

MHI
Copy 2

FM 17-33

WAR DEPARTMENT

**ARMORED FORCE FIELD
MANUAL**



**THE ARMORED BATTALION,
LIGHT AND MEDIUM**

September 18, 1942

FM 17-33

**ARMORED FORCE FIELD
MANUAL**



**THE ARMORED BATTALION,
LIGHT AND MEDIUM**



UNITED STATES
GOVERNMENT PRINTING OFFICE
WASHINGTON : 1942

WAR DEPARTMENT,
WASHINGTON, September 18, 1942

FM 17-33, Armored Force Field Manual, The Armored Battalion, Light and Medium, is published for the information and guidance of all concerned.

[A. G. 062.11 (8-20-42).]

BY ORDER OF THE SECRETARY OF WAR:

G. C. MARSHALL,
Chief of Staff.

OFFICIAL:

















J. A. ULIO,
Major General,
The Adjutant General.

DISTRIBUTION:

D 2, 7 (5); D 17 (15); R and H 2, 7 (3); Bn and H 17
(5); IBn 2, 5-10 (3); C 17 (20); IC 2, 5-11 (3).
(For explanation of symbols see FM 21-6.)

TABLE OF CONTENTS

	Paragraphs	Page
SECTION I. General -----	1-4	1
II. Training -----	5-9	4
III. Control, orders, liaison, reconnaissance, maintenance, evacuation -----	10-15	12
IV. Marches and bivouac -----	16-21	21
V. Security -----	22-27	31
VI. Offensive action -----	28-39	57
VII. Defensive action -----	40-43	113
VIII. Special operation -----	44-49	122
INDEX -----		135

	SECOND IN COMMAND
	PLATOON LEADER
	COMPANY COMMANDER
	BATTALION COMMANDER
	TANK
	TANK, SHOWING DIRECTION OF TURRET GUN
	HALF-TRACK, CAR OR CARRIER (OF ARMORED UNITS)
	HALF-TRACK, CAR OR CARRIER (OF INFANTRY UNITS)
	MORTAR CARRIER
	ASSAULT GUN
	AMMUNITION CARRIER
	1/4 TON TRUCK
	MOTORCYCLE
	DESTROYED AT GUN
BN MAINT 	BN MAINT CREW, MAINT CO, ARMORED REGT
	UNIT TRAINS, ECHELON A

Key to symbols used in this manual.

ARMORED FORCE FIELD MANUAL

THE ARMORED BATTALION, LIGHT AND MEDIUM

SECTION I

GENERAL

■ 1. **SCOPE AND PURPOSE.**—*a.* This manual covers the tactical employment of the light and medium tank battalions both as part of a larger force and when acting independently. It is designed as a guide only and does not lay down a set of inflexible rules. Each tactical situation must be solved on its own merits and the initiative of individual commanders must be encouraged.

b. Although not written specifically for the separate tank battalions, the fundamentals covered herein and formations shown are generally applicable to those units.

■ 2. **ORGANIZATION.**—*a. Armored battalion.*—The armored battalion has a headquarters and headquarters company and three tank companies. For details of organization see current Tables of Organization.

b. Separate tank battalion.—The separate tank battalion is similar in organization to the armored battalion except that a service company is added for administrative purposes and for maintenance.

c. Headquarters and headquarters company.—The headquarters and headquarters company consists of a battalion headquarters and a headquarters company. The headquarters company is further divided into company headquarters, an assault gun platoon, and a mortar platoon. The company has a small maintenance section for maintenance of company equipment only. Figures 1 and 2 show in chart form the organization of the company. A small reconnaissance platoon is provided for the battalion headquarters.

■ 3. **FUNDAMENTALS.**—*a.* The tank battalion operates by surprise, fire and maneuver, and concentration of effort (mass).

(1) *Surprise* is obtained by speed of maneuver, use of cover and concealment, striking at an unexpected time in an unex-

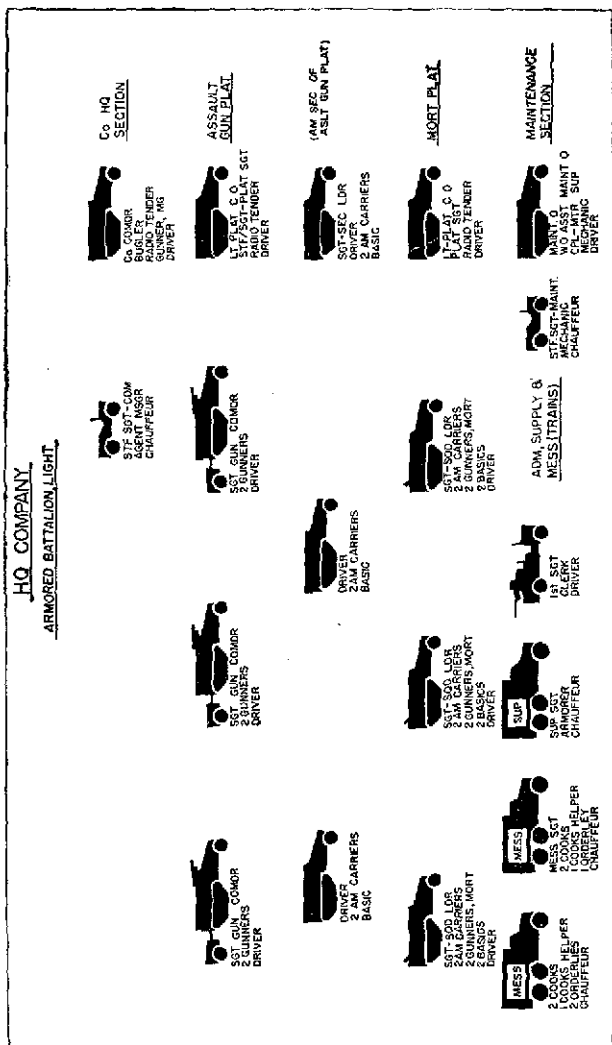

Figure 1.—Headquarters and headquarters company, armored battalion, light. (The medium battalion headquarters company is similar in organization.)

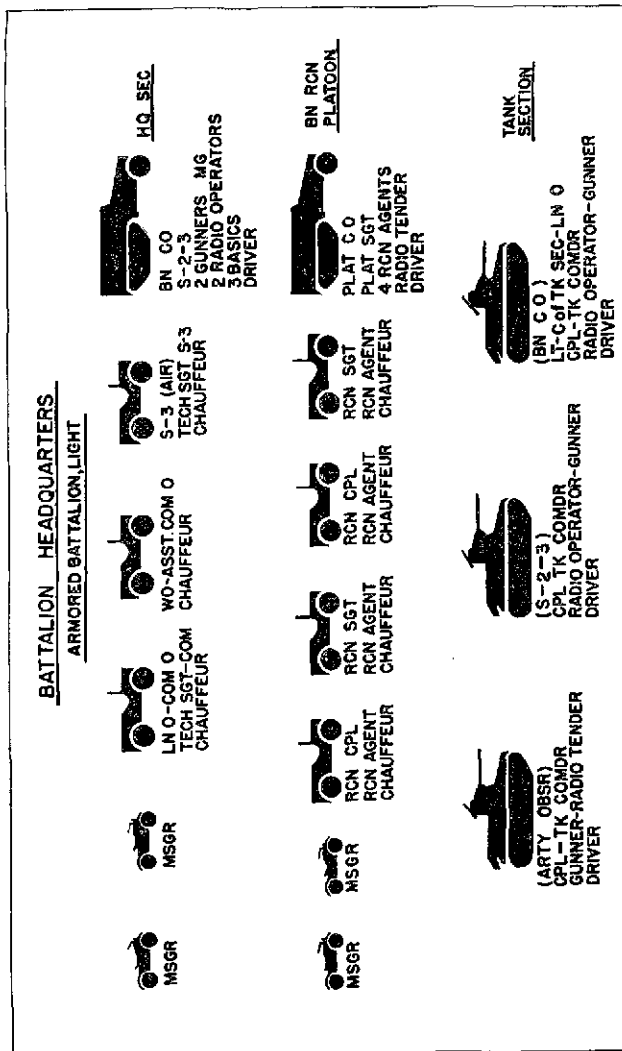

FIGURE 2.—Headquarters, armored battalion, light. (The medium battalion headquarters is similar in organization.)

pected direction, and by deceiving the enemy as to the true point of the main attack.

(2) *Fire and maneuver* is a fundamental of all tactical employment. Part of the battalion supports by fire the maneuver of the remainder. This fundamental is applicable down to and including the tank section.

(3) *Concentration of effort* must be made on critical areas. Do not disperse the command by making simultaneous attacks on widely dispersed objectives. Such action is ineffective, wastes effort, and usually leads to failure.

b. The characteristics of the different type tanks dictate their employment.

(1) The light tanks are used—

(a) To feel out weak points in enemy resistance.

(b) To screen the advance when the situation is vague.

(c) As a fast maneuvering force to attack the enemy flank or rear or to exploit a success.

(d) To draw the enemy into prepared traps.

(e) As advance, flank, or rear guards.

(f) On terrain impassable for medium tanks.

(2) The medium tanks are used—

(a) As the leading wave or echelon of attack against known enemy resistance when the antitank defense is strong.

(b) To support by fire the advance of light tanks, other medium tanks, or infantry in tank versus tank action.

■ **4. INFLUENCE OF TERRAIN.**—In any plan for employment of tanks, the influence of terrain must be carefully analyzed. (See FM 17-10.) Tanks are extremely sensitive to terrain and, many times, infantry must attack to secure ground from which the tank attack may be launched. However, do not dismiss the possibility of the use of difficult terrain. The surprise gained may be worth the labor of traversing it.

SECTION II

TRAINING

■ **5. GENERAL.**—*a.* The subject of training is covered generally in FM 21-5. The battalion may operate alone, as part of a regiment, as part of a combat command, and as the division reserve. It will normally be reinforced. It is essential that

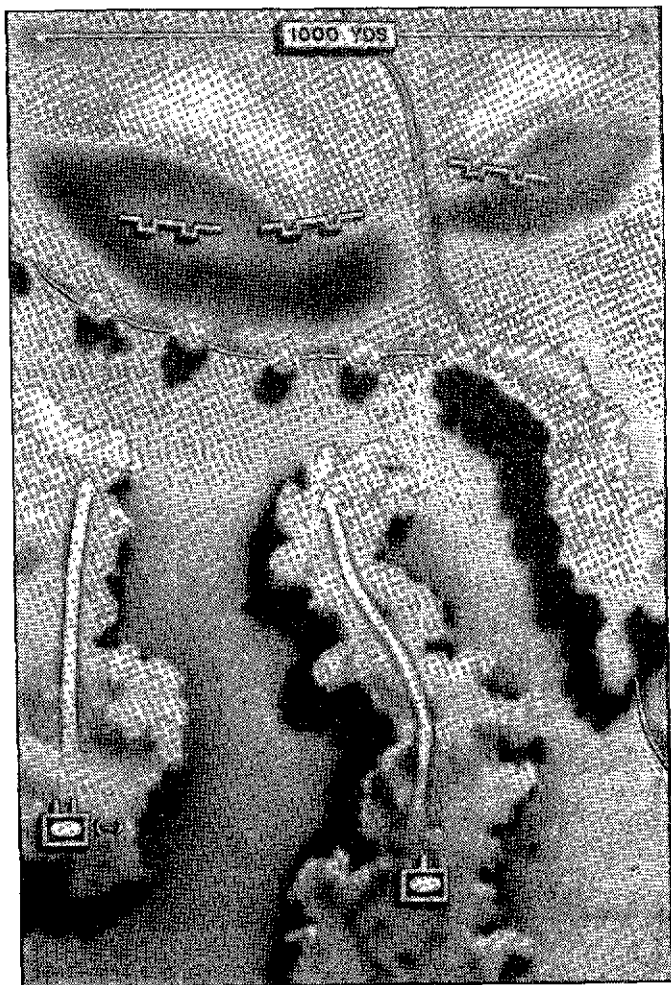

FIGURE 3.—Surprise is gained by rapidity of movement, use of concealed approaches. Do not move across open spaces when cover is available.

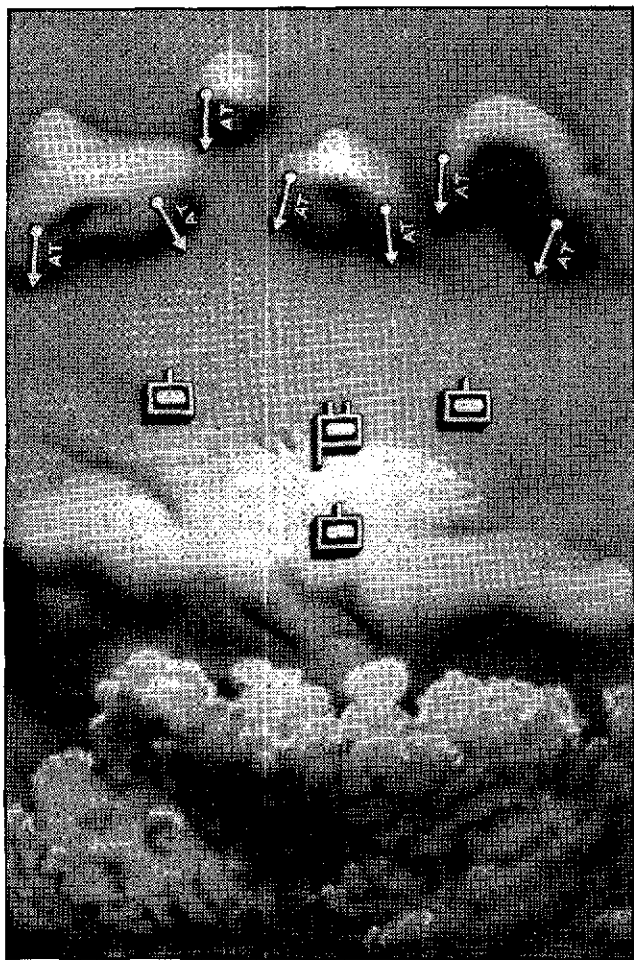

FIGURE 4.—Advance without fire support will lead to disaster.

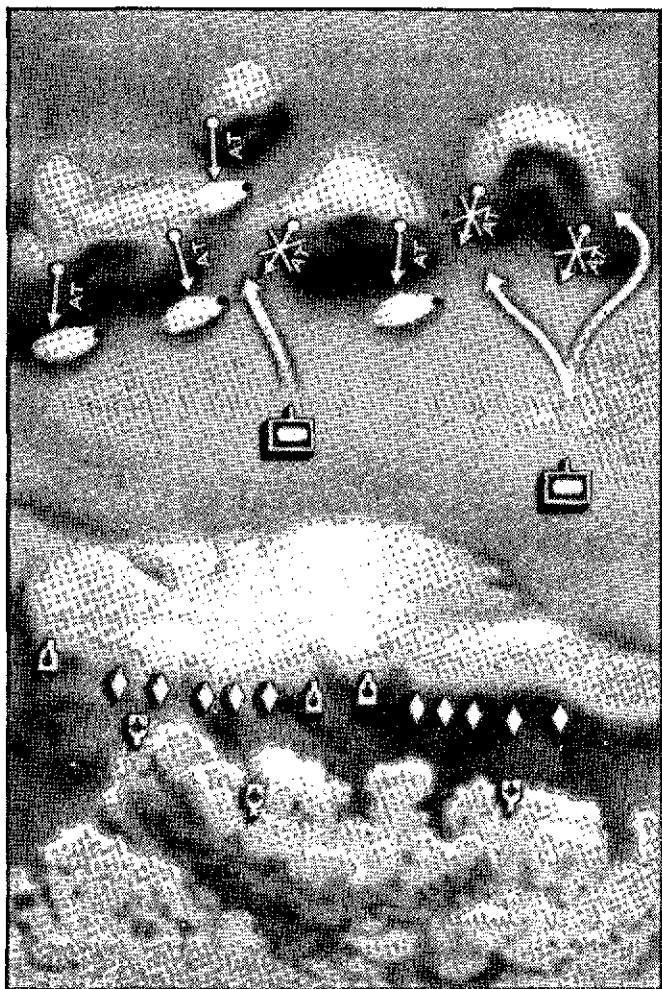

FIGURE 5.—Use available supporting weapons. Use one company to support attack by fire. Companies also use fire and maneuver in their advance. Smoke antitank guns or fire on them with assault guns.

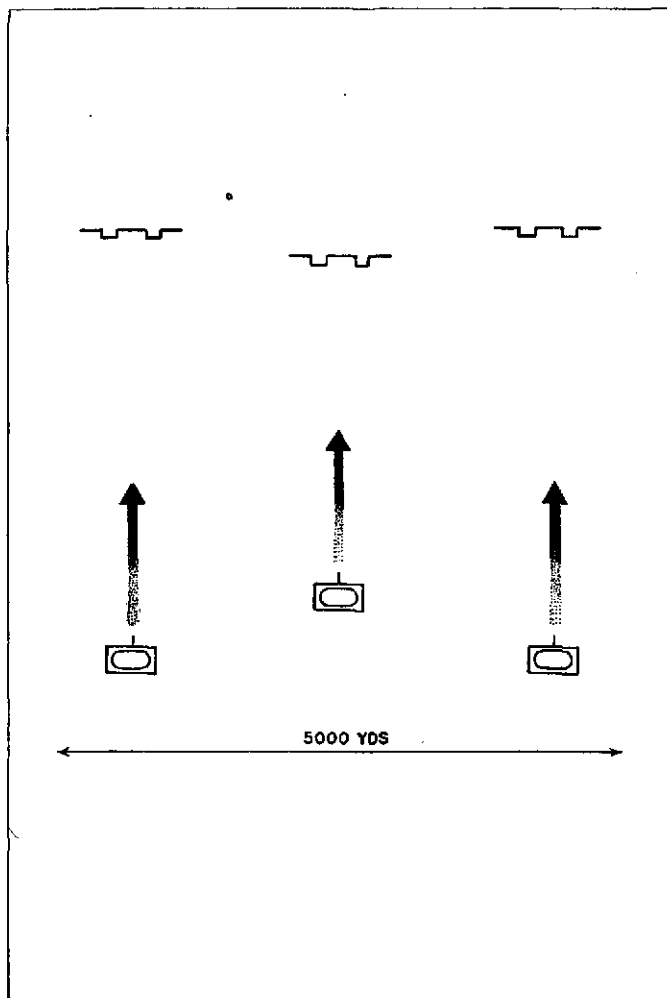

FIGURE 6.—Do not disperse the battalion.

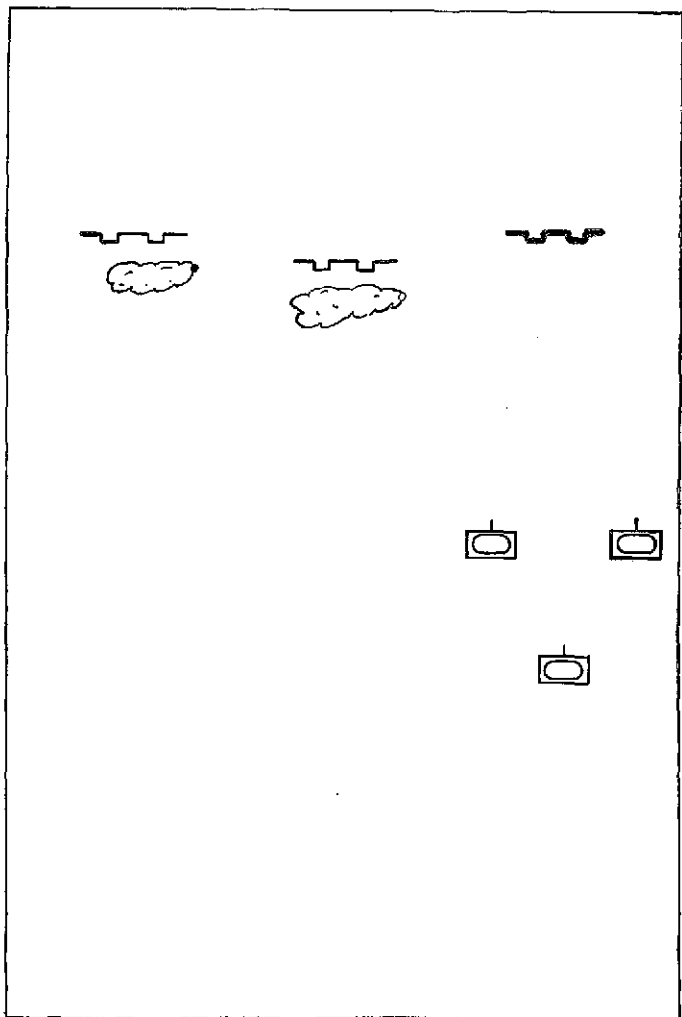

FIGURE 7.—Mass effort on one objective, take it and others will fall.
Block enemy observation by smoke, if practicable.

all training stress coordination, not only within the battalion, but with other units as well. All battalion exercises must be prepared with a view to gaining the maximum training in coordination, control, and battle efficiency.

b. The battalion and its component parts must be thoroughly trained in—

- Marches.
- Security.
- Offensive combat.
- Defensive combat.
- Special operations.

This manual covers the training of the battalion as a whole. For training of the component parts of the battalion see FM 17-10, 17-25, 17-27, and 17-32.

c. Platoons and companies must have completed training in a particular subject before that subject is scheduled for battalion training.

■ 6. TRAINING OF HEADQUARTERS AND HEADQUARTERS COMPANY.—This subject is covered in FM 17-10, 17-20, 17-25, and 17-27.

■ 7. PREPARATION OF EXERCISE.—a. Maximum training is obtained by careful preparation and vigorous execution of exercises. Do not leave anything to the last minute. Prepare everything well in advance of the date the exercise is scheduled.

b. The following procedure is recommended for preparation of an exercise:

(1) Determine the type of exercise and the particular lessons to be emphasized.

(2) Make a map reconnaissance for a suitable area for the exercise and then, with the battalion staff, personally reconnoiter the whole area.

(3) Determine whether this area will be available for the date scheduled and, if so, reserve it.

(4) Make an outline of the exercise, first setting down a list of items to be emphasized. Such items for a march may be—

- Security against ground attack.
- Security against air attack.
- Reduction of road blocks.

Selection of command posts.

Zones of advance.

Phase lines.

Methods of communication.

(5) Outline the problem on the map and, together with staff officers, play it to determine its soundness. Work out time and space factors so that companies will not be expected to do the impossible. Determine places and times where and when it is desired to introduce enemy action. Determine what type of enemy action is wanted at these points to bring out certain lessons, and what troops and equipment is needed for the enemy action.

(6) The problem can now be drafted and issued in the form of a training memorandum. Information in this memorandum should include—

Date of exercise.

Type of exercise.

Equipment.

Place of assembly.

The general situation.

Enemy troops needed.

(7) Instructions to troops acting as the enemy should be given in a separate memorandum or by written message to each commander concerned. The commanders of such detachments should be conducted by the battalion commander or a staff officer to the place where they are to operate and there be given specific instructions as to their part in the problem. Leave nothing to chance.

(8) Have all troops and all available equipment ready for the exercise.

c. In conducting the problem the following procedure is recommended:

(1) Assemble company commanders and give oral orders.

(2) Give time for company and platoon commanders to give their orders.

(3) Move out from motor parks in battle formation, every individual alert and at his proper post.

(4) Do not allow excessive delays. Keep everybody alert. Require vigorous action.

(5) Give fragmentary orders as required.

(6) After the exercise, hold a critique; emphasize lessons learned. Comment on poor solutions and point out a correct solution. Commend good solutions but do not ridicule poor solutions. Remember the men are being prepared for combat and their success or failures may be directly traceable to their teaching. Have parts of problem repeated as necessary.

■ 8. COMBINED TRAINING.—Whenever practicable, hold combined training exercises with artillery, engineers, infantry, tank destroyer units, and air units. In any case the battalion medical detachment and the battalion section of the maintenance company should be present.

■ 9. SUPPLY, MAINTENANCE, AND EVACUATION.—Do not forget the supply, maintenance, and medical functions in keeping the battalion in operation. Think of these in planning exercises. Require the staff officers concerned to make plans and require execution of such plans. (See FM 101-5.)

SECTION III

CONTROL, ORDERS, LIAISON, RECONNAISSANCE, MAINTENANCE, EVACUATION

■ 10. CONTROL.—Control as discussed herein consists of both tactical and fire.

a. *Tactical.*—Control once lost is difficult to regain. It is therefore imperative that the battalion commander use every means within his power to insure adequate control of his battalion at all times. Control is exercised by—

(1) Giving clear definite orders as to formations, zones, lines of departure, axis of advance, phase lines, attack positions, objectives, and rallying points. (See sec. VI.) It is not sufficient merely to give these orders; the battalion commander must allow time for lower commanders to transmit these orders to all personnel and must assure himself that this is done. The most brilliantly conceived plan is likely to fail if it is not properly transmitted to the troops and if execution of it is not supervised. *Plan, order, supervise.*

(2) Radio.

(3) Messenger.

(4) Signals.

(5) For radio communication within the company see FM 17-32.

(a) The battalion commander has radio communication with higher-unit headquarters, his company commanders, reconnaissance platoon, assault gun platoon leader, mortar platoon leader, artillery forward observer, and headquarters company commander. By switching of crystals, attached units may be placed on the battalion command frequency. See figure 8 for battalion radio net.

(b) The use of radio must be kept to the minimum. Messages must be brief. Do not send messages in the clear that will disclose information upon which the enemy will have time to act. *Commanders habitually use the radio themselves.*

(c) On the march, radio is usually silent although receivers are turned on and all except a small number used for other purposes are set on the battalion net. Radios must be silent at least $\frac{1}{2}$ hour before reaching bivouac. They *must* be silent in bivouac.

b. *Fire.*—The control of the fire of a tank battalion with its supporting weapons and reinforcements is an extremely difficult task. The battalion commander must rely to a great extent upon mission-type fire orders as control of individual weapons is impracticable. In general, the battalion commander controls fire initially by giving targets to supporting weapons and zones of action for his leading companies. During action, the battalion commander by means of radio or by oral order when practicable gives fire missions to his battalion.

(1) *Initial.*—(a) *Leading companies.*—Leading companies are given a direction of attack or zone of action. The locations of any known hostile targets are designated to the company commander and the company commander is then left free to control the fire of his company.

(b) *Reserve company.*—Part or all of the reserve company may be given an initial mission of supporting the leading companies by fire. Known targets are pointed out to the platoon or company commander and a time for opening fire designated. If location of targets, such as antitank guns, is not definitely known, the reserve company or its platoons is given the mission of firing on targets as they appear. Each

platoon will be given the mission of supporting a particular leading company, to protect a flank, or to cover a particular zone.

(c) *Assault gun platoon.*—Initially the assault gun platoon, except when the zone is extremely wide, remains under the direct control of the battalion commander. The platoon leader is directed to fire on designated targets if any suitable targets are known. Otherwise, he places his guns in position and is directed to fire on targets as they appear.

(d) *Mortar platoon.*—Initially fire control of the mortar platoon is the same as for the assault gun platoon. It may be given smoke missions. (See FM 17-27.)

(e) *Supporting tank company or platoon.*—A supporting tank company or platoon is controlled the same as the battalion reserve.

(f) *Supporting infantry.*—Supporting infantry is normally used as a base of fire for the maneuver of the battalion. As such it is given a mission and fire control left to the unit commander. (See FM 17-40 and 17-42.)

(g) *Artillery.*—The battalion commander through his artillery forward observer calls for such fires as he deems necessary. (For fire control and coordination see FM 17-62.)

(2) *During action.*—(a) *Leading companies.*—Company commanders control their companies. The battalion commander gives orders for movements. Rarely will he give orders for a company to place its fire on any particular target. He may order the company commander to assist an adjacent company but actual fire control is left to the company commander.

(b) *Reserve company.*—As the attack progresses the battalion commander, by radio or personal contact with the reserve company commander, orders supporting fires for leading companies. In this connection, the platoons of the reserve company may be placed on the battalion command frequency so fire orders can be given without undue delay. When the reserve company acts as a unit for maneuver the company net is re-formed.

(c) *Assault gun platoon.*—By radio the battalion commander orders the assault gun platoon to fire on targets as desired. The assault gun platoon commander must not wait for orders to fire on targets of opportunity. (See FM 17-25.)

(d) *Mortar platoon.*—By radio or signal the battalion commander directs the mortar platoon leader to fire on targets as they appear or place smoke as needed. (See FM 17-27.)

(e) *Supporting tanks.*—These are controlled the same as the reserve company.

(f) *Infantry.*—As infantry is needed to reduce resistance which tanks cannot reach, the battalion commander orders its use tactically but does not attempt to control the fire.

(g) *Artillery.*—Through his artillery forward observer the battalion commander calls for fires as needed. Should this observer become a casualty the battalion commander, his S-2-3, or his company commanders and platoon commanders of the battalion adjust artillery fire.

(3) *Adjustment of fire.*—For maintaining control and obtaining faster adjustment of fire the battalion commander may use his S-2-3 to control a part of the fire support. Thus this officer may direct the fire of the assault guns or mortars in accordance with the battalion commander's wishes.

c. *Signals.*—Signals are covered in FM 17-5. Because of the distance involved the battalion commander will rarely use visual signals.

■ 11. **ORDERS.**—a. Orders are oral or in written message form and frequently fragmentary. They must be brief, clear, and when practicable, given at a point from which as much as possible of the terrain over which the operation is to take place, can be seen. Full use should be made of marked maps, aerial photographs, and overlays.

b. The form for a field order is given in FM 101-5.

■ 12. **LIAISON.**—The battalion commander maintains liaison with the regiment or combat command by means of a liaison officer. This officer should know the battalion plan of action. He may be used to deliver orders to the battalion but he should not be used for messenger service. Duties of liaison officers are prescribed in FM 101-5.

■ 13. **RECONNAISSANCE.**—Reconnaissance is covered in detail in FM 17-10, 17-20, 17-22, and 17-32.

a. The tank battalion has a small reconnaissance platoon mounted in a half-track vehicle and four $\frac{1}{4}$ -ton trucks. This platoon is used on the march for making short reconnaissance

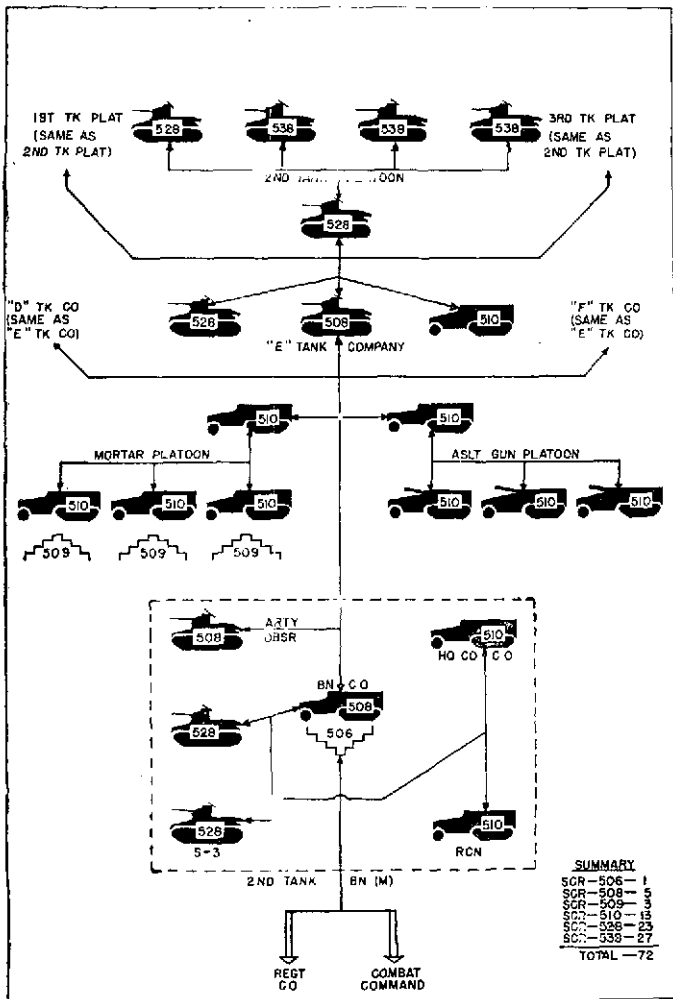

FIGURE 8.—Battalion radio net.

trips to the right and left of the line of march, or to reconnoiter to the front when the battalion is acting alone, or is acting as an advance guard for a larger force. In assembly areas and rallying points it is used for close reconnaissance missions. Before combat the platoon assists the battalion commander in reconnaissance of the area of employment. During combat it follows the reserve company, performs reconnaissance missions to the flanks, or may be used to maintain liaison with adjacent units. When the battalion is in the leading echelon of an attack, the reconnaissance platoon usually follows the second echelon and rejoins the battalion at the rallying point.

b. The battalion commander and his staff must make personal reconnaissance for employment of the battalion. This includes reconnaissance of both terrain and enemy positions.

■ 14. MAINTENANCE.—Employment of company maintenance sections is covered in FM 17-32.

a. The battalion has no maintenance personnel except for its own battalion headquarters and headquarters company vehicles. During operations a battalion maintenance section of the regimental maintenance company is attached to, or supports, the battalion. It moves with the battalion and reinforces the company maintenance sections. This section accompanies the battalion to the assembly area and attack positions where it assists in making final adjustments on vehicles. During combat it follows the battalion as closely as practicable, along the battalion axis of maintenance designated by the battalion commander. It seeks disabled vehicles, reinforces company maintenance sections, and reports to the regiment, or to the maintenance battalion personnel with the combat command, the location of any vehicles which are disabled beyond the capability of the section to repair. If time permits, an estimate of the extent of the damage should be transmitted at the same time. The maintenance section should rejoin the battalion at the rallying point where it will assist the company maintenance sections. (See FM 17-50.)

b. During a penetration when the battalion is the first echelon of attack, maintenance personnel usually follow the second echelon of attack.

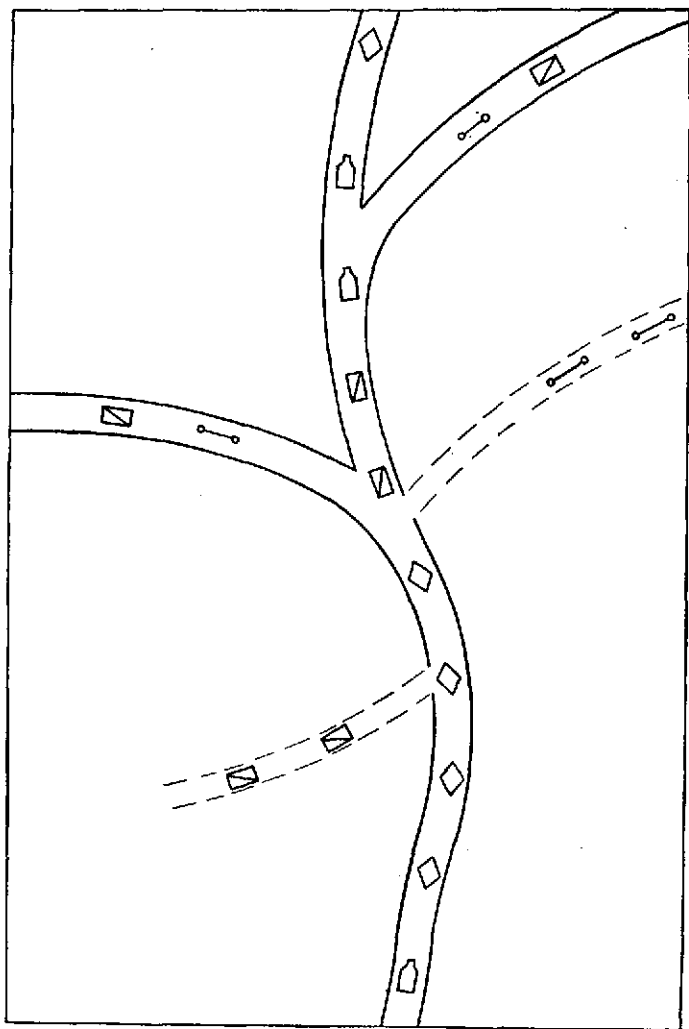

FIGURE 9.—On the march, when the battalion is in the main body, use reconnaissance platoon and motorcyclists to reconnoiter short distances to the flanks.

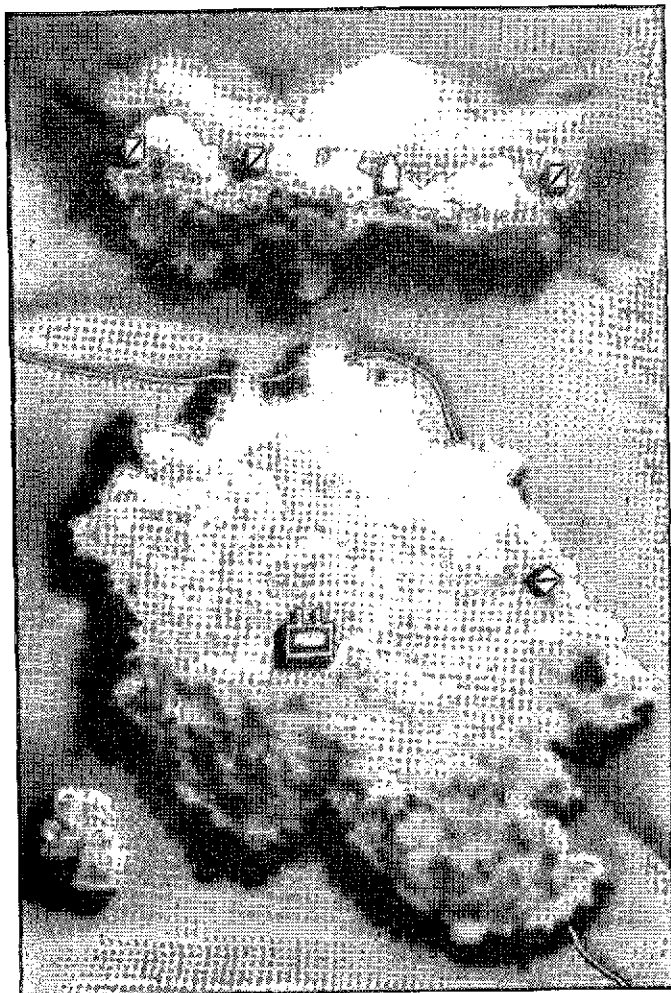

FIGURE 10.—In assembly area, attack positions, and rallying points, use reconnaissance platoon to observe and to make additional reconnaissance.

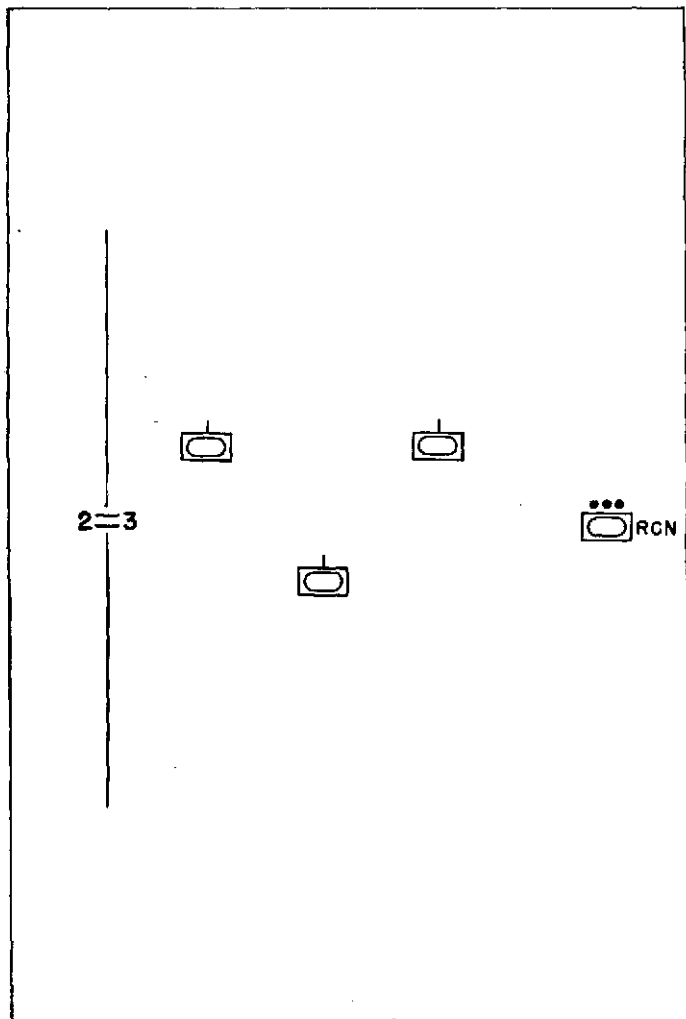

FIGURE 11.—During combat, use platoon for reconnaissance to flanks or to maintain contact with adjacent units.

■ 15. EVACUATION.—The evacuation of wounded from armored units is covered in detail in FM 17-50 and 8-5. The battalion section of the regimental medical detachment marches at the rear of the battalion on the march. It accompanies the battalion to the attack position. During combat it moves forward with the maintenance, cares for wounded, and joins the battalion at the rallying point.

SECTION IV

MARCHES AND BIVOUAC

■ 16. GENERAL.—The subject of marches is covered in detail in FM 25-10, 17-10, and 17-50.

a. A successful march is one that places the troops and equipment at their destination at the proper time and in proper condition to fight. A successful march depends upon good march discipline. This can be obtained only by thorough training in march procedure and rigid enforcement of march rules.

b. The rate of march of a column containing medium tanks does not exceed 17 miles per hour. This rate may be increased for short periods for columns which do not contain medium tanks. However, it must be borne in mind that an increase of rate of march above 17 miles per hour for extended periods will cause an exorbitant increase in maintenance needs.

c. For detailed discussion of distances between vehicles see FM 25-10. Ordinarily distances will be not less than 50 yards and usually will be approximately 90 yards. At times they may be as great as 0.1 mile. Movement by infiltration is discussed in FM 25-10 and 17-50.

■ 17. MARCH PLANS AND ORDERS.—The march order for a battalion is oral, supplemented by sketches or marked maps of the route. Each vehicle commander and each driver should know the route and when practicable be given a sketch of the route. For form for a march order see FM 101-5.

a. *Warning orders.*—Warning orders should be issued far enough in advance of the time set for departure so that proper preparations for the march may be made. These preparations will depend upon the situation as to supply and state of maintenance. A well-trained battalion should be able to

move from bivouac within $\frac{1}{2}$ hour after receipt of warning orders.

b. *Plans.*—Plans for movement include—

Formation for the march.

Route.

Phase lines.

Security measures.

Route reconnaissance.

Supplies.

Halts.

(1) *Formation for the march.*—The march formation will depend upon the orders of the higher commander, the enemy situation, and the place in column. Figure 12 shows one formation for the battalion marching as an interior battalion of the regiment or combat command. Advance and rear guard formations are covered in section V.

(2) *Route.*—The route will usually be designated by the higher commander. When a zone of advance is given, or the battalion is operating alone, the battalion commander, by map reconnaissance, picks his route and alternate routes. (See *g* below.)

(3) *Phase lines.*—Phase lines should be clearly distinguishable terrain features such as streams, crossroads, and well-defined ridges across the line of march. They are spaced from 1 to 3 hours apart, and are used for control purposes. The heads of columns cross phase lines at predesignated times or upon order of the higher commander.

(4) *Security.*—Security is covered in section V and in FM 100-5.

(5) *Route reconnaissance.*—(a) After receiving warning orders the battalion commander procures all information practicable concerning the route of advance. This information includes conditions of roads and bridges, location of defiles, places where guides must be posted, and areas where enemy attack may be expected. When acting alone he has as much of the route as practicable reconnoitered. When operating as part of a larger unit he will depend primarily on map reconnaissance and information received from higher headquarters.

(b) Examine the map. Look for places where the column might stray from the route. Look for streams which may

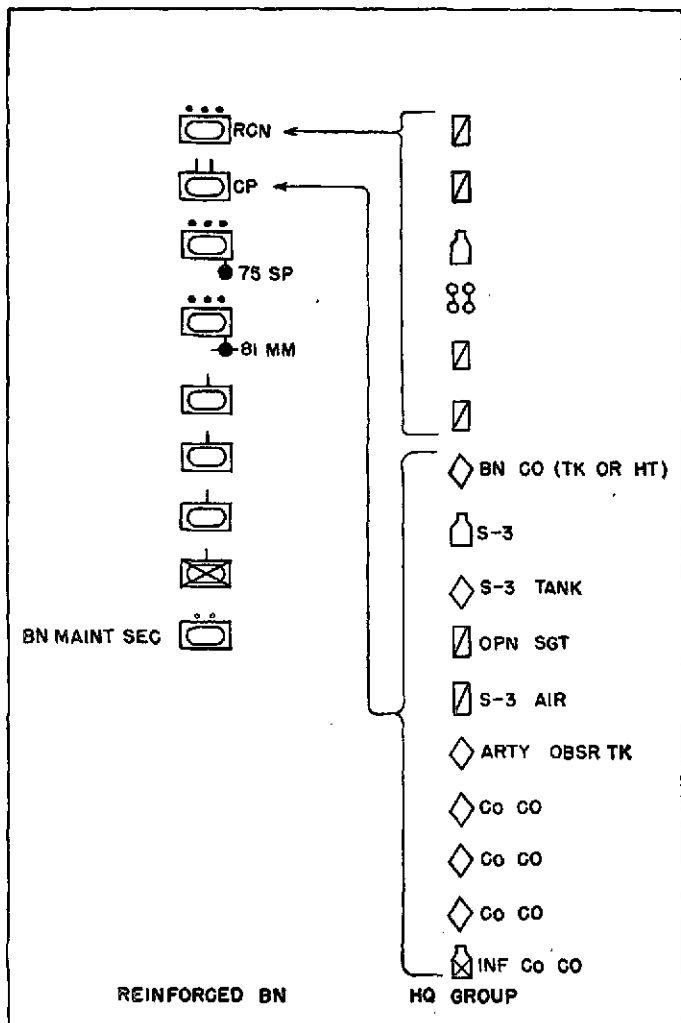

FIGURE 12.—Typical march formation interior battalion.

cause trouble and places where the column might be ambushed. Plan ground reconnaissance on basis of map reconnaissance.

(6) *Supplies.*—The battalion of the armored regiment is not an administrative unit. However, the battalion commander must check to see that the companies have their full supply of equipment, fuel and lubricants, ammunition, and food.

■ 18. TRAINS.—*a.* Fuel and lubricants, maintenance vehicles, and ammunition vehicles, and in some cases company kitchens accompany the battalion. Company maintenance vehicles follow at the tail of each company column. Some fuel and lubricants trucks follow the company column. Ammunition vehicles are grouped at the rear of the battalion.

b. The battalion maintenance section from the regimental maintenance company follows the battalion. (See par. 14.)

c. The battalion medical detachment is placed in rear of the battalion column just ahead of the battalion maintenance section.

d. For long marches, kitchens accompany their companies. When contact becomes imminent, kitchens are dropped out of column and join the higher unit trains.

e. Personnel sections are with the division trains.

■ 19. CONDUCT OF THE MARCH.—*a.* The battalion moves out of bivouac at the proper time to reach the IP at time scheduled for passing that point. Do not be too late or too early.

b. Use staff officer to patrol column. This officer using $\frac{1}{4}$ -ton truck falls out of column, watches vehicles pass, and rejoins the head of column at the halt. He checks for presence of vehicles, their condition, and for breaches of march discipline. He reports the results of the check to the battalion commander or the officer conducting the battalion column.

c. Use motorcyclists and personnel in $\frac{1}{4}$ -ton trucks as traffic guides and guards. Use motorcyclists as connecting files to keep contact with unit ahead. *Do not take the wrong road.*

d. Send billeting party ahead as required by higher commanders to guide units into new bivouac.

■ 20. HALTS.—*a.* Normally a scheduled halt of 15 minutes is made after the first hour and halts of 10 minutes at the end

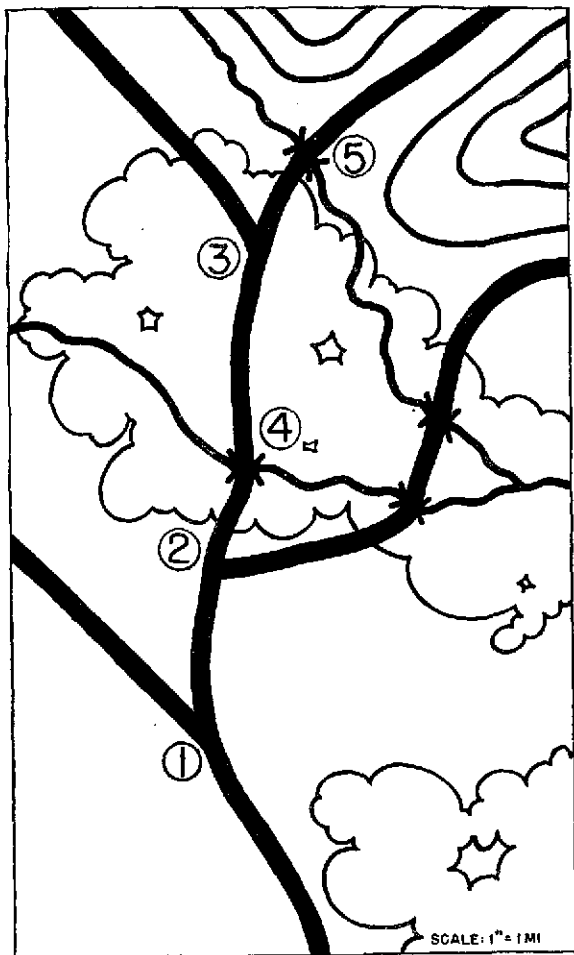

FIGURE 13.—Route reconnaissance by map. Guides needed at (1), (2), and (3). Bridges (4) and (5) must be examined. Woods are defiles, enemy may have ambush there. Hills must be reconnoitered. Measure distances.



FIGURE 14.—Do not form on road near bivouac and wait time for moving out. Vehicles will be exposed to discovery and possible air attack.



FIGURE 15.—Move vehicles out and form column moving.

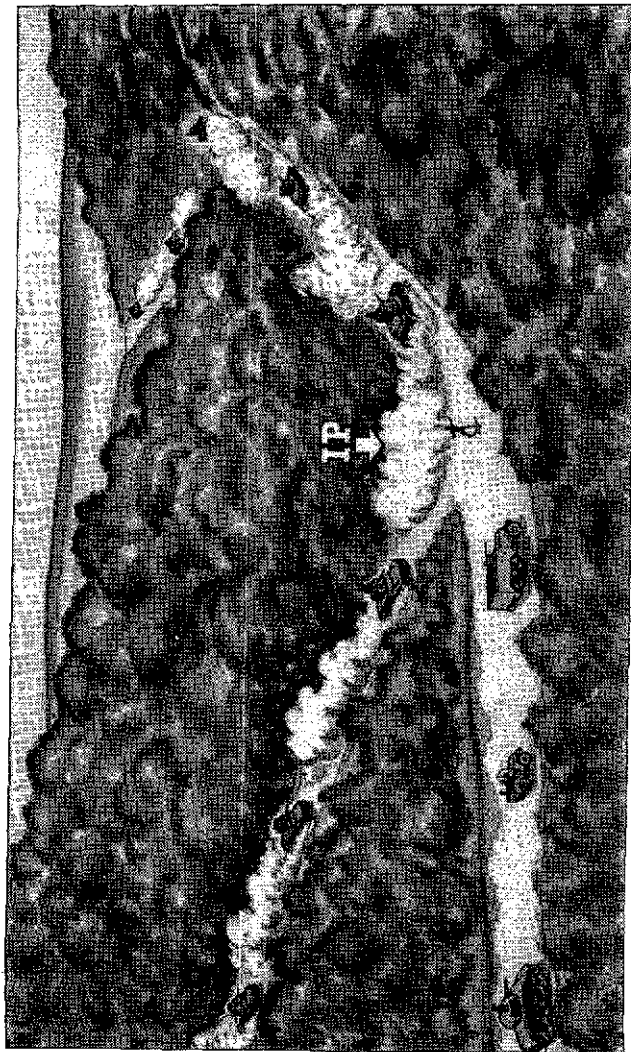

FIGURE 16.—Do not move out too early. Vehicles must halt at the IP.

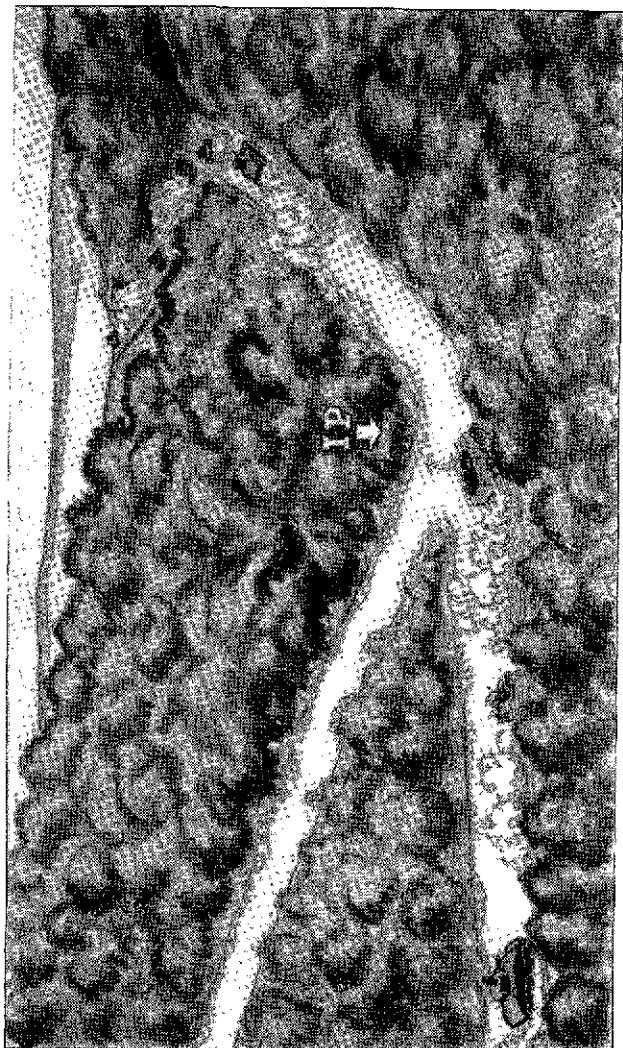

FIGURE 17.—Move out from bivouac so that IF may be passed at proper time without halting.

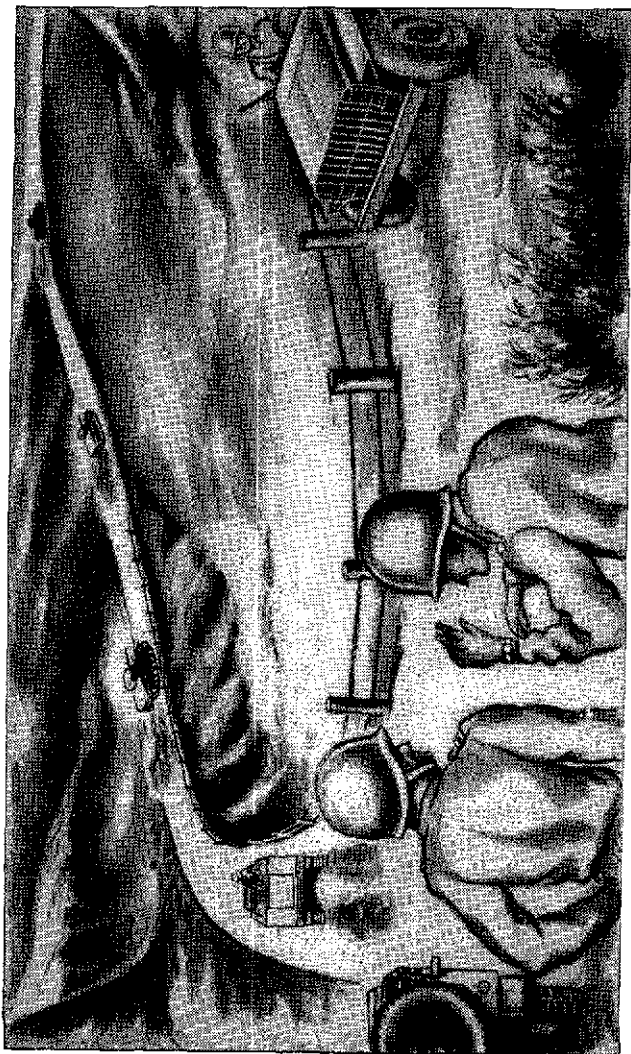

FIGURE 18.—Have staff officers check column at frequent intervals.

of 1 hour and 20 minutes or 1 hour and 50 minutes thereafter. In long columns, some units may not have left the bivouac before the first 15-minute halt and other units may have traveled only a few minutes. These halts are for the purpose of inspection and maintenance of vehicles, rest of personnel, and changing drivers.

b. Refueling halts, of $\frac{1}{2}$ - to $\frac{3}{4}$ -hour duration, are made at approximately 4-hour intervals. Although some units may have traveled less than 2 hours at the time of this halt, fuel tanks must be filled.

c. Halts for feeding usually coincide with refueling halts.

d. For security at the halt see section V.

■ 21. BIVOUACS.—a. Bivouacs are selected which provide concealment, natural protection, good standing for vehicles, sufficient area to permit necessary dispersion, and sufficient exits to prevent being blocked by enemy action.

b. The specific area for bivouac is assigned by higher commander. The battalion commander sends his billeting detail, usually the battalion liaison officer and other men as necessary, to reconnoiter the area, divide it into company areas, and post guides to lead the companies to their positions. The company areas should be divided into platoon areas so no time will be lost in moving into the bivouac. This liaison officer should make a thorough reconnaissance so as to advise the battalion commander on security measures.

c. Arrange units in bivouac so they can move out readily in the proper order of march without passing through the area of another company.

SECTION V

SECURITY

■ 22. GENERAL.—The fundamentals of security are covered in FM 17-10 and 100-5.

a. Security includes all measures taken by a command to protect itself against annoyance, surprise, and observation by enemy forces (FM 100-5). Adequate and timely information of the enemy is the basis of all security measures.

b. The battalion commander is responsible for the security of the battalion as a whole. He checks on and coordinates

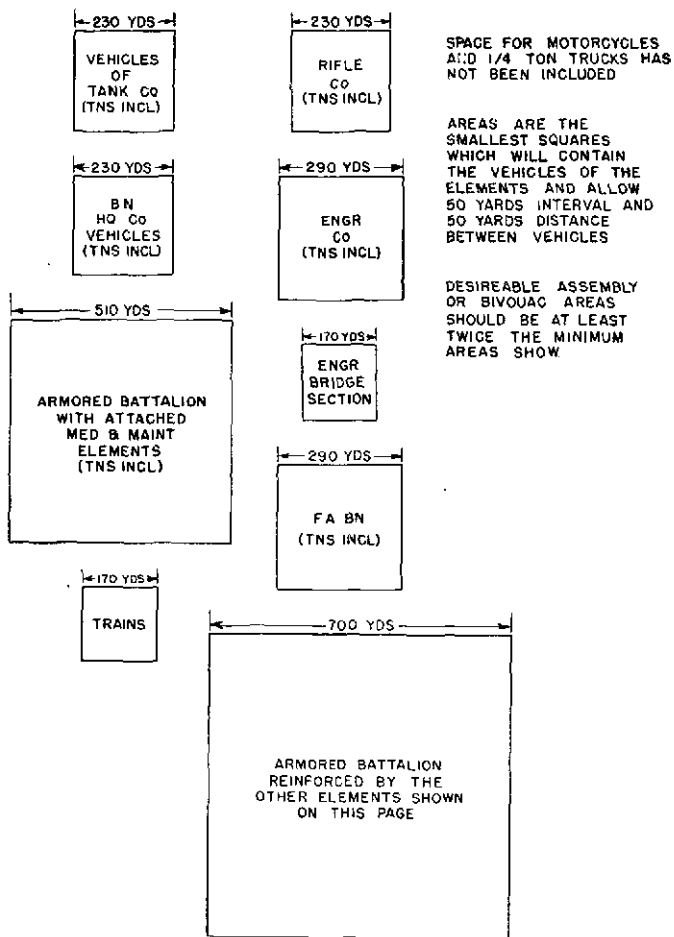

FIGURE 19.—Minimum bivouac areas.

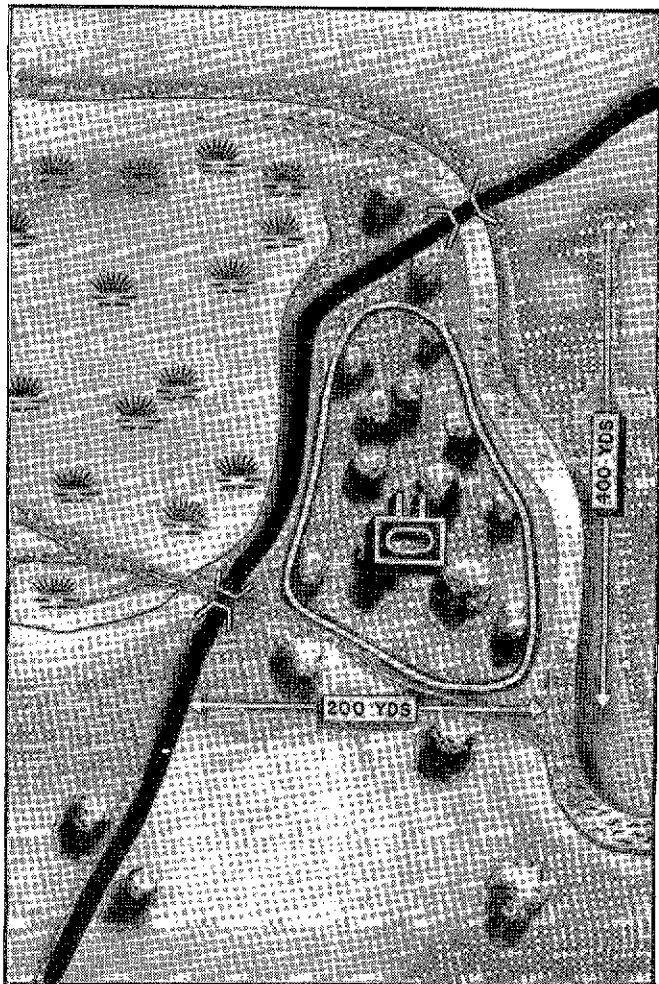

FIGURE 20.—Bivouac area. This area provides little concealment, can be easily flooded, has only two exits, and vehicles will be crowded. These conditions invite air attack.

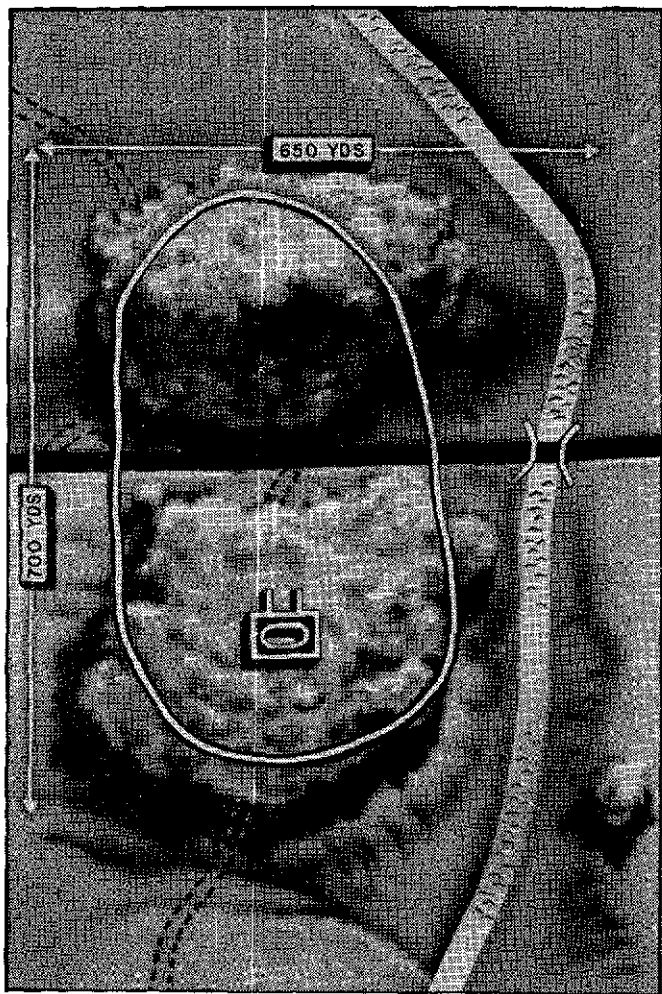

FIGURE 21.—Bivouac area. This area has good cover, good standings, ample exits, and sufficient area. Vehicles must be at least 50 yards apart.

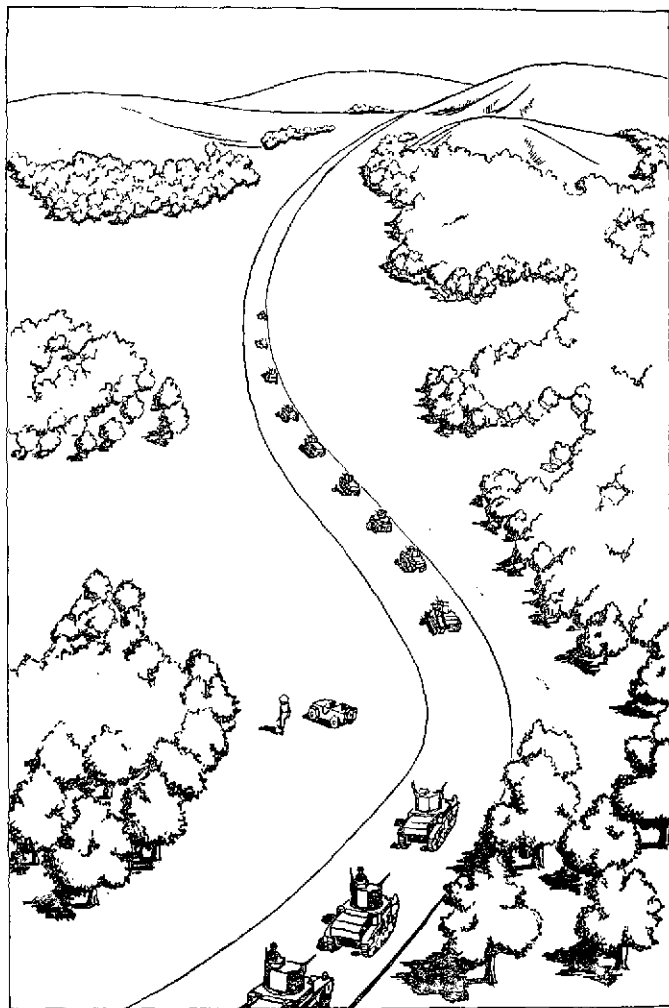

FIGURE 22.—Guides were not posted here and vehicles jammed on road. This column is easy prey for air attack.

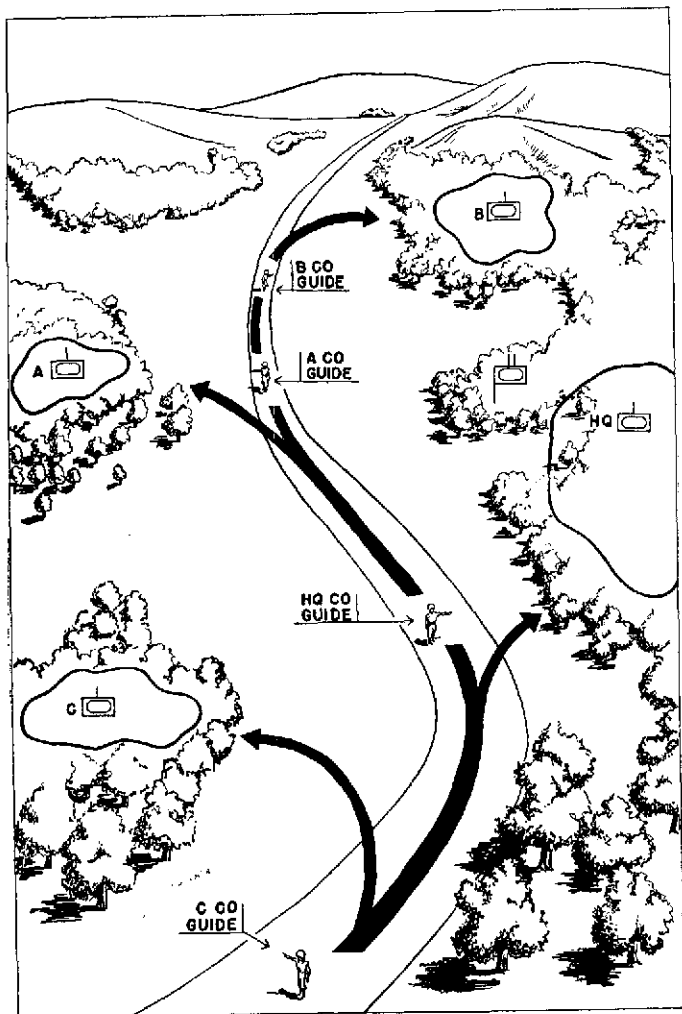

FIGURE 23.—Post guides. Move column in quickly without halting on road.

local security and provides for the general security of the battalion in accordance with the plans of the higher commander.

■ 23. ON THE MARCH.—Security against ground attack while on the march is obtained by reconnaissance and by use of advance flank and rear guards. Security against air attack is covered in paragraph 25.

a. Battalion acting alone.—(1) *Reconnaissance.*—When acting alone the battalion uses its reconnaissance platoon to reconnoiter 3 to 7 miles ahead of the advance guard and 1 to 2 miles on each side, depending upon the road net. The platoon leader follows the main route of advance. He sends squads to reconnoiter ahead and to the flanks. The $\frac{1}{4}$ -ton trucks work in pairs. Any resistance met is immediately reported to the battalion commander. The reconnaissance platoon seeks to determine the strength, disposition, and flanks of the enemy and makes reports immediately to the battalion commander. This report may be made by radio. If practicable, message is sent back to the battalion commander by motorcycle messenger.

(2) *Advance guard.*—An advance guard for a reinforced battalion acting alone will frequently consist of a tank company reinforced with a platoon of infantry, engineers, and one or more assault guns or mortars (see FM 17-32 and fig. 24). During daylight tanks generally lead. During darkness infantry usually leads.

(a) The battalion commander and the artillery observer ride at the head of the support.

(b) The artillery marches between the support and the main body.

(c) The advance guard attacks boldly and attempts to overcome hostile resistance. It serves as a covering force for the development of the main body and as a pivot of maneuver. (See sec. VI.)

(3) *Flank guards.*—(a) Flank guards, consisting usually of not more than a platoon preferably of light tanks with a squad of infantry attached or a platoon of infantry with an assault gun squad attached, are sent out for 2 to 5 miles, depending upon the road net, to protect the flanks of the

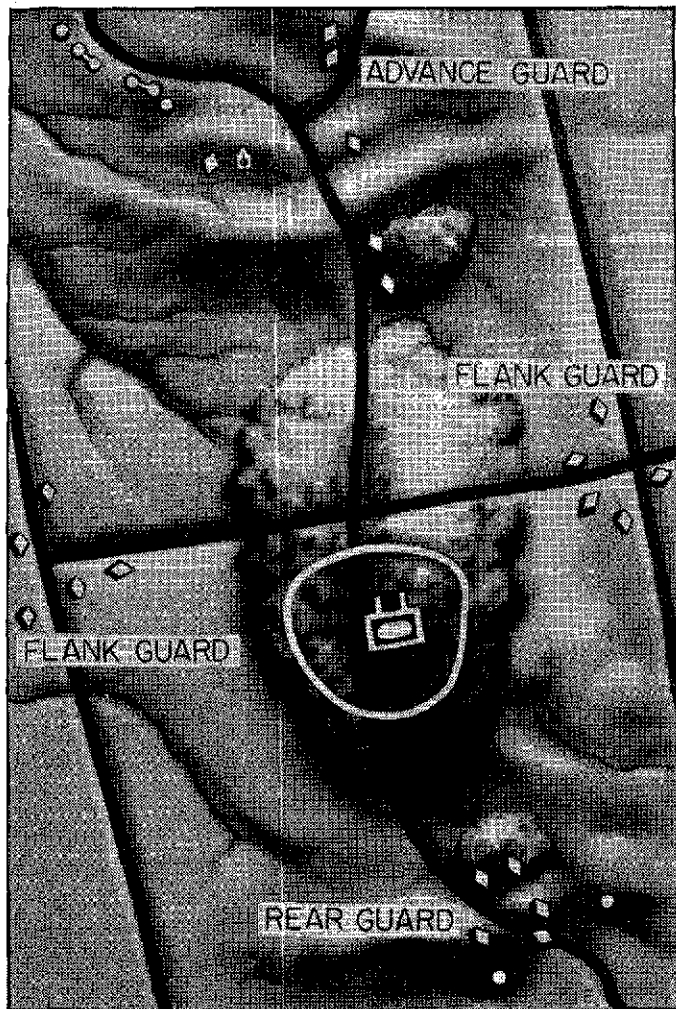

FIGURE 24.—Security, armored battalion acting alone.

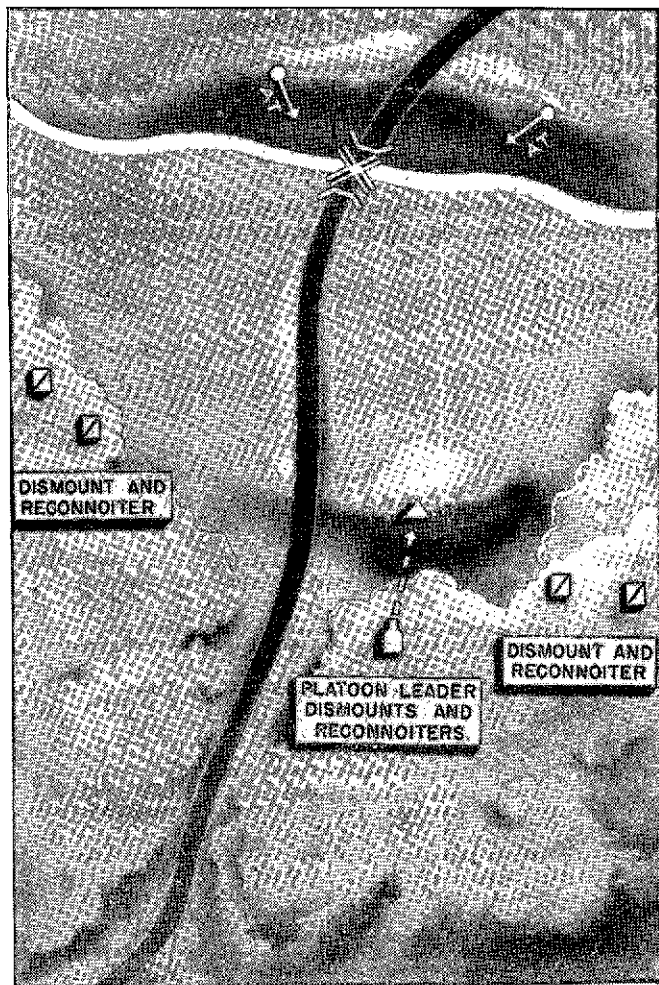

FIGURE 25.—Battalion reconnaissance platoon. When resistance cannot be overcome, seek flanks. Report enemy situation to column commander.

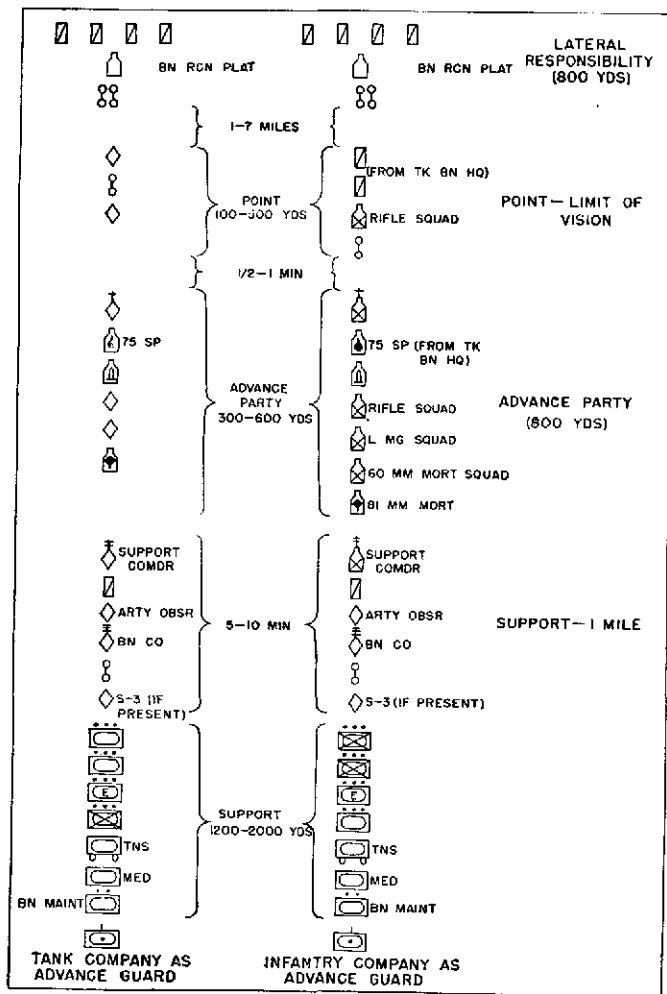

FIGURE 26.—Advance guard, armored battalion acting alone. Artillery moves between the support and the main body. Artillery observer is with the support commander.

battalion. Light tanks because of their speed are more suitable than medium tanks for flank guards.

(b) *The flank guard protects the battalion from surprise attack from the flanks. It reconnoiters points from which the enemy may observe the march of the column. It usually moves by bounds, occupying key positions the holding of which will protect the main body. (See FM 100-5.) The flank guard may split into two or more parts and use the leapfrog method of advance. (See fig. 27.)*

(4) *Rear guard.*—(a) When the battalion is advancing the rear guard will usually consist of a tank or infantry platoon with an assault gun and a mortar attached. The rear guard follows the main body by about 5 to 10 minutes. When the enemy attacks from the rear, the rear guard fights a delaying action, withdrawing a portion of its force under cover of fire of the remainder, occupying positions that afford good fields of fire and at the same time afford good routes of withdrawal.

(b) When the battalion is retiring, a stronger rear guard is detailed. Such a force may consist of a tank company reinforced with infantry and engineers. Artillery will move between the rear guard and the main body. The artillery observer, mounted in a tank, marches with the rear guard commander. For action of a company acting as rear guard see FM 17-32.

b. *Battalion as advance guard.*—(1) The mission of the advance guard is to prevent unnecessary delay of the main body and to protect it against surprise and observation (FM 100-5). The action of the advance guard depends upon the plan of the column commander. The advance guard commander must be careful that he does not commit the column commander to a line of action that will hinder freedom of movement. The main body deploys under the protection of the advance guard.

(2) When detailed as advance guard, the battalion usually is reinforced with a battery of field artillery, a company of infantry, a company of engineers, and tank destroyer elements. A medium tank battalion may be reinforced with a light tank company and a light tank battalion with a medium tank company. During daylight, tanks lead, the



FIGURE 27.—Action of flank guard. Hold (1), (2), and (3) until main body passes. Check hills (4) and (7) and woods (5) and (6) for enemy.

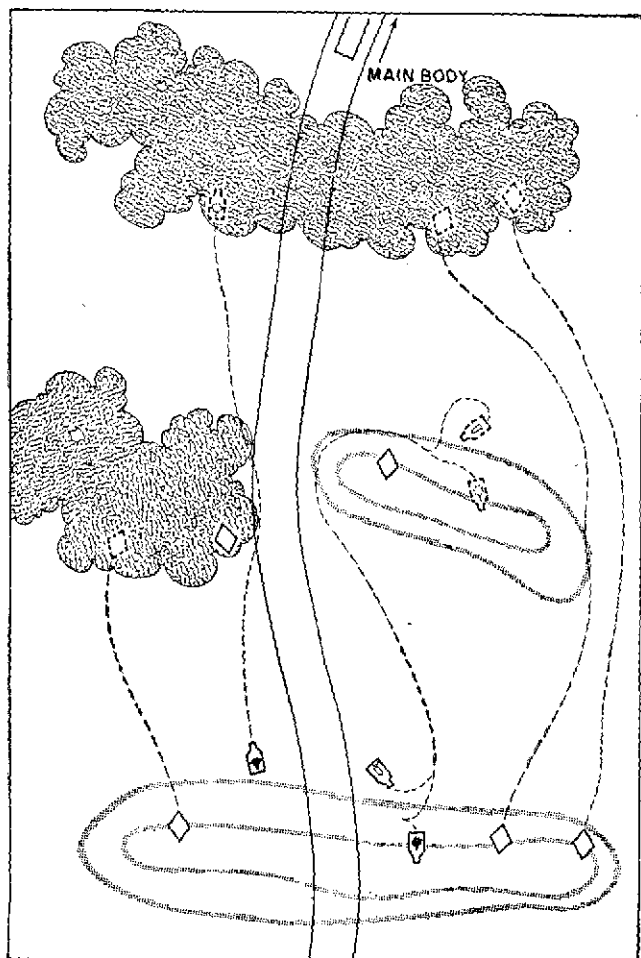

FIGURE 2B.—Rear guard action, battalion advancing. Part of force covers withdrawal of remainder. Assault gun and the mortar used to slow enemy advance. Do not let force be flanked.

support being a light tank company if one is present. During darkness, infantry leads, if present.

(3) Figure 29 shows one formation for a reinforced battalion as advance guard.

(a) Use reconnaissance platoon for reconnaissance to front and flanks even though a regimental reconnaissance company may be out in front. Do not use the reconnaissance platoon as a point.

(b) Arrange for patrols to flank. (See fig. 24.) Use light tanks, available motorcycles, and $\frac{1}{4}$ -ton trucks for this purpose.

(c) Investigate points where enemy may have good observation. Investigate woods where enemy may try an ambush.

(d) The battalion commander with the artillery forward observer and such staff as he desires marches in interval between the support and the advance party. Here he can obtain early information of the enemy.

(e) The artillery battery marches in the interval between the support and the reserve.

(f) The battalion command post is at the head of the reserve. S-3 or the headquarters commandant conducts the march of the reserve. Company commanders (except the support commander) and the artillery liaison officer march with the battalion command post. Companies are conducted by the senior platoon leader, all platoon leaders being at the head of their respective companies.

(g) Radio receivers except those specifically designated for higher command net, reconnaissance company net, or air-ground net, are tuned to the battalion command frequency. Company nets are formed on command of the battalion commander, FORM NETS, or other designated signal.

(h) *Keep the column commander informed of the situation.* This is done by radio or messenger. The column commander will usually be with the advance guard commander or near the head of the reserve.

(4) For action when enemy is met, see section VI and FM 17-32.

c. Reinforced battalion as flank guard.—(1) The reinforced armored battalion may be used as a flank guard. If strong enemy forces are expected, strong engineer and tank-destroyer detachments should be attached.

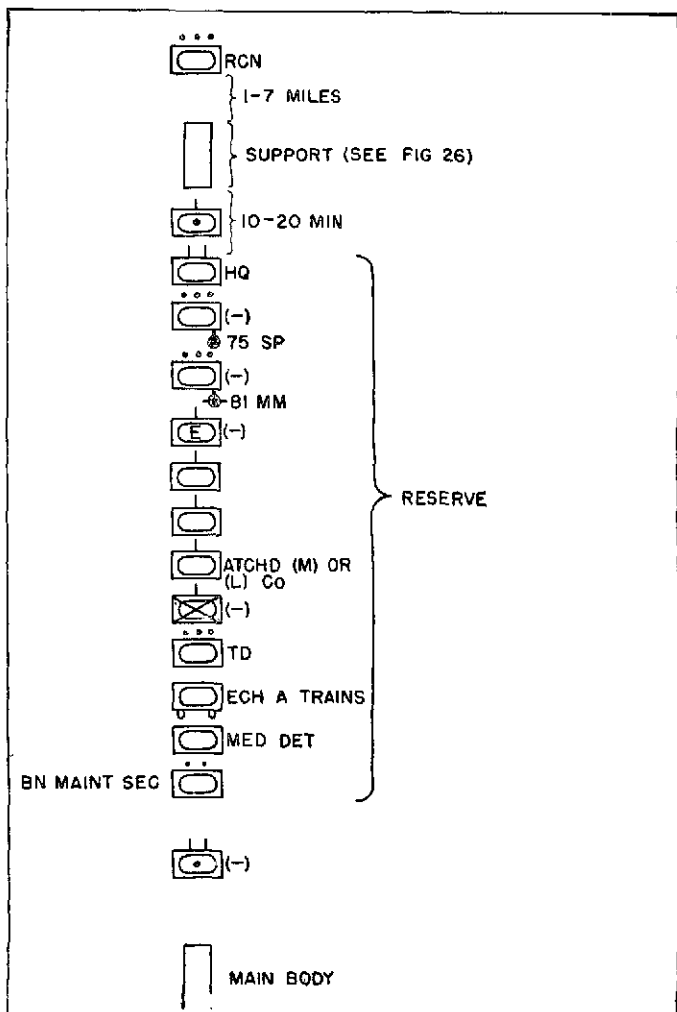

FIGURE 29.—Formation of the reinforced armored battalion as advance guard. During daylight use light tanks, if present, as the support. During darkness, part of the infantry in the support will lead.

(2) The light tank battalion, because of its mobility, is more suited to flank guard duty than the medium battalion. This is particularly true when key points must be occupied and elements of the battalion move by leapfrogging or by successive bounds. Medium tanks, because of their slowness will not be able to perform such a maneuver and keep abreast of the column.

(3) As a flank guard, the battalion protects the main body from attack of ground forces and from terrestrial observation by the enemy. It furnishes its own advance, flank, and rear guards. (See *b* above.) The following is a guide to the planning and execution of duties of the flank guard:

(a) Select a route roughly parallel to the route of the main body. This, depending upon terrain, should be from 5 to 15 miles to the flank. The column commander will usually designate the route.

(b) Select critical points to be held until the main body passes.

(c) Detail detachments to hold these critical points. Such detachments may vary from a section of tanks to a reinforced tank company depending upon its importance. Critical defiles are held by road blocks covered by the fire of tanks or antitank guns.

(d) Give definite instructions to each detachment as to where it is to go, what it is to do, and how long it is to stay in position. If the time cannot be determined, arrange for relief by signal, by radio, or by messenger.

(e) If critical points are not to be occupied, then prescribe a formation for the march that will adequately protect the column. When the terrain is such that the enemy can attack from almost any point, march in small groups and arrange for rapid concentration to repel attack.

(f) If attacked, concentrate and repel attack. Fight delaying action if necessary by occupying successive positions. Do not expect help from the main body; its mission may prevent such help.

d. Reinforced battalion as rear guard.—(1) The reinforced battalion will rarely be used as a rear guard except in withdrawal. The formation of the rear guard is the reverse of an advance guard.

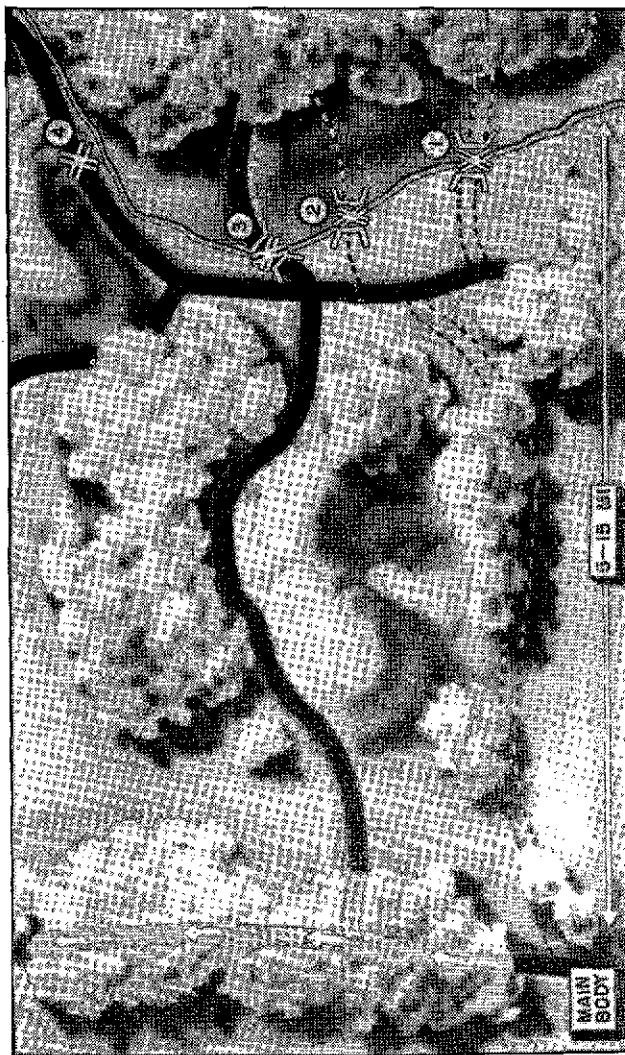

FIGURE 30.—Flank guard holding critical points. Place road blocks at (1), (2), (3), and (4) until main body passes.

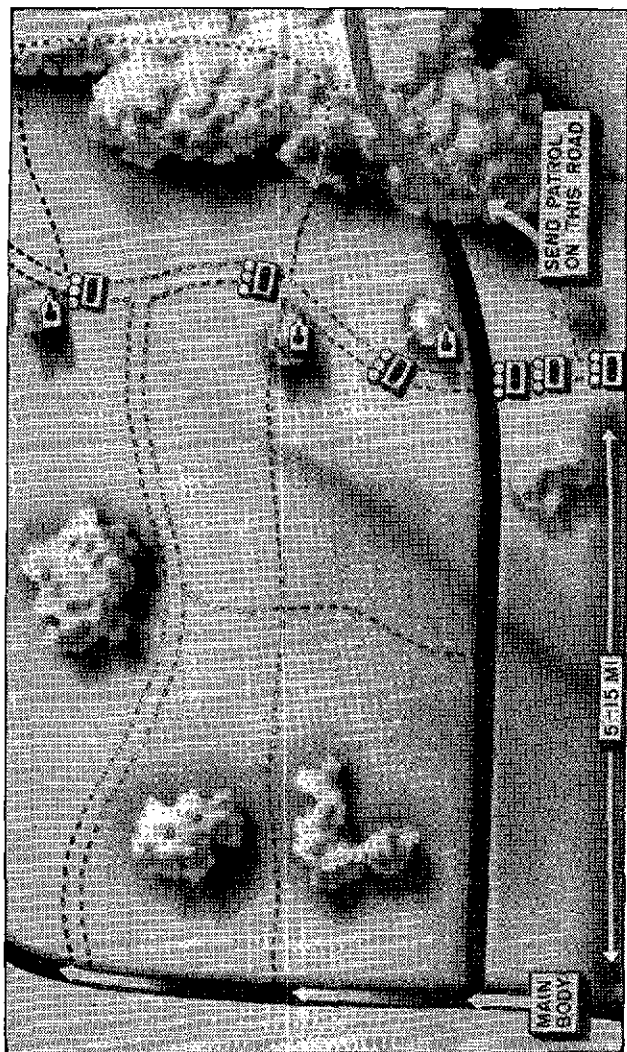

FIGURE 31.—No defiles, march in groups. Cover roads. Send out flank protection. Arrange for quick support of any unit attacked.

(2) The rear guard in withdrawal protects the main body by delaying the enemy and making him fight small time-consuming actions. The rear guard must not become heavily engaged. For delaying action see paragraph 41.

e. Armored battalion as part of main body.—(1) As part of the main body the battalion is responsible only for local protection to the flanks to guard against surprise attacks. Motorcyclists and men in $\frac{1}{4}$ -ton trucks are sent to the flanks on roads for distances up to $\frac{1}{2}$ mile to observe until the column passes. All possible observation points overlooking the line of march are investigated. Use reconnaissance platoon supplemented by available $\frac{1}{4}$ -ton trucks and motorcycles for this purpose.

(2) Air and ground alert sentries are detailed. Have certain platoons or vehicles guard to the right and certain others to the left. (See fig. 32 and par. 25.)

■ 24. IN BIVOUC.—Security in bivouac is obtained by concealment, use of natural and artificial obstacles, by posting local security, by reconnaissance, and by establishment of an outpost. This paragraph deals with security against ground attack. For security against air attack see paragraph 25.

a. Outpost.—(1) An outpost is a security detachment to protect a resting command or a defensive position against annoyance, surprise, and observation by ground forces. The outpost must furnish security in all directions from which enemy ground forces may attack.

(2) The strength and composition of the outpost vary with the distance from the enemy, and his mobility, armament, and attitude; the terrain; time of day; size of the command to be secured; degree of resistance the outpost is expected to offer; and the special duties assigned to it. The reinforced battalion may be detailed as an outpost of a larger command. When acting alone the battalion details its own outpost. Prior to establishment of an outpost the advance, flank, and rear guards form a march outpost.

b. Battalion as march outpost.—(1) When the battalion is an advance guard, the battalion commander, upon receiving the halt order designating the bivouac area, plans for and issues orders for the march outpost.

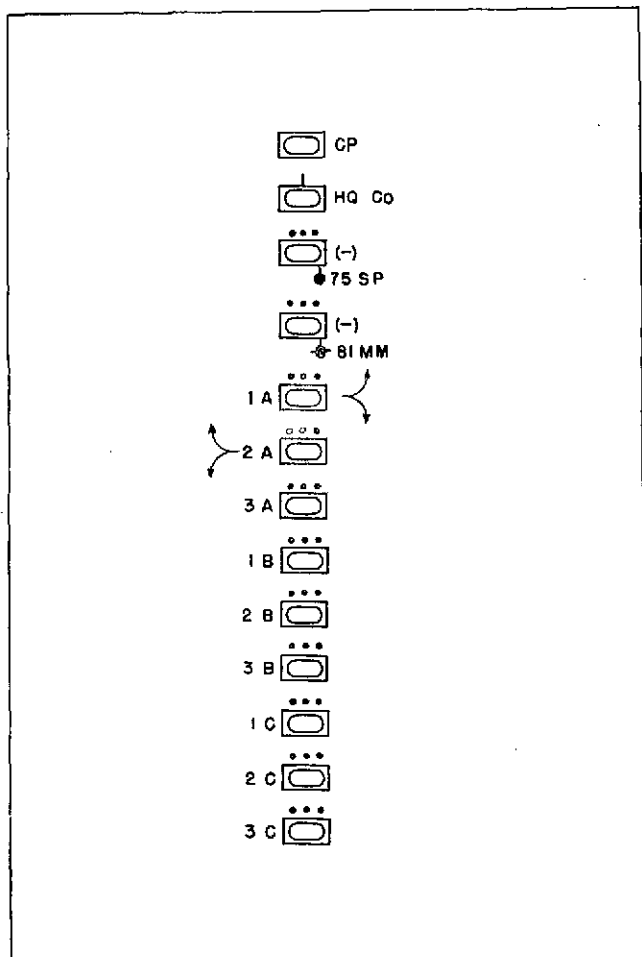

FIGURE 32.—Security when part of main body. A method of protecting flanks. Alternate platoons guard right and left. Individual tanks keep turret weapons point to front and left or right and rear.

(2) Figure 33 shows a march outpost established by a reinforced light armored battalion. The reconnaissance company with the combat command furnishes the reconnaissance for the command. This applies also to a reinforced medium armored battalion. Plan the outpost as follows:

- (a) Give company sectors of responsibility.
- (b) Cover all avenues of approach from the front.
- (c) Establish contact with flank guards.
- (d) Place artillery to cover most likely avenues of approach for hostile troops.
- (e) Use medium tank company to cover important avenues of approach. Coordinate with artillery.
- (f) Locate reserve to repel hostile attack.
- (g) Send reconnaissance out beyond the outpost line 3 to 7 miles.

c. March outpost of reinforced battalion acting alone.—See figure 34.

d. Reinforced battalion as outpost.—For organization of an outpost see FM 100-5 and 17-10.

(1) When on outpost duty the armored battalion should be reinforced with infantry and engineers and supported by artillery and tank destroyer elements.

(2) The outpost for a force the size of a combat command should protect the command from medium artillery fire, that is, it should send some patrols out at least 10,000 yards from the bivouac.

(3) Figure 35 shows a reinforced armored battalion on outpost. The procedure in establishing such an outpost is as follows:

(a) Upon receiving orders for the outpost make a map reconnaissance and divide the area into supports. Assign units to these areas.

(b) Determine places for detached posts.

(c) Locate reserve.

(d) Determine artillery missions.

(e) Plan for patrols.

(f) Place plans on a map or overlay and give oral order for the outpost. (See FM 101-5 for form of order.)

(g) After supports and outguards have been established, inspect, make necessary changes, and coordinate the supports.

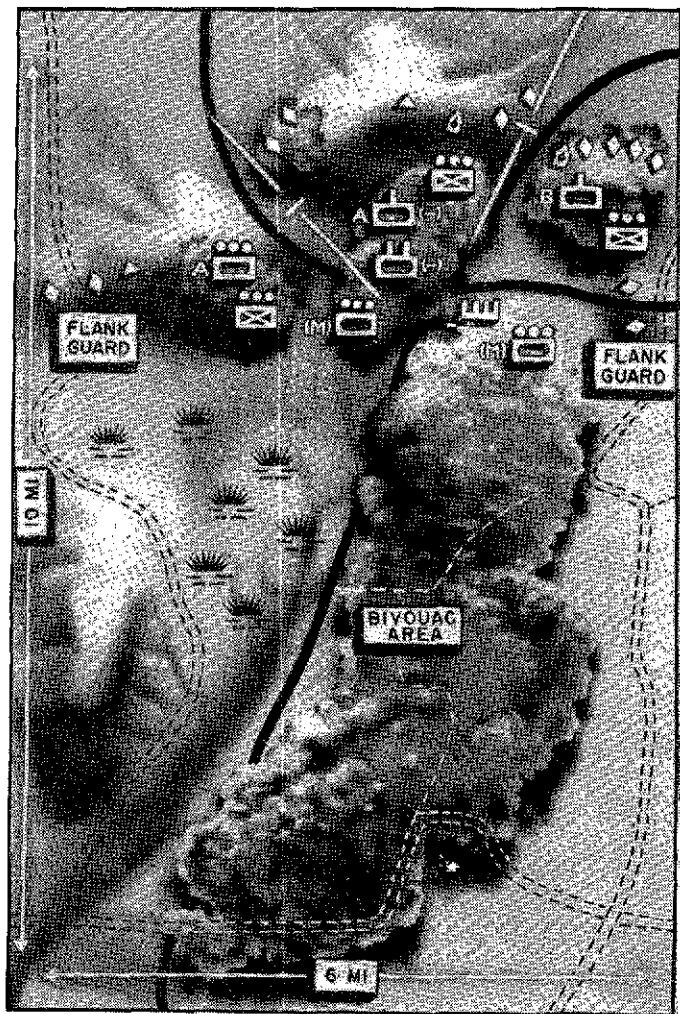

FIGURE 33.—Battalion as march outpost.

(h) Road blocks protected by 37-mm or 75-mm guns are established. Engineers are used to assist in this work.

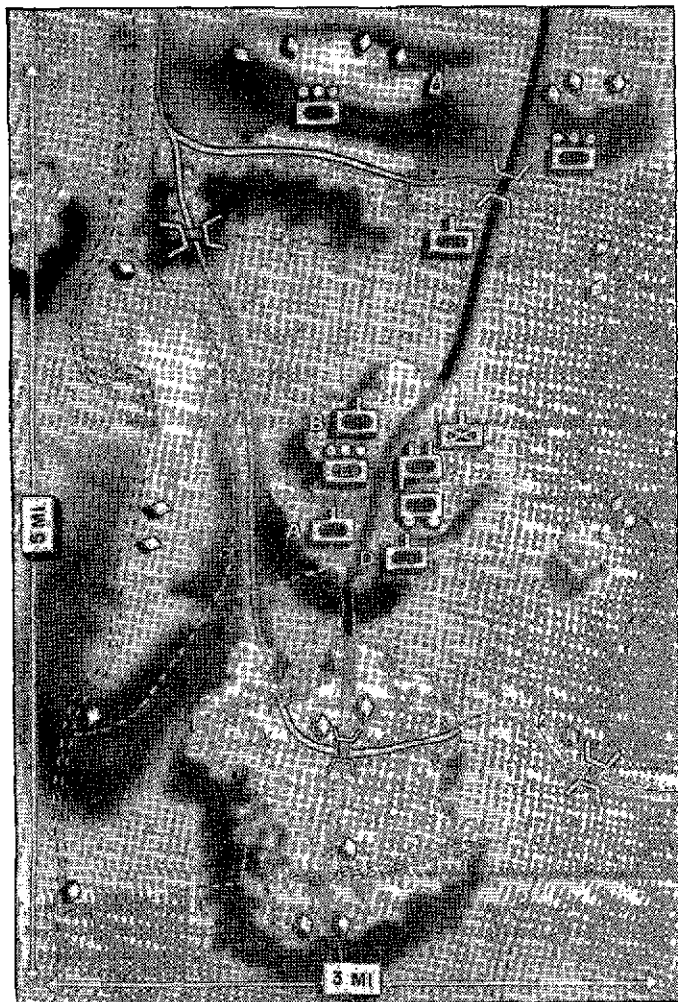

FIGURE 34.—March outpost for a reinforced battalion.

(i) Make plans for reserve to reinforce any part of the outpost in case of necessity.

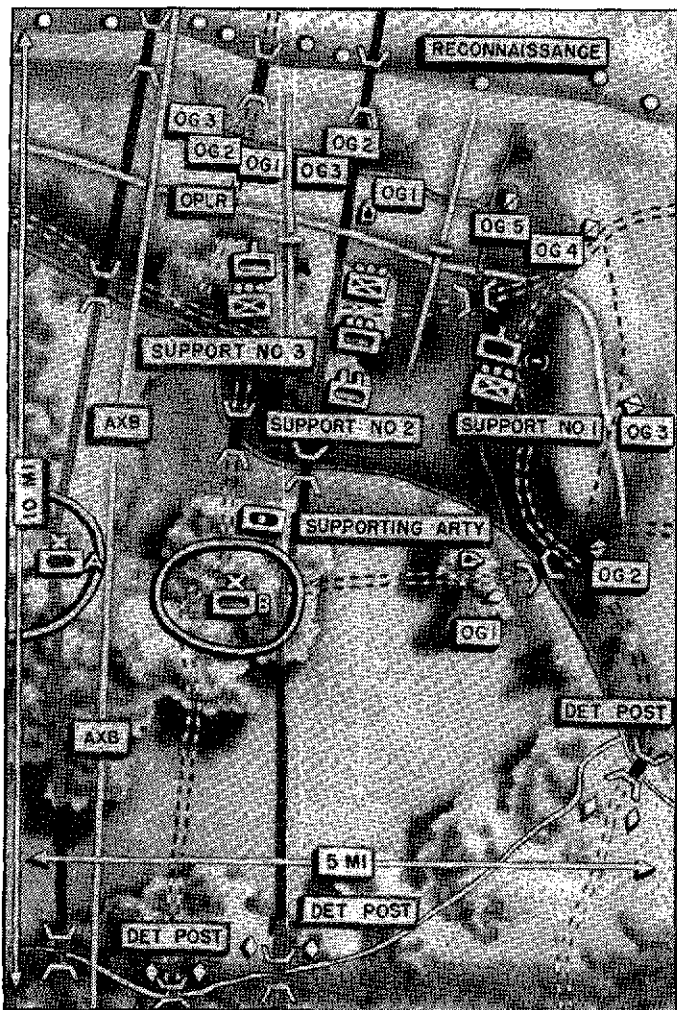

FIGURE 35.—Reinforced armored battalion as outpost.

(4) Conduct of the outpost is as follows:

(a) A patrol should visit each outguard at least once an hour. Special recognition signals must be prescribed so outguards will not fire on patrols. Contact between supports should be established from right to left. Thus in support No. 1 (fig. 35) a patrol would visit outguards Nos. 1, 2, 3, 4, and 5 and outguard No. 1 of support No. 2. Support No. 3 contacts the nearest outguard of Combat Command A.

(b) The reserve causes a patrol to visit support Nos. 1, 2, and 3. Special patrols visit the detached post. The reserve also contacts the nearest support of Combat Command A.

(c) The reserve is held in readiness to move to any threatened point.

(d) *Radio is silent, except in case of a strong attack.* Lights must not be used.

(e) The artillery prepares supporting fires. Medium tanks are also used for this purpose. Fire data are prepared and guns laid for deflection and elevation. Special signals are arranged for firing certain predesignated concentrations.

e. Battalion acting alone.—When acting alone an armored battalion establishes an outpost as described in *d* above. Such an outpost must be far enough out to protect the bivouac from small-arms fire but not so far that it may be cut off by the enemy.

f. Circular outpost.—When country is open such as in a desert a circular outpost is established. (See fig. 36.)

■ 25. AGAINST AIR ATTACK.—Security against air attack is obtained by an extensive warning system, dispersion, concealment, and use of available weapons. One radio in the battalion headquarters must be on the air warning net if such is established or the column command net on the march.

a. On the march.—(1) When there is danger of air attack, and this is present anywhere in the theater of operations, vehicles should move at not less than 80 yards distance.

(2) Air alert sentries are designated in each vehicle.

(3) Vehicles or platoons are given designated sides of the road to cover. For example, one platoon may be told to cover to the front and right while the next covers to the left and rear. Low-flying bombers attack low over woods or hills, therefore some guns must cover these places. Use

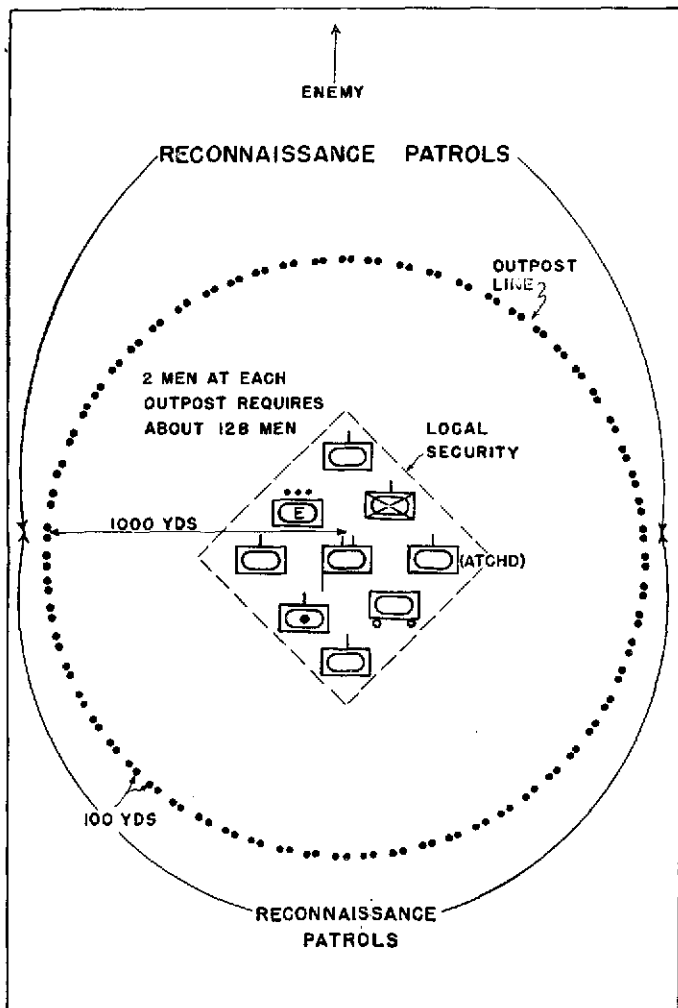

FIGURE 36.—One form of outpost in open terrain with no natural obstacles available.

individual arms, machine guns, and 37-mm tank guns. The 75-mm gun may be used at times. For low-flying attack the guns must be trained on the point of probable appearance of the airplanes. There will be no time to shift after the airplanes appear. Have all receivers on battalion frequency so air alert warning can be transmitted quickly.

(4) At temporary halts, move under concealment and brush out tracks. If concealment from observation is not available, move off road and disperse, if possible. Dig slit trenches at long halts. If vehicles are concealed, do not fire at airplanes unless attacked.

b. *In bivouac*.—(1) Air security in bivouac, assembly areas, and rallying points is obtained primarily by concealment and dispersion. Air sentries are detailed. Use standard air alarms. Keep one battalion radio receiver on reconnaissance unit frequency so early warning of approach of airplanes may be obtained.

(2) Brush out all tracks (see fig. 40).

(3) Enforce rigid camouflage discipline. Dig slit trenches. Prohibit unshielded lights.

(4) Do not fire at airplanes unless attacked.

■ 26. IN ASSEMBLY AREA AND AT RALLYING POINT.—*a.* At assembly area and rallying point make use of available cover and concealment. Post local security.

b. At rallying point, first unit to arrive posts weapons to cover favorable avenues of approach. Post observation. As more units arrive, the battalion commander posts more security details and then reorganizes his battalion.

c. Use available tank destroyer elements to assist in protection. (See FM 18-5.)

■ 27. AGAINST CHEMICAL ATTACK.—See FM 17-10 and 21-40.

SECTION VI

OFFENSIVE ACTION

■ 28. GENERAL.—For fundamentals of offensive action see paragraph 3, and FM 100-5 and 17-10. The missions of echelons of attack are as follows (see FM 17-100):

a. The combat command or armored regiment will usually attack in three echelons. The light or medium armored

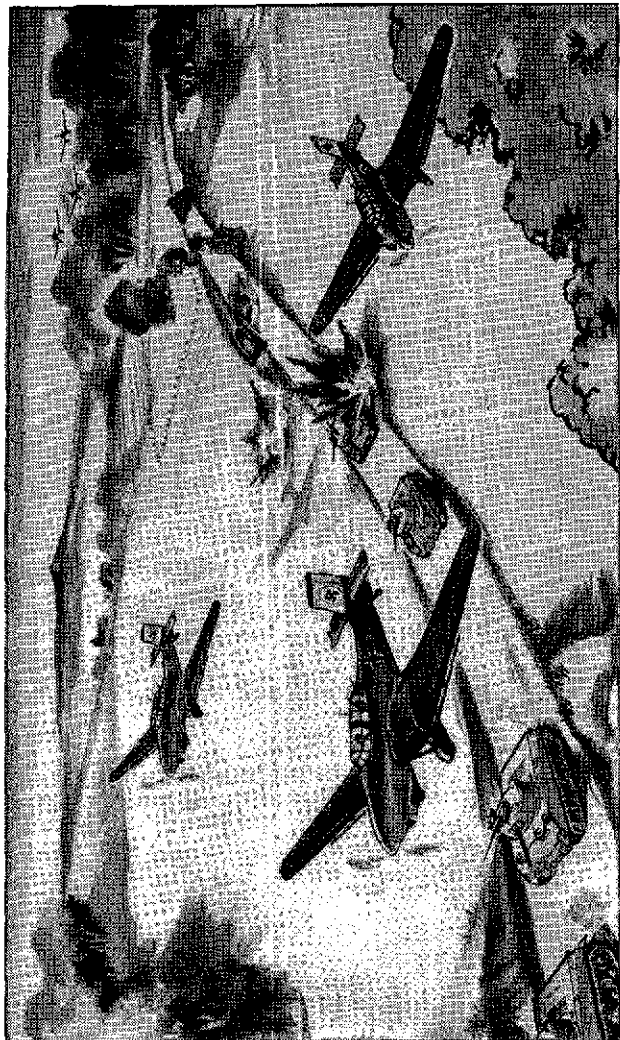

FIGURE 37.—This column was not alert. Hostile airplanes attacked over woods in rear. Vehicles closed up at bottom of hill and made a perfect target. BEWARE OF DEFILLES.

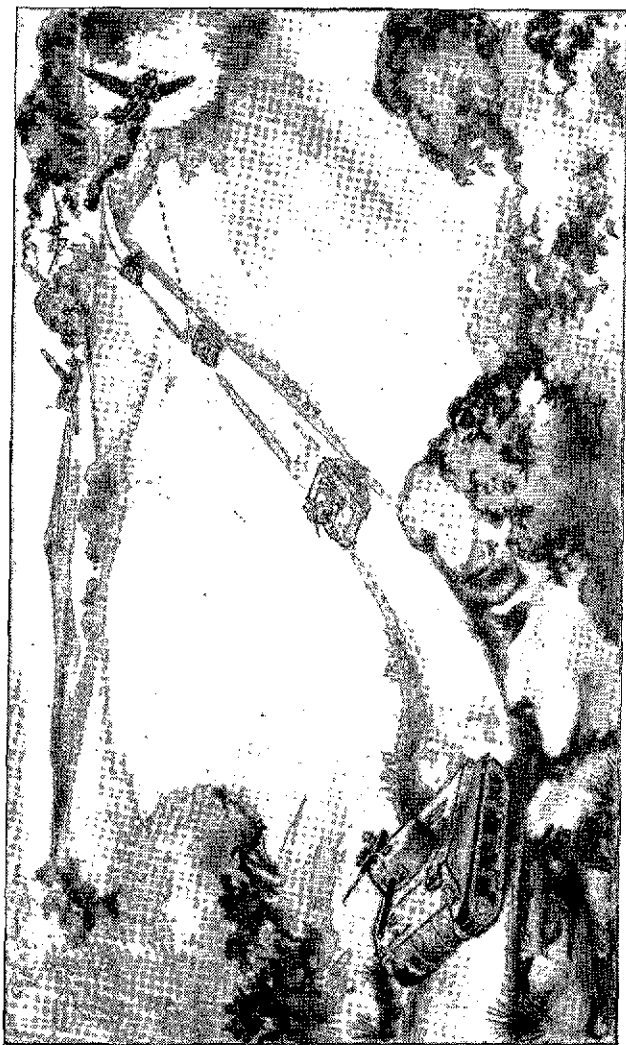

FIGURE 38.—Here some guns pointed to rear and covered woods. Vehicles are properly spaced. This column was alert.

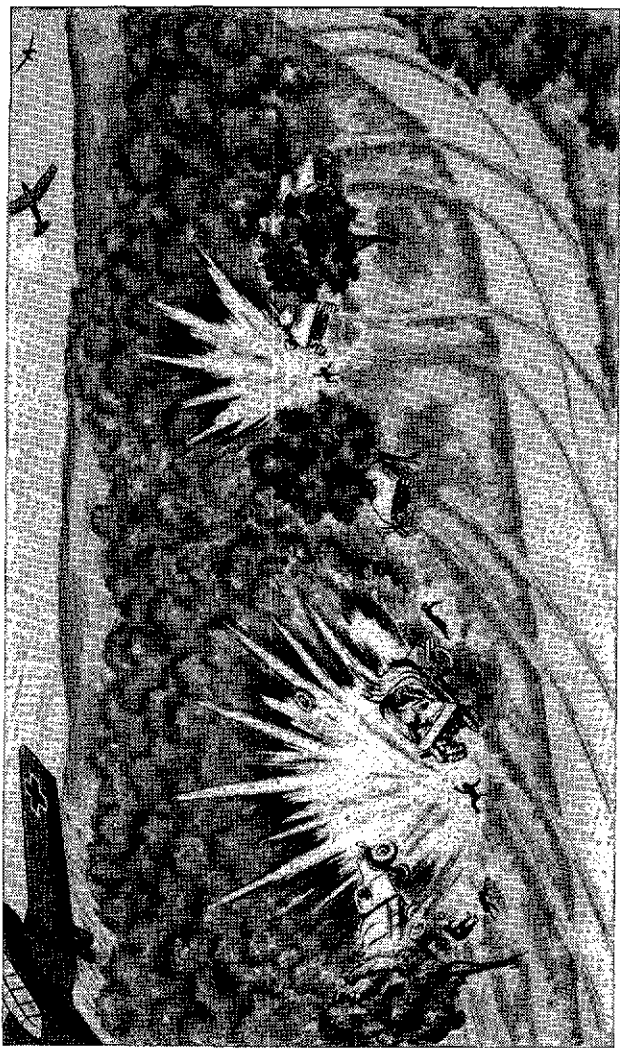

FIGURE 39.—Tracks here disclosed the position of the vehicles. Also vehicles were not dispersed. Silt trenches had not been dug.

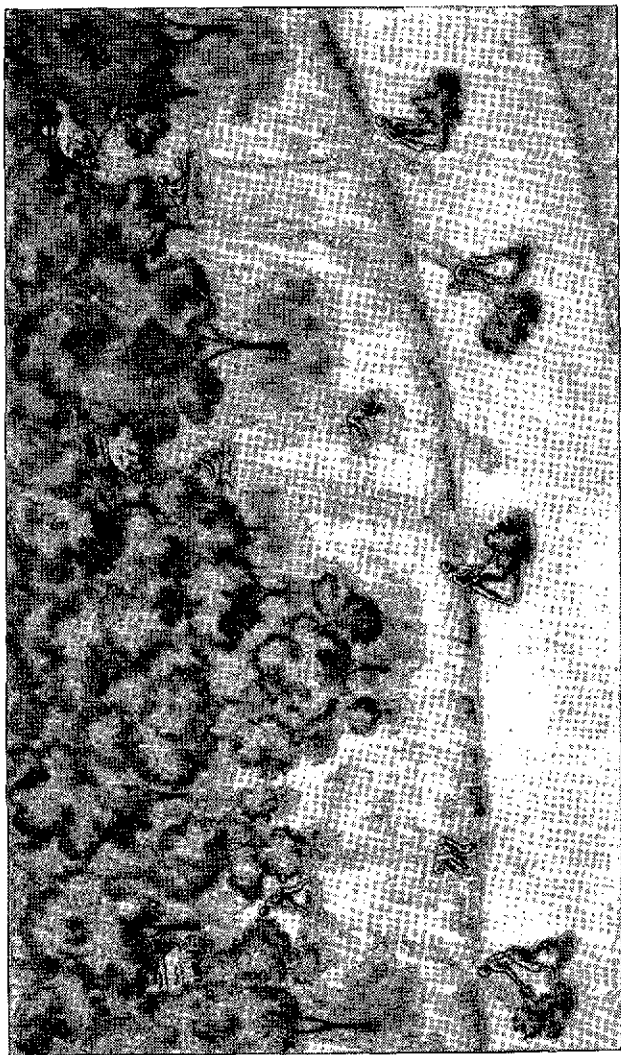

FIGURE 40.—Brush out tracks, disperse vehicles, dig silt trenches.

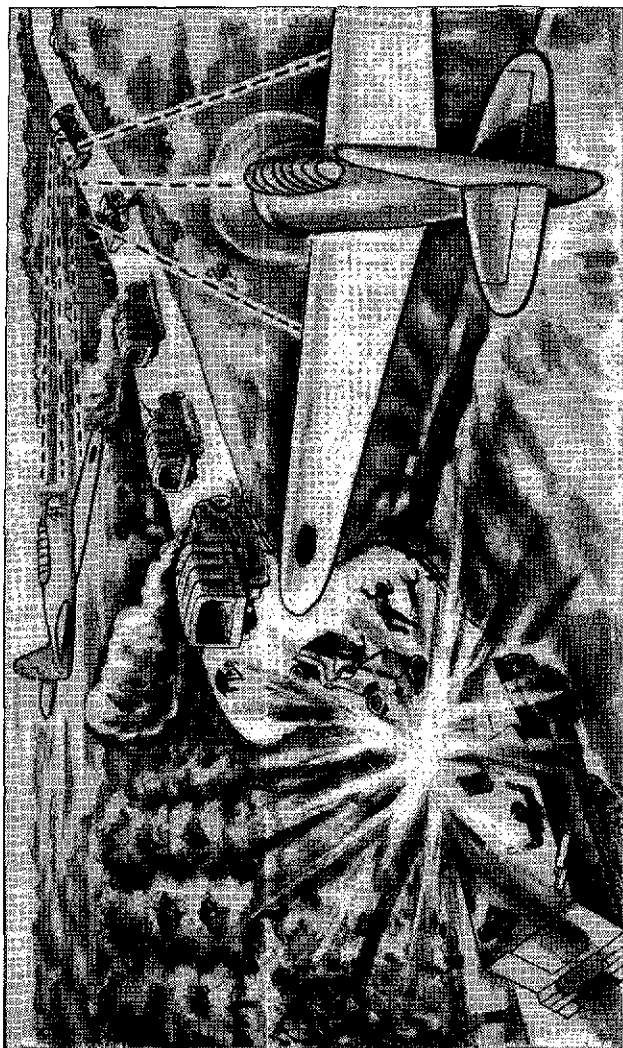

Figure 41.—Vehicles closed up at halt and stayed on road. They make an excellent target.

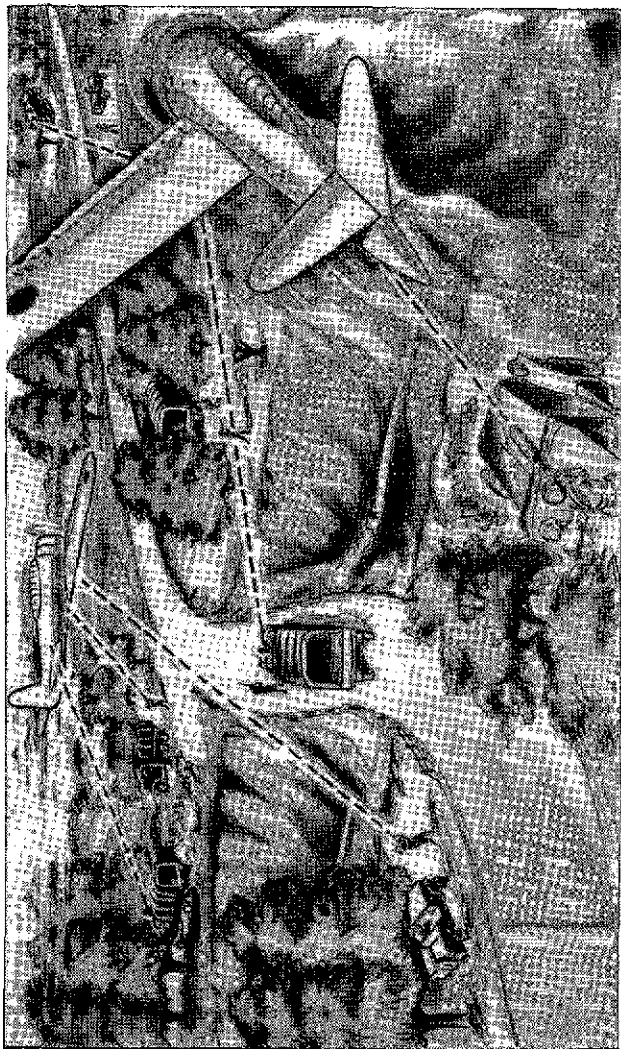

FIGURE 42.—Move off the road if practicable. Disperse. If possible, always halt in a shadow. If it is impossible to move off the road, keep some weapons manned and ready to fire. Cover all directions.

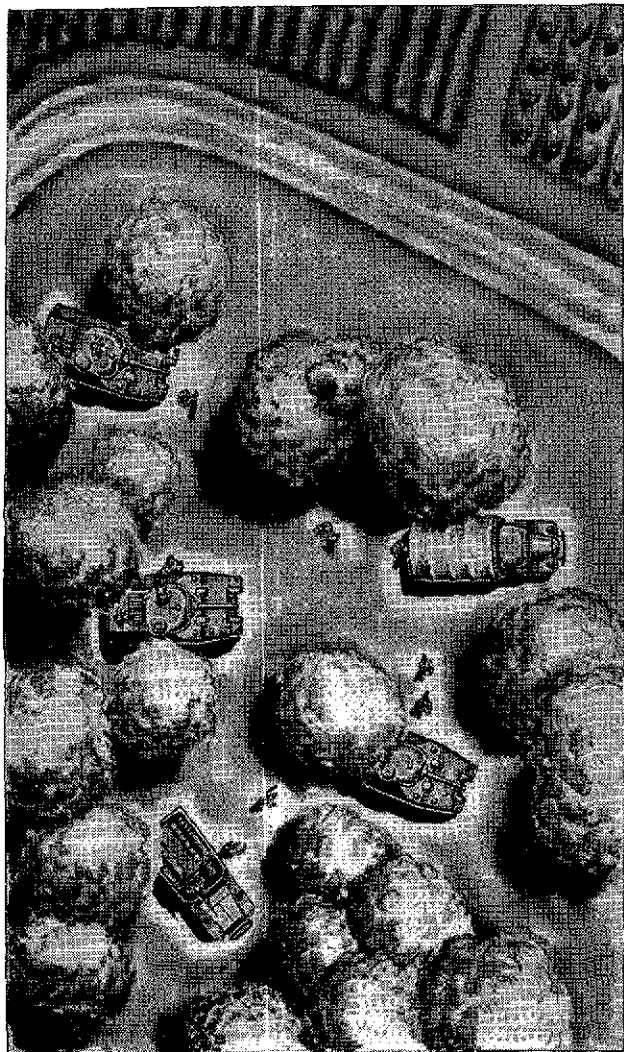

FIGURE 43.—Here advantage was not taken of cover. This invites disaster.

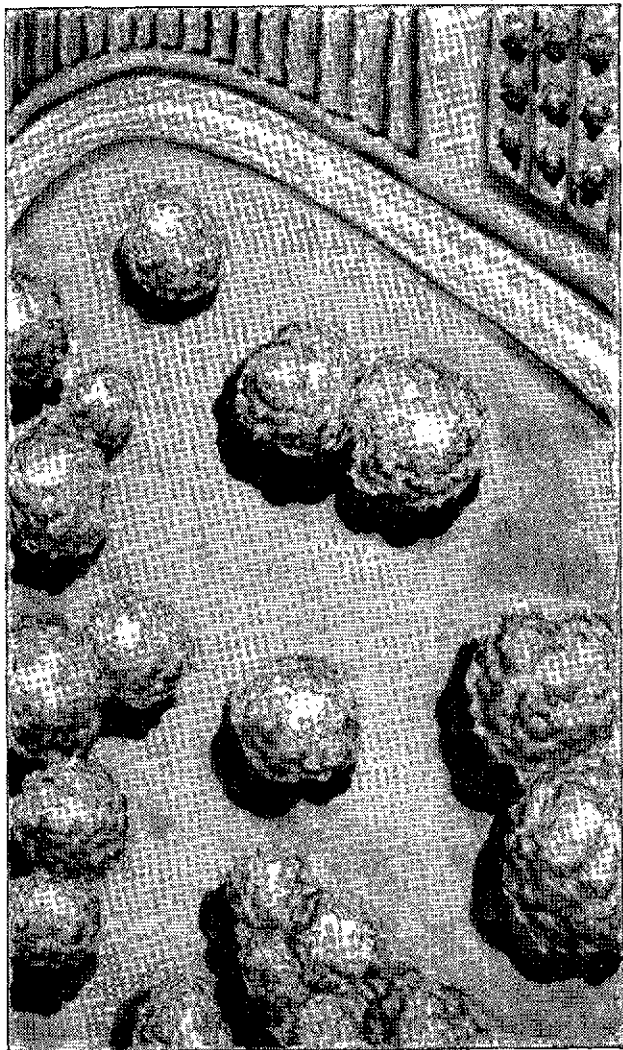

FIGURE 44.—Advantage was taken of available concealment here.

battalion may be in any of these echelons. Each echelon attacks in a series of waves using fire and maneuver.

(1) *First echelon.*—The mission of the first echelon of attack is to destroy enemy antitank defenses, artillery, command posts, and other rear installations. It pays little attention to personnel other than that operating antitank weapons and artillery, command post personnel, or reserves in assembly areas.

(2) *Second echelon.*—The mission of the second echelon of attack is to destroy infantry with its weapons, especially machine guns. It destroys antitank guns passed over by the leading echelon and also command posts, communication centers, reserves, and rear installations.

(3) *Third echelon.*—The third echelon of attack advances with the infantry and destroys enemy personnel, machine guns, and installations holding up the infantry.

b. It must not be assumed that the tanks will always attack first. Many times infantry will attack to secure ground from which a tank attack may be launched or in conjunction with engineers, to remove or clear paths through obstacles.

■ 29. FORMATIONS, FRONTAGES, AND DEPTHS.—Formations, frontages, and depths will depend upon the mission, terrain, enemy situation, and supporting fires. For type formations see figure 46. Companies may be in any suitable formation. (See FM 17-32.)

a. *Frontage.*—(1) Wide frontage may be taken on a covering mission while a penetration calls for narrow frontage and great depth to give sustaining power to carry the action through to a successful conclusion.

(2) A narrow frontage to facilitate control is taken in wooded terrain. Impassable ground may narrow the formation. (See fig. 47.) In open terrain, wider frontages than for wooded terrain are practicable and desirable.

(3) When enemy has few antitank guns and his other antitank defenses are light a wide frontage may be taken. If enemy antitank defenses are strong and cannot be avoided, a narrow frontage and formation in great depth is taken.

(4) When well supported by artillery and bombardment aviation, the frontage may be greater than when such support is light or lacking. In the latter cases, the tanks must furnish their own supporting fires.

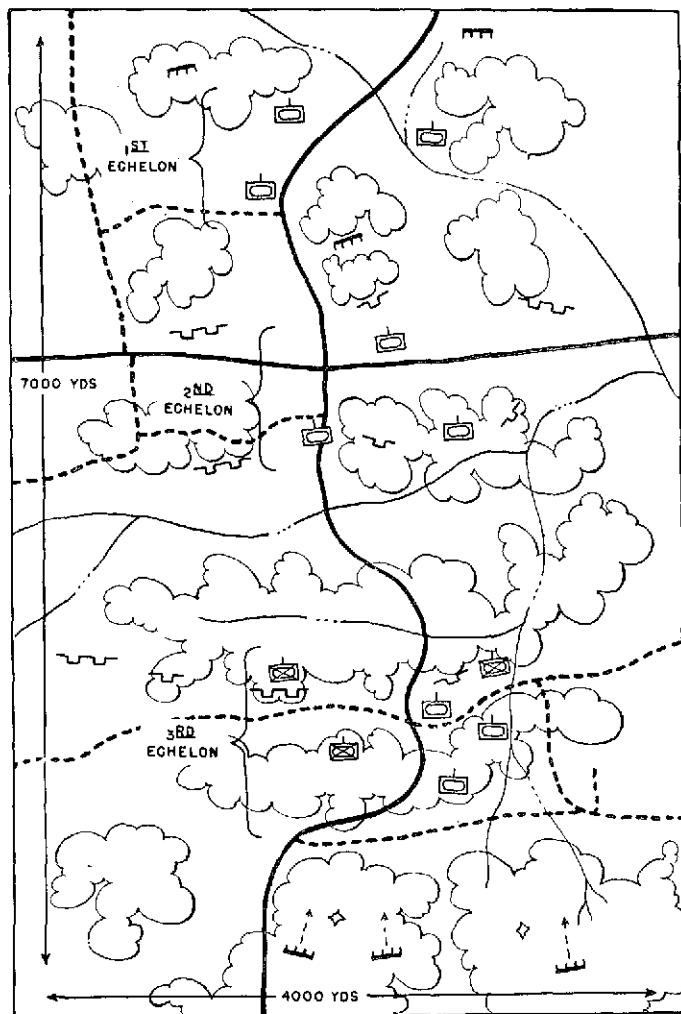

FIGURE 45.—Echelons of attack. Distances are not fixed but will depend upon terrain and the enemy.

b. Inverted wedge.—This formation is suitable for any echelon of attack. It provides strong fire power to the front, flank protection, fire support, and a reserve to influence the action.

(1) Frontage in this formation will rarely exceed 1,500 yards.

(2) The depth of the formation depends upon the terrain, mission, and fire support of other units.

(3) The reserve is usually located behind the company making the main effort. It moves from firing position to firing position to give continuous support to the leading companies. It is prepared to repel counterattacks from the flank or to pass through a depleted leading company and continue the attack.

(4) Unless an extremely wide front is covered, the mortar platoon and the assault gun platoon should be retained under battalion control.

c. Wedge.—This formation is used in advancing against an enemy whose defenses have not been definitely located. The leading company covers the advance of the other two companies. These companies in turn protect the flanks, give fire support to the leading company, and are prepared to maneuver to either flank. Mortars and assault guns may be attached to the leading company.

d. Column.—Column gives maximum control and driving power. The battalion may be quickly developed to either flank. The formation is useful in passing through woods. It may have to be used in passing a defile. It is the best formation for a penetration when the battalion is acting alone. For the initial advance against light enemy resistance, the leading company will usually cover a broad front.

e. Echelon.—The battalion may be echeloned either to the right or left. Such formations are useful for a flank battalion as it gives great flank protection by favoring rapid deployment to the exposed flank. Assault guns and mortars may be attached to companies.

f. Line.—This is a rare formation as it provides little depth and consequently low sustaining power. Its use is confined to screening or counterreconnaissance missions. Assault guns and mortars should be attached to companies.

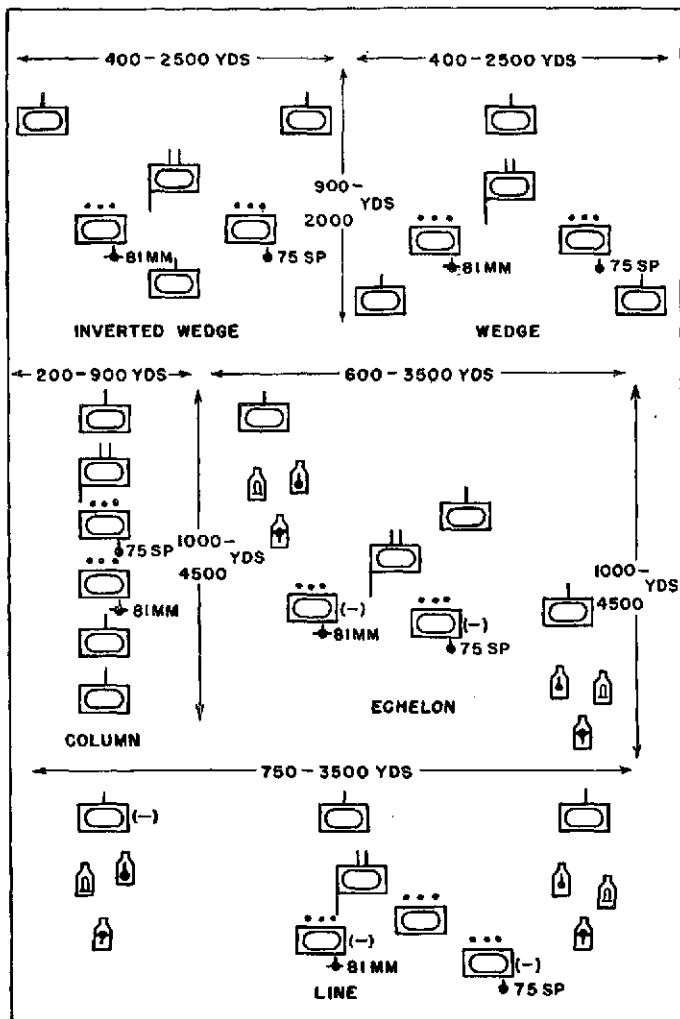

FIGURE 46.—Schematic formations for an armored battalion.

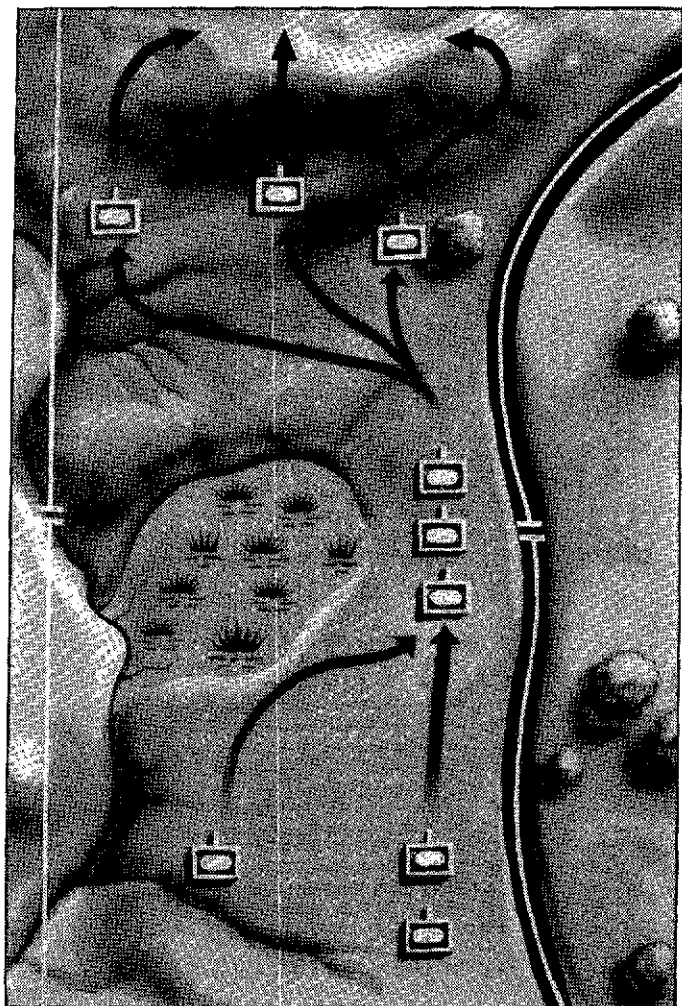

FIGURE 47.—Influence of terrain on formations.

g. Other formations.—There are other formations or modifications of the above formations that may be used to meet a particular tactical situation. For example, in the echelon formation the rear company may follow in the trace of the center company.

■ 30. BATTALION HEADQUARTERS (see FM 17-10).—*a.* In the approach to combat and in combat, the battalion has with it only those individuals and vehicles necessary for the control, maintenance, and evacuation of the battalion and for supply of the battalion in the assembly position. All supply vehicles—gasoline, ammunition, equipment, and kitchen trucks if with the column—are left at the assembly position to be moved forward as directed by the regimental or combat command commander. Personnel sections are with the regimental, combat command, or division trains.

b. The forward echelon of battalion headquarters (see FM 17-10) moves with the battalion to the attack position. During combat the battalion commander, the S-2-3, and the artillery forward observer move forward with the battalion, the headquarters commandant remains at the attack position with the battalion headquarters maintenance section, attached battalion maintenance section, battalion medical detachment, and such other vehicles and personnel as the battalion commander may direct. The actions of maintenance and medical personnel are covered in section III. The headquarters commandant moves this group forward as directed by the battalion commander. In a penetration this group will follow the second or third echelon of attack.

■ 31. SUPPORTING FIRES.—*a. Artillery* (see FM 17-60).—The artillery gives close support to the attack in all stages. (See FM 17-10.) An artillery forward observer, mounted in a tank, advances behind the leading waves of tanks. This officer has direct radio communication with the supporting artillery battalion and the tank battalion commander. Other artillery officers usually will be forward to conduct fire of individual batteries as may be necessary, but these will not be in the radio net of the tank battalion commander.

(1) The tank battalion commander may expect from the artillery—

(a) Firing of concentrations to cover development for an attack.

(b) Assistance in security of assembly area by placing concentrations on avenues of approach for hostile troops.

(c) Assistance in protection of the rallying point by fires as necessary on threatening hostile elements, and by counter-battery fire.

(d) Support of initial attack by fires on hostile front line installations, antitank guns, observation posts, and artillery. Targets must not be closer than 300 yards to friendly troops. An area 200 yards wide and 200 yards deep can be effectively covered by one battery.

(e) Continuing support as attack progresses by concentrations on hostile troops and weapons holding up the attack.

(f) Screening, by smoke, of hostile antitank guns and observation points.

(g) Assistance in breaking up hostile counterattacks, including hostile armored threats from the flanks.

(h) Destruction of road blocks and troops defending them.

(2) The battalion commander should not expect the artillery to—

(a) Fire a long preparation before the attack, unless special arrangements have been made for dumping additional ammunition at the guns.

(b) Fire concentrations on unimportant targets or targets which the tanks themselves may overcome without excessive danger.

(c) Fire at targets that can be neutralized more quickly by assault guns, mortars, or tank weapons. Small targets close to the leading tanks and positively located can usually be eliminated quickly without calling for an artillery concentration.

(d) Blast extensive passageways through mine fields.

(3) Each officer must know how to call for and adjust artillery fire. (See FM 17-62.) Radio nets should be set up so that each tank company commander, if necessary, can tune into the artillery net. The company commander needing artillery support first calls his battalion commander on the radio, gives location and type of target, and requests fire. The battalion commander turns the fire mission over to the



FIGURE 48.—Do not call for artillery fire on unimportant missions. Here valuable ammunition is wasted on a machine gun that the tanks themselves can easily overcome.

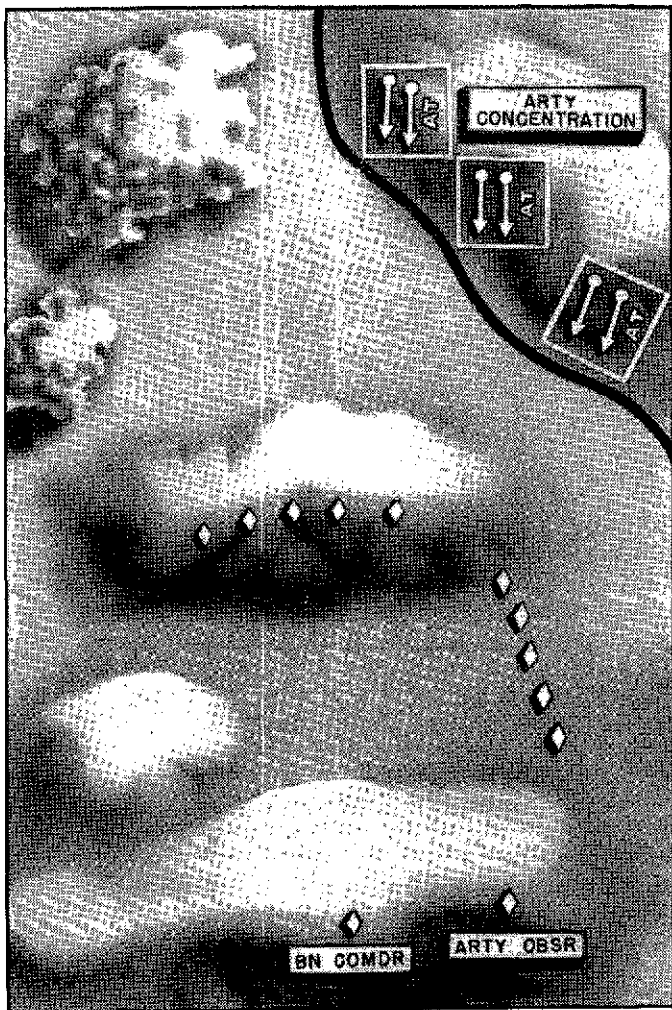

FIGURE 49.—Save artillery for important targets such as groups of antitank guns.

artillery forward observer. If the observer is not in a position to direct the fire and cannot move quickly to such position, he may so state and the battalion commander gives the company commander authority to adjust fire. If the artillery forward observer should become a casualty, either the battalion commander or the company commander may adjust fire.

(4) In order that all officers may be able to adjust fire, the battalion commander in his attack order designates a series of check points and easily identifiable terrain features, and numbers them consecutively in the direction of advance. To distinguish check points for the various artillery battalions, the check points for the lower numbered artillery battalion begins with 100, the next higher 200, and the highest number 300. Company commanders number these check points on their maps.

b. Air support.—(1) Air bombardment is used to supplement artillery fires and to attack targets beyond the range of artillery. The use of air bombardment should be coordinated with artillery fire.

(2) The battalion commander has on his staff an officer called the S-3 for air. When the battalion is making the main effort or is the first echelon of attack this officer is mounted in a half-track vehicle, equipped with long-range radio, from the division signal company.

(3) Should air support be needed and the signal company long-range radio is not available, the battalion commander may arrange through his regiment or the combat command for air support.

(4) If air support is desired, ask for it at the earliest practicable moment. It takes time to get the planes to the right place.

c. Mortar fires.—For employment of mortars see FM 17-27. The mortars should be retained under battalion control when the attack is on a narrow front. When the front becomes so wide that mortar support cannot be given leading companies by retention under battalion control, attach them to companies.

d. Assault gun.—For employment of the assault gun platoon see FM 17-25. The same principle of attachment which

governs the mortar platoon also governs the assault gun platoon.

e. Supporting tanks.—Medium tanks from another battalion may be used to support the attack either by direct or indirect fire. The reserve company should be used to support the attack by fire. Do not attempt to lay down extensive artillery preparations with the medium tanks; the ammunition carried will not permit such action. (See FM 17-32.)

f. Infantry weapons.—When attacking with infantry, the infantry weapons are used to give fire support for the tanks. (See par. 32 and FM 17-10, 17-40, and 17-42.)

■ 32. COORDINATION.—Careful planning, perfect coordination and timing, and vigorous execution are essentials of a successful attack. The effect of all elements—tanks, infantry, artillery, and air—must be coordinated.

a. In a meeting engagement coordination is difficult. (See par. 34.) However, in an attack from assembly position on an enemy whose location has been determined, the maximum of coordination must be attained.

b. Coordination is obtained by explicit orders, designation of time or signal for attack, and designation of a line or lines of departure. Commanders concerned or their staff officers must confer and make certain that each knows what, when, where, and how he is to operate.

c. The regimental or combat command commander is responsible for coordination of the attack as a whole. However, the battalion commander must confer with the infantry commander, the artillery commander or his liaison officer, and the commander of supporting tanks. He makes all necessary arrangements to insure that each knows what the other is to do. He arranges for special signals and for any special radio communication. *This information must be passed on to the lower units.*

■ 33. POSITIONS.—Locations or positions which must be understood by all are the assembly position, attack position, rallying point, and alternate rallying point. In addition separate tank battalions may use an intermediate position. (See fig. 49 and FM 17-10.)

a. The assembly position (area) should afford concealment and is preferably beyond the range of hostile medium artillery fire, usually about 8,000 to 9,000 yards from the line of departure. If such assembly position would cause the battalion to move through a defile to reach attack positions, then select an assembly position in front of the defiles or cause several passages to be constructed through the obstacle. (See fig. 50.) In assembly areas, post security, check vehicles and weapons. Get everything ready for the attack.

b. An intermediate position may be designated if the assembly position is a great distance from attack positions. This is in fact a forward assembly position and should have the same characteristics as the assembly position.

c. The attack position is as near the line of departure as practicable, considering concealment. There will be an attack position for each company or platoon. Halts are made only long enough to regain control, for last minute coordination with other troops, especially infantry if the attack is made through or in conjunction with infantry. Before reaching the attack position, assume a deployed or semideployed formation. Take up the formation with which the line of departure is to be passed.

d. The rallying point is a well-defined terrain feature at which the tanks assemble after reaching their objective. It is usually in rear of (on the friendly side of) the final objective. (See fig. 52.) It should afford concealment and take advantage of natural obstacles for security. Here the battalion reorganizes, resupplies as necessary, takes care of wounded, and prepares for further action. Alternate rallying points are designated in case the rallying point is untenable or cannot be attained. The attack position may be designated as an alternate rallying point. There should be a rallying point and an alternate rallying point for each objective. *Do not stop to reorganize on each objective.* If the going is good *keep going* to the final objective, then reorganize. Keep control by observation of advance and issuance of necessary coordinating orders.

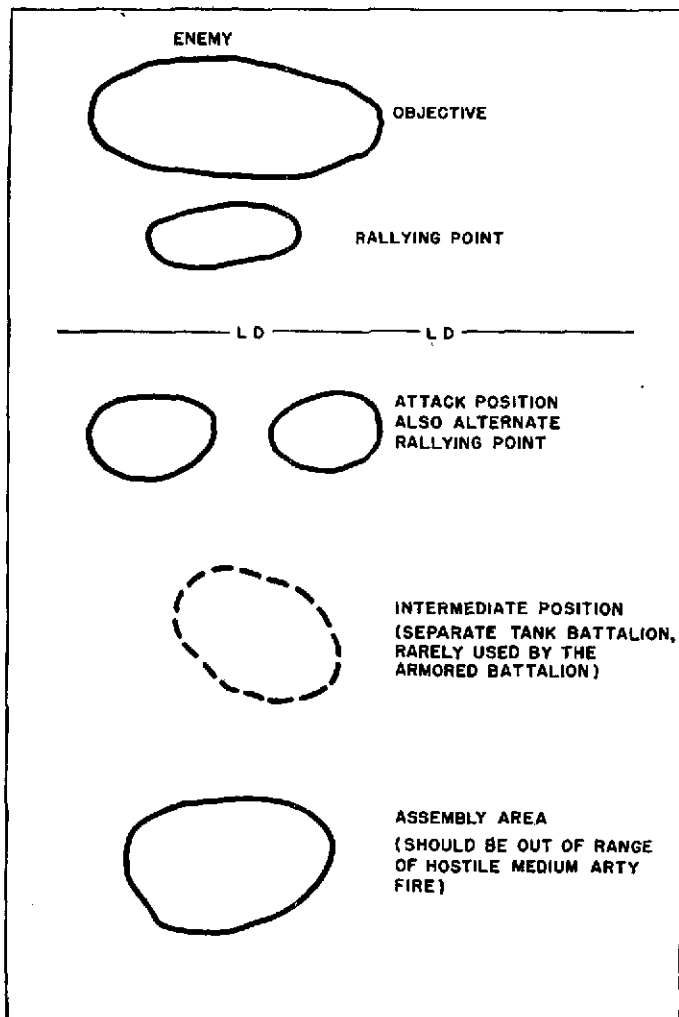

Figure 50.—Armored battalion installations.

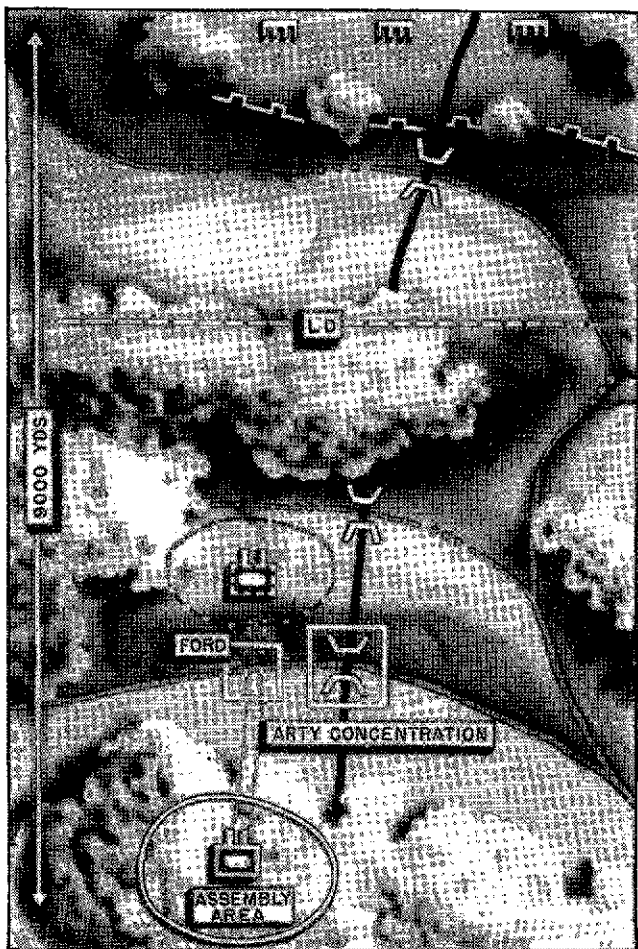

FIGURE 51.—Do not select assembly area with defiles in front that can be blocked by artillery. Move forward through defiles before discovered by the enemy. Disperse to minimize losses.

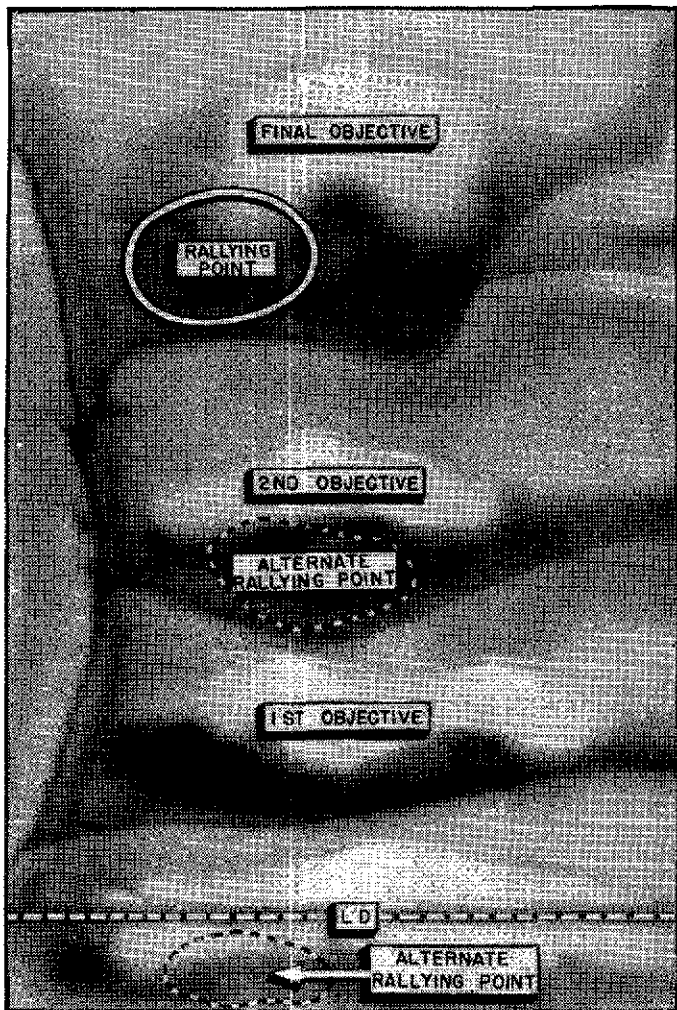

FIGURE 52.—Rallying point.

■ 34. MEETING ENGAGEMENT.—*a.* A meeting engagement may occur when the situation is obscure, such as the meeting of small hostile units when reconnaissance is not effective. Again it may occur when opponents are aware of each other's presence but attack immediately to gain some tactical advantage. (See FM 17-10.) Advance guard action is an example of a meeting engagement.

b. In order to secure tactical advantage in a meeting engagement it is essential that orders be issued and action initiated immediately. Commanders must be well forward. Little time is spent on coordination of fires. Attack is usually launched from march column. The mission of the command will determine the action taken.

c. The following shows one form of action in a meeting engagement:

(1) *Situation.*—(*a*) Combat command A, 60th Armored Division, is marching west along state highway 59 with the mission of destroying an enemy unarmed column reported advancing on TETRA from the west. (See fig. 53.)

(*b*) The 1st Battalion, 99th Armored Regiment, with one company of infantry, one platoon of engineers, a heavy tank destroyer platoon, a medium tank company, and one battery of field artillery attached forms the advance guard.

(*c*) Reports from combat command reconnaissance units indicate a Red force of infantry, artillery, and tanks is marching from the west on TETRA. This force has brushed aside our reconnaissance units.

(*d*) At 10:00 AM the point of the advance guard is as shown in figure 53. The battalion reconnaissance platoon has reached DEAD MAN CREEK and has just reported that enemy patrol of two armored cars is moving east on highway 59, leading car about 500 yards west of DEAD MAN CREEK.

(*e*) At this time the advance guard commander, who is immediately behind the advance party, receives the following message from the combat command commander:

"Battalion of enemy light tanks followed by two batteries of artillery and a regiment of infantry is moving east on highway 59, head of column 2 miles east of TETRA. Seize

PERRY ROAD RIDGE at once and cover the development of the combat command."

(2) *Actions and orders of battalion commander.*—The advance guard commander (battalion commander) immediately gives orders as follows:

"Support commander, enemy tanks, artillery and infantry moving east on highway 59, head of column 2 miles east of **TETRA**. Move your company at maximum speed and cover crossings of **DEAD MAN CREEK**.

"Artillery observer, I want artillery prepared to fire on crossing of Dead Man Creek on highway 59 and enemy concentrations in woods west of the creek.

"S-2-3 conduct reserve to assembly areas in woods west of Lone Branch. Send assault gun platoon and mortar platoon forward at once to report to me near junction of highway 59 and **PERRY ROAD**. Report to me at **PERRY ROAD** with the company commanders. I am going forward."

(3) *Situation—continued.*—(a) As the point crossed **LONE BRANCH** it met the hostile reconnaissance cars previously reported, quickly deployed, attacked, and destroyed the cars. The advance guard continued the advance and as the point approached the bridge over **DEAD MAN CREEK** it was fired upon by two tanks coming down the road to the west. It immediately moved off the road to the woods on the right. The advance party took position on hill west of **PERRY ROAD** together with the assault gun, opened fire, and destroyed the hostile tanks. The support commander moved the infantry platoon south of the road and a tank north with orders to cover crossings of **DEAD MAN CREEK**. (See fig. 54.)

(b) The advance guard commander arrived at junction of highway 59 and **PERRY ROAD**. He learned by radio report from the reconnaissance platoon that **DEAD MAN CREEK** was favorable for crossing by tanks to a distance of 1 mile north of the bridge. One reconnaissance squad reconnoitering to the south reported to the infantry platoon leader on the south of the road that suitable tank crossings were located 200 and 400 yards south of the bridge. This was reported to the battalion commander.

(c) The reconnaissance platoon leader reported enemy patrols on west bank of DEAD MAN CREEK and what was estimated as a platoon of tanks moving into woods north of the road. (See fig. 54.) Just then hostile artillery fire fell on woods northeast of the bridge knocking out one of the two tanks at (1). The S-2-3 and the company commanders arrived at this time. An air observer dropped message stating that hostile tanks, estimated as a battalion, were moving north of road and going toward woods north of highway 59. Infantry in carriers was moving into woods south of roads.

(4) *Actions and orders of battalion commander—continued.*

"Artillery observer, bring fire on enemy tanks at (2).

"Look at your maps. Tanks estimated as a battalion are moving here (pointing to map). Infantry is moving into that woods (pointing to woods).

"We hold this ridge to cover development of the combat command. DEAD MAN CREEK is fordable north of that bridge.

"Company B with assault gun and mortar attached, move here (see map). Prepare to repel enemy attack from west or north and to attack on my order.

"Company C. Position rear Company B. Protect right flank.

"Company D. Position south Company C. One platoon edge woods cover west on north. (See map.)

"Infantry company, move south of road, cover crossings of DEAD MAN CREEK there. 1st platoon Company A attached to you.

"Mortar platoon less one squad cover bridge to front.

"Assault gun platoon less one gun cover bridge to front.

"I'll be with Company B.

"Move out.

"Artillery observer be prepared to switch fires to area in front of Company B. Come with me.

"Company A keep enemy from crossing creek to your front. If artillery fire is needed, call me. You may adjust the fire."

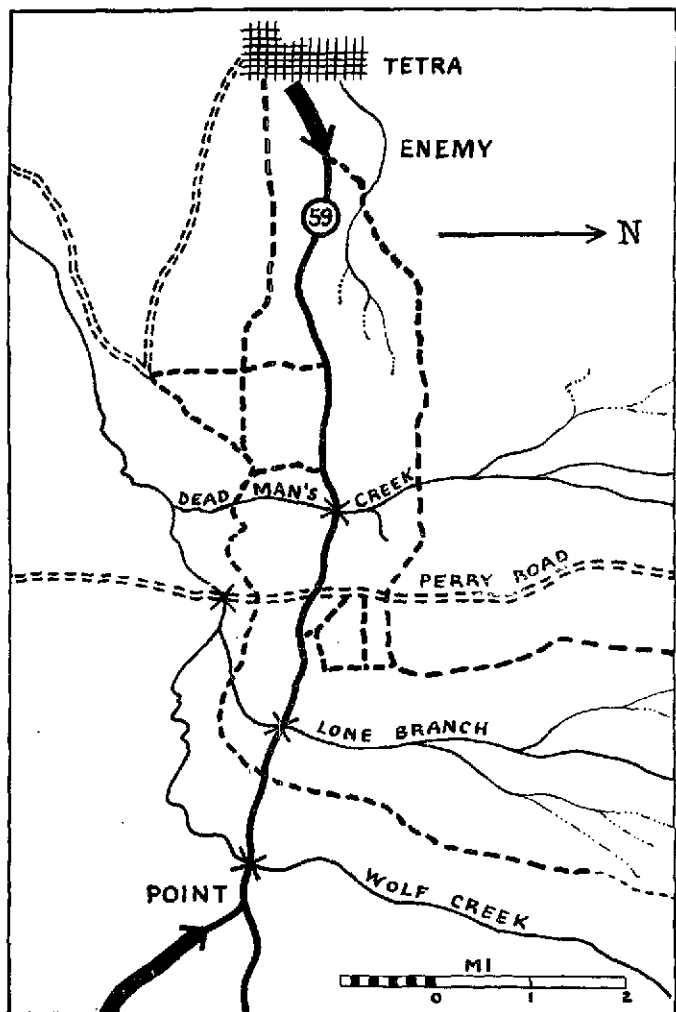

FIGURE 53.—Illustrative problem, advance guard. (Map 1.)

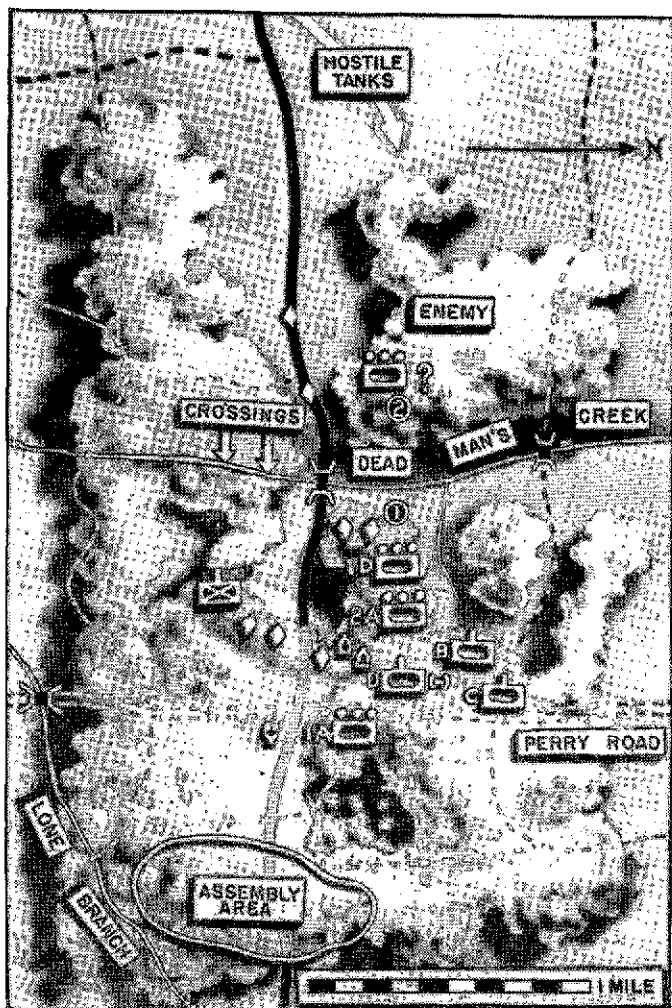

FIGURE 54.—Illustrative problem, advance guard action. (Map 2.)

■ 35. ATTACK BY PENETRATION.—*a. General.*—(1) Armored units seek to attack through weak spots in an enemy position, break through, and destroy rear installation. Attack is made through a well-organized position only when attack on other points is impracticable.

(2) A penetration is characterized by attack on a narrow front, the massing of all available fires, and the maximum coordination of all means of attack. Often infantry and engineers will attack first to clear paths through obstacles through which tank units may pass.

(3) The attack is made in three echelons. Against a position strong in antitank guns, medium tanks lead.

b. First echelon of attack.—(1) *Action prior to the attack.*—Prior to the attack and after receiving the plan of attack the battalion commander—

(a) Makes a map and personal reconnaissance of the routes to the attack position and, from an observation post, studies the ground over which he is to attack.

(b) Causes company commanders and as many as practicable of lower unit commanders to make a personal reconnaissance.

(c) Contacts infantry and reconnaissance units in the zone, obtains all information they may have concerning the terrain and the enemy, arranges for fire support and passage of lines. If infantry and engineers attack first, he arranges for liaison.

(d) Obtains information on artillery support for the initial attack and for subsequent action. Makes requests for additional fires or changes in artillery fire plan if desired.

(e) Obtains information on air bombardment support. Requests support desired. Makes arrangements for liaison with air observation.

(f) Plans his attack.

(g) Issues his attack order.

(2) *Plan of attack.*—The plan of attack includes—

(a) *Formation.*—Consider width of zone and distance to final objective. Normally the width will not exceed 1,500 yards. A formation with two companies leading will usually be satisfactory. The battalion commander prescribes the initial formation for the companies or gives each company a frontage.

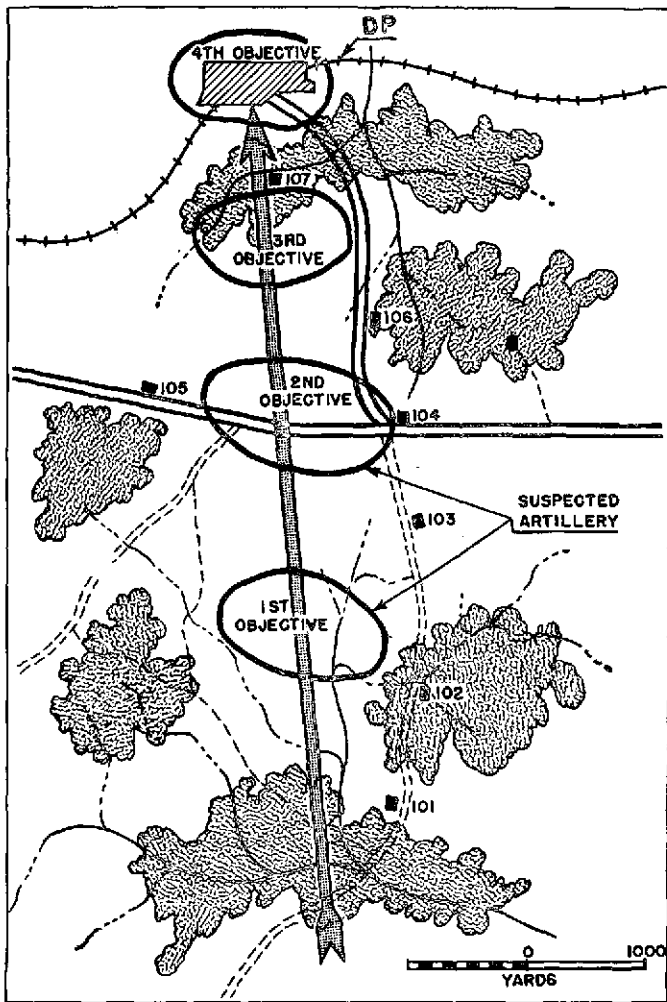

FIGURE 55.—Plan of attack showing objectives.
 NOTE.—Numbers designate artillery check points.

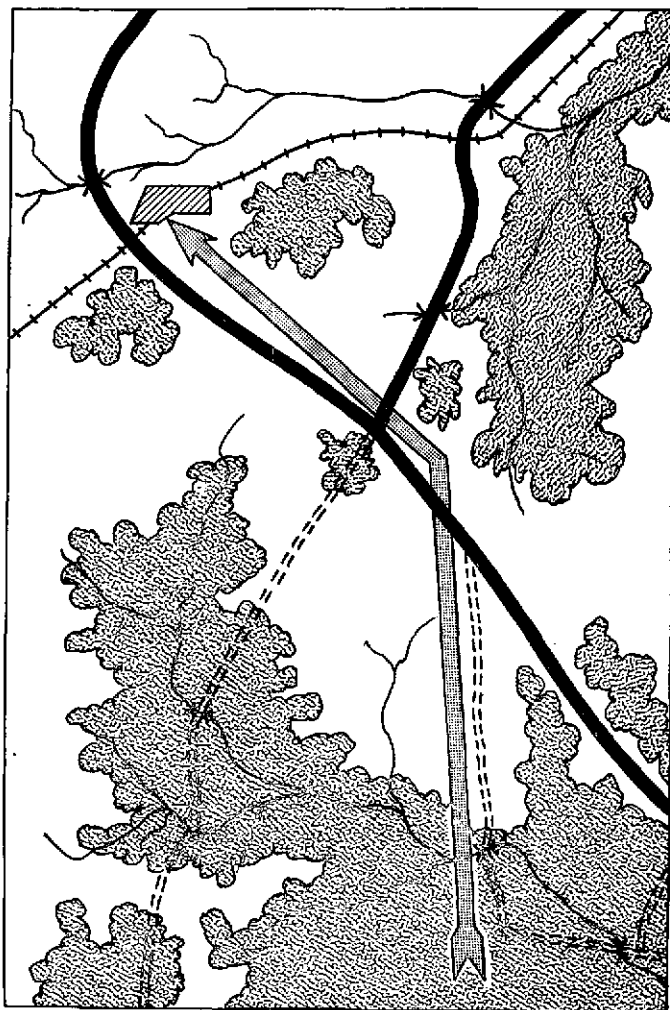

FIGURE 56.—Plan of attack. If change of direction is necessary, make it at a well-defined terrain feature.

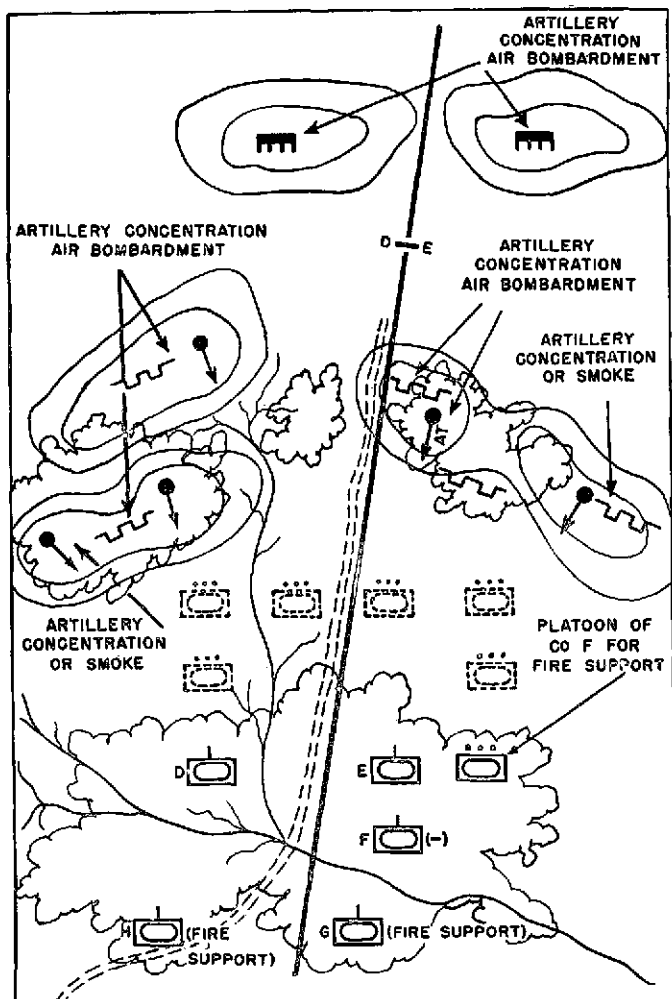

FIGURE 57.—Coordination of fires for initial attack. Broken symbols show one formation for advance.

(b) *Objective*.—Designate a series of objectives. The first objective is usually the enemy second line position or a prominent terrain feature in rear of his front installations. Objective should be easily discernible terrain features.

(c) *Direction of attack*.—The objectives determine the direction of attack. However, an azimuth of attack should be given. If a change of direction becomes necessary, make it on a prominent terrain feature.

(d) *Boundaries*.—Boundaries rarely are designated unless another battalion is attacking abreast. The boundary is then designated by the higher commander. Each company is given a frontage. A road or other suitable feature may be designated as a guide. A boundary may be given between companies. However, designation of objectives will often be sufficient. Figure 56 shows a boundary between companies.

(e) *Line of departure*.—This should be some line as far forward as available cover will permit. It may be a small stream, edge of a woods or other distinguishing line. Different lines of departure may be designated for each company.

(f) *Time of attack*.—This will normally be set by the higher commander and is on time or by signal. When infantry attacks prior to the tanks, the tank is launched by signal.

(3) *Attack through infantry*.—(a) If the attack is made through infantry, special arrangements must be made for passage of lines. The battalion commander contacts the infantry commander in his zone and arranges for this passage. Each company commander contacts the infantry troops in his part of the zone and makes arrangements whereby foot troops indicate their positions so they will not be endangered by tanks. Guides are posted as necessary.

(b) When infantry attacks first to clear a passage through obstacles, liaison is maintained by the battalion commander with the infantry commander. Infantry or engineers post guides to show tanks where to cross the obstacles.

(4) *Movement to attack positions*.—(a) Guides are posted or routes marked to attack positions. The battalion moves out, protected if necessary by a small covering detachment. The covering platoon should be from the reserve company and takes up positions to protect the attack position and

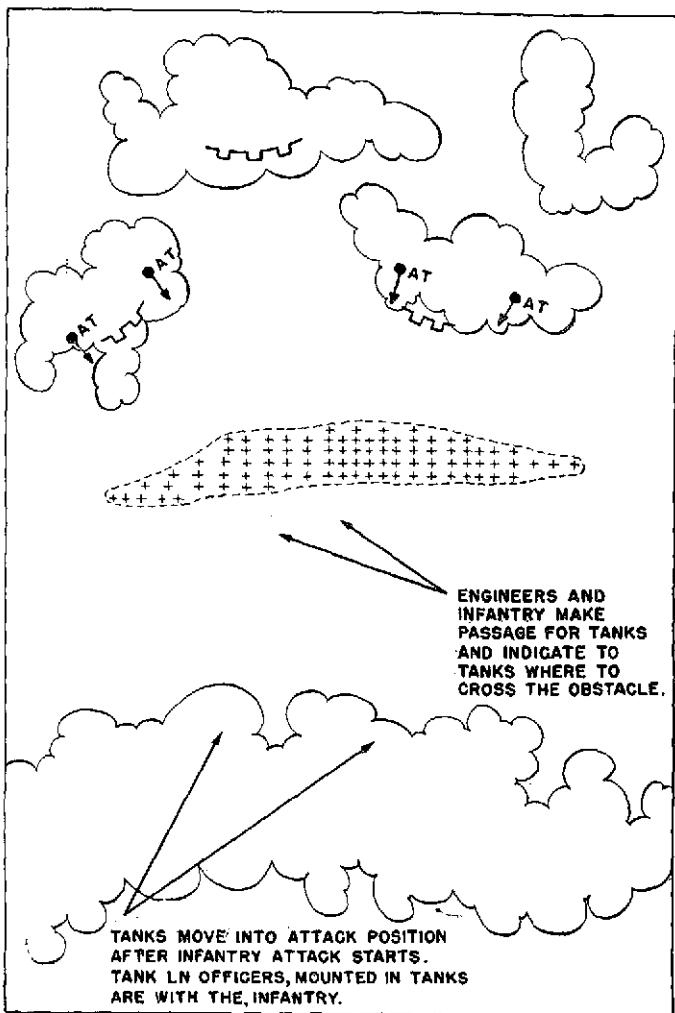

FIGURE 58.—Attack through infantry and engineers who have cleared passages through obstacles.

support the attack. The mortar platoon and assault gun platoon follow the covering force and go into position. The leading companies follow and move into attack position. The reserve and the battalion headquarters, less the command group, move last. The battalion commander with his S-3 moves behind the covering force. The artillery observer either moves with the battalion commander or goes to the attack position ahead of the battalion where he will be ready to observe and adjust fires.

(b) Movement to the attack position is made at such time that only a few minutes will be spent in that position for last minute check and orders.

(5) *Conduct of the attack.*—(a) The battalion commander observes the attack and, by personal orders or by use of his staff, directs the companies as necessary. *The battalion commander must use the radio himself.*

(b) As the attack progresses, the battalion commander or his S-3 designates targets or missions for the assault gun platoon or the mortar platoon. The battalion commander personally directs the movement of the reserve to influence the action. He calls upon the artillery observer for fires. In case the artillery observer becomes a casualty the battalion commander or his officers adjust artillery fire. (See FM 17-62.)

(c) The reserve follows the assault companies at 300 to 1,000 yards. It moves by bounds from cover to cover where it can give continuous fire support to the leading companies and protect the flanks. *Do not use the reserve company for artillery support when artillery is available.* This will deplete the ammunition supply and the reserve will not be able to influence the action later. When an objective is taken the reserve must be prepared to protect against counterattack.

(d) For action of rallying point see paragraph 33.

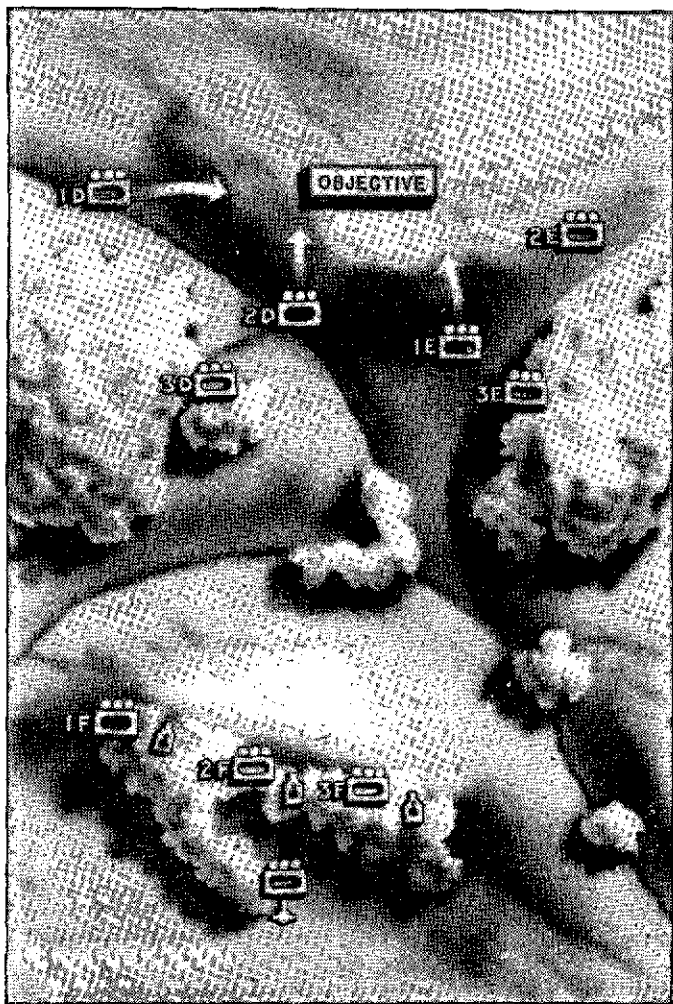

FIGURE 59.—Use reserve as necessary for fire support. Mortars and assault guns displace so as to maintain continuous fire support.

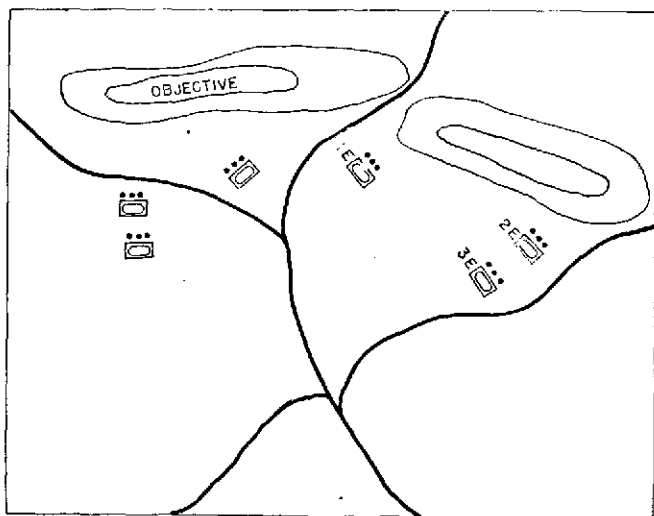

FIGURE 60.—Keep companies in right direction. Here Company E is advancing in wrong direction.

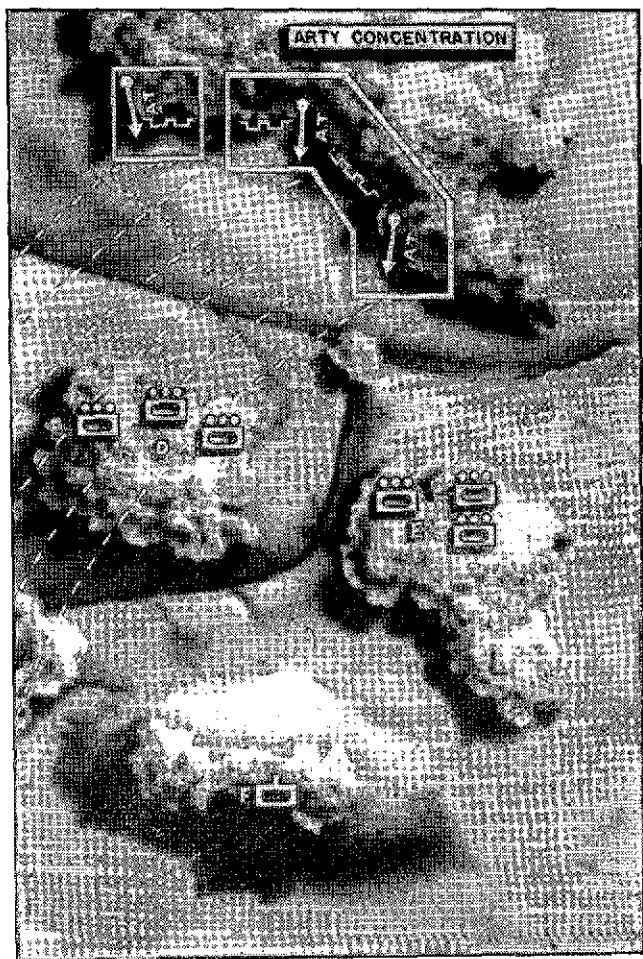

FIGURE 61.—Use artillery to support attack where practicable. Here Companies D and E are held up by antitank fire. Artillery is available and can bring down much more effective fire than can Company F.

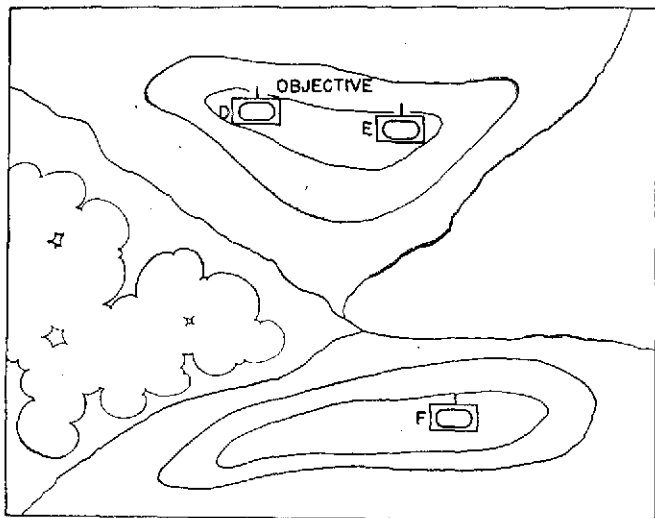

FIGURE 62.—Reserve is placed to cover flanks of leading companies on objective.



FIGURE 63.—Use reserve company for envelopment. Attach assault gun. Coordinate assault gun fire, mortar fire, artillery fire, and attack of all three companies. Attack may be launched upon signal by Company F when it is in position.

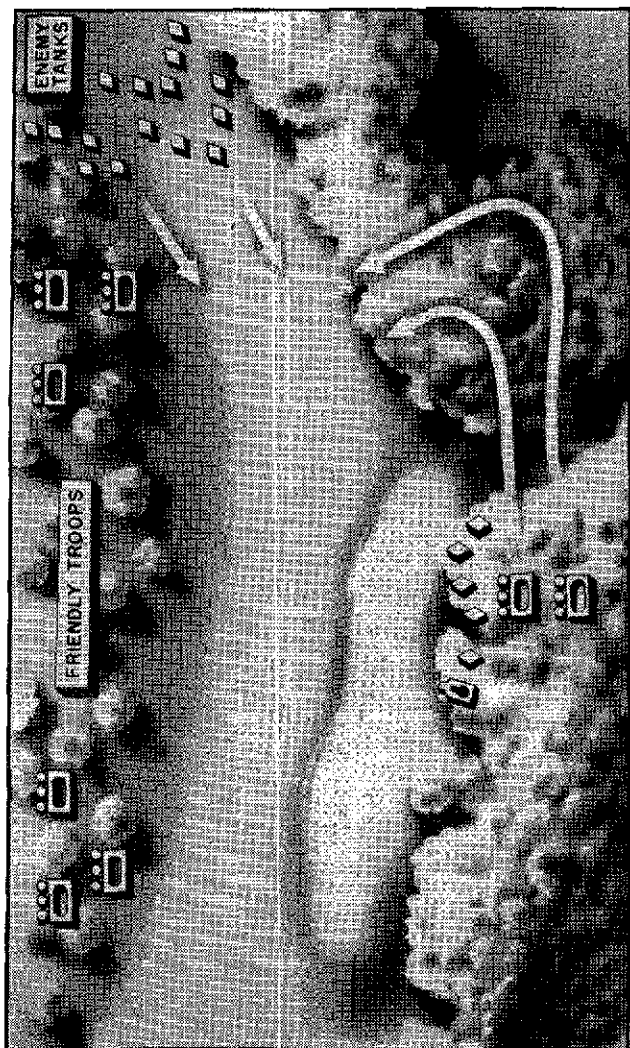

FIGURE 64.—Use reserve company to repel mechanized counterattack. Part of company brings fire on hostile tanks, and remainder maneuver strike enemy tanks at close range.

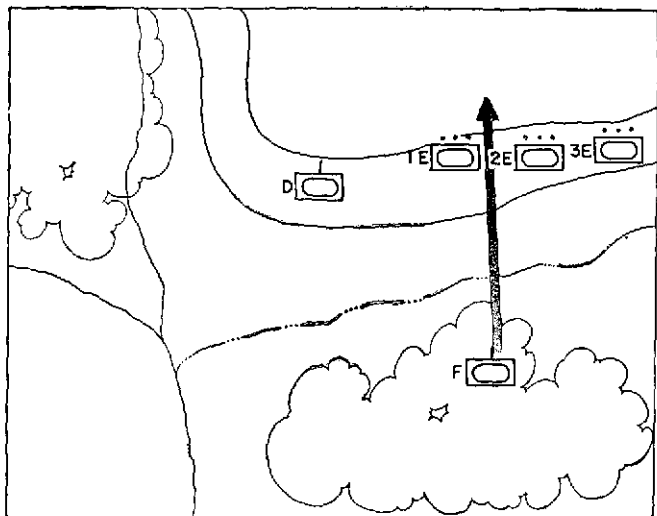

FIGURE 65.—Use reserve to make passage of lines and to assume mission of a depleted company.

c. Second echelon of attack.—(1) *Position.*—The second echelon may be either light or medium tanks. It follows the leading echelon at a variable distance from 500 to 3,000 yards, depending upon the terrain and the enemy situation. It should be close enough so that the enemy will not have time to reorganize his antitank defense after the first echelon passes but should not be so close as to become intermingled with elements of the first echelon.

(2) *Function.*—The second echelon of attack must be prepared to—

(a) Support the leading echelon by fire.

(b) Protect the flanks of the leading echelon.

(c) Pass through and assume the mission of the first echelon should that battalion become so depleted as to be unable to continue on its mission.

(d) Make an envelopment to either flank.

(3) *Formation.*—The second echelon must assume a formation that permits fire support of the leading echelon by

some of its elements; covers the zone of attack to beat down hostile automatic weapons; and facilitates movement to either flank or passage through the first echelon. Wedge formation will be proper in most cases.

(4) *Action prior to the attack.*—Prior to the attack and after receiving the orders or plan of the regimental or combat command commander, the battalion commander—

(a) Makes personal reconnaissance and causes lower unit commanders to reconnoiter routes to the attack position and to the line of departure of the first echelon.

(b) Studies map of zone of attack.

(c) Contacts battalion commander of first echelon, learns his plan of attack, marks objectives on map, locates artillery check points, arranges to support first echelon by fire.

(d) Contacts infantry or reconnaissance units in the front, obtains all possible information of the enemy, arranges for be made through mine fields or other obstacles, and arranges for indicating to tanks the location of these paths.

ments for indicating to tanks the location of these paths.

(e) Obtains information on artillery support.

(f) Plans his attack.

(5) *Plan.*—The plan includes the steps outlined in b(2) above.

(6) *Conduct of the attack.*—(a) The battalion moves into position immediately after the first echelon of attack. The battalion commander must be well forward, usually just behind the company supporting the first echelon. He moves the battalion forward when the first echelon has passed the first obstacles or when his support company can no longer support the leading echelon by fire.

(b) The battalion commander moves his battalion rapidly forward and overruns and destroys hostile infantry and weapons. He must be ready at all times to repel a counter-attack from either flank. He overcomes small isolated enemy resistance by use of tanks, mortars, and artillery fire. During the advance, the artillery may displace forward with or behind his battalion. This artillery is not attached to his battalion but he gives such aid and security as is consistent with accomplishment of his mission.

(c) In case of enemy counter-attack the battalion commander immediately takes appropriate countermeasures.

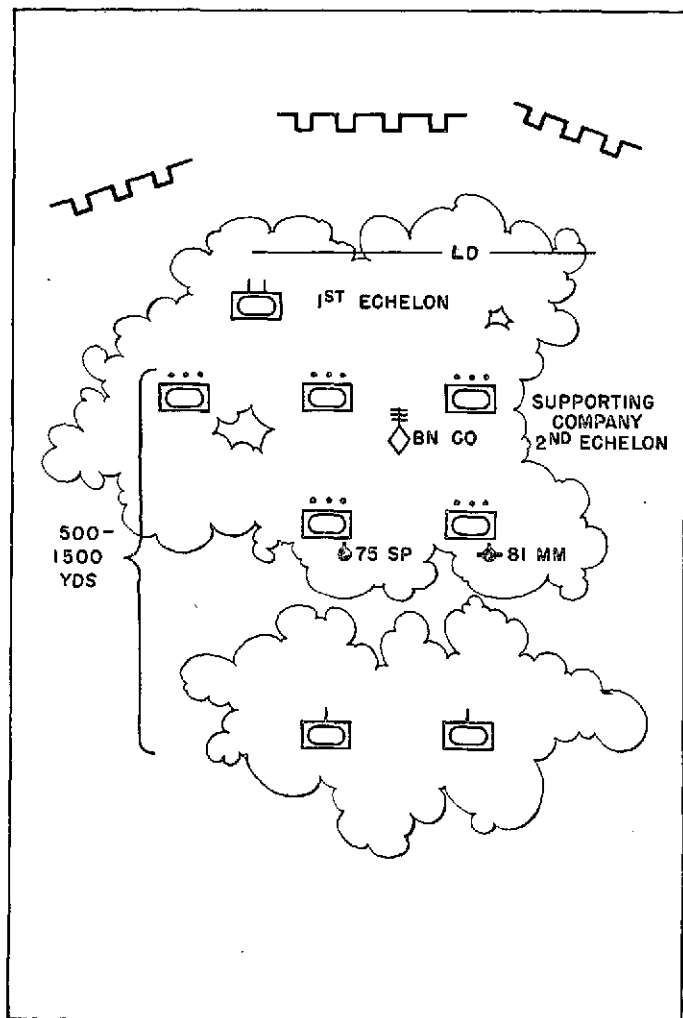

FIGURE 66.—Second echelon of attack. Attack positions.

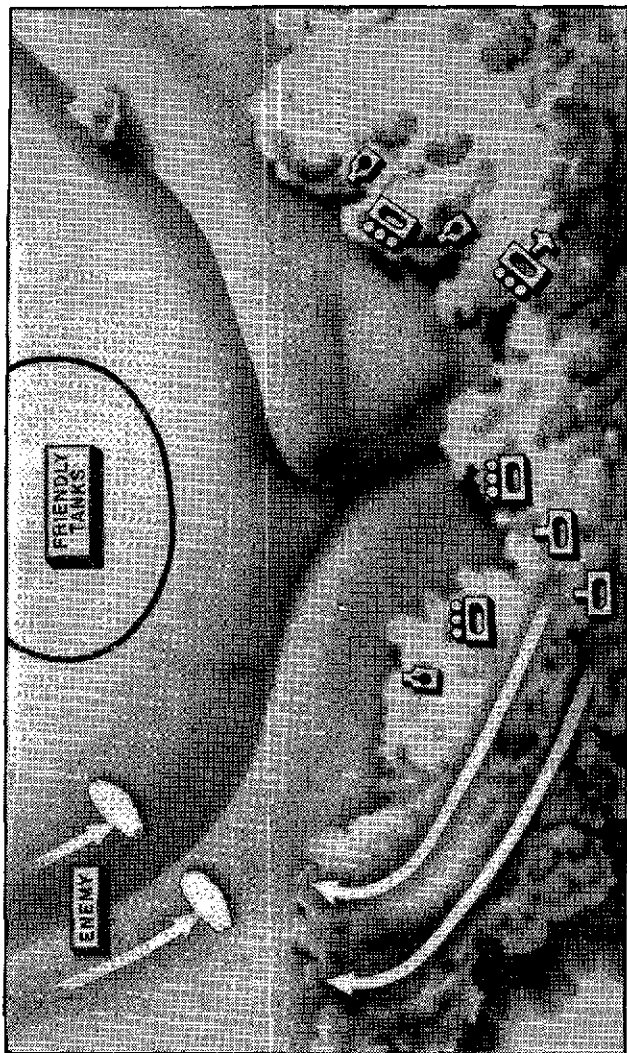

FIGURE 67.—Repelling counterattack. Battalion commander uses one company to fire on enemy from concealed or deflated positions, maneuvers the other two companies to strike enemy in flank, calls for artillery fire on the hostile troops, and uses smoke to disorganize the enemy.

d. Third echelon of attack.—(1) If armored infantry makes the initial attack, the tank battalion will advance behind the second echelon of attack, joining the infantry in front of the line of departure. If the armored infantry does not make the initial attack, it advances, in carriers, close behind the second echelon of attack. The tank battalion follows the infantry closely. (See (3) below.)

(2) Prior to the attack the battalion commander—

(a) Makes a map and personal reconnaissance and requires subordinate leader to make such reconnaissance as is practicable.

(b) Contacts the infantry commander and makes arrangements for coordination, and liaison.

(c) Plans his action.

(3) The advance to attack may be made with infantry leading, with tanks leading, or by tanks and infantry together.

(a) When resistance is light, infantry in carriers will usually lead the attack. The leading tanks follow the infantry at 200 to 500 yards. When infantry is forced off carriers by hostile fire, tanks immediately attack and assist the infantry to advance.

(b) When the second echelon has not reduced all hostile automatic weapons the tanks of the third echelon lead the attack. Infantry follows closely in carriers if practicable.

(c) When attacking, dismounted infantry advances with or closely behind the tanks.

(4) The tanks of the third echelon must be prepared to—

(a) Overcome local resistance holding up the infantry.

(b) Repel a counterattack.

(c) Move rapidly to either flank as an enveloping force to assist the first or second echelon.

(d) Pursue.

■ 36. ENVELOPMENT.—The battalion may be used as an enveloping force and may itself use enveloping action in attack.

a. Battalion as an enveloping force.—As an enveloping force the battalion will usually be reinforced. It moves rapidly around the enemy flanks and attacks from flank or rear. The attack is timed with a frontal attack by infantry or other tanks and with artillery fire. The objective and time of attack is set by the higher commander. Time of attack

may be upon signal that the enveloping battalion is in position. When practicable the battalion commander will be permitted to choose his own direction of attack, the flank only being indicated.

(1) In an envelopment, place mortars, assault guns, and a medium tank company to support the attack by fire. Use the remainder of the battalion as a maneuvering force.

(2) In advancing to attack positions, use a covering force consisting of the reconnaissance platoon, one or more platoons of tanks, and infantry.

(3) Use the reconnaissance platoon to reconnoiter the exposed flank and protect this exposed flank by a tank platoon. The infantry company follows the attack at about 500 yards, in carriers as far as possible, and mops up the enemy position.

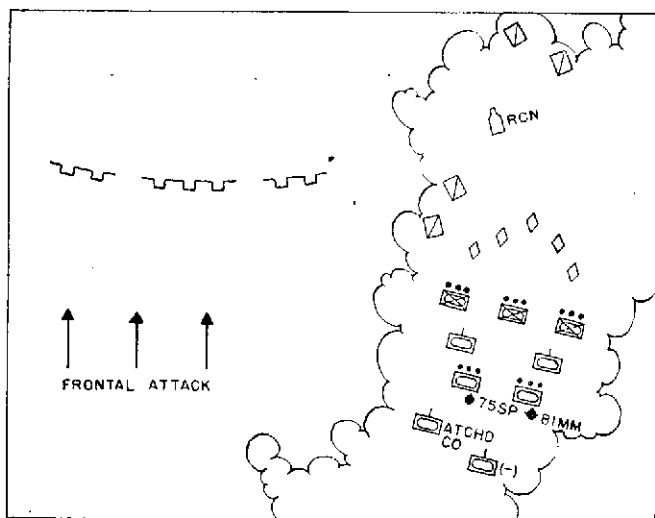

FIGURE 68.—Movement to attack positions in envelopment.

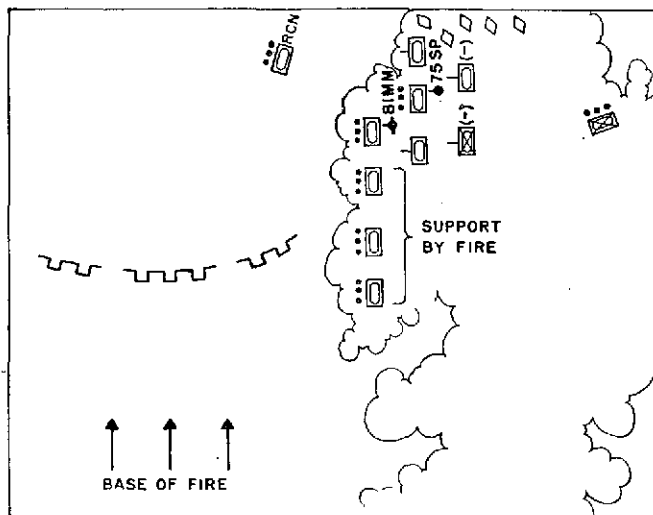

FIGURE 69.—Plan of attack, envelopment.

b. Battalion acting alone.—When acting alone the battalion may use a single or double envelopment maneuver. Infantry, if present, with a medium tank company and the assault gun and mortar platoons, less detachments, forms the base of fire. The remainder of the battalion envelops one or both flanks. Use reconnaissance platoon for reconnaissance on both flanks. Coordinate artillery fire with the attack.

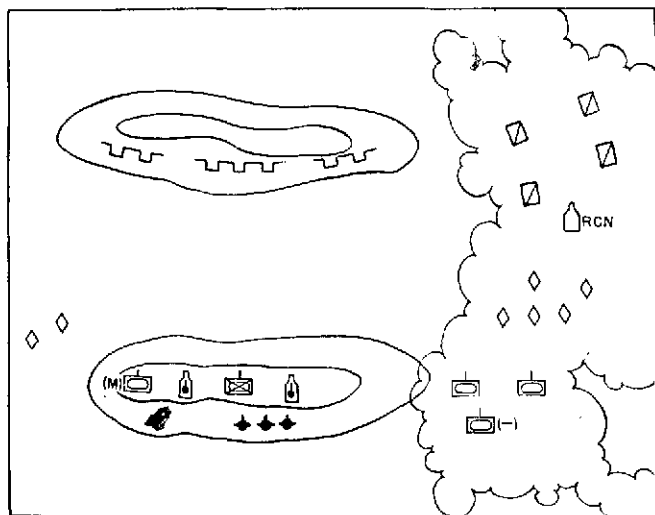

FIGURE 70.—Single envelopment reinforced tank battalion acting alone.

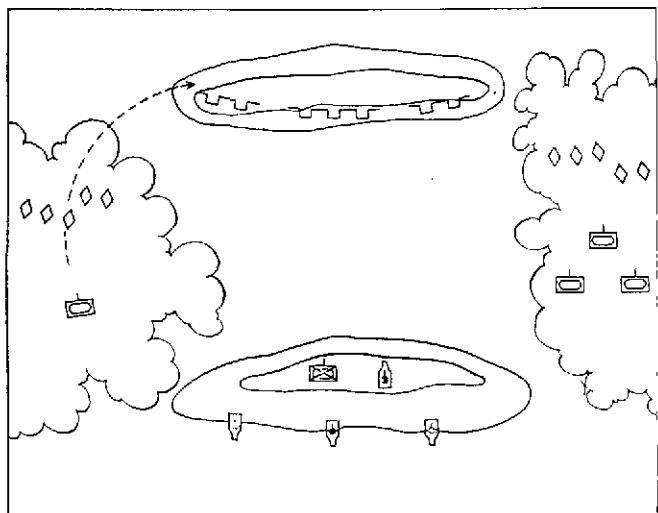

FIGURE 71.—Double envelopment, reinforced battalion.

■ 37. TANK VERSUS TANK ACTION (see FM 17-10).—Attacking tanks frequently encounter hostile tank units unexpectedly. At other times they may be required to attack hostile tanks deliberately in order to break up an attack or a counterattack. It is therefore necessary that all personnel be carefully trained in recognition of hostile and friendly tanks; characteristics and capabilities of hostile tanks as to armor, armament, and speed; vulnerable parts of hostile tanks upon which fire will be effective; range at which each of our weapons is effective against hostile vehicles; enemy methods of tank employment; and methods of combating hostile tanks, such as the use of speed, defilade and cover, and ambush. In tank versus tank action—

a. Use artillery concentrations on hostile tanks. Concentrations will be especially effective in defiles.

b. Place some tanks (preferably medium tanks) together with assault guns in defiladed or concealed positions to fire upon and slow down the hostile attack when enemy tanks come within effective range.

c. Use mortars to place smoke on the enemy to disorganize his attack. Smoke may also be used to screen maneuver of your own tanks.

d. Maneuver part of the battalion to one or both hostile flanks where they can attack by fire at close range, preferably from defiladed or concealed position.

e. If defiladed or concealed positions are not available use smoke both of mortars and artillery to disorganize the enemy and screen the advance to effective range.

f. When attacking an enemy inferior in armament, advance rapidly to positions beyond the effective range of his weapons, take up stationary position, and fire. If enemy advances, withdraw and keep beyond range of his guns while still keeping him within effective range of your own guns.

g. When attacked by an enemy whose armament is superior to your own, withdraw and lead him into your own anti-tank defenses. If there are no antitank defenses backing you up, place smoke on enemy and maneuver rapidly to approach within effective range.

h. Use terrain to aid in maneuver, defilade, and concealment.

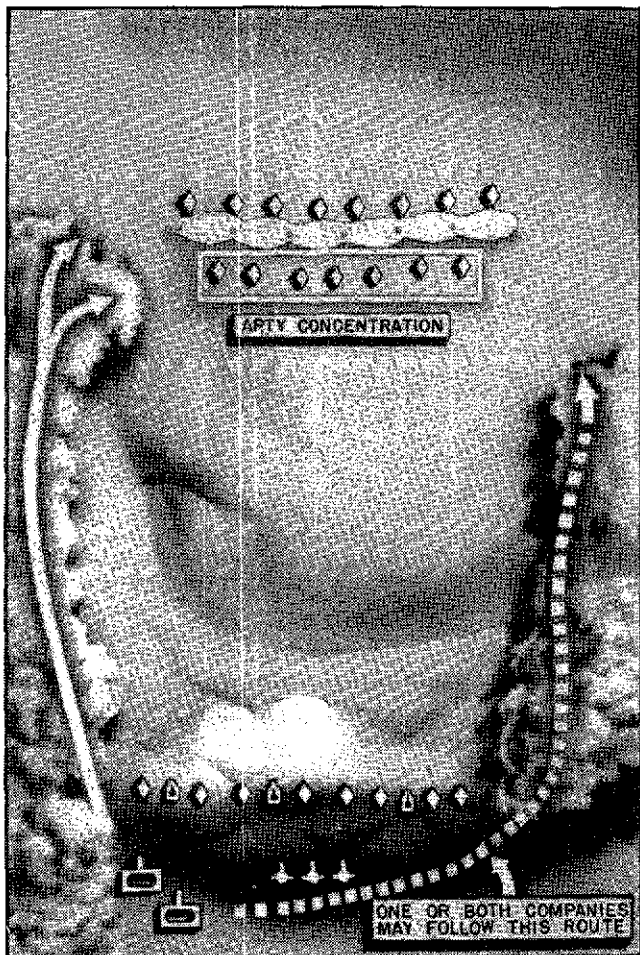

FIGURE 72.—Tank versus tank action. Place some tanks in defilade to fire on and slow down the enemy while other tanks maneuver against one or both flanks. Use artillery and mortars to smoke hostile tanks.

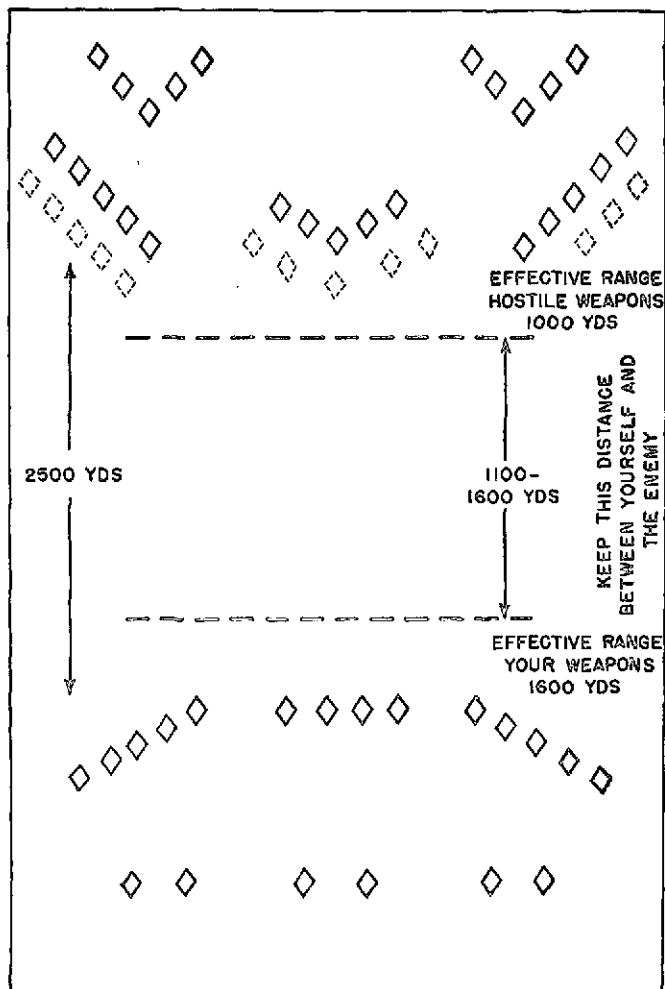

FIGURE 73.—If enemy armament is inferior, advance to effective range of your own weapons and fire. Stay out of effective range of enemy weapons.

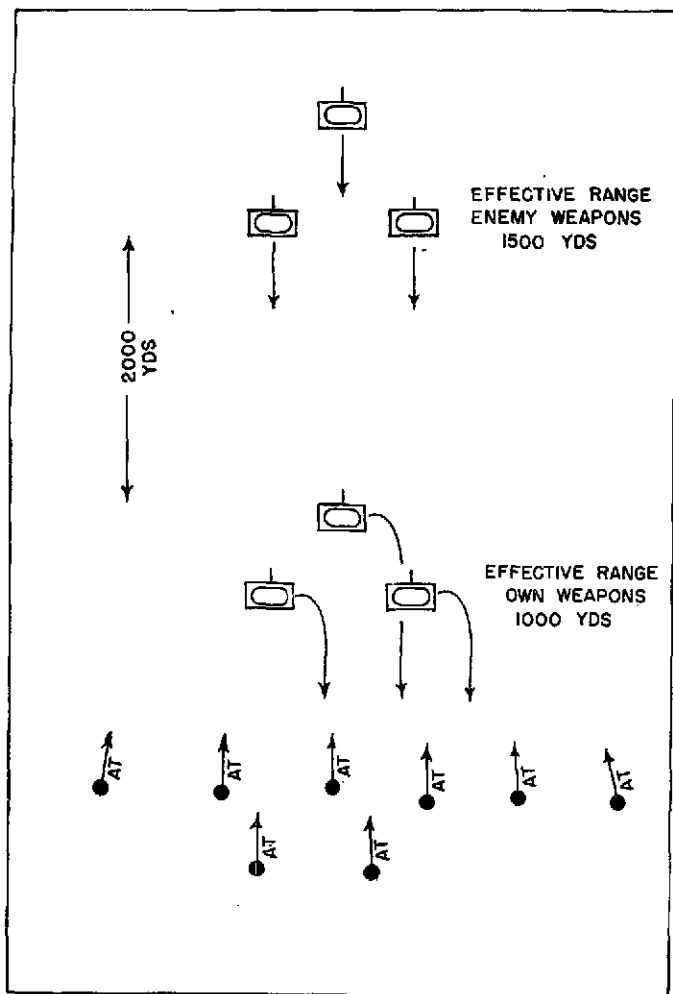

FIGURE 74.—In open country offering no concealment, if your weapons are inferior to those of the enemy, withdraw and lead enemy into fire of friendly supporting antitank guns.

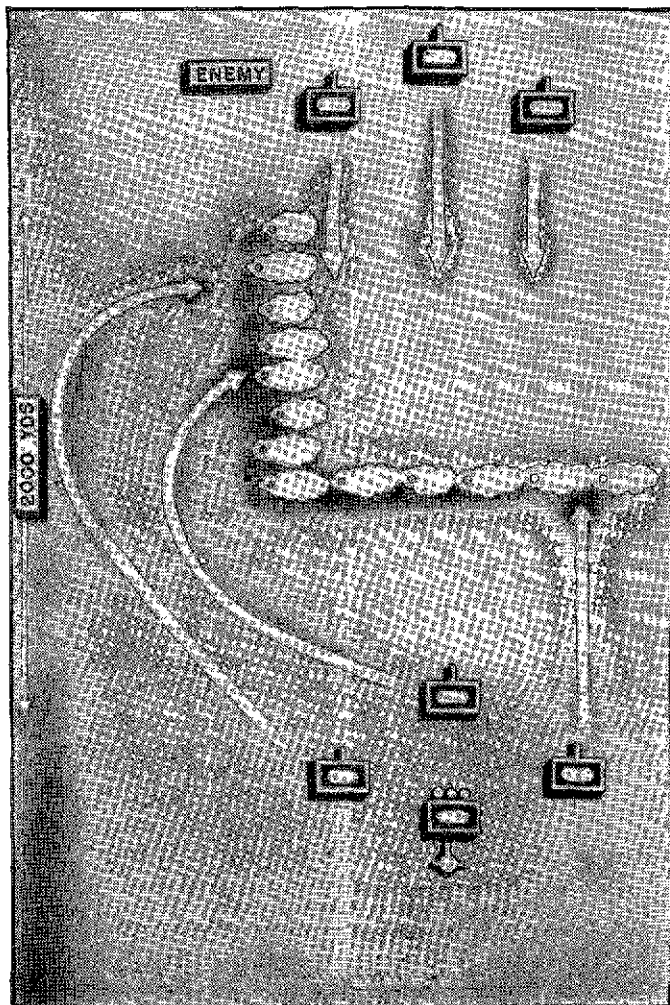

FIGURE 75.—If not possible to withdraw to antitank supporting weapons, use smoke screen to cover movement to effective range.

■ 38. **BATTALION IN RESERVE.**—*a.* A battalion in division reserve must be prepared to move rapidly to a flank to extend an envelopment, relieve a depleted assault battalion, repel a mechanized attack, or pursue a defeated enemy. The reserve is located in a position where it can best support the main attack and cover the flanks.

b. The battalion commander of the reserve battalion—

(1) Keeps himself constantly informed of the situation and of the division commander's plans either by personal contact with the division commander and his staff or by a liaison officer.

(2) Maintains a liaison officer at the division command post.

(3) Constantly studies the map and plans movements.

(4) Initiates route reconnaissance for movement of the battalion.

(5) Keeps his battalion informed of the situation.

■ 39. **PURSUIT.**—When it is recognized that the enemy is withdrawing, pursuit must be launched immediately and pushed to the limit of endurance of the command even into the night. Only lack of fuel or ammunition will be allowed to halt the action even temporarily. The enemy must be given no rest and must not be given time to regroup his forces and reorganize his defense.

a. Armored battalion.—The armored battalion will usually be part of the combat command in pursuit. It will usually be reinforced with engineers, infantry, and artillery.

b. Light tank battalion.—Light tank battalions together with infantry and engineers will be given missions of advancing rapidly behind the enemy, moving parallel to the enemy withdrawing columns, and seizing critical terrain that will block hostile retreat. Medium battalions then attack and destroy the enemy.

c. Formations.—(1) When advancing along roads parallel to the enemy, march formations are taken with reconnaissance units to the front and flanks. When the enemy is met, deployment must be rapid in order to destroy the enemy force at the earliest practicable moment.

(2) When advancing through scattered groups of enemy, a partially deployed formation is taken. Part of the advance

may be made across country in order to pass and cut off the retreating enemy.

d. Observation aviation.—Maximum use must be made of observation aviation. Air observers should report direct to the battalion headquarters by radio or drop message, giving the enemy situation and especially locations of large bodies of troops.

SECTION VII

DEFENSIVE ACTION

■ 40. GENERAL.—*a.* In defense the armored battalion is held in reserve to be used on counterattack missions to the front, flanks, or rear. As the tank is primarily an offensive weapon it should not be placed in position and used as a pill box, except when the enemy is to be ambushed. This last mission is more suited to the tank destroyer units and tanks should not be used for that purpose when tank destroyers are present.

b. The battalion acting alone will rarely take up the defensive unless forced to do so by lack of fuel.

■ 41. DEFENSE OF A POSITION.—*a.* In defense of a position, infantry occupies the main line of resistance while tank units are held in reserve. (See FM 17-10, 17-100, and 100-5.) The battalion may be part of a combat command as general reserve or may be in local reserve for a particular section of the line. Medium tanks are normally used in local reserve while some medium tanks and light tanks are placed in general reserve.

b. As a local reserve the tank battalion may be called upon to counterattack the enemy either in the front or to the flanks before he has reached the main defenses, or counterattack an enemy who has succeeded in penetrating the position and destroy or eject him.

c. The reserve position should—

(1) Afford proper concealment for all vehicles and personnel.

(2) Be large enough to allow for dispersion of vehicles, that is, at least 50 yards between vehicles.

(3) Have good routes leading into and out of the position so that movement may quickly be made to previously selected attack positions.

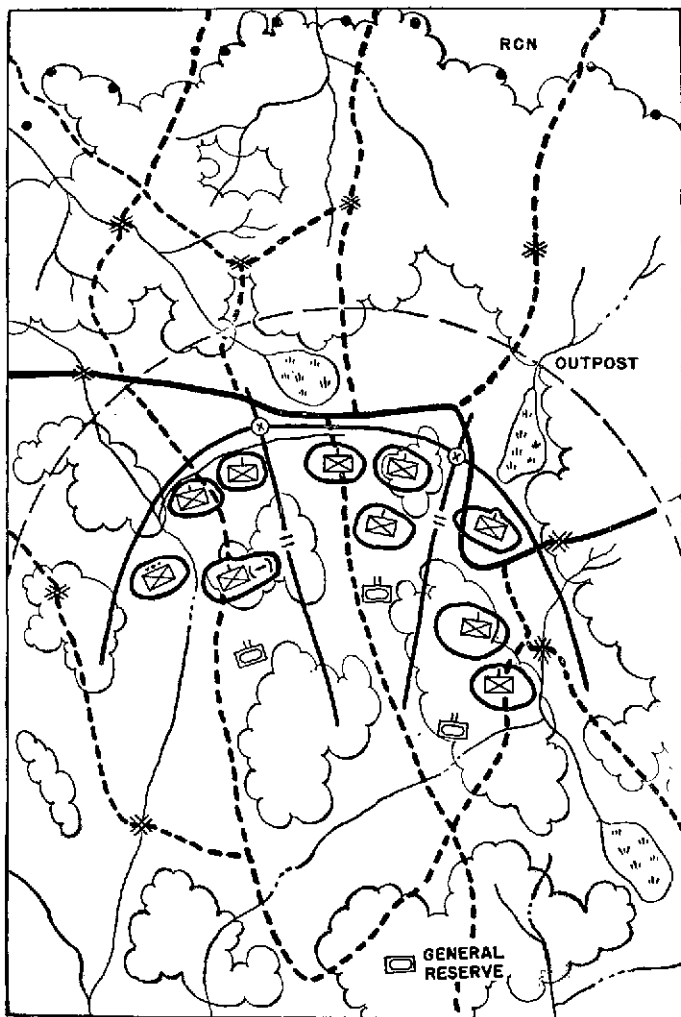

FIGURE 76.—One type of defense for armored division, showing armored battalions as local reserves.

(4) Be out of effective artillery range, that is, 4,000 to 7,000 yards behind the front line.

d. The battalion commander must make plans for all possible uses of the reserve including use in sectors other than the particular sector in which his battalion is operating. During organization of the defense, the battalion commander moves or causes his battalion to move into a reserve position as indicated by the higher commander, provides for local security as in an assembly area, then proceeds as follows:

(1) Contacts the infantry commander in the sector, and

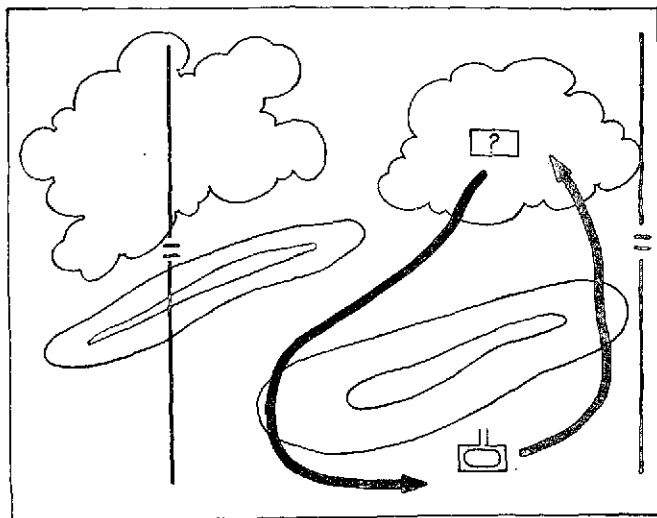

FIGURE 77.—Counterattack. If possible strike the enemy before he reaches our own lines. If front is covered with mines, passages must be opened for this purpose or gaps left.

learns this officer's plans and tactical dispositions. He reconnoiters the area and with the infantry commander plans counterattacks and coordination for counterattacks to include—

(a) Tank attack positions.

(b) Infantry, artillery, antitank gun, and air support of the tank attack. (All possible weapons should support.)

(c) Direction for each contemplated attack.

(d) Objectives.

(e) Arrangements for marking paths in mine fields so tanks may attack the enemy in his attack positions or pursue him.

(f) Arrangements for liaison. The tank battalion should keep one liaison officer at the infantry battalion command post. This officer must be equipped with radio. The S-3 for

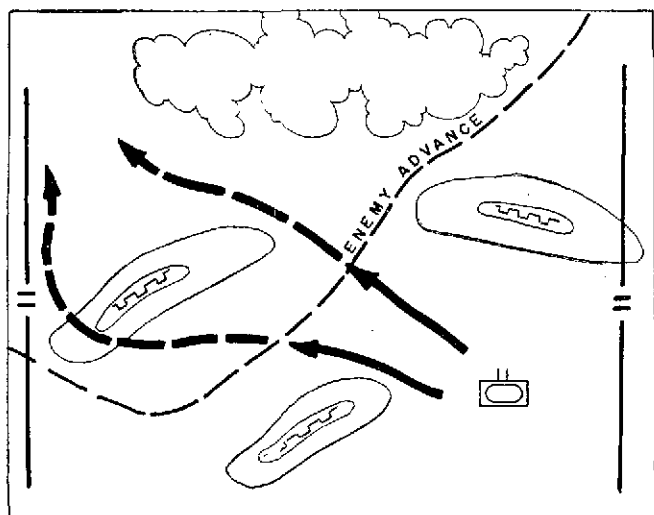

FIGURE 78.—Counterattack. If enemy succeeds in penetrating the position, counterattack and eject him. Do not be satisfied with merely ejecting him, also destroy the reserves following.

air in the battalion commander's half-track vehicle may be used for this duty.

(2) The battalion commander then outlines his plans to his company commanders and directs them to make and have their lower unit leaders make careful route reconnaissance to the various attack positions. He should also require subordinate commanders to make careful employment reconnaissance, on foot, over the area of contemplated attack. Recon-

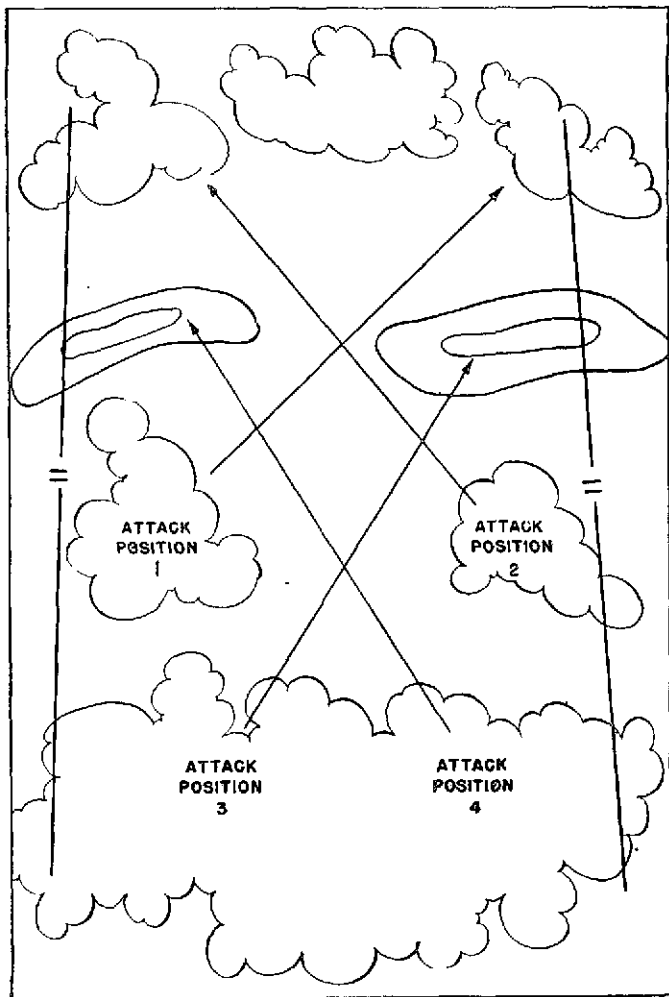

FIGURE 79.—Plans of action. Each plan is numbered. All plans must provide artillery and infantry support.

naissance should be made beyond the main line of resistance to the outpost line of resistance when time is available.

(3) Next, the battalion commander visits adjacent tank battalions and makes plans for mutual support. He obtains reconnaissance data from these commanders and makes any personal reconnaissance that can be made in the time available.

(4) Orders for various plans of attack are then given. They should be in overlay form or marked on maps. Each

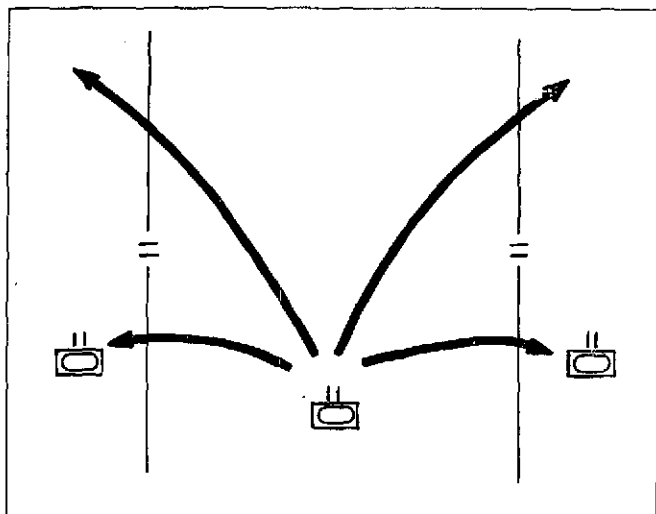

FIGURE 80.—Plan of action. Make plans for assistance of adjacent battalions.

plan is given a number and when time comes for action the battalion commander merely calls for execution of a particular numbered plan.

■ 42. WITHDRAWAL.—*a.* As part of a general covering force, tanks will be very useful in daylight withdrawal but are of little value at night except in bright moonlight. As part of the covering force the tank battalion, by rapid thrusts on a broad front, attacks and disorganizes the enemy and thus

gives other troops the opportunity to disengage and retire. These are limited objective attacks. These attacks are supported by available artillery. Having reached its objective the battalion withdraws, taking with it, by towing if necessary, all disabled tanks. The rallying point is usually the attack position.

b. When acting alone the tank battalion uses smoke to screen the withdrawal. A company supported by mortars and assault guns may be used to attack as in *a* above, to cover the withdrawal of the remainder of the battalion. A rear guard is then formed.

c. Prior to withdrawal of the combat elements, trains, except those that are absolutely essential, such as the maintenance and medical vehicles, are sent to the rear.

■ 43. DELAYING ACTION.—*a.* As part of a larger force in delaying action the tank battalion is used as a reserve to protect the flanks and make limited objective attacks (par. 42).

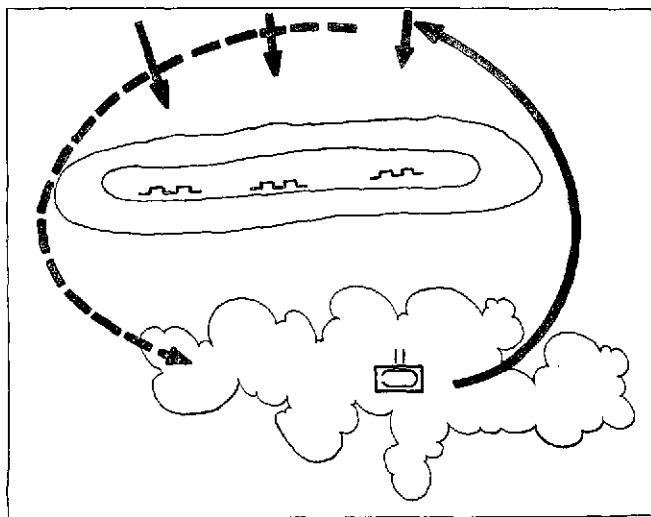

FIGURE 81.—Armored battalion as part of a delaying force. Battalion is used in reserve and attacks flank of enemy.

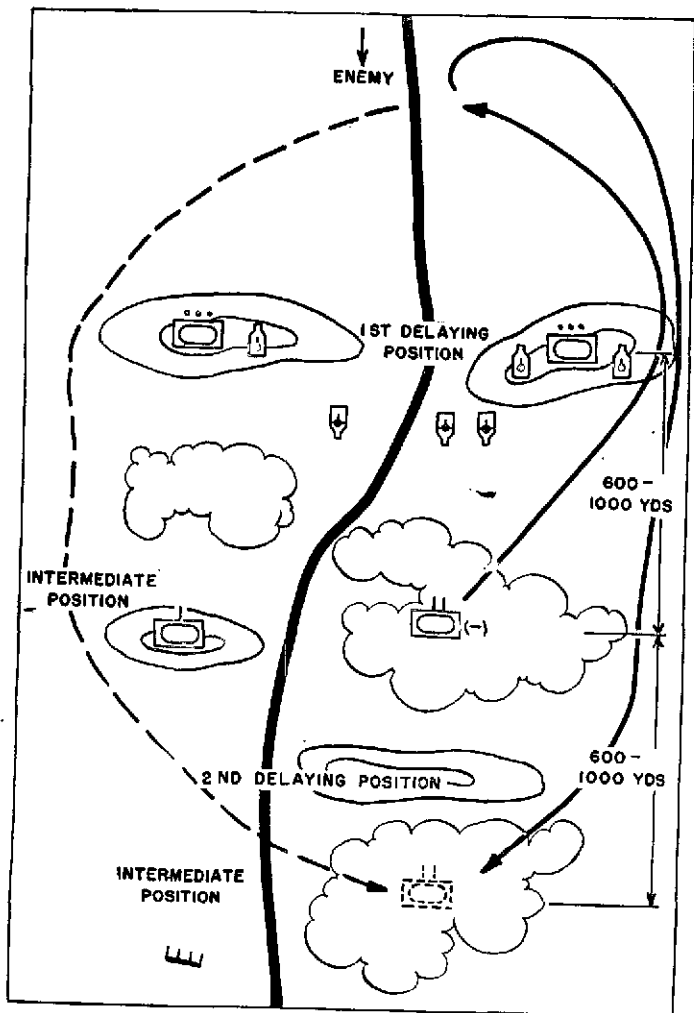

FIGURE 82.—Reinforced battalion in delaying action, acting alone.

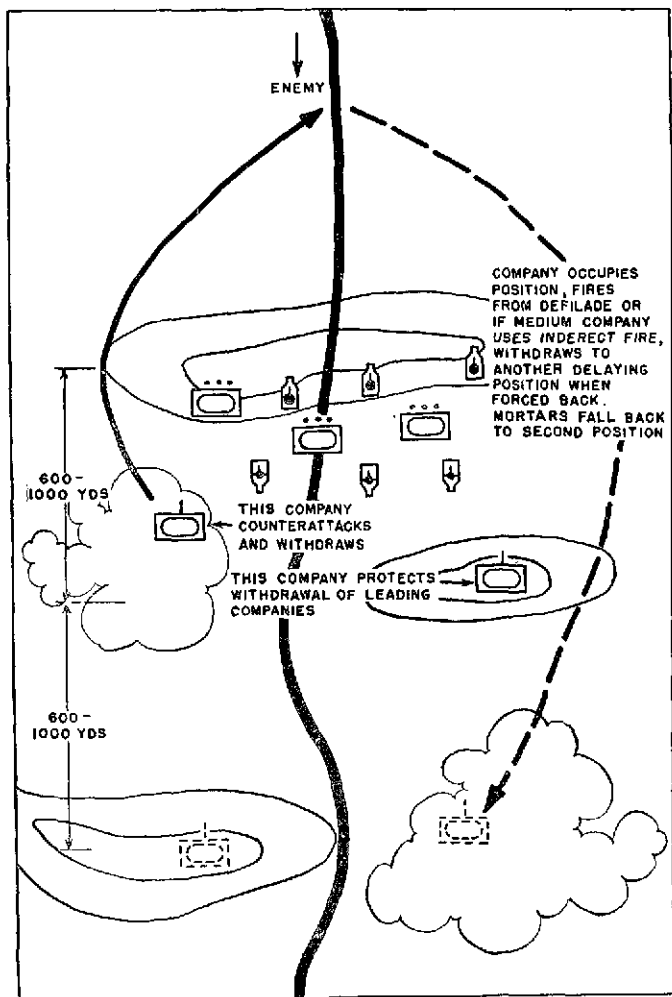

FIGURE 83.—Armored battalion acting alone in delaying action. No reinforcements.

b. When acting alone in delaying action the armored battalion will usually be reinforced with infantry, artillery, and engineers. Artillery by long-range fire delays and forces deployment of the enemy. Engineers destroy bridges and blow up fords. The infantry occupies positions from which it can force enemy deployment while tanks make limited objective attacks on the flanks and front of the enemy. The infantry then withdraws under protection of the tanks to the next delaying position.

c. If the tank battalion is not reinforced, companies or platoons with assault guns and mortars occupy defiladed or concealed positions to bring fire on and force the enemy to deploy while other tanks make flank attacks. These tanks then withdraw to the next delaying position.

d. Delay may be in one position or successive positions. If delay is in one position, select as strong a position as practicable, that is, high ground with a stream in front and flanks protected by impassable ground. If delay is in successive positions, select these positions so that enemy artillery will have to displace. Select intermediate positions to cover withdrawal and withdraw by echelon.

SECTION VIII

SPECIAL OPERATIONS

■ 44. GENERAL.—Although fundamentals are the same for special operations as for other tank actions, certain operations present special problems that require some change in technique. The paragraphs below are written as a guide for solving certain type operations. Some conditions, such as operations in desert or in snow and ice, require special training and seasoning of troops.

■ 45. ATTACK OF A RIVER LINE.—In the attack of a river line the armored battalion is normally part of a larger force. However, the battalion when acting alone may seize bridges over unfordable streams, may force the crossing of streams at fords, or may with the assistance of engineers, cross small unfordable streams. The latter will be exceptional and the

battalion must be reinforced with reconnaissance, infantry, engineer, and artillery elements for such operations.

a. *As part of a larger force* (see FM 17-10).—The infantry supported by artillery and fire of medium tanks forces the crossing, the engineers build the bridge, and the tanks then cross. Some tanks may be ferried across early. Light and medium tanks may be used to support the crossing by fire. Medium tanks are more suitable for this purpose.

(1) *Light armored battalion*.—Light tanks are held in concealed assembly areas beyond range of hostile medium artillery fire and move to the river at the proper time to be ferried across or to use the bridge. An assembly point is designated on the far bank of the river where the battalion is reformed. Subsequently, the battalion performs such missions as are directed. Do not close up on river bank, or move up too early. The enemy may launch an air attack or bring artillery fire on the column.

(2) *Medium armored battalion*.—The medium armored battalion, when not used for fire support, is conducted the same as the light armored battalion in (1) above. A medium armored battalion may be used to assist the initial crossing by direct or indirect laying methods. When so used these tanks are placed in concealed positions close to the river bank, preferably on high ground. Medium tanks should not be used to replace artillery but are used for fire on definitely located enemy targets. Do not fire all your ammunition; it will be needed when the crossing is effected.



FIGURE 84.—River crossing. Stay in assembly area until time to move across river. Occupy assembly area on far bank, or move as directed by the higher commander.

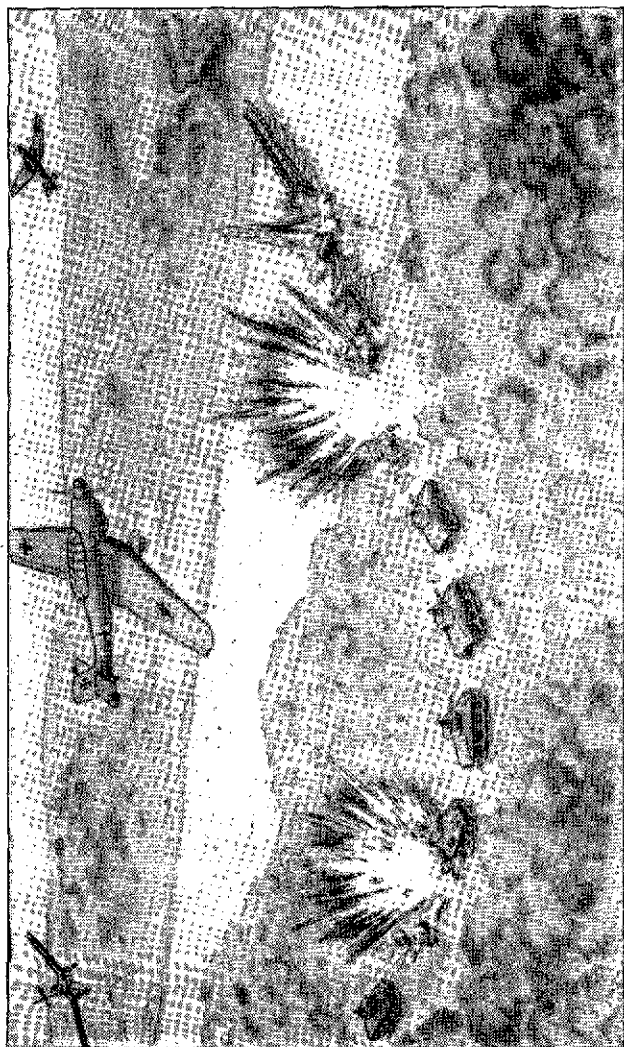

FIGURE 85.—Do not move up too early and crowd vehicles near river.

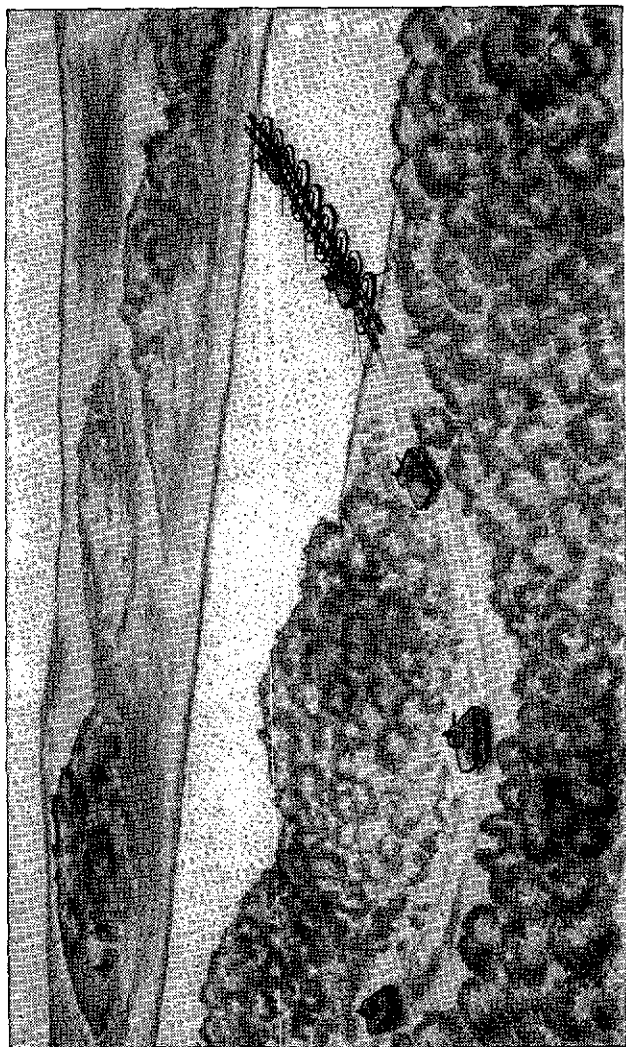

FIGURE 86.—Move up with march distance and cross river without halting.



FIGURE 87.—Tanks, particularly medium tanks, may be used to give direct support for ferrying or bridging operations.

b. Attack to seize a bridge.—In a rapid advance, particularly in pursuit, an armored battalion will attempt to seize bridges before the enemy has had time to destroy them. This action must be rapid and bold. There will be no time for preparing a carefully coordinated plan of action and the methods of attack will vary with the situation. The enemy probably will have the bridge defended by antitank guns and prepared for demolition. The following briefly outlines a method of attack to seize a bridge:

(1) Before the operation starts the battalion commander should obtain and pass on to lower unit commanders all information concerning the approaches to the bridge, the size of the bridge, and defensive positions on the far bank. He should make plans for the attack.

(2) The leading units, that is, the point and the advance party, move at maximum speed and attempt to cross the bridge. At the same time the support goes into position and brings heavy fire on the opposite approaches. This should consist of both heavy weapon and caliber .30 machine-gun fire. Assault guns, mortars, and artillery assist in this fire. Should tanks fail to cross the bridge, attempt to cross infantry supported by fire of tanks and mortars at some point up or down stream. Use any boats that can be found. If engineer rubber boats are available use them. The infantry supported by fire of tanks moves along the opposite bank to capture the bridge approaches. Tanks then move rapidly across and establish a bridgehead.

c. Attack to seize a ford.—The attack of a ford is similar in many respects to the attack of a bridge, except that leading tanks must not rush across the ford before it has been examined. The ford may be mined and one tank disabled in a ford may cost precious minutes in time. One method of attack is as follows: After reconnaissance has determined that the ford is defended, place tanks, mortars, and assault guns in position to fire on the defenders. Use artillery when available. Send infantry up or down stream to cross and destroy or drive the defender back. Search for an undefended ford across which some tanks may be sent to assist the infantry. If the ford is defended by artillery, these tanks should immediately move forward and destroy such artillery. Engineers under protection of fire examine the ford for mines.



FIGURE 88.—Attack to seize a bridge.

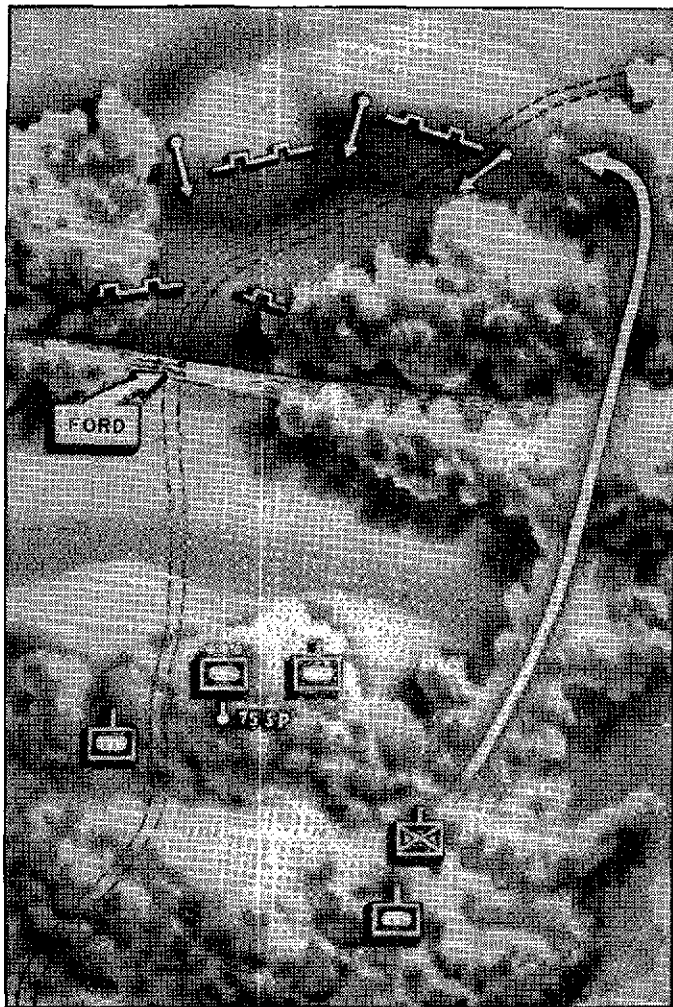

FIGURE 89.—Attack of a ford.

■ 46. DEFENSE OF A RIVER LINE.—In defense of a river line the armored battalion is held in reserve to be used to counter-attack if the enemy should succeed in making a crossing. The operation is similar to defense of a position. (See par. 41 and FM 17-10.)

■ 47. DESERT OPERATIONS.—FM 31-25 gives in detail the methods to be used in desert warfare. Special training and special equipment are required for desert operation. Prior to being moved to such a theater of operation, units should be given intensive training in a similar climate, on similar terrain, and under conditions that as nearly as practicable simulate conditions to be found in that theater.

a. *Formations.*—Because of the lack of concealment, vehicles must be dispersed in daylight or bright moonlight at 100- to 300-yard interval and distance. They must not be in straight lines.

b. *Security.*—(1) Security against air attack is obtained by dispersion and the use of all anti-aircraft weapons.

(2) Security against surprise ground attack is obtained by widespread reconnaissance, close cooperation with observation aviation, and posting of any attached tank-destroyer units on the flanks. Dust stirred up by columns, will, except in a heavy sandstorm, disclose an approaching enemy.

(3) Radio silence must be maintained in bivouac and at least 1 hour before reaching bivouac.

(4) In bivouac, vehicles are forced in the direction in which they are to move out from bivouac. On moonlight nights they must be dispersed and under no conditions should they be closer together than 50 yards. Outposts must be posted to prevent infiltration of hostile troops. (See fig. 90.) Turrets of tanks are turned so the bivouac is protected from all sides. Trains are placed in the interior of the bivouac area.

c. *Navigation.*—As landmarks are few and largely indistinguishable, movement must be made by careful navigation. Each battalion must have a navigator and navigation equipment. Each officer must know how to navigate by dead reckoning and by use of hand compass and odometer.

d. *Camouflage.*—Vehicles may be camouflaged to some extent by oiling the exterior so it will collect sand. By use of

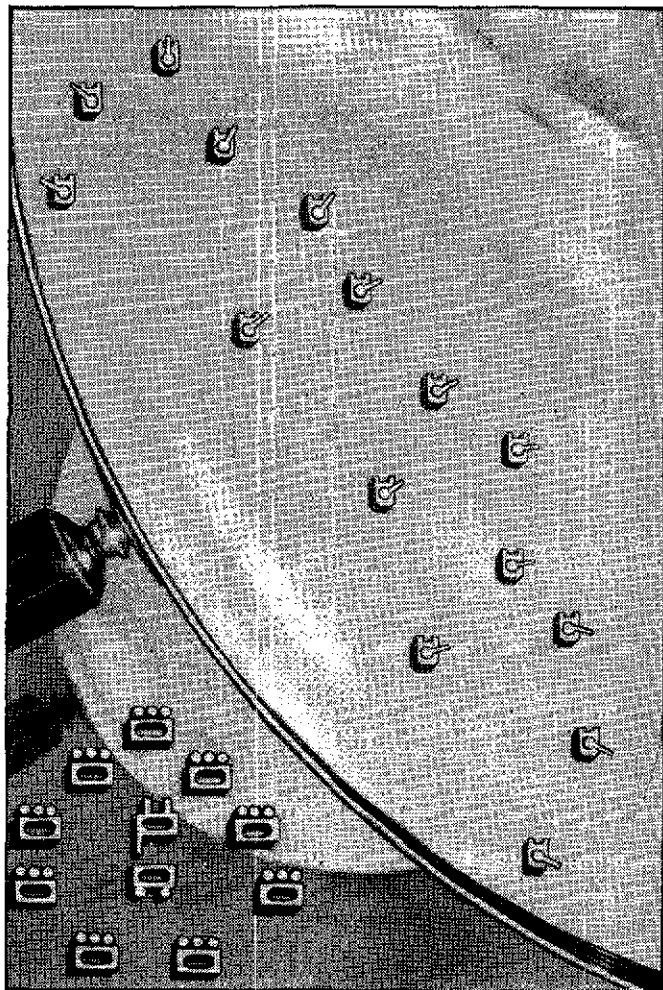

FIGURE 90.—Protection in bivouac showing protection afforded by tanks. Upper right is enlargement of area showing method of sighting guns.

canvas truck tops and a frame, tanks may be disguised as trucks.

e. Concealment.—In combat, whenever practicable, attack with the sun to your back. Use the dust raised by the vehicle as concealment in withdrawal. Attack in a following wind may cause the dust to get in your way and hinder you more than the enemy. Smoke, except in a fairly strong wind, will usually be of little use as convection currents will cause it to pillar.

■ 48. OPERATIONS IN SNOW AND EXTREME COLD.—This is a specialized operation requiring special training and equipment (see FM 31-15). Before being detailed for such duty troops should be specially equipped and should be trained in a climate and under such conditions as will be comparable to that expected in the theater of operations.

■ 49. OPERATIONS IN JUNGLE (see FM 31-20).—*a.* Because of boggy terrain, medium tanks will be useless in jungle except on fairly high ground. Light tanks are more suitable for jungle work.

b. The tank battalion in the advance in jungle warfare moves forward in small columns on trails behind reconnaissance elements. It must be heavily reinforced with engineers. The columns move forward through the jungle and assemble where they can launch an attack in high, open areas (sabanas). Rarely will they be used as a battalion unit.

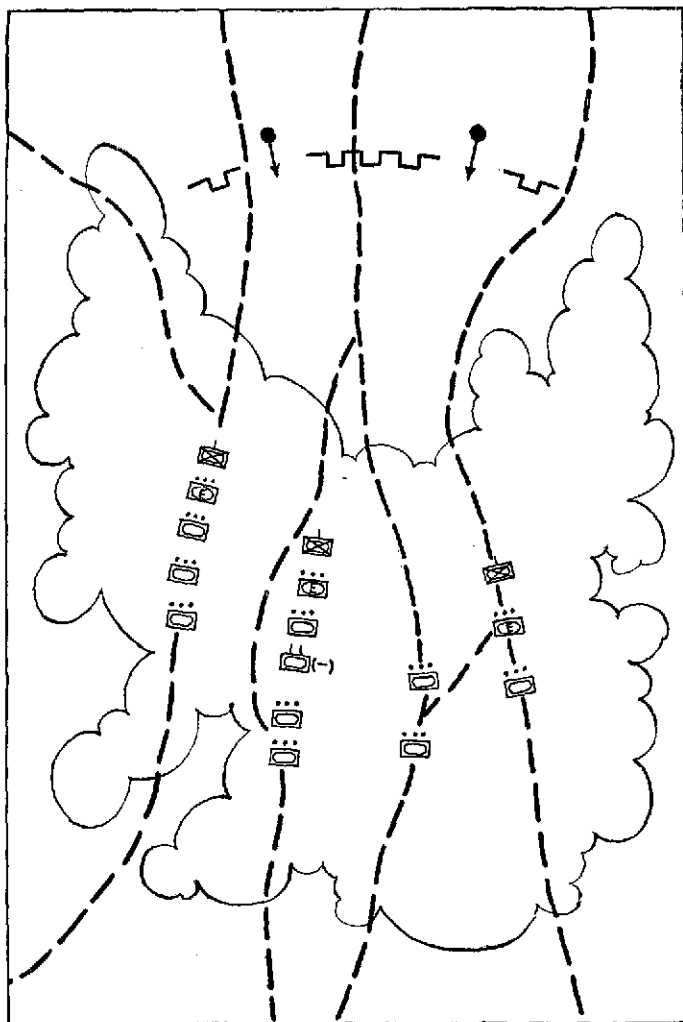

FIGURE 91.—Use of tanks in the jungle. They move forward in small groups and assist in reduction of sabanas.

INDEX

	Paragraph	Page
Advance guard	23, 34	37, 81
Air support	31	71
Antiaircraft security	25	55
Artillery:		
Adjustment of fire	31	71
Check points	31	71
Coordination	32	76
Envelopment	36	103
Fire control	10	12
Meeting engagement	34	81
Penetrations	35	86
Support	31	71
Tank versus tank action	37	107
Assault gun:		
Employment	31	71
Fire control	10	12
Platoon	2	1
Assembly area (position)	26, 33	57, 76
Attack:		
Boundaries in	35	86
By envelopment	36	103
By penetration	35	86
Chemical, security against	27	57
Conduct of	35	86
Coordination of	32	76
Direction of	35	86
Echelons of	28, 35	57, 86
Fire support in	31	71
Line of departure	35	86
Objective	35	86
Of river line	45	122
Of tanks	37	107
Position	33	76
Through infantry	36	86
Time of	35	86
To seize bridge	45	122
Bivouacs	21, 24, 25	31, 49, 55
Boundaries	35	86
Characteristics	3	1
Chemical attack, security against	27	57
Communication	10	12
Control	10	12
Defense:		
General	40	113
Of position	41	113
Of river line	46	131
Reserve in	41	113

INDEX

	Paragraph	Page
Delaying action.....	43	119
Desert operation.....	47	131
Direction of attack.....	35	86
Echelons of attack.....	28, 35	57, 86
Envelopment.....	36	103
Evacuation.....	9, 15, 18	12, 21, 24
Exercises, preparation of.....	7	10
Fire:		
Assault gun.....	31	71
Fire and maneuver.....	3	1
Control.....	10	12
Coordination.....	32	76
Mortar.....	31	71
Support.....	31	71
Flank guard.....	23	87
Formations:		
Attack.....	29	66
March.....	17	21
Penetration.....	35	86
Pursuit.....	39	112
Frontages.....	29	66
Fundamentals.....	3	1
Halts.....	20	24
Headquarters and headquarters company:		
In attack.....	30	71
Organization.....	2	1
Training.....	6	10
Infantry:		
Attack through.....	36	86
In defense.....	41	113
Supporting.....	10, 31	12, 71
Jungle warfare.....	49	133
Liaison.....	12	15
Line of departure.....	35	86
Maintenance.....	9, 14, 18	12, 17, 24
Marches:		
Conduct.....	19	24
Formations.....	17	21
General.....	16	21
Guides.....	19	24
Halts.....	20	24
Phase lines.....	17	21
Plans and orders.....	17	21
Reconnaissance.....	17	21
Route.....	17	21
Security.....	23-25	87

	Paragraph	Page
Mass.....	3	1
Meeting engagement.....	34	81
Mortar:		
Employment.....	31	71
Fire control.....	10	12
Platoon.....	2	1
Objective.....	35	86
Offensive action. (See Attack.)		
Orders.....	11, 17, 34	15, 21, 81
Organization.....	2	1
Outpost.....	24	49
Penetration.....	35	86
Phase lines.....	7, 17	10, 21
Plans.....	11, 17, 34	15, 21, 81
Pursuit.....	39	112
Radio.....	10, 24	12, 49
Rallying point.....	26, 33	57, 76
Reconnaissance:		
In envelopment.....	36	103
Outpost.....	24	49
Personal.....	13	15
Platoon.....	2, 13	1, 15
Route.....	17	21
Reserve:		
Battalion in.....	38	112
Conduct in attack.....	35	86
Defense.....	41	113
Fire, control of.....	10	12
Rear guard.....	23	37
Security.....	22-27	31