

MHI  
Copy 3

*K for release*  
4-30-43 *Estw*

*hak 4/2/43*

FM 2-30

WAR DEPARTMENT

CAVALRY FIELD MANUAL



CAVALRY MECHANIZED  
RECONNAISSANCE SQUADRON

March 29, 1943

*[Faint, illegible text, possibly a stamp or bleed-through]*

FM 2-30

# CAVALRY FIELD MANUAL



## CAVALRY MECHANIZED RECONNAISSANCE SQUADRON



UNITED STATES  
GOVERNMENT PRINTING OFFICE  
WASHINGTON : 1943

WAR DEPARTMENT,  
WASHINGTON, March 29, 1943.

FM 2-30, Cavalry Field Manual, Cavalry Mechanized  
Reconnaissance Squadron, is published for the information  
and guidance of all concerned.

[A. G. 062.11 (1-28-43).]

By ORDER OF THE SECRETARY OF WAR:

G. C. MARSHALL,  
*Chief of Staff.*

OFFICIAL:

J. A. ULIO,  
*Major General,*  
*The Adjutant General.*

DISTRIBUTION:

D 2, 7 (5); B 2 (5); R 2, 7 (4); Bn 2, 7 (4); IBn 2 (10);  
IC 2 (15).

(For explanation of symbols see FM-6.)

## TABLE OF CONTENTS

	Paragraphs	Page
CHAPTER 1. General.		
SECTION I. Purpose and scope-----	1-2	1
II. Organization-----	3-4	1
III. Equipment-----	5-8	2
CHAPTER 2. Training.		
SECTION I. General-----	9-10	4
II. Squadron headquarters and head- quarters troop-----	11-17	6
III. Combat elements-----	18-19	13
IV. Drill-----	20-21	14
V. Inspections-----	22	15
CHAPTER 3. Employment.		
SECTION I. General-----	23-27	16
II. Reconnaissance-----	28-38	18
III. Security-----	39-44	36
IV. Marches, halts, and bivouacs-----	45-47	49
V. Combat-----	48-57	51
VI. Logistics-----	58-60	85
VII. Special operations-----	61-66	88
APPENDIX I-----		93
APPENDIX II-----		103
INDEX-----		107

# CAVALRY FIELD MANUAL

## CAVALRY MECHANIZED RECONNAISSANCE SQUADRON

### CHAPTER 1

#### GENERAL

	Paragraphs
SECTION I. Purpose and scope.....	1-2
II. Organization.....	3-4
III. Equipment.....	5-8

#### SECTION I

##### PURPOSE AND SCOPE

■ 1. **PURPOSE.**—The purpose of this manual is to present the doctrine for the combat training and employment of the mechanized reconnaissances, including squadrons of the motorized infantry division and of the cavalry division.

■ 2. **SCOPE.**—*a.* This manual covers the functional organization, combat training, and tactical employment of the cavalry mechanized reconnaissance squadron.

*b.* The maximum use of functional charts, diagrams, and pictures will be made as illustrations to simplify and expedite training. These to be exploited must be studied. They can be used as the basis for sand table layouts (see TF 7-265 and 7-266).

#### SECTION II

##### ORGANIZATION

■ 3. **ORGANIZATION.**—Tables of Organization 2-25, 2-26, 2-27, and 2-29, prescribe respectively the organization of the cavalry mechanized reconnaissance squadron, its headquarters and headquarters troop, reconnaissance troop, and support troop. Details as to organization are contained in FM 2-5.

■ 4. **TACTICAL GROUPING.**—Appendix I contains charts showing a suggested organization of the reconnaissance squadron

and its components into functional groups. Manning of the various vehicles according to the appropriate Table of Organization is included. These charts are intended as a guide and may be modified by squadron commanders to meet particular conditions.

### SECTION III

#### EQUIPMENT

■ 5. VEHICLES.—*a.* Combat vehicles of the reconnaissance squadron include the following types: armored cars, half-track cars, half-track personnel carriers, light tanks, ¼-ton trucks, amphibious ¼-ton trucks, and ¾-ton trucks, weapons carriers.

*b.* The light armored car M8 (see fig. 1①), is a 6 x 6 vehicle, weighs 15,000 pounds, has a 110-horsepower gasoline engine and is capable of cruising 300 miles. On a level improved road, it can sustain a speed of 55 miles per hour. Vehicular armament includes one 37-mm gun and one caliber .30 light machine gun fixed in combination mount in the turret which allows 360° traverse and one caliber .30 light machine gun in an antiaircraft mount on the turret. Provision is made for installing two radio sets.

*c.* The amphibious ¼-ton truck (see fig. 1②) is similar in capacity, roadability, and performance to the standard ¼-ton truck. Appendix I suggests a suitable distribution of the amphibious vehicles authorized for issue to the squadron.

■ 6. WEAPONS.—*a.* The following weapons are included in the squadron: carbine, caliber .30 light machine gun, caliber .50 machine gun (HB), caliber .45 submachine gun, 37-mm gun, 60-mm mortar, caliber .45 pistol, rifle, caliber .30, and rocket launcher M-1.

*b.* Tables of Organization indicate the numbers and distribution of weapons. 37-mm guns are mounted in armored cars and in light tanks now being issued to the support troop.

■ 7. RADIO.—The type and quantity of radio sets issued to units of the reconnaissance squadron are indicated in Tables of Equipment. A suggested organization of the radio sets of the squadron into nets is illustrated in appendix II.

■ 8. DESTRUCTION OF MATÉRIEL.—In order to prevent an enemy from using captured vehicles, weapons, and communication equipment, it is necessary that personnel be trained in the disabling or destruction of all equipment in the squadron. The various ways of accomplishing this destruction are detailed in FM 2-20. It is emphasized that destruction of equipment is a command decision of division and similar units. This authority may be delegated to subordinate commanders by the division commander.

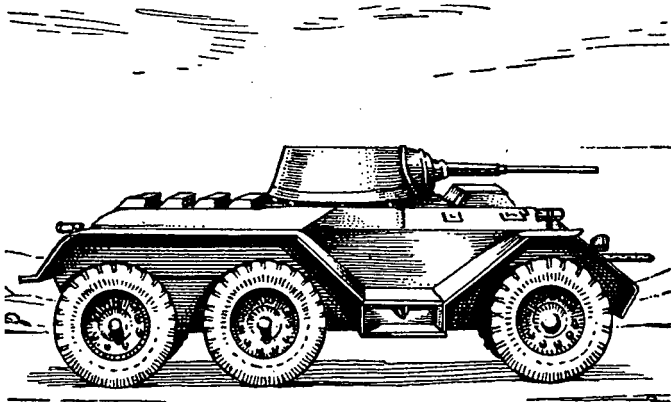

① Armored car M8.

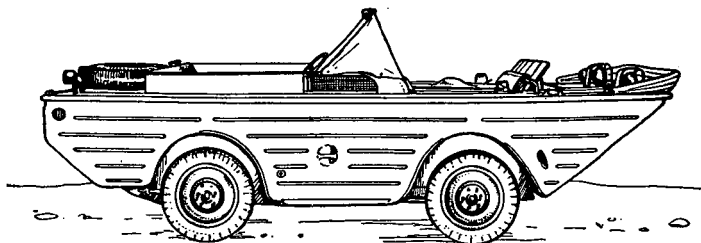

② ¼-ton truck, amphibian.

FIGURE 1.

## CHAPTER 2

### TRAINING

	Paragraphs
SECTION I. General.....	9-10
II. Squadron headquarters and headquarters troop..	11-17
III. Combat elements.....	18-19
IV. Drill.....	20-21
V. Inspections.....	22

#### SECTION I

#### GENERAL

■ 9. OBJECTIVES.—*a.* The initial training objective is to achieve the standards of individual and subordinate unit proficiency in basic, technical, and tactical phases as prescribed in FM 2-50 (when printed).

*b.* The ultimate objective of the training program is to achieve a smoothly functioning organization, having exceptionally high morale, capable of executing its primary mission of reconnaissance and of performing aggressive offensive and defensive combat within the limitations of its equipment and weapons.

*c.* In order to insure continuity in action by this unit, which normally operates under conditions which limit the possibility of rapid replacement of casualties, it is necessary that each man be qualified to drive the vehicle in which he rides (see TM 21-300), man the weapons in the vehicle, and operate the means of communication provided therein (see TM 11-454 and FS 11-1). Personnel must be fully trained in dismounted combat, reduction of road blocks, and individual and unit protective measures (see FM 21-45).

*d.* In mobile warfare it is essential that personnel in all grades fully appreciate the necessity for and importance of combat intelligence. In the mind of the private, the G-2 and his section must not be a mystery. The individual must be given a clear, workable understanding of military intelligence, his relationship to G-2, and how he may contribute to



intelligence operations. In addition to training in field observation as outlined in FM 21-45, and in reporting certain specified information as a matter of standing operating procedure (see par. 33), or on order, the cavalry soldier should be trained to observe and report any information which may be of value in the operation being conducted. In order to prevent the G-2 section from being glutted with a mass of minutia, each commander should receive such intelligence training, compatible with his responsibility, as will enable him to appreciate the relative importance of information received, to recognize and consolidate duplications, and to report promptly to the appropriate agency the information received.

■ 10. METHODS.—*a.* Training will be conducted according to the principles set forth in FM 21-5 (note particularly secs. IV and V). Maximum use will be made of the publications listed and suggestions contained in FM 21-6 and 21-7. (See TF 7-295 and FS 7-75.)

*b.* Effective training can only be achieved when the interest of all participants is sustained. Interest-holding tactical problems must be worked out well in advance with painstaking care as to details of execution. The execution of an applicatory tactical exercise should involve the following steps:

(1) The problem is planned to bring out a specific principle or phase of operation and to emphasize the battle application to a given situation. This planning will include selection of suitable terrain first by map study and then examination of the ground itself to insure suitability and complete familiarity with it.

(2) The problem is then staked out on the map and solved in conference. All rough spots are ironed out and unsound tactical procedures eliminated.

(3) The problem is then worked on a sand table with all officers and selected key noncommissioned officers present. The problem may be worked several times and each participant called upon for a solution to a particular phase. (See TF 7-265 and 7-266.)

(4) The problem is then worked on the ground and is

followed immediately by a critique in which constructive criticism points out errors in tactics, technique, and procedure and indicates correct combat methods. The problem, or desired portions of it, may be repeated several times, rotating organizations in order to allow each unit to participate in each phase.

## SECTION II

### SQUADRON HEADQUARTERS AND HEADQUARTERS TROOP

■ 11. **RESPONSIBILITY.**—Fundamental training, classified as basic, technical, and tactical, of individuals of the headquarters troop is the responsibility of the troop commander and is conducted under his supervision. Specialist training of a technical and tactical nature is conducted under the supervision of the staff officer to whose section the individual is assigned or the officer who commands the platoon or section.

■ 12. **SQUADRON HEADQUARTERS.**—Squadron headquarters contains the commissioned and warrant officer personnel necessary to perform squadron command and staff duties in combat. The duties of these individuals are as follows:

*a. Squadron commander.*—The squadron commander is responsible to the division commander for the training, administration, and operations of the reconnaissance squadron. He closely supervises all phases of training, inspecting and observing constantly. During operations, he visits his units and gains first-hand knowledge of the tactical situation. He develops initiative and self-confidence in his subordinates by delegating appropriate command responsibility to them and not interfering until circumstances make it absolutely necessary. The squadron commander is provided with a staff to assist him and relieve him of details in order that he may devote the maximum time to major decisions and personal contact with his combat elements. This staff includes the personnel described in *b* to *f*, inclusive, below.

*b. Executive officer.*—The squadron executive is second in command and principal assistant to the squadron commander. He coordinates and supervises all staff activities,

keeps informed of the situation, verifies the execution of orders and, when necessary in the absence of the squadron commander, makes decisions and issues orders to effect them. Normally he remains at the command post when the commander is away.

*c. Adjutant.*—The squadron adjutant (see also par. 15*b*) is squadron S-1. His staff duties include supervision of—

(1) Receiving and delivering replacements to troops in coordination with S-2-3.

(2) Preparation of strength and casualty reports.

(3) Recreation and morale activities.

(4) Leaves of absence, furloughs, discipline, rewards, and punishments.

(5) The collection and disposition of prisoners of war in coordination with S-2-3 and S-4.

(6) Graves registration service, including burials, in coordination with S-4.

(7) Sanitation, coordinated with S-4 and assisted by the squadron surgeon.

*d. S-2-3.*—The squadron S-2-3 is concerned primarily with the collection, recording, evaluation, and dissemination of information of the enemy and with the training and tactical operations of the squadron. In detail, his duties include—

(1) Preparation of detailed plans based upon the squadron commander's decision.

(2) Preparation and issuance of intelligence instructions, reconnaissance instructions, and tactical orders.

(3) Maintenance of the situation map and preparation of operations maps.

(4) Planning of security measures to include camouflage and concealment.

(5) Maintenance of liaison and exchange of intelligence with higher, adjacent, and subordinate units.

(6) Procurement and distribution of maps, aerial photographs, and photomaps.

(7) Preparation of data for tactical and training reports.

(8) Examination of captured personnel, documents, and matériel for information of immediate importance to the squadron.

(9) Planning and supervising all training in accordance with the unit training program.

*e. Supply officer.*—The squadron supply officer performs S-4 duties to include—

(1) Preparation of supply plans based upon tactical plans, coordinated with S-2-3.

(2) Supervision of the procurement, storage, and issue of all classes of supply.

(3) Control of squadron trains when troop supply vehicles are operating under squadron control.

(4) Supervision of the evacuation of casualties, disabled equipment, prisoners, and captured matériel.

(5) Supervision of maintenance of equipment, assisted by the squadron motor maintenance officer and coordinated with S-2-3 for priorities.

(6) Security for the rear echelon, coordinated with S-2-3.

*f. Communication officer.*—The communication officer, in addition to commanding the command and communication platoon (see par. 14*b*), is adviser to the squadron commander and staff on matters relating to signal communication, including location of command posts.

■ 13. TROOP HEADQUARTERS.—Troop headquarters contain the necessary personnel for the control and administration of the troop; the messing of the squadron headquarters and the troop; and for squadron second echelon motor maintenance.

*a. Headquarters section.*—The troop commander supervises the specialist training of all enlisted personnel in the headquarters section. As headquarters commandant, assisted by the mess officer and mess sergeant, he supervises the operation of the mess and the training of cooks, cook's helpers and orderlies. Assisted by the first sergeant, he supervises the training of the troop clerk, messenger, and bugler. Sergeant, supply, under direction of the troop commander, is responsible for the receipt, care, and issue of supplies within the troop. The armorer maintains and repairs the troop weapons and is the assistant to the supply sergeant.

*b. Motor maintenance platoon.*—The lieutenant in troop headquarters commands the motor maintenance platoon and

is the squadron motor officer. Master sergeant, motor, is the squadron motor sergeant and assistant to the squadron motor officer. The staff sergeant, motor inspector, makes periodic inspection of all vehicles in the squadron. He prepares and maintains all records and reports pertaining to supplies, repairs, and operations of the vehicles of the squadron. The staff sergeant, motor, is the assistant squadron motor sergeant. The sergeant, crew chief, has direct charge of the mechanics of the platoon. The corporal, supply, motor, is charged with the procurement, care, and issue of replacement parts, and assists the staff sergeant, motor inspector, in the preparation of those records and reports pertinent to motor supply. The mechanics, in addition to reaching the necessary high proficiency in maintenance and repair work, must be specially trained in the use of weapons and field expedients and should receive such instruction in map reading as will qualify them to make separate marches incident to salvage operations. It should be standing operating procedure within the squadron for the mechanics of the motor maintenance platoon to be trained as three crews capable of being sent out to perform squadron second echelon maintenance on vehicles disabled in the field; these three crews to be commanded respectively by the master sergeant, motor; the staff sergeant, motor; and the sergeant, crew chief. (See TF 10-166, 10-167, 10-291, 10-299, 10-300, 10-301, 10-319, 10-376, 10-377, 10-570, 10-592, 10-593, 10-595, 10-596, 10-639; FS 10-33 to 10-36, 10-39, 10-40, 10-42, 10-43, 10-44, 10-53 to 10-56, 10-58, 10-61, 10-62 to 10-66, 17-6, 17-7, 17-9 to 17-12 and 17-14.)

■ 14. COMMAND AND COMMUNICATION PLATOON.—The command and communication platoon furnishes the personnel and equipment for the forward echelon of squadron headquarters. It comprises individuals with functions as follows (see also FM 2-50):

*a. Intelligence and operations section.*—Major S-2-3 performs the duties of S-2 and S-3 as prescribed in FM 101-5 and paragraph 12*d*. He is assisted in his duties by the technical sergeant, intelligence and operations. The sergeant keeps the situation and operations maps and records data for journal and diary. Specialist training prerequisites for

this position include advanced map and aerial photograph reading, sketching, and drafting. (See FM 21-26 and 30-20.) Major S-2-3 trains his assistant in the collection, evaluation, interpretation, and distribution of information of the enemy (see FM 30-5); in the establishment of observation posts (see FM 30-10); in examination of prisoners of war, enemy deserters and enemy documents (see FM 30-15); and in the preparation of orders (see FM 101-5).

*b. Communication.*—(1) The communication officer is responsible to the squadron commander for the training, operation, and maintenance of all communication agencies within the squadron. He prepares instructions relative to radio discipline. He prepares signal operating instructions coordinated with those of the division and, when the squadron is tactically employed, maintains communication with attached, adjacent, and higher units. His duties are prescribed in FM 24-5, FM 101-5 and paragraph 12*f*.

(2) The warrant officer, as chief assistant to the communication officer, must be a qualified radio operator and technician and be completely familiar with message center procedure and with the operation, inspection, and maintenance of all squadron communication equipment. He assists the communication officer in training personnel according to the principles detailed in FM 24-5.

(3) The technical sergeant, communication, is in direct charge of radio communication and supervises the operation of the net control station in the squadron commander's car. He must be expert as a radio operator and in radio procedure. (See FM 24-6, 24-10; TM 11-454, 11-455, and 11-461.)

(4) The sergeant, message center, as enlisted chief of the message center, must keep himself posted as to the location of higher and lower headquarters and the means of communication available at any given time. He must know thoroughly and be able to teach message center procedure. (See FM 24-5.)

(5) The radio electrician repairs the radio equipment of both the headquarters troop and the support troop.

(6) All radio operators, in addition to their specialist

training, should be qualified as drivers and gunners for the vehicles in which they ride.

c. All personnel, commissioned and enlisted, of the command and communication platoon, must be capable of operating the unit radio sets at least on voice.

■ 15. SUPPLY AND ADMINISTRATIVE PLATOON.—This platoon contains the enlisted personnel and equipment for the rear echelon of squadron headquarters. The captain in this section, in addition to his duties as squadron supply officer, performs S-4 functions as indicated in paragraph 12d.

a. *Supply section.*—S-4 is assisted by the technical sergeant, supply, and one clerk. The supply sergeant must have a knowledge of the system of supply of the squadron in the field and of receipt, storage, issue, and care of supplies. He must know how to prepare all papers pertaining to supply. In addition to training in the paper work incidental to supply, the clerk must be qualified to operate the machine gun in the truck in which he rides.

b. *Administrative section.*—This section is under the command of the lieutenant, personnel adjutant (see also par. 12b). However, it functions as two sections. The adjutant, assisted by the warrant officer, assistant adjutant, and the master sergeant, sergeant major, handles the correspondence, reports, and filing of administrative records, orders, bulletins, and other matter received and issued by the squadron, and trains clerical assistants. Lieutenant, personnel adjutant, assisted by the technical sergeant, personnel sergeant major, and the necessary clerks, keeps the personnel records of the entire squadron. All clerks should be trained as relief drivers and gunners.

■ 16. ANTITANK PLATOON AND PIONEER AND DEMOLITION PLATOON.—The lieutenants in command of the antitank platoon and pioneer and demolition platoon advise the squadron commander as to the employment of their respective platoons. In addition to his other duties, either of these officers may be designated as mess officer for headquarters troop. Details as to the training of these platoons, which comprise the combat element of headquarters troop, are contained in MTP 2-1. The standards of technical and tactical proficiency

for each platoon and its personnel are contained in FM 2-50 (when printed).

*a.* The mission of the antitank platoon being essentially that of mobile, aggressive defense, it is necessary that training in selection and occupation of firing positions and technique of fire be most thorough. The platoon must be trained as a unit to organize the antimechanized defense of the squadron. In order to develop well coordinated tactical groups, the antitank sections will receive combined training with subordinate elements of the squadron. Although it is necessary that a high degree of teamwork exists between the vehicles of a section and between sections of the platoon, it is equally necessary that initiative be developed in the crew of the individual vehicle. Each member of the vehicle's crew must be able to function efficiently in all crew positions. (See TF 5-146, 5-147, 5-148, and 5-962.)

*b.* The pioneer and demolition platoon will receive combined training with the pioneer and demolition squads of reconnaissance platoons whose operations it complements. Technical details involved in the operations of the platoon in the execution of its missions are contained in FM 5-15, 5-20, 5-25, 5-30, and 5-35. (See TF 5-147, 5-149, 5-199 to 5-203, 5-270 to 5-273, 5-571 to 5-575, 5-597, 5-598, 5-697 to 5-699, 5-955, 5-956, and 5-962; FS 5-6 and 5-7.)

■ 17. ATTACHED MEDICAL.—The squadron medical detachment is commanded by the captain, Medical Corps. Assisted by two lieutenants, Medical Corps, he conducts the technical training of the enlisted personnel of the detachment. Because of the difficulty of evacuating casualties in this type of unit, personnel should be trained in map reading and use of cover and concealment. In addition to his command functions and personal participation in medical care of casualties, the surgeon is a member of the squadron staff with duties which include—

*a.* Advising the commander and staff on matters pertaining to the health and sanitation of the squadron and the training of personnel in personal hygiene, sanitation, and first aid.

*b.* Conducting sanitary inspections.



*c.* Procurement, storage, and distribution of medical equipment and supplies.

*d.* Preparation of reports.

*e.* Evacuation of casualties, coordinated with S-4. (See TF 8-33, 8-150, and 8-304; FS 8-3 to 8-13, 8-25 to 8-32, 8-35, 8-40, and 8-41.)

### SECTION III

#### COMBAT ELEMENTS

■ 18. RECONNAISSANCE TROOP.—*a.* The basic, technical, and tactical training of the reconnaissance troop of the reconnaissance squadron is prescribed in MTP 2-1 and is almost identical with that described in FM 2-20 (when printed).

*b.* Because of the rapidity with which its parent organization marches and maneuvers, limitations of time will frequently necessitate that the squadron abandon stealth and fight for information. This is called reconnaissance in force. It is imperative that in the tactical training of the reconnaissance troop of the reconnaissance squadron offensive combat, particularly combined offensive action with other reconnaissance troops and with the support troop, be stressed.

■ 19. SUPPORT TROOP.—*a.* Details of the unit training of the support troop are contained in MTP 2-1. Combat training of the tank platoon is covered in FM 2-35 (when printed). (See also FM 17-30.) (See TF 17-264, 17-314, 17-315, 17-375, 17-576 and FS 17-5.)

*b.* The support troop is an offensive weapon, combining mobility, shock and fire power, which is included in the squadron as a means of overcoming resistance to the operations of the reconnaissance troops. By means of combined training it must become capable of functioning smoothly with the reconnaissance troops.

*c.* The support troop is not intended primarily as a reconnaissance unit. However, when the terrain is not suited to the operation of wheeled vehicles or when enemy activity is too great a hazard to armored cars, it may be expedient to employ support troop elements on reconnaissance. It is

therefore essential that the support troop be trained in reconnaissance.

*d.* Because of the limited quantity of ammunition carried in the light tank, it is imperative that training in ammunition conservation be included. Such training should be stressed during exercises in which firing is simulated. Both gunners and assistant gunners should keep track of the rounds the gunner has simulated firing and cease firing when the hypothetical number of rounds is exhausted. If promiscuous simulated firing without thought of ammunition supply is permitted, wasteful habits will be developed.

## SECTION IV

### DRILL

■ 20. GENERAL.—*a.* The primary purpose of drill is to train a number of individuals to move and function as a unit in order to facilitate control. Psychologically it is a potent means of developing discipline in the enlisted man and command responsibility in young or inexperienced officers.

*b.* Dismounted drill is as prescribed in FM 22-5. (See TF 7-143, 7-144, 7-248, 7-249, 7-560, and 7-561.)

*c.* Normally, mounted drill is performed by the troop or lower unit. Drill of the squadron is exceptional, being limited to ceremonies and inspections.

*d.* Details of mounted drill are covered in FM 2-5. Drill commands and signals are indicated in FM 2-5, 2-35 (when printed), and 22-5.

■ 21. TACTICAL FORMATIONS.—*a.* With the exception of the support troop, the elements of the squadron will not, in their normal employment, use drill formations in combat. In desert warfare, extended-interval drill formations may be used to facilitate control.

*b.* The support troop may frequently use extended order drill formations in combat. To facilitate control, the various combat formations usually are designated in unit standing operating procedure by a letter symbol such as **A**, **B**, **C**.

## SECTION V

## INSPECTIONS

■ 22. **GENERAL.**—The conduct of dismounted inspections without vehicles is covered in FM 22-5. Inspections with full field equipment are as prescribed in FM 2-5.

## CHAPTER 3

### EMPLOYMENT

	Paragraphs
SECTION I. General.....	23-27
II. Reconnaissance.....	28-38
III. Security.....	39-44
IV. Marches, halts, and bivouacs.....	45-47
V. Combat.....	48-57
VI. Logistics.....	58-60
VII. Special operations.....	61-66

#### SECTION I

#### GENERAL

■ 23. GENERAL PRINCIPLES.—*a.* The reconnaissance squadron is organized and equipped for the specific purpose of securing the detailed information needed by the commander of a motorized infantry division or cavalry division to plan his operations intelligently.

*b.* The size and composition of the squadron, as compared with the reconnaissance troop of the infantry division, is necessitated by the fact that the motorized or cavalry division, unlike the infantry division, often will operate on missions without close support or assistance by other infantry divisions or at considerable distance from other divisions, will advance on a broad front and will therefore be unable to depend on a corps reconnaissance element for information. Furthermore, the movement of the motorized or cavalry division is so rapid as to require individual reconnaissance platoons to operate on a relatively narrower front in order to accelerate their rate of advance.

*c.* The operation of the squadron is characterized by speed in decision and action.

■ 24. MISSIONS.—*a.* The principal mission of the reconnaissance squadron is to obtain the information required by higher authority and get it back to the interested commander in time to be evaluated and acted upon.

b. While the squadron is capable of executing counter-reconnaissance and certain offensive and defensive operations, the division commander, before assigning such other missions, should consider the availability of other troops more suitable to perform them and the relative importance of the missions compared with reconnaissance.

c. In issuing orders to the squadron, the division commander must assign definite missions expressing specifically what information he desires and when he must have it. The squadron commander must enjoy the confidence of the division commander and his general staff, especially the Chief of Staff, G-2 and G-3, and know their plans sufficiently and in ample time to insure the effective employment of the squadron. He should be so familiar with the division commander's personality, habits, and manner of tactical operation as to be able, in a given situation, to say, "If he were here he would want so and so."

d. Within the squadron and its subordinate elements all personnel should be familiar with and understand their specific missions and that of the squadron. This is essential to insure continuity of action because in many situations the crew of an individual vehicle will be entirely on its own.

■ 25. TYPES OF TACTICAL ACTION.—Either incident to a reconnaissance mission or otherwise, the reconnaissance squadron must be fully qualified and must expect to undertake the following types of tactical action:

Marches.

Security (internal, for other elements, counterreconnaissance).

Attack.

Pursuit.

Defense.

Delay.

Demolitions.

Withdrawal.

Certain special operations (antiairborne, amphibious, river line, desert, jungle).

■ 26. COOPERATION BY OBSERVATION AVIATION.—a. Cooperation by aviation operating in support of the division increases

the efficiency of operation of the reconnaissance squadron. Air observers flying long-range reconnaissance missions can furnish such timely information to the commander as—

(1) Location, strength, composition, and disposition of the hostile main force.

(2) Location and strength of enemy security and reconnaissance detachments.

(3) Rates and direction of movement and routes followed by any hostile forces in the observed area.

(4) Apparent condition of routes and bridges in the zone to be reconnoitered by the squadron including location and nature of road blocks, demolitions, and possible ambush.

(5) Terrain features which may be utilized to advantage by either hostile or friendly forces.

b. The air observer communicates directly with the squadron by dropped and pick-up messages, visual signals, or radio. (See FM 24-5.)

c. Time and the situation permitting, the air unit and the reconnaissance squadron should be given combined training to enable them to function efficiently as a team.

■ 27. COOPERATION WITH TANK DESTROYER BATTALIONS.—The reconnaissance element of the tank destroyer battalion, operating with either the motorized or cavalry division, bases its operations upon the information gathered by the reconnaissance squadron on its normal missions. Closer cooperation is insured when the tank destroyer battalion places a liaison agent, with transportation and means of communication, with the squadron headquarters. For greater detail, see FM 18-5 and 2-20 (when printed).

## SECTION II

### RECONNAISSANCE

■ 28. METHODS.—a. The methods of employment described in FM 2-20 (when printed) for the reconnaissance troop, infantry division, are applicable equally to the individual reconnaissance troops of the squadron.

b. The action of the squadron may be described as fluid. It moves along its assigned channel (route, zone, or area),

rapidly and more forcefully when the channel is narrow; less rapidly when its front is widened. It seeks to flow around or infiltrate through such obstacles as hostile counterreconnaissance or security groups by means of stealth and to reach the enemy main body. When the advance of its detachments is arrested by enemy action, necessary pressure is applied at a weak point by the use of reserve elements to penetrate the resistance and expose the enemy dispositions to continued reconnaissance.

*c. Contact with the enemy once gained must not be lost.*—However, it is not sufficient merely to gain contact. After the enemy has been located, reconnaissance activity must be intensified to secure information as to his disposition, strength, identity of units, organization, equipment, attitude, morale, movements, and capabilities. Of particular importance is information as to the location of command posts, centers of signal communication, observation posts, reserves, artillery positions, tank concentrations, advance landing fields, supply installations, and routes of communication. (See also par. 33.)

■ 29. DEPTH AND FRONTAGE.—A statement that a reconnaissance squadron is capable of executing reconnaissance in a zone or area of a stated breadth and at a particular rate or distance is dangerous if taken too literally. Rarely will two situations be the same and in each case the influence of terrain features, condition and pattern of the road net, present and predicted weather conditions, fatigue of personnel, condition of vehicles and, most important, enemy action, will determine the unit's capabilities. The following should be considered only as guides:

*a.* The distance by which the squadron may precede its division varies from several hours' to 1 or more days' marches.

*b.* With a good road net and when unopposed, it can advance from 125 to 200 miles daily at a rate of between 25 to 30 miles an hour. As an example, when distant air reconnaissance has located the hostile force at a considerable distance, the squadron may be sent out at maximum speed to gain contact.

*c.* Active and effective reconnaissance at a rate of more

than 10 to 15 miles per hour should not be expected. One of the limiting factors previously mentioned or any combination of them may reduce the rate to as low as 4 miles per hour.

d. With one reconnaissance troop initially in reserve, the squadron can reconnoiter a zone containing six to ten axial roads and their intersecting lateral roads on a front of from 25 to 35 miles. Exceptionally, and by employing eight platoons on the front, the assigned zone for reconnaissance may be extended to 50 miles in breadth.

e. When the division operates as part of a corps, it is possible that the squadron, or elements therefrom, will be assigned supplementary reconnaissance missions in rear of or to the flank of the corps reconnaissance regiment. Transfer of responsibility for reconnaissance from corps to division agency is accomplished in the manner described in FM 2-20 (when printed). The squadron establishes liaison with the corps reconnaissance group by radio or, preferably, by an agent with a radio-equipped vehicle.

■ 30. ROUTES, ZONES, AND AREAS.—The division commander and the squadron commander in turn prescribe specific axes or routes and boundaries of zones and areas to their respective reconnaissance agencies. This practice has the twofold purpose of definitely allocating responsibility on the one hand and of preventing duplication of effort on the other. However, such definition of boundaries is not intended to restrict the initiative of subordinate commanders. The maximum freedom of movement that the particular situation warrants is allowed. For example, the commander of one detachment observing something which he believes should be more closely reconnoitered in the zone of a second detachment may take any action from directing the attention of the second detachment commander to it to making a detailed reconnaissance himself. The factors that he will consider in deciding are the urgency of his own mission, time and space to include relative distance of his own and the adjacent detachment from the suspected area, its apparent importance, and the disposition of his own force. The situations wherein a zone, a route, or an area may be designated are as follows:



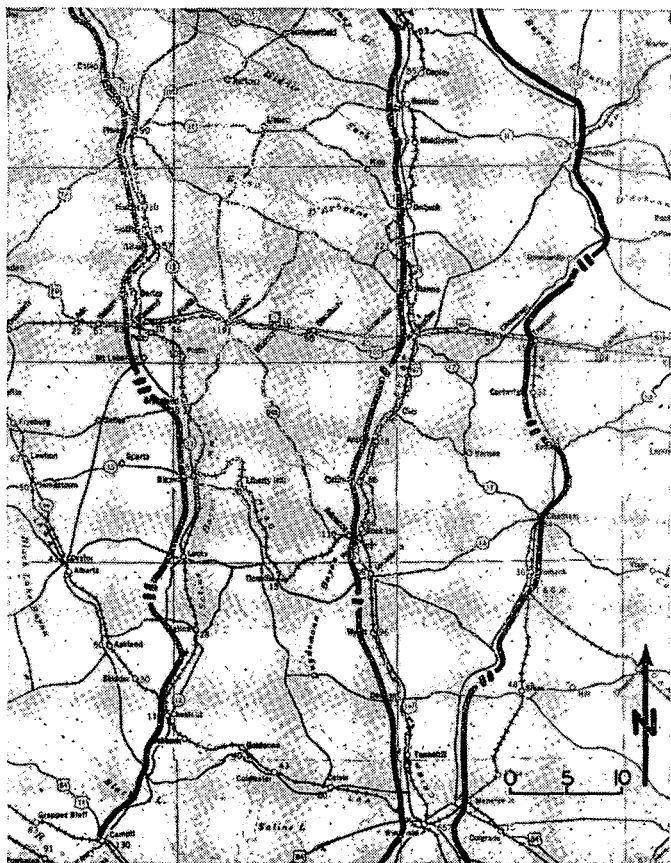

FIGURE 2.—Zone boundaries should be easily recognized terrain features.

a. When the enemy is disposed on a broad front or when his location is in doubt, a zone of reconnaissance may be assigned. Factors to be considered in determining the width of the zone to be assigned are those indicated in paragraph 27. Zone boundaries should be easily recognized features such as roads, railroads, rivers, ridge lines, etc. (See fig. 2.)

b. When information indicates the enemy's movement is by a definite route (or routes) or when terrain features canalize his advance, a route (or routes) or an axis is designated.

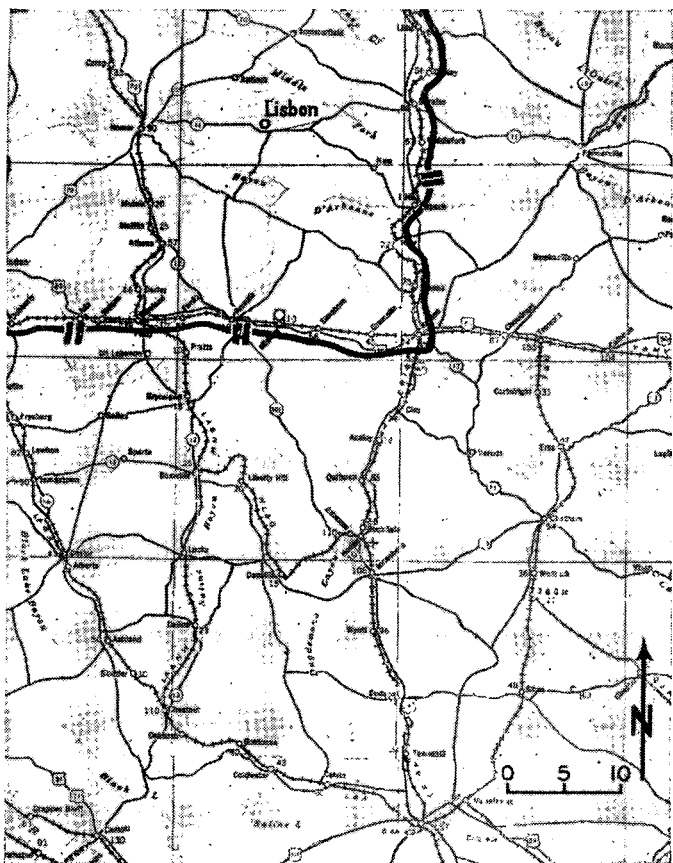

FIGURE 3.—Enemy concentration reported at Lisbon. Reconnoiter area north of Y & M V RR and west of C R I & P RR.

c. When accurate information such as that obtained by espionage or the action of other reconnaissance agencies has disclosed the presence of the enemy in a definite area, that area or locality is assigned for reconnaissance. (See fig. 3.)

■ 31. STRENGTH OF DETACHMENTS.—*a.* The size and composition of a reconnaissance detachment is dictated by the factors of the particular situation: the mission, terrain, information of the enemy including his capabilities, the condition of own personnel and equipment, and the cooperation of friendly ground and air units. No arbitrary statement as to strength can be universally applicable. As a general rule, the principle of economy of force will govern and the minimum strength considered necessary to perform the assigned mission will be employed. The efficiency of the squadron is increased if the commander is able to operate with one reconnaissance troop in reserve (see fig. 4①) and, in a continuing situation, to relieve the reconnoitering troops by rotation. The support troop usually will be retained by the squadron commander as a reserve weapon which he may use to effect a penetration of a counterreconnaissance screen or to support a reconnaissance troop.

*b.* It may be necessary to employ all three reconnaissance troops simultaneously (see fig. 4②). The situation often will require that reconnaissance troops be strengthened by attaching elements from the reserve (see fig. 4③). Exceptionally, the reconnaissance troops may be reinforced by detachments from the support troop. More appropriately the squadron commander increases the strength of his reconnaissance troops by the attachment of other units furnished him on his request by the division commander in such strength and of such type as the particular situation necessitates.

*c.* In a fast-moving situation over terrain having a relatively dense road net, the squadron commander may detach the platoons from one or more reconnaissance troops and employ them under his direct control. (See fig. 4④.)

■ 32. INSTRUCTIONS.—The basic doctrine is that sufficient information be disseminated, from the commanding general down through appropriate channels to the lowest ranking

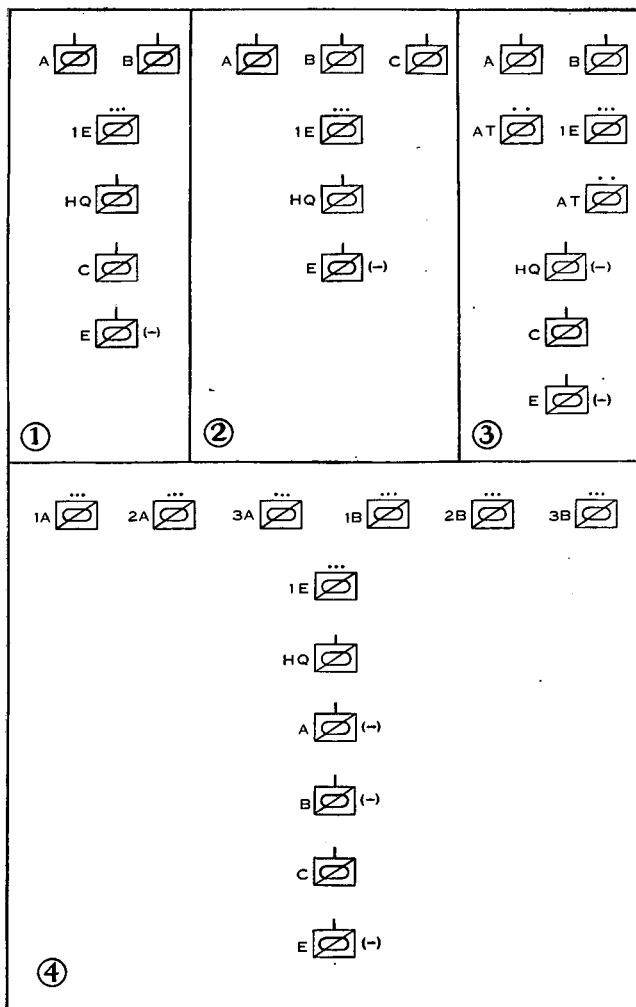

FIGURE 4.—Normal squadron dispositions on reconnaissance.

enlisted man, to insure that all personnel have a clear concept of the commander's plan and his information needs.

a. Instructions may be issued to the squadron commander in an intelligence annex or in a simplification of that form (see FM 101-5). The essential elements of information (see FM 30-5), so far as they pertain to the squadron, are expressed in the form of definite missions requiring positive or negative answers to specific questions. Further instructions include—

Time of departure.

Routes or boundaries of zones or areas.

Objectives and time to be reached.

Duration.

Control measures.

Adjacent reconnaissance units.

Time and manner of transmitting reports.

Communication, including air-ground.

Time of departure, routes and objectives of the main force.

b. Instructions by the squadron commander to his reconnaissance detachments follow the same pattern but usually are issued orally. When feasible, troop officers are assembled and orders are issued in conference. The use of the blank forms shown in figures 5 and 6, prepared in advance by S-2-3 or filled in by subordinate commanders while oral orders are being issued, expedites the work of S-2-3 and places specific written instructions in the hands of subordinates in such form as to be unidentifiable and of small value to the enemy if they are captured.

c. Within the limitations of the situation, the troop commander assembles his officers and noncommissioned officers to issue orders. As a given situation develops, additional fragmentary orders may be transmitted by voice, messenger, or radio.

■ 33. ROUTINE ITEMS OF INFORMATION.—It is standing operating procedure within reconnaissance units to observe and report without being specified in orders, information covering the following (see also par. 9):

*a. Terrain.*—Swamp and marsh areas or other difficult areas, fordability of streams, commanding ground, positions favoring a hostile ambush, area suitable for advanced or emergency landing fields, cover and concealment.

*b. Roads, bridges, and culverts.*—Type, condition, load limit, traffic capabilities, and materials available in vicinity to repair or strengthen.

*c. Obstacles, demolitions, mines, and contaminated areas.*—Nature, location, extent, and means of avoiding.

*d. Supplies.*—Amounts, location, type and condition, particularly fuel, lubricants, and food.

*e. Hostile aircraft.*—Number, type, altitude, direction of flight, and location at a stated time.

*f. Utilities* (water, sewerage, power, communication, railroads, docks).—Condition, repair necessary, and materials available for repair.

*g. Civilian population.*—Density, economic status, attitude, evidence of being armed.

ORGANIZATION \_\_\_\_\_

Detachment No. \_\_\_\_\_ Hour of departure \_\_\_\_\_

Zone boundaries (area, axis, or route). \_\_\_\_\_

## OBJECTIVES:

Time to be reached

- |          |  |
|----------|--|
| 1. _____ |  |
| 2. _____ |  |
| 3. _____ |  |

Axis of march: \_\_\_\_\_

Axis of sig. com. \_\_\_\_\_

of next higher unit: \_\_\_\_\_

PRI-ORITY	MISSIONS	REPORT	
		Due	Submitted

This form is intended primarily for use at the service schools to secure uniformity in instruction in the formulating of orders to be issued to reconnaissance agencies. The form may also serve as a supplement to paragraph 3, Intelligence Annex.

FIGURE 5.—Reconnaissance instructions.

---

---

---

**INTELLIGENCE INSTRUCTIONS  
FOR USE IN SERVICE SCHOOLS**

No. \_\_\_\_\_

To: \_\_\_\_\_ Effective \_\_\_\_\_ 194 \_\_\_\_\_

Maps: \_\_\_\_\_

---

---

REPORT ALL INFORMATION OF THE ENEMY AND IMPORTANT FACTS ABOUT THE TERRAIN WITH PARTICULAR ATTENTION TO THE ITEMS CHECKED (✓) BELOW.

Special Instructions

(AREAS AND ROADS TO BE OBSERVED, IF NOT INCLUDED IN UNIT'S NORMAL SECTOR OF OBSERVATION. SPECIAL INTELLIGENCE ACTIVITIES. HOUR AND DESTINATION OF REPORTS.)

---

1. RAILROADS—Traffic densities, detrainments.

2. CONCENTRATION AREAS.—Location, strength and composition of troops, activities, movements into, movements from.

3. ASSEMBLY AREAS—Location, strength and composition of troops, activities, movements into, movements from.

4. MOVEMENTS ON ROADS—Time, location, nature, direction, speed, strength and composition or length of columns, destination.

5. MOVEMENTS ACROSS COUNTRY—Time, location, nature, speed, strength and composition or length of columns, destination.

6. UNITS IN CONTACT—Position occupied; strength, composition, identification and attitude of the hostile units; reinforcement, weakening.

7. INFANTRY AND CAVALRY WEAPONS—Type, location, activities.

8. ARTILLERY—Location, number of batteries, calibers, fires, movements, type (towed or self propelled).

9. RESERVES—Location, strength, composition, movements.

10. TANKS—Location, numbers, type, movements.

FIGURE 6.—Intelligence instructions.



11. MECHANIZED UNITS (Except Tanks)—When observed, location, strength, movements, type, armament.

12. COMMAND POSTS—Location, movements. RADIO STATIONS—Location, size, protection, movements, changes in traffic.

13. RECONNAISSANCE ACTIVITIES — Air, ground.

14. EXTENSION OF FLANKS—Location, strength and composition of occupation, defensive works, including tank obstacles, mine fields, location of AT guns.

15. DEFENSIVE WORKS—Location, nature, work in progress, including tank obstacles, mine fields, location of AT guns.

16. DEMOLITIONS AND OBSTACLES—Location, nature, work in progress.

17. PERSISTENT GAS—Nature of chemical, when and where used, method of projection.

18. SUPPLIES — Accumulation, removal, destruction, activities of trains.

19. ESTABLISHMENTS—Location, nature, movements.

20. NEW POSITION—Location, organization, occupation.

21. TERRAIN—Fordability of streams, condition of crossings, condition of roads, obstacles to cross-country movements, concealment.

22. AIR FIELDS—Location, size, condition of suitable airfield locations.

23. TANK DESTROYER UNITS—Time observed, location, strength, movements, type, caliber.

24.

25.

By command of \_\_\_\_\_

OFFICIAL:

\_\_\_\_\_  
*A C of S, G-2*

\_\_\_\_\_  
*C of S*

This form is intended primarily for use at the service schools to insure uniformity in instruction in the formulating of orders to be issued to reconnaissance agencies. It is included in this manual to serve as a reminder to staff officers regarding the various elements of information which reconnaissance agencies may be instructed to obtain. This form must not be used as a substitute for carefully thought-out original orders. Additionally, it may serve as a supplement to paragraph 3, Intelligence Annex.

FIGURE 6.—Intelligence instructions—Continued.

■ 34. CONTROL.—Because of the distances at which detachments and patrols operate from their respective squadron and troop command groups and the fact that the relative rates of advance of the various subordinate units may be accelerated or impeded by terrain, road net, or enemy action, there must be a predetermined plan for controlling and coordinating their forward movement.

a. Commanders achieve this control by designating phase lines or unit objectives to be reached and passed at specified times, and by periodic reports and checks. Phase lines should be well-defined terrain features such as rivers, railroads, highways, or prominent ridge lines, and should be successively spaced by a 1- to 2-hour time distance. (See fig. 7.) In the absence of a well-defined terrain feature it is necessary to designate individual unit objectives approximately the same time-distance from a previous phase line.

b. Coordination with adjacent detachments and patrols is furthered by lateral contact on phase lines or at designated contact points, and by periodic radio communication.

■ 35. COMMUNICATION.—a. The reconnaissance operations of the squadron, regardless of how brilliantly executed, are useless if the information obtained is not received by the division in time to be exploited. It is also true that the efficiency of the squadron is greatly increased when the division sends forward pertinent information gleaned from other sources.

b. A detailed study of communication within cavalry reconnaissance units is contained in chapter 3, FM 2-35 (when printed).

c. The organization of the organic radio sets of the reconnaissance squadron into nets is illustrated in appendix II.

d. The potential value of mechanized reconnaissance elements as radio intelligence agencies should be exploited. The amplitude modulated radio sets used in armored cars, when equipped with suitably calibrated directional loop antennae, can be used as radio locator stations. When such antennae are not issued, they can be improvised by the radio electrician. Since these cars, on normal missions, are in advance of friendly main forces and usually are in closer

proximity to the enemy, they are well situated to attempt the location of active hostile radio sets operating from enemy command posts, observation posts, patrols, or radio jamming stations, without materially deviating from or delaying the

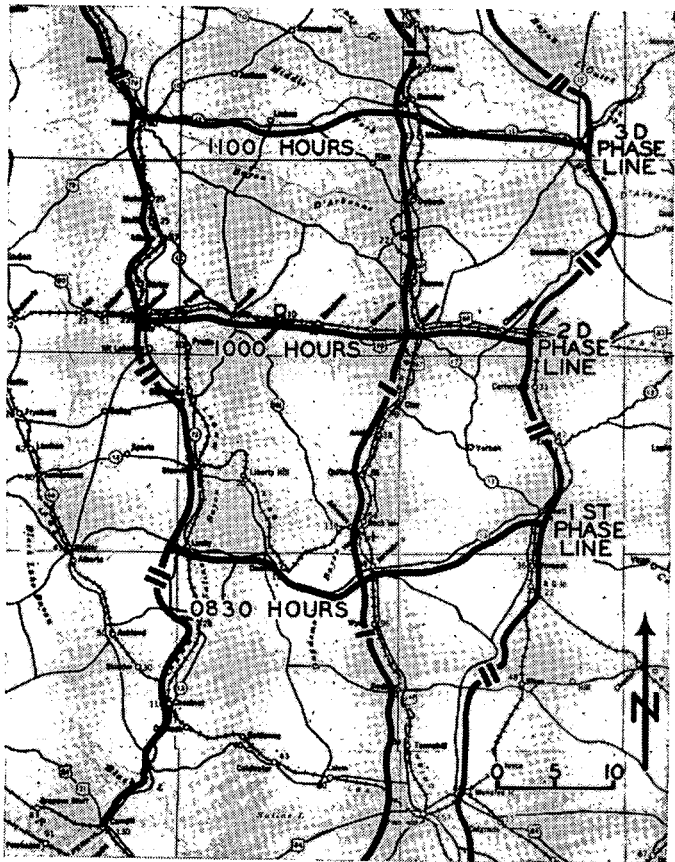

FIGURE 7.—Phase lines should be well-defined terrain features and should be successively spaced by a 1- to 2-hour time distance.

accomplishment of the assigned mission. Two or more armored cars of a reconnaissance troop, using the distance between themselves as a base line, can establish reasonably accurate location of another station by means of triangulation.

■ 36. EXECUTION OF DISTANT RECONNAISSANCE.—Distant reconnaissance is the term used to indicate the information-gathering operations of a reconnaissance element performed beyond the practicable supporting distance of its parent organization. In the case of the reconnaissance squadron, this distance may vary from 50 or 75 miles to 150 or more miles.

a. Before contact with the enemy in force is made, the action of the squadron is characterized by its rapidity. Close or detailed examination of terrain is subordinated to the more urgent consideration of gaining contact with hostile main forces at the earliest practicable moment. Hostile patrols operating in the squadron's zone of advance are avoided if possible and their presence and location reported. If such units cannot be evaded, they are attacked with determination, using all available force, and either destroyed or brushed aside.

b. As the squadron approaches contact with the main force, its advance will be slowed by the enemy's efforts to deny observation. The strength, composition, and aggressiveness of these counterreconnaissance elements are clues to the capabilities and intentions of the enemy and should be reported. The reconnaissance activity becomes more intensive as the squadron commander seeks to define the enemy's contour and secure identifications. Bold action by patrols will more frequently than not produce the best results, but it should be tempered by the realization that more detailed and aggressive missions will be assigned as the division closes on its objective and the strength of the reconnaissance means must not be dissipated prematurely. The methods employed change and approach those used in close reconnaissance.

■ 37. EXECUTION OF CLOSE AND BATTLE RECONNAISSANCE.—a. The action of the squadron becomes progressively more aggressive and intensive when the division closes to within sup-

porting distance. It is in this phase that the division commander must secure the items of information which he needs to complete a picture of the enemy on the given terrain and perfect his final plan of action. Such items include disposition and flanks, artillery positions, centers of signal communication, command posts, and tank concentrations. It is to be expected that hostile counterreconnaissance will become stiffer as the situation develops.

(1) As opposition to reconnaissance increases, the support troop is employed more frequently to assist the advance of a reconnaissance troop; as a spear head to penetrate the enemy screen and allow passage of a reserve reconnaissance troop; or platoons may be detached to reinforce separate reconnaissance troops. In a situation involving cross-country operation, it may be necessary to assign a reconnaissance mission to the support troop or one of its platoons.

(2) As the situation dictates, the antitank platoon, the pioneer and demolition platoon, and either one reconnaissance troop or a reinforcing detachment from the division may be combined as a task force to contain hostile reconnaissance or security units while the remaining troops of the squadron maneuver around their flanks and continue close reconnaissance. (See fig. 8.)

b. As regimental reconnaissance and security elements, preceding their respective columns in the approach march, make contact with elements of the reconnaissance squadron, they gradually take over the close-in reconnaissance. The squadron may be ordered into division reserve or it may be directed to execute battle reconnaissance around the enemy flanks and to his rear, seeking out supply installations and routes, location and movements of reserves; advance landing fields, and other important installations. (See fig. 9.) If ordered into division reserve, the squadron commander or his executive should remain at the division command post where he can keep informed of developments and formulate plans for the future employment of the squadron.

■ 38. RECONNAISSANCE AT NIGHT.—The efficiency of the squadron operating on reconnaissance at night is greatly re-

duced and such employment, except on roads, will be exceptional. Vehicles are highly susceptible to ambush. Reconnaissance across country, except under most favorable terrain and weather conditions, is slow and laborious. Usually night reconnaissance uses vehicles for movement to

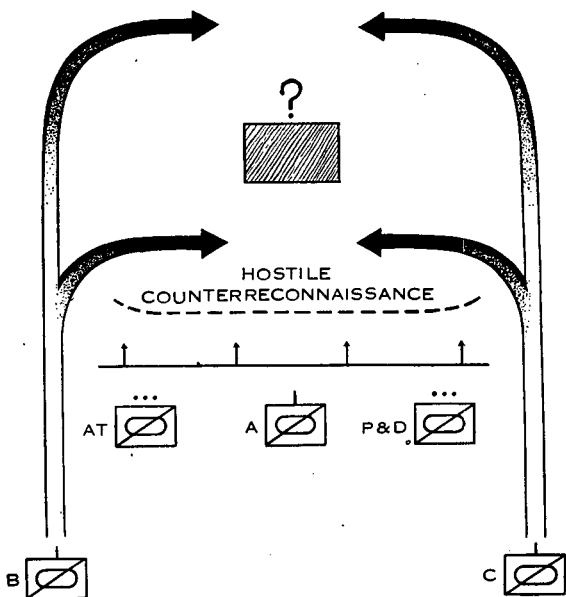

FIGURE 8.—The situation permitting, hostile counterreconnaissance is contained with part of the force while the remainder of the squadron maneuvers around its flanks.

an area where dismounted patrols operate (see TF 7-275) and return to rendezvous with their transportation. The technique of night reconnaissance by small mechanized pa-

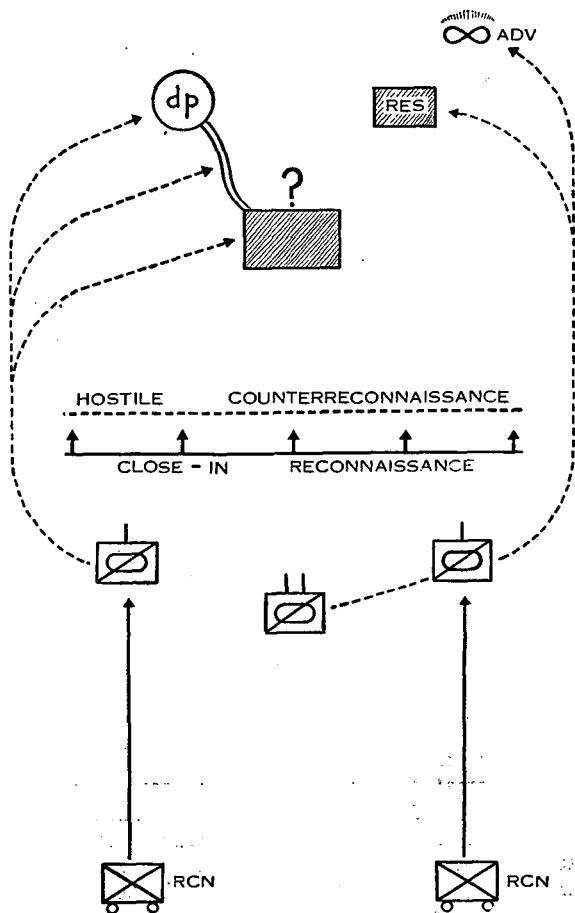

FIGURE 9.—Battle reconnaissance seeks out the enemy flanks, supply installations and routes, location and movement of reserves, and advance landing fields.

trols is described in FM 2-20 (when printed). When the division contemplates movement at night, the squadron should be sent out during daylight to a line beyond the expected division bivouac location where it establishes observation during the hours of darkness to warn of enemy movements that might interfere with the march or bivouac of the division.

### SECTION III

#### SECURITY

■ 39. **GENERAL.**—The principles of security as prescribed in FM 100-5 are applicable to the reconnaissance squadron as a unit. Security within the individual reconnaissance troop is described in FM 2-20.

■ 40. **WHILE MOVING.**—*a.* When the squadron is executing a reconnaissance mission the patrols, operating at a distance from the main body, provide a warning system against ground and air observation and attack.

*b.* Protection of the main body from surprise attack is accomplished by the employment of an advance guard and, when the situation requires, flank and rear guards. When approaching combat cross-country, security is provided by a covering detachment.

(1) *Advance guards.*—When the support troop is a part of the main body, one of its platoons with one or more reconnaissance sections attached normally will form the advance guard. In the absence of the support troop, such security will be provided by a detachment from one of the reconnaissance troops. The advance guard will include ¼-ton trucks as point and advance party vehicles and tanks or armored cars in the support. The size of the advance guard varies from a small fraction to about one-fourth the available strength, depending upon the tactical situation and the immediate size and composition of the main body. The distance at which the advance guard marches is limited by two considerations: it must be far enough to protect the main body from hostile small-arms fire and the direct fire of anti-tank weapons; it must be within supporting distance of the main body.



(2) *Rear guards.*—The size and composition of rear guards are similar to those of advance guards. In determining the size of a rear guard, consideration should be given to the fact that it can expect no support from the main body. It must be far enough to the rear to eliminate the possibility of being driven in on the main body. It must be close enough to prevent hostile elements in force from interposing between itself and the main body.

(3) *Flank guards.*—Flank guards for the squadron normally are composed of elements from a reconnaissance troop. Due to the increased mileage incident to flank guard operations, it is generally not desirable to employ support troop elements. Exception to this will occur when the route of the flank guard traverses ground unsuited to wheeled vehicles or when there is a well-defined threat, such as might be the case when the squadron on battle reconnaissance is passing around the enemy flank.

(4) *Covering detachments.*—Covering detachments employed by the squadron normally are composed of reconnaissance elements. For details of operation, see FM 2-20 (when printed). The use of tanks, except to cover the advance of the support troop when it has been assigned a definite combat mission, is not desirable because such employment may reveal the presence of a tank unit and thereby lose the chance for surprise.

c. *Antiaircraft weapons* in all elements of the squadron are alerted for antiaircraft fire at all times. Whenever overhead cover is available, units will attempt to escape detection by concealment. When observed and attacked by hostile aircraft, all possible small-arms fire should be brought to bear on the attackers. If aerial threat develops during operations in open country, the best security is effected by dispersion of vehicles, off the road, if possible, or by extending the column to increase the distance between vehicles. Columns with a distance of from 200 to 300 yards between vehicles present an unremunerative target because they force airplanes to attack each vehicle separately.

■ **41. WHILE HALTED.**—When the reconnaissance squadron halts, it provides for its security by establishing outposts.

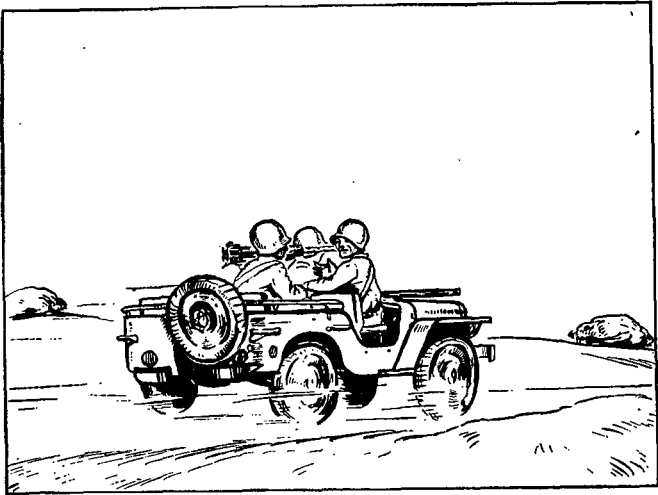

① Wrong.

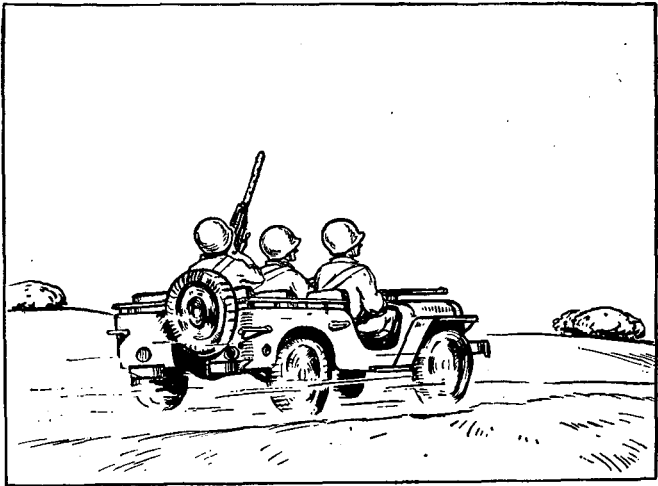

② Right.

FIGURE 10.—Antiaircraft weapons are alerted for antiaircraft fire at all times.

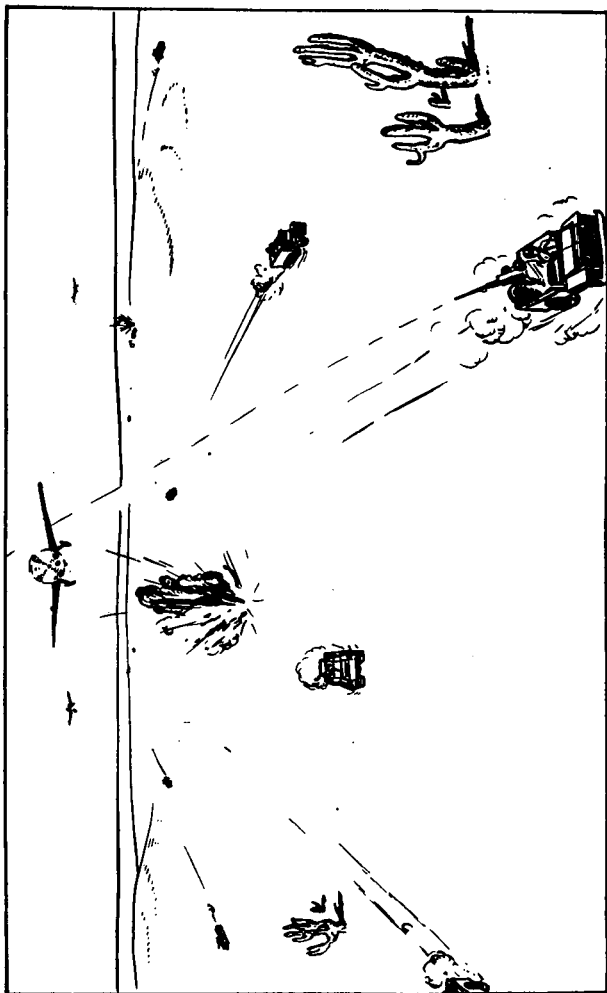
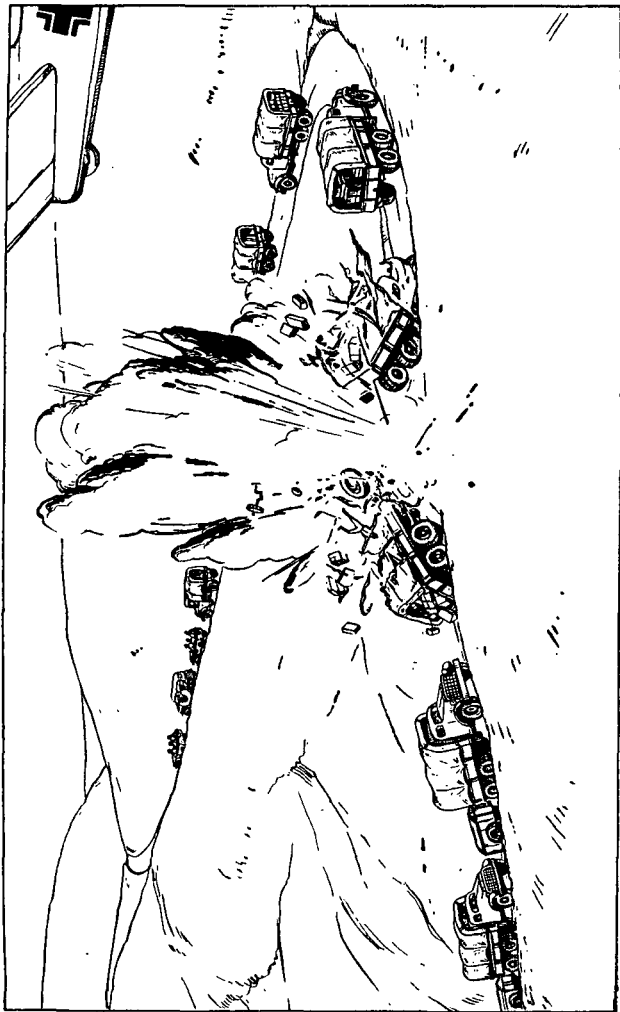
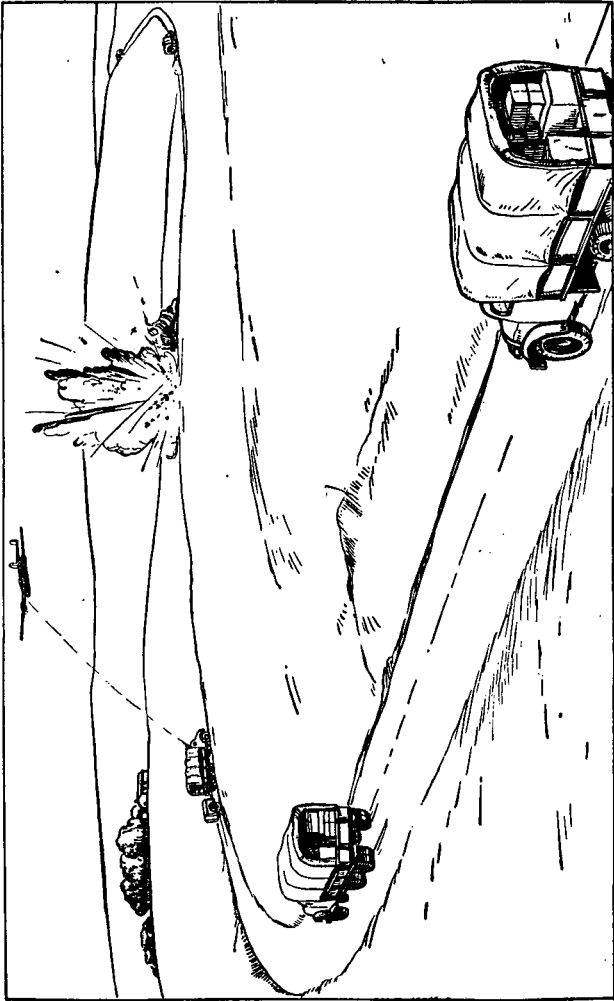

FIGURE 11.—In open country, the best security is effected by dispersion of vehicles.



① Close columns increase the hazard from air attack.

FIGURE 12.



© Open columns force airplanes to attack each vehicle separately.  
FIGURE 12—Continued.

The position in relation to both friendly and hostile forces that the squadron invariably will occupy while on a tactical mission increases the possibility of its being attacked from any direction. It must, therefore, habitually provide for all-around security.

a. The security measures taken by an individual reconnaissance troop while halted are described in FM 2-20 (when printed).

b. During a temporary halt to rest, or to refuel or eat, the marching security detachments (advance guards, rear guards, and flank guards) establish a march outpost consisting of observation posts at commanding points. (See fig. 13.) During a halt at least one member of each vehicle remains in his vehicle to observe and to man its major armament. Details of the security measures to be observed at halts should be contained in the unit's standing operating procedure and the establishment of march outposts should be automatic. If there is a critical terrain objective adjacent to the halt site, a combat patrol will be sent to cover it. During halts of any length full use is made of all available cover and concealment. (See FM 21-45.)

c. For protracted halts, such as bivouacs, outposts usually are detailed from the support troop. The outpost disposition is dependent upon the existing situation and terrain. An all-around warning system of observation posts comprising air lookouts and sentinels is established. Obstacles are installed to block avenues of approach open to mechanization. Armored vehicles are placed and their weapons laid so as to defend these obstacles. Other armed vehicles and dismounted machine guns are placed so as to cover other avenues of approach. (See fig. 14.) All vehicles take advantage of available cover and concealment and, if necessary, improve their position by means of camouflage. Bivouac areas selected must give more than one exit. Routes leading out of the area are reconnoitered. Movements into, out of, and within the area are restricted and tracks made are obliterated. While the outpost is being established, march outposts provide security.

d. On terrain which affords little or no concealment, such as deserts, bivouac security demands special consideration.

(1) In daylight or bright moonlight, the squadron forms a dispersed bivouac maintaining generally the same formation as when moving. Intervals and distances between vehicles may be extended to 300 yards or more. Particular care is taken to avoid lines of vehicles. Armored vehicles

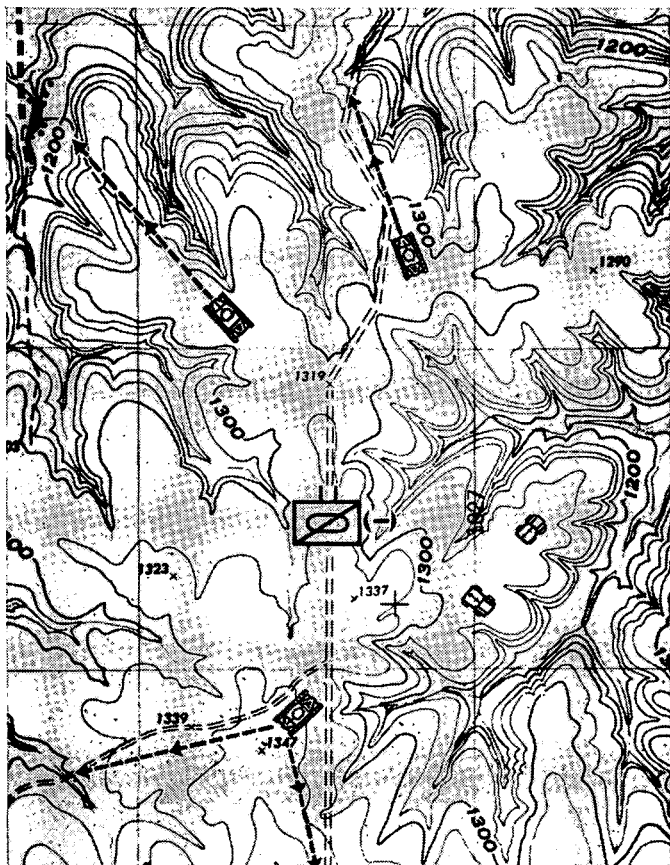

FIGURE 13.—During a temporary halt, march outposts cover likely avenues of approach.

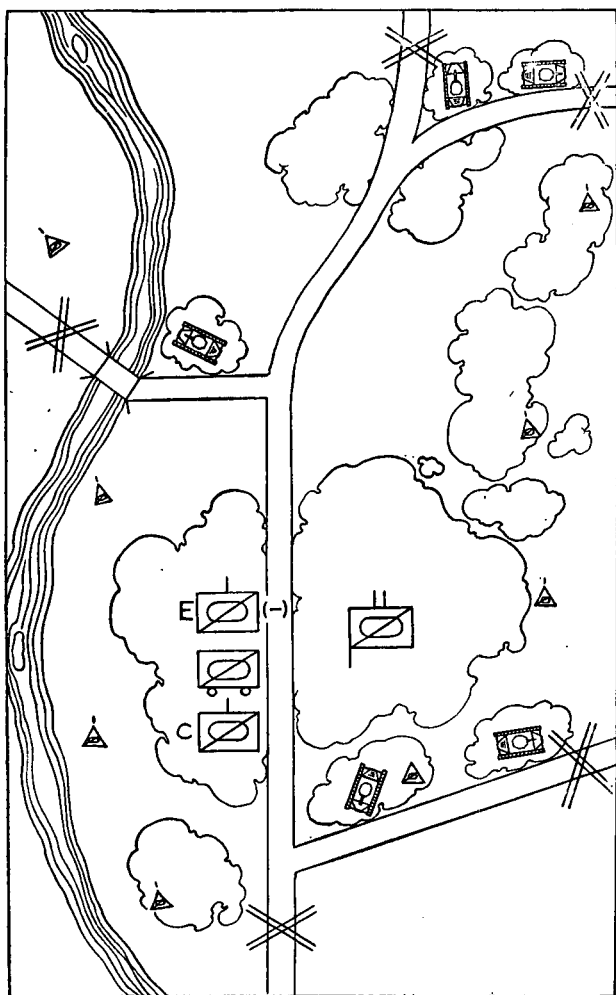

FIGURE 14.—In bivouac, security measures must include air look-outs, sentinels, defended obstacles covering avenues of approach, cover and concealment for and dispersion of vehicles within subordinate element areas.



are placed to provide an all-around defense; 37-mm guns and anti-aircraft weapons are manned at all times. Patrols of radio-equipped  $\frac{1}{4}$ -ton trucks or armored cars are sent well out to give warning of hostile ground attacks.

(2) The squadron forms a closer bivouac for protracted halts in darkness. A hollow triangle or square is formed of tactical vehicles surrounding the supply, service and unarmored command vehicles, with all facing the direction in which they are to move in the event of a night alarm. The interval between vehicles should be 40 to 50 yards. The formation which affords the most even distribution of armor and fire power and which will least disrupt the unity of troop organizations is a triangle each side of which is formed by a reconnaissance troop reinforced by a tank platoon and one antitank section. Night listening posts are established at sufficient distance from the bivouac to give warning of ground attack. Because of the necessity for radio silence, communication is restricted to messengers and patrols between listening posts and the main body. At dawn the squadron adopts an appropriate daylight formation.

e. When operations are halted and troops are required to remain in tactical disposition, individual troops cover their sectors by means of combat outposts. The action of the several outposts is coordinated by the squadron commander. Contact with the enemy must be maintained.

■ 42. TRAIN SECURITY.—The problem of protecting the movement of trains varies according to the disposition in a given situation. The motor maintenance element of each troop always remains with the troop. However, the combat trucks and kitchen trucks of the various troops may march with their respective troops or they may be grouped in a squadron train.

a. When troop service vehicles are marching with their respective units, the unit provides security.

b. When vehicles are grouped in a squadron train, special security measures must be observed.

(1) A medium-range radio set in the squadron supply and administrative platoon includes the trains in the squadron warning system. The passage of information by hand signals

from truck to truck should be standing operating procedure, and one man should be on the alert in each truck at all times.

(2) Passive security measures will include dispersion (see par. 40), use of cover, concealment, and speed. Since, as a general rule, the danger of a mechanized or air attack is in direct proportion to the amount of time the vehicles are exposed, they should move at the maximum rate of speed compatible with safe operation. Recent experience in theaters of operation has proved that vehicles moving in column at a distance of 300 yards have been able to reduce casualties by sharply increasing and decreasing speed within the column when attacked by aircraft. In the desert, trains move in dispersed irregular formation with intervals and distances of from 100 to 300 yards. Line and column formations must be avoided. Protection must be provided by combat vehicles on the front, flanks, and rear of the formation. Antitank and antiaircraft weapons normally should move on the flanks.

(3) Weapons mounted on vehicles should be manned continuously during marches, but gunners should be cautioned against firing at enemy airplanes unless certain that their vehicles have been sighted.

(4) When danger of attack is great, it will be necessary for the squadron to provide additional means of security for the trains. Such antitank weapons as are available for train defense should be combined with  $\frac{1}{4}$ -ton trucks mounting antiaircraft guns to form groups of concentrated fire power operating as advance and rear guards. Areas such as narrow defiles, which are especially likely objectives for mechanized or air attack, should be organized defensively by security detachments. (See fig. 15.)

■ 43. SECURITY FOR OTHER ELEMENTS.—*a.* While operating on its most normal mission of reconnaissance, the squadron performs an incidental mission of security by protection of the main body from surprise. The presence, strength, composition, and direction of movement of enemy ground and air forces encountered are reported as a matter of standing operating procedure so that the division commander may make early preparation to meet the enemy threat. How-

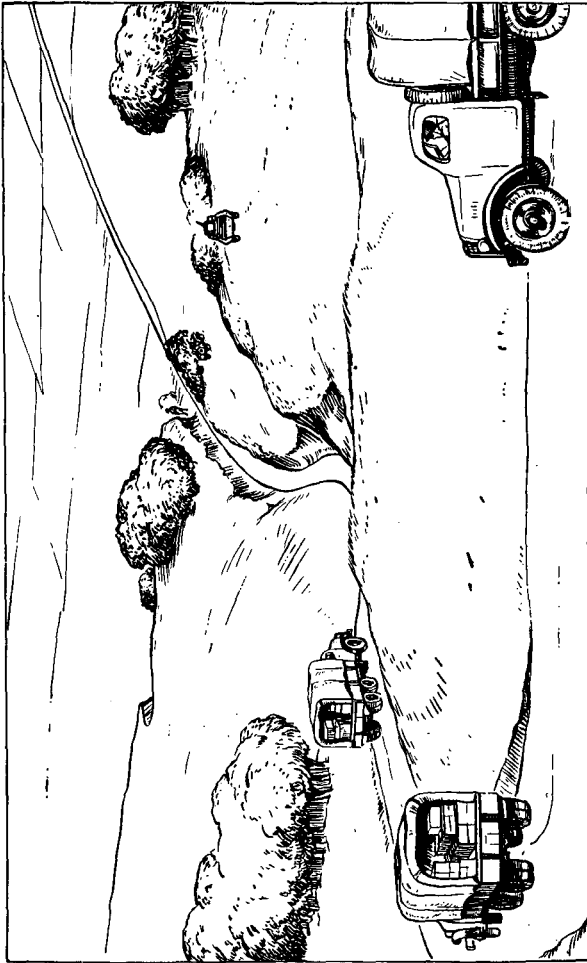

FIGURE 15.—Train security elements cover the movement of supply vehicles through defiles.

ever, time and space may cause the division commander to order an additional and temporary mission for the squadron to oppose the hostile force, in which case it executes another phase of security—delay to allow the main body time to dispose itself to engage the enemy. The reconnaissance squadron does not take the place of an advance guard. While the squadron may be given security missions, it should never be used as the advance guard for the division.

b. When it becomes necessary for the division commander to assign a primary mission of security, the operations of the squadron are typical of cavalry. Reconnaissance tactics are employed to gain and transmit timely information of the enemy. The other elements (support troop, antitank platoon, pioneer, and demolition platoon) cooperate with the reconnaissance elements and, using the technique of harassing and delaying action, block the routes of hostile approach to gain time for the main body.

■ 44. COUNTERRECONNAISSANCE.—Counterreconnaissance is a form of security in which a command prevents hostile observation of or interference with its own or supported main forces. A moving counterreconnaissance screen, seeking to cover a movement, acts offensively to destroy enemy reconnaissance detachments and patrols. A stationary screen is defensive in character and is intended to deny enemy reconnaissance of troop concentrations or an area.

a. The squadron is capable of executing counterreconnaissance in a zone 15 to 20 miles wide. Normally the squadron will divide the zone between two detachments consisting of a reconnaissance troop each. According to the situation, support platoons and elements of the antitank platoon and pioneer and demolition platoon may be attached. The detachment commander sends out patrols on a broad front, retaining the bulk of his striking power in reserve prepared to move rapidly in support of the patrols. The advance of patrols is regulated by movement from one coordinating line to another. The squadron, less detachments, follows its detachments within supporting distance and coordinates their advance.

b. The dispositions of the squadron in a stationary screen are not dissimilar to those in a moving screen. The front of the position is covered by patrols and reserves are located so as to be able to support them rapidly. Advantage is taken of terrain; obstacles are constructed and demolitions prepared. As always, obstacles are defended.

#### SECTION IV

#### MARCHES, HALTS, AND BIVOUACS

■ 45. MARCHES.—a. The reconnaissance squadron rarely will execute tactical marches as a unit. If it does move as a part of a larger force, the squadron normally will march as a serial and the troop will be the march unit. Details as to the conduct of such marches are contained in FM 25-10. When the squadron marches alone as a unit it establishes reconnaissance and security measures appropriate to the situation.

b. Normally the squadron moves with two troops operating on a broad front embracing a number of axial roads, while squadron headquarters, reserve elements, and trains follow a centrally located route. Movement is by bounds, and as a general rule, the length of bounds increases with the size of the unit. Patrols make short bounds from one terrain feature to the next. The squadron, less detachments, advances from one phase line to the next.

c. In open terrain where no road net or only a few trails exist, as in the desert, movement usually will be across country. Formations must be irregular with vehicles echeloned and dispersed in width and depth. Intervals and distances must never be less than 100 yards and may be extended to 300 yards. The absence of roads, trails, and landmarks makes control and maintenance of direction difficult and requires the use of special equipment and methods. (See par. 64.) Prominent terrain features, if present, are used as coordinating lines. In the absence of such landmarks, movement is coordinated by marching measured distances on a predetermined compass bearing. When units are able to move in columns on roads, a traffic density of 10 to 15 vehicles to the mile should be maintained.

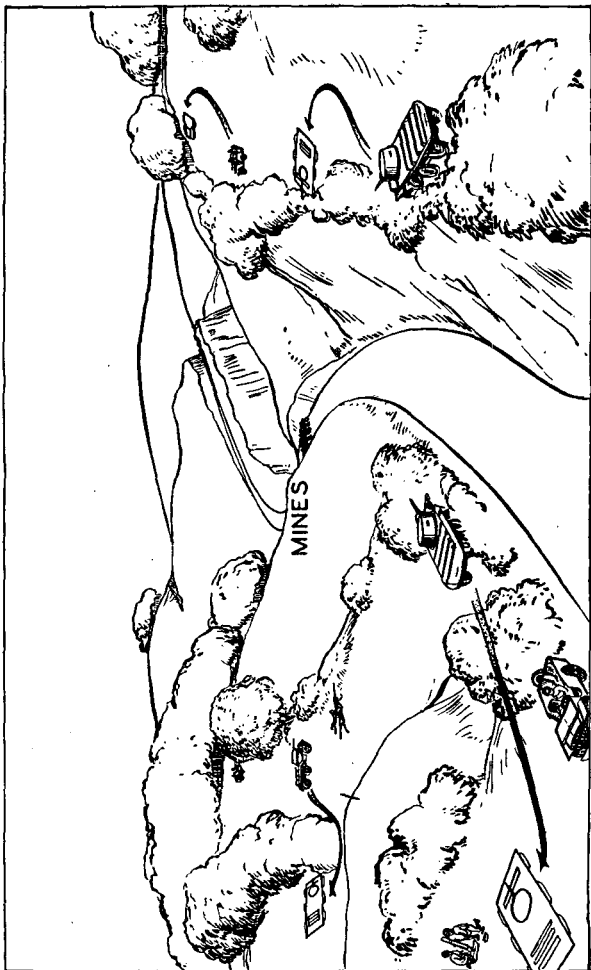

FIGURE 16.—Road blocks are defended. Weapons are laid to cover routes of approach. Alternate positions are selected for vehicles.

■ 46. HALTS.—*a.* The locations selected for halts should be those which offer the most protection from hostile observation and fire. When no overhead concealment is available, accidents of the terrain which offer protection from direct fire should be sought. (See fig. 17.)

*b.* When halting, vehicles should clear the road whenever practicable. (See fig. 18.) Every effort is made to conceal vehicles by placing them under trees or in shadows. When natural concealment is not adequate, it is improved by means of camouflage as described in FM 21-45. (See also FM 2-20 (when printed), 5-20, and FS 5-3 and 5-10.) The security measures observed during halts in the desert are the same as those for bivouacs in the desert. (See par. 41*d.*)

■ 47. BIVOUACS.—*a.* The principles of concealment and cover considered in the selection of halt sites are applicable equally in determining the location of a bivouac area. Other considerations involved, but subordinate to security, are sanitation, the comfort of troops (see FM 21-10), and facility of supply. The area selected is reconnoitered, divided into troop and platoon areas, and guides are posted to direct units to their positions. Dispositions within desert bivouacs are described in paragraph 41.

*b.* Subordinate units within the bivouac area take protective measures as described in FM 21-45. The squadron commander checks on the effectiveness of these measures.

*c.* The disposition of units within the bivouac area should be that which will facilitate the continued tactical operation of the squadron. (See fig. 19.) Security is covered in paragraph 41.

## SECTION V

### COMBAT

■ 48. GENERAL.—*a.* The fundamental methods of both offensive and defensive combat, together with their military terminology, are explained in FM 100-5. This section deals with the application of these principles by the cavalry reconnaissance squadron.

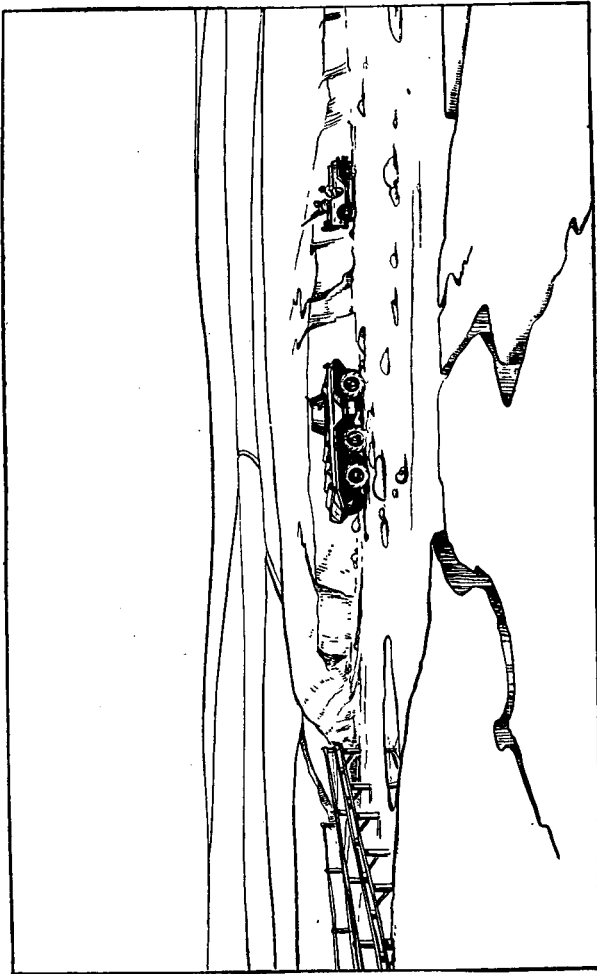
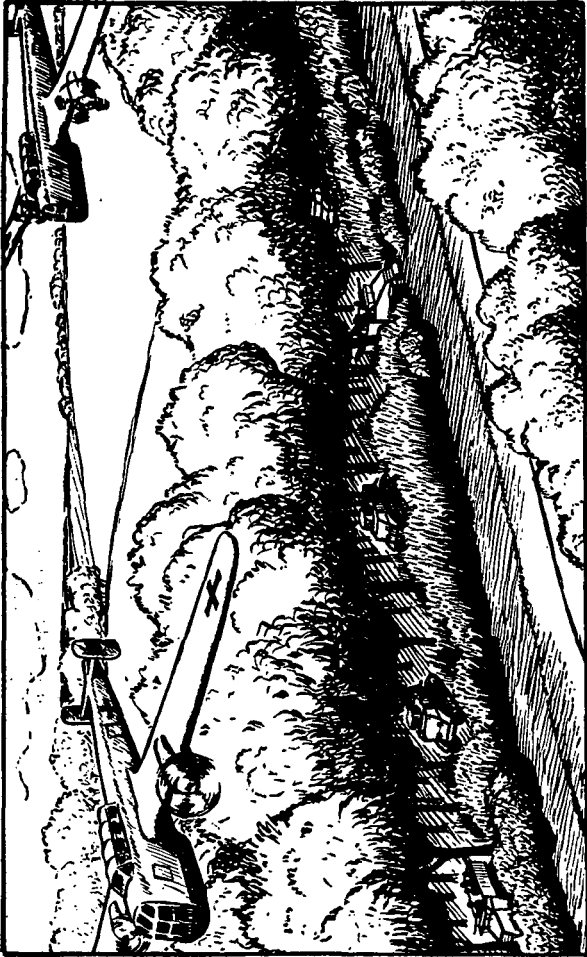

FIGURE 17.—When no overhead concealment is available, accidents of terrain which offer protection from direct fire should be sought.





① Vehicles should not close up on the road.  
Figure 18.—When halting.



© Vehicles should take advantage of available concealment.

FIGURE 18.—When halting—Continued.

b. It is to be expected that the squadron must fight at some time in the execution of any mission it may be assigned. In either an offensive or a defensive situation, the action of the squadron is marked by the bold execution of a sound plan. The tempo of the typical situation demands quick appreciation of terrain and rapid formulation of a plan that will fully exploit it to bring about the most effective combination of fire and movement.

■ 49. EMPLOYMENT OF RECONNAISSANCE PLATOONS AND TROOPS.—Combat by subordinate reconnaissance elements is described in FM 2-20 (when printed).

■ 50. EMPLOYMENT OF THE SUPPORT TROOP.—The support troop is provided to increase the striking power of the reconnaissance squadron and enable it to operate with greater aggressiveness.

a. The tank possesses favorable characteristics of great fire power, protection to crew, crushing power, shock, and mobility. However, its mobility is limited by the following terrain features:

- (1) Ground covered with large stumps and boulders.
- (2) Heavy woods.
- (3) Swamps.
- (4) Steep slopes, especially those which afford loose or slippery footing.

b. The tank being essentially an offensive weapon it follows that the primary mission of the support troop is to attack. The tank attack seeks to break up organized resistance by destroying hostile automatic weapons; disrupting communication; overrunning command posts, mortar, and artillery positions; and impeding the movement of reserves. Since the attack of positions strongly organized in depth is beyond the capabilities of the squadron and therefore rarely will be attempted, the support troop normally will be assigned limited objectives. Pursuit is restricted beyond that which is necessary to prevent hostile reorganization of the position.

(1) Before an attack, the troop will occupy an assembly position where final preparations are made for the attack. Platoons occupy the area in such manner as will allow them

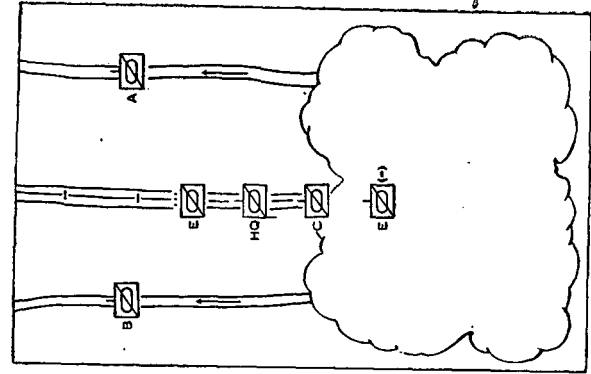

(a)

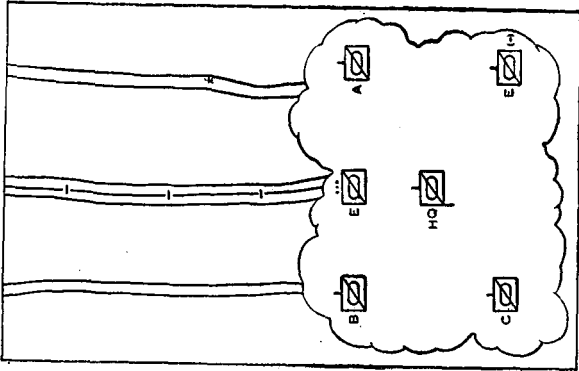

(b)

FIGURE 19.—Disposition of units within a bivouac area should facilitate continued tactical operation.

to move directly to attack positions without passing through other units. Final orders are issued and ammunition, fuel, and oil are replenished. Security measures are taken to protect against hostile ground and air observation. Obvious exceptions to the use of an assembly position occur when the troop repels a surprise counterattack or when it attacks directly from march column.

(2) Figures 22 and 23 illustrate basic attack formations for the platoon and troop. Any combination of platoon formations may be used in any one of the basic troop formations. Column formation affords the optimum in ease of control and power for sustained effort as compared with line formation.

(3) The advance to the objective is effected by a combination of fire and movement in which platoons move by bounds or by leapfrogging. In leapfrogging, the first platoon covers the movement of the second platoon until the second is in position ahead of the first; then the second covers the movement of the first to a position ahead of the second. In moving by bounds the first platoon covers the advance of the second platoon to a position on the same general line with itself, then the first moves to a new position supported by the fire of the second. Leapfrogging is comparable to a man's stride—movement by bounds to a series of paces each taken with the same foot leading. The advance of tank elements across country is described more fully and illustrated in FM 17-30 and 17-32.

(4) Targets for tank elements, in order of priority, are antitank guns, artillery in position, armored vehicles in position, moving armored vehicles, automatic weapons, and personnel. The technique of tank operations against these targets is described in detail in FM 17-30.

(5) When time and space demand that the support troop attack from march column, orders to platoons, based on a rapid estimate of the situation, are issued by radio and the situation is developed as rapidly as possible. Unarmored troops are attacked quickly and, if possible, overrun before they can organize the ground to any appreciable extent. If opposed by armored vehicles of comparable armament, a

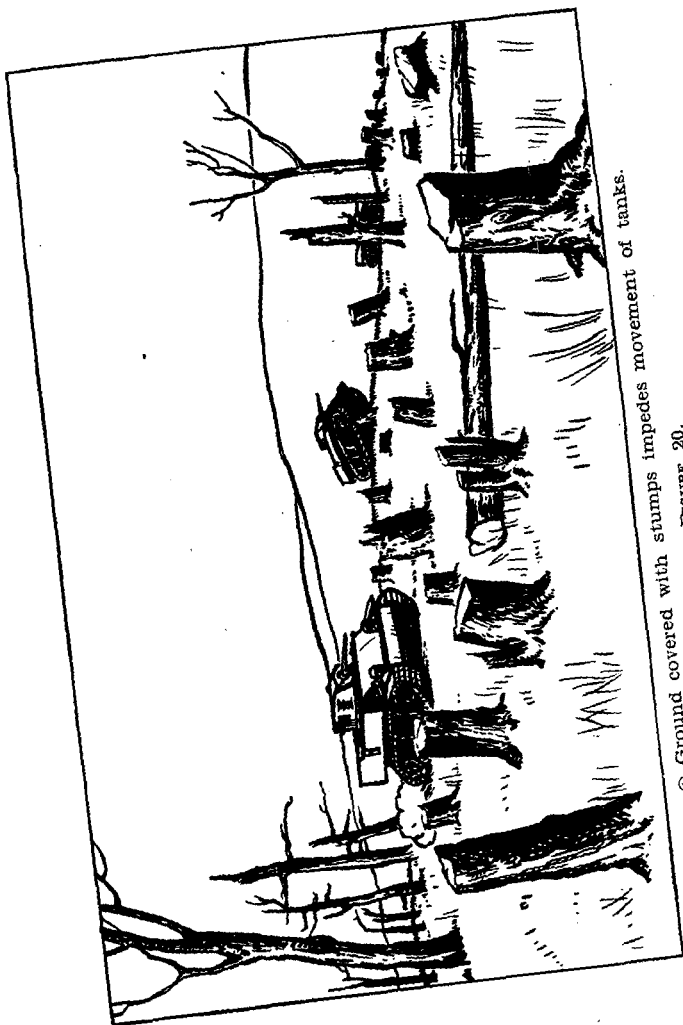

① Ground covered with stumps impedes movement of tanks.  
FIGURE 20.



③ Boulders restrict the movement of tanks.

FIGURE 20—Continued.

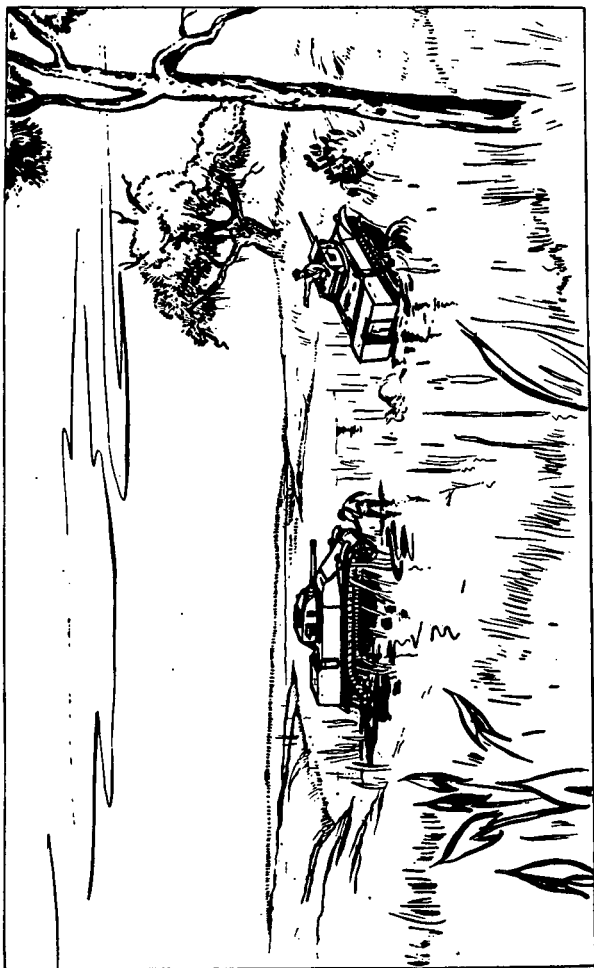

③ Swamps should be avoided.

FIGURE 20.—Continued.



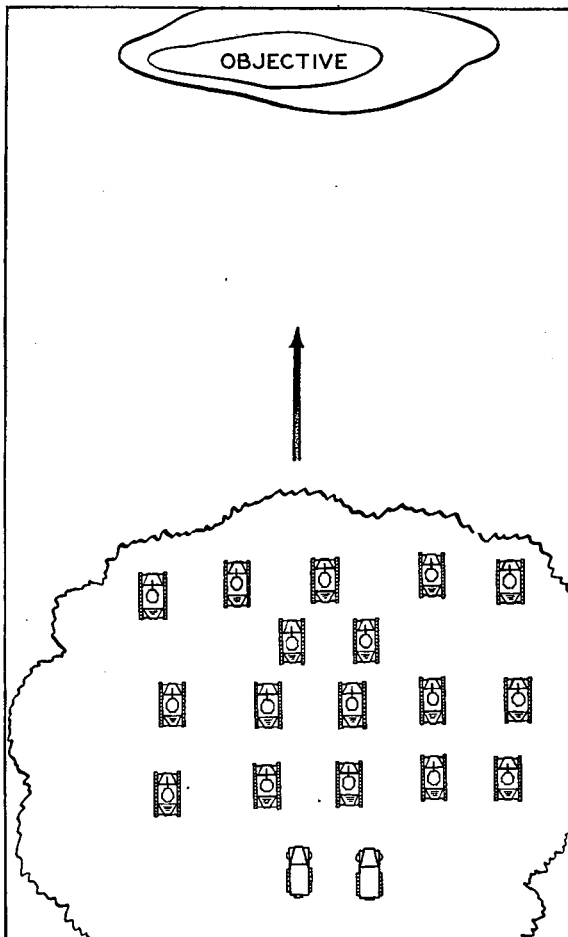

- ① Platoons occupy an assembly area in such a manner as will allow them to move to the attack, without passing through other units.

FIGURE 21.

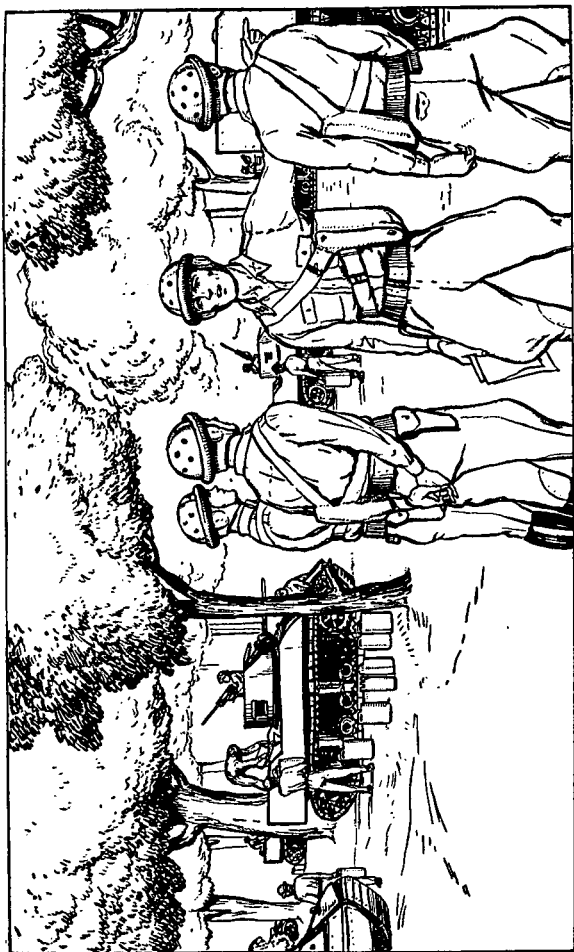

③ In the assembly position final orders are issued, and ammunition, fuel, and oil are replenished. Security measures are taken.

FIGURE 21—Continued.

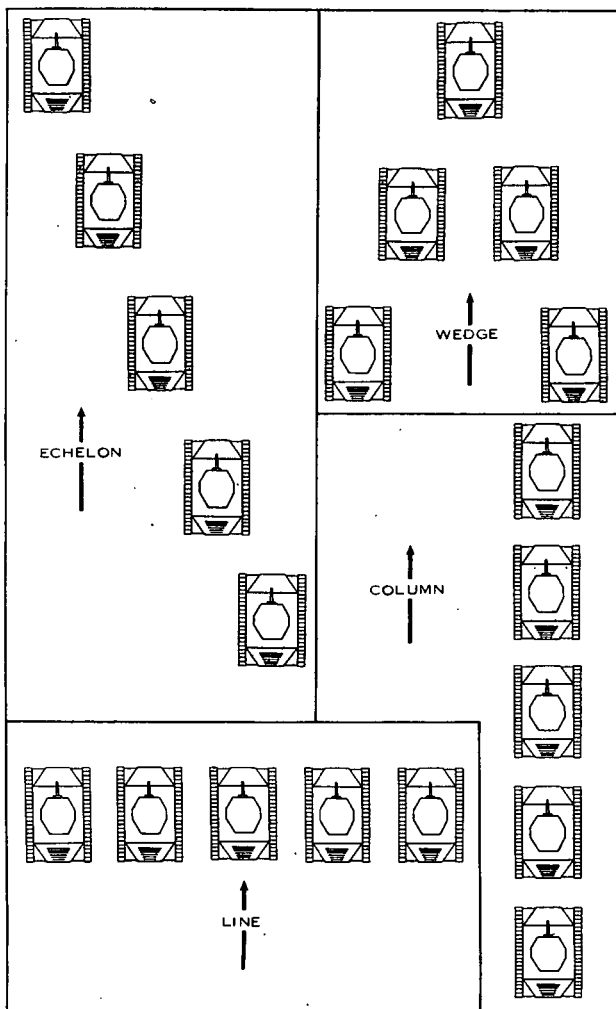

FIGURE 22.—Basic attack formations for the support platoon.

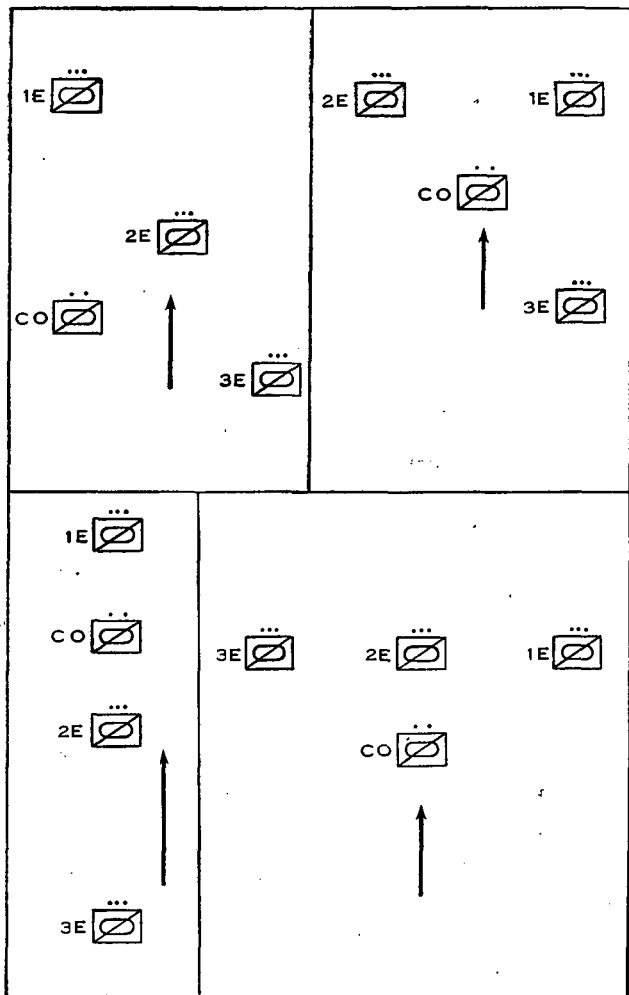

FIGURE 23.—Basic attack formations for the support troop.

small part of the troop or the squadron antitank platoon may be used to contain the hostile force while the main strength maneuvers to bring maximum fire to bear.

c. In defense, the support troop is used offensively to execute counterattacks. Tanks should not be used as stationary pill boxes except as a last resort. (See par. 54.)

d. In the execution of delaying actions, the support troop operates offensively against the hostile flanks and rear or is held as a mobile reserve and employed to prevent enemy encirclement of the flanks of the delaying force. Opportunities to employ ambush tactics are sought and exploited.

■ 51. OFFENSE.—The cavalry reconnaissance squadron may engage in offensive combat as an incident in the execution of any mission which it is assigned. On reconnaissance, individual patrols will have frequent engagements with hostile groups. (See FM 2-20 (when printed).) The squadron may find itself opposed by a counterreconnaissance screen around whose flanks it cannot side slip and be confronted by the necessity of executing a penetration. A point usually will be reached at which it will be necessary to attack a covering force in order to develop so much of a situation as will reveal the strength and attitude of the enemy. Although generally it is not considered wise to dissipate the highly specialized reconnaissance squadron on a strictly combat mission, factors of time, space, and the current location of the squadron may force the division commander to direct the squadron to seize a key terrain point or delay the enemy to gain time for the division to reach a given point and dispose itself to engage the hostile force. The reconnaissance squadron applies the fundamentals of offensive combat in the manner dictated by the capabilities and limitations of the organization, equipment, and armament. When sustained combat is anticipated, the squadron must be suitably reinforced.

a. The outstanding combat characteristics of the squadron are its great fire power and extreme mobility. The potential of these assets is greatly reduced when the squadron fights dismounted. The most desirable situation is one wherein the principle of fire and movement can be applied by the rapid transfer of fire power *in vehicles* with one unit supporting

by fire the maneuver of another until a position is reached from which hostile opposition can be overcome by coordinated fire or overrun in a short, swift assault. Terrain is the most influential factor in determining how fire power will be applied in a given situation.

(1) Irregularities of terrain favor one unit supporting, by fire from defilade, the movement of another unit to a position from which the latter can develop its fire power. (See fig. 24.)

(2) Fire from moving vehicles generally is ineffective. However, when an attack must be made over open ground it may be necessary to fire while moving. In such a case units are dispersed as widely as possible to bring fire from several directions.

b. The normal cavalry attack will take the form of an envelopment of one or both flanks. When factors of terrain, enemy disposition, limitation of time, or possibility of surprise argue against an envelopment, the most effective form of attack may be a rapidly executed penetration.

c. In the attack the elements of the squadron are distributed to form a main attack force, a secondary attack force, and a reserve. (See FM 100-5.)

(1) The main attack force normally will be composed of the support troop and such additional reconnaissance elements as the situation may necessitate. In order to reap the full measure of shock and crushing power accruing from mass, the support troop should be employed as a unit. Reconnaissance platoons and troops assigned to the main attack force act as a mobile base of fire in direct support of the tank unit. (See fig. 25.) Personnel from the pioneer and demolition platoon may accompany the main attack and be used to reduce obstacles and remove or explode mines and booby traps. (See fig. 26.)

(2) The secondary attack establishes the base of fire on which the scheme of maneuver of the squadron as a whole is built. (See fig. 27.) Initially it will include all combat elements not assigned to the maneuvering element or elements and reserve. Maximum fire power will be concentrated by employing the antitank platoon and the mortar squads of reserve reconnaissance platoons.

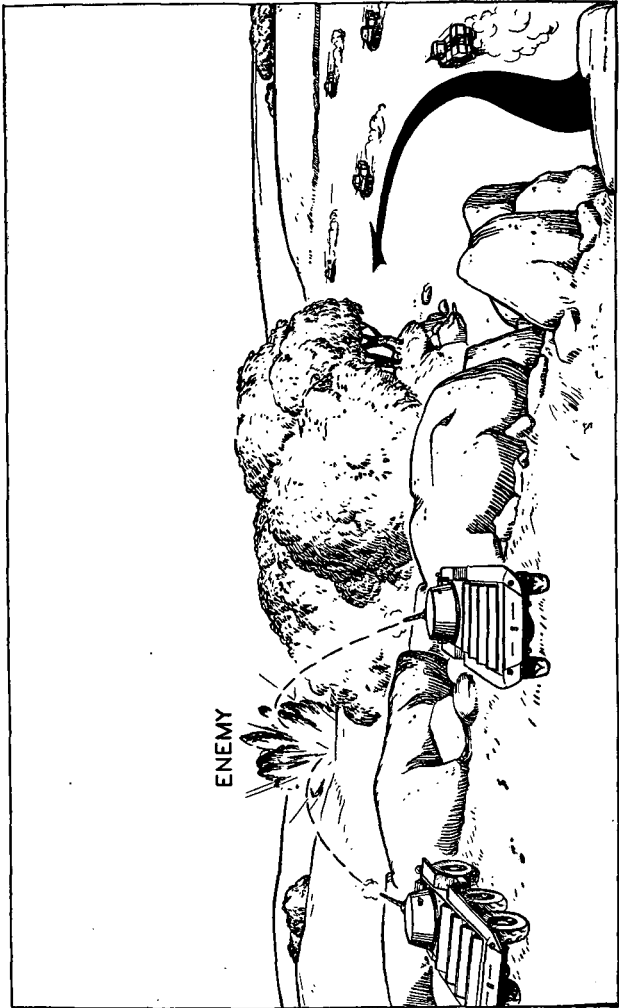

FIGURE 24.—One unit supports another by fire from defilade.

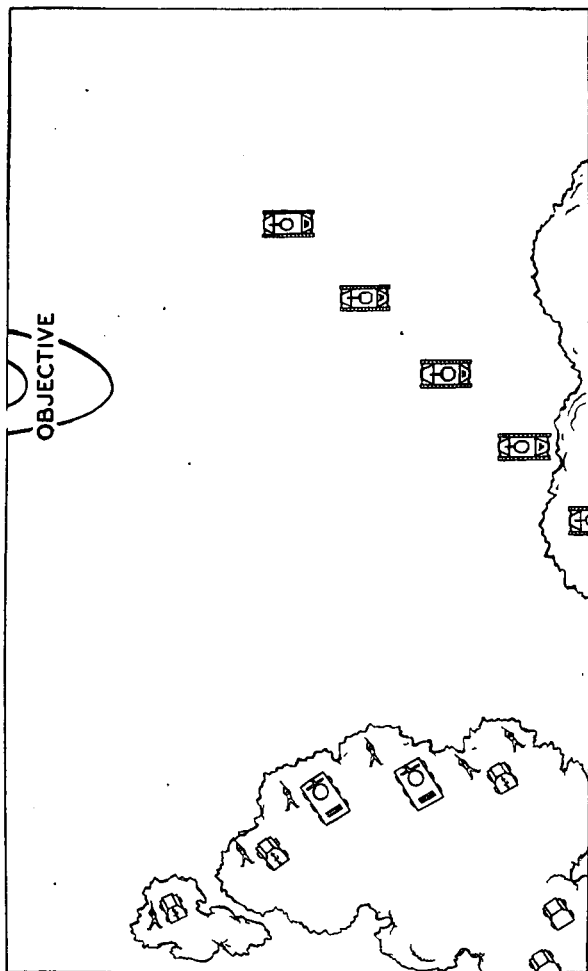

FIGURE 25.—Reconnaissance elements assigned to the main attack force act as a mobile base of fire in direct support of the tank unit.





Figure 26.—Pioneer and demolition personnel may accompany the main attack to reduce obstacles and remove mines.

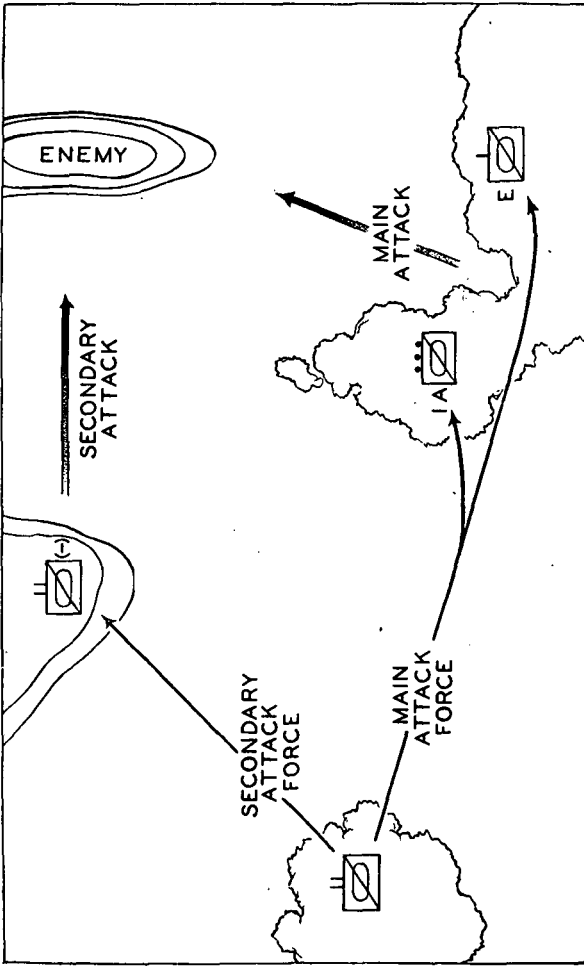

FIGURE 27.—Secondary attack establishes the base of fire on which the scheme of maneuver is built.

(3) A reserve is held out initially by the commander to counter an unpredictable development of the situation or to influence the final result of the action. The strength of the reserve normally will vary in size from a reconnaissance platoon to a reconnaissance troop. The strength required varies in direct proportion to the strength of enemy mechanized elements and antitank weapons. When the reserve is committed to action, a new reserve must be constituted without delay.

*d.* The fire of all weapons must be coordinated in order to achieve maximum efficiency. The most remunerative target for each type weapon must be understood; the effects of the various fires fully appreciated; and finally, all weapons be given definite, appropriate fire missions with a minimum of avoidable duplication. In other words, the right tool should be used on the right job with no more force employed than is necessary.

(1) The machine gun is the basic fire support weapon. Light machine guns are used to kill the hostile soldier or to pin him to the ground so that he cannot use his weapons with deliberate effectiveness. The caliber .50 machine gun, though intended primarily as an antiaircraft weapon, may be used effectively against light matériel such as machine guns, mortars, and unarmored and lightly armored vehicles.

(2) The 37-mm gun is essentially an antimechanized weapon. Its characteristics of high velocity and flat trajectory limit its fire to direct laying. Being permanently mounted in its vehicle, it can be moved quickly from point to point and can open fire with a minimum of wasted time. 37-mm guns will be disposed to protect the flanks and rear of the squadron against mechanized attack and also, in the base of fire, to support the attack. Armor-piercing ammunition is effective against mechanized vehicles, matériel, and weapons. High explosive ammunition is effective against personnel, light matériel, automatic weapons, and mortars. Hull-down positions should be sought in order to protect the vehicle.

(3) The fire of the 81-mm mortar is extremely effective against machine-gun positions, antitank guns, personnel in groups, and command posts. Frequently it may be used to lay

smoke *on the objective* to screen the movement of attacking forces. (See fig. 28.) The mortar squads of the reconnaissance platoons may be grouped in a provisional platoon under central control or left with their respective platoons.

e. The fact that the typical cavalry operation is characterized by speed, dispersion due to exploitation of mobility, and the initiative of subordinate commanders, tends to make control and coordination difficult. It is imperative, therefore, that application of practicable methods of control be perfected.

(1) The successful operation of any control method is based upon understanding between commanders and subordinates. A commander must study and know the capabilities of his immediate subordinates; how they will execute a given order, how they will react in a particular situation. On the other hand, the subordinate must study the personality and methods of his superior, know what is expected of him, and comply with the spirit as well as the letter of the order. When complete understanding and confidence exist between individuals, perfect teamwork can be achieved using any mechanical means of control. As a general rule the most simple plan will be the most successful.

(2) The initial order contains the essential elements of coordination and control. It should, if possible, be issued to assembled commanders at a point where the various terrain features can be pointed out on the ground. Objectives are given. The direction of attack is designated as an axis or as a thrust line. Assembly positions and, if necessary, intermediate assembly positions are assigned. Lines of departure will be designated and the time for clearing same be fixed at a definite hour, or made contingent upon a signal by messenger, radio, or visual means. Rallying and alternate rallying points are prescribed in order to expedite reorganization.

(3) When the individual unit is committed to the attack, the subordinate exercises his initiative in conformity with the general plan. The squadron commander exercises necessary control by means of messengers, radio and visual signals. Control procedure by means other than radio must be perfected, as it is to be expected that the use of radio often will

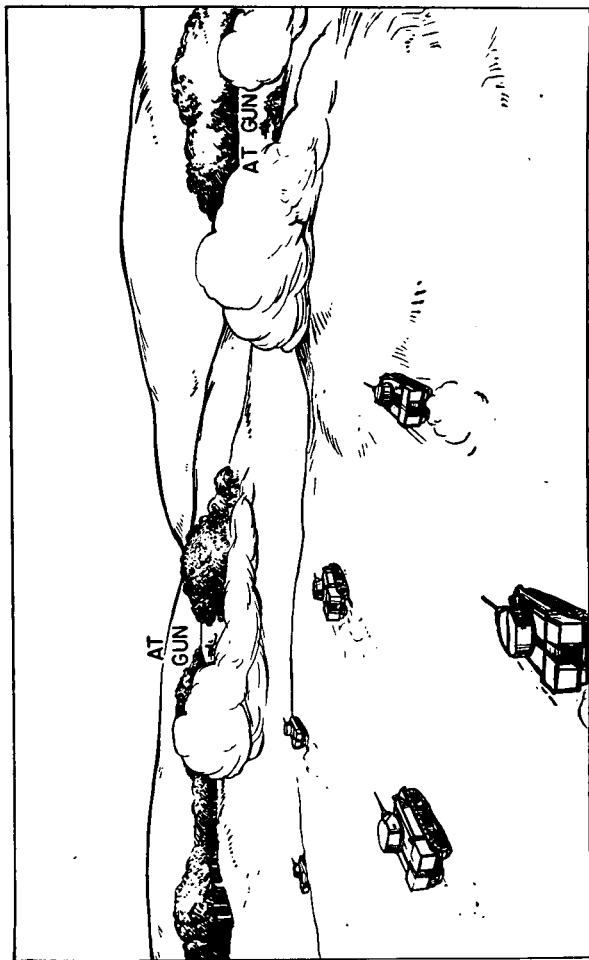

① Smoke may be used to blind hostile antitank gun crews.

FIGURE 28.—Use of smoke.

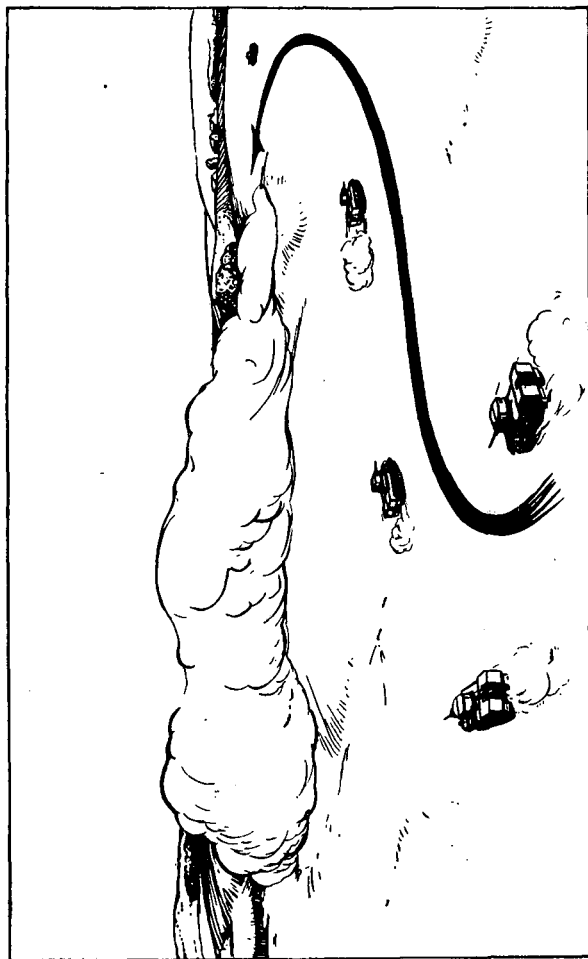

② Smoke is used to deceive the enemy as to direction of the attack.

FIGURE 28.—Use of smoke—Continued.

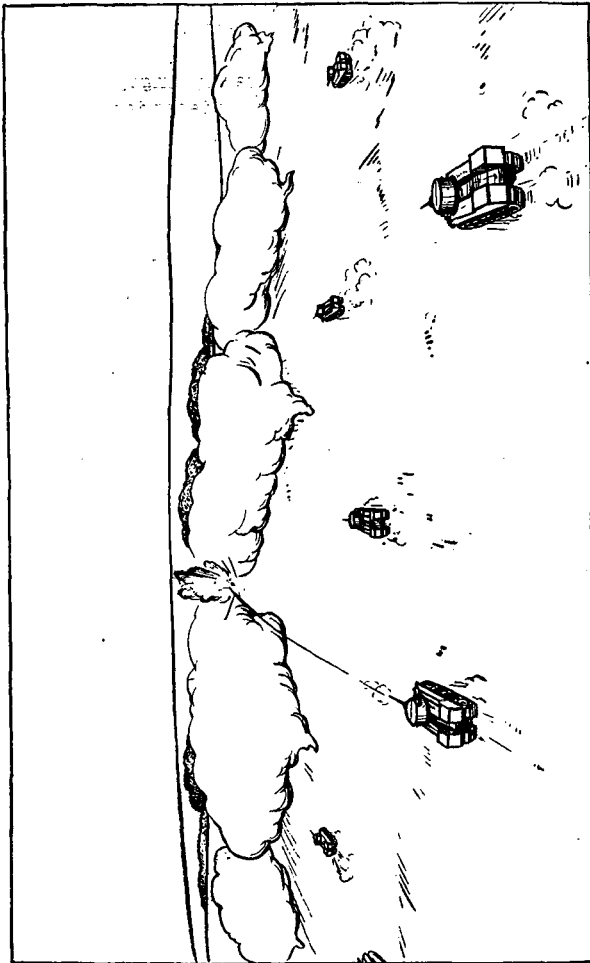

③ Smoke should be placed so that the wind will carry it toward the objective.

FIGURE 28.—Use of smoke—Continued.

be denied by the operation of mobile hostile radio jamming stations mounted either in vehicles or in aircraft.

■ 52. PURSUIT.—Pursuit is a development of offensive action. (See FM 100-5.)

a. The reconnaissance squadron rarely engages in other than limited pursuit following an independent offensive action.

b. When the division pursues, the squadron is used to envelop or encircle the enemy and arrest his retirement so that the division can close in and annihilate him. The squadron concentrates its efforts at bridges, defiles, and other critical points. When the retiring force is highly mobile, the faster reconnaissance troops move at maximum speed to complete the encirclement, while the support troop, with mission-type orders, moves parallel to the enemy's route making sudden and repeated harassing attacks for the purpose of slowing his rate of march and adversely affecting his morale.

■ 53. HARASSING ACTION.—Harassing action is a specialized form of the offensive in which a unit of relatively inferior strength executes surprise limited-objective attacks against a hostile force. Its purpose is to inflict damage without becoming closely involved and, by keeping the enemy always alerted, to exhaust him and lower his morale. The reconnaissance squadron is well suited for this type of offensive action. Depending on the terrain and the opposition expected, harassing detachments will be composed of reconnaissance troops reinforced by support platoons or composed of elements of the support troop reinforced by reconnaissance units. Mission-type orders are the rule.

■ 54. DEFENSE.—a. The reconnaissance squadron lacks the holding power to organize a defensive position in depth. In the course of its normal mission, it rarely will be necessary for it to execute a position defense and it should be specifically ordered to do so by higher authority only when an extreme situation so demands.

b. When reinforced by more suitable ground holding units a portion of the squadron's fire power may be assigned to



strengthen the position. The remainder of the squadron, always including the support troop, exploits its mobility in counterattacks and offensive operations against the hostile flanks.

■ 55. DELAYING ACTION.—*a.* Reconnaissance missions frequently will develop into delaying actions. The squadron, after having located the enemy and secured and reported the information needed by the division commander to plan his operations, may be given the mission of impeding the movement of the hostile force to gain the time and space necessary for the operation. When the division withdraws, the squadron may be ordered to delay hostile pursuit.

*b.* The two main combat characteristics of the squadron, fire power and mobility, qualify it as an effective delaying force.

*c.* The tactics used in delay are a combination of defensive and offensive, with the accent on the latter. Generally speaking, delaying action will take either one of two forms depending upon whether the enemy is advancing in column or on a broad front.

(1) In the first case, the squadron disposes itself to block the head of the column and attack its flank.

(*a*) The blocking force is similar in composition and function to the secondary attack of an envelopment. It is composed essentially of reconnaissance elements supported by the antitank platoon and the mortar squads of reserve elements. The pioneer and demolition platoon is employed to prepare demolitions and obstacles to impede or canalize the hostile advance.

(*b*) The support troop is employed to ambush and attack the flanks. Reconnaissance elements may be assigned to the attack force to support the tanks or they may be used to harass either enemy flank by a series of surprise fire attacks.

(2) When the enemy advances on a broad front, as might be the case when the division is executing a withdrawal, it may be necessary to occupy a delaying position from which the hostile approach can be opposed by fire at maximum effective range. Such a position would not be held to the

point where the squadron could not extricate itself without serious losses. The support troop, in such a situation, would be held in reserve prepared to counterattack, particularly against hostile flank attacks. In close country it may be necessary for the squadron commander to decentralize control by assigning sectors to reconnaissance elements reinforced by support platoons. These detachments should exploit opportunities to assist each other by flanking fire.

■ 56. WITHDRAWALS.—*a.* When the division seeks to disengage itself from action, the reconnaissance squadron may be employed to cover the withdrawal. This operation of the squadron entails two phases. (See fig. 29.) The first phase is one of reconnaissance and security to the division flanks. In the second phase, the squadron closes in behind the division where it may effect delay as described in paragraph 55, or operate as a security detachment. For this type of operation the squadron, when a part of the cavalry division, should have motorized artillery attached; when a part of the motorized division, self-propelled artillery or assault guns. In either case, engineers normally are attached to prepare obstacles.

*b.* It has been pointed out that the squadron avoids becoming so involved as to make extrication too costly. On the other hand, it should exploit each delaying position to the fullest extent. Obviously then, perfection of the technique of withdrawal is a prerequisite to efficient execution of delaying actions.

(1) Initially, control is decentralized to allow subordinates to extricate their commands in accordance with the dictates of their immediate situation. However, the squadron commander should be so familiar with the situation and exercise sufficient control to be able to order the withdrawal of subordinate elements before they become so closely engaged that they cannot withdraw. Central control is regained when units have assembled or have joined the march column.

(2) The squadron commander designates a covering force to cover the withdrawal of the whole command. This force withdraws on the instructions of the squadron commander and ultimately becomes the rear guard of the retiring column

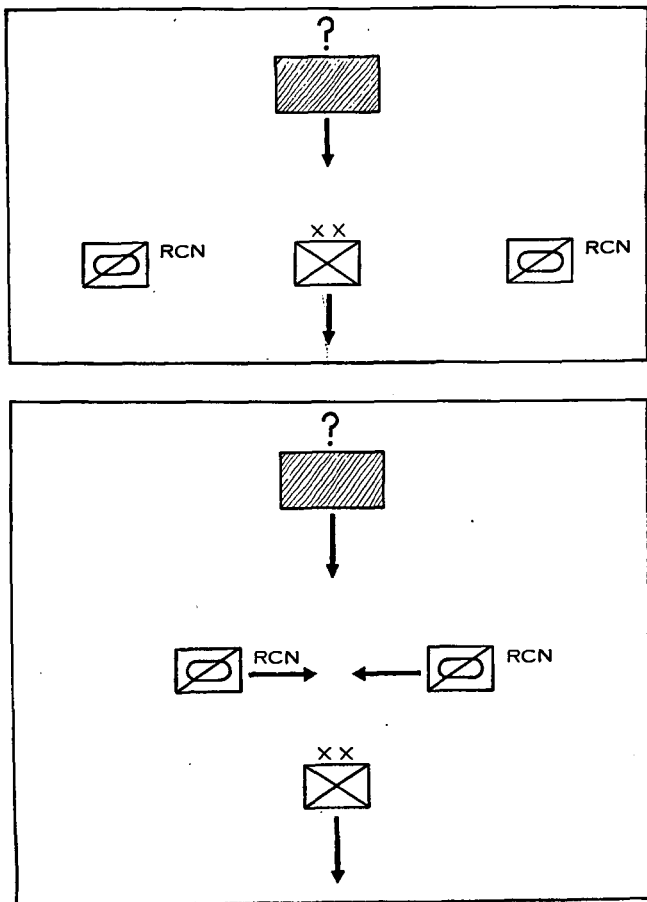

FIGURE 29.—When the division withdraws, the squadron reconnoiters to the flanks initially and then closes in behind the division.

or the outpost of the next delaying position. Subordinate units employ small local covering forces.

(3) The pattern of the terrain determines the order in which individual units are withdrawn. Troops holding critical terrain features which favor the covering of other elements should be withdrawn last. The units in the most difficult or hazardous positions are withdrawn first under the covering fire of the other element.

■ 57. ANTI-AIRBORNE DEFENSE.—The reconnaissance squadron is a highly effective agency in the scheme of anti-airborne defense as outlined in FM 100-5. Generally speaking, airborne troops in force will be used either ahead or to the flank of their enemy for the purpose of seizing and holding key terrain or behind it as a vertical envelopment. In either case, the squadron has an active role.

a. The squadron operating ahead of the division will, in all probability, be the nearest element to any point at which an air landing is attempted in the division zone of advance. The points at which such an enemy operation will be profitable should be as well known to friendly commanders as they are to the enemy and should therefore be expected. Long-range air reconnaissance may further reduce the element of surprise. Division G-2 should immediately warn the reconnaissance squadron commander of any airborne movements observed either in preparation or aloft. Being thus alerted, the squadron commander can plan how he will oppose a landing at any probable point in his zone.

(1) The reconnaissance commander encountering airborne troops in his zone must make a rapid decision based on the stage of the enemy development, relative strength, and the urgency of his primary mission. He may decide to attack, to contain the force until reinforced by the division, or to bypass and report the incident.

(2) If the commander decides to attack, the action is characterized by its rapidity and dispersion. Defense against light bombardment and fighter aircraft supporting the landing is accomplished by use of overhead cover, wide dispersion of vehicles, and fire of anti-aircraft machine guns. Parachutists, after they have jumped, and gliders and transports

making a landing approach should be fired on from the time they come within effective range until they are destroyed. Parachutists should be prevented, if possible, from reaching and opening the containers of heavy weapons dropped with them, and glider or transport prevented from unloading their heavy weapons. High explosive, 37-mm fire, is effective against gliders and transports on the ground. Weapon containers may be destroyed by gunfire or by the light tanks running over them.

b. When the squadron is in reserve it may be assigned the mission of defense against airborne attacks aimed at rear installations.

(1) The squadron commander, in cooperation with G-2 and G-3, makes preparation for the employment of his command. The squadron is included in the warning system or, if one has not been established, he assists in its creation and provides radio-equipped motor patrols. A reconnaissance of the rear area is made to discover and study likely objectives for airborne attack. Based on this study, plans are made for the employment of the squadron to include communication, priority on roads, and support by reserve elements of the division.

(2) The enemy planning to attack in rear of the division will take cognizance of the fact that the area probably is more or less organized for resistance and he will attempt deception by means of feints and demonstrations. One solution to this problem is to divide the rear area into three reconnaissance troop sectors, locating each troop in the position from which it can move most readily to the probable points in its sector. The squadron, less detachments, should remain in centrally located reserve prepared for rapid movement to any sector.

(3) The actual engagement of the airborne troops is as previously described.

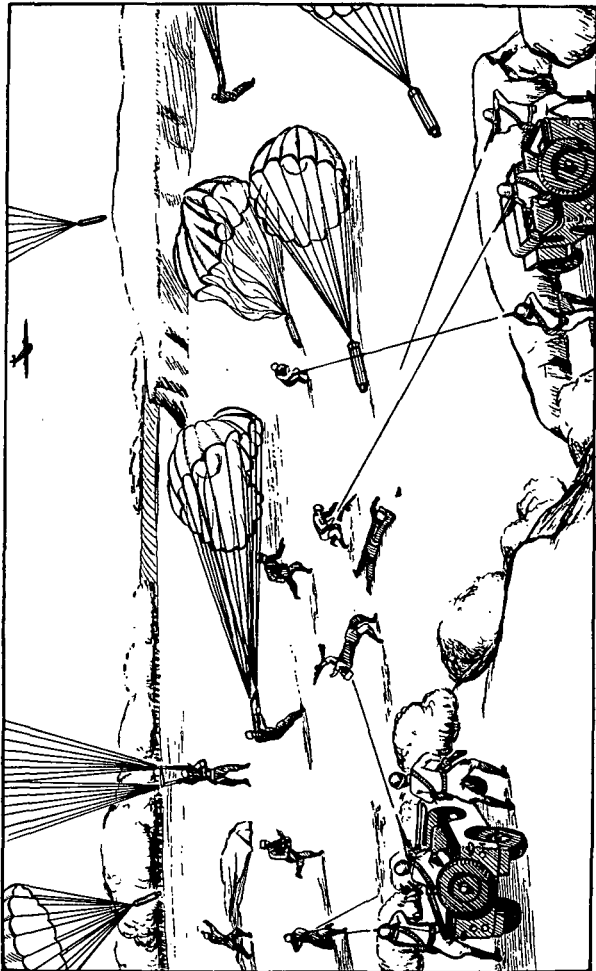

① Parachutists should be prevented from reaching and opening their weapon containers.

FIGURE 30.

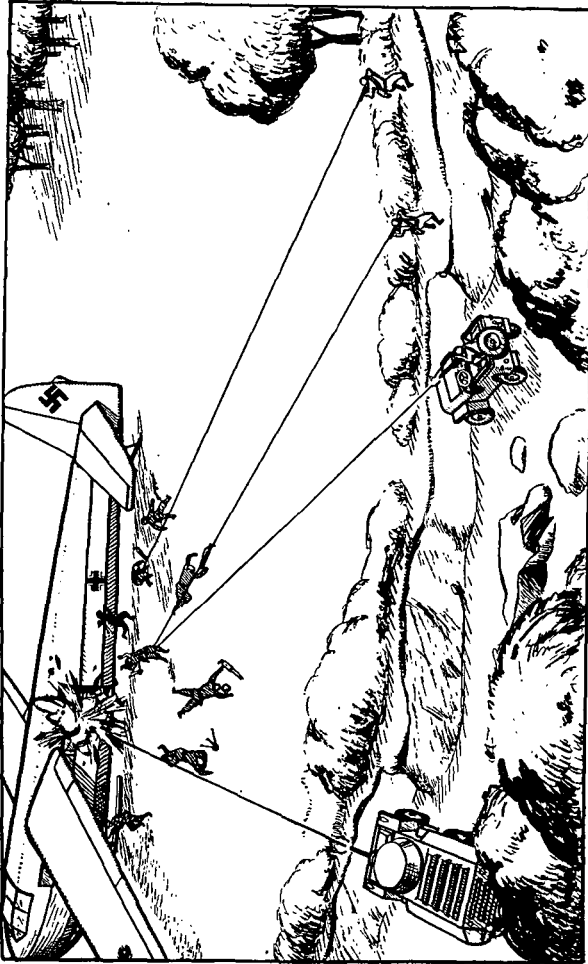

② High explosive 37-mm fire is effective against gliders and transports on the ground.

FIGURE 30—Continued.

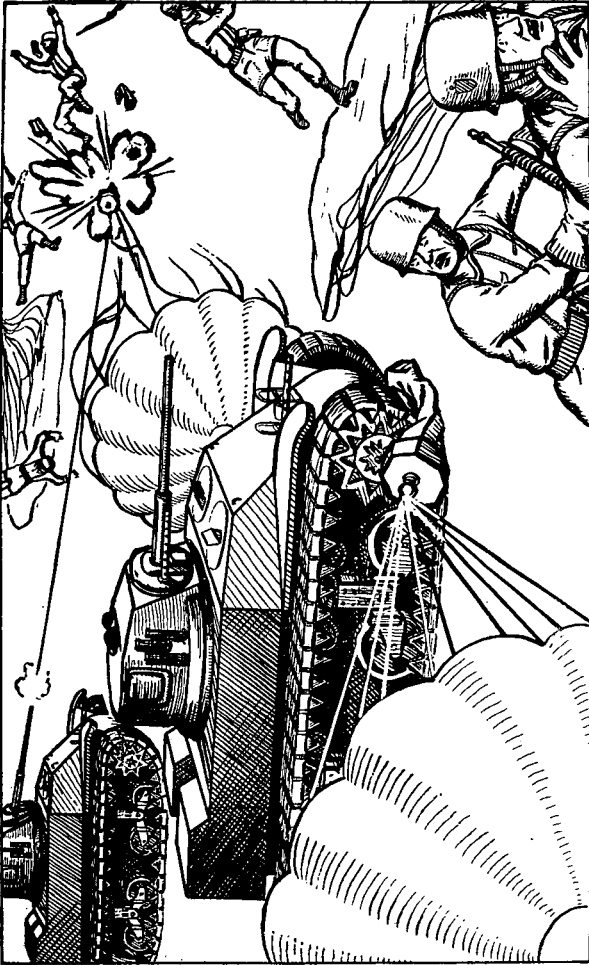

③ Weapon containers may be destroyed by gunfire or by light tanks crushing them.  
FIGURE 30—Continued.



## SECTION VI

## LOGISTICS

■ 58. **SUPPLY.**—The general doctrine of supply is expressed in FM 100-10. Current Tables of Basic Allowances prescribe the specific items of supply, the quantity of each, and the organic means of transporting them.

a. The Squadron S-4 consolidates troop requisitions for class II and IV supplies and the reports forming the basis for automatic issue of class I, III, and V supplies and is responsible for coordinating the flow of supplies from the division distributing point (DP) to troops.

b. The reservoirs of supply in the squadron are similar to those in the reconnaissance troop of the infantry division. The first reservoir is the ammunition, gasoline, oil, and rations carried on the individual soldier or vehicle. The second is transported in the service element of each troop; the third in the division quartermaster train.

c. Normal resupply of the squadron is accomplished by assembling the troop trains into a squadron train which moves to the rear and draws supplies from an advance division DP. In a situation where it is foreseen that the squadron will operate at extreme range and the division will not close on the squadron, it will be necessary for the division to attach additional transportation and issue another day of supply or establish forward truck heads or dumps.

d. Within the squadron, troop motor maintenance vehicles and combat trucks will accompany their respective troops. Kitchen trucks normally will be grouped in the squadron train. However, a troop operating at a distance from the squadron may retain its kitchen truck.

■ 59. **MAINTENANCE.**—The echelon system of motor maintenance is described in FM 25-10.

a. Troop motor maintenance sections perform troop second echelon maintenance for the vehicles of their respective troops.

b. The squadron performs squadron second echelon maintenance for the vehicles of the troops.

c. In tactical operations, a too strict adherence to the

echelon system of maintenance cannot be required. There is a need for initiative, intelligence, imagination, realism, and opportunism in addition to technical skill in the operation of the maintenance facilities. The inherent mobility of the squadron will be preserved only if all its personnel have a knowledge and appreciation of automotive maintenance and operation.

(1) It is desirable to bring disabled vehicles to the bivouac area of the maintenance platoon, but usually it is necessary for the squadron to send mechanics, tools, and parts to the disabled vehicle as a matter of expediency. (See par. 13.) Because of the limited quantity of replacement parts that can be carried, vehicle drivers, as well as unit mechanics, must continuously perform preventive maintenance as prescribed in FM 25-10 and TM 21-300.

(2) The scope of the work that the maintenance section and platoon can perform is limited more by the replacement parts that they can transport than by their organic tools and equipment. Therefore, consideration should be given to the fact that parts removed from a hopelessly disabled vehicle may be the emergency means of restoring to service several vehicles that otherwise would have been evacuated to rear echelons.

(3) The extent of work undertaken on a given vehicle is determined by the amount of work required on all vehicles. *Keep the maximum number rolling.*

d. The motor maintenance officer should be present at staff conferences so that he can have the earliest possible knowledge of future operations upon which to base his plan and prepare for the operation of his platoon. His plan will include—

- (1) Axis of maintenance.
- (2) Squadron support of troop maintenance sections.
- (3) Need for and use of personnel detached from the division echelon.
- (4) Supplies and replacement parts needed in addition to those habitually carried.
- (5) Method of reporting and locating disabled vehicles. (Probably SOP.)
- (6) Evacuation of vehicles.

■ 60. EVACUATION.—*a. Personnel.*—General instructions for the evacuation of personnel are contained in FM 100-10 and 8-10. The squadron medical detachment (see T/O 2-25) collects and arranges for the evacuation of squadron casualties. Two troop aid men from the medical detachment are attached to each combat troop during tactical operations. First aid is administered to casualties by vehicle crew members or aid men. If life or limb of the injured man will not be jeopardized by so doing, he may continue with his unit in order to avoid the deleterious effect on morale that abandonment may have. When it is impracticable to transport casualties after first aid has been given, they are made as comfortable as possible and their location is reported to the medical detachment.

*b. Prisoners.*—The disposition of prisoners is prescribed in FM 30-15. While it is desirable to evacuate prisoners rapidly for examination, reconnaissance elements will not interrupt operations to do so unless there is sound reason to believe that important information can be obtained from them. Prisoners in small numbers will be retained until transportation is available. A large number of prisoners will be placed under guard and their location reported.

*c. Captured material.*—Captured documents of importance are sent to the rear as soon as practicable. Captured matériel, equipment, stores, and transportation will be reported and then secured, rendered unserviceable, or destroyed as directed by higher authority. New types of matériel will be reported without delay and then be protected against deterioration or destruction as long as it remains in the possession of the capturing element.

*d. Vehicles.*—Evacuation of vehicles which the squadron maintenance platoon is not capable of repairing normally is a function of the division maintenance echelon. Such vehicles are left in the service park, or place where disabled, and the higher headquarters is notified of their location.

## SECTION VII

## SPECIAL OPERATIONS

■ 61. **ATTACK OF A RIVER LINE.**—The general subject of operations at river lines is covered in FM 100-5. The motorized division or the cavalry division acting as part of a corps forcing a river line may be either held back initially as part of a force with the mission of exploiting the penetration, or may be sent far to a flank to execute a feint, demonstration, or a crossing which will enable it to support the main attack on the far side of the river.

*a.* In the first case, the reconnaissance squadron will follow closely the force establishing the bridgehead and continue on to reconnoiter assigned zones and objectives. Close cooperation is maintained with the corps reconnaissance regiment.

*b.* In the second case, or when the division makes an independent attack of a river line, the operations of the squadron are more extensive.

(1) The squadron, with engineer reconnaissance parties attached, reconnoiters the river line to determine suitable crossing points and enemy dispositions. The organic amphibious  $\frac{1}{4}$ -ton trucks will be particularly valuable during this phase.

(*a*) The amphibians may be left with their respective platoons to be sent across singly or towing one or more  $\frac{1}{4}$ -ton trucks wrapped in paulins. (See fig. 31.) (See also FM 25-10.)

(*b*) In another situation it may be expedient for a troop to form its amphibians into a provisional four-car section for operation on the far shore or for the squadron to form an amphibious platoon.

(*c*) Additional dismounted patrols are ferried or swim across to perform close reconnaissance.

(2) From positions on both sides of the river, elements of the squadron provide security for infantry and engineer troops establishing the bridgehead.

(3) If resistance is light, elements of the squadron not already across the river accompany the bridgehead force

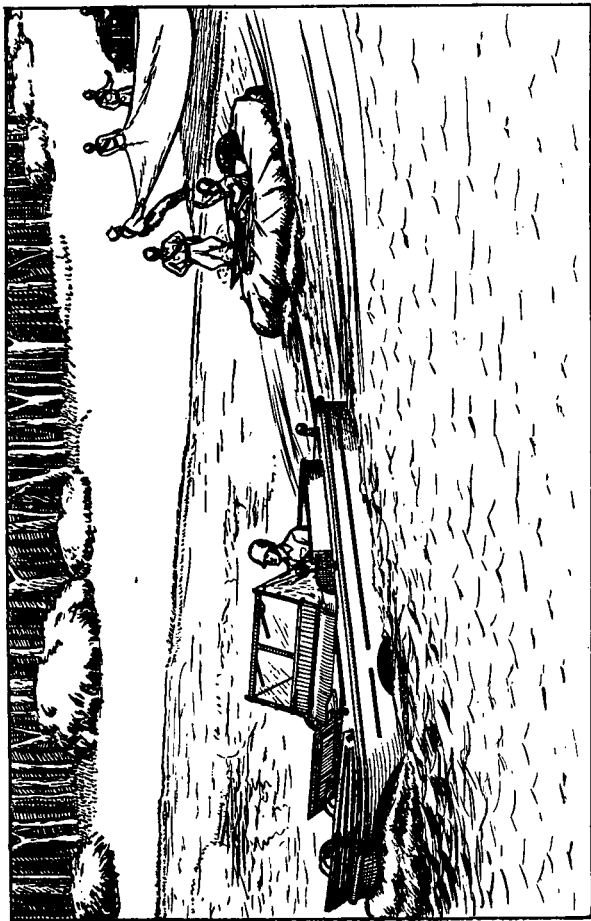

FIGURE 31.—Amphibians may be sent across singly or towing another 1/4-ton truck wrapped in a paulin.

across. If resistance is heavy they follow when the bridge-head is established. The squadron then assembles and proceeds with reconnaissance of assigned zones and objectives.

■ 62. DEFENSE OF A RIVER LINE.—*a.* In the defense of a river line, the motorized division normally will be used as a mobile corps or army reserve to be shifted rapidly to meet a hostile threat. The cavalry division may be used in similar fashion. In this situation the squadron reconnoiters the advance of the division to the river, crosses, and continues reconnaissance to locate the hostile main body. After establishing contact, the squadron withdraws, maintaining contact constantly, determining the hostile strength and movement, observing his flanks, performing counterreconnaissance and, if so ordered, executing delaying action. When the river line is reached patrols are sent to both hostile flanks to report movements to the flank. The remainder of the squadron crosses by prearranged means and establishes patrols along the near bank. Contact is maintained with the patrols on the far bank.

*b.* A corps organizing a river defense may send out a cavalry division with the mission of delaying the approach of a hostile force. During such an operation the squadron will operate on the hostile flanks, reconnoitering, harassing, and providing security for the division.

■ 63. OPERATIONS IN SNOW AND EXTREME COLD.—The fundamentals of operations in snow and extreme cold are contained in FM 100-5. A more detailed discussion, including certain field expedients, is to be found in FM 31-15.

■ 64. DESERT OPERATIONS.—The special considerations contained in FM 31-25 pertaining to individual and unit equipment, motor maintenance, messing, hygiene and sanitation, camouflage and concealment are applicable to the reconnaissance squadron operating in the desert. Security, movement, halts, and bivouacs in the desert are described in paragraphs 41, 42, 45, 46, and 47 of this manual. All personnel must be given special training in determining direction by field expedients (see FM 21-26) and in navigating by dead reckoning (see FM 31-25). Each vehicle should be equipped with a

liquid filled lensatic compass, universal sun compass, pocket watch, protractor, 45° triangle, 6-inch scale graduated in inches and tenths, and Bowditch Table, H. O. 9.

■ **65. JUNGLE OPERATIONS.**—In the jungle proper the combat efficiency of a mechanized unit is sharply decreased. Movement is restricted to roads and trails, and observation usually is limited to a matter of feet. All types of vehicles organic in the reconnaissance squadron are highly susceptible to ambush. The ¼-ton truck is the most useful reconnaissance vehicle. In all but the most favorable of jungle terrain, it will be necessary for personnel to dismount frequently and scout on foot under the protection of vehicular armament. Engineers should be attached to the squadron when it is operating in a jungle area. The subject of jungle warfare is discussed in detail in FM 31-20.

■ **66. LANDING OPERATIONS.**—The logistics of oversea movements are contained in FM 101-10.

a. Landing operations generally involve the main landing, one or more secondary landings, and one or more demonstrations or feints. The main landing is the one upon which the ultimate success of the tactical plan depends. Secondary landings are made outside the immediate area of the main landing and directly or indirectly support the main landing. Secondary landings are conducted with the same determination as the main landing.

b. Landings usually include three phases:

(1) The first phase includes the seizure of the terrain immediately in the rear of the beach followed, when sufficient strength has been landed, by an advance to a position about 10,000 yards inland which secures the beach from enemy light artillery fire.

(2) The second phase consists of an advance to a position at least 15,000 yards inland which denies enemy medium artillery fire on the beach.

(3) The third phase includes further land and air operations made for securing the objectives for which the landing was undertaken.

c. The motorized division and the cavalry division are special-purpose organizations. The use of either in the first

or second phase of a main landing is not contemplated for the reason that such employment would fail to exploit their outstanding characteristic—mobility. Either division may be used in the third phase of a main landing or may execute a secondary landing at a favorable point known to be undefended or only lightly defended.

*d.* When the division makes a third-phase landing, the reconnaissance squadron normally will be landed as a combat team immediately preceding, simultaneously with or following the first infantry battalion, or cavalry squadron, combat team. After reaching the shore, the reconnaissance squadron operates as the main divisional reconnaissance and security agency.

*e.* When the division makes a secondary landing, the order in which elements of the squadron are landed varies according to the tactical situation and landing conditions. When tank lighters of sufficient speed are available and landing conditions are not unfavorable to their operation, the support troop and the antitank platoon should be assigned to the leading wave of the first combat team to provide immediate assistance in the advance from the beach or, if the landing is not immediately opposed, to provide security for following waves. Tanks and armored cars are extremely valuable at this time because of the lack of adequate close supporting artillery fire. At least one reconnaissance platoon also should go ashore with the first combat team to provide the means for early, though limited, mechanized reconnaissance. The rest of the squadron should be sent ashore as soon as possible after the first or second combat team.



CAVALRY MECHANIZED RECONNAISSANCE SQUADRON

APPENDIX I

FUNCTIONAL GROUPING AND VEHICLE MANNING CHARTS

CAVALRY MECHANIZED RECONNAISSANCE SQUADRON

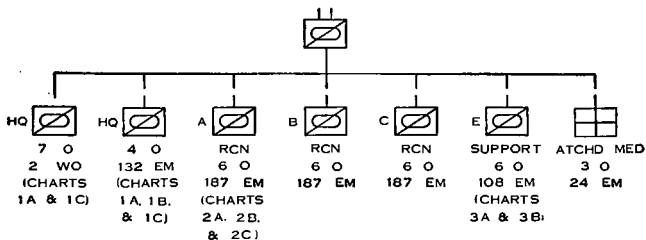

A. PERSONNEL

1. OFFICERS



2. ENLISTED GRADES



B. ARMED WITH

C = CARBINES, CAL .30, M1  
P = PISTOLS, CAL .45

R = RIFLES, CAL .30  
S = SUBMACHINE GUNS, CAL .45

# CAVALRY FIELD MANUAL

## C. VEHICLES



TANK, LIGHT,  
WITH ARMAMENT



CAR, ARMORED, LIGHT,  
WITH ARMAMENT

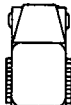

CAR HALF-TRACK  
M-2, WITH  
ARMAMENT



TRUCK, 3-4 TON,  
WEAPONS CARRIER.

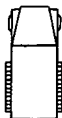

CARRIER, PERSONNEL,  
HALF-TRACK M-3, WITH  
ARMAMENT

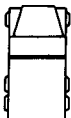

TRUCK, 2 1/2 TON,  
CARGO

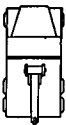

TRUCK, HEAVY WRECKING  
M-1

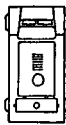

COMPRESSOR, AIR,  
MTZ, 3-TON, HC, 53



TRUCK, 3-4 TON,  
COMMAND



TRUCK, 1-4 TON



AMPH  
TRUCK, 1-4 TON  
AMPHIBIAN



MOTORCYCLE, SOLO



TRAILER, 1 TON,  
2-WHEEL CARGO



TRAILER, 1 TON,  
2-WHEEL WATER



TRAILER, 1-4 TON  
2-WHEEL CARGO

# CAVALRY MECHANIZED RECONNAISSANCE SQUADRON

## HEADQUARTERS & HEADQUARTERS TROOP, CAVALRY MECHANIZED RECONNAISSANCE SQUADRON

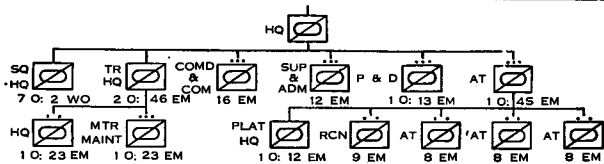

### SUMMARY OF ORGANIZATION

#### STRENGTH

##### A. PERSONNEL

- 11 OFFICERS
- 2 WARRANT OFFICERS
- 132 ENLISTED MEN
- (INCLUDES 12 BASICS NOT SHOWN ON CHARTS AS NO TRANSPORTATION IS PROVIDED FOR BASICS.)

##### B. ARMAMENT (INCLUDES 12 PISTOLS FOR BASICS)

- 30 CARBINES, CAL .30
- 6 LIGHT MACHINE GUNS, CAL .30
- 10 MACHINE GUNS, (HB) CAL .50
- 11 SUBMACHINE GUNS, CAL .45
- 81 PISTOLS, CAL .45
- 23 RIFLES, CAL .30
- (VEHICULAR ARMAMENT NOT INCLUDED)

##### C. VEHICLES

- 1 COMPRESSOR, AIR, MTZ, 3-TON, HC.
- 11 ARMORED CARS, LIGHT, W-ARMAMENT
- 1 TRUCK, HEAVY-WRECKING M-1
- 2 MOTORCYCLES, SOLO
- 3 TRAILERS, 1 TON, 2 WHEEL CARGO
- 2 TRAILERS, 1 TON, 2 WHEEL WATER TANK (250-GALLON)
- 3 TRAILERS, 1-4 TON, 2 WHEEL CARGO
- 10 TRUCKS, 1-4 TON
- 2 TRUCKS, 1-4 TON, AMPH
- 5 TRUCKS, 3-4 TON, COMMAND
- 6 TRUCKS, 2 1-2 TON, CARGO (2 COMBAT, 1 KITCHEN, 1 GAS & OIL, 2 MTR MAINT W-WINCH)

### 1. COMMAND ELEMENT

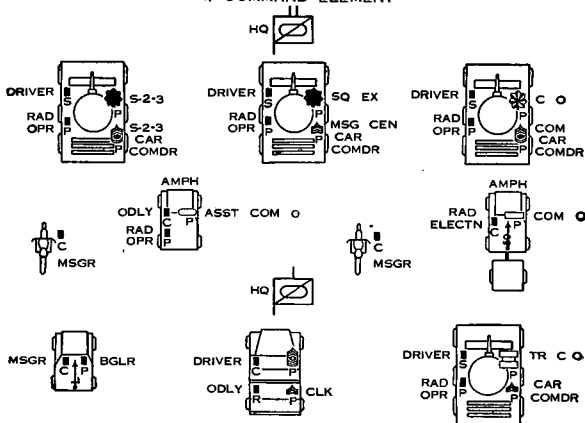

# CAVALRY FIELD MANUAL

## 2. COMBAT ELEMENT

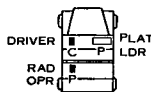
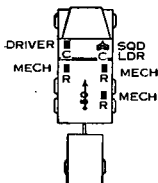
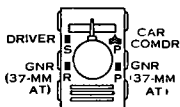
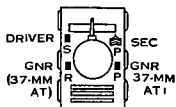
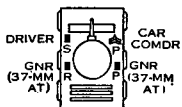
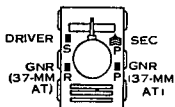
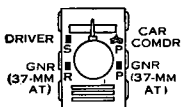
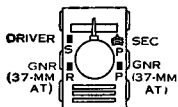
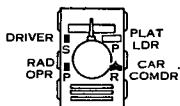
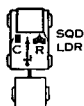

# CAVALRY MECHANIZED RECONNAISSANCE SQUADRON

## 3. SERVICE ELEMENT

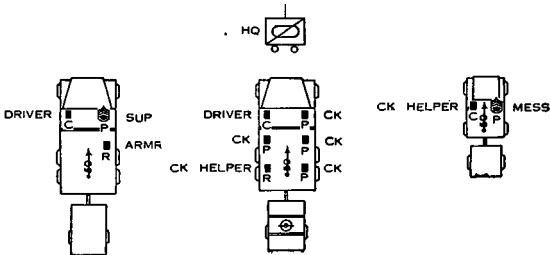
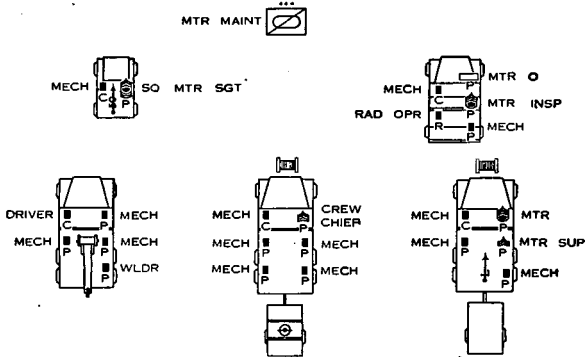
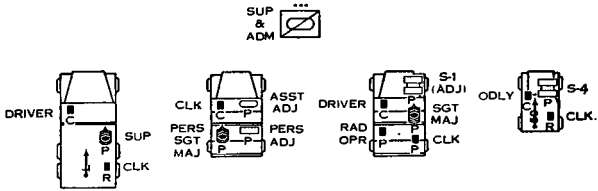

# CAVALRY FIELD MANUAL

## CAVALRY MECHANIZED RECONNAISSANCE TROOP

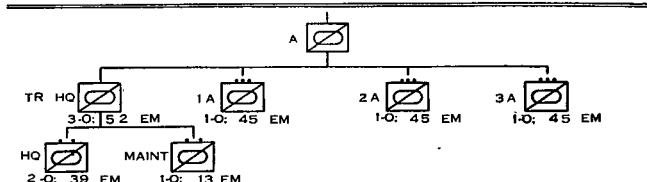

### SUMMARY OF ORGANIZATION

#### STRENGTH

##### A. PERSONNEL

6 OFFICERS  
187 ENLISTED  
(INCLUDING 17 BASICS NOT SHOWN  
ON CHARTS AS NO TRANSPORTATION  
IS PROVIDED FOR BASICS.)

##### B. ARMAMENT (INCLUDES 9 CARBINES,

AND 8 RIFLES CAL 30, FOR BASICS)  
42 PISTOLS, CAL .45  
17 LIGHT MACHINE GUNS, CAL .30  
15 MACHINE GUNS (HB) CAL .50  
17 SUBMACHINE GUNS, CAL .45  
60 CARBINES, CAL .30  
74 RIFLES, CAL .30  
3 MORTARS, 81-MM, M-1  
(VEHICULAR ARMAMENT NOT INCLUDED)

##### C. VEHICLES

9 ARMORED CARS, LIGHT, WITH  
ARMAMENT  
8 MOTORCYCLES, SOLO  
29 TRUCKS, 1-4 TON  
4 TRUCKS, 1-4 TON AMPHIBIAN  
1 TRUCK 3-4 TON COMMAND  
9 TRUCKS, 3-4 TON WEAPONS CARRIER  
W-WINCH  
2 TRUCKS, 2 1-2 TON, CARGO  
(1 KITCHEN, 1 MTR MAINT W-WINCH)  
1 TRAILER, 1 TON, 2 WHEEL, CARGO  
15 TRAILERS, 1-4 TON, 2 WHEEL, CARGO

### 1. COMMAND ELEMENT

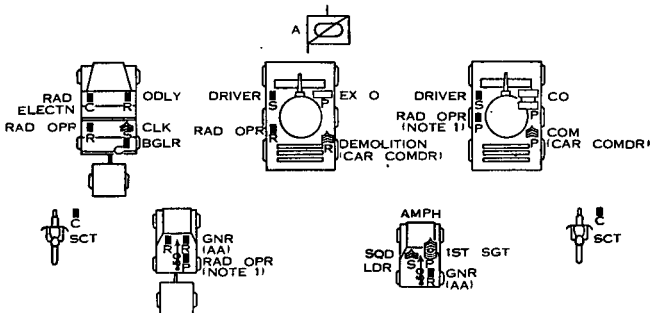

#### NOTES

1. RELIEF RADIO OPERATOR ALSO ACTS AS GUNNER.

# CAVALRY MECHANIZED RECONNAISSANCE SQUADRON

## 2. COMBAT ELEMENT

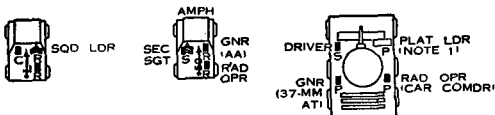

NOTE

1. RIDES IN ARMORED CAR OR OTHER CAR OF RECONNAISSANCE SECTION, AS REQUIRED.

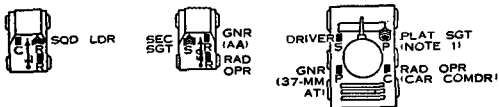

NOTE

2. PLATOON LEADER AND PLATOON SERGEANT CONSTITUTE PLATOON HEADQUARTERS AND ARE NOT PERMANENTLY A PART OF EITHER SECTION. SEE NOTE 2.

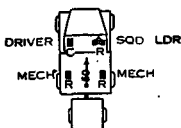

(SAME AS 1ST PLATOON)

# CAVALRY FIELD MANUAL

## 3. SERVICE ELEMENT

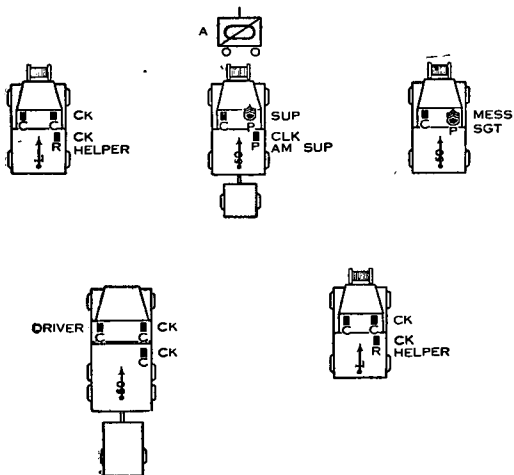
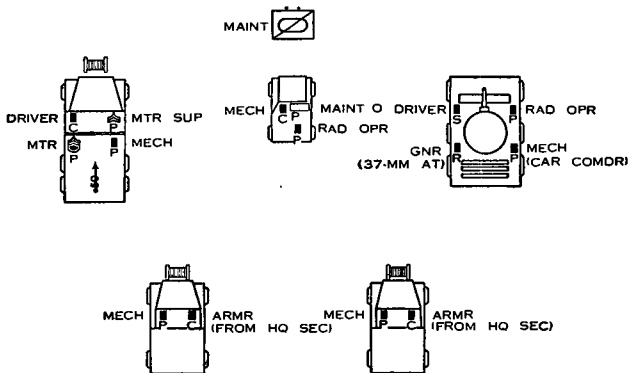



# CAVALRY MECHANIZED RECONNAISSANCE SQUADRON

## CAVALRY MECHANIZED SUPPORT TROOP

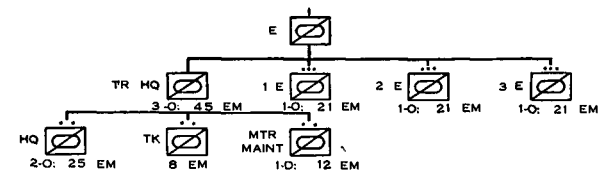

### SUMMARY OF ORGANIZATION

#### STRENGTH

##### A. PERSONNEL

6 OFFICERS  
 108 ENLISTED  
 (INCLUDING 9 BASICS NOT SHOWN ON CHARTS AS NO TRANSPORTATION IS PROVIDED FOR BASICS.)

##### B. ARMAMENT

2 MACHINE GUNS (HB), CAL. .50  
 3 LIGHT MACHINE GUNS, CAL. .30  
 21 SUBMACHINE GUNS, CAL. .45  
 4 RIFLES, CAL. 30.  
 28 CARBINES, CAL. 30  
 (INCLUDES 9 FOR BASICS.)  
 61 PISTOLS, CAL. .45  
 (VEHICULAR ARMAMENT NOT INCLUDED)

##### C. VEHICLES

17 TANKS, LIGHT WITH ARMAMENT  
 1 HALF-TRACK, M-2, WITH ARMAMENT  
 2 CARRIERS, PERSONNEL, HALF-TRACK M-3, WITH ARMAMENT, WITH WINCH  
 2 TRUCKS, 1-4 TON  
 1 TRUCK, 3-4 TON, COMMAND  
 3 TRUCKS, 2 1-2 TON, CARGO  
 (1 COMBAT, 1 GAS & OIL, 1 KITCHEN.)  
 2 TRAILERS, 1 TON, 2 WHEEL, CARGO  
 1 TRAILER, 1 TON, 2 WHEEL, WATER TANK (250-GALLON)  
 4 TRAILERS, 1-4 TON, 2 WHEEL, CARGO

### 1. COMMAND ELEMENT

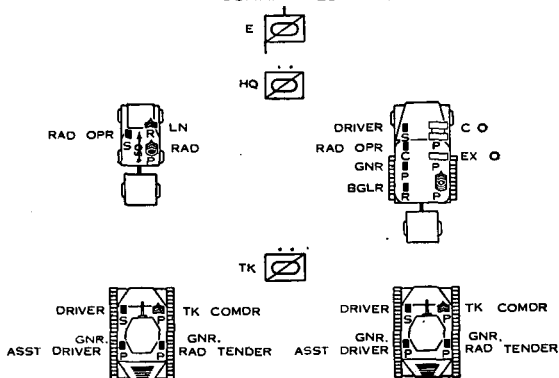

# CAVALRY FIELD MANUAL

## 2. COMBAT ELEMENT

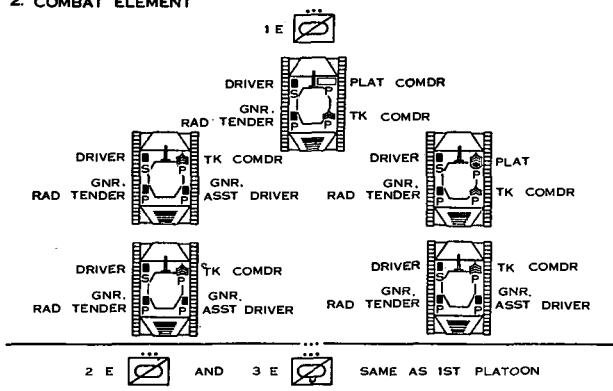

## 3. SERVICE ELEMENT

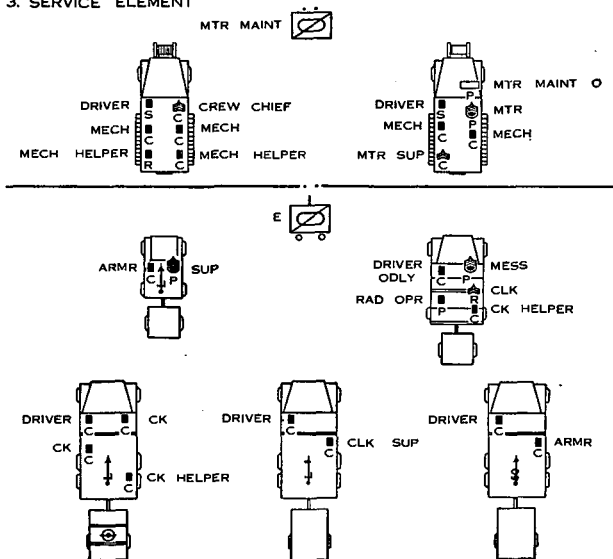

# CAVALRY MECHANIZED RECONNAISSANCE SQUADRON

## APPENDIX II

### RADIO NETS

CAVALRY MECHANIZED RECONNAISSANCE SQUADRON

#### HEADQUARTERS & HEADQUARTERS TROOP

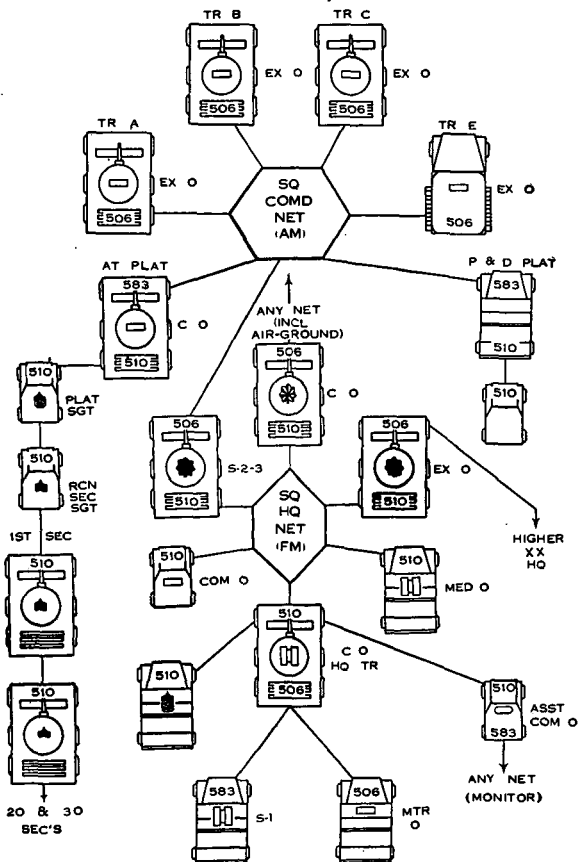



# CAVALRY MECHANIZED RECONNAISSANCE SQUADRON

## CAVALRY MECHANIZED SUPPORT TROOP

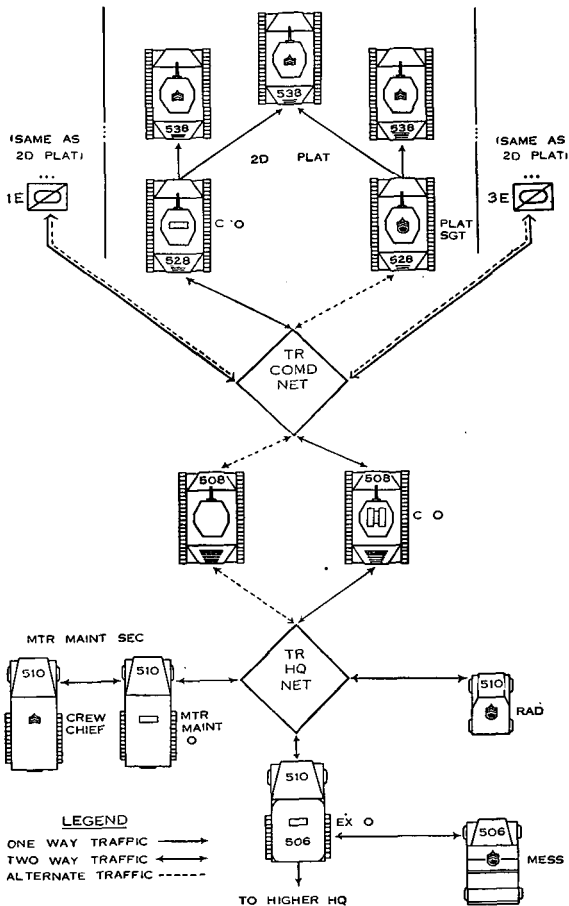



## INDEX

	Paragraph	Page
<b>Action:</b>		
Against air-landing troops-----	57	80
Character of-----	23	16
Defensive-----	24, 42, 44, 54, 57	16, 45, 48, 76, 80
Delaying-----	43, 51, 55, 56, 62	46, 65, 77, 78, 90
Harassing-----	43, 52, 53	46, 76
Offensive-----	18, 24, 49-53	13, 16, 55
Of the squadron on reconnaissance-----	28	18
Tactical, types of-----	25	17
<b>Advance:</b>		
Guards-----	40	36
Rate of-----	29	19
Aircraft, security against-----	42	45
Air-ground communication-----	26	17
<b>Ammunition:</b>		
Conservation of-----	19	13
Supply of-----	58	85
<b>Amphibious ¼-ton truck:</b>		
Description-----	5	2
Employment-----	61	88
<b>Antiairborne defense-----</b>	<b>57</b>	<b>80</b>
<b>Antiaircraft:</b>		
Defense-----	40, 42, 57	36, 45, 80
Weapons, alert of-----	40	36
<b>Antitank platoon:</b>		
Employment of-----	37, 43, 51	32, 46, 65
Training-----	16	11
<b>Areas of reconnaissance-----</b>	<b>30</b>	<b>20</b>
<b>Armored car, description of-----</b>	<b>5</b>	<b>2</b>
<b>Artillery attached-----</b>	<b>56</b>	<b>78</b>
<b>Assembly position-----</b>	<b>50, 51</b>	<b>55, 65</b>
<b>Attached medical-----</b>	<b>17, 60</b>	<b>12, 87</b>
<b>Attack:</b>		
Direction of-----	51	65
Formations of support troop-----	50	55
Harassing-----	52, 53	76
Main-----	51	65
Of a river line-----	61	88
Secondary-----	51	65
<b>Aviation:</b>		
Observation, cooperation by-----	26	17
Information furnished by-----	26	17
Information of hostile-----	33	25
<b>Axial roads-----</b>	<b>29</b>	<b>19</b>

INDEX

	Paragraph	Page
Base of fire.....	51	65
Battle reconnaissance.....	37	32
Bivouac.....	41, 46	37, 51
Blocks, road, reduction of.....	9	4
Boundaries of zones and areas.....	30	20
Bounds, movement by.....	45, 50	49, 55
Bridges, information of.....	33	25
Casualties, evacuation of.....	60	87
Civilian population.....	33	25
Classes of supply.....	58	85
Close reconnaissance.....	37	32
Cold, extreme, operations in.....	63	90
Collection of casualties.....	60	87
Combat:		
By reconnaissance platoons and troops.....	49	55
Defensive.....	54-57	76
Dismounted.....	9	4
Formations.....	21	14
General.....	48	51
Offensive.....	18, 49-53	13, 55
Outposts.....	41	37
Patrols.....	41	37
Trucks.....	58	85
Combined training, air-ground.....	26	17
Command and communications platoon.....	14	9
Communication:		
By air observer.....	26	17
Command and, platoon.....	14	9
Importance of.....	24	16
In reconnaissance, instruction.....	32	23
Means of.....	9	4
Personnel.....	14	9
Radio.....	7, 35, 42, 51	2, 30, 45, 65
Contaminated areas, information of.....	33	25
Control:		
Decentralization of.....	56	78
During attack.....	51	65
Of reconnaissance detachments.....	32, 34	23, 30
Procedure.....	51	65
Cooperation:		
By observation aviation.....	26	17
With corps reconnaissance regiment.....	29, 61	19, 88
With tank destroyer battalions.....	27	18
Coordination:		
Essential elements of.....	51	55
Of fire.....	51	55
Of reconnaissance elements.....	34	30
Corps reconnaissance regiment, cooperation with.....	29, 61	19, 88
Counterattack.....	54, 55	76, 77
Counterreconnaissance.....	24, 44, 62	16, 48, 90
Cover and concealment.....	40, 46, 47	36, 51
Covering detachments.....	40	36
Culverts, information of.....	33	25



# INDEX

	Paragraph	Page
Defense:		
Antiairborne.....	57	80
Antiaircraft.....	42	45
General.....	54	76
Of a river line.....	62	90
Of obstacles.....	44	48
Of a position.....	54	76
Deflate, fire from.....	51	65
Delaying action.....	41, 51, 55, 56, 62	37, 65, 77, 78, 90
Demolitions, information of.....	33, 55	25, 77
Depth of reconnaissance.....	29	19
Desert operations.....	64	90
Destruction of matériel.....	8	3
Detachments:		
Control of.....	34	30
Counterreconnaissance.....	44	48
Reconnaissance, strength and composition of.....	31	23
Dismounted combat.....	9	4
Distant reconnaissance.....	36	32
Drill.....	19, 20	13, 14
Employment:		
General principles.....	23	16
Of the antitank platoon.....	37, 51	32, 65
Of the pioneer and demolitions platoon.....	37, 51	32, 65
Of the support troop.....	19, 39, 42, 50-55	13, 36, 45, 55
Engineers:		
Attached.....	56	78
Reconnaissance parties attached.....	61	88
Envelopment:		
Of flanks.....	51	65
In pursuit.....	52	76
Vertical.....	57	80
Equipment:		
Radio.....	7	2
Vehicles.....	5	2
Weapons.....	6	2
Evacuation.....	60	87
Fire:		
And movement.....	48	51
Base of.....	51	65
Coordination of.....	51	65
Power, application of.....	51	65
First aid.....	60	87
Flank guards.....	40	36
Formations:		
Combat.....	21, 50	14, 55
Drill.....	21	14
Frontage on reconnaissance.....	31	23
Gasoline supply.....	58	85
General principles of employment.....	23	16
Grouping, tactical.....	4	1

## INDEX

	Paragraph	Page
Half-track vehicles.....	5	2
Halts.....	46	51
Harassing action.....	43, 53, 62	46, 76, 90
Headquarters and headquarters troop.....	11-17	6
Antitank platoon.....	16	11
Attached medical.....	17	12
Command and communications platoon.....	14	9
Pioneer and demolitions platoon.....	16	11
Squadron headquarters.....	12	6
Supply and administrative platoon.....	15	11
Troop headquarters.....	13	8
Headquarters section.....	13	8
Motor maintenance platoon.....	13	8
Information:		
Essential elements of.....	32, 37	23, 32
Furnished by observation aviation.....	26	17
Routine items of.....	33	25
Initiative:		
Need for, in motor maintenance platoon.....	59	85
Of subordinate commanders.....	51	65
Inspection, full field.....	22	15
Instructions, reconnaissance.....	32	23
Intelligence.....	14	9
Annex.....	32	23
Radio.....	35	30
Jungle warfare.....	65	91
Kitchen trucks, location of.....	58	85
Landing operations.....	66	91
Leapfrogging.....	50	55
Liaison:		
Agent from tank destroyer battalion.....	27	18
With corps reconnaissance regiment.....	29	19
Limited objectives.....	50	55
Line of departure.....	51	65
Logistics.....	58, 60	85, 87
Machine gun.....	51	55
March:		
Outposts.....	41	37
Serial.....	45	49
Unit.....	45	49
Marches.....	45	49
Matériel:		
Destruction of.....	8	3
Evacuation of.....	60	87
Means of communication.....	9	4
Medical detachment:		
Collection of casualties by.....	60	87
Training.....	17	12
Messages.....	26	17

INDEX

	Paragraph	Page
Methods of reconnaissance.....	28	18
Mines, information of.....	33	25
Missions.....	24	16
Mission-type orders.....	52, 53	76
Mortar squads.....	51, 55	65, 77
Motor maintenance:		
Echelons of.....	59	85
Initiative in.....	59	85
Personnel.....	13	8
Platoon.....	13	8
Squadron second echelon maintenance.....	13, 59	8, 85
Troop second echelon maintenance.....	59	85
Movement:		
By bounds.....	45	49
Fire and.....	48	51
Navigation.....	64	90
Nets, radio.....	7	2
Night reconnaissance.....	38	33
Objectives, limited.....	50	55
Obstacles:		
Defense of.....	44	48
Information of.....	33	25
Preparation of.....	44, 55, 56	48, 77, 78
Offensive combat.....	18, 49-53	13, 55
Operations:		
At river lines.....	61, 62	88, 90
Cavalry, character of.....	51	65
Defensive.....	24, 42, 44, 54, 57	16, 45, 48, 76, 80
In desert.....	41, 42, 45, 46, 47, 64	37, 45, 49, 51, 90
In snow and extreme cold.....	63	90
In jungle.....	65	91
Landing.....	66	91
Map.....	14	9
Offensive.....	18, 24, 49-53	13, 16, 55
Special.....	61-65	88
Orders:		
Fragmentary.....	32	23
Initial.....	51	65
Mission-type.....	52, 53	76
Organization.....	3	1
Outposts.....	41	37
Parachutists, action against.....	57	80
Patrols:		
Combat.....	41	37
Reconnaissance.....	34	30
Penetration.....	51	65

INDEX

	Paragraph	Page
Personnel:		
Communication.....	14	9
Evacuation of.....	60	87
Phase lines:		
Advance regulated by.....	45	49
Designation of.....	34	30
Pioneer and demolitions platoon:		
Employment of.....	37, 43, 51, 55	32, 46, 65, 77
Training.....	16	11
Position:		
Assembly.....	50	55
Defense of.....	54	76
Prisoners, evacuation of.....	60	87
Problems, tactical.....	10	5
Protective measures.....	9, 47	4, 51
Purpose of manual.....	1	1
Pursuit.....	52	76
Radio:		
Equipment.....	7	2
Intelligence, locator stations.....	35	30
In warning systems.....	42	45
Jamming.....	35, 51	30, 65
Nets.....	7	2
Personnel.....	14	9
Repair.....	14	9
Rallying point.....	51	65
Rate of advance.....	29	19
Rations, supply of.....	58	85
Rear guards.....	40	36
Reconnaissance:		
As a part of task force.....	61	88
At night.....	38	33
At river lines.....	61, 62	88, 90
Close and battle.....	37	32
Detachments, strength and composition of.....	31	23
Distant.....	36	32
During withdrawal.....	56	78
In force.....	18	13
Instructions.....	32	23
Long range.....	57	80
Methods.....	28	18
Of anti-airborne defense area.....	57	80
Rate of advance on.....	29	19
Reconnaissance troop:		
Defensive combat.....	54, 55, 57	76, 77, 80
Instructions to.....	32	23
Offensive combat by.....	49, 51-53, 55	55, 65, 77
Training of.....	18	13
Reserve.....	51, 57	65, 80
River line, attack of.....	61	88
Road blocks, reduction of.....	9	4

INDEX

	Paragraph	Page
Roads:		
Axial .....	29	19
Information of .....	33	25
Routes of reconnaissance .....	30	20
Routine items of information .....	33	25
Sand table .....	10	5
Scope of manual .....	2	1
Screen, counterreconnaissance .....	44	48
Security:		
As a primary mission .....	43	46
By support troop .....	40, 41, 50	38, 37, 55
Counterreconnaissance .....	44	48
During withdrawal .....	56	78
For bridgehead troops .....	61	88
For other elements .....	43, 61, 62	46, 88, 90
Passive measures of .....	42	45
Train .....	42	45
Use of antitank weapons .....	42	45
While moving .....	40	36
Signals, visual .....	26	17
Smoke, use of .....	51	65
Snow, operations in .....	63	90
Special operations .....	61-65	88
Attack of river line .....	61	88
Defense of a river line .....	62	90
Desert .....	64	90
In snow and extreme cold .....	63	90
Jungle warfare .....	65	91
Landing operations .....	66	91
Squadron headquarters .....	12	6
Standards of proficiency .....	9	4
Standing operating procedure .....	21	14
Strength of reconnaissance detachments .....	31	23
Supervision of training .....	11, 13-17	6, 8
Supplies:		
Classes of .....	58	85
Information of .....	33	25
Supply .....	58	85
Facility of .....	47	51
Motor .....	59	85
Responsibility for .....	13	8
Supply and administrative platoon .....	15	11
Support troop:		
Employment of .....	19, 38, 42, 50-55	13, 33, 45, 55
Training of .....	18	13
Tactical:		
Exercise, applicatory .....	10	5
Grouping .....	4	1
Problems .....	10	5

INDEX

	Paragraph	Page
Tank, light:		
Against air-landing troops.....	57	80
Combat, characteristics of.....	50	55
In landing operations.....	66	91
Tank destroyer battalions, cooperation with.....	27	18
Task force on reconnaissance.....	37	32
37-mm gun:		
Against air-landing troops.....	57	80
Against mechanization.....	51	65
Thrust line.....	51	65
Time and space.....	51	65
Training:		
Combined air-ground.....	26	17
Methods.....	10	5
Objectives.....	9	4
Of headquarters and headquarters troop.....	11, 13-17	6, 8
Of reconnaissance troop.....	18	13
Of support troop.....	19	13
Responsibility for.....	11	6
Specialist.....	11	6
Standards of proficiency.....	9	4
Trains:		
Employment of.....	58	85
Security for.....	42	45
Troop headquarters, headquarters and headquarters troop.....	13	8
Trucks:		
Combat.....	58	85
Kitchen.....	58	85
1/4-ton.....	5	2
1/4-ton amphibian.....	5	2
3/4-ton weapon carrier.....	5	2
Utilities, information of.....	33	25
Vehicles.....	5	2
Evacuation of.....	60	87
Maintenance of.....	59	85
Vertical envelopment.....	57	80
Visual signals.....	26-51	17
Warning system:		
Airborne attack.....	57	80
For other elements.....	43	46
In trains.....	42	45
Weapons.....	6	2
Withdrawal.....	56, 62	78, 90
Zones of reconnaissance.....	30	20

