

MHI
Copy 3

DEPARTMENT OF THE
ARMY FIELD MANUAL
DEPARTMENT OF THE AIR
FORCE TECHNICAL ORDER

FM 23-5

TO 39A-5AC-11

U. S. RIFLE CALIBER .30, M1

DEPARTMENTS OF THE ARMY AND THE AIR FORCE

October 1951

FM 23-5/ TO 39A -5AC-11

This manual supersedes FM 23-5, 30 July 1943, including C1, 21 March 1944; C2, 1 December 1944; C3, 24 November 1948; Paragraph 3, Training Circular No. 9, Department of the Army, 6 July 1949; Paragraph 9, Training Circular No. 10, Department of the Army, 20 July 1949; and Training Circular No. 5, Department of the Army, 4 April 1950.

U. S. RIFLE CALIBER .30, M1



DEPARTMENTS OF THE ARMY
AND THE AIR FORCE

WASHINGTON 25, D. C., 2 October, 1951

FM 23-5/TO 39A-5AC-11, is published for the information and guidance of all concerned.

[AG 474.1 (8 Jun 51)]

BY ORDER OF THE SECRETARIES OF THE ARMY AND
THE AIR FORCE:

OFFICIAL:

WM. E. BERGIN
Major General, USA
The Adjutant General

J. LAWTON COLLINS

Chief of Staff
United States Army

OFFICIAL:

K. E. THIEBAUD
Colonel, USAF
Air Adjutant General

HOYT S. VANDENBERG

Chief of Staff
United States Air Force

DISTRIBUTION:

Army:

Tech Svc (1); Arm & Svc Bd (2); AFF (40);
AA Comd (2); OS Maj Comd (20) except
FECOM (200); Base Comd (10); MDW (10);
Log Comd (5); A (25); CHQ (10); D (5); B
(3); R 2,5,7,17 (5); Bn 2,3,5,6,7,9,10,11,17, 19,44
(5); C 5, 7,17,57 (20), 2,6,44 (15), 3,9,10,11,19
(10); Sch (5) except USMA (50); PMS&T
(2); ARMA (1); Mil Mis (1).

For explanation of distribution formula, see SR
310-90-1.

CONTENTS

		<i>Paragraphs</i>	<i>Page</i>
CHAPTER 1. INTRODUCTION		1-4	2
2. MECHANICAL TRAINING			
<i>Section I.</i> Disassembly and assembly....	5-24		9
<i>II.</i> How the rifle works.....	25-32		57
<i>III.</i> Operation	33-44		72
<i>IV.</i> Immediate action and stop- pages	45-47		82
<i>V.</i> Care and cleaning.....	48-57		83
<i>VI.</i> Spare parts, appendages, and accessories	58-60	102	
<i>VII.</i> Ammunition	61-70		115
CHAPTER 3. MARKSMANSHIP TRAINING			
<i>Section I.</i> General	71-73		126
<i>II.</i> Preparatory marksmanship training	74-138		127
<i>III.</i> Courses	139-147		253
<i>IV.</i> Range firing	148-151		274
<i>V.</i> Subjects common to instruc- tion and record firing.....	152-162		280
<i>VI.</i> Instruction firing	163-180		284
<i>VII.</i> Record firing	181-187		297
<i>VIII.</i> Pit operation	188-198		307
<i>IX.</i> Equipment and targets.....	199-200		314
<i>X.</i> Small-bore firing	201-203		318
CHAPTER 4. MARKSMANSHIP, MOVING GROUND AND AERIAL TARGETS			
<i>Section I.</i> General	204-206		322
<i>II.</i> Moving personnel	207-208		323
<i>III.</i> Moving vehicles	209-210		325
<i>IV.</i> Aerial target	211-212		328
CHAPTER 5. TECHNIQUE OF FIRE OF THE RIFLE SQUAD			
<i>Section I.</i> General	213		331
<i>II.</i> Range determination	214-217		331

	<i>Paragraphs</i>	<i>Page</i>
III. Rifle and automatic rifle fire and its effect	218-223	337
IV. Fire commands	224-227	344
V. Application of fire by the rifle squad	228-234	355
VI. Landscape target firing.....	235-240	368
VII. Field target firing.....	241-247	378
 CHAPTER 6. ADVICE TO INSTRUCTORS		
<i>Section I.</i> General	248-253	387
II. Subject schedules and train- ing notes for rifle marks- manship training	254-289	390
III. Subject schedule and train- ing notes for familiariza- tion rifle marksmanship training	290-297	414
IV. Mechanical training	298-302	419
V. Preparatory training	303-319	422
VI. Transition and moving tar- get firing	320-326	455
VII. Technique of fire.....	327-337	467
VIII. Landscape target firing.....	338-341	478
IX. Field target firing.....	342-345	479
X. Training aids	346-349	491
 CHAPTER 7. SAFETY PRECAUTIONS.....		
	350-353	500
 APPENDIX I. REFERENCES		
		507
 II. DESTRUCTION OF ORDNANCE		
MATÉRIEL.....		509
 INDEX		
		512

This manual supersedes FM 23-5, 30 July 1943, including C 1 21 March 1944; C 2, 1 December 1944; C 3, 24 November 1948; paragraph 3, Training Circular No. 9, Department of the Army, 6 July 1949; paragraph 9, Training Circular No. 10, Department of the Army, 20 July 1949; and Training Circular No. 5, Department of the Army, 4 April 1950.

CHAPTER 1

INTRODUCTION

1. PURPOSE AND SCOPE

The purpose of this manual is to teach you how to fire your rifle correctly and how to take care of it, both in the field and in garrison. By mastering the material in this manual, you can help yourself to become a good rifleman and a better member of your team—the rifle squad.

2. IMPORTANCE OF RIFLE TRAINING

a. The rifle is the basic weapon of the United States Army. Although you use it to shoot at a bull's eye (fig. 1) today, your target tomorrow may be the enemy. For that reason there is no part of shooting that is *about right*. In combat, you either HIT or you MISS, and your own life as well as the lives of other men of your unit may depend on your skill as a rifleman.

b. On the battlefield your target is almost always a moving one and it may be very hard to see. Learning how to hit your battlefield target is the most important part of your training.

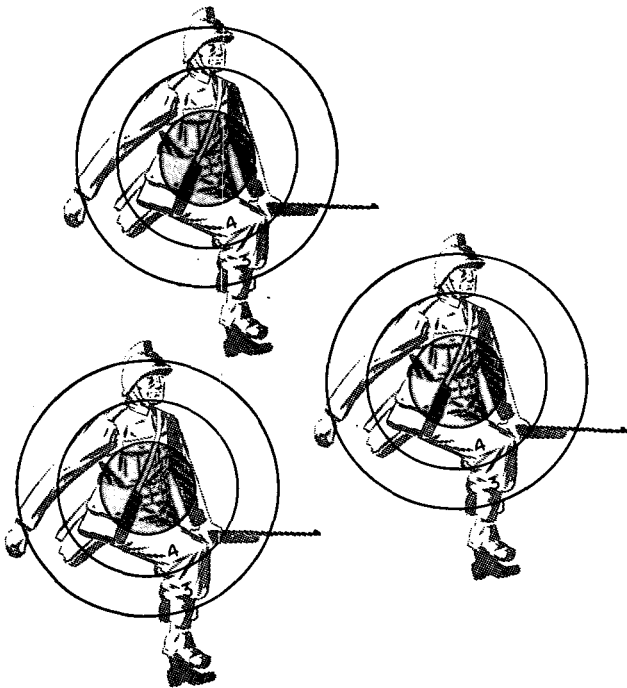

Figure 1. Bull's-eye—Enemy.

Naturally, your training starts with the rifle itself (fig. 2). First you learn how it works, how to care for it, and what it can do. Next you learn how to fire at a fixed target on the range. Your last step is firing under battlefield conditions.

c. The rifle marksmanship training that you will be given is battle-tested and thorough. If you learn and practice the right shooting habits, you will become a good shot. As a rifleman, you must strive to be an expert. Do not be satisfied to qualify only as a marksman.

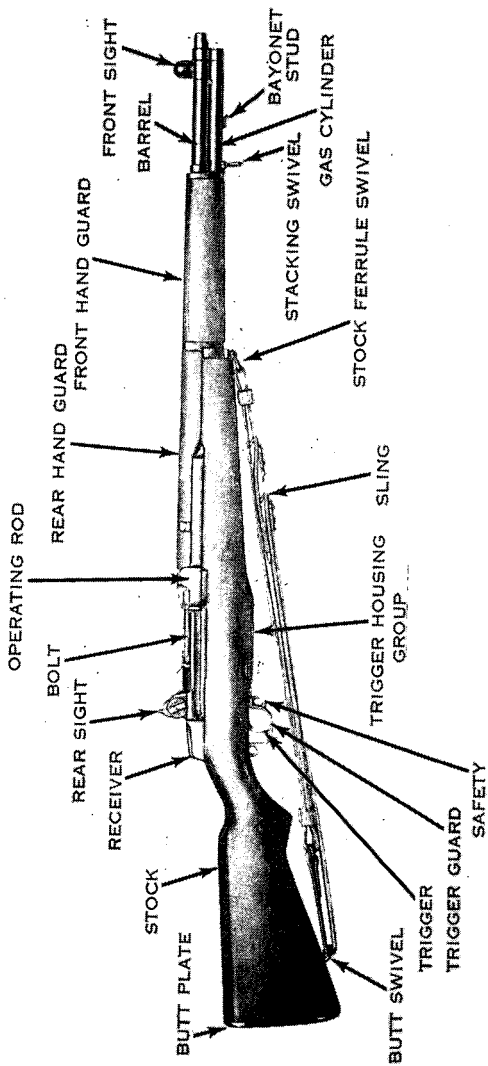

Figure 2. U. S. Rifle, caliber .30, M1.

3. DESCRIPTION OF THE RIFLE

a. The U. S. rifle, caliber .30, M1 is a clip-fed, gas-operated, air-cooled, semiautomatic shoulder weapon. This means that you insert into the receiver a metal clip containing a maximum of eight rounds; that the power needed to load and cock the rifle for each succeeding round comes from the expanding gases of the previous round; that the air cools the barrel; and that the rifle fires one round each time you squeeze the trigger.

b. The rifle has a fixed (immovable) front sight and a movable rear sight that can be moved up or down and right or left. Thus, you can adjust the sight for long or short ranges or to take care of a wind that might otherwise blow the bullet off its course to the target. At ranges over 500 yards, a battlefield target is hard for the average rifleman to hit. Therefore, 500 yards is

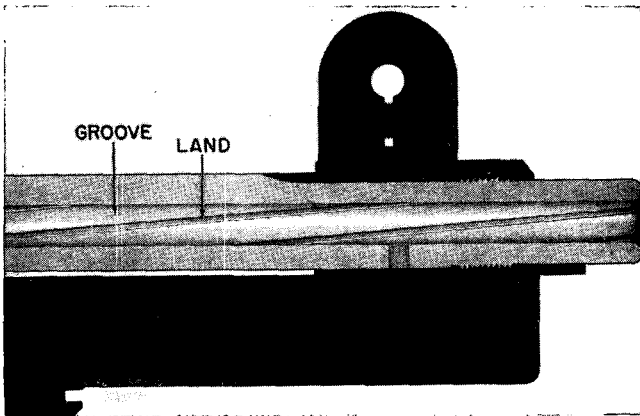

Figure 3. The barrel of the rifle.

considered the *maximum effective range*, even though the rifle is accurate at much greater ranges.

c. After examining your rifle to make sure that it is not loaded, look down the bore (fig. 3). The ribs that stand out between the grooves in the bore are called the lands. The grooves and lands are called rifling. This rifling makes the bullet rotate during its flight toward the target. This rotation prevents the bullet from tumbling in flight and causes it to follow a uniform course to the target. The grooves and lands make one complete turn in 10 inches of barrel length.

d. You will want to know the following facts about your rifle:

Weight, without bayonet.....	9.5 pounds
Weight, with bayonet.....	10.5 pounds
Length, without bayonet	43.6 inches
Length, with bayonet.....	53.4 inches
Trigger pull, minimum.....	4.5 pounds
Trigger pull, maximum.....	7.5 pounds
Barrel:	
Length	24 inches
Approximate normal cham-	
ber pressure	50,000 lbs. per
	square inch
Sight radius (distance from	
front sight to rear sight)....	27.9 inches
Rifling:	
Number of grooves.....	4
Twist.....	Uniform, right hand,
	one turn in 10 inches

4. FIRE POWER

When you squeeze the trigger, the round is fired, the empty case is ejected, the hammer is cocked, a new round is inserted into the chamber, and the rifle is made ready to fire again—all in about one eight-hundredth of a minute. This fast mechanical action allows you, or a group of riflemen, to deliver a large number of aimed shots in a very short time on any target within effective range.

CHAPTER 2

MECHANICAL TRAINING

Section I. DISASSEMBLY AND ASSEMBLY

5. TRAINING

Your rifle is only as good as the care you give it. Rust and dirt cause more wear than actual firing. The officers and noncommissioned officers of your unit will teach you how to take the rifle apart, how to clean it, and how to put it together. This is commonly called *field stripping*. In training, feel free to ask the instructor questions on any point that you do not understand.

6. CARE OF THE RIFLE

Your rifle has been designed so that it may be taken apart and put together easily. No force is needed if you strip it correctly. As you remove the parts (fig. 4) from the rifle, lay them on a clean flat surface such as a table or shelter half in the same order that you remove them. This keeps you from losing any parts and helps you to assemble your rifle because you replace the parts in reverse order.

7. NOMENCLATURE

You will learn the names of the parts of your rifle during your instruction in field stripping. As your instructor names the parts, repeat them to yourself, and name each part as you remove

it and as you replace it. You will find that the parts generally are named for the job they perform. For example, the trigger guard actually guards the trigger so that your hands or some other object will not accidentally brush against the trigger and trip it.

8. DISASSEMBLY

a. You will be permitted to disassemble only certain parts of your rifle, not because the disassembly of some of the parts is beyond your ability to learn, but because constant disassembly causes extra wear. Also, some parts of your rifle require special tools for disassembly.

b. Study the following chart. The left hand column shows those parts that you may disassemble alone. The right hand column shows those parts that only ordnance personnel may disassemble. The center columns indicate those parts that you may remove when supervised.

Disassembly authorized	Individual soldier	Disassembly supervised by		Ordnance personnel
		Noncommissioned officer or artificer	Commissioned officer	
INTO THREE MAIN GROUPS.....	X			
BARREL AND RECEIVER GROUP.....	X			
Except:				
Gas cylinder..... (See note below.)			X	
Gas cylinder lock.....		X	X	
Clip latch and pin.....		X	X	
Rear sight.....			X	
Slide from follower.....				X
Accelerator from the operating rod catch.....				X
Front sight.....				X
STOCK GROUP.....		X	X	
TRIGGER HOUSING GROUP.....		X	X	
Except:				
Sear from trigger.....				X

Note. After extensive range firing, field exercises, prolonged exposure to inclement weather, or immersion in water (particularly salt water), the gas cylinder may be removed for cleaning. The removal, care and cleaning, and the replacement of the gas cylinder is made under the *direct supervision* of an officer.

9. FIELD STRIPPING

You must learn the steps of field stripping so well that you can do them in the dark. You can field strip your rifle by using only the combination tool or a dummy cartridge. Learn to know the combination tool, because you will use it many

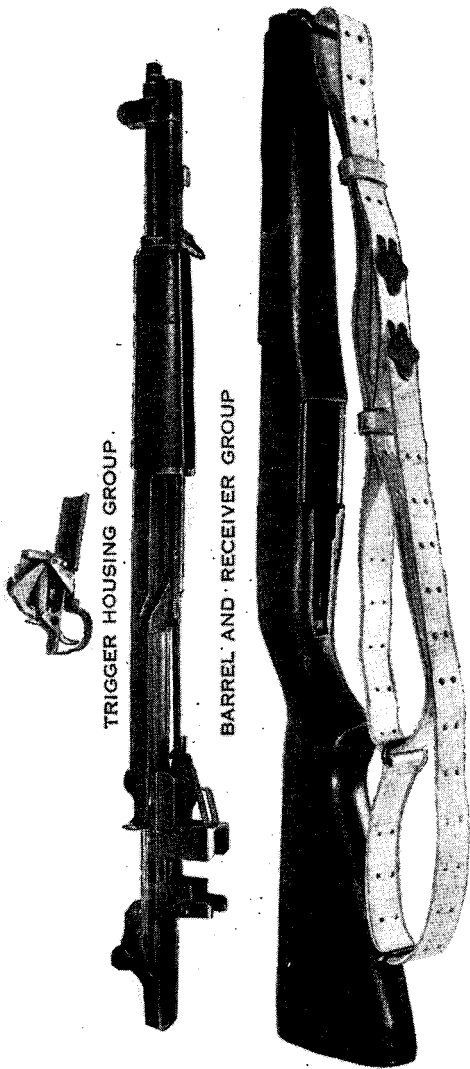

TRIGGER HOUSING GROUP.

BARREL AND RECEIVER GROUP

STOCK GROUP

Figure 5. The three main groups.

times. In combat, you may use a live round if the combination tool is not available.

Caution: When using a live round, use only the tip of the bullet.

10. METHOD OF DISASSEMBLY

Follow the step-by-step explanation in disassembling the rifle. It is disassembled into the three main groups first (fig. 5). After this, the barrel and receiver group and the trigger housing group are disassembled further.

11. THE THREE MAIN GROUPS

a. The three main groups are the trigger housing group, the barrel and receiver group, and the stock group.

b. To disassemble the rifle into the three main groups, grasp it with the left hand so that the base of the trigger housing is included in your grip. Place the rifle butt against your left thigh, sights to the left. With the thumb and forefinger of your right hand, pull downward and outward on the trigger guard. Swing the trigger guard out as far as it will go. Lift out the trigger housing group (fig. 6).

c. With your left hand, grasp the rear of the receiver and raise the stock. With your right hand, give a downward blow, grasping the small of the stock. This will separate the two groups (fig. 7).

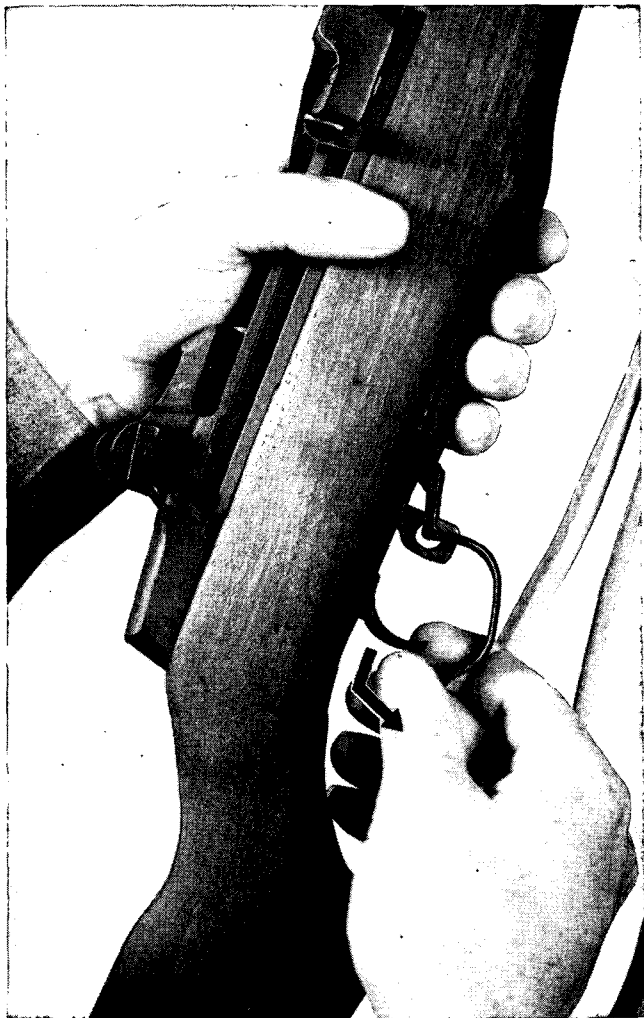

Figure 6. Removing the trigger housing group.

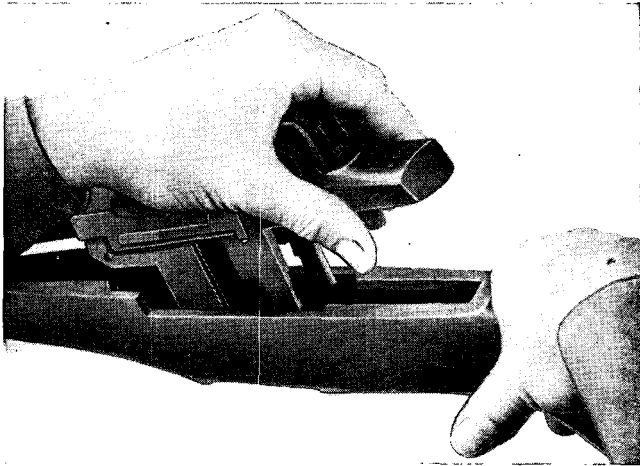

Figure 7. Separating the barrel and receiver group from the stock group.

12. BARREL AND RECEIVER GROUP

a. Place the barrel and receiver group on the table with the sights down, muzzle pointing to the left. Locate the follower rod. With the thumb and forefinger of your left hand, grasp the follower rod and disengage it from the follower arm by moving it toward the muzzle. You may have to lift up on the follower assembly. Remove the follower rod and operating rod spring by withdrawing them to the right (fig. 8). Do not separate these parts.

b. Using the drift of your combination tool, or the point of a dummy cartridge, push out the follower arm pin from the far side of the receiver toward your body (fig. 9).

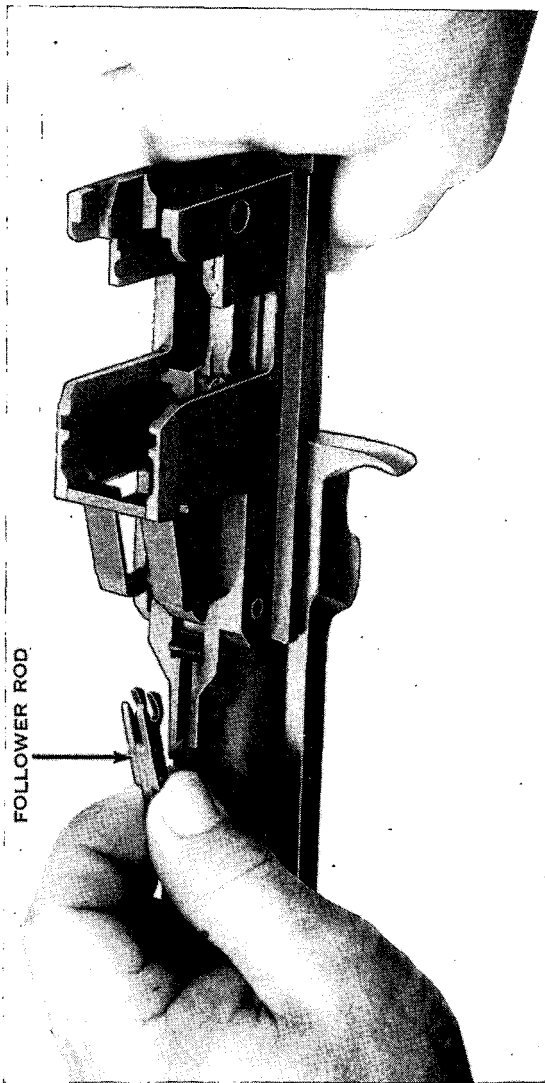

Figure 8. Removing the follower rod and operating rod spring.

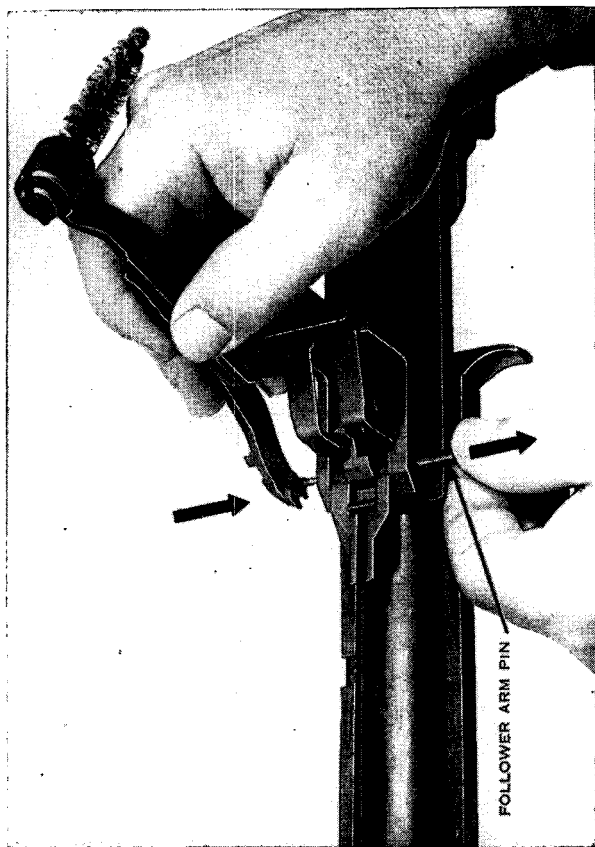

Figure 9. Removing the follower arm pin.

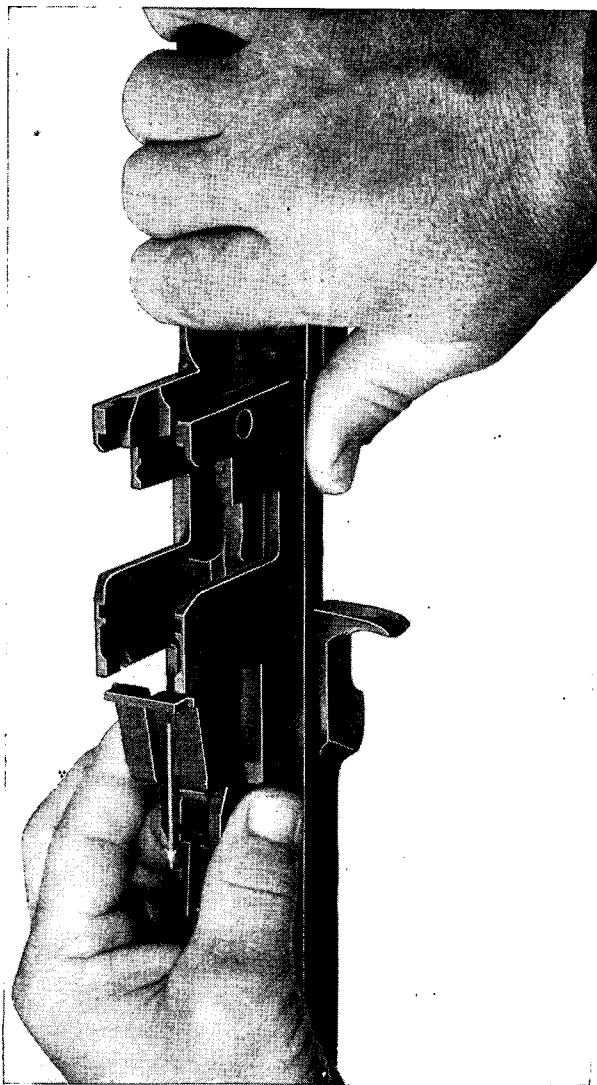

Figure 10. Removing the bullet guide, follower arm, and operating rod catch assembly.

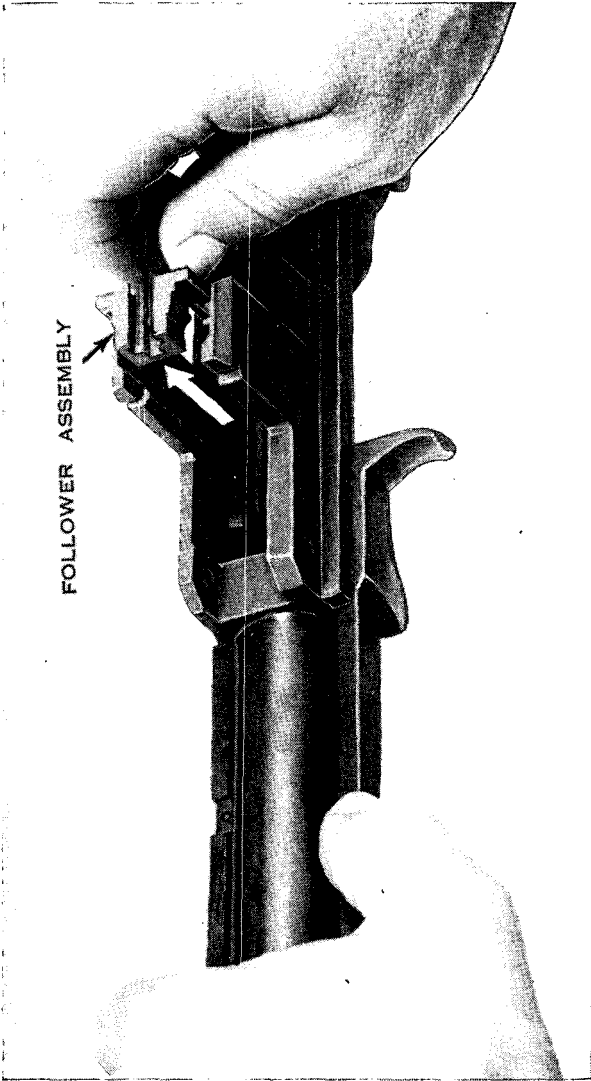

Figure 11. Removing the follower assembly.

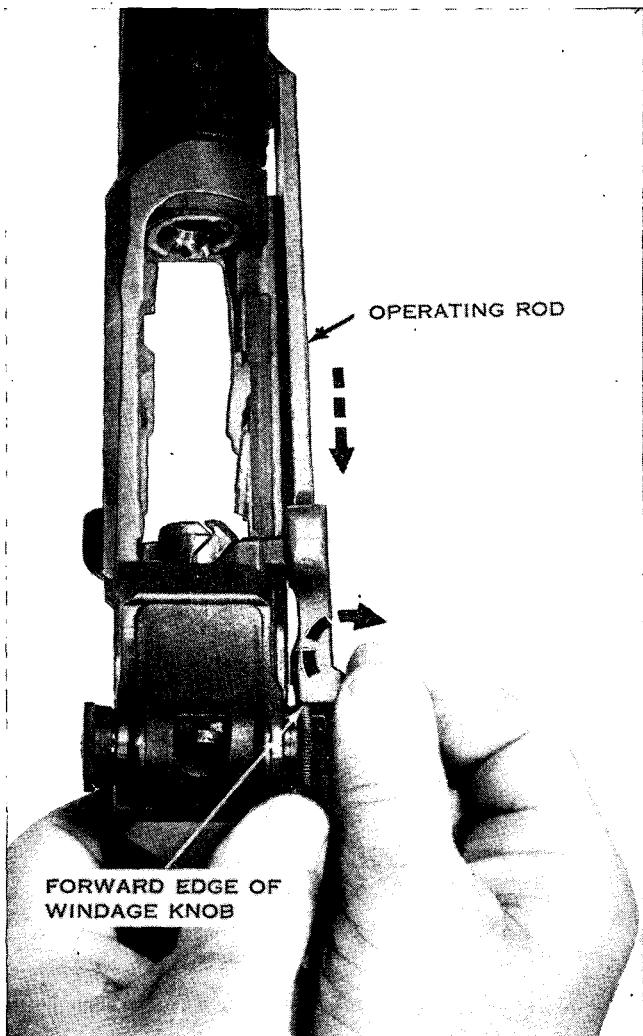

Figure 12. Removing the operating rod.

c. Grasp the bullet guide, follower arm, and the operating rod catch assembly, and lift them out of the receiver together (fig. 10). Separate and arrange these parts from left to right in the following order: follower arm, operating rod catch assembly, and bullet guide.

d. Reach down into the receiver and lift out the follower assembly (fig. 11). Do not separate the slide from the follower.

e. Turn the barrel and receiver group over so that the sights are up, muzzle pointing away from you. With your left hand, raise the rear of the group. With the right hand, pull the operating rod to the rear until the rear of the handle is directly under the forward edge of the windage knob. Grasp the handle with the thumb and forefinger of the right hand; and with an upward and outward pressure, disengage the guide lug of the operating rod through its dismount notch on the receiver. Remove the operating rod (fig. 12).

Note. The operating rod has been intentionally bent. Do not attempt to straighten it.

f. Grasp the bolt by the operating lug and, while sliding it from rear to front, lift it upward and outward to the right front with a slight rotating motion (fig. 13).

g: Hold the bolt in your left hand with the operating lug to the right so that the little finger is under the tang of the firing pin and the thumb is over the ejector. This is important because the ejector may fly out and become lost if you do not hold it with your thumb. Insert the screwdriver

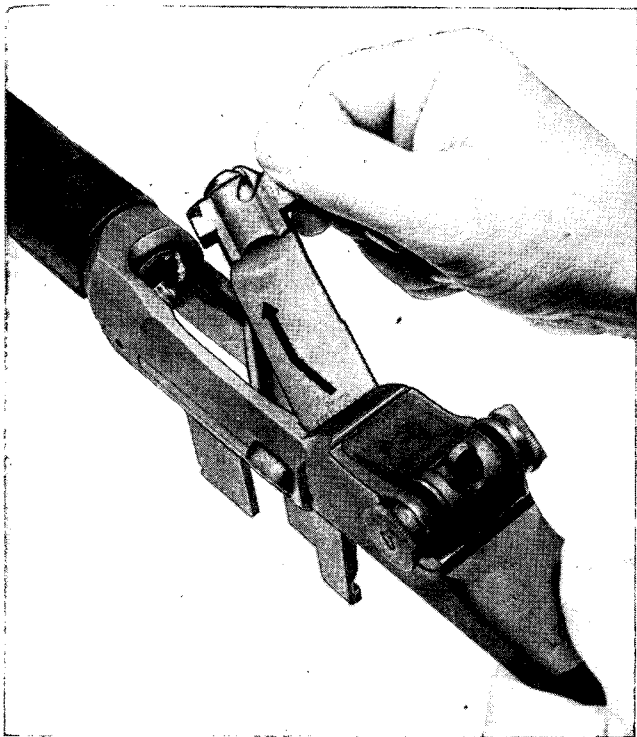

Figure 13. Removing the bolt.

blade of the combination tool between the extractor and the lower cartridge seat flange. Twist the screwdriver blade against the extractor and unseat it (fig. 14). The ejector will snap up against your left thumb. Remove the extractor and the extractor spring and plunger. Lift out the ejector and ejector spring. Do not separate the ejector

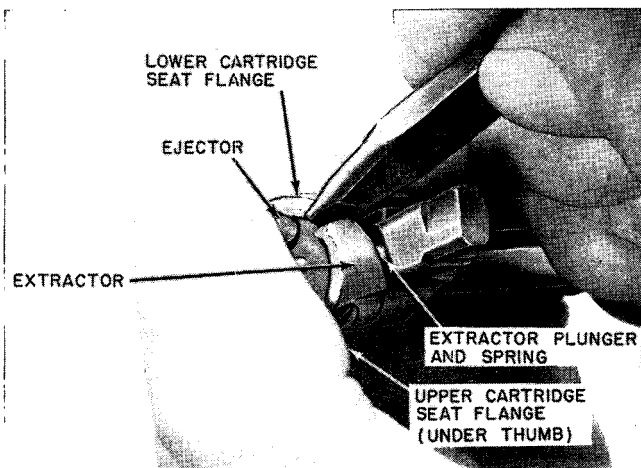

Figure 14. Unseating the extractor.

from its spring nor the extractor plunger from its spring (fig. 15).

h. Remove the firing pin from the rear of the bolt (fig. 16).

i. In figure 17, you see the parts of the barrel and receiver group that you have disassembled in the order in which they should be laid out.

13. REAR SIGHT (fig. 18)

a. You may disassemble the rear sight only when supervised by a commissioned officer. To disassemble it, place the barrel and receiver group on a flat surface so that the sights are up. Lower the aperture as far as it will go. Check the read-

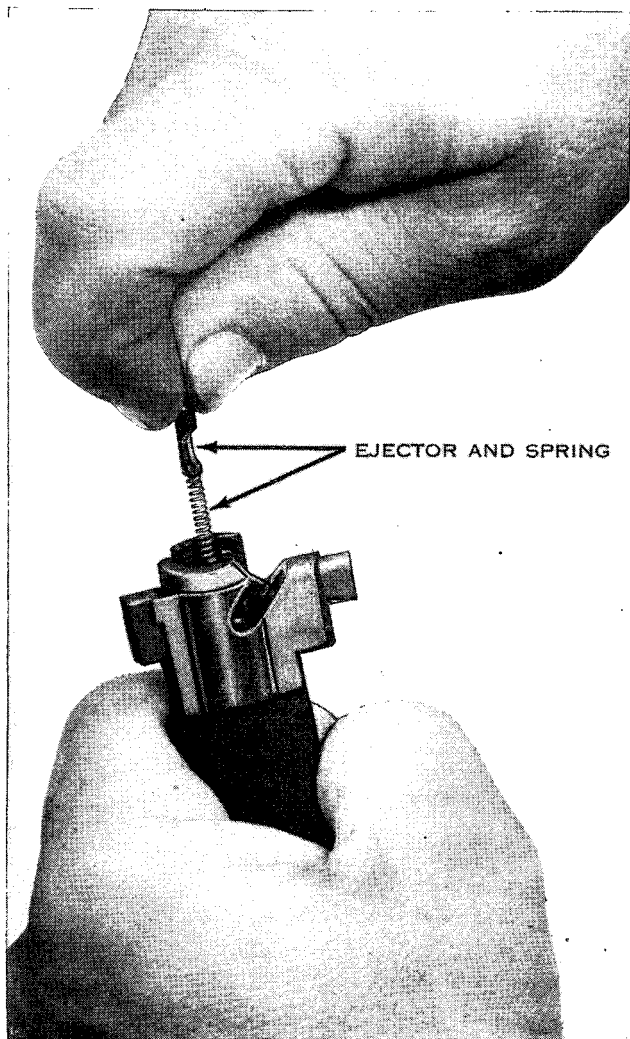

Figure 15. Removing the ejector and spring.

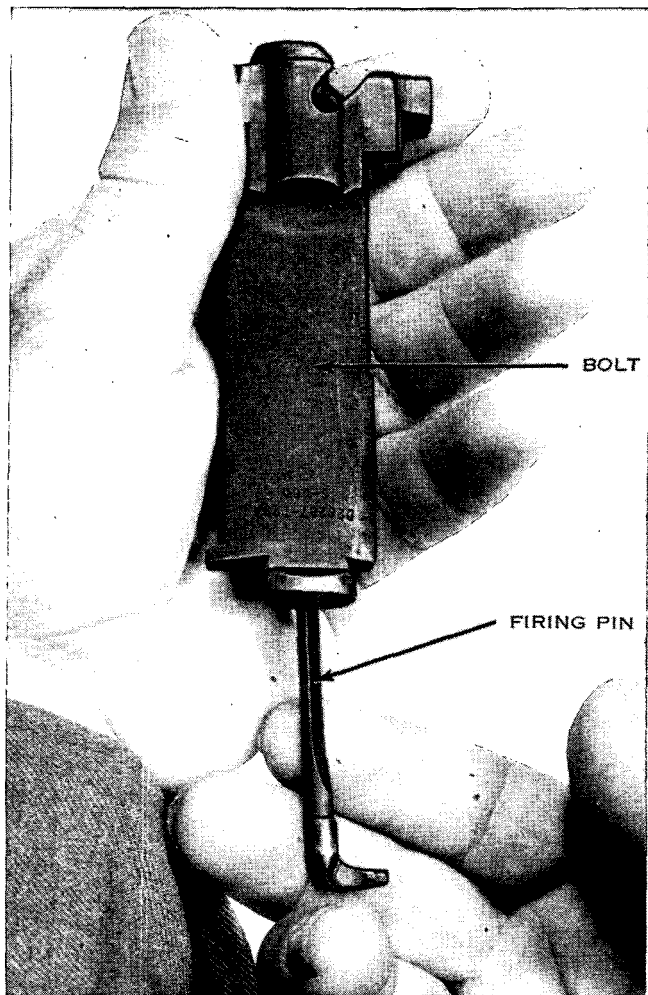

Figure 16. Removing the firing pin.

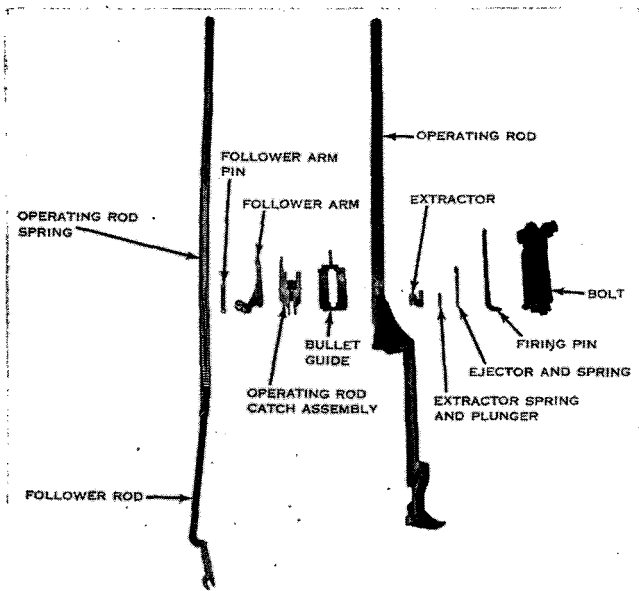

Figure 17. Parts of the barrel and receiver group in their order of disassembly.

ing on the rear sight elevating knob and write it down. You will need this reading when you replace the rear sight elevating knob.

b. Place the barrel and receiver group on its right side, muzzle to the left. Using the combination tool, remove the rear sight elevating knob screw and the elevating knob. Turn the barrel and receiver group on its left side. The rear sight locking nut can be removed with a pair of pliers.

Note. The elevating pinion has been counterbored on the threaded end to permit spreading after assembly. Frequent disassembly will cause stripping of the threads

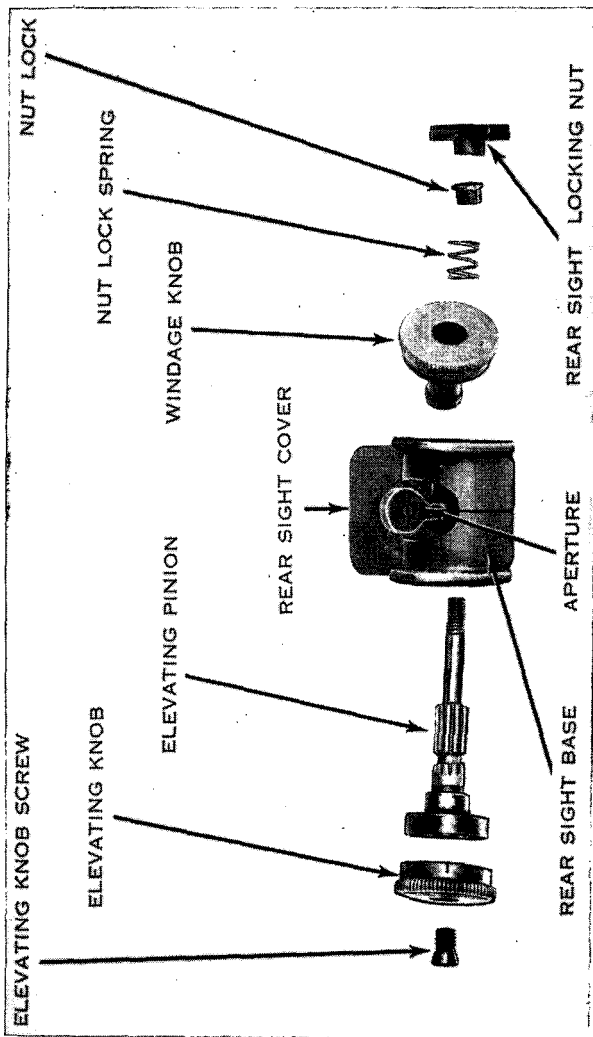

Figure 18. Parts of the rear sight.

on the pinion; the rear sight, therefore, is disassembled only to replace parts or to clean it after use in very bad weather such as a heavy rain, sand and dust storms, or submersion in salt water.

Unscrew and remove the rear sight locking nut. Unscrew and remove the windage knob, taking care that the rear sight nut lock and spring, which are inside the windage knob, do not become lost. Tap the windage knob lightly to remove the nut lock and spring. Turn the barrel and receiver group so that the sights are up, the muzzle pointing to the front. Pull out the rear sight elevating pinion from the left side of the receiver. Pull the aperture up about one-half inch. Place your right thumb under the top of the aperture and push forward and upward to remove the aperture cover and base. Separate the rear sight cover from the rear sight base.

c. The new modified rear sight eliminates the cross bar on the rear sight locking nut and the counterbored end of the pinion (fig. 19). The modified sight may be disassembled as follows: Run the aperture all the way down and record the reading, as you will use this reading when assembling the sight. Hold the elevating knob and unscrew the nut in the center of the windage knob with the forked end of the combination tool or the rim of a cartridge. You can loosen this nut but you cannot remove it, so there is no danger of losing it. Withdraw the elevating knob to the left, removing the elevating knob assembly, including the pinion shaft, elevating knob and screw, and other parts, all of which are made into one piece and cannot be separated. (Like the rear

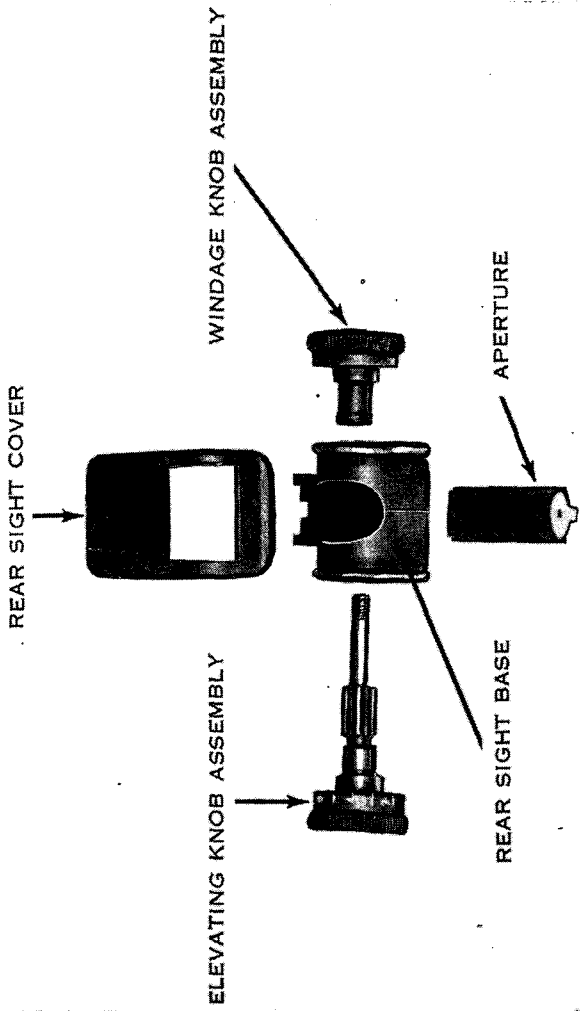

Figure 19. Parts of the modified sight.

sight nut, the elevating knob screw can be unscrewed until it is loose, but it cannot be removed.) Unscrew the windage knob until it can be removed. The aperture, base, and cover are removed as already described for the other type sight.

14. CLIP LATCH

You may disassemble the clip latch only when supervised. To disassemble it, place the receiver on its right side with the muzzle pointing to the left (fig. 20). With the thumb of your left hand, depress the clip latch. This relieves the tension of the clip latch spring. Using the point of a bullet or the drift of your combination tool, push forward on the clip latch pin and unseat it. Remove it by withdrawing it with your finger tips. Lift out the clip latch with the clip latch spring attached. Place the parts on a smooth surface in the order that you remove them.

15. TRIGGER HOUSING GROUP

a. You may disassemble the trigger housing group only when supervised. To disassemble it, close and latch the trigger guard. Squeeze the trigger, allowing the hammer to go forward. Hold the trigger housing group with the first finger of the right hand on the trigger and the thumb against the sear. Place the front of the trigger housing against a firm surface. Squeeze the trigger with your finger and push forward on the sear with the thumb. At the same time, using

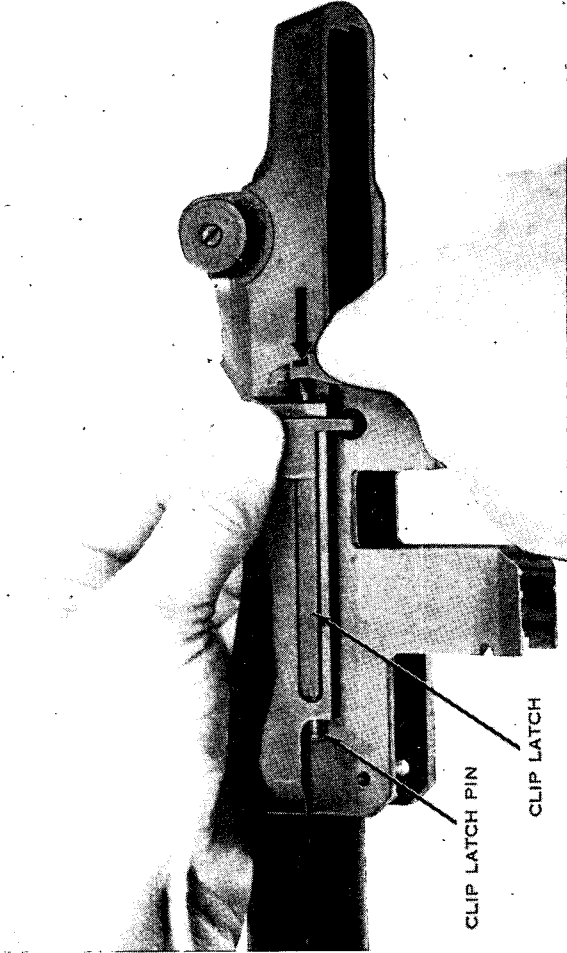

Figure 20. Removing the clip latch.

the drift of the combination tool or the tip of a dummy cartridge, push out the trigger pin from left to right (fig. 21). Slowly release the pressure with your finger and thumb. This allows the hammer spring to expand.

b. Lift out the trigger assembly. Remove and separate the hammer spring plunger, hammer spring, and the hammer spring housing (fig. 22).

c. Using the combination tool or a dummy round, push out the hammer pin from left to right. Move the hammer a little to the rear and lift it out (fig. 23).

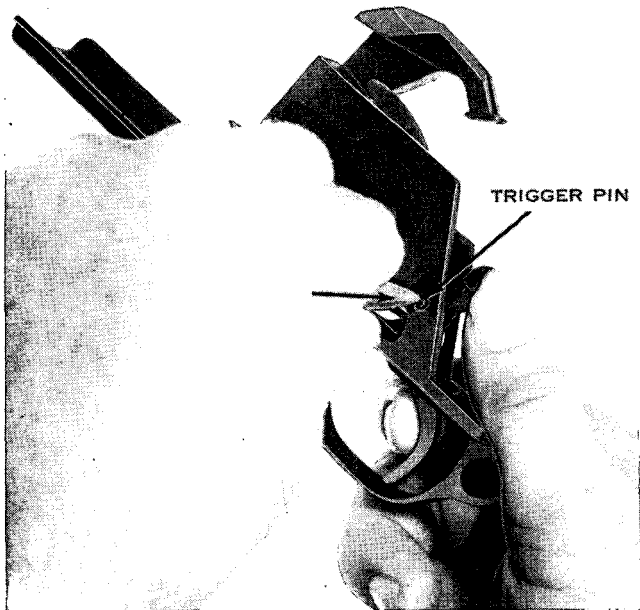

Figure 21. Removing the trigger pin.

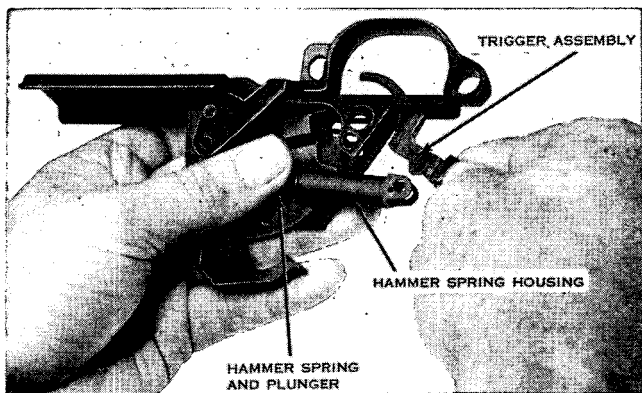

Figure 22. Removing the trigger assembly, hammer spring housing, hammer spring, and hammer spring plunger.

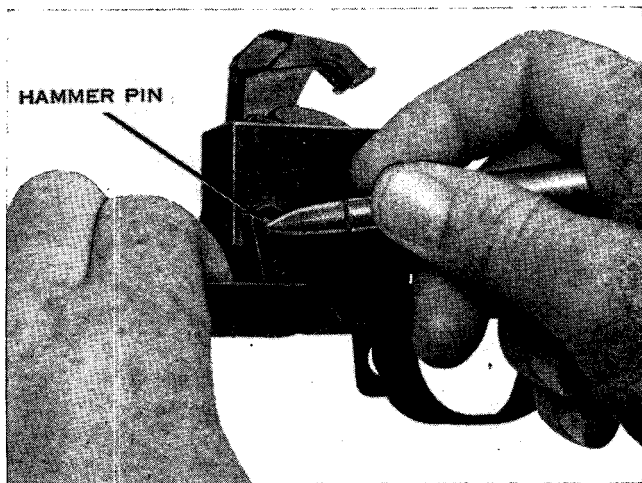

Figure 23. Removing the hammer pin and hammer.

d. Unlatch the trigger guard. Lay the trigger housing on its right side. With the drift of your combination tool, or the point of a bullet, push out the stud of the safety from its hole. Remove the safety by lifting it from its slot in the base of the trigger housing (fig. 24).

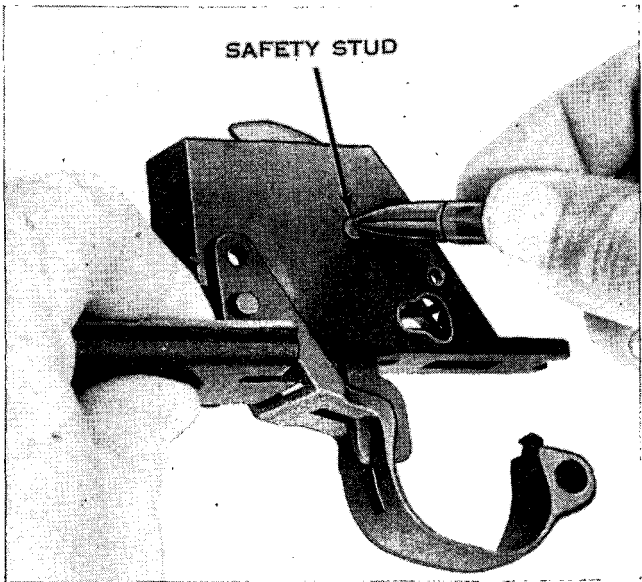

Figure 24. Unseating the safety.

e. Hold the rear of the trigger housing with your left hand and the trigger guard with your right hand. Swing the trigger guard down into the opened position. Slide the trigger guard to the rear until the wings of the trigger guard are aligned with the safety stud hole. Rotate the trigger guard to the right and upward with your

right hand until the hammer stop inside of the right wing clears the base of the trigger housing. Remove the trigger guard (fig. 25).

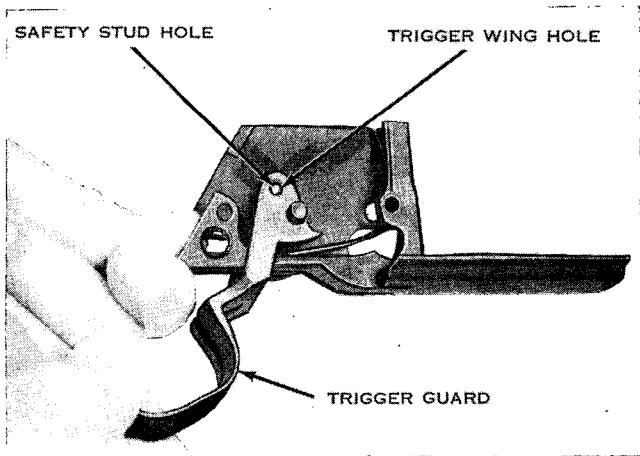

Figure 25. Removing the trigger guard.

f. Lay the trigger housing on its right side. Insert the point of a bullet or the screw driver blade of the combination tool in the hole by the loop of the clip ejector. Push downward on the clip ejector and unseat it (fig. 26).

16. GAS CYLINDER

a. Using the screw driver blade of your combination tool, unscrew and remove the gas cylinder lock screw (fig. 27) with valve assembly. If you are supervised, you may now unscrew and remove the gas cylinder lock (fig. 28).

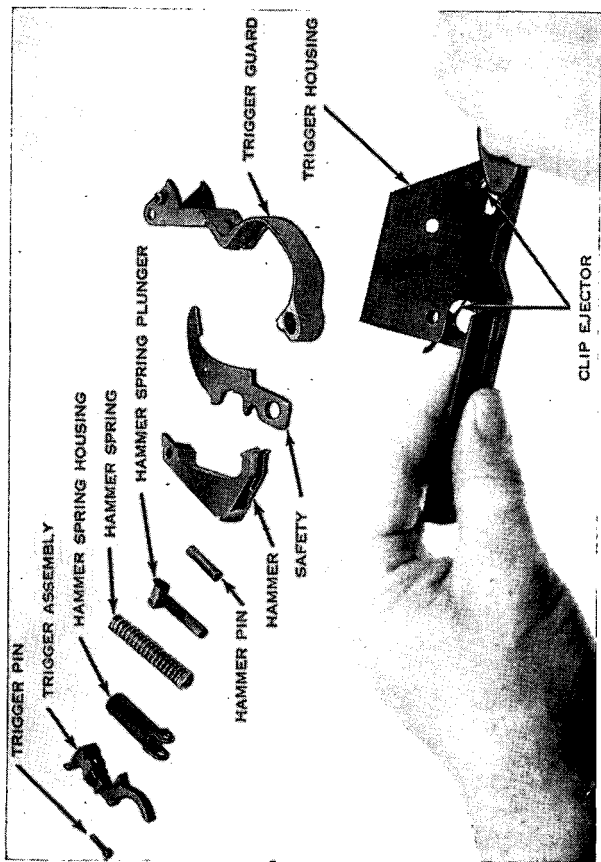

Figure 26. Removing the last part—the clip ejector.

b. Do not remove the gas cylinder except when necessary. Before removing the gas cylinder, be sure that the operating rod has been removed. To remove the gas cylinder, tap lightly toward the muzzle on the *bayonet stud* with a piece of wood or similar soft object until the gas cylinder is loosened. Remove the gas cylinder (fig. 29). Be careful that the splines are not burred or dam-

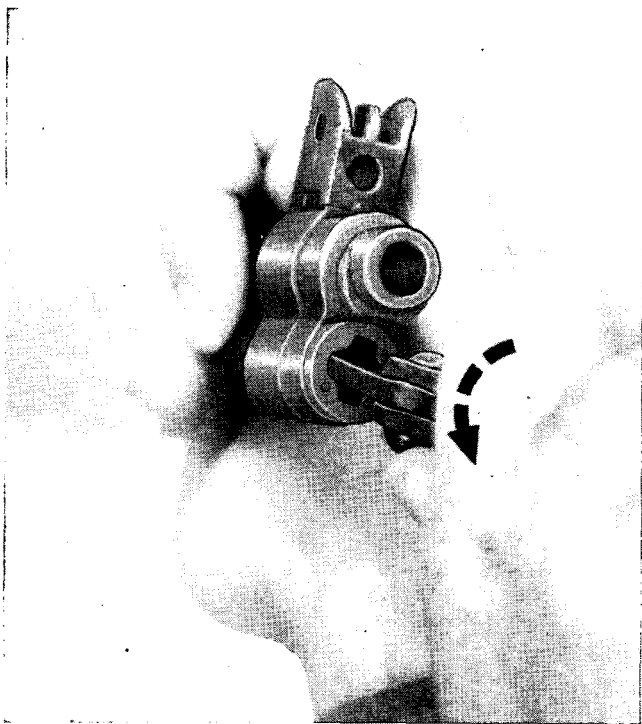

Figure 27. Removing the gas cylinder lock screw with valve assembly.

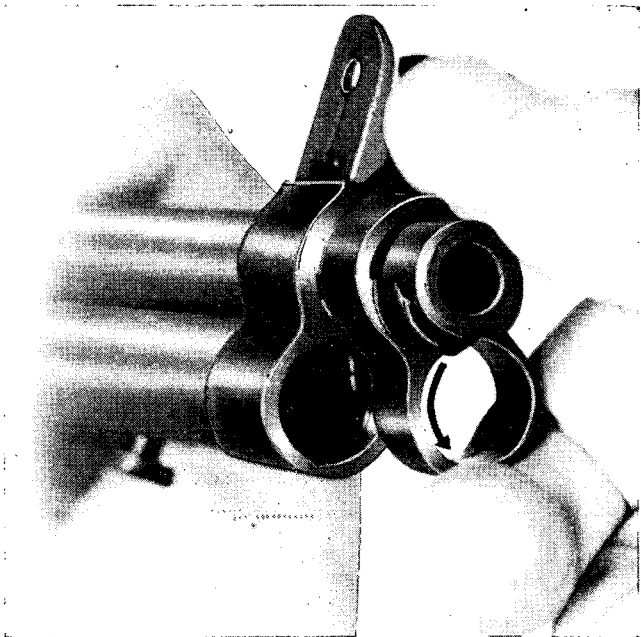

Figure 28. Removing the gas cylinder lock.

aged. Do not remove the front sight or make any attempt to adjust the front sight.

Note. On rifles with gas cylinders that have been modified by a cut that extends from the front sight base dovetail downward to the lower splines, it is necessary to loosen the front sight screw before attempting to remove the gas cylinder. Otherwise, the barrel and gas cylinder may be damaged.

17. ASSEMBLING

Your rifle and its component groups are assembled in the reverse order of their disassembly ;

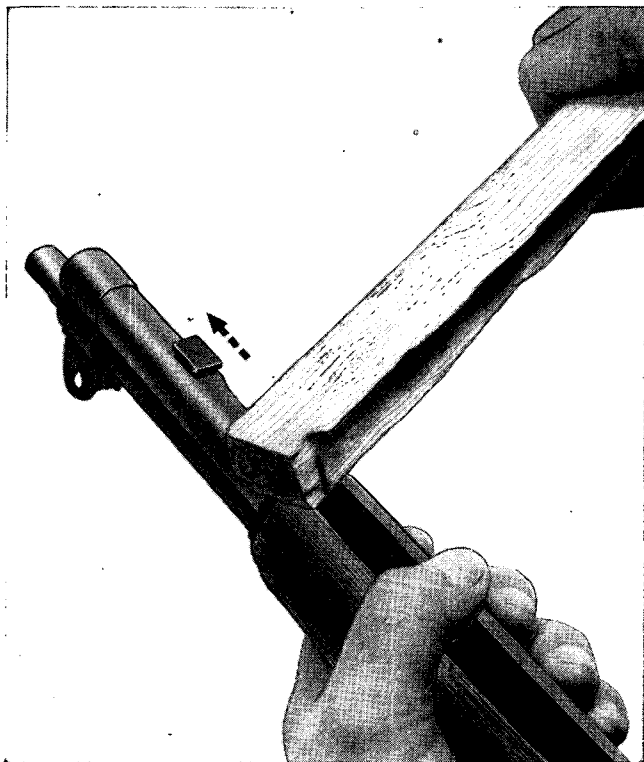

Figure 29. Removing the gas cylinder.

for this reason you lay out the parts in the order that you remove them.

18. REPLACING THE GAS CYLINDER, GAS CYLINDER LOCK, AND THE GAS CYLINDER LOCK SCREW

a. Place the gas cylinder over the barrel. Make sure that the splines are alined with their grooves.

Replace the gas cylinder as far as it will move easily. If tapping is necessary, tap lightly on the *bayonet stud* with a piece of wood.

b. Engage the threads of the gas cylinder lock with those on the barrel and screw it on by hand until it is finger tight (do not use a tool). If the lock is not aligned with the gas cylinder, do not force it, but unscrew it until it is aligned.

c. Replace the gas cylinder lock screw. Tighten by using the screw driver blade of your combination tool. Keep this screw tight at all times, because a loose gas cylinder lock screw may prevent your rifle from firing semiautomatically.

19. TRIGGER HOUSING GROUP

a. Hold the trigger housing in your right hand, with the left side down and the rear end to the right. Place the clip ejector in position in the trigger housing with the short arm toward your body and the tip of the long arm in its slot in front of the trigger housing. The loop of the clip ejector is positioned on top of its stud on the left side of the trigger housing. With your right thumb, hold the loop of the clip ejector on top of this stud. With the forefinger of your left hand, hold the long arm up in its slot on the front of the trigger housing. Place the tip of your left thumb between the long arm and the base of the trigger housing and move the long arm toward your body, at the same time exerting pressure downward. The long arm of the clip ejector will snap into the notch on the base of the trigger housing (fig. 30).

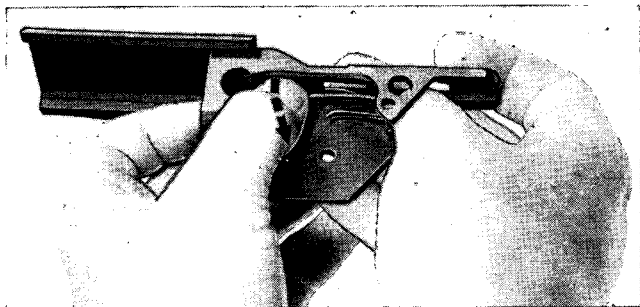

Figure 30. Replacing the clip ejector.

b. To replace the trigger guard, hold the trigger housing as shown in figure 25. Place the wings of the trigger guard astride the base of the trigger housing so that the hammer stop, on the inside of the right wing, clears the base. Turn the trigger guard down and to the left until the holes in the wings are under the safety stud hole. Slide the trigger guard forward until the holes in the wings are alined with the hammer pin hole.

c. Insert the finger piece of the safety through its slot in the base of the trigger housing. To reseat the safety stud in its hole in the trigger housing, force the safety down against the pressure of the short arm of the clip ejector. Push the finger piece of the safety forward.

d. Insert the hammer loosely in position, holding it halfway between the cocked and fired position. Be sure that the hammer toe clears the hammer stop on the right wing of the trigger guard. Aline the hammer pin holes in the hammer with the holes in the trigger housing and trigger guard.

Be sure that the trigger guard is not latched. Insert the hammer pin from the right side. Move the hammer to the fired position. Close and latch the trigger guard.

e. Place the trigger housing group on the table with the base down and the rear end to the right. Assemble the hammer spring housing, hammer spring, and hammer spring plunger into one unit. Place the plunger in its seat on the hammer. Make sure that the open side of the hammer spring housing is toward the safety. (This is important because failure to do this prevents the

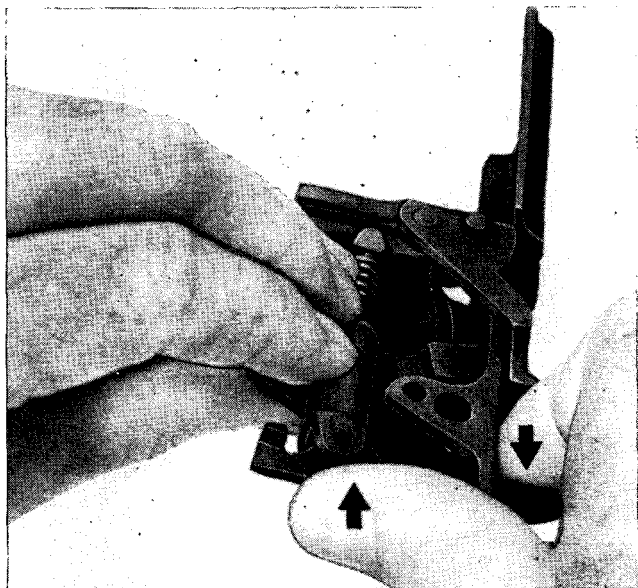

Figure 31. Replacement of the trigger assembly, hammer spring housing, hammer spring, and hammer spring plunger.

safety from being used; also the sear will not function.) Hold these assembled parts in a raised position with the thumb and fingers of your left hand. With your right hand, insert the trigger into the trigger slot so that the notch at the curved rear surface of the finger piece bears against the rear of the slot in the trigger housing. Place the wings of the hammer spring housing astride the sear pin. With your right forefinger on the trigger and the right thumb against the sear, apply pressure forward against the sear and at the same time squeeze the trigger. Hold the parts in this position and insert the trigger pin as far as its head only (fig. 31).

f. To seat the head of the trigger pin, hold the trigger housing group as shown in figure 32. Note the direction the pin must be moved to be seated. By applying pressure with the thumb and fingers,



Figure 32. Seating the trigger pin.

aline the head of the trigger pin with the trigger pin holes. Seat the trigger pin by pressing on its head with the left thumb.

20. CLIP LATCH

Place the clip latch with the clip latch spring attached in position on the left side of the receiver and start replacing the clip latch pin from the front. Press in on the thumb piece of the clip latch to relieve the tension of the clip latch spring, and push the clip latch pin fully home. If the pin head is not fully seated, it will damage the stock.

21. REAR SIGHT

a. Assemble the rear sight cover and rear sight base into one unit. Place the rear lip of the sight cover in its slot at the rear end of the sight bracket. Press down against the front part of the sight cover, seating it in its slot in the front end of the sight bracket. Insert the aperture in its slot in the rear sight base. Slide the aperture to its lowest position. Holding the rear sight base forward against the rear sight cover, insert the elevating pinion through the left side of the receiver, taking care that it meshes with the teeth of the aperture. Insert the windage knob into the right side of the receiver. Move the sight base to the left until the index line shows at the left edge of the windage gage. Screw the windage knob into the rear sight base until the zero mark on the rear sight base is aligned with the center

line of the windage scale on the receiver. Lay the rifle on its left side. Place the rear sight nut lock spring and nut lock in position in the windage knob around the threaded end of the elevating pinion, *taking care that the flat cut on the elevating pinion is alined with the flat portion of the nut lock.* Screw the rear sight nut onto the elevating pinion until the desired tension is obtained on both the elevating knob and the windage knob. When this nut is tightened too much, the elevating and windage knobs become locked and cannot be turned. Lower the aperture as far as it will go by turning the elevating pinion. Replace the elevating knob and rotate it to the reading that was noted before the part was disassembled. Holding it in this position, replace the elevating knob screw. In tightening the elevating knob screw, run the aperture up to its highest position and set the screw as tightly as possible. Now run the sight down and recheck the knob reading. Be careful when starting the rear sight locking nut on the pinion so that you do not damage the threads. If you can remove the rear sight locking nut without using pliers or a small wrench, the end of the pinion should be respread, using the punch that is provided for this purpose. A very light tap of a hammer is enough to expand the end of the shaft. The company armorer artificer is authorized to do this.

b. To assemble the modified rear sight, first replace the base, cover, and aperture as described for the other sight. Screw the windage knob in until it takes hold and draws the base to the

center position on the windage gage. Insert the elevating knob and pinion shaft from the left, meshing the pinion with the teeth on the aperture. The flat portion of the elevating pinion shaft must pass through a D-shaped hole in the lock which is located inside the windage knob assembly adjacent to the slotted rear sight nut. With the aperture all the way down, adjust the elevating pinion until the recorded setting (before disassembly) is on the rear sight. Screw in the rear sight nut with the forked end of the combination tool. Screw it in as far as it will go, then turn it back a fraction of a turn until any change on the rear sight clicks distinctly; the assembly is then completed.

22. BARREL AND RECEIVER GROUP

a. To assemble the bolt, you may use the extractor seating device on the combination tool, the soft leaded end of the chamber cleaning brush, or the point of a dummy or live cartridge. When the extractor seating device is used properly, the extractor and ejector may be seated very easily. However, because some men have difficulty in learning how to use this device and because you must be able to assemble the bolt without the combination tool, two methods will be described.

- (1) *First method.* Insert the firing pin in the bolt, making sure that the tang of the firing pin enters its slot in the rear of the bolt. Grasp the bolt in your left hand with the face of the bolt upward and the operating lug to the right. Re-

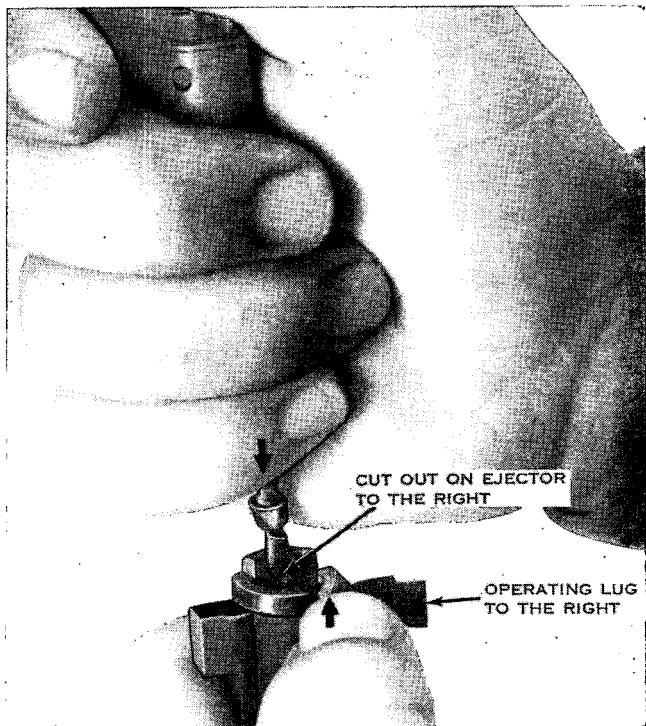

Figure 33. Assembling the bolt, first method.

place the ejector and the ejector spring into the bolt with the ejector spring down. Turn the ejector so that the cut is toward the operating lug of the bolt. Replace the extractor spring and plunger (spring first) into their hole in the bolt. Put the stud of the extractor into its hole in the bolt. With your left thumb press lightly on the extractor so that it

begins to ride over the extractor plunger. Grasp the chamber cleaning brush in your right hand with a firm grip. Use the tip of the brush the same way that you use a stick, a nail, the base or tip of a dummy round, or the tip of a live round.

Caution: Do not use the primer end of a live round.

Using the soft lead tip of the cleaning brush, depress the ejector into the face of the bolt, (fig. 33). With the thumb of the left hand, push the extractor into the bolt until it is fully seated.

- (2) *Second method.* (Using the extractor seating device of the combination tool.) Replace the firing pin, ejector and spring, extractor plunger and spring, and the extractor as described in the

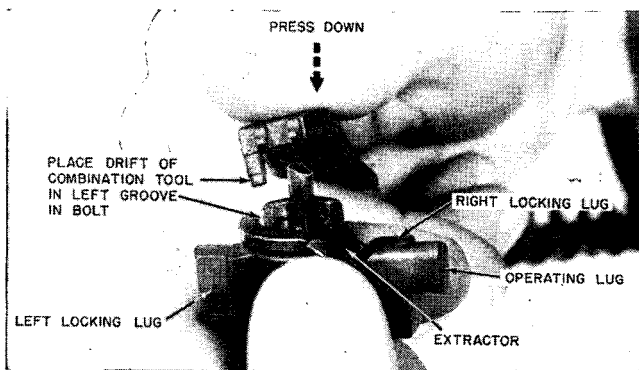
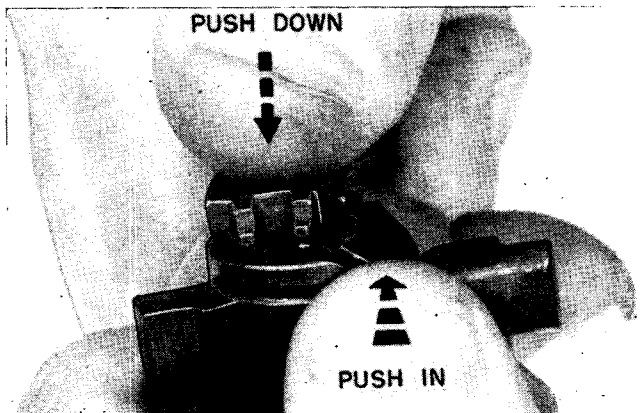

Figure 34. Assembling the bolt, second method.

preceding paragraph. Place the drift of the combination tool in the left groove of the bolt and hold the combination tool at a right angle to the locking and operating lugs of the bolt as shown in figure 34. Press downward on the combination tool until the ejector is forced into the face of the bolt then, with your left thumb, press inward on the extractor, seating it.

Caution: In either method when assembling the bolt, be careful to keep your face away from over the bolt because the ejector might fly out from under the tool that you are using.

b. To replace the bolt (fig. 13), hold the barrel and receiver with the sights up and the muzzle pointing away from you. Hold the bolt by the operating lug so that the front end of the bolt is



②
Figure 34—Continued.

slightly above and to the right of its extreme forward position in the receiver. Insert the rear end in its bearing on the bridge of the receiver. Rotate the bolt in a counterclockwise direction as far as necessary to permit the tang of the firing pin to clear the top of the bridge. Guide the left locking lug of the bolt into its groove on the left side of the receiver. Lower the right locking lug on its bearing and slide the bolt to its rearmost position.

c. Place the barrel and receiver in front of you so that the sights are up and the muzzle is pointing to the front. Tilt the barrel and receiver to the left, then, holding the operating rod at the handle, place the head of the piston into the gas cylinder about three-eighths of an inch. Adjust the operating rod so that the recess in the hump fits over the operating lug of the bolt (fig. 35). While applying pressure downward and inward on the handle, move the operating rod forward until the guide lug is engaged in its groove. Move the bolt forward until it is closed.

d. Turn the barrel and receiver group so that the sights are down. With the follower slide down, replace the follower assembly so that its guide ribs fit into their grooves in the receiver, the square hole in the follower to the rear. The slide will now rest against the bolt.

e. With your left hand, replace the bullet guide (fig. 36) so that the shoulders of the bullet guide fit into their slots in the receiver and so that the hole in the toe of the bullet guide is in alignment with the holes in the receiver.

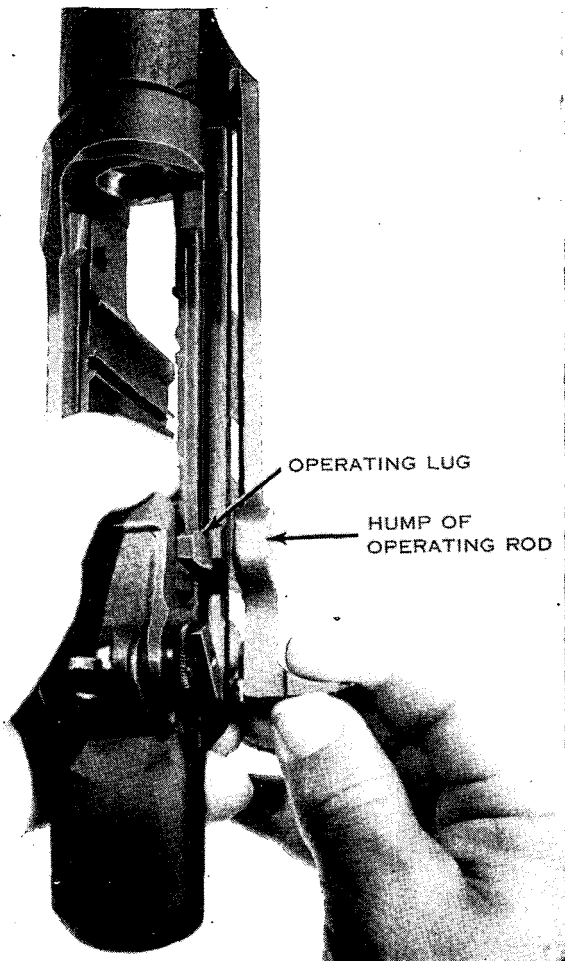

①

Figure 35. Replacing the operating rod.

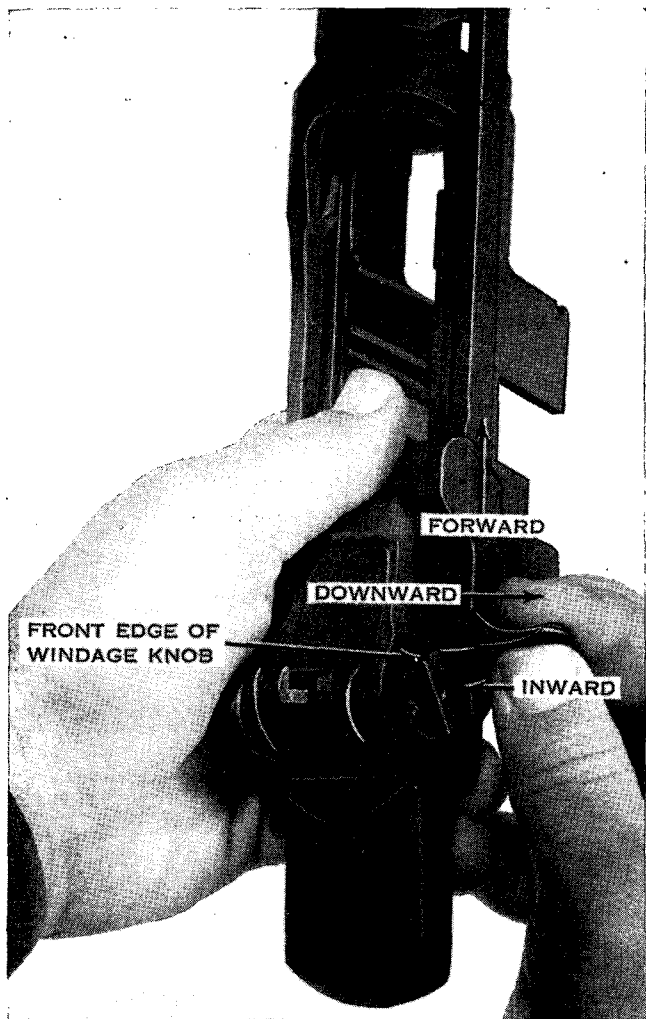

②
Figure 35—Continued.

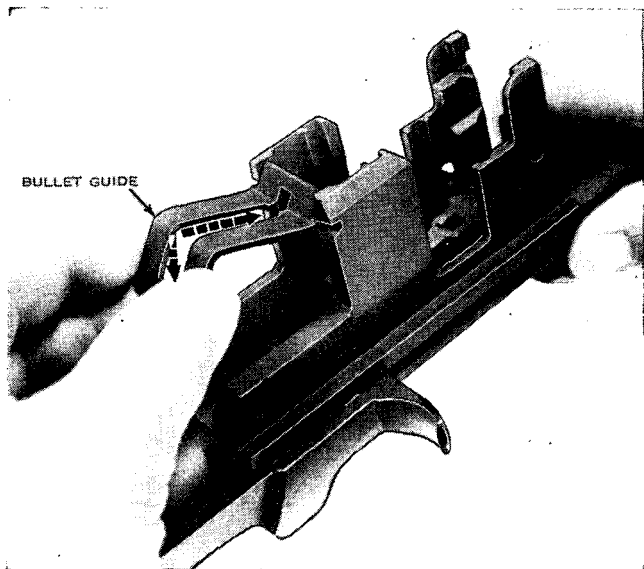

Figure 36. Replacing the bullet guide.

f. With your right hand, swing up the lower part of the bullet guide slightly. With the left hand, insert the long rear arm of the operating rod catch assembly through the clearance cut in the bullet guide. Make sure that the rear of the long arm is underneath the front stud of the clip latch which projects into the receiver (fig. 37). Lower the bullet guide into place. To test for correct assembly, press down on the front arms of the operating rod catch. When released, they should spring back into place.

g. Replace the follower arm by passing its studded end through the bullet guide and inserting the studs in the grooves in the follower (fig.

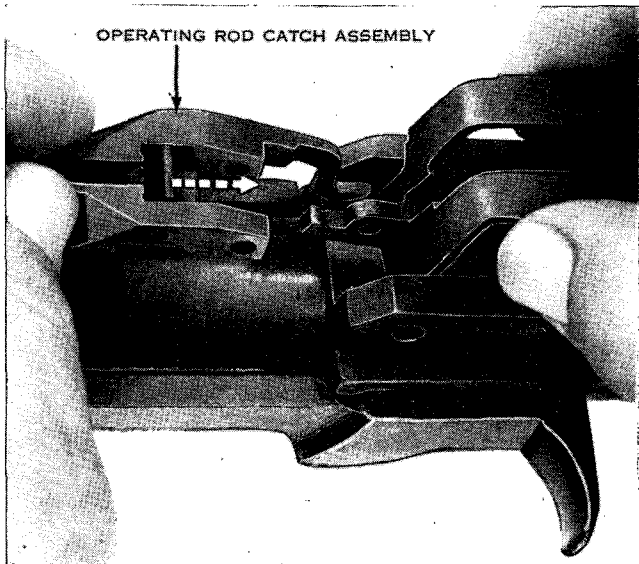

Figure 37. Replacing the operating rod catch assembly.

38). Place the forked end of the follower arm astride the toe of the bullet guide. Aline the holes in the operating rod catch, follower arm, and bullet guide with those in the receiver. Replace the follower arm pin.

h. Insert the operating rod spring into the operating rod. Grasp the follower rod with the fingers of your left hand. Make sure that the hump of the follower rod is toward the barrel. Push toward the muzzle, compressing the operating rod spring, and hook the claws of the follower rod with the front studs of the follower arm (fig. 39). You may have to raise the follower assembly



Figure 38. Replacing the follower arm.

a little to do this. Check to see that the hump of the follower rod is in the slot between the forward arms of the operating rod catch assembly. The straight part of the follower rod will then be parallel to the barrel.

23. ASSEMBLING THE THREE MAIN GROUPS

a. With the barrel and receiver group on the table, sights down, pick up the stock group and locate the **U**-shaped flange of the stock ferrule.

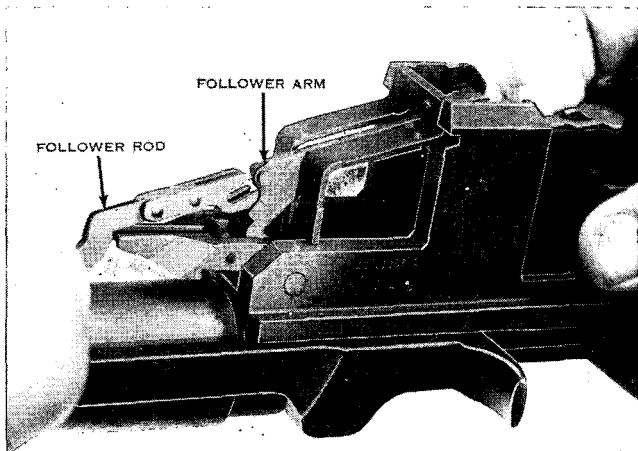

Figure 39. Replacing the follower rod and operating rod spring.

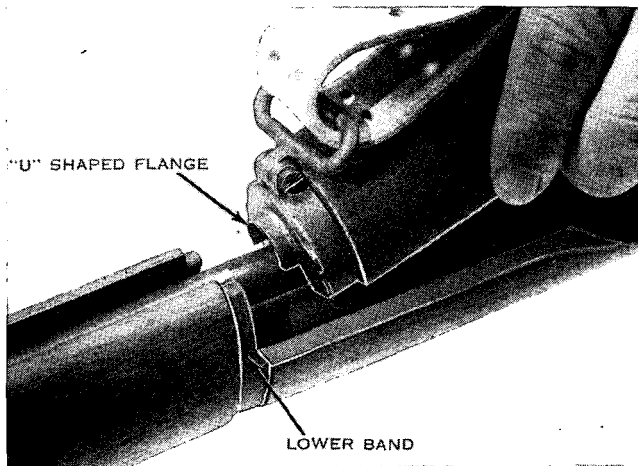

Figure 40. Replacing the stock on the barrel and receiver group.

Hold the stock so that the sling is up. Engage this U-shaped flange into the lower band, then lower the stock group down onto the barrel and receiver group (fig. 40).

b. Unlatch and open the trigger guard; keeping the base of the trigger housing level, place it straight down into the receiver, making sure that the locking lugs on the trigger guard enter the recesses in the receiver (fig. 41). Close and latch the trigger guard.

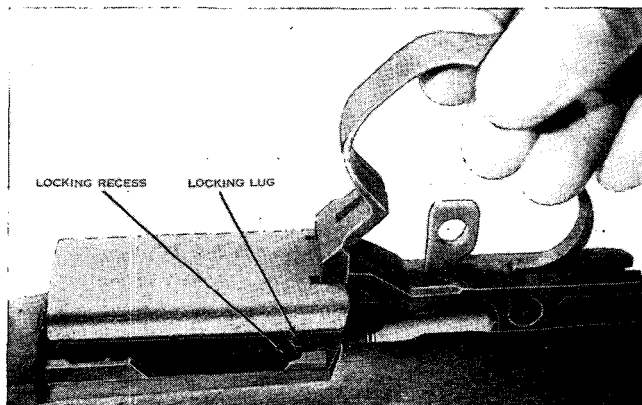

Figure 41. Replacing the trigger housing group.

24. TO TEST FOR CORRECT ASSEMBLY

To test the assembly of your rifle, pull the operating rod to its rearmost position. The bolt should stay open. Close the bolt and snap the safety to its locked position. Squeeze the trigger. The hammer should not fall. Push the safety forward and squeeze the trigger. The hammer should fall.

Section II. HOW THE RIFLE WORKS

25. GENERAL

a. By taking your rifle apart and putting it together, you have become familiar with its parts. Next, you must learn how these parts function. If you understand how your rifle works, you will be able to clear any stoppages that may occur. This knowledge will also give you confidence in your rifle and will enable you to keep it in working order.

b. Each time a cartridge is fired, many parts inside the rifle work in a given order. This is known as the *cycle of functioning*. This cycle is almost the same in all semiautomatic weapons.

c. To help you understand the cycle of functioning, it is broken down into eight basic steps. Keep in mind that more than one step may be occurring at the same time. The steps are listed below in the order that they begin.

- (1) Feeding—moving the cartridge into the path of the bolt.
- (2) Chambering—moving the cartridge into the chamber.
- (3) Locking—locking the bolt in the receiver.
- (4) Firing—driving the firing pin forward to strike the primer cap, which sets off the cartridge.
- (5) Unlocking—unlocking the bolt from the receiver.
- (6) Extraction—pulling the empty cartridge case from the chamber.

- (7) Ejection—throwing the empty cartridge case from the rifle.
- (8) Cocking—pushing the hammer into the cocked position.

26. FUNCTION OF THE TRIGGER HOUSING GROUP

a. As the rifle begins to function when you squeeze the trigger, you first learn how the trigger housing group works.

- (1) Remove the trigger housing group (fig. 42). Close and latch the trigger guard and cock the hammer. The hammer is held in the cocked position by the trigger lugs which are engaged with the hammer hooks. Hold your left thumb over the hammer and slowly squeeze the trigger. Notice how the trigger lugs move forward, releasing the hammer hooks. The hammer is forced forward by the expanding hammer spring (fig. 43). This happens each time the trigger is squeezed if you release your finger from the trigger after each shot is fired.
- (2) However, there must also be a way of stopping the hammer from going forward even if you keep your finger pressed on the trigger after each shot. This is done by the sear, which catches on the rear hammer hooks. Now squeeze the trigger and hold it to the rear. Cock the hammer slowly and see how the sear catches on the rear hammer hooks and

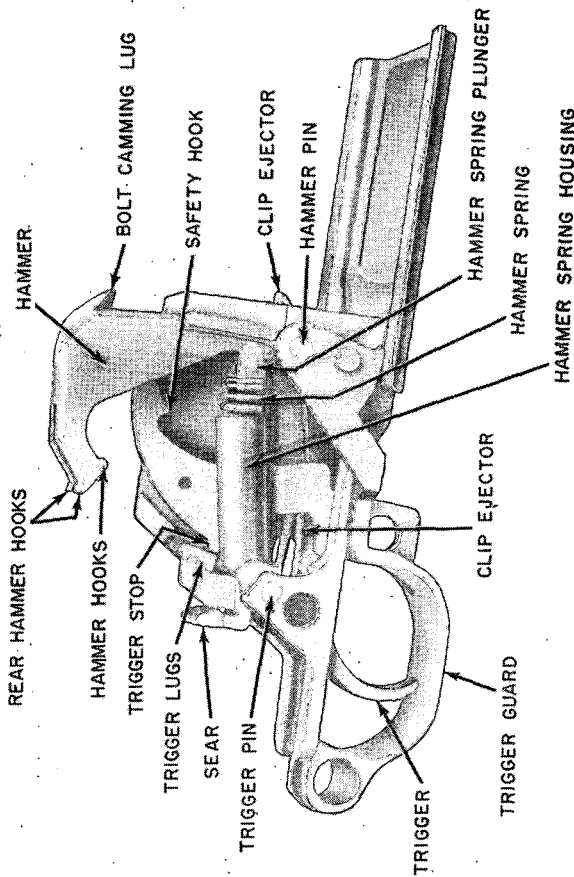

Figure 42. The trigger housing group.

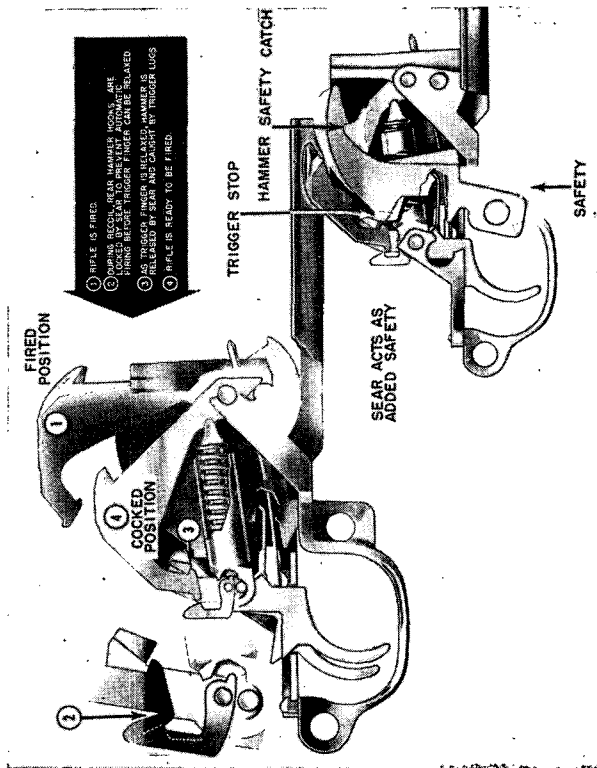

Figure 43. Functioning of the trigger housing group.

holds the hammer back. Slowly release the trigger. As you do this, the sear will release the rear hammer hooks. Now the hammer hooks catch on the trigger lugs and hold the hammer in the cocked position. This combination holds the hammer to the rear each time a round is fired.

b. As you apply pressure on the trigger, it moves to the rear. This movement is divided into a *slack* portion and a *squeeze* portion. Cock the hammer and squeeze the trigger lightly and notice that it moves easily until the sear touches the rear hammer hooks. This movement, until the sear contacts the rear hammer hooks, is called the *slack*. Increased pressure is required to move the trigger from the time the sear contacts the rear hammer hooks until the trigger lugs release the hammer hooks. This second movement of the trigger which requires heavier pressure is called the *squeeze*.

c. To see how the safety works, cock the hammer and push the finger piece of the safety to the rear or *safe* position. As you push the safety to the rear, you force the hook of the safety over the safety lug on the hammer. This locks the hammer in the cocked position. Notice that the hammer hooks are below, and not engaged with, the trigger lugs. Squeeze the trigger. The hammer cannot fall. Notice also that the trigger stop of the safety now blocks the left trigger lug, preventing the trigger from being moved. This is an automatic safety feature designed to block the

trigger in the event of a broken hook on the safety.

d. A safety feature has been built into the rifle to prevent it from being fired unless the bolt is in its locked position. This is done by the action of the bolt camming lug on the hammer against the cocking cam of the bolt. Place the rear of the bolt against the hammer; notice how the bolt camming lug fits into the cocking cam of the bolt. Note that if the bolt is not completely rotated to the right into the locked position, the bolt camming lug will not fit in the cocking cam and that the hammer will not hit the tang of the firing pin. If the bolt is not fully locked and the hammer moves forward, the bolt camming lug will rotate the bolt to the right. This locks the bolt before the hammer can hit the tang of the firing pin. During unlocking, the instant the bolt starts to rotate to the left, the hammer is pushed away from the tang of the firing pin by the action of the cocking cam against the bolt camming lug.

e. Another important part of the trigger housing group is the clip ejector. By placing an empty clip in the trigger housing group, you can see the action of the clip ejector in ejecting the empty clip.

27. FUNCTIONING OF THE RIFLE

The action of the working parts as a full clip of ammunition is loaded into the rifle and during the *functioning cycle* is divided into four phases with certain steps occurring in each phase. You must remember that some of these actions are

going on at the same time; they are listed below in the order in which they start.

a. The *first phase* is the ACTION ON LOADING A FULL CLIP.

- (1) Movement of the follower, follower arm, and follower rod.
- (2) Action of the accelerator and operating rod catch assembly.
- (3) Action of the clip latch.

b. The *second phase* is the ACTION DURING THE FORWARD MOVEMENT OF THE OPERATING ROD.

- (1) Chambering.
- (2) Locking.
- (3) Alinement of the firing pin.
- (4) Termination of the forward movement.

c. The *third phase* is the ACTION DURING THE REARWARD MOVEMENT OF THE OPERATING ROD.

- (1) Action of the gas.
- (2) Action of the operating rod and spring.
- (3) Unlocking.
- (4) Withdrawal of the firing pin.
- (5) Extraction.
- (6) Ejection.
- (7) Cocking.
- (8) Feeding.
- (9) Termination of the rearward movement.

d. The *fourth phase* is the ACTION FOLLOWING THE FIRING OF THE LAST ROUND.

- (1) Action of the follower, follower arm, and follower rod.

- (2) Action of the operating rod catch assembly.
- (3) Action of the clip latch.
- (4) Ejection of the empty clip.

28. STARTING POSITION

a. In paragraph 26 you learned how the trigger, the safety, the hammer, and the clip ejector do their work. Now you are ready to learn what happens when a clip of ammunition is placed in the receiver.

b. Place the barrel and receiver group in front of you and pull the operating rod handle all the way to the rear. Notice that the bolt stays open when no ammunition is in the rifle, that is, unless you purposely let it go forward on an empty chamber. The parts are now in position for you to load a full clip into the receiver (fig. 44).

c. Study the relationship of the parts to each other. The operating rod and bolt are in the rear-most position. The follower is all the way up in the receiver, because the compressed operating rod spring is exerting pressure through the follower rod and follower arm, against the follower. The hump of the follower rod is touching the 45° camming surface of the operating rod catch, pushing it toward the barrel and engaging its undercut hook with the hooks on the operating rod. This keeps the bolt and operating rod to the rear against the pressure of the compressed operating rod spring. The rear stud of the clip latch is pulled back into its slot in the receiver, and the clip latch spring is compressed because of

1. THE FOLLOWER IS MOVED ALL THE WAY UP IN THE RECEIVER BY THE COMPRESSED OPERATING ROD SPRING EXERTING PRESSURE THROUGH THE FOLLOWER ROD AND FOLLOWER ARM.

3. WHEN THE FRONT END OF THE OPERATING ROD CATCH IS CAMMED UP IT TURNS ON THE FOLLOWER ARM PIN AND THE LONG REAR ARM MOVES DOWNWARD.

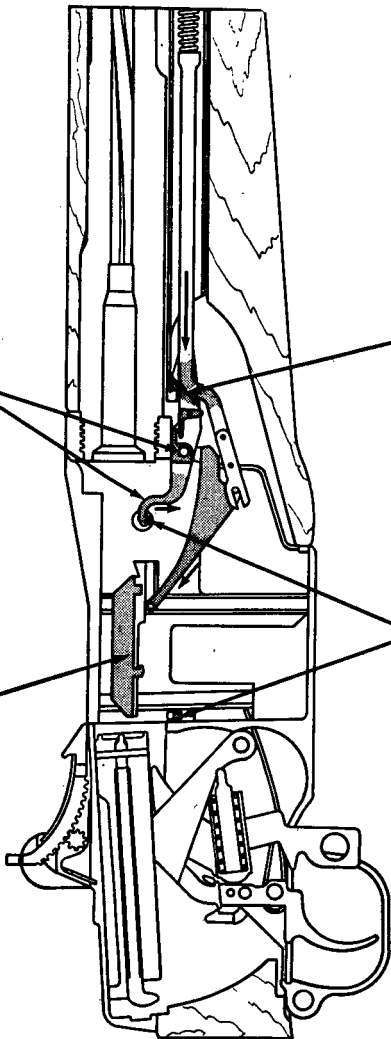

2. THE HUMP OF THE FOLLOWER ROD BEARS AGAINST THE 45° CAMMING SURFACE OF THE OPERATING ROD CATCH, FORCING THE FRONT END OF THE CATCH TOWARD THE BARREL. ITS HOOK IS ENGAGED BY THE HOOKS OF THE OPERATING ROD WHICH IS THEN HELD IN THE REARWARD POSITION ALONG WITH THE BOLT.

4. WHEN THE LONG REAR ARM OF THE CATCH ASSEMBLY EXERTS PRESSURE DOWNWARD ON THE FRONT STUD OF THE CLIP LATCH, THE CLIP LATCH ROTATES COMPRESSING THE CLIP LATCH SPRING AND WITHDRAWING THE REAR STUD FROM THE RECEIVER INTO ITS SLOT.

Figure 44. Position of the parts when the rifle is ready to be loaded with a full clip.

pressure exerted on the front stud of the clip latch by the long rear arm of the operating rod catch assembly.

29. ACTION ON LOADING A FULL CLIP

a. Movement of the Follower, Follower Arm, and Follower Rod. By placing a full clip on top of the follower and pressing down on the clip, the follower is depressed. This action moves the follower arm down, rotating around the follower arm pin. Since the follower arm is connected to the follower rod, it pushes the follower rod toward the muzzle, moving the hump of the follower rod away from the 45° camming surface of the operating rod catch.

b. Action of the Accelerator and Operating Rod Catch Assembly. As the follower reaches its lowest point in the receiver, the square shoulder of the follower arm contacts the rear lip of the accelerator, forcing it toward the barrel. Between its lip and the point where it is fastened by its pin to the operating rod catch, the accelerator bears on and pivots about the toe of the bullet guide. Thus as the lip of the accelerator is forced toward the barrel, the operating rod catch is forced away from the barrel. The undercut hook of the operating rod catch is disengaged from the hooks of the operating rod, letting the bolt and operating rod go forward under the action of the expanding operating rod spring. The accelerator plays no other part in functioning *except when loading a full clip of ammunition as just described.*

c. Action of the Clip Latch. As the forward end of the operating rod catch moves downward

and away from the barrel, the long rear arm of the catch moves upward and away from the front stud of the clip latch. This allows the clip latch spring to expand and force the rear stud of the clip latch into the notch of the clip. The rear stud of the clip latch holds the clip in the receiver against the action of the compressed clip ejector. The operating rod catch is held away from the barrel by the front stud of the clip latch which is continually pushing upward against the long rear arm. This allows the bolt to move freely back and forth until the last round is fired (fig. 45). Load a clip of dummy rounds in the receiver several times and carefully notice how each part works.

30. ACTION DURING THE FORWARD MOVEMENT OF THE OPERATING ROD

a. The Clip is Now in Place. Pull the operating rod all the way to the rear and hold it there. (If dummy rounds are not available for this study, allow the operating rod to go forward a short distance until the operating rod catch no longer holds it to the rear.) The compressed operating rod spring provides the force for the forward movement.

b. Chambering. As the operating rod and bolt, pushed by the compressed operating rod spring, move forward, the bolt strips off the top round in the clip and shoves it into the chamber. When the bolt reaches its forward position, the rim of the cartridge is gripped by the extractor, and the base of the cartridge forces the ejector into the bolt, thus compressing the ejector spring.

3 THE LONG REAR ARM MOVES UPWARD TAKING ITS PRESSURE OFF THE FRONT STUD OF THE CLIP LATCH. THE CLIP LATCH SPRING EXPANDS AND ROTATES THE CLIP LATCH. THE REAR STUD IS MOVED INTO THE RECEIVER WHERE IT ENGAGES IN THE NOTCH OF THE CLIP HOLDING IT IN THE RECEIVER AGAINST THE PRESSURE OF THE COMPRESSED CLIP EJECTOR SPRING.

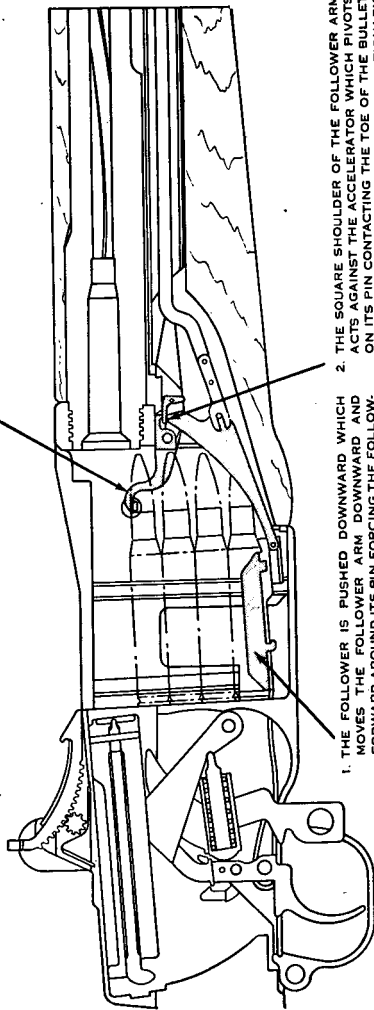

1. THE FOLLOWER IS PUSHED DOWNWARD WHICH MOVES THE FOLLOWER ARM DOWNWARD AND FORWARD AROUND ITS PIN FORCING THE FOLLOWER ROD TOWARD THE MUZZLE END OF THE RIFLE.

2. THE SQUARE SHOULDER OF THE FOLLOWER ARM ACTS AGAINST THE ACCELERATOR WHICH PIVOTS ON ITS PIN CONTACTING THE TOE OF THE BULLET GUIDE. SINCE THE BULLET GUIDE IS STATIONARY, THE ACCELERATOR FORCES THE FRONT END OF THE OPERATING ROD DOWNWARD SEPARATING ITS HOOK FROM THE HOOKS OF THE OPERATING ROD. THE ROD AND BOLT ARE NOW FREE TO MOVE FORWARD.

Figure 45. Position of the parts after a full clip has been placed in the receiver.

c. *Locking.* When the bolt is all the way forward, the rear camming surface in the hump of the operating rod forces the operating lug of the bolt downward, causing the bolt to rotate clockwise. The bolt is locked by the locking lugs on both sides of the bolt, engaging in the locking recesses in the receiver.

d. *Alinement of the Firing Pin.* Slightly before the bolt reaches its foremost position, the tang of the firing pin contacts the bridge of the receiver, stopping the forward movement of the firing pin. When the bolt is turned and fully locked, the tang of the firing pin is lined up with the slot in the bridge of the receiver and may be driven forward by the hammer. This is a safety feature to make sure that the bolt is fully locked before the live round can be fired. Should the hammer fall before the bolt is fully locked, the bolt camming lug on the hammer will strike the cocking cam on the bolt causing the bolt to rotate to its locked position.

e. *Termination of the Forward Movement.* After the bolt has been turned into the locked position, the operating rod continues forward for five-sixteenths of an inch at which time the rear of the recess in the operating rod contacts the operating lug of the bolt, terminating the forward movement.

31. ACTION DURING THE REARWARD MOVEMENT OF THE OPERATING ROD

a. *Action of the Gas.* When a round is fired, the gas formed by the burning powder provides

the force for the rearward movement of the operating parts. Assume that a cartridge is in the chamber, the bolt locked, and the hammer cocked. Squeeze the trigger and imagine that the cartridge is fired. A chamber pressure of approximately 50,000 pounds per square inch is generated and the bullet is forced through the barrel. As the bullet passes the gas port, this tremendous gas pressure has dropped to about 2,000 pounds per square inch. A small part of this gas, seeking the easiest means of escape, expands through the gas port into the gas cylinder and strikes the head of the piston with sudden force, driving the operating rod to the rear.

b. Action of the Operating Rod and Spring. As the operating rod starts to the rear, the operating rod spring begins to be compressed. The operating rod moves to the rear five-sixteenths of an inch before contacting the operating lug of the bolt. This allows it to build up enough speed to overcome the inertia of the locked bolt. This *free play* is also a safety feature. It allows the bullet to clear the muzzle and the pressure inside the barrel to be reduced to outside pressure before the bolt begins to unlock. This prevents a blow-back of gases into the firer's face.

c. Unlocking. As the operating rod continues to the rear, the front camming surface in the hump of the operating rod contacts the operating lug on the bolt, turning the bolt counterclockwise, unlocking it.

d. Withdrawal of the Firing Pin. This action occurs at the same time the bolt is being unlocked.

As the bolt is turned counterclockwise, the tang of the firing pin contacts the bridge of the receiver and is cammed to the rear, withdrawing the striker of the firing pin into the face of the bolt.

e. Extraction. Extraction occurs next. Remember that the extractor has been gripping the rim of the cartridge case all the time that the round has been in the chamber. Initially the round is loosened in the chamber as the bolt unlocks, due to a very slight rearward movement of the bolt. As the bolt continues to the rear it pulls the empty case from the chamber.

f. Ejection. When the front of the empty case clears the rear of the chamber, the ejector (which has been continually pushing against the base of the case) ejects the empty case from the receiver by the action of the expanding ejector spring.

g. Cocking. As the bolt moves to the rear, it forces the hammer rearward and downward into the cocked position.

h. Feeding. When the bolt in its rearward movement clears the top round in the clip, the follower, through the action of the compressed operating rod spring on the follower rod and follower arm, moves the top round up into the path of the bolt.

i. Termination of the Rearward Movement. The rearward movement ends when the square shoulder of the operating rod contacts the front of the receiver.

32. ACTION FOLLOWING THE FIRING OF THE LAST ROUND

a. As each round is fed into the path of the bolt, the hump of the follower rod moves closer to the 45° camming surface between the front arms of the operating rod catch.

b. While the last round is in the chamber, the follower is against the bottom of the bolt. When the last round is fired (fig. 46), the bolt comes to the rear and the follower, freed to this obstruction, is moved all the way up in the receiver by the action of the operating rod spring pushing the follower rod which in turn pushes the follower arm and follower. At the same time the hump of the follower rod contacts the 45° camming surface of the operating rod catch and pushes the catch up toward the barrel.

c. As the catch is cammed toward the barrel, its hook is engaged by the hooks of the operating rod. The engagement of these hooks holds the operating rod to the rear and the bolt open.

d. When the front end of the operating rod catch is cammed toward the barrel, the catch pivots on the follower arm pin and the long rear arm moves downward against the front stud of the clip latch. The clip latch rotates, withdrawing the rear stud from the notch in the clip.

e. The empty clip, now free from the rear stud of the clip latch, is ejected by the expanding clip ejector.

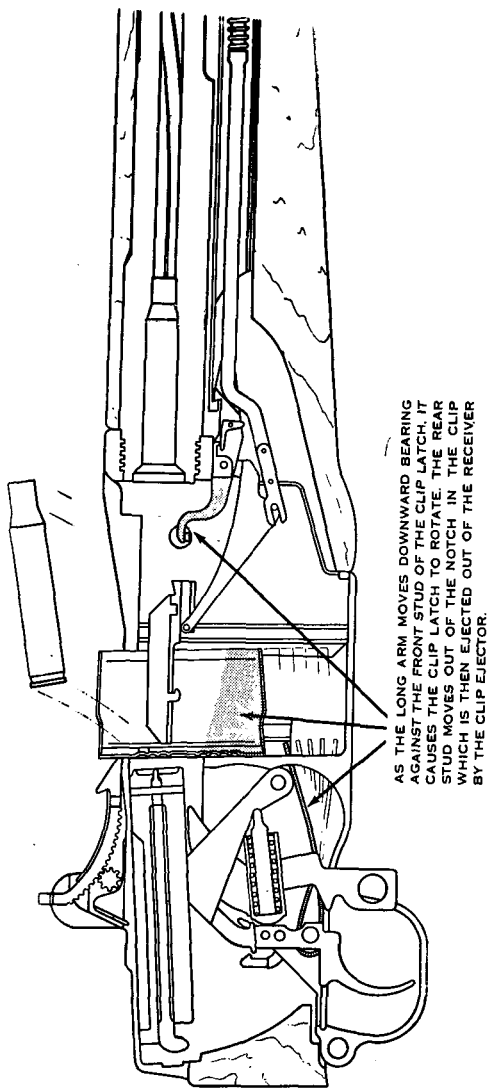

Figure 46. Action following the firing of the last round.

Section III. OPERATION

33. GENERAL

In order to use your rifle, you must know how to load the rifle with a full clip, a partially filled clip, or a single round. You must know how to fire it, and, for the safety of yourself and other soldiers, how to unload and clear the rifle. In this section you will be shown how to operate the rifle.

34. USE OF DUMMY CARTRIDGES

Dummy cartridges will be helpful during your instruction in mechanical training. Be careful to keep dirt and grit out of the weapon while you are using the dummy cartridge.

35. TO LOAD A CARTRIDGE CLIP

Insert eight rounds in the cartridge clip making sure that the base of each cartridge is against the rear wall of the clip and that the inner rib of the clip engages the extractor groove in the cartridge (fig. 47). The rifle will work if the top cartridge of the loaded clip is on the left or right side, since the follower slide will adjust itself. However, if the uppermost cartridge is on the right, the clip can be more easily forced into the receiver by a right hand firer. For this reason clips are loaded this way at the arsenal.

36. TO LOAD THE RIFLE

Except in continuous firing, the operation of loading a full clip into the rifle is performed with

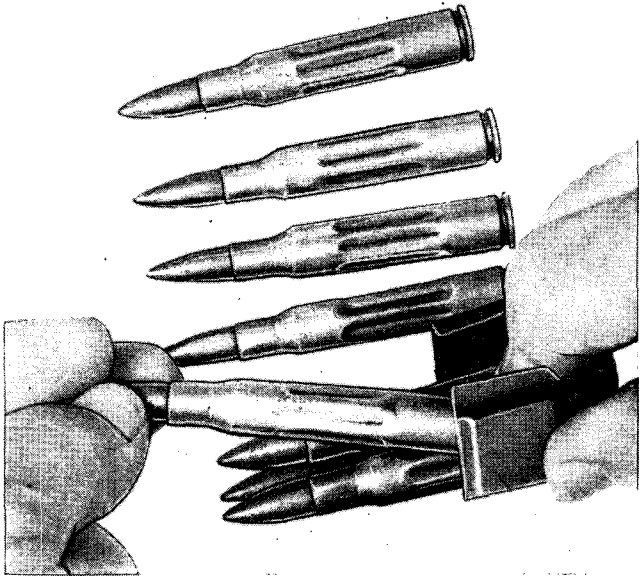

Figure 47. Loading a clip.

the rifle locked, that is, with the finger piece of the safety in its rearmost position. With the left hand, hold the rifle at its balance. With the right hand, pull the operating rod handle smartly to the rear until the hooks of the operating rod engages the hook of the operating rod catch and the bolt stays open. Rest the toe of the butt on the right thigh. With the right hand, take a fully loaded clip and place it on top of the follower. Close the hand into a fist with the thumb extended. Raise the elbow high and, with the ball of the thumb on top of the clip at its front end (about the middle of the top cartridge) and the

thumb pointing toward the muzzle end, press the clip down into the receiver until it is caught by the rear stud of the clip latch. Swing the thumb to the right so as to clear the bolt in its forward movement. The closing and locking of the bolt may be assisted by striking the operating rod handle sharply with the heel of the right hand. You can easily learn the technique of loading the rifle by doing it a few times with dummy cartridges.

37. TO UNLOAD THE RIFLE

a. To unload a cartridge from the chamber, hook the right thumb over the operating rod handle, pull and hold the operating rod in the extreme rear position. This extracts and ejects the round.

b. To remove the loaded clip from the receiver, hold the rifle with your right hand, thumb on the operating rod handle, fingers around the trigger guard, and the rifle butt resting in your right groin. Place the palm of your left hand over the receiver and press in on the clip latch with your left thumb. The clip is ejected upward from the receiver and into your left hand. Do not allow the bolt to move forward during the operation as it will push the top cartridge forward and prevent ejection of the clip.

c. To close the bolt on an empty chamber and retain a partially loaded clip in the receiver, press down on the top cartridge in the clip, allowing the bolt to slide forward over it; make sure that

the bolt is fully closed. This can be done only when there are less than eight cartridges in the clip.

38. TO OPERATE THE RIFLE AS A SINGLE LOADER

With the receiver empty, pull the operating rod to the rear until it is caught by the operating rod catch. With the right hand, place one round in the chamber, seating it with the thumb. With the palm of the right hand against the receiver, the rear edge of the right hand against the operating rod handle, the fingers extended, joined, and pointing downward, force the operating rod handle slightly to the rear; push down the follower with the right thumb; and permit the bolt to ride forward about one inch over the follower. Then remove the thumb from the follower and release the operating rod handle. The operating rod must be allowed to go forward by the force of its expanding spring. It must not be slowed in its forward movement by contact with the hand. If the operating rod is not completely released, the bolt may not lock; when this occurs, the rifle may not fire when the trigger is squeezed.

39. TO PARTIALLY LOAD A CLIP

a. Using One Hand. To partially load a clip from any firing position, hold the rifle with your left hand at the firing position, with the butt of the rifle resting on a secure surface (the groin, thigh, or ground). Move the operating rod handle to its rearmost position with your right hand, opening the bolt. Place the empty clip into the

receiver. Next, place the first cartridge into the clip and on the follower with the right hand. Press the second cartridge into the clip, exerting a downward turning motion toward the center of the clip with the right thumb until the cartridge snaps into place. In the same manner, continue to load the clip. After placing the last cartridge into the clip, loading is completed by pressing down slightly on the top cartridge with the right thumb, at the same time moving the operating rod handle slightly to the rear with the right edge of the right hand. Let the bolt move forward about 1 inch; this starts the top round forward. Remove your right hand and allow the operating rod to go forward. This method of loading is useful in combat when a full clip of ammunition is not available.

Caution: While pressing rounds into the clip keep the palm of the right hand against the receiver and in front of, but not touching, the operating rod handle. This will prevent the bolt from going forward and injuring the right thumb while loading rounds into the clip.

b. Using Both Hands. Place the empty clip on a solid surface, gripping the sides of the clip with the thumb and middle finger of the right hand. With the left hand, insert the cartridges into the clip and hold them in place with the right forefinger inside the clip. When the rounds (less than eight) have all been inserted into the clip, place the clip on top of the follower without changing your grasp with your right hand. Use your left hand to assist in holding the cartridges in place

and slide the clip down until the lip engages the top cartridge. Regrasp the rifle with the left hand at the firing position. Press down on the top cartridge with the right thumb, the palm of the right hand against the stock, and the side of the hand pressing the operating rod handle slightly to the rear. When the clip is engaged by the rear stud of the clip latch, allow the bolt to move forward about an inch, withdraw the right thumb, release the operating rod handle; this allows the bolt to close and lock. Whether using one or both hands, care should be taken to insure that the base of each cartridge is against the rear wall of the clip.

40. TO FIRE THE RIFLE

To fire the rifle, you must squeeze the trigger for each shot. When the last round has been fired, the empty clip is automatically ejected and the bolt remains open.

41. TO SET THE RIFLE AT SAFE

The loaded rifle must be kept locked until you are ready to shoot. To lock the rifle, snap the safety to its rear position inside the trigger guard. In this position, the trigger cannot be moved because the left trigger lug is blocked by the square shoulder of the safety. When locked, the rifle may be loaded or unloaded by hand but it cannot be fired. To unlock the rifle, push the safety to its forward position.

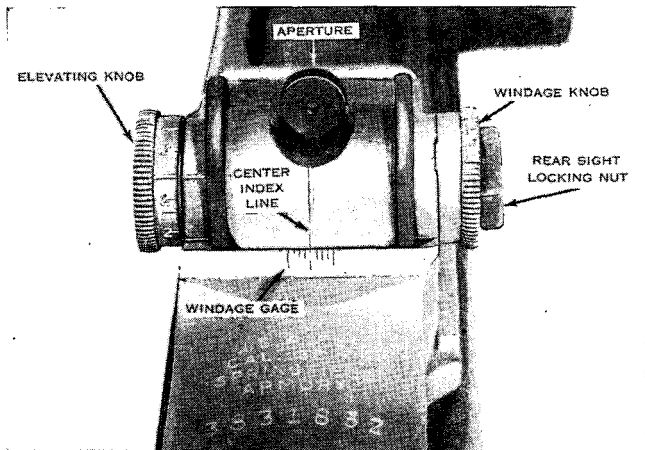

Figure 48. The rear sight.

42. TO CLEAR THE RIFLE

To clear the rifle, pull the operating rod fully to the rear, thus extracting and ejecting the cartridge from the chamber. Remove the clip from the receiver by depressing the clip latch; this will cause the clip to jump out. Leave the bolt in the open position. Inspect the receiver and chamber to be sure that they are empty.

43. TO ADJUST THE REAR SIGHT

a. The rear sight of your rifle (fig. 48) is adjustable, enabling you to engage targets accurately up to the maximum effective range. It has an elevation knob and a windage knob. The elevation knob has a number and a mark for 200, 400, 600, 800, 1,000, 1,200 yards of range and lines between these graduations for 100, 300, 500, 700, 900 and

1,100 yards. The base of the rear sight has a center index line, and the graduations for windage are on the receiver. Arrows on the elevation and windage knobs show the direction to turn them to move the sight either up or down, right or left.

b. To raise the strike of the bullet on the target, increase the sight setting by turning the elevating knob toward you. To lower the strike of the bullet on the target, lower the sight setting by turning the elevating knob away from you. To move the strike of the bullet to the right, turn the windage knob away from you. This moves the aperture to the right and is called right windage. To move the strike of the bullet to the left, turn the windage knob toward you. This puts left windage on the rear sight. An easier way of saying all this is to move the rear sight in the direction that you want to move the strike of the bullet.

c. The rear sight contains *clicks* both for elevation and windage. One click represents an angular adjustment of one minute or approximately 1 inch on the target for each 100 yards of range.

Note. Each windage graduation on the receiver represents an angular adjustment of four minutes.

d. After setting the rear sight to any click of elevation or windage, move the adjustment knob slightly in both directions to see that it is centered for that click.

44. SAFETY PRECAUTIONS

Safety cannot be overemphasized. Whenever you work with weapons, constant care and check-

ing must be done. Some of the precautions to observe in handling this rifle follow. These precautions are not intended to replace other existing safety regulations.

a. A rifle with its bolt closed is never considered to be safe until it has been properly inspected.

b. Do not playfully or carelessly point the rifle at anyone. Always consider the rifle loaded.

c. Do not leave any obstruction in the muzzle or bore.

Section IV. IMMEDIATE ACTION AND STOPPAGES

45. GENERAL

If your rifle stops firing from no fault or intention of your own, then you have a stoppage. You must be able to clear such stoppages and continue firing—in combat your life and the lives of other members of your squad may depend on your fire support. Therefore, the first thing to do when you have a stoppage is to apply immediate action, which is the unhesitating application of a probable remedy to clear a stoppage without investigating the cause.

46. APPLYING IMMEDIATE ACTION

If your rifle fails to fire, pull the operating rod handle *all the way* to the rear with the right hand, palm up; release it, aim, and fire. This action will clear most stoppages. If this fails to correct the stoppage, and it is necessary to continue fir-

ing, work the operating rod handle by hand until you have enough time to investigate the trouble.

47. STOPPAGES

a. The stoppages that are not cleared by immediate action fall into three classes. They are—

- (1) *Failure to chamber*, which is the result of some condition that prevents the bolt from chambering the round completely. In some cases the bolt will be locked and in others the bolt will not be locked.
- (2) *Failure to fire*, which is the result of the primer failing to fire when struck by the firing pin or a failure of the firing pin to strike the primer.
- (3) *Failure to extract*, which is the result of an extremely dirty chamber, extremely dirty ammunition, or a broken extractor or spring.

b. Table I gives the causes for the above stoppages as well as others for which the corrective action is based upon your knowledge of mechanical training with the rifle.

SECTION V. CARE AND CLEANING

48. GENERAL

Proper care, cleaning, and preservation of your rifle is an important duty. Experience has proved that more rifles become unserviceable through lack of care and cleaning than for any other reason.

Table I. Stoppages and Malfunctions

Malfunction	Cause	Correction by soldier
Failure to chamber.....	Dirty or rough chamber. Restricted gas port. Dirty or improperly lubricated rifle. Bent clip. Ruptured cartridge case in chamber.	Clean chamber. Clean gas port. Clean and lubricate rifle. Replace clip. Remove ruptured cartridge case.
Failure to fire (hammer releases but rifle does not fire).	Bolt not seated and locked. Defective or broken firing pin. Defective ammunition.	Pull operating rod handle halfway to rear and release it. Insure complete locking. Replace firing pin. Discard round.
Failure to extract.....	Dirty or rough chamber. Restricted gas port. Dirty ammunition. Failure to replace extractor plunger and spring. Broken extractor.	Clean chamber. Clean gas port. Discard or clean round. Replace extractor plunger and spring. Replace extractor.
Clip jumps out on seventh round.	Bent follower rod.....	Replace follower rod.
Fires in bursts of two or three rounds.	Sear broken or worn, or remains in open position. Hammer spring housing improperly assembled.	Replace trigger assembly or hammer spring housing. Disassemble and assemble trigger housing group correctly.
Safety releases when pressure is applied on trigger.	Worn trigger stop on safety or broken safety.	Replace safety.
Pressure on trigger does not release hammer.	Deformed hammer or trigger or worn trigger pin. Trigger strikes trigger housing.	Replace defective part. Turn in to ordnance.
Creep in trigger.....	Burrs on trigger lugs or hammer hooks.	Replace trigger, hammer, or both.

49. CLEANING MATERIALS, LUBRICANTS, AND RUST PREVENTIVES

a. *Cleaning Materials.*

- (1) *Rifle bore cleaner* is issued for cleaning the bore of your rifle after firing. This material possesses rust-preventive properties and will provide temporary protection against rust. Dry the bore and other components immediately after using rifle bore cleaner and apply a thin coat of special preservative lubricating oil. Rifle bore cleaner freezes at temperatures below minus 20°F. If thawed rifle bore cleaner is used, shake it well before using.
- (2) *Water* is used for cleaning the bore of your rifle when rifle bore cleaner is not available. Warm water is good, but warm soapy water is better. It is used to clean only the bore and the gas cylinder. After using soap and water, dry the bore and apply a thin coat of special preservative lubricating oil.
- (3) *Dry-cleaning solvent* is a noncorrosive petroleum solvent used for removing grease, oil, or light rust-preventive compounds from rifles. Do not use near an open flame, because dry-cleaning solvent is highly inflammable. Smoking is prohibited where this solvent is being used. It will attack and discolor rubber. Apply it with rag swabs to large parts and use as a bath for all small parts. Clean

all surfaces immediately and thoroughly dry them with clean rags and then oil them. To avoid leaving finger marks, which contain corrosive acids, wear gloves when handling parts after cleaning. Volatile-mineral-spirits paint thinner may be used instead of dry cleaning solvent.

- (4) *Decontaminating agents* are used under special conditions to remove chemical agents.

b. *Lubricants.*

- (1) *Medium preservative lubricating oil* is a highly refined, non-hardening mineral lubricating oil containing a rust inhibiting additive. It forms a relatively heavy film which resists the direct action of salt spray. These characteristics make it useful for coating all parts of the weapon before landing operations. Use it in preference to preservative lubricating oil, special, only when the rifle is to be exposed to salt water, high humidity atmospheric conditions, or high temperatures.
- (2) *Special preservative lubricating oil* is a thin oil used for lubricating at normal and low temperatures and for providing temporary protection against rust. Use this oil for preserving the bore after the rifle has been fired and cleaned. Make frequent inspections to assure maintenance of an adequate protective film of oil.

- (3) *Rifle grease* possesses high resistance to the action of water. Use it sparingly on those parts subject to heavy wear in wet climates or during amphibious operations. Figure 49 shows the critical parts where this grease should be applied. It is issued in a small plastic container which can be carried in the rifle butt recess along with the combination tool and oiler.
- (4) *Engine oil, SAE 10* may be used when the oils mentioned above cannot be obtained. In cold weather any oil as heavy as this causes sluggish operation and may prevent the rifle from working. This alternate oil does not possess the rust preventive properties of preservative lubricating oils. When engine oil is used, the weapons must be examined, cleaned, and reoiled frequently.

c. Preservatives.

- (1) *Medium rust-preventive compound* is issued for protecting the metal parts for long periods of time while the rifles are boxed and in storage. Warm it before application. When you have no way to heat it, brush it onto the parts when the temperature of the atmosphere is above 80° F. At temperatures below 80° F., medium rust-preventive compound becomes thick and sluggish and it is not economical to use it without preheating.

- (2) *Raw linseed oil* is used to prevent the drying of the wooden parts and to preserve them. Apply it with long strokes of the hand, it improves the appearance of wood.
- (3) *Neat's-foot oil* is a pale yellow animal oil. Use it for preserving leather equipment such as gun slings.

50. CARE AND CLEANING WHEN NO FIRING IS DONE

a. This includes the care of the rifle necessary to preserve its condition and appearance during the periods when no firing is done.

b. To clean the bore, use the M3 cleaning rod and several patches. If you use a rod longer than the M3, protect the follower and face of the bolt against damage from the rod. Run a patch forward and backward through the bore several times, making sure that the patch goes all the way through before reversing the direction. Repeat this several times, using a clean patch each time, until a patch comes out clean. Then, dip a patch in special preservative lubricating oil, squeeze out the excess oil and run the patch through the bore several times.

Caution: Avoid careless use of the cleaning rod to prevent unnecessary wear at the muzzle. When using the cleaning rod it should not be allowed to bear against the bore at the muzzle end during cleaning. To prevent wear, keep cleaning strokes reasonably straight so that the cleaning rod does not bend and bear against the bore.

c. Clean the small screw heads and all recesses with a small brush or stick. An old tooth brush or shaving brush is excellent for this purpose. Clean the metal parts with a dry cloth and wipe with an oil-dampened cloth to provide a protective finish. Wipe the stock and hand guards with a clean cloth, then rub in linseed oil. Preserve the leather sling by rubbing on some neat's-foot oil.

Caution: After cleaning your rifle, do not use a muzzle plug or cover. These will collect moisture and result in rust, and there is always the danger of forgetting to remove the plug before firing.

51. CARE AND CLEANING BEFORE AND DURING FIRING ON THE RANGE

Before firing, take the following steps to insure efficient functioning of the rifle.

- a. Dismount it into the main groups.
- b. Clean the bore and chambers. Do not oil them.
- c. Remove any carbon on the gas-cylinder lock screw and piston head.
- d. Clean thoroughly and put a light coat of oil on all metal parts which do not come in contact with the ammunition. Use special preservative lubricating oil. Be sure that the following parts have a light coat or oil:

- (1) Locking lugs of the bolt, operating lug, and recesses.
- (2) Bolt guides.

- (3) Cocking cam on bolt.
- (4) Contact surface of barrel and operating rod.
- (5) Operating rod guide groove on side of the receiver.
- (6) Operating rod spring.
- (7) Camming surfaces in the hump of the operating rod.

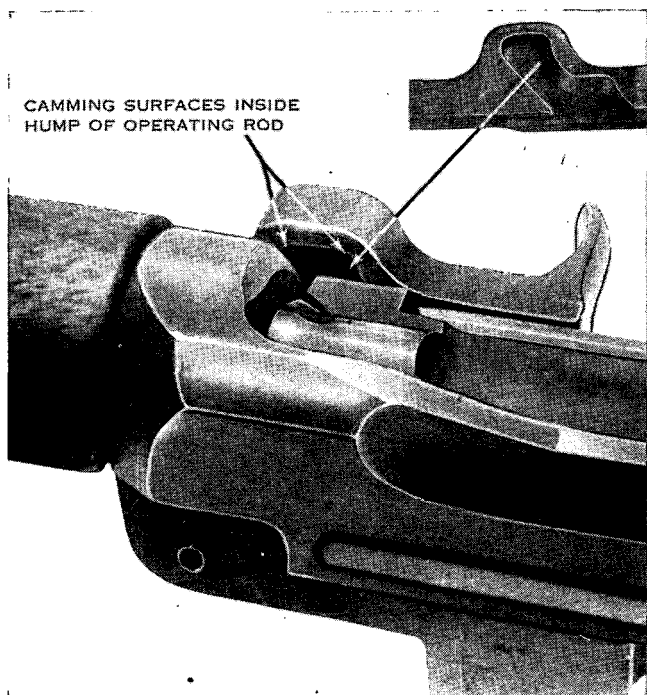

①

Figure 49. Camming surfaces in the hump of the operating rod.

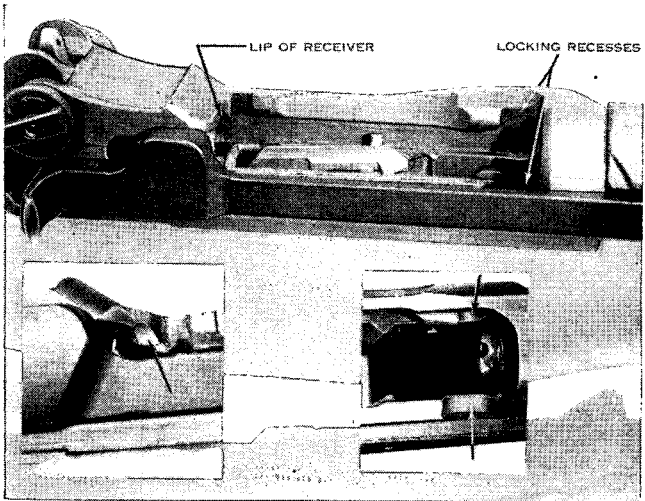

②

Figure 49. The lip of the receiver and locking recesses.

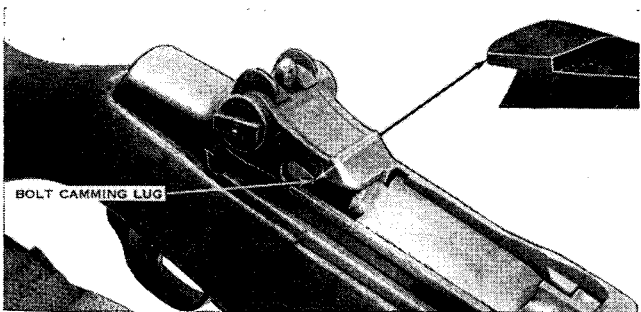

③

Figure 49. The bolt camming lug.

e. Use rifle grease if the rifle is exposed to severe conditions of rain or to spray from sea water, because the bolt may occasionally fail to open. This is caused by the friction resulting

from the effect of the water and the fact that any ordinary lubricant is likely to be washed away from certain bearing surfaces. Under these conditions, it is essential that such surfaces be coated with rifle grease which resists the action of the water. Rifle grease is applied to the parts shown in figure 49①②③ after wiping them clean and dry with a cloth.

Rifle grease normally is not applied to other parts. After applying rifle grease, work the parts several times to spread the grease.

52. CARE AND CLEANING AFTER FIRING

After your rifle has been fired, the primary consideration is the prevention of rust. The residue left after firing consists mainly of primer salts, powder ashes, metal fouling, and carbon. In most small arms ammunition (carbine excluded), the primer contains a salt which collects moisture and promotes rust, just as table salt does. This salt collects about the chamber and may be deposited throughout the bore. Rifle bore cleaner removes it as well as powder ashes. Metal fouling is relatively unusual. It is removed only by ordnance personnel. Carbon, formed by cooling powder gases, clings to the entire gas system and is a constant worry because it clogs the rifle, causing stoppages. Rifle bore cleaner will remove this carbon but considerable effort may be required.

a. *Cleaning the Bore.* Clean the bore of your rifle thoroughly, preferably right after firing, and

certainly no later than the evening of the day you fire it.

(1) Use the following equipment:

- (a) M3 cleaning rod.
- (b) Rifle bore cleaner.
- (c) Patches.
- (d) Special preservative lubricating oil.
- (e) Combination tool.
- (f) Waste.

(2) Follow this system:

- (a) Wet patches (rifle bore cleaner or hot soapy water).
- (b) Rifle bore brush.
- (c) More wet patches.
- (d) Dry patches.
- (e) Inspection (Repeat the above until a dry patch comes out clean and no evidence of fouling can be seen in the bore.)
- (f) Oily patch.

b. *Cleaning the Chamber.* Clean the chamber by using the chamber cleaning brush on the combination tool and follow the sequence outlined above. To use the chamber cleaning brush, place it on a patch in the palm of the left hand. Close the left hand over the patch and brush and give the brush about three turns to the right. This causes the patch to wrap neatly around and cover the brush. A slight pressure with the forefinger of the left hand while turning the brush, will twist the end of the patch like the finished end of a hand rolled cigarette. This insures cleaning the full length of the chamber. Clean by twist-

ing the patch-covered brush in the chamber. After cleaning the chamber, inspect it by inserting the little finger and twisting it. If no discoloration shows on the finger, oil the chamber lightly.

c. Cleaning the Gas Cylinder. Remove the gas cylinder lock screw with valve assembly and the gas cylinder lock. Clean the gas cylinder by using the cleaning rod, patches, and rifle bore cleaner. When all carbon has been removed, wipe dry and oil lightly.

d. Cleaning the Gas Cylinder Lock Screw with Valve Assembly. Remove excess carbon deposits by scraping, then oil lightly. Carbon should be scrubbed off the head of the piston, using rifle bore cleaner. Oil lightly after cleaning.

e. Cleaning the Bolt. The face of the bolt should be cleaned with a patch and rifle bore cleaner. After cleaning, dry and oil lightly.

f. Cleaning Other Metal Parts and Exterior Surfaces. Wipe all parts and surfaces with a dry cloth to remove dampness, dirt, and perspiration. Oil all metal parts with special preservative lubricating oil. Oil the stock and hand guard with linseed oil and the sling with neat's-foot oil.

53. CARE AND CLEANING DURING COMBAT

a. There is no basic difference between the care of a rifle during range firing and during combat except:

- (1) The rifle may have much more severe treatment.
- (2) Conditions for maintenance may be much more difficult.

(3) Materials for maintenance may be partially or completely lacking.

b. There is little you can do about these conditions except to use your initiative, energy, and continued attention to overcome your difficult surroundings.

c. To obtain the maximum efficiency from your rifle, observe the following points:

- (1) *Clean bore.* Do not fire the rifle when dirt, mud, snow, or any other obstruction is in the bore. Such obstructions are extremely dangerous and may cause the rifle barrel to blow up. Use a cleaning rod, if one is available, or the thong and brush which you should always have in the stock of the rifle. If these are not available any slender rod or stiff wire can be used as a field expedient. Using any one of these, keep the bore clean and lightly oiled.
- (2) *Clean chamber.* Clean the chamber at the same time you clean the bore. Use clean ammunition because dirty or corroded ammunition deposits dirt in the chamber which may cause stoppages. After cleaning, to prevent rust, dip a patch in oil, squeeze the excess oil out of it, and then use this patch to thinly oil the chamber.
- (3) *Excessive friction.* If the rifle shows signs of excessive friction due to lack of lubrication, apply oil to the parts that need it. If this friction is the result of

dirt and there is no time to clean the rifle use an extra amount of oil in the places needed. Friction is indicated if the empty cartridge cases are being ejected to the right rear or if the action of the bolt is sluggish. Apply oil at the first opportunity, as failure to chamber and eject will occur if the condition is not corrected.

- (4) *Severe exposure.* If the rifle is to be exposed to severe conditions of rain or salt water, apply rifle grease. The points on which to apply this grease are shown in figure 49^{①②③}.

d. Keep a thin coating of special preservative lubricating oil on all metal parts.

e. Remove the carbon from the gas cylinder lock screw with valve assembly and the piston head when necessary.

f. Normally it is not necessary to remove any of the parts of the rifle for cleaning in the field except the trigger housing group and the gas cylinder lock screw. However, if the mechanism becomes very dirty, disassemble the rifle for cleaning and lubrication.

g. In emergencies when the prescribed lubricants are not available, use any clean light mineral oil such as engine oil.

54. PREPARATION FOR STORAGE

Medium preservative lubricating oil is the most suitable oil for short term protection of the rifle

mechanism. It is effective for storage over periods of two to six weeks, depending on climatic conditions. However, rifles in short term storage must be inspected every four or five days and the preservative films renewed if necessary. For longer periods of storage, rifles are protected with medium rust preventive compound. Medium rust preventive compound is a semisolid material. It is efficient for preserving polished surfaces, the bore, and the chamber for many years, depending on climatic and storage conditions. The rifles must be cleaned and prepared for storage with particular care. The bore, all parts of the mechanism, and the exterior of the rifles should be thoroughly cleaned and then dried completely with rags. In damp climates, particular care must be taken to see that the rags are dry. After drying a metal part, the bare hands should not touch that part. All metal parts should then be coated with either medium preservative lubricating oil or medium rust preventive compound, depending on length of storage required. Application of the rust preventive compound to the bore of the rifle is best done by dipping the cleaning brush into the compound and then running it through the bore two or three times. The brush must be clean before it is used. Before placing the rifle in the packing chest, see that the bolt is in its forward position and that the hammer is released. Then, handling the rifle by the stock and hand guard only, place it in the packing chest whose wooden supports for the butt and muzzle have been painted previously with rust preventive compound. *In no circumstances will a rifle be wrapped*

in a cloth or other cover or be placed in storage with a plug in the bore. Such covers collect moisture which cause the weapon to rust.

55. CLEANING WEAPONS RECEIVED FROM STORAGE

Rifles taken from storage will be coated with either preservative lubricating oil or with rust preventive compound. Rifles received from ordnance storage will usually be coated with rust preventive compound. Use dry-cleaning solvent or volatile mineral spirits paint thinner to remove all traces of the compound or oil. Take particular care that all recesses in which springs or plungers operate are cleaned thoroughly. Failure to do this may cause stoppages at normal temperatures and will certainly cause stoppages when the rust preventive compound congeals during cold weather. After using the cleaning solvent, be sure it is completely removed from all parts by wiping with a dry cloth. Then apply a thin coat of special preservative lubricating oil to all metal parts; use linseed oil on the wooden parts and treat the leather sling with neat's-foot oil.

56. CARE WHEN SUBJECT TO CHEMICAL ATTACK

a. If a chemical attack is anticipated or chemical contaminations are encountered, the following action will be taken: Apply oil to all outer metal surfaces of the rifle and accessories. Do not apply oil to ammunition. If the weapon is not to be used, cover rifle, accessories, and ammunition with protective coverings or disperse under natural cover. Ammunition should be kept in its

containers as long as possible. After a chemical attack, determine by means of detector paper (for liquid) or detector crayon (for vapors) whether or not the equipment is contaminated.

b. If not contaminated, clean the equipment with rifle bore cleaner. Prepare the rifle and its equipment for use as required.

c. If contaminated, a complete suit of protective clothing (permeable or impermeable), including impermeable protective gloves, and a gas mask must be worn during decontamination.

(1) Equipment contaminated with chemicals other than the blister agents or G-series agents can be decontaminated by airing. For faster decontamination of these agents and to protect against corrosion, clean the rifle and its equipment with rifle bore cleaner, denatured alcohol, or soap and water.

(2) Equipment contaminated by blister agents will be decontaminated as follows:

(*a*) Remove dirt, dust, grease, and oil by wiping with rags.

(*b*) Expose all surfaces to air.

(*c*) Decontaminate all metal surfaces except the bore with agent, decontaminating, noncorrosive (DANC) (FM 21-40). Hot water and soap, or repeated applications with gasoline soaked swabs are also effective.

(*d*) Protective ointment, M5, carried in the gas mask carrier, can be used for

emergency decontamination (FM 21-40).

- (e) Test with detector paper on detector kit to see if decontamination is complete.
 - (f) After decontamination and test: clean, dry, oil, and prepare the rifle and its equipment for use as required.
 - (g) Burn, or preferably bury, all rags or wiping materials used during decontamination. Caution should be taken to protect men against vapors created by burning.
- (3) In general these same actions are applicable to equipment contaminated by biological or radiological attack. If contamination is too great it may be necessary to discard the equipment. Detailed information on decontamination is contained in FM 21-40 and TM 3-220.

57. CARE AND CLEANING UNDER UNUSUAL CLIMATIC CONDITIONS

a. In Cold Climates. In temperatures below freezing, it is necessary that the moving parts of your rifle be kept absolutely free from moisture. It has also been found that excess oil on the working parts will solidify to such an extent as to cause sluggish operation or complete failure.

- (1) The rifle should be disassembled and completely cleaned with dry-cleaning solvent before use in temperatures below + 32° F. The working surfaces of

parts which shown signs of wear may be lubricated by rubbing with a cloth which has been wetted in special preservative lubricating oil; other parts are left dry. At temperatures above 32° F., all metal surfaces of the rifle may be oiled thinly, after cleaning, by wiping with a lightly oiled cloth, using medium preservative lubricating oil.

- (2) When brought indoors, the rifle should first be allowed to come to room temperature. Moisture will condense on the cold surfaces. Then disassemble the rifle and wipe it completely dry. Oil with special preservative lubricating oil. This condensation may be avoided by providing a cold place in which to keep the rifles when not in use. For example, a separate cold room with rifle racks may be used, or, when in the field, racks under proper cover may be improvised. If the rifle has been fired, it should be cleaned and oiled. When the rifle reaches room temperature it should be cleaned and oiled again.

b. Hot, Humid Climates. In tropical climates where temperature and humidity are high, or where salt air is present, and during rainy seasons, your rifle should be thoroughly inspected daily. It should be kept lightly oiled when not in use. The three main groups should be dismounted at regular intervals and, if necessary, should be disassembled enough to permit the drying and

oiling of all parts. Care should be taken to see that unexposed parts and surfaces are kept clean and oiled. Special preservative lubricating oil should be used. However, use medium preservative lubricating oil where the rifle is exposed to salt-water atmospheres. Wood parts should be inspected to see that swelling caused by moisture does not bind working parts. If swelling has occurred, shave off the wood *only enough* to relieve binding. A light coat of raw linseed oil applied at intervals and rubbed in with the heel of the hand will help to keep moisture out. Allow the oil to soak in for a few hours and then wipe and polish the wood with a dry, clean rag.

Note. Care should be taken that linseed oil does not get on the working parts, because linseed oil thickens when dry. Stock and hand guards should be dismantled while this oil is being applied.

c. Hot, Dry Climates. In hot, dry climates where sand and dust are likely to get into the mechanism and bore, the rifle should be wiped clean daily or oftener. Groups should be separated and disassembled for thorough cleaning. When the rifle is being used under sandy conditions, all lubricants should be wiped from the weapon. This will prevent sand from sticking to the lubricant and forming an abrasive which will ruin the mechanism. Upon leaving sandy terrain, the rifle should be relubricated. In such climates, the wood parts are likely to dry out and shrink. A light application of raw linseed oil will help to keep the wood in condition. Perspiration from the hands contains acid and causes rust. Perspi-

ration should be wiped from metal parts. During sand or dust storms, the receiver and muzzle should be kept covered if possible.

Section VI. SPARE PARTS, APPENDAGES, AND ACCESSORIES

58. SPARE PARTS

Some parts of your rifle may in time become unserviceable through breakage or from wear resulting from continuous use. Extra parts are provided with the rifle to replace those most likely to fail. They should be kept clean and lightly oiled to prevent rust. Sets of spare parts should be kept complete at all times. Whenever a spare part is used to replace a defective part in the rifle, the defective part should be repaired or replaced. Parts that are carried complete should be correctly assembled and ready for immediate use with the rifle. The allowances of spare parts are prescribed in DA Supply Catalog ORD 7 SNL B-21. Except for replacements with the spare parts mentioned above, repairs or alterations to the rifle are made only by ordnance personnel.

59. APPENDAGES

a. Bayonet. The bayonet is a blade sharpened along the entire lower edge and partially along the upper edge. It is made to fit securely into the scabbard or onto the muzzle end of the rifle. A hand grip on its base makes it a suitable hand weapon or utility tool.

b. Grenade Launcher. The grenade launcher is

a short tube-like device which may be attached to the muzzle of the rifle to fire various types of grenades. A detailed discussion of the grenade launcher and rifle grenades is presented in FM 23-30.

60. ACCESSORIES

Accessories include the tools required to assemble and clean your rifle, and the gun slings, spare parts containers, covers, arm lockers, and similar articles. They should be used for no other purpose than that for which they are intended. When not in use, they should be stored in the places provided for them. Detailed descriptions or methods for the use of all such accessories are not outlined in this manual. However, the most common accessories are described below.

a. The barrel reflector (fig. 50) is a small L-shaped device having a short tube which slips into the chamber of the rifle barrel. It has a mirror which reflects the bore and makes inspection easy.

b. The brush and thong are used for cleaning the bore of the rifle when the cleaning rod is not

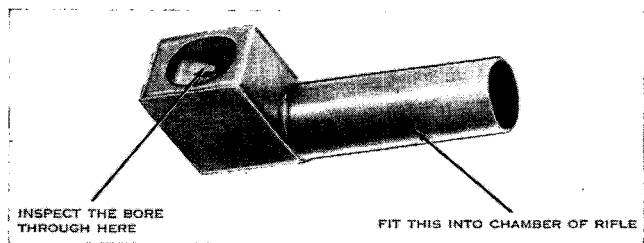

Figure 50. The barrel reflector.

available. The oiler and thong case which may be carried in the stock of the rifle is divided so that one end contains the oil and oil dropper and the other end holds the tip, weight, thong, and brush.

c. *The cleaning rod M3* is of such length as to prevent damage to the follower or the face of the bolt. The rod has a handle at one end and is threaded at the other end to receive the patch or brush sections. The patch section is slotted to permit the insertion of a cleaning patch; the brush section is used to clean the bore of the rifle after firing.

d. *The combination tool* (fig. 51) consists of three parts, the chamber cleaning brush, the forked end, and the screwdriver blade. The movable screwdriver blade is used for tightening the

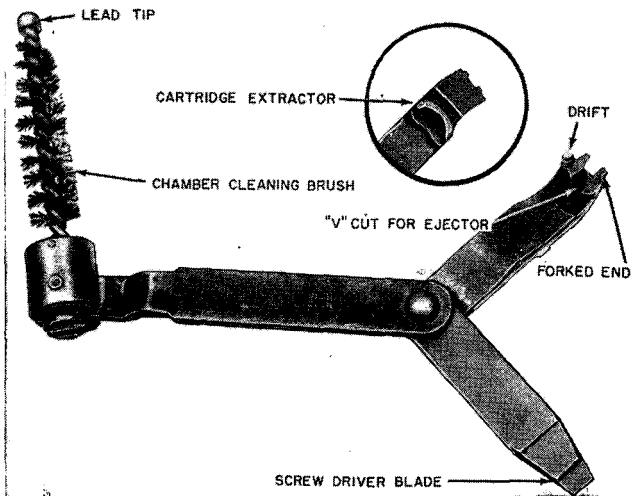

Figure 51. *The combination tool.*

gas cylinder lock screw, for disassembling the bolt, and for adjusting various screws. The notched blade of the handle is used to tighten the rear sight locking nut. The small cylindrical projection is used to drift out pins. It is also used, together with the V-shaped groove cut into the face of the handle, to assemble the extractor and ejector in the bolt. The curved undercut lug or hook, commonly called the hand extractor, is used to remove a cartridge case from the chamber when the extractor has failed to function.

e. *The gun sling M1907 (leather)* (fig. 52) is placed on your rifle as shown in figure 53①.

- (1) Thread the feed end of the long strap through the upper keeper as shown in figure 53②; then place the upper hook in the third or fourth pair of holes near the feed end of the long strap. Engage the lower hook in the pair of holes below the upper hook. The sling is now attached to the rifle.
- (2) To tighten the sling (fig. 53③), grasp the inside strap of the sling near the trigger housing with the left hand. With the right hand, grasp the sling between the hooks. Now pull toward the butt with the left hand and push toward the muzzle with the right hand until the sling is tight. Slide the lower keeper toward the muzzle until the feed end of the long strap has been passed.
- (3) To loosen the sling for carrying purposes, slide the lower keeper down from

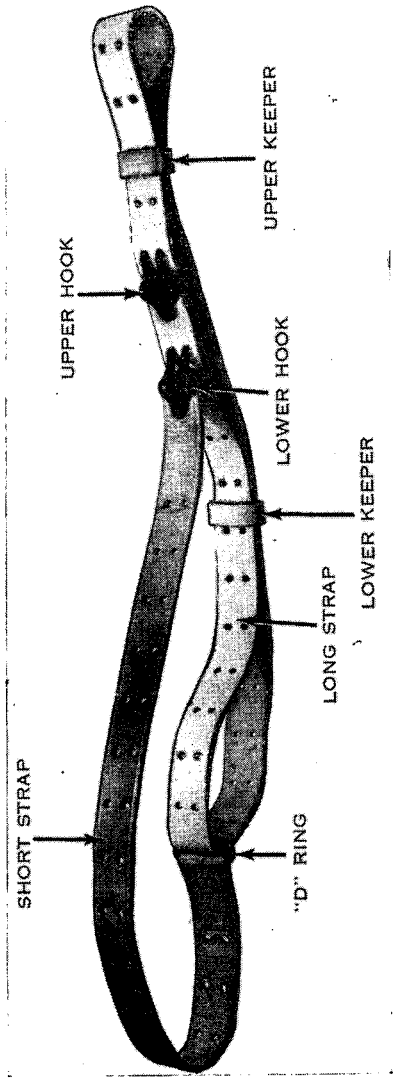
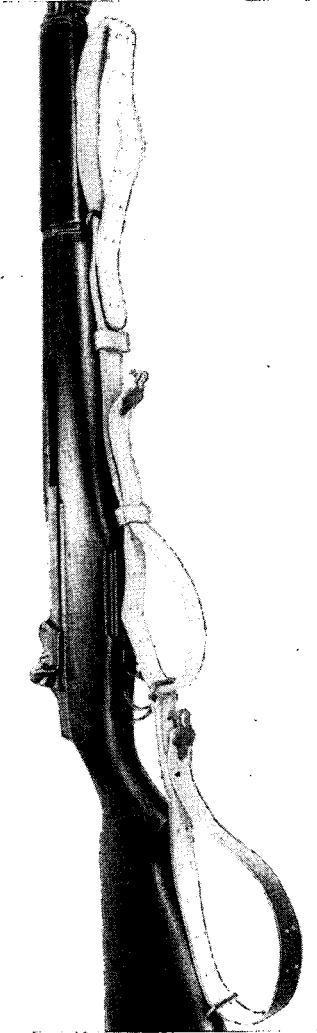
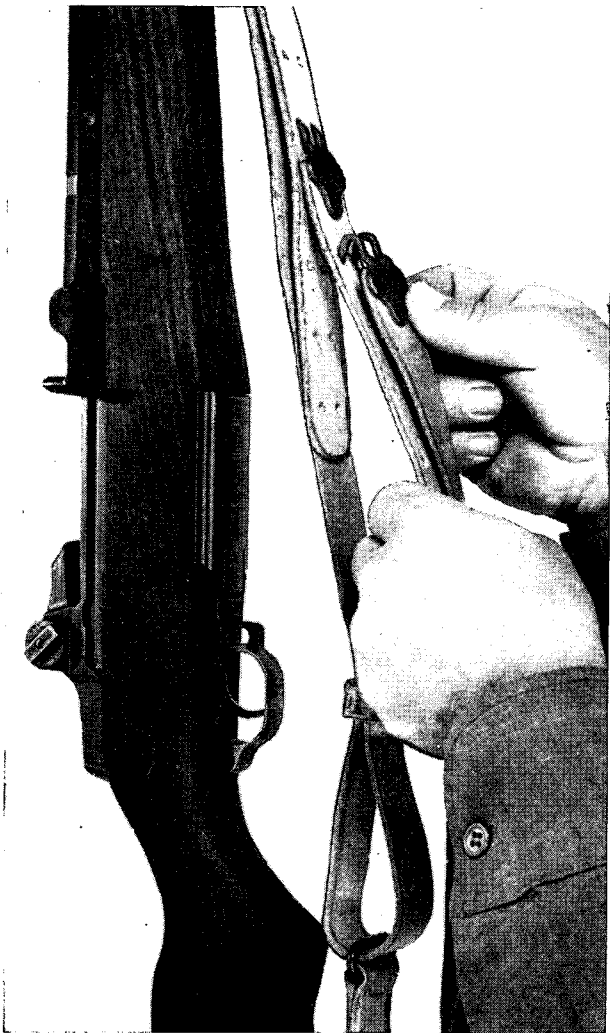

Figure 52. Gun sling, M1907 (leather).



①

Figure 53. Placing and tightening the sling on the rifle.



②

Figure 53—Continued.



③

Figure 53—Continued.

the feed end of the long strap and grasp the inside strap with the left hand. Grasp the outside strap between the hooks with the right hand. Now force the inside strap toward the muzzle and at the same time pull the outside strap toward the butt of the rifle.

- (4) To hold the sling in a tight position, force the upper keeper against the stock ferrule swivel and slide the lower keeper up until it has passed the feed end of the long strap.

f. The gun sling M1 (improved web) (fig. 54) is placed on your rifle as shown in figure 55①.

- (1) Thread the feed end of the sling through the keeper and pull the keeper and feed end of the sling toward the butt of the rifle, as shown in figure 55②, until the sling is tight. Close the keeper.
- (2) To adjust the web sling for carrying purposes, open the keeper, loosen the sling by sliding the keeper and feed end of the sling toward the muzzle. In this manner loosen the sling until there is sufficient slack to sling the rifle comfortably on the shoulder. Close the keeper.

g. The ruptured cartridge extractor (fig. 56) has the general shape of a caliber .30 cartridge and consists of three parts; the spindle, the head, and the sleeve. To use the ruptured cartridge extractor, the cartridge clip and live cartridges must be removed from the rifle. The ruptured cartridge extractor is then inserted through the opening of

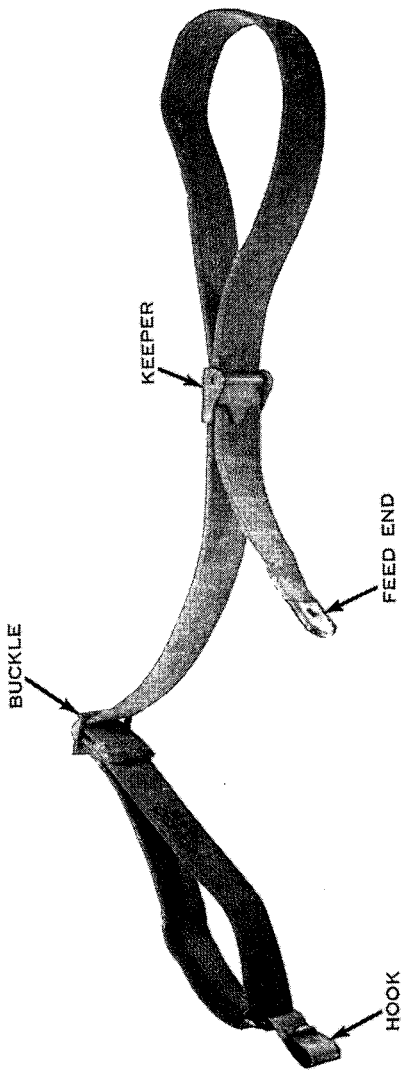
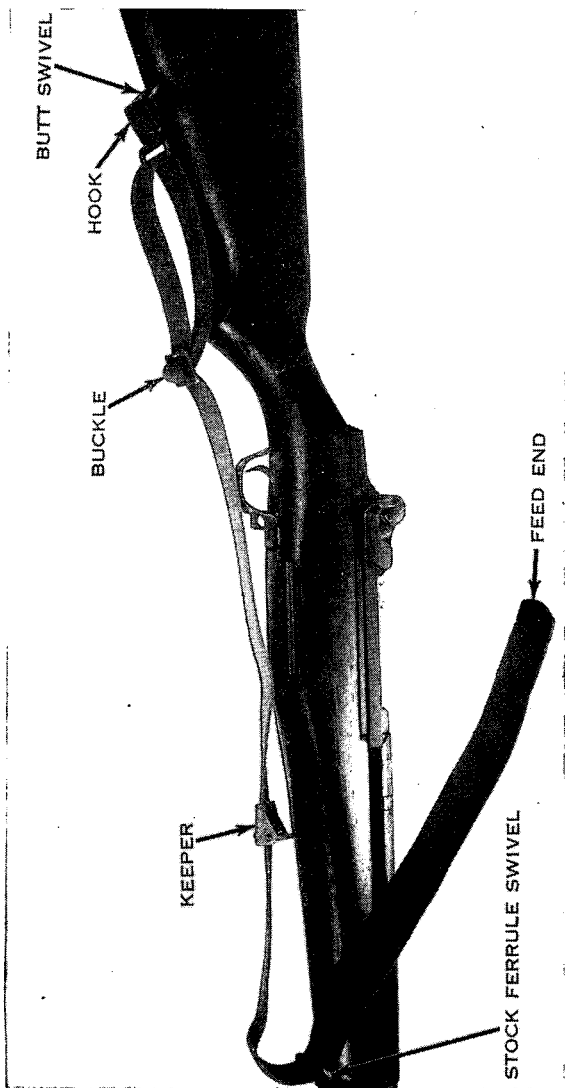
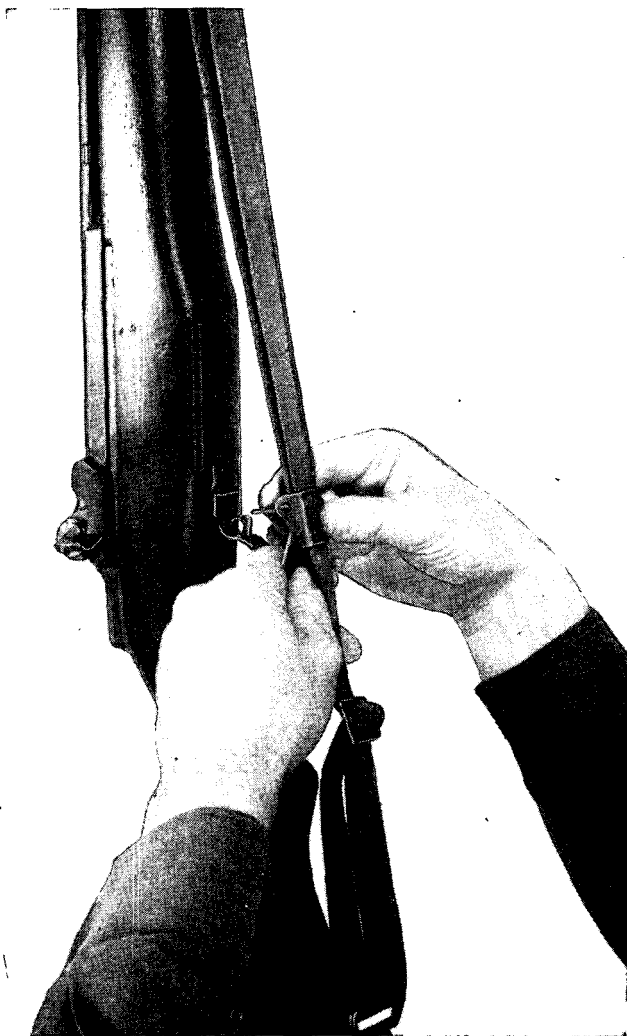

Figure 54. Gun sling, M1 (improved web).



①

Figure 55. Placing the sling on the rifle.



②

Figure 55. Tightening the sling on the rifle.

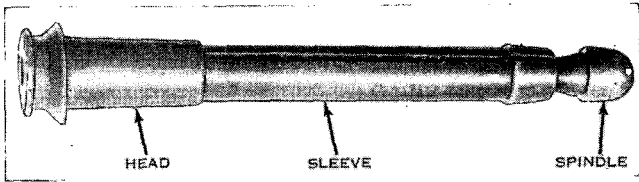

Figure 56. Ruptured cartridge extractor.

the ruptured case and pushed forward into the chamber. Allow the bolt to close without excessive shock so that the extractor on the bolt engages the head of the ruptured cartridge extractor. When the bolt is opened, the ruptured cartridge extractor will remove the ruptured cartridge.

h. The M2 aiming device (fig. 57) is an instructional aid that allows the coach to positively check the pupil's sight picture during preparatory marksmanship training and range practice. As the coach looks into the aiming device, he sees reflected on the glass an image of the sight picture as the rifleman sees it. This allows the coach to check on those men who do not hold their breath properly, and it enables him to help the inexperienced rifleman to obtain the correct sight picture. The device is attached by fitting the two extensions over the rear sight.

Section VII. AMMUNITION

61. GENERAL

The ammunition that you may use in the M1 rifle is described in this section. This rifle can fire several types of ammunition. You are responsible for being able to recognize these types, to

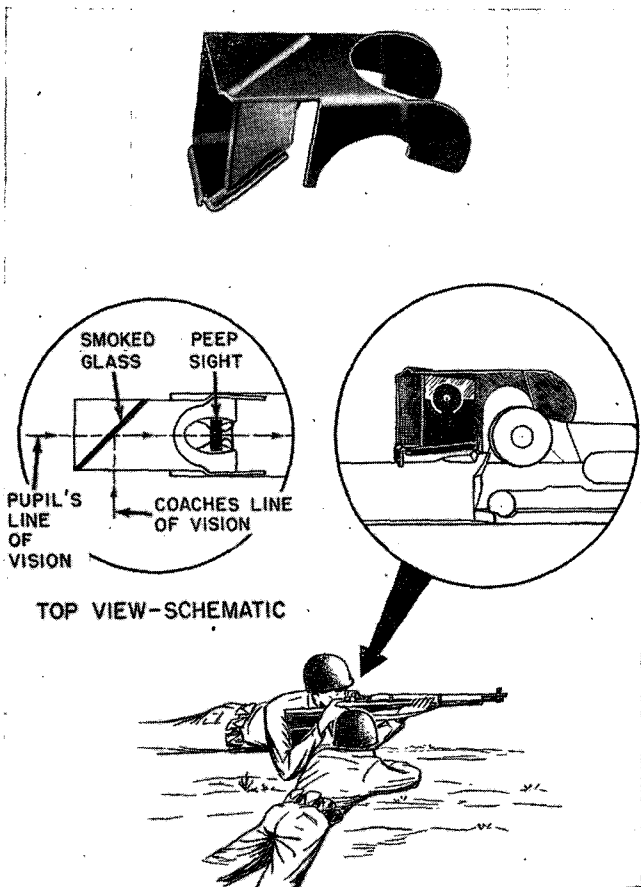

Figure 57. M2 aiming device.

know which is best to use for certain targets, and to properly care for the ammunition.

a. In most types of small-arms ammunition, a cartridge consists of a cartridge case, primer, pro-

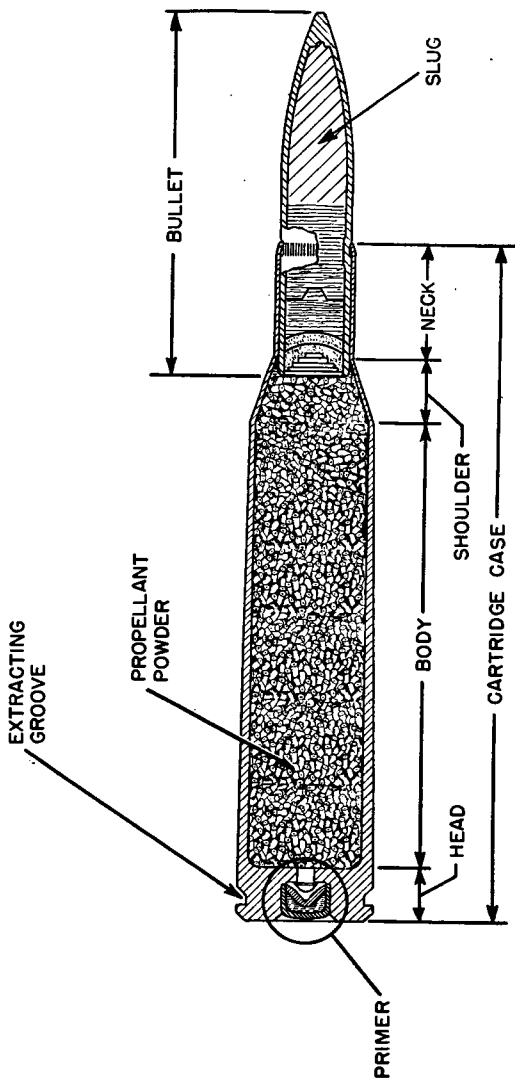

Figure 58. Parts of the caliber .30 round.

elling charge, and the bullet. Figure 58 shows the construction of a typical cartridge and its parts.

b. The term *bullet* refers only to a small arms projectile. The term *ball* was originally used to describe the ball shaped bullet of very early small arms ammunition. The term *ball ammunition* now refers to a cartridge having a bullet which has a metallic jacket filled only with lead.

62. CLASSIFICATION

Based on use, the principal classifications of the several types of ammunition used with your rifle are—

- a.* Ball, M2—for use in marksmanship training.
- b.* Tracer, M1—observation of fire, incendiary, and signaling purposes.
- c.* Armor-piercing, M2—for use against lightly armored vehicles, protective shelters, and personnel.
- d.* Incendiary, M1—for use against inflammable material.
- e.* Armor-piercing incendiary, M14—used in place of either the armor-piercing or incendiary cartridges.
- f.* Rifle grenade cartridge, M3—used in propelling grenades.
- g.* Blank, M1909—for simulated fire, signaling, and salute.
- h.* Dummy—used for training.

63. LOT NUMBER

When ammunition is manufactured, it is given an ammunition lot number. This lot number is marked on all packing containers. It is also on the identification card inclosed in each packing box. The lot number is required for all purposes of record, such as grading and use, and reports on the condition, functioning, and accidents in which the ammunition might be involved. It is impracticable to mark the ammunition lot number on each individual cartridge. Every effort should be made to maintain the ammunition lot number or the repacked lot number with the cartridges after they are removed from their original packing. Cartridges which have been removed from their original packing for which the ammunition lot number has been lost are automatically placed in grade 3; these are not to be fired.

64. IDENTIFICATION

a. *Markings.* The contents of original boxes may be readily identified by the markings on the box. Similar markings on the cardboard carton label identify the contents of each carton. The markings which appear on the box and carton are complete information necessary for identification, shipping, care, handling, and use.

b. *Identification of Ammunition Types.* In general, all types of cartridges of one caliber look alike in shape and size, but they may be identified by certain physical characteristics. The ammunition authorized for use with the M1 rifle and the way to identify each type after it has been

removed from the original container follows:

<i>Types of cartridge</i>	<i>Identification</i>
Ball	All models of caliber .30 ball ammunition have bullets coated with gilding metal, a copper alloy, which prevents fouling in the bore of the rifle. Ball ammunition has no identifying color on the tip of the bullet.
Tracer	Tip of the bullet is painted red.
Incendiary	Tip of the bullet is painted a light blue.
Armor-piercing	Tip of the bullet is painted black.
Armor-piercing incendiary	Tip of the bullet is painted aluminum.
Grenade	Has no bullet. Its mouth has 5 crimps (indentations).
Blanks	Has no bullet. Its mouth is not crimped.
Dummy	There are two types of caliber .30 dummy cartridges in use. One type has 6 longitudinal crimps in the case; the other type has 3 holes in the case.

65. CARE, HANDLING, AND PRESERVATION

Most men have at one time or another fired a rifle or a pistol, or perhaps both types of weapons. If you have, it means you have also handled ammunition for these weapons. You know that the ammunition was not dangerous to handle. This of course does not mean that you handled the ammunition carelessly. The ammunition used in your army rifle is not dangerous to handle but there is a *correct* way to handle it.

a. Care must be exercised to prevent ammunition boxes from becoming broken or damaged. All

broken ammunition boxes must be repaired immediately. All original markings must be transferred to the new parts of the box. The metal liner should be air tested and sealed if equipment for this work is available.

b. Open wooden ammunition boxes carefully. They are used as long as they are serviceable.

c. Ammunition boxes should not be opened until the ammunition is to be used. Ammunition removed from the airtight container, particularly in damp climates, is likely to corrode. This ammunition is unserviceable.

d. Protect ammunition from mud, sand, and water. If it gets wet or dirty, wipe it off at once with a clean, dry cloth. Light corrosion should be wiped off as soon as it is discovered. Heavily corroded cartridges must be turned in.

e. During marksmanship and combat training, no caliber .30 ammunition will be fired until it has been identified by an ammunition lot number and grade.

f. Do not expose ammunition to the direct rays of the sun. If the powder is heated, excessive pressure may be developed when the weapon is fired. This condition will affect ammunition performance.

g. Do not oil or grease ammunition. The dust and other abrasives that collect on greasy ammunition are injurious to the operating parts of the rifle.

h. Do not attempt to fire cartridges that have bad dents, scratches, or loose bullets, or those that are corroded. If you think a cartridge is defec-

tive, return it. Do not throw away or attempt to destroy defective ammunition.

66. STORAGE

a. Small-arms ammunition is not an explosive hazard. Under poor storage conditions, however, it may become a fire hazard.

b. Small-arms ammunition of all classes should be stored away from radiators, hot water pipes, and other sources of heat.

c. Whenever practicable, small-arms ammunition should be stored under cover. If it is necessary to leave ammunition in the open, it should be raised at least six inches from the ground and covered with a double thickness of tarpaulin. The tarpaulin should be placed so that it gives maximum protection and allows free circulation of air. Suitable trenches must be dug to prevent water from flowing under the ammunition pile.

67. BALLISTIC DATA

The approximate maximum range and average muzzle velocity of the different types of caliber .30 ammunition authorized for use in the M1 rifle are shown below.

<i>Cartridge</i>	<i>Maximum range (yards)</i>	<i>Average muzzle velocities (feet per second)</i>
Ball, M2	3,500	2,800
Tracer, M1	3,350	2,750
Incendiary, M1	2,875	3,020
Armor-piercing, M2	3,160	2,770
Armor-piercing, incendiary, M14	3,300	2,830

68. PRECAUTIONS IN FIRING BLANK AMMUNITION

Firing blank cartridges at anyone within a 20-yard range is dangerous because the wad or paper cup in the cartridge may fail to break up within this distance. Misfires, in which the primer explodes but fails to ignite the powder charge, may prove dangerous when blank ammunition is being fired. In this type of misfire, some of the powder may be left in the bore of the weapon. A series of such rounds in which the powder fails to ignite (because of moisture or other causes) may result in serious damage when the accumulated powder is ignited by a subsequent cartridge. When misfires in excess of five percent are encountered in blank ammunition, the lot will be withdrawn and reported to the ordnance officer.

69. PRECAUTIONS IN FIRING SERVICE AMMUNITION

The general precautions concerning the firing and handling of ammunition in the field, as prescribed in SR 385-310-1 and TM 9-1900, are observed. Precautions that apply particularly to small-arms ammunition are—

a. Do not fire any small-arms ammunition (other than blank ammunition) until it has been positively identified by ammunition lot number and grade. Under no circumstances will small-arms ammunition graded and marked "For training use only" be fired over the heads of troops.

b. Do not use armor-piercing cartridges in demonstrations in which tanks are used. In using armor-piercing ammunition, remember that the cores of bullets that fail to penetrate the target

may rebound. The radius of rebound for caliber .30 armor-piercing ammunition depends on several factors but may safely be assumed to be a maximum of 100 yards.

c. Before firing, make sure that the bore of your weapon is free from any foreign matter like cleaning patches, mud, sand, snow, and the like. A weapon fired with any obstruction in the bore may be damaged and may injure the rifleman. If a bullet lodges in the bore of the rifle, remove it by applying pressure from the muzzle end of the weapon. To attempt to force the bullet out by firing another cartridge is dangerous and is prohibited.

70. HANGFIRES

When a hangfire occurs, further use of ammunition from that lot should be suspended and a report made to the post ordnance officer, giving the lot number involved. The lot affected will be withdrawn and replaced by serviceable ammunition.

CHAPTER 3

MARKSMANSHIP TRAINING

Section I. GENERAL

71. INTRODUCTION

The best way for you to meet the enemy is with deadly rifle fire. You need to fire with speed as well as with accuracy. You may fire at targets from a few yards to several hundred yards away. If you lay down plenty of fast, well-aimed fire on the enemy, you will reduce the effect of his fire. Your rifle is capable of all this, so use it well.

72. FUNDAMENTALS

a. You need no special ability to learn to shoot well. Good shots are not born with the ability to shoot well. You become a good shot only by practice and shooting. A perfect physique is not necessary. All you need is the desire and willingness to learn. And why not learn? This rifle is the tool of your trade. The principles of marksmanship in this manual have been proved to be sound. Learn them thoroughly and apply yourself earnestly and you will be a good shot. You will find that shooting is fun as well as a challenge.

b. Good shooting is the result of the mastery of the five important elements of marksmanship. These elements are—

Aiming.
Position.
Trigger squeeze.
Sustained fire.
Sight setting.

c. These five elements are tied together by the word COORDINATION. Each element is taught in the sequence listed above, except that sight setting may be taught any time. Each step depends on material covered in the steps preceding it. Each element is essential to the final result—good shooting.

73. PHASES OF TRAINING

a. Marksmanship training is divided into two phases—

- (1) Preparatory marksmanship training.
- (2) Range firing.

b. Each of the two phases may be divided further. Preparatory marksmanship training can be divided into separate instructional steps. Range firing includes all firing whether it is on the 1,000-inch range, the larger known-distance ranges, the transition range, or others. One very important thing to remember, during *all* phases of marksmanship training, is that *training is progressive*.

c. The following guides must be observed during marksmanship training:

- (1) Each soldier must have a good understanding of how his rifle works before he receives instruction in preparatory marksmanship.

- (2) No man will be allowed to fire on the range until he has thorough training in preparatory marksmanship, regardless of his previous qualification.

Section II. PREPARATORY MARKSMANSHIP TRAINING

74. GENERAL

a. You should develop fixed and correct shooting habits before you go on the range. The purpose of preparatory marksmanship training is to teach you the essentials of good shooting. Preparatory marksmanship training is divided into six steps. These steps are—

Sighting and aiming exercises.

Position exercises.

Trigger squeeze exercises.

Sustained fire exercises.

Effect of wind, sight changes, and use of the score card.

Examination before range firing.

Note. The first five steps correspond to the five elements of marksmanship.

b. The first four steps are listed in the order of instruction. They *must* be taught in that order. As the fifth step is not based on material covered in any of the first four steps, it may be taught any time before the examination. It may be taught either indoors or outdoors. Therefore, it is an excellent subject to be taught indoors during bad weather.

75. COACHING

a. Throughout all of your preparatory work, one of your important duties will be to act as a coach. You and the other members of your unit will be organized into instructional groups. You will rotate within your group performing the duties of firer and coach. As a coach you are expected and required to supervise your firer closely. You will check to see that the firer—

- (1) Blacks sights.
- (2) Adjusts sling properly.
- (3) Takes correct position.
- (4) Holds breath while aiming.
- (5) Aims carefully.
- (6) Takes up slack promptly.
- (7) Squeezes trigger properly.
- (8) Calls the shot.
- (9) Fills out the score card for each shot.
- (10) Observes safety precautions.

b. How well a man learns to shoot depends to a great extent on how well the coach does his job. Thus, a coach's duties are important.

76. PROGRESS CHART

A progress chart like the one below should be kept on all men starting preparatory marksmanship training. Normally, each platoon keeps a progress chart. Each experienced squad leader notes the progress of his men on this chart. The platoon leader can tell by a glance at the chart

how far each man has progressed in each subject. Those men weak in certain steps can be given more attention to bring them up to the required standard of proficiency.

77. SIGHTING AND AIMING EXERCISES

a. The sighting and aiming step of preparatory marksmanship training consists of three exercises. They are—

- (1) Making correct sight alinement and correct sight picture using the sighting and aiming bar.
- (2) Making correct sight alinement and correct sight picture using the rifle sights.
- (3) Testing your sight alinement and sight picture by having three sight pictures marked at a distance of 50 feet. These three markings will form a shot group.

b. The following equipment is used to teach these exercises:

- (1) Sighting and aiming bar with rear sight and bull's-eye.
- (2) Rifle and rifle rest.
- (3) Three-inch aiming disk.
- (4) Ammunition box, blank sheet of paper, thumb tacks, and pencil.
- (5) Aiming device M15.

c. For details on the use and construction of the above equipment, see paragraph 353.

d. Before you are ready to practice any of the three exercises, you must understand the meaning of *sight alinement* and *sight picture* (fig. 59).

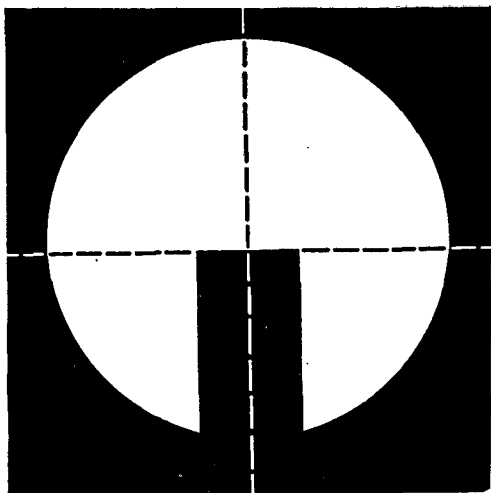

①

Figure 59. Sight alignment and sight picture.

- (1) When the front and rear sights are brought into correct adjustment with the eye, the sights are said to be in *alignment*.
- (2) The *sight picture* is the pattern seen by the rifleman when he aims his rifle. This pattern includes the front and rear sights and if a bull's-eye or some other object is aimed at, it includes that object. When the sight picture is correct, the sights and the bull's-eye or other object (if the picture contains one) are in alignment.
- (3) To get the correct picture of the sights alone, look through the rear sight. Now

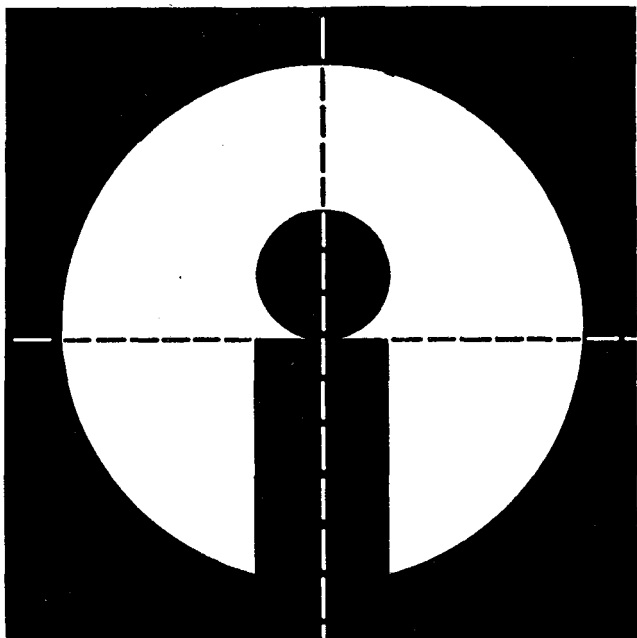

②

Figure 59—Continued.

move your rifle until an imaginary horizontal line passing through the center of the rear sight just touches the top of the front sight and until an imaginary vertical line through the center of the rear sight passes through the center of the front sight.

- (4) A complete sight picture is made by adding the bull's-eye. The bull's-eye should be centered over the front sight

and should appear to be barely touching it.

- (5) In aiming, the correct alinement of the sights in the sight picture is more important than the exact placement of the bull's-eye. A small error in the alinement of the bull's-eye in the sight picture will produce the same error in the strike of the bullet at all ranges. A small error in the relationship of the sights in the picture will produce a much larger error in the strike of the bullet. The same error in the alinement of the sights will increase as the range is increased.

78. SIGHTING DEVICE, M15

The sighting device, M15, is an excellent training aid for use during marksmanship training. This training aid has movable parts to represent the rear and front sights of the rifle and the bull's-eye. By moving these parts you can set up the correct sight picture. After your instructor explains sight alinement and sight picture, you adjust the sighting device to show the correct sight picture. During marksmanship training, you may be called on to demonstrate your ability to set up the correct sight picture, using this device.

79. FIRST SIGHTING AND AIMING EXERCISE

a. The sighting and aiming bar (fig. 60) is used for this exercise. The front and rear sights

on the sighting and aiming bar represent the front and the rear sights of your rifle. The rear sight on the sighting and aiming bar is movable. This allows you to make adjustments in the sight picture. There is no part on your rifle that corresponds to the eyepiece on the sighting and aiming bar. The eyepiece represents the position of your eye as you adjust the sights, and anyone who looks through the eyepiece will see

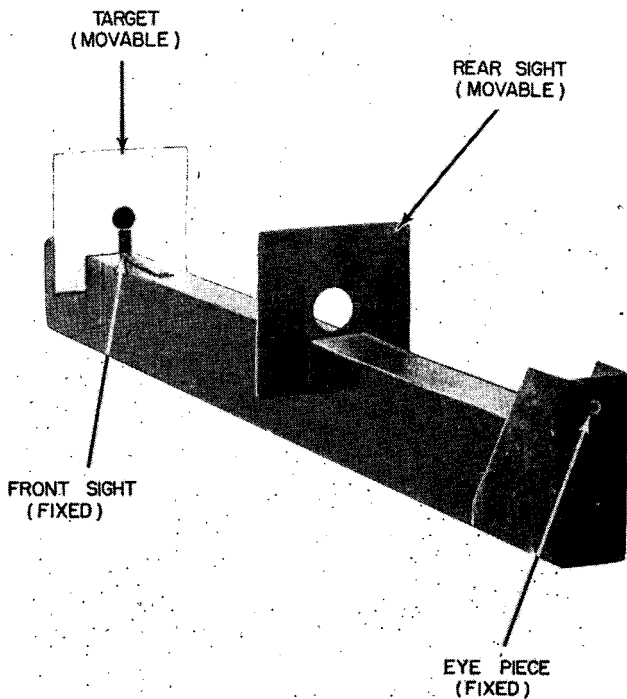

Figure 60. The sighting and aiming bar.

the same sight picture that you see. The movable target allows for adjustments in the sight picture.

b. Your instructor will first show you the correct sight picture. He may use a large model, a smaller training aid, or a blackboard to do this. Then you will be paired with another soldier for practice in this exercise.

c. Using the sighting and aiming bar, your coach sets up the correct sight alinement and hands the bar to you to examine. You will see the position of the front sight in its relation to the rear sight. Remember that the sight alignment must be accurate. *Demand precision when you are acting as coach so as to help your pupil become a good shot.*

d. The coach then moves the sights out of alinement and has you set up the correct sight alinement (fig. 61①). As soon as you have demonstrated your ability to make correct sight alinements, the coach sets up other small errors in alinement and requires you to locate and correct them.

e. When you are thoroughly familiar with alinement of the sights alone, your coach adds the small bull's-eye to complete the sight picture (fig. 61②). He hands the sighting and aiming bar to you so that you may see the correct sight picture. Your coach then moves the bull's-eye and has you set up the correct sight picture. When you have demonstrated that you can make a correct sight picture, your coach will set up a small



①



②

Figure 61. A pupil making the correct sight alignment and sight picture.

error in the sight picture. You will tell what the error is and correct it.

f. You will serve both as a coach and as a pupil during preparatory marksmanship and range firing.

80. BLACKENING THE SIGHTS (fig. 62)

a. To see your rifle sights and the bull's-eye clearly, you must first clean and then blacken your sights. Remove all traces of oil and dirt. With dirty and improperly blackened sights, you are unable to take the correct sight alinement and the correct sight picture. Dirty sights cause you to aim low, because the bull's-eye rests on top of the dirt rather than squarely on top of the front sight. Clean and blackened sights stand out clearly and are easy to see. Sights that are clean but not blackened are shiny and difficult to see. Figure 62 shows a rifleman blackening his front and rear sights with a carbide lamp. Hold the point of the flame for a few seconds against the front and rear sights and against the barrel near the front sight. Place a uniform coating of blacking on the metal.

b. The best way to blacken the sights is to use a carbide lamp. If this lamp is not available, you can use a kerosene lamp, candle, small pine stick, smudge pot, or even matches.

c. An effective sight blacking preparation may be mixed by adding powdered lamp black to diluted clear shellac. The quantity of lamp black used is small in proportion to the total quantity

of shellac and is best determined by experiment. This black shellac is applied to the sights with a small varnish brush. The preparation dries rapidly.

81. SECOND SIGHTING AND AIMING EXERCISE

a. Look at figure 63. Here you see the layout for the second sighting and aiming exercise.



Figure 62. Blacking the sights.

The rifle, rifle rest, aiming box, aiming disk, a sheet of paper, a pencil, and the M15 sighting and aiming device are used in conducting this exercise for each instructional group of four men. The aiming box is located 50 feet from the position of the rifle. One member of the group is stationed at the aiming box as a marker. The front and rear sights of the rifle are blacked. The rear sight is set at 11 clicks of elevation and zero windage. The rifle is placed in the rest and wedged tight using the sling. During this exercise you must be careful not to move the rifle once you have it pointed at the paper.

b. Your coach now gets into the prone position without disturbing the rifle. He places both elbows on the ground and rests his chin in the palm of his left hand; he signals to the marker with his right hand. His cheek lightly touches the stock so that his eye is approximately the same distance from the peep sight as it will be in actual firing. The coach then signals the marker to move the small bull's-eye until it is in correct alinement with the rifle sights. He holds his breath while doing this, just as is done in firing. When the bull's-eye is correctly placed in position, he calls HOLD to the marker. Your coach will then have you look through the sights so you will see the correct sight picture he has set up.

c. He will then have the marker move the bull's-eye, and each soldier will take turns making the correct sight picture. The coach will set up slight errors in the sight picture and require each soldier to correct them.

82. THIRD SIGHTING AND AIMING EXERCISE

a. *General.* The third sighting and aiming exercise is similar to the second exercise with the exception that three sight pictures are plotted (fig. 63) by each group member. The purpose of this exercise is to test your ability in setting up the correct sight picture as well as to continue your instruction on sighting and aiming.

b. *How to Conduct the Third Sighting and Aiming Exercise.* Assume your position behind the weapon and direct the marker to move the spotter to set up the correct sight picture as you did during the second exercise. Now, command HOLD and rise (fig. 63①). Your coach assumes his position behind the weapon, checks the sight picture, and makes a *mental* note of any error which exists. He does not comment on any error or require any corrections to be made at this time. The coach calls MARK (fig. 63②). The marker then places a dot on the paper by inserting the point of a pencil through the hole in the center of the aiming disk. He then removes the disk and places a small number 1 above the dot to indicate the first sight picture. This exercise is repeated until three sight pictures have been plotted and numbered. The marker then connects the three dots with straight lines to mark the shot group and writes the group member's name under the shot group. The entire group then moves to the aiming box where the coach critiques the group member's performance. He comments on the size and shape of the shot group and, at this time, discusses the errors that

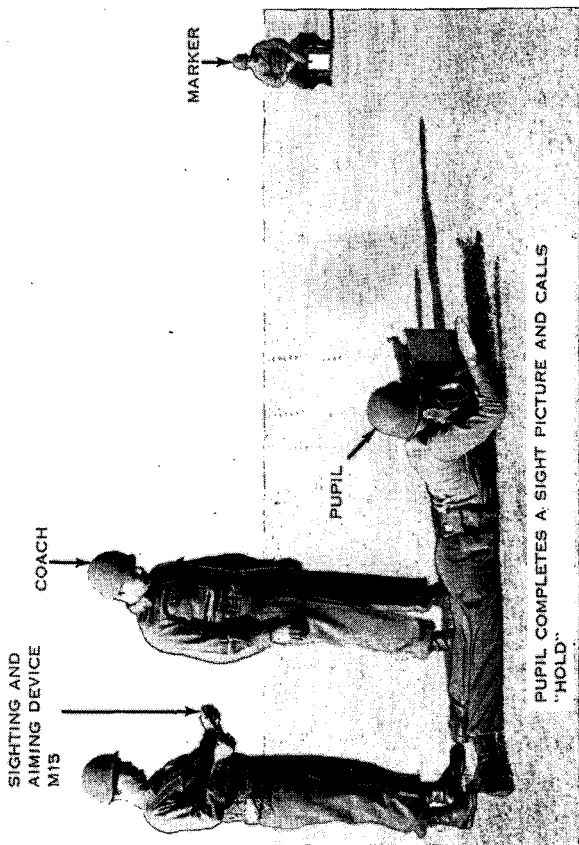

① *Figure 63. Making a shot group.*

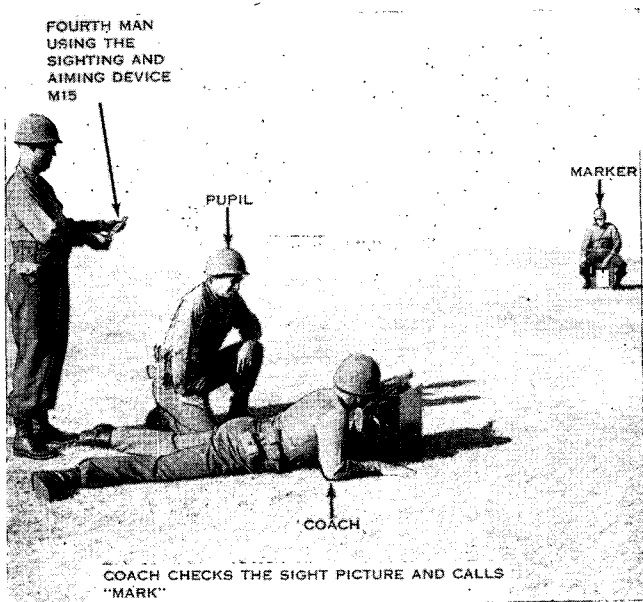

②

Figure 63—Continued.

he detected when he checked the sight picture. A satisfactory shot group made from fifty feet is one that can be covered with the eraser end of a pencil. Each member of the group repeats the exercise until he becomes skilled.

83. ERRORS CAUSING UNSATISFACTORY SHOT GROUPS

You will notice that unsatisfactory shot groups are either too wide or too high (fig. 64).

a. High and narrow shot groups are caused by inaccurate vertical alinement of the sights or

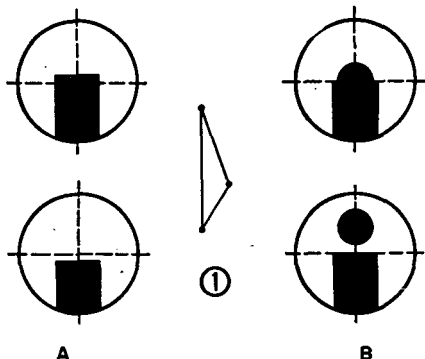

A
 TOP OF FRONT SIGHT NOT
 ON THE HORIZONTAL
 DIAMETER OF PEEP SIGHT

B
 BULLS-EYE NOT TANGENT
 TO FRONT SIGHT

EITHER KIND OF ERROR (A OR B) WILL PRODUCE A
 SHOT GROUP SIMILAR TO 1 ABOVE

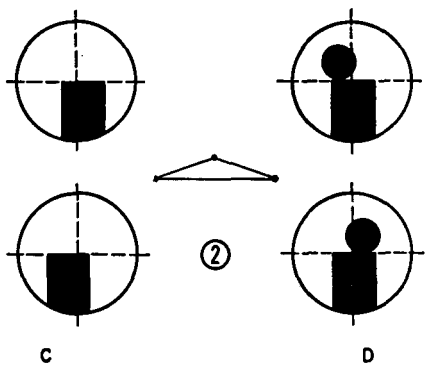

C
 FRONT SIGHT NOT CENTERED
 FROM RIGHT TO LEFT IN
 PEEP SIGHT

D
 BULLS-EYE TANGENT TO
 FRONT SIGHT BUT NOT AT
 THE MIDPOINT

EITHER KIND OF ERROR (C OR D) WILL PRODUCE A
 SHOT GROUP SIMILAR TO 2 ABOVE

Figure 64. Errors causing unsatisfactory shot groups.

by placing the bull's-eye above or below the top of the front sight (① of fig. 64).

b. Flat and wide shot groups are caused by inaccurate horizontal alinement of the sights with each other or of the sights with the bull's-eye (② of fig. 64).

c. A shot group both high and wide is caused by a combination of the errors listed above.

d. In ② of figure 64 the long axis of the group is horizontal. This is a result of one of two errors. Either the front sight was not centered from right to left in the rear sight or the bull's-eye was not centered above the front sight, but was off-centered to the right or left.

84. IMPORTANT POINTS ABOUT SIGHTING AND AIMING

Remember—

a. That the front sight is accurately centered in the rear sight. This is the most important part in aiming.

b. That you do not breathe while aiming.

c. That the bull's-eye is centered above and appears to barely touch the top of the front sight.

d. That the last focus of your eye is on the front sight. This will leave the front sight clear and sharp, while the bull's-eye will appear to be a bit fuzzy.

85. POSITION EXERCISES

a. In the second step of preparatory marksmanship you will receive instruction in the prone,

kneeling, squatting, sitting, standing, crouch and aerial target positions; in adjusting the sling to be used with these positions; and in the method of holding your breath while aiming. What you learn in the first step, you practice in the second.

b. The rifle sling is used for—

(1) Holding the rifle steady while firing.

(2) Carrying the rifle.

c. The sling is used for all firing positions except the crouch and aerial target positions. Either of two sling adjustments, known as the loop sling and the hasty sling, may be used in all other positions. The loop adjustment is the better of the two, except in the standing position.

86. ADJUSTING THE LOOP SLING (LEATHER) FOR THE PRONE, SITTING, SQUATTING, AND KNEELING POSITIONS

a. Place the rifle butt on your right hip and cradle the rifle on the inside of your right forearm, sights to the right (fig. 65①). Both of your hands are now free to adjust the sling. Loosen the sling, then unhook the lower hook and rehook it down near the butt swivel.

b. The loop to be placed on your arm is formed by that part of the long strap between the **D**-ring and the lower keeper. For the average sling adjustment, unhook the upper hook and engage it four to six holes from the end of the long strap (fig. 65①). To shorten or lengthen the sling to conform with your body and arms, make the adjustment by moving the upper hook. Push the lower keeper up; the loop now formed is the loop

2 UNHOOK UPPER HOOK AND ENGAGE IT IN SIXTH HOLE FROM FEED END OF LONG STRAP. THIS IS THE ADJUSTMENT FOR THE AVERAGE SOLDIER



①

Figure 65. Adjustment of the loop sling (leather).

for your left arm. Straighten out the sling so that it lies flat, then give it a half turn to the

left. Insert your left arm through the loop until the loop is high on the upper arm, above the biceps (fig. 65②). Now, using both hands, left hand on the outside strap, right hand on the inside, rotate the sling through the upper swivel, moving the lower keeper and upper hook downward to your arm. This tightens the loop on your arm. Now, to keep the loop from slipping, pull the

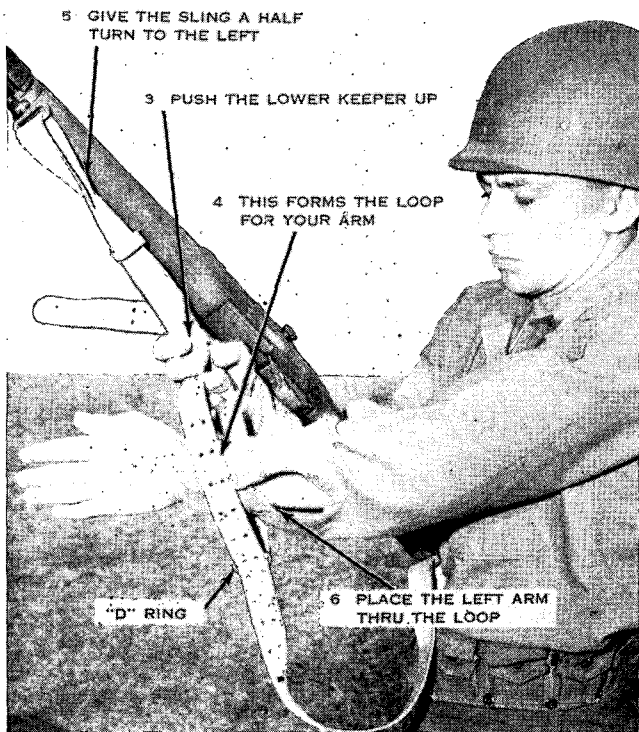

②

Figure 65—Continued.

8 LOCK THE SLING
TIGHT ON YOUR ARM
BY MOVING THE UPPER
KEEPER DOWNWARD AGAINST
THE UPPER HOOK



7 ROTATE THE SLING SO THAT
THE LOWER KEEPER AND UPPER
HOOK ARE AGAINST THE ARM

⑧

Figure 65—Continued.

upper keeper down tight against the upper hook, locking it in place (fig. 65③). The feed end of the sling is left hanging downward. Do not roll it up between the keepers as this will stretch them.

c. For the average soldier, the adjustment of the loop sling in the kneeling, squatting, and sit-



④

Figure 65—Continued.

ting positions is about two holes shorter than that for the prone position.

d. After the sling has been adjusted on the upper arm, grasp the rifle so that the hand is against the stock ferrule swivel and the sling lies flat against the back of the left hand (fig. 65④).

e. Before taking your position, place your left hand so that the rifle lies in the center of the V formed by your thumb and first finger.

f. Some leeway in the position of the loop on the arm is permitted. In general, the loop should be above the biceps; however, experience has shown that many men get good results with the sling somewhat lower. *It is important* that daylight be visible between the sling and the crook of the arm formed at the elbow.

g. Be sure the sling is doing its share of the work in giving your rifle full support. The tendency of most men is to use a sling adjustment which is too long (loose). A properly adjusted sling means a steady rifle (fig. 66).

87. ADJUSTMENT OF THE LOOP SLING (WEB) FOR THE PRONE, SITTING, SQUATTING, AND KNEELING POSITIONS

a. Place the butt of the rifle on your right hip and cradle the rifle on the inside of your right forearm, sights to the right (fig. 67①). Both of your hands are now free to adjust the sling. Unsnap the hook from the butt swivel. The loop to be used is formed by pulling the strap through the two slots of the buckle until it is large enough for your arm. To do this, hold the buckle in the

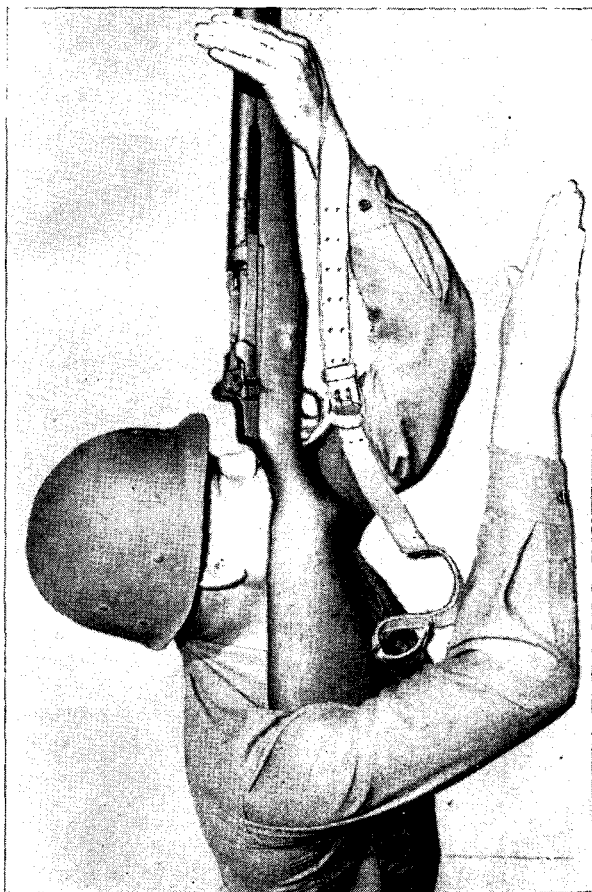

Figure 66. A correct sling adjustment holds the rifle into the shoulder.

right hand; with the left hand, grasp the strap as it passes through the buckle and pull it straight out until the loop is formed. Holding the loop in the left hand, give the sling a half turn to the left. Holding the buckle in the right hand, pass the left arm through the loop until it rests high on the upper arm above the muscle. Tighten the loop on the arm (fig. 67①). With the right



①

Figure 67. Adjusting the loop sling (web).



②

Figure 67—Continued.

hand, grasp the feed end of the sling and unloosen the keeper (fig. 67③). Pull the feed end of the sling toward the butt of the rifle until the proper sling adjustment is reached. Average adjustment is obtained when the feed end reaches the trigger

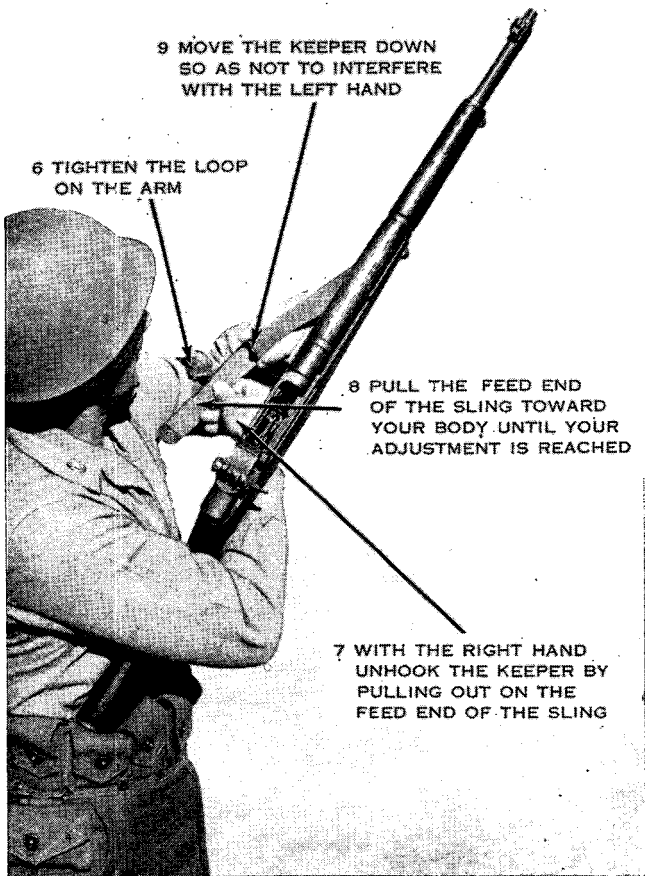

③

Figure 67—Continued.

guard. Move the keeper toward the butt of the rifle until it is out of the way of the left hand. Lock the keeper. Place the left hand over the

sling and move the hand forward to the stock ferrule swivel.

b. The adjustment of the sling for the kneeling, sitting, and squatting positions is the same as the adjustment for the prone position, except that it will be somewhat shorter. You will have to determine this by experience. The point to remember is that the sling must be so adjusted that you have to force the rifle butt into your shoulder, giving maximum support to your rifle.

88. BREATHING

Obviously, if your chest and back are moving, your rifle will move up and down. To prevent this, take a breath of air, then let out a little, and stop breathing by closing your throat (fig. 68). Hold your breath naturally. If you do not fire your shot in a reasonable length of time (8 or 9 seconds), do not attempt to fire, but take several breaths and start all over again. Do not tighten up. Do not become breathless. Practice will teach you to control your breathing without discomfort. Coaches must check pupils carefully on this point: watch the firer's back; if it rises and falls while he is aiming, he is breathing. Watch the muzzle of the rifle. If it *seesaws*, the firer is breathing.

89. RELAXATION AND BONE SUPPORT

a. Now you are ready to learn the firing positions. There are two things to remember about these positions. First, you must be relaxed. Sec-

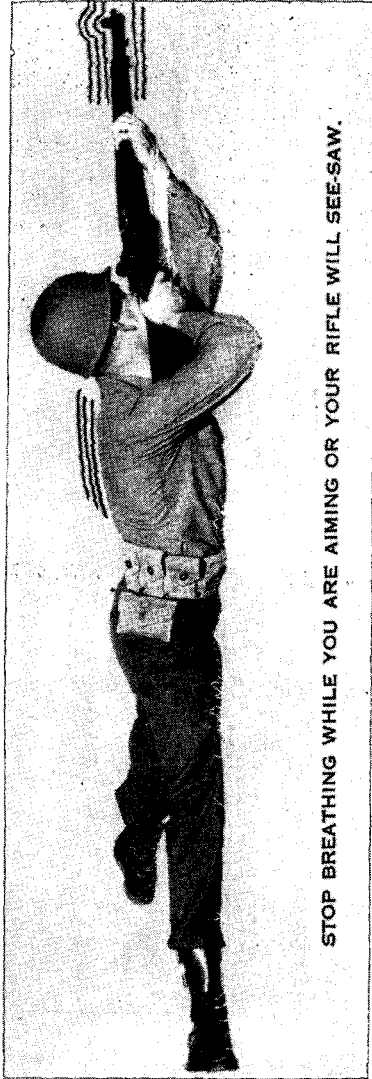

STOP BREATHING WHILE YOU ARE AIMING OR YOUR RIFLE WILL SEE-SAW.

Figure 68. Stop breathing while you are aiming, or your rifle will seesaw.

ond, to be relaxed, your position must be such that the bones of your body, rather than your muscles, support your rifle. You may have difficulty in getting the correct position because your muscles are not limbered up. In a few days, after



A

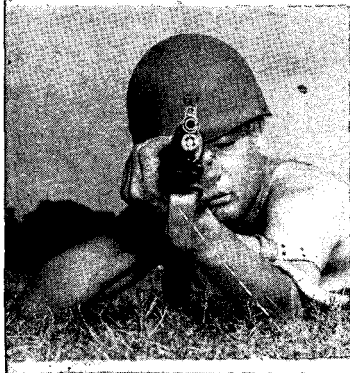
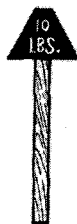

B

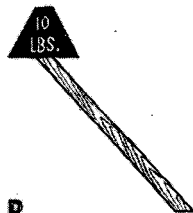

Figure 69. Bones, not muscular effort, support the rifle.

some practice and stretching, you will be able to take the correct position easily.

b. Figure 69 makes the idea a little clearer. In the first picture, the 10-pound weight has a steady support in the straight up and down stick. In the second picture, the stick is slanting; this is not a steady support for the weight. Hold your rifle as shown in the first picture. Do not hold it as shown in the second one. If you do, your muscles will not be able to hold the rifle steady.

c. Remember, *use your bones*, and your position will be both comfortable and steady.

90. PRONE POSITION

(fig. 70)

a. This position is the one most frequently used. It is natural to assume, steady and comfortable.

b. To take the prone position, stand facing your target with your left hand forward to the stock ferrule swivel and your right hand on the heel of the butt. Spread your feet a comfortable distance apart, shift your weight slightly to the rear and drop to your knees. Place the toe of the butt about 30 inches in front of your right knee on a line from your right knee to the target. Pivot on the rifle down onto your left side and place the left elbow on the line of your right knee, the butt of the rifle, and the target. Force the butt of the rifle into your right shoulder. Grasp the small of the stock with your right hand and lower the elbow to the ground so that the shoulders are level. Aim at your target.

c. These are the important features of the prone position:

- (1) The rifle rests in the **V** formed by the thumb and first finger and against the heel of the hand.
- (2) The left wrist is straight.
- (3) The left elbow is under the rifle.
- (4) The fingers and thumb of the left hand are relaxed.
- (5) The left hand is forward against the stock ferrule swivel (unless the firer has a very short arm).
- (6) Daylight is visible between the sling and the crook of the elbow.
- (7) The left shoulder is relaxed forward.
- (8) The spine is straight; the legs are spread a comfortable distance apart.
- (9) The toes are pointing outward; the heels, if possible without discomfort, should touch the ground.
- (10) The angle made by the pupil's spine and the rifle is 30° or less. The firer must be well behind the rifle, so that his weight will act against the recoil of the rifle and cause the muzzle to drop back into position after each shot.
- (11) The butt of the rifle is seated well into the pocket formed in the shoulder as the right elbow is moved forward.
- (12) The right elbow is far enough out so that the shoulders are parallel to the ground.

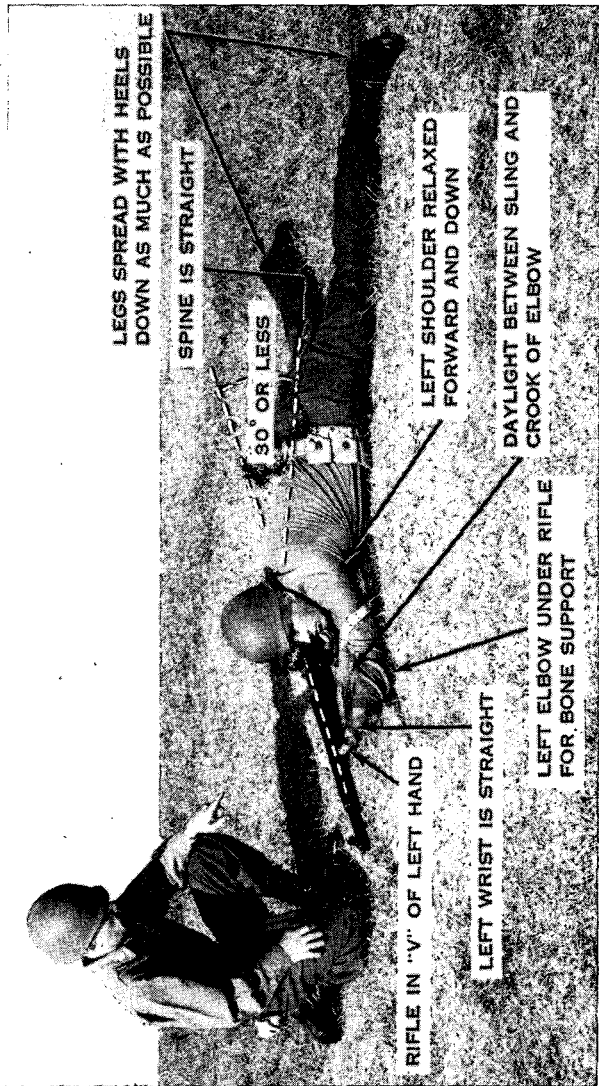

Figure 70. The prone position.

- (13) The small of the stock is gripped firmly with the right hand, the thumb on top of or over the top of the stock.
- (14) The trigger finger, between the tip and the second joint, contacts the trigger. As a general rule, it is best if no part of the trigger finger touches the stock as this may hinder proper trigger squeeze.
- (15) The neck is relaxed. The cheek should rest firmly against the stock and the thumb of the firing hand. This contact between the cheek and the thumb is known as the *spot weld*. It is natural to take the same grip with the right hand each time, and the *spot weld* will position your eye the same distance from the rear sight for every shot.
- (16) The weight of the upper body is relaxed forward against the tension of the sling.

d. You now have the two points that you are striving for: *bone support and muscular relaxation*.

91. ERRORS IN THE PRONE POSITION

Errors most frequently found in the prone position and the method of correcting them follow:

a. *Body Placed at Too Great an Angle with Rifle*. This fault may be detected by observing whether the front part of the body is held too high off the ground and whether the eye is too close to the receiver. Another way to detect this error is to mentally draw a line through the rifle

barrel straight to the rear, and another line through the firer's spine; the angle formed should not be more than 30°. Because of this common fault, most of the recoil is taken up by the shoulder instead of being absorbed by the entire body. The cause of this may be a too short sling adjustment. To correct this, the coach unhooks the sling and has the firer move his body until he has the correct angle. The coach then rehooks the sling. Another cause may be that the firer faces to the right before going into position. To correct this, he rises, faces his target, then assumes the prone position.

b. Right Elbow Too Close to the Body. The right shoulder will be higher than the left shoulder and the back may appear to be twisted. To correct this, the firer moves the right elbow outward and forward so that the right shoulder is level with the left shoulder.

c. Left Elbow not Under the Rifle. This error is easy to detect. In this position the rifle will not return to the same position after each shot. Accuracy and cadence in sustained fire is difficult, if not impossible, unless the elbow is under the receiver. The firer remedies this by relaxing his left shoulder and moving his elbow under the rifle. This is best done with the rifle butt removed from the shoulder. Even though you find this a bit difficult at first, relaxation and practice will enable you to place your elbow under the rifle.

d. Improper Grip. This term is used to describe the error that exists when the wrist is

bent and not straight. This is caused by not placing the rifle in the **V** formed by the thumb and first finger, and by having the rifle rest in the palm of the hand rather than on the heel of the hand. To correct this, the firer removes the butt of the rifle from his shoulder and moves his hand so that the rifle is in the **V** and resting on the heel of his hand.

92. KNEELING POSITION (fig. 71①②③)

a. This position is frequently used on level ground or ground that slopes upward. It is a steady position and can be used to great advantage if you do not have time or space to assume the prone position or when your view of the target would be obscured from that position.

b. To take the kneeling position, face your target. Hold the rifle with the left hand forward to the stock ferrule swivel and the right hand on the rifle butt. Make a right face and then place the left foot about 18 inches to the left front. Rotate over the right toe down onto the right knee. Sit on the right heel with the right buttock. Place the left elbow forward of the left knee several inches. Force the rifle butt into your shoulder and grasp the small of the stock. The right elbow is horizontal or slightly below horizontal. Finally, shift the weight forward onto the left leg. Aim at your target.

c. These are the important features of the kneeling position—

- (1) The firer kneels on his right knee.

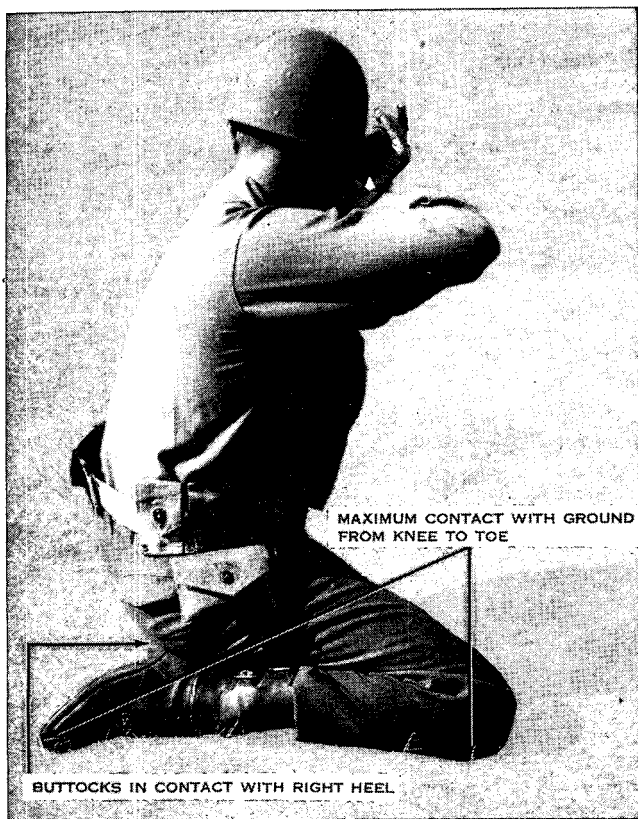

①

Figure 71. The kneeling position.

- (2) He sits on his right heel so that there is solid contact between his right heel and his right buttock. If at first this puts too much strain on the instep, dig a small hole for your toe. Practice in

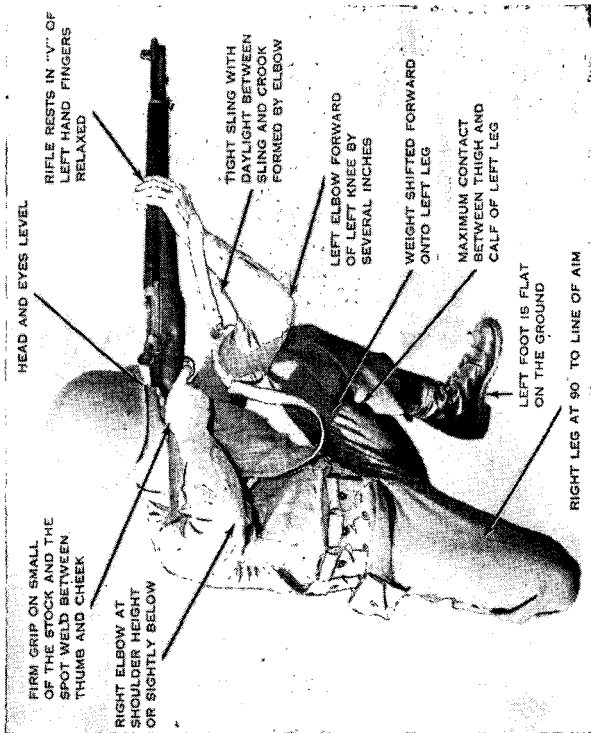

② *Figure 71—Continued.*



⑨

Figure 71—Continued.

this position will eliminate the need for this hole.

- (3) The rifle rests in the V formed by the thumb and first finger and on the heel of the left hand.

- (4) The left wrist is straight.
- (5) The left elbow is directly under the rifle, *for bone support.*
- (6) The left elbow is several inches forward of the left knee; this moves the weight of the body forward.
- (7) Daylight can be seen between the sling and the crook of the elbow.
- (8) The left lower leg is vertical as viewed from the front.
- (9) The toes of the left foot point generally at the target.
- (10) The left foot is drawn back, then the body weight is relaxed forward so that solid contact is made between the calf of the leg and the thigh.
- (11) Notice the position of the right knee. It is placed so that the right thigh forms an angle of 90° with the line of aim. The entire surface of the lower leg, from knee to toe, is in contact with the ground. *The weight of the body is forward.* This takes most of the weight off the right leg and puts it on the left leg. The right leg now completes a solid three-point base. If the right leg forms an angle of less than 90° , then the three-point base is reduced in size. If the angle is greater, the firer is straining the thigh muscles.
- (12) The grasp on the rifle by the right hand, the position of the cheek against the thumb of the firing hand, and the finger on the trigger are the same as for the prone position.

- (13) The right elbow is raised to the height of, or slightly below, the right shoulder, thus forming a pocket or recess in which to seat the butt of the rifle. If the right elbow is held too low, a too shallow pocket is formed. This is a serious disadvantage in sustained fire.

93. ERRORS IN THE KNEELING POSITION

Errors most frequently found in the kneeling position and the method of correcting them are—

a. Sitting on the Inside of the Right Foot. This throws the weight of the body too far to the rear. For this reason, sitting on the inside of the right foot is not a suitable position for sustained fire. In exceptional cases where the physical conformation of the man indicates unusual difficulty in assuming the prescribed position, and after the instructor has required the man to attempt to adapt himself to the normal position, the instructor may authorize him to use this modified position.

b. Left Elbow and Knee not Under the Rifle. Here the muscles, and not the bones, are supporting the rifle. To correct this, the firer takes the rifle butt from his shoulder and moves the left foot to the right, then completes his position.

c. Point-to-Point Contact. When the tip of the elbow rides directly on the knee, a very unsteady position is the result. To correct this, the firer moves the elbow forward of and below the knee. This will shift the weight forward.

d. Right Thigh not at Right Angle to the Line of Aim. To correct this, the firer moves his right knee to obtain a 90° angle.

e. Improper Grip. Correct this as described in paragraph 91d.

94. ALTERNATE KNEELING POSITIONS

a. A man with long legs may modify the kneeling position by:

- (1) Placing the left foot forward of the knee. This will lower the knee. Each firer will have to determine how far to move his left foot forward to bring his line of aim down on the bull's-eye.
- (2) By placing his elbow farther forward. This will lower his aim. *Do not place the knee in the armpit.*

b. A man with short legs may modify the kneeling position by—

- (1) Positioning the left leg so that it is vertical from the foot to the knee as viewed from the side as well as from the front. This will give the firer the maximum height of his leg.
- (2) Bringing his elbow back as far as possible; this will raise his aim. Remember, the tip of the elbow must not rest on top of the knee.

95. SQUATTING POSITION

(fig. 72)

a. This position has important advantages in combat. It can be quickly assumed with either

the loop or hasty sling. The feet only are in contact with the ground, making this a good position to use when firing in mud, shallow water, snow, or in an area contaminated with gas.

b. To take the squatting position, the firer half faces to the right, spreads his feet a comfortable distance apart, and balances his weight equally on both feet. He then squats as low as possible. He places his left elbow down over his knee, then places the butt of his rifle in the pocket of the right shoulder and takes the correct grip with the right hand. The right arm is blocked on the inside of the right knee.

c. These are the important features of the squatting position—

- (1) The rifle rests in the V formed by the thumb and first finger and against the heel of the hand.
- (2) The left elbow is under the rifle.
- (3) The left wrist is straight.
- (4) The left elbow is below and forward of the left knee.
- (5) Daylight can be seen between the sling and the crook of the elbow.
- (6) The shoulders are level.
- (7) The backs of the upper and lower legs are in the fullest possible contact from the knees downward.
- (8) The feet are flat on the ground.
- (9) The right elbow is blocked on the inside of the right knee.
- (10) The right hand grip is the same as for the prone and kneeling position.

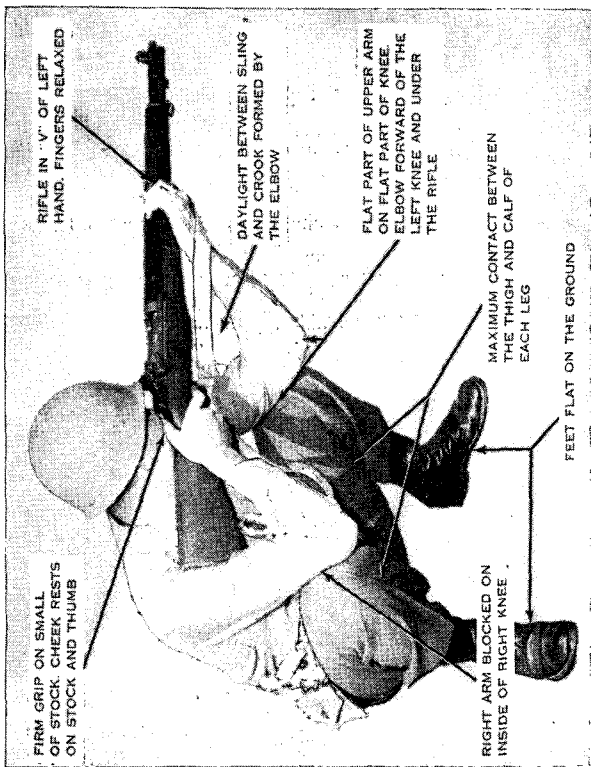

Figure 72. The squatting position.

- (11) The body is relaxed with the weight forward over the left leg.

96. ERRORS IN THE SQUATTING POSITION

Errors found frequently in the squatting position and the method of correcting them are—

a. Contact with Ground Made only with Balls of Feet. As a result of this error, the rifleman is in an unstable position and will be thrown off balance in firing. The remedy is to place the heels on the ground and to relax the body and shift the weight forward over the left leg. Separating the feet more widely helps in getting the heels on the ground.

b. Body not Relaxed and Weight not Shifted Forward Over Left Leg. This position is unstable. It will cause the rifleman to be thrown off balance as soon as he begins to fire. The firer must make a conscious effort to relax, especially in the legs, and shift the weight forward over the left leg.

c. Left Elbow not Under the Rifle. The firer faces more to the right. This will cause him to move his line of aim more over the left arm.

97. SITTING POSITION

(fig. 73①②)

a. For steadiness, this position is second only to the prone position. It is suitable for use where the grass is high, or for any other reason where the view would be obscured in the prone position. It is also suitable for firing downhill.

b. To assume the sitting position, the rifleman half faces to the right, spreads his feet a comfort-

able distance apart, and sits down. He breaks his fall by using the right hand and arm and then moves his buttocks to the rear until the undersides of his knees are about a hand span off the ground. He bends forward from the waist, placing the left upper arm on the flat part of the shinbone so that the tip of the elbow is crossed over the shinbone. There should be several inches of contact between the upper arm and the shinbone. Forcing the rifle butt into his shoulder, he takes the correct grip on the rifle and blocks his right elbow in front of the right knee. He then relaxes his body into the sling.

c. These are the important features of the sitting position—

- (1) The rifle rests in the **V** formed by the thumb and first finger and against the heel of the hand.
- (2) The left elbow is under the rifle; the left wrist is straight.
- (3) Daylight is visible between the sling and the crook of the elbow.
- (4) The left upper arm is forward and down over the left knee, having several inches of contact with the flat part of the left shin, the tip of the elbow crossed over the shinbone.
- (5) The weight of the body is relaxed forward at the waist.
- (6) The feet are farther apart than the knees, with the feet relaxed forward at the ankles.
- (7) The weight of the upper part of the body is forward on the legs.



① *Figure 73. The sitting position.*

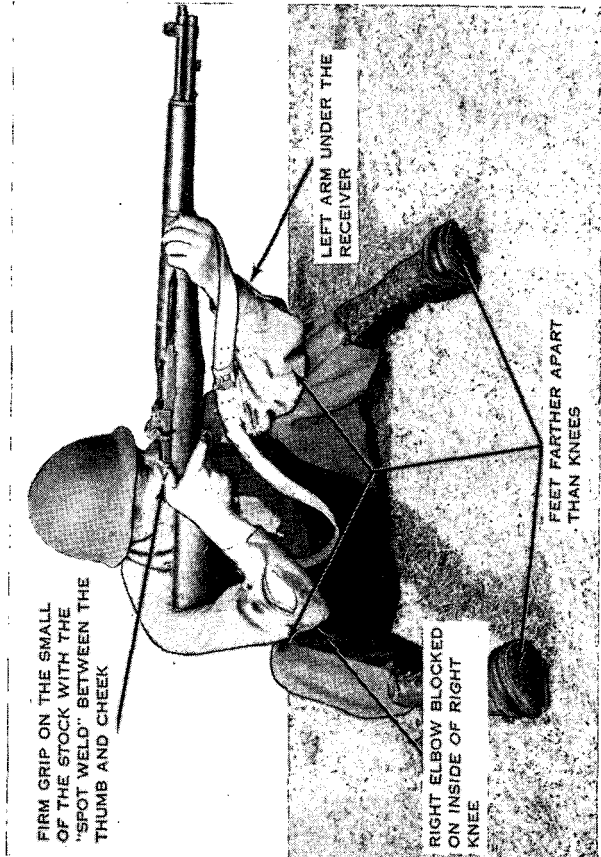

FIRM GRIP ON THE SMALL OF THE STOCK WITH THE "SPOT WELD" BETWEEN THE THUMB AND CHEEK

LEFT ARM UNDER THE RECEIVER

RIGHT ELBOW BLOCKED ON INSIDE OF RIGHT KNEE

FEET FARTHER APART THAN KNEES

② Figure 73—Continued.

- (8) The butt of the rifle is held in the pocket of the right shoulder by the tension of the sling.
- (9) The right arm is blocked by the right knee.
- (10) The grip on the small of the stock, the position of the trigger finger, and the *spot weld* between the cheek and thumb are the same as in the other positions.

98. ERRORS IN THE SITTING POSITION

Errors found frequently in the sitting position and the method of correcting them are—

a. Tips of Elbows Resting on Top of Knees (Point-to-Point Contact). This error results in an unstable support for the rifle. It places the body in a position which is too erect. Each shot will destroy the position. To correct this error, the firer lowers his knees, bends his body well forward at the waist, and makes contact between the left upper arm and the left shinbone. He blocks the right elbow in front of the right knee.

b. Knees Farther Apart Than the Feet. This error causes muscular strain rather than relaxation. This error may have been caused by one of the following faults:

- (1) Placing the feet too close together. To correct this, the firer lowers his legs and spreads his feet farther apart, then completes the position.
- (2) Turning the toes outward, which throws the knees outward. To correct this, the

firer turns the toes inward slightly and puts the weight of the rifle down on the shinbone instead of outward.

c. *Toes Pointing Up*. This usually indicates muscular tension. To correct this, the man relaxes his leg muscles.

d. *Left Elbow not Under the Rifle*. To correct this, the firer moves his feet 5 or 6 inches to the right.

e. *Improper Grip*. To correct this, the firer removes the rifle butt from his shoulder and moves his hand so that the rifle is in the **V** and resting on the heel of his hand.

99. ALTERNATE SITTING POSITIONS

a. *Cross-Legged Position* (fig. 74). In this position the firer sits with the left leg crossed over the right leg. His feet are drawn up close to the body so that the outer part of the calf of each leg rests on the inside of the opposite foot. The back of the upper arms are supported against the shinbones and are very nearly at right angles to them. The rest of this position is the same as for the normal sitting position.

b. *Cross-Ankled Position* (fig. 75).

- (1) In this position the left ankle is crossed over the right ankle, the legs extended well away from the body. Here, as in the cross-legged position, the upper arms are supported by the shins. The rest of this position is the same as the normal sitting position.

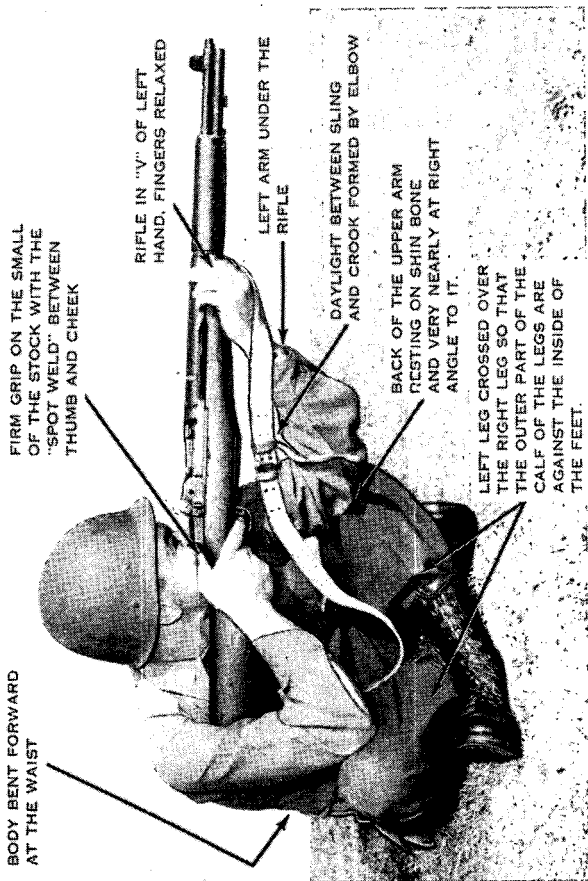

Figure 74. The cross-legged position (alternate to the normal sitting position (fig. 73).)

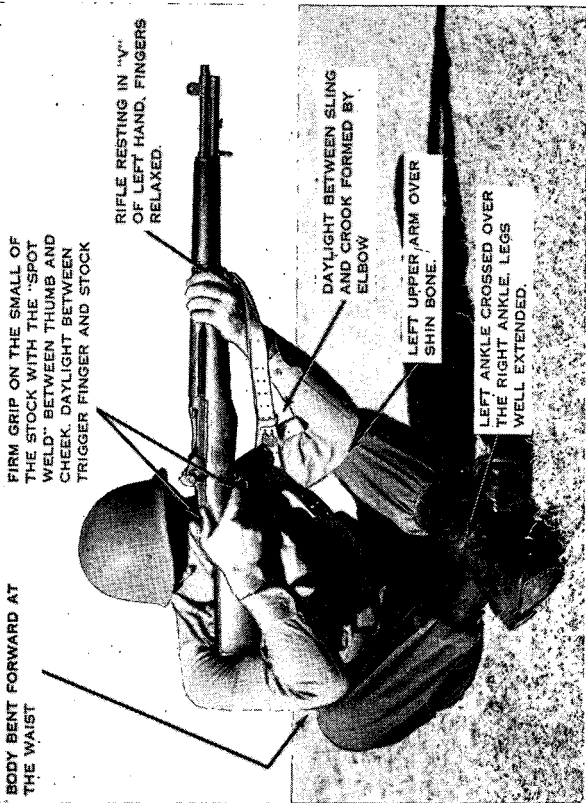

Figure 75. The cross-ankled position (alternate to the normal sitting position (fig. 73).)

- (2) The cross-ankled position provides only a two-point base of support and is less stable than the cross-legged position, which has a three-point base. A firer weighing less than 170 pounds should avoid the cross-ankled position. The amount of leg extension depends on the leg conformation of the firer. Care must be taken in this position that the knees are not held up by sheer muscular effort.

100. ADJUSTMENT OF THE HASTY SLING

a. General. The hasty sling is used in the standing position. In other positions the loop sling is normally used in training, because it gives better support than the hasty sling. However, the hasty sling has one advantage—it can be adjusted quicker and easier than the loop adjustment. In combat, where speed may be essential, use of the hasty sling is advantageous.

b. Adjusting the Hasty Sling (Leather). If the sling is adjusted for the loop sling, unhook the lower hook and rehook it in the parade position. Now place the butt of the rifle on your right hip, cradled in your right arm. This leaves both hands free to adjust the sling. Grasp the outside strap near the butt swivel with the left hand; with the right hand, grasp the inside strap of the sling near the stock ferrule swivel. Pull down with the left hand and upward with the right hand. This will loosen the sling. Continue this until the sling extends about two inches below the rifle butt. Grasp the rifle at the small of the stock with the

right hand. With the left hand, give the sling a half turn to the left. Insert your left arm between the sling and the rifle so that the sling is high on the left upper arm. Pass the left hand to the left and under the sling and then to the right over the sling (fig. 76). Grasp the rifle with the left hand. If the sling has been given a half turn, it



Figure 76. Adjusting the hasty sling (leather).

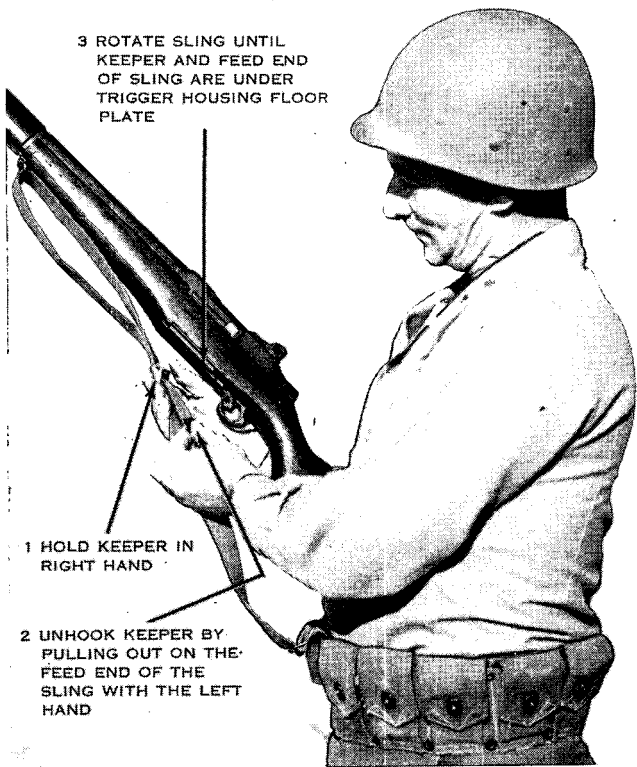

3 ROTATE SLING UNTIL
KEEPER AND FEED END
OF SLING ARE UNDER
TRIGGER HOUSING FLOOR
PLATE

1 HOLD KEEPER IN
RIGHT HAND

2 UNHOOK KEEPER BY
PULLING OUT ON THE
FEED END OF THE
SLING WITH THE LEFT
HAND

①

Figure 77. Adjusting the hasty sling (web).

will lie flat along the back of the left hand and wrist. Another method of adjusting the hasty sling is as follows: from the parade position, unhook the lower hook and count down 10 or 11 pairs of holes. Rehook the lower hook. This will extend the sling 2 or 3 inches below the butt of

the rifle. Either method of adjustment described above will fit the average soldier; however, each man will have to determine his correct sling adjustment.

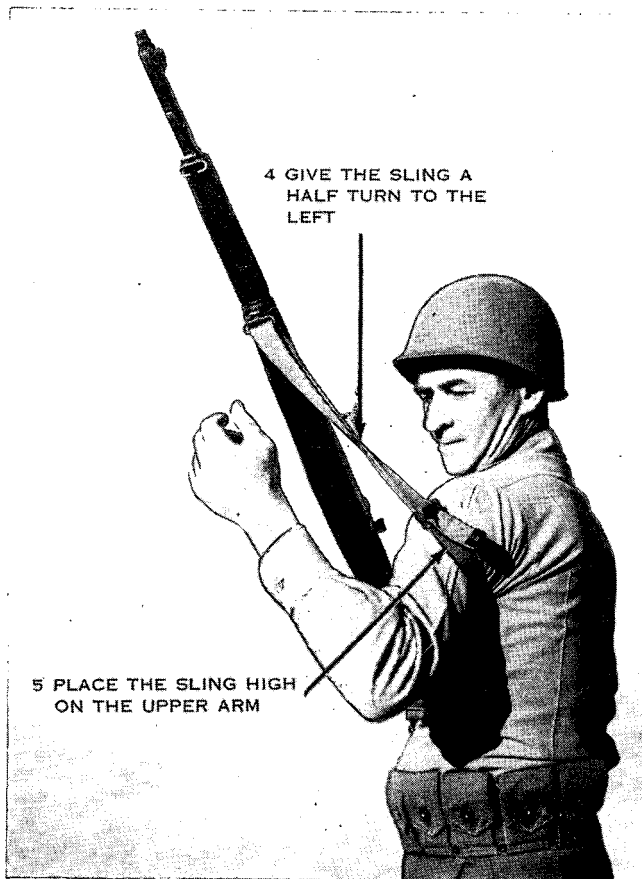

②

Figure 77—Continued.



③

Figure 77—Continued.

c. Adjusting the Hasty Sling (Web). Place the butt of the rifle on your right hip, cradled on your right arm. This leaves both hands free to adjust the sling. Holding the keeper in the right hand, grasp the feed end of the sling with the left hand, pull out on it, and unhook the keeper. Move the keeper and feed end of the sling until they are positioned by the trigger housing floor plate (fig.

77①). This is the sling adjustment for the average soldier. Lock the keeper. Give the sling a half turn to the left; then place the left arm through the sling so that the sling is high on the upper arm (fig. 77②). Move the left hand to the left and under the sling and then to the right over the sling. Grasp the rifle with the left hand between the balance and the stock ferrule swivel. If the sling has been given a half turn to the left, it will lie flat along the back of the left hand and wrist (fig. 77③). Each man will have to determine his own correct sling adjustment by moving the keeper and feed end of the sling until this adjustment is reached.

101. STANDING POSITION

a. The standing position, which is known as the offhand position, is normally used in the assault. This position is used for a range of about 100 yards. In firing from this position, the rifleman quickly assumes the position, fires, and then moves forward.

b. To assume this position, stand facing your target, make a right face, and spread your feet ten to fourteen inches apart. Now move the right foot forward a few inches. This places your body at an angle of approximately 85° with your line of aim. Place the sling on your arm and the left hand just forward of the balance. With the right hand, raise the rifle butt upward until the sights are level with the eyes and the toe of the butt is high on the shoulder (fig. 78). About half of the butt should be visible from the rear. Raise the

PLACE THE BUTT OF THE
RIFLE HIGH ON THE SHOULDER
SO THAT ABOUT HALF OF IT
SHOWS FROM THE REAR

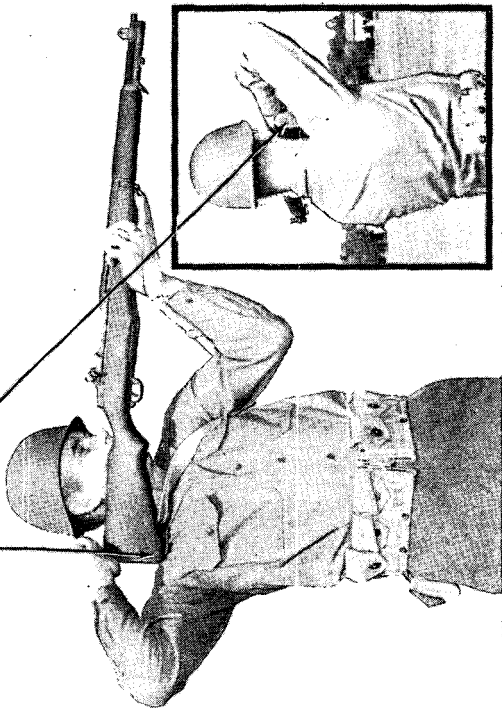

Figure 78. Taking the standing position.

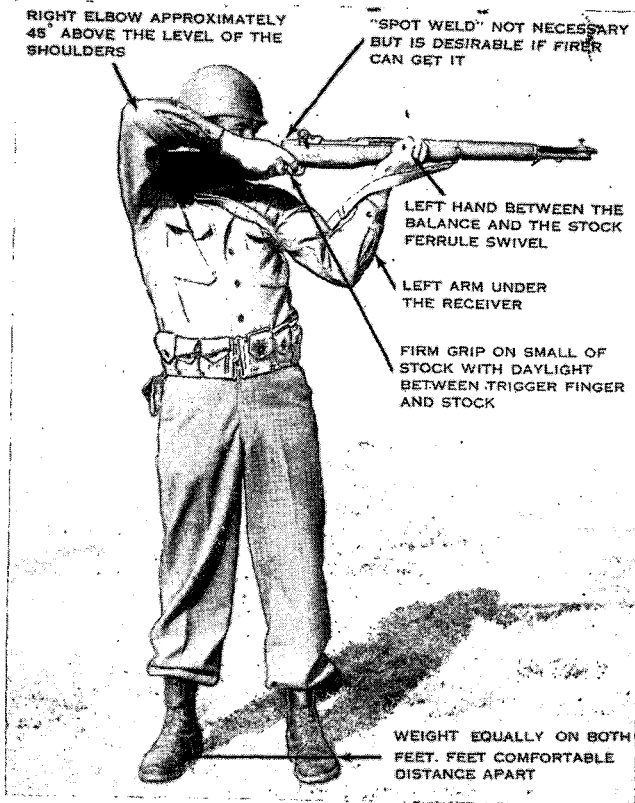

Figure 79. The standing position.

right arm as high as possible, even stretch a little, and then bend the arm at the elbow until the hand can grasp the small of the stock. The right elbow is now at an angle of approximately 45° above the level of the shoulders. Take a firm grip on the small of the stock and pull back hard. This will keep the butt of the rifle pressed into the pocket

of the right shoulder. Finally, make sure that the hips are level and the weight of the body is evenly distributed on both feet (fig. 79).

c. These are the features of the standing position—

- (1) The body is faced to the right, about 85° with the line of aim.
- (2) The feet are spread 10 to 14 inches apart.
- (3) The weight of the body rests equally on both feet.
- (4) The left hand may be anywhere between the balance and the stock ferrule swivel, with the rifle in the **V** formed by the fingers and resting on the heel of the hand.
- (5) The left elbow is under, or nearly under, the rifle.
- (6) The butt of the rifle is high on the right shoulder.
- (7) The right elbow is 45° above the level of the shoulders. The right arm and hand do all the holding—the left arm only steadies the rifle.
- (8) The *spot weld* of the cheek and the right thumb is used when possible; otherwise, the cheek is pressed firmly against the stock.
- (9) The trigger finger is on the trigger and arched so that it does not bear against the stock.
- (10) The firer relaxes the weight of his trunk

straight down and evenly distributed on both hips.

102. ERRORS FREQUENTLY FOUND IN THE STANDING POSITION

The errors most frequently found in the standing position and the method of correcting them are—

a. *Feet Spread Too Far Apart.* The firer should place his feet as if he were going to stand still for about an hour without moving them.

b. *Weight not Evenly Placed on Both Hips.* The firer should relax his weight straight down.

c. *Neck Bent Sideways or Forward to Get the Cheek Against the Stock.* Hold the head erect and bring the rifle sights up to the eyes. A sling which is too short may be pulling the rifle down. Lengthen the sling enough to place the butt of the rifle high on the shoulder.

103. CROUCH POSITION (fig. 80)

a. This is a position from which you can deliver fire quickly in a *sudden engagement* with the enemy at *extremely short ranges up to 30 or 35 yards*. Fire from this position is delivered rapidly while the firer has his body bent at the knees and waist, offering a smaller target to the enemy. From this position the firer may move in any direction, making himself a difficult target to hit.

b. These are the important features of the crouch position—

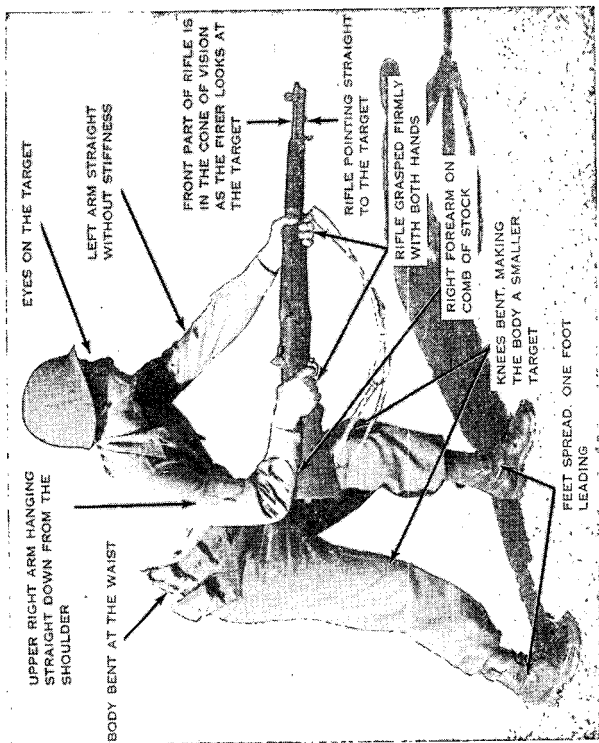

Figure 80. The crouch position.

- (1) The feet are spread a comfortable distance apart, with one foot leading.
- (2) The knees are bent, making the body a smaller target.
- (3) The rifle is grasped firmly at the small of the stock with the right hand.
- (4) The right forearm is along the comb of the stock.
- (5) The left arm is straight without stiffness, the hand grasping the rifle firmly near the front band.
- (6) The weight of the body is well balanced so that the firer may move quickly in any direction.
- (7) The firer keeps his eyes on his target. Within his cone of vision he can see his rifle extended toward the target.
- (8) He aims with the rifle, right arm, and hand.
- (9) He uses the left arm to raise or lower his aim.
- (10) The firm grip that the firer has on the rifle with both hands enables him to fire rapidly and accurately.

c. During practice or firing in this position, the coach corrects the slightest error and demands perfection. Your duties as coach include seeing that—

- (1) The position has stability.
- (2) The position is a natural one, being well balanced to eliminate awkwardness.
- (3) The upper right arm hangs straight down with the forearm pressed against the comb of the stock.

- (4) The rifle is level.
- (5) The firer keeps his eyes on the target.

104. AERIAL TARGET FIRING POSITION (fig. 81)

a. General. The positions used in firing at aerial targets are those that can be assumed rapidly, that afford the maximum flexibility to the body for operation of the rifle, and that do not require undue exposure of the firer. The kneeling or standing position will usually be taken. The kneeling position best meets the requirements listed above as it is less vulnerable than the standing position.

b. Firing Positions.

- (1) Aerial target firing positions differ from those used in ground target firing in that—
 - (a) The sling is not used.
 - (b) The arms are not supported but move freely with the body in any direction.
 - (c) In the kneeling position, the buttock does not rest on the right heel and the left foot is well advanced to the left front. The weight is slightly forward.
- (2) The positions must be such that the rifle, the body from the waist up, the arms, and the head are a fixed unit.
- (3) When leading a target, the rifle is swung with a smooth, uniform motion. This is accomplished by pivoting the body at the waist. There should be no independent movement of the arms, shoulders, head or rifle.



Figure 81. The aerial target position.

c. Duties of the Coach. During practice in teaching aerial target positions, the coach sees that—

- (1) The proper position is taken.
- (2) The rifle is swung with a smooth, uniform motion.

- (3) The rifle is swung by pivoting the body at the waist.
- (4) The arms, shoulders, rifle, and head move as a unit as the rifle is swung.
- (5) The pupil continues to aim and squeeze the trigger during the entire tracking of the target.

105. TRIGGER SQUEEZE (fig. 82)

a. Importance of Trigger Squeeze. The most important single factor in marksmanship is *trigger squeeze*. Everything about your position and aim may be perfect, but, unless you squeeze the trigger correctly, your shot will not go where you have aimed it. Squeezing the trigger correctly is not as easy as it might appear; the technique must be fully understood before you can hope to do it perfectly. If you jerk the trigger, you lose control. It is important to understand that jerking the trigger may disturb the sights only slightly. Even this slight movement, however, will spoil an otherwise good shot. A bigger movement—the one which really spoils the aim—is a body movement which occurs before the bullet leaves the barrel. This movement, made in anticipation of the recoil of the rifle, will occur if you know in advance when the recoil will come. This movement is called *flinching*. The trigger must be squeezed so steadily that you do not know at which instant the rifle is to fire. If you do not know when the rifle is to fire, you will not spoil

your aim by flinching, *because you do not know when to flinch.*

b. How to Apply Trigger Squeeze to Fire Your Rifle. After completing your position, take a breath of air, expel part of it and lock your throat. Align your sights on the bull's-eye, take up the slack and part of the squeeze with a firm initial pressure; continue the steady movement of your trigger finger straight to the rear until the rifle fires. Now, if the rifle fires *before you expect it to*, the shot will be good, for you are



①

Figure 82. Trigger squeeze.



②

Figure 82—Continued.

holding your breath and your sights are aligned on the bull's-eye. To remember this sequence, think of the word **BASS—BREATHE—AIM.** (Take up the) **SLACK—SQUEEZE** (until the rifle fires).

c. Important Points in Trigger Squeeze.

- (1) Apply pressure with the trigger finger only.
- (2) Once the slack is taken up, pressure is firm and continuous straight to the

rear. However, if the rifle does not fire in a reasonable length of time (8 or 9 seconds) after the slack is taken up, release the pressure and take another breath and start all over. Apply pressure straight to the rear to avoid pulling the sights out of alinement.

- (3) Your attention must be divorced from your trigger finger. This finger works automatically when you are well trained. Then you can concentrate all of your attention on the correct sight picture.
- (4) Every shot must be a surprise to you. This means that you should not know precisely when the rifle will fire. Otherwise, you will instinctively brace yourself to meet the recoil. Such bracing or tensing of the muscles will disturb the sight picture.
- (5) The difference between the unqualified soldier and the expert may be measured by their ability to squeeze the trigger correctly.
- (6) Trigger squeeze is the same in sustained fire as in slow fire.
- (7) An unsteadiness or tendency to wobble is natural in the kneeling and standing positions. Reduce this wobble (you can never entirely eliminate it) by practicing these positions and by squeezing the trigger with a continuous pressure. The desire to hit the bull's-eye will tempt you to fire the shot at the instant the

sights come into correct alinement. This is snap shooting. The result is usually a bad shot. DO NOT SNAP SHOOT.

106. CALLING THE SHOT

a. One way to teach yourself to squeeze the trigger is to call your shot. If you can tell where your shot will hit, then you are shooting with your eyes open and you are squeezing the trigger. If you cannot call your shot, you do not know where the sights are pointing when the rifle fires; you are blinking and flinching when the rifle fires. When you blink and flinch, only luck will put the bullet in the bull's-eye. In combat you cannot afford to rely on luck.

b. To call the shot, you must notice where the sights are pointed at the instant the rifle is fired and call out, *at once*, where you think the bullet will hit. Shots are called even when dry firing at a target in order to develop the habit of concentrating on accurate aiming and calling the shot. No man can become expert until he is able to call his shot *before it is marked*.

c. Shots are called by assuming that the bull's-eye is the face of a clock, with 12 o'clock at the top of the bull's-eye and 6 o'clock at the bottom. Examples of calls are *center bull*, *bull's-eye at 4 o'clock*, *a close four at 9 o'clock*.

107. FOLLOW-THROUGH

Follow-through is the procedure that most effectively enables you to call your shots and to

detect errors in your position. Follow-through means that after your rifle fires you remain in position for a few seconds; you continue to hold your breath; you continue to look through the sights; and you continue to squeeze the trigger.

a. When you use follow-through, you keep your mind and your muscles concentrated on your shot for an instant or two after your rifle fires. In this moment of concentration, you will have a clear mental picture of all the elements that may have affected your shot; if your sight picture was slightly out of line when the rifle fired, you will remember it and will be able to call your shot accordingly.

b. Almost everyone who does target shooting has a tendency to remove the rifle from the shoulder or to draw the head away from the stock too quickly after firing. Sometimes these impulsive movements begin before the rifle fires. The practice of follow-through controls these impulses.

108. PROCEDURE IN CONDUCTING TRIGGER SQUEEZE EXERCISES

a. The instructor explains to the group the importance of trigger squeeze. By asking questions, he is assured that each pupil understands what is meant by a steady increase of pressure. Working alternately as coach and pupil, each man practices the trigger squeeze exercises. First, the pupil puts his finger on the trigger and then the coach puts his finger on top of the pupil's finger. As the coach squeezes with his finger, the pupil can feel the steady pressure to the rear until the

hammer falls. Next the coach puts his finger on the trigger and the pupil places his finger on top of the coach's finger. As the pupil applies trigger squeeze until the hammer falls, the coach can determine if the pupil understands trigger squeeze and knows how to apply it.

b. The instructor then explains *calling the shot*, because you must learn to call your shots as you practice the trigger squeeze.

c. You first practice the correct trigger squeeze in the prone position. You can hold steadily in this position and you are not tempted to snap the shot the instant the front sight touches the bull's-eye. After you have learned the principles of correct trigger squeeze in the prone position, you practice it in the other positions.

d. A great deal of *carefully coached trigger squeeze practice* is essential to good combat firing. Faulty trigger squeeze practice is worse than no practice at all.

e. In coaching a pupil during dry firing, be sure that he is aiming at a definite target and carrying out the principles of *aiming, squeezing the trigger, following through, and calling his shot*.

109. DUTIES OF THE COACH

a. Your duties as coach become more and more important as the pupil progresses in marksmanship. Constantly check everything and leave nothing to chance. In this way you will have the satisfaction of seeing your pupil improve and become one of the company experts.

b. To assist you in checking the pupil's sight picture at the instant the hammer fell, make use of the M2 aiming device. By listening for the fall of the hammer and looking through the M2 device, you will be able to tell your pupil whether or not he had his sights correctly aligned at the instant the hammer fell. You will also be able to tell the pupil whether or not he called his shot correctly.

c. The duties of the coach in trigger squeeze exercises are to see that—

- (1) The sights are blacked and kept black.
- (2) The sling is properly adjusted.
- (3) The firer is in a good, steady position.
- (4) The breath is held during aiming and squeezing.
- (5) The trigger slack is taken up decisively in one motion with a heavy initial pressure.
- (6) The trigger is *squeezed*.
- (7) The firer follows through and calls his shot.
- (8) The firer does not take too long to squeeze off a shot. If he takes too much time, make him stop, rest, and start over.

110. SUSTAINED FIRE, GENERAL

a. Everything that you have learned in the preceding steps is applied in sustained fire. The positions, method of breathing, aiming and squeezing the trigger are the same as in slow fire. The time is less because you take the position

rapidly, reload quickly without fumbling, and fire a number of rounds in succession. NEVER SACRIFICE ACCURACY FOR SPEED.

b. You practice sustained fire in three progressive exercises—

- (1) The first exercise is a cadence exercise to develop a steady rhythm for firing a series of shots.
- (2) The second exercise is practice in taking positions rapidly, simulating reloading the rifle, and firing a total of 9 rounds in 50 seconds.
- (3) The third exercise is practice in taking positions rapidly, reloading with a clip of dummy rounds, and firing a total of 9 rounds in 50 seconds.

111. FIRST SUSTAINED FIRE EXERCISE—CADENCE

a. The most important point in sustained fire is the development of correct timing (cadence) in firing. In starting, you will find the time will vary for each shot; but as rhythm (cadence) is developed, the time for each shot will become the same. If you try to hurry, you lose accuracy; *so do not hurry.*

b. The development of correct timing depends on your having a correct position. If your position is correct, the sights will return automatically to the aiming point after each shot is fired. As soon as the sights come back on the aiming point, you can concentrate on the sight picture and instantly begin to squeeze the trigger. This process is repeated for each shot.

c. From his position, the coach strikes the operating rod handle sharply to the rear and releases it. The result is the same as if you actually fire your rifle; the sight picture is disturbed, the rifle recoils, and cocking takes place. To prevent the bolt from staying in the rear position, a clip fitted with a grooved wooden block is used (fig. 83). This clip is loaded into the receiver in the same manner as a clip of live or dummy rounds.

d. The cadence exercise is given in the prone, kneeling, squatting, and sitting positions. For this exercise the pupil gets into position and aims at the target. The coach takes a position to conform with the pupil's position, with his right hand a few inches forward of the operating rod handle. In this position he is able to strike the operating rod handle sharply all the way to the rear in order to cock the rifle, and to simulate the effect of recoil.

e. With coach and pupil in position, the instructor gives the following command: FIRER IN POSITION, AIM AT YOUR TARGET. BOLT FORWARD, HAMMER DOWN. BOLT. Upon the command BOLT, the coach strikes the operating rod handle to the rear, cocking the rifle (fig. 84). The pupil holds his breath, aligns the sights, takes up the trigger slack, and continues the squeeze until the hammer falls.

f. The command BOLT is repeated every 5 seconds for the first runs in all positions. When the pupil is able to get the shots off at this interval without hurrying, the time is reduced to 4 seconds. Four seconds per shot is the ideal cadence for sustained fire.

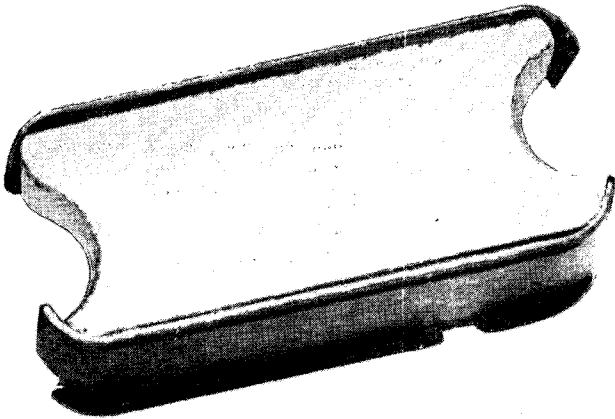

Figure 83. The M1 clip fitted with grooved wooden block.

g. For the pupil to get a definite idea of the time interval, the coach strikes the operating rod handle only on the command BOLT.

h. NEVER SACRIFICE ACCURACY FOR SPEED.

i. A word about breathing — each time the hammer falls, the pupil calls out the number of that shot. The number is preceded by the letter *h*, such as *hone*, *htwo*, *hthree*, *hfour*. In calling the shots in this manner, the pupil expels what air he has left in his lungs, and he has to breathe again before the next shot. He is also counting his shots so that he knows how many are left.

112. TAKING POSITIONS RAPIDLY

Before practicing the second sustained fire exercise, you are instructed how to take positions rap-



①

Figure 84. Practicing sustained fire, prone and kneeling positions.

idly and how to reload. Initially each movement is practiced slowly—by count (par. 113). As you become accustomed to these movements, you develop speed and accuracy in taking the positions. The time you need to take any position and fire your first shot should be about 10 seconds.



②

Figure 84—Continued.

113. TAKING THE PRONE POSITION FROM STANDING

a. Take the prone position and sight on the bull's-eye. Close your eyes and relax completely. Open your eyes and, if your sights are still alined on the bottom of the bull's-eye, drop the rifle butt from your shoulder and mark the spot where it strikes the ground. Mark the spots for both elbows, then rise to your knees without moving the position of your toes, then rise to your feet. You are now in the ready position with the sling ad-

justed, the left hand forward to the stock ferrule swivel, and the right hand at the heel of the butt.

- (1) At the count of ONE, shift your weight slightly to the rear and drop to your knees (fig. 85①).
- (2) At the count of TWO, fall forward placing the toe of the rifle butt on the spot marked for it (fig. 85②).



①

Figure 85. Taking the prone position rapidly.



AT THE COUNT OF TWO, FALL FORWARD PLACING THE TOE OF THE BUTT OF THE RIFLE ON THE SPOT MARKED FOR IT. TWO

②

Figure 85—Continued.

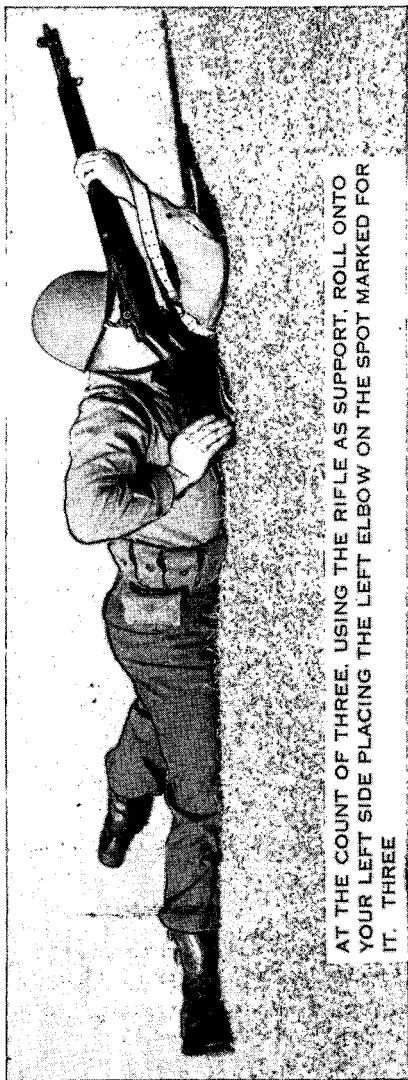

AT THE COUNT OF THREE. USING THE RIFLE AS SUPPORT, ROLL ONTO YOUR LEFT SIDE PLACING THE LEFT ELBOW ON THE SPOT MARKED FOR IT. THREE

③
Figure 85—Continued.

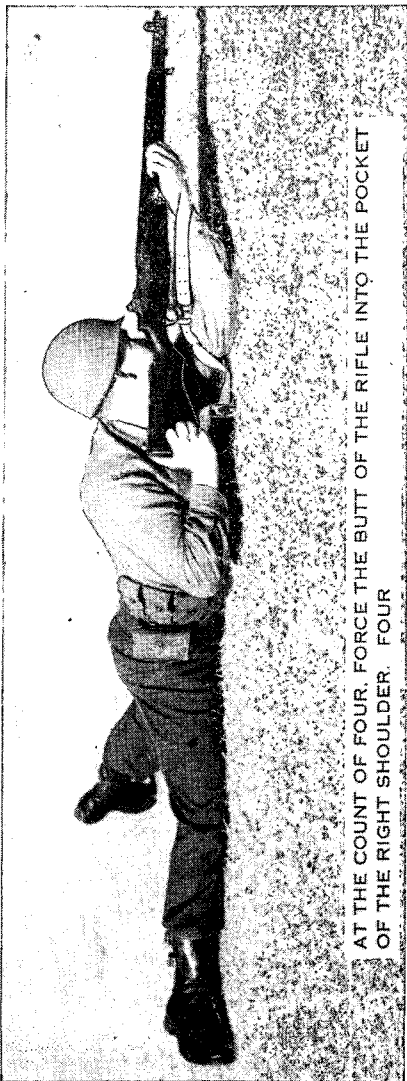

AT THE COUNT OF FOUR, FORCE THE BUTT OF THE RIFLE INTO THE POCKET
OF THE RIGHT SHOULDER. FOUR

④

Figure 85—Continued.

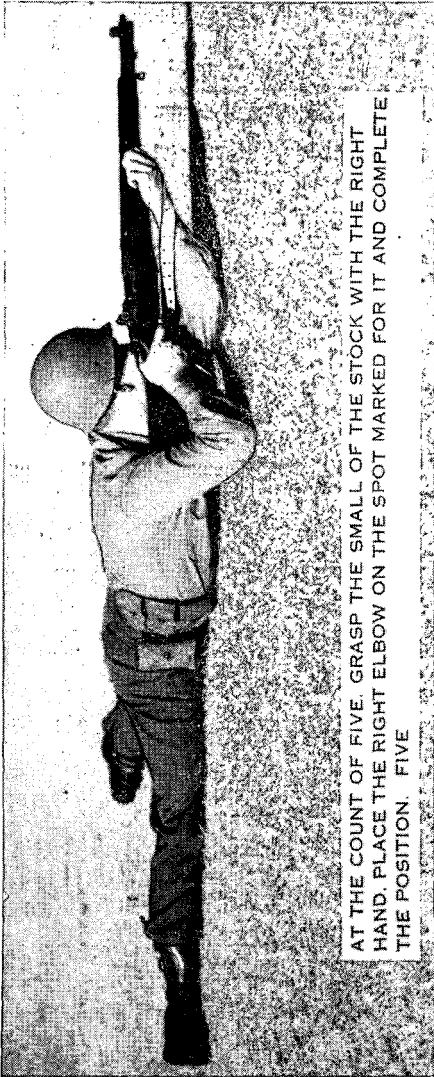

AT THE COUNT OF FIVE. GRASP THE SMALL OF THE STOCK WITH THE RIGHT HAND. PLACE THE RIGHT ELBOW ON THE SPOT MARKED FOR IT AND COMPLETE THE POSITION. FIVE

⑤ *Figure 85—Continued.*

- (3) At the count of THREE, using the rifle as support, roll onto your left side placing the left elbow on the spot marked for it (fig. 85③).
- (4) At the count of FOUR, force the rifle butt into the pocket of the right shoulder (fig. 85④).
- (5) At the count of FIVE, grasp the small of the stock with your right hand, place your right elbow on the spot marked for it, and complete your position (fig. 85⑤).
- (6) You are now in your original position and your sights should be aligned on the bottom of the bull's-eye.

b. As you progress, the exercise will be conducted without counting. *Know what you are going to do; do not hurry.*

114. TAKING THE KNEELING POSITION FROM STANDING

Take the correct kneeling position and sight on the target. Mark the spot on the ground for your right knee. Rise to your feet, keeping your left foot and right toe in place. On command, or when the target appears, kneel forward over the right toe and down on the spot for your right knee. Place your left elbow forward of the left knee. With the heel of your hand on the butt plate, force the rifle butt in the pocket formed by the right shoulder (fig. 86①). Grasp the small of the stock with your right hand. Then shift the weight of your body forward onto your left leg and complete the position (fig. 86②).

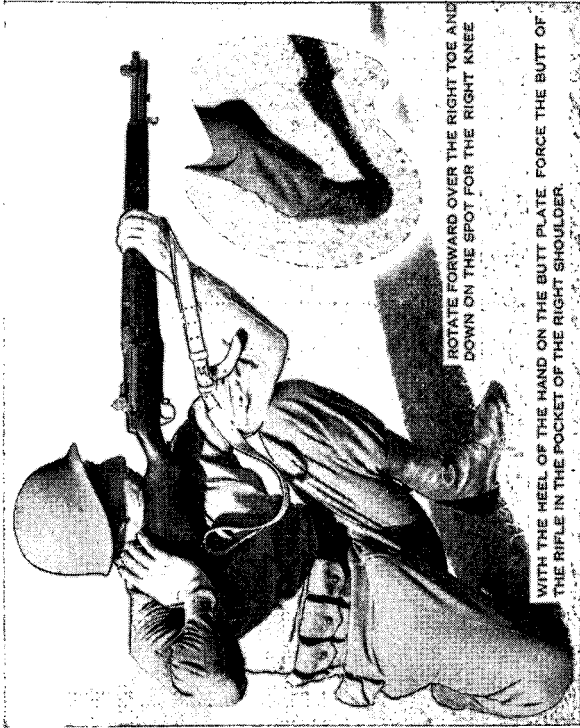

ROTATE FORWARD OVER THE RIGHT TOE AND
DOWN ON THE SPOT FOR THE RIGHT KNEE

WITH THE HEEL OF THE HAND ON THE BUTT PLATE. FORCE THE BUTT OF
THE RIFLE IN THE POCKET OF THE RIGHT SHOULDER.

①

Figure 86. Taking the kneeling position rapidly.



GRASP THE SMALL OF THE STOCK WITH THE RIGHT HAND. SHIFT THE WEIGHT FORWARD ONTO THE LEFT LEG AND COMPLETE THE AIM.

②

Figure 86—Continued.

115. TAKING THE SQUATTING POSITION FROM STANDING

Take the correct squatting position and aim at the target. Rise without moving your feet. On command, or when the target appears, squat into position. Place your left upper arm over your left knee. With the heel of your right hand on the butt plate, force the rifle butt into the pocket of your right shoulder. Grasp the rifle at the small of the stock with your right hand and lower your right arm to its position inside the right knee.

116. TAKING THE SITTING POSITION FROM STANDING

a. Take the correct sitting position and aim at the target. When you and your coach are satisfied with your position, rise to your feet, keeping them in place. On command, or when the target appears, sit down, breaking the fall with your right hand. As you sit down, skid your buttocks to the rear to get the correct height for your knees. Place your left arm in position. With the heel of your hand on the rifle butt, force the butt into the pocket of your right shoulder. Grasp the small of the stock with your right hand and lower your right arm to its position inside the right knee. Keep your eyes on the target while taking this position.

b. For those men who use the cross-legged or cross-ankled position, follow this method of taking the position rapidly:

- (1) *Cross-legged.* Rise and stand with the legs crossed. On command or when the

target appears, bend your knees and sink to the ground. Complete the position as described above.

- (2) *Cross-ankled.* Mark the spot for your heels, then bring your legs back into the cross-legged position. Rise and stand with the legs crossed. On command, or when the target appears, sink to the ground and move your feet out to the spots marked for them. Complete the position as described above.

c. These are important points in taking a position rapidly—

- (1) Take a correct position, close your eyes, and relax. When you open your eyes, your sights should still be aligned directly under the bull's-eye. If they are, you have a good position; if not, correct your position until you can do this.
- (2) When you rise, do *not* move the position of your feet. If you do, your line of aim will be changed and you will waste time in correcting it once you go down into position.

117. RELOADING EXERCISES

To fire effectively and to use the fire power of your rifle in combat and on the range, you must learn to reload your rifle quickly and smoothly in all positions. Reloading consists of reaching to a pocket of your cartridge belt, grasping a clip of dummy cartridges, loading this clip into your rifle,

and firing one round. Ten seconds is enough time to reload and fire one round. You will find that you can reload in much less time. However, do not rush.

a. Reloading in the Prone, Squatting, and Sitting Positions. To reload in these positions, place the rifle butt on the ground. Take a clip out of the cartridge belt and place it on the follower. Hold your right elbow high, extend the thumb on your right fist and place it on the right side of the clip and on the center of the top round, and push the clip into the receiver (fig. 87①). Remove your hand smartly to the right front. If the bolt does not close, strike the operating rod handle toward the muzzle, then, after completing the position, fire one round. In the sitting and squatting positions, you may place the butt of the rifle on your right thigh instead of on the ground (fig. 87②).

b. Reloading in the Kneeling Position. Place the rifle butt on your right thigh and reload in the same manner as for the other positions. Complete your position and fire one round.

c. Reloading in the Crouch Position. Place the rifle butt on top of your right leg. Reload in the same way as for the other positions. Another way is to drop to your right knee and place the rifle butt on the ground. Reload in the same way as for the other positions.

d. Commands. The following commands are used to teach reloading:

FIRER IN POSITION, AIM AT YOUR
TARGET



① Prone position.
Figure 87. Reloading.



② *Sitting position.*

Figure 87—Continued.

**BOLT OPEN
RELOADING EXERCISE
RELOAD
(Wait 10 seconds)
TIME**

118. SECOND SUSTAINED FIRE EXERCISE

a. This exercise combines the cadence exercise with taking positions rapidly, simulating reloading, and firing nine rounds in 50 seconds.

b. You will be allowed 10 seconds to take the correct position and fire the first round, 10 seconds to simulate reloading and firing the second round,

and 4 seconds for firing each remaining round. This totals 48 seconds. The remaining 2 seconds are a reserve in case you have to apply immediate action.

c. You know the cadence of 4 seconds per round, how to take a position rapidly, and how to reload. Now you are going to do all of these things in one exercise. Think of what you are going to do. Do not hurry or fumble. Concentrate on the sight picture, squeeze the trigger, count your shots, and breathe between each shot.

d. Place the M1 clip (fitted with the grooved wooden block) in the receiver and check your position. Rise, keeping your feet in place. Relax. On the preparatory field, the commands will be—

LOCK, ONE ROUND, SIMULATE LOAD
READY ON THE RIGHT?
READY ON THE LEFT?
READY ON THE FIRING LINE

(At this command, unlock your rifle with your right thumb)

TARGET UP (or COMMENCE FIRING)

At this command take the position rapidly, align your sights and fire the first round. Simulate reloading and fire your second shot. Then fire the remaining rounds at the 4-second cadence. After firing the last round, lock your rifle.

e. When the command, LOAD, is given, the coach steps back two paces. This tells the officer in charge that the man is ready for the exercise.

f. As soon as the man is in position, the coach moves forward and makes a quick check of the pupil's position; then the coach takes his own

position. The coach keeps the rifle cocked by striking the operating rod handle to the rear each time he hears the hammer fall. The coach constantly watches his pupil and corrects any faults in position, breathing, trigger squeeze, or other principles of good shooting.

g. For the first few times, the instructor keeps the group informed of the time by announcing FIRST SHOT RELOAD, SECOND SHOT, NINTH SHOT, and CEASE FIRING at the appropriate times.

119. THIRD SUSTAINED FIRE EXERCISE

a. After you have been trained in timing, taking positions rapidly, and simulating reloading, you are given additional practice in all of these points in the third sustained fire exercise. This exercise is the same as the second sustained fire exercise, except that you use a clip of dummy rounds instead of the clip with the wooden block.

b. Check the clip of dummy rounds for long rounds, then put this clip in the third pocket of your cartridge belt. Take your position and check it until you and the coach are satisfied. Rise, keeping your feet in place. At the command: LOCK, ONE ROUND, SIMULATE LOAD, lock your rifle and allow the bolt to close on an empty chamber. When READY ON THE FIRING LINE is given, unlock. At the command TARGETS UP or COMMENCE FIRING, take the position smoothly and rapidly and squeeze the trigger for the first shot. After the coach has checked your position and assumed his position, he will strike the operating

rod handle to the rear, and the bolt will stay open. Reach back and take the clip of dummy rounds from your belt. Load it into the receiver and fire your second shot. Continue to squeeze the trigger for each shot as the coach ejects the dummy round and cocks and loads for the next shot by striking the operating rod to the rear.

c. The rhythm of firing in a steady cadence helps you to fire sustained fire with accuracy. *Accuracy must not be sacrificed for speed.* Once in position, concentrate on the sight picture. Trigger squeeze should be automatic. Your position should be so steady that the sights automatically come to rest under the bull's-eye after each shot. Count each shot and breathe between each shot. When you can do these naturally, with little effort, you have learned this step.

120. ADJUSTING THE REAR SIGHT FOR WINDAGE AND ELEVATION

a. The movable rear sight (fig. 88) makes your rifle a precision instrument. You move the rear sight in the direction that you want to move the strike of the bullet. By adjusting this sight up or down, you can raise or lower the strike of the bullet on the target. If you move the sight *to the right*, you move the strike of the bullet *to the right*. If you move it *to the left*, the strike of the bullet will be *to the left*.

b. You move the sight up or down by turning the *elevation* knob; you move it to the right or left (deflection) by turning the *windage* knob.

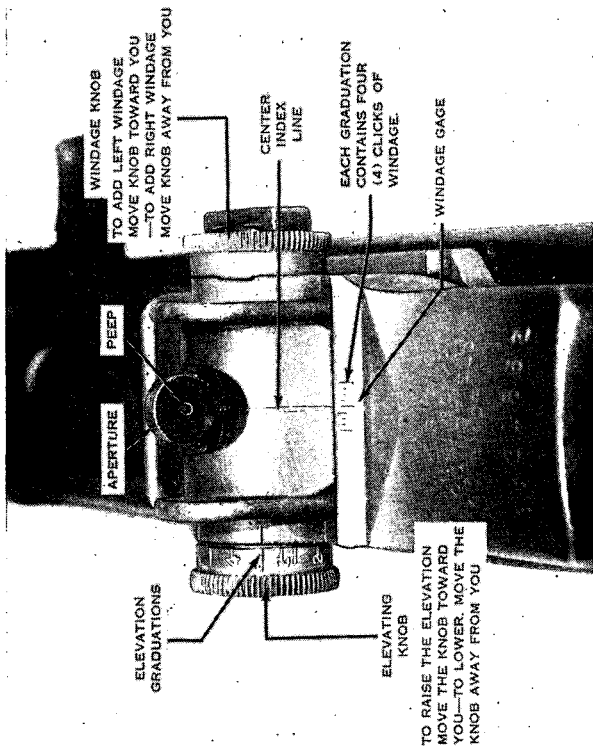
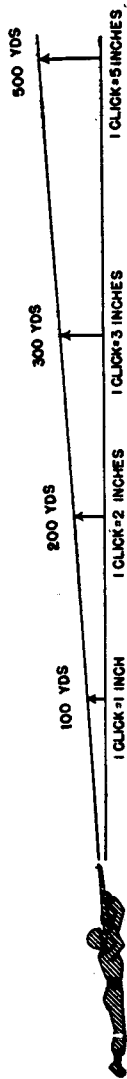

Figure 88. Directions for operating the rear sight.



ELEVATION RULE : _____

Figure 89. Elevation rule.

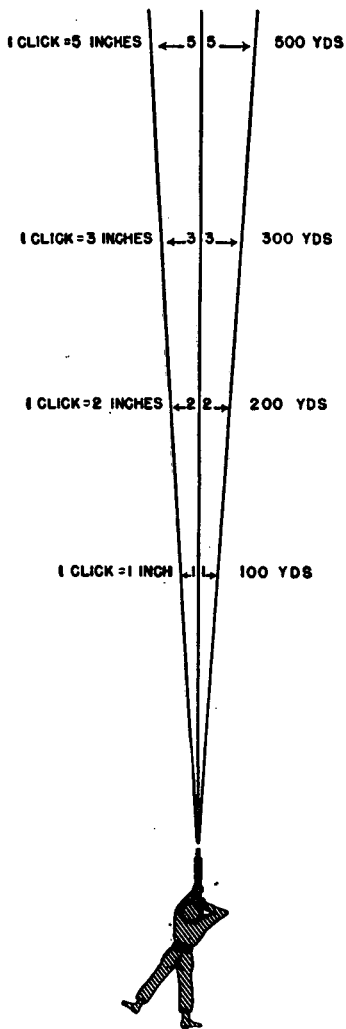

Figure 90. Deflection rule.

121. ELEVATION AND DEFLECTION RULE

a. General. As you move the sight up or down or right or left, you will notice that it clicks. Each click is a unit of measurement in the movement of the sight. There are no half clicks on the rear sight.

b. Rule. Turning the *elevation* knob one click up or down moves the strike of the bullet on the target approximately one inch up or down for each 100 yards (fig. 89). Turning the *windage* knob to the right or left (deflection) one click moves the strike of the bullet on the target approximately one inch to the right or left for each 100 yards (fig. 90).

122. USE OF THE ELEVATION AND DEFLECTION RULE

a. Before you can use the elevation and deflection rule, you will have to know two things—

- (1) The range to the target.
- (2) The number of inches on the target that you wish to move the next shot.

b. On the range you will know the distance to the target, but you will have to estimate the number of inches you wish to move the strike of the bullet. A knowledge of the dimensions of the target will help you estimate this distance. On the known distance ranges you will use the rifle A target (fig. 91) for slow fire at 100, 200, and 300 yards and for sustained fire at 200 and 300 yards. The rifle B target (fig. 92) is used at 500 yards. Study these targets and remember the number of

inches from the center of the bull's-eye to its outer edge and the width of the four ring and the three ring.

c. Knowing the dimensions of the A target, how many clicks will be needed to move the bullet from the bottom of the bull's-eye to the center of it at a range of 100 yards? 200 yards? 300 yards? In solving these problems, refer to figure 91. How many clicks would be needed to move the bullet from the bottom of the bull's-eye to the center if you were firing at the B target from 500 yards? In solving this problem, refer to figure 92.

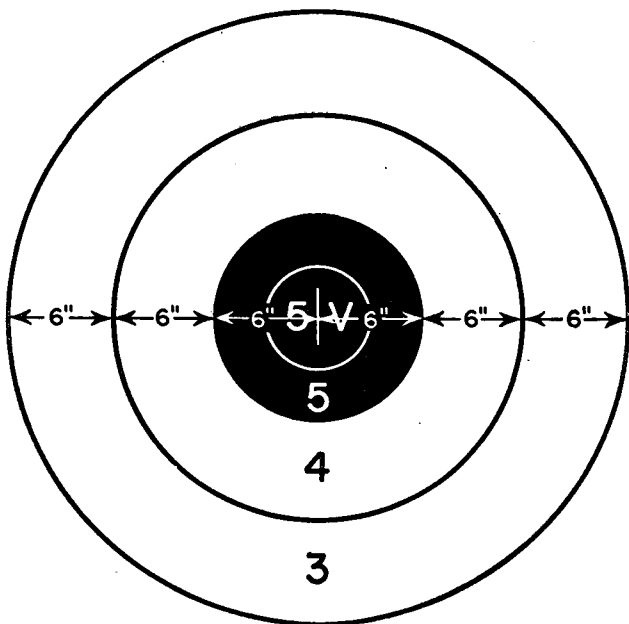

Figure 91. The A target.

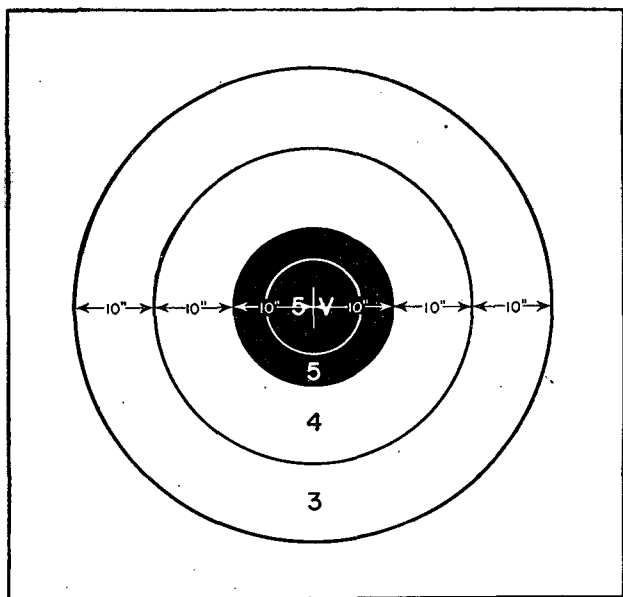

Figure 92. The B target.

123. HOW TO CALL SHOTS USING THE CLOCK SYSTEM

Visualize the target as the face of a clock.

- a. The top of the target is 12 o'clock.
- b. Directly to the right is 3 o'clock.
- c. The bottom of the target is 6 o'clock.
- d. Directly to the left is 9 o'clock.
- e. Other points on the target are called in their relation to the numbers on the face of the clock.

124. SIGHT ADJUSTMENT PROBLEM NO. 1

a. At 200 yards, the shots shown in figure 93 have been called and marked as indicated. How many clicks and in what direction would you move the rear sight?

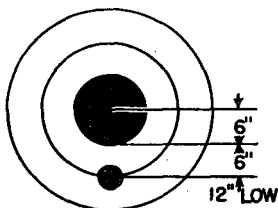

A 4 AT 6 O'CLOCK

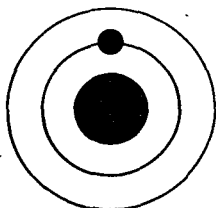

A 4 AT 12 O'CLOCK

THIS SHOT IS 12" LOW. AT 200 YARDS ONE CLICK WILL MOVE THE STRIKE OF THE BULLET 2".

TO MOVE IT 12" YOU MUST MOVE THE ELEVATION UP 6 CLICKS.

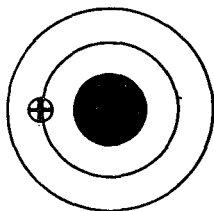

A 3 AT 9 O'CLOCK

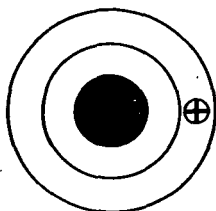

A 3 AT 3 O'CLOCK

Figure 93. Shots called as indicated.

b. The rear sight may have to be moved both for elevation and windage (called deflection) to get the next shot in the center of the bull's-eye. To do this, determine the elevation change first and put this on the rear sight. Then determine

the windage change and put this on the rear sight. With the same sight picture, your next shot should be in the center of the bull's-eye.

125. SIGHT ADJUSTMENT PROBLEM NO. 2

At 200 yards the shots shown in figure 94 have been called and marked. How many clicks of elevation and windage is necessary to move the next shot into the center of the bull's-eye?

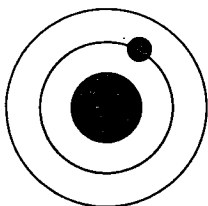

**A 4 AT 10 O'CLOCK
THIS SHOT IS 10" HIGH AND
6" RIGHT OF THE CENTER OF
THE BULL'S EYE . CORRECT
SIGHT CHANGE IS DOWN 5
CLICKS AND LEFT 3 CLICKS**

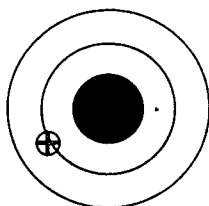

A 3 AT 8 O'CLOCK

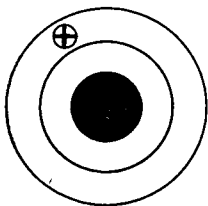

A 3 AT 11 O'CLOCK

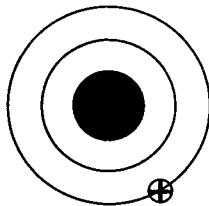

A 3 AT 5 O'CLOCK

Figure 94. Shots called as indicated.

126. DIRECTION OF THE WIND

(fig. 95)

a. In firing at 500 yards or under, the wind is the only weather condition that affects the flight of the bullet. The effect of the wind on the bullet must be carefully studied. To describe the direction of the wind, we again use the clock system.

b. Visualize yourself facing the target and standing in the center of the face of a clock that is lying flat on the ground with the number twelve toward the target.

- (1) A wind blowing directly into your face is called a 12 o'clock wind.
- (2) A wind blowing directly from the rear is a 6 o'clock wind.
- (3) A wind blowing directly from the right is a 3 o'clock wind.
- (4) A wind blowing directly from the left is a 9 o'clock wind.
- (5) Winds blowing from other directions are called by the hour on the face of the imaginary clock. Examples are a 1 o'clock wind, a 5 o'clock wind, or an 11 o'clock wind.

127. SPEED OF THE WIND

Having determined the wind's direction, you must also know the wind's speed, which is measured in miles per hour. Wind speed can be estimated by either of two methods.

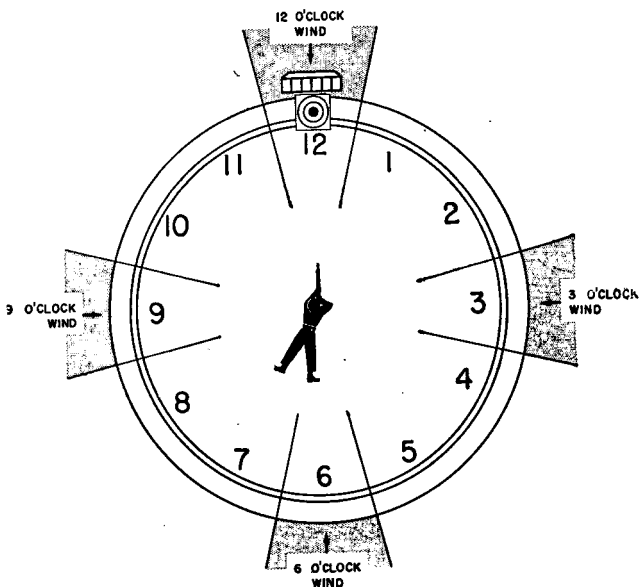

Figure 95. The direction of the wind.

a. *First Method.* When you are on the range, you can observe the range streamer. When a wind is blowing, the range streamer will be flying out from its staff, forming an angle. Estimate the angle in degrees between the staff and the streamer. Divide this angle by 4. The result is the approximate speed of the wind in miles per hour.

b. *Second Method.* In field firing or when you are in combat, use dry grass, dust, light fuzz, or bits of paper. Hold any of these at shoulder height, but do not block the wind with your shoulder. Drop whatever you are using to test the

wind. Extend your arm and point to the spot on the ground where it landed. Your arm now forms an angle with your body. Estimate this angle in degrees and divide by 4. The result is the speed of the wind in miles per hour.

128. WIND SPEED EXAMPLES

a. The wind is blowing the streamer out at an angle of 40° :

Angle is 40° .

$$40 \div 4 = 10 \text{ miles per hour.}$$

b. The wind is blowing the streamer out at an angle of 80° :

Angle is 80° .

$$80 \div 4 = 20 \text{ miles per hour.}$$

c. The wind has blown some grass out at an angle of 60° degrees from your body:

Angle is 60° .

$$60 \div 4 = 15 \text{ miles per hour.}$$

129. EFFECT OF WIND ON BULLET

(fig. 96)

a. When a cross-range wind is blowing, the force of the wind acts against the bullet. From the time the bullet leaves the muzzle, the wind will force it off of its intended path according to the strength of the wind and the direction from which it is blowing. If you do nothing to compensate for the wind, the bullet will not strike the target where you intend it to.

b. There are three values in computing the wind. These are—

- (1) *Full value winds.* Winds blowing from 2, 3, and 4 o'clock and 8, 9, and 10 o'clock

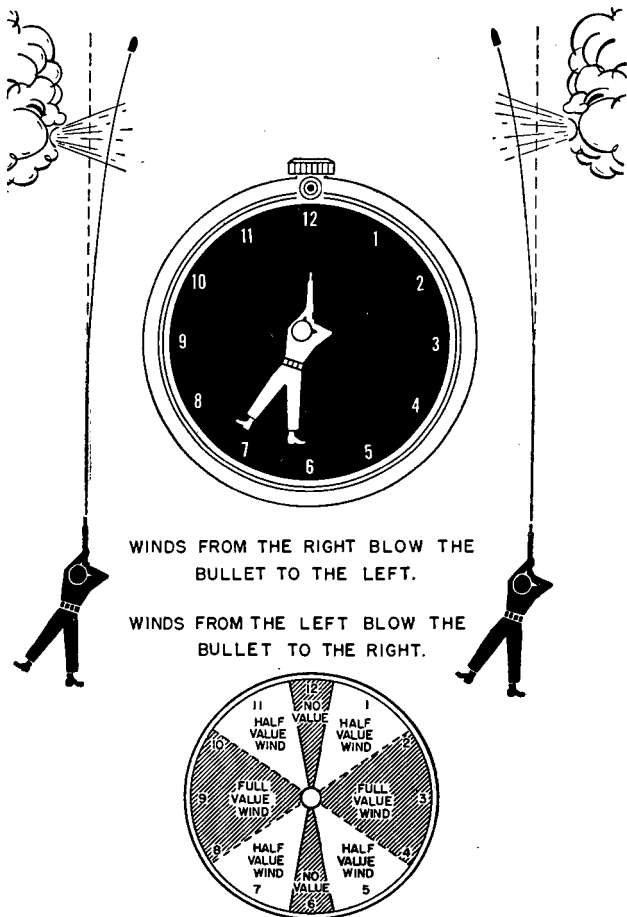

Figure 96. The wind changes the flight of the bullet.

have the maximum effect on the bullet's flight. These are full value winds.

- (2) *Half value winds.* Winds blowing from 1, 5, 7, and 11 o'clock are blowing from an angle and have about half the effect on the bullet's flight as a full value wind. These are half value winds.
- (3) *No value winds.* Winds blowing from the target (12 o'clock) and winds blowing from the rear, toward the target (from 6 o'clock), have no effect on the bullet's flight at the ranges you will be firing.

130. WIND RULE

a. After you determine the speed and direction of the wind, use the wind formula to find the number of clicks to move your rear sight. This formula is—

$$\frac{R \times V}{10} = \text{the number of clicks for a full value wind.}$$

b. To use this rule, proceed as follows:

- (1) R is the range that you are firing—100, 200, 300, or 500 yards; and express this as 1, 2, 3, or 5.
- (2) V is the velocity of the wind in *miles per hour*.
- (3) Multiply the range and the wind velocity factors.
- (4) Divide by 10.
- (5) The result is the *number of clicks for a full value wind*.

- (6) For a half value wind, use half of the result of this formula. No adjustment is needed for winds that have no value.

131. WIND FORMULA EXAMPLES

- a. Range is 200 yards—show as 2
Speed of wind is 15 mph.
Divide by 10 $\frac{2 \times 15 = 30}{10} = \frac{30}{10}$ or
3 clicks for a *full value*
wind.
- b. Range is 500 yards—show as 5
Speed of wind is 15 mph.
Divide by 10 $\frac{5 \times 15 = 75}{10} = \frac{75}{10}$ or $7\frac{1}{2}$ clicks
for a *full value* *wind*.

Note. Since we cannot put half clicks on the rear sight, any sight adjustment that has a fraction of a click is expressed at the next higher number— $7\frac{1}{2}$ will be 8; $1\frac{1}{2}$ will be 2; $5\frac{1}{2}$ will be 6.

132. LIGHT

a. Bright, hazy, or dull daylight does not affect the flight of the bullet, but it does affect your aim. Changes in light have very slight effect on the aim of most riflemen and corrections for the effects of light will not exceed one click in any direction at any range. Changes in light do not always affect everyone to the same degree.

b. Most men unconsciously aim a little lower in a poor light than in a good light. Because of this, more elevation is needed when the light is

poor. The aim is lowered because the outline of the bull's-eye is not clear and sharp in a poor light. As a rule, poor light exists on dark days when there is a haze in the air, and on very bright hot days when heat waves rise from the ground, distorting the line of sight. The best conditions for shooting prevail when the sky is uniformly overcast and there is enough light to see the target clearly.

c. Sunlight from the side affects a man's aim because the sunny side of the front sight is more clearly defined and is unconsciously held toward the center of the bull's-eye. The adjustment for this will rarely exceed one click. In making this adjustment, change the windage setting toward the sun.

133. ZEROING YOUR RIFLE

a. Each rifle has certain characteristics such as firing a little low, a little high, or to the left or right, and many others. You must know these characteristics. Once you do, it is easy to move the rear sight to correct for them.

b. Correcting for these characteristics of your rifle by adjusting the rear sight is called *zeroing your rifle*. When your rifle was manufactured, the rear sight was made so that you could raise the elevation 72 clicks from the bottom. For deflection, a center index line was placed on the rear sight base and a windage gage was placed on the receiver. The center index line can be moved 16 clicks to the left and 16 clicks to the right of the center of the gage. To zero your

rifle, you must adjust the elevation and deflection until your rifle shoots where it is aimed. The *zero* sight settings of your rifle for various ranges should become a part of a team, *you and the rifle*.

c. What is meant by the *zero* of your rifle? *The zero of your rifle, for each range, is the sight setting in elevation and deflection that will enable you to hit the center of the bull's-eye on a day when no wind is blowing.*

d. There are two ways to zero your rifle on a day *when no wind is blowing*—

- (1) The first way is to fire three or more shots with the same sight setting and the same aiming point. These shots will form a group on the target. Make a sight change on your rear sight to move the center of this group into the center of the bull's-eye. Fire another group and, if necessary, make a sight change to move the center of this group into the center of the bull's eye. The next group should be in the center of the bull's-eye. The sight setting that you now have on your rear sight is the zero of your rifle at that range, for any day *when no wind is blowing*.
- (2) The second way is to fire a single shot. Make the necessary sight change to move the next shot into the center of the bull's-eye. Fire another round. Continue this until your shots are hitting in the center of the bull's-eye. The final sight setting that you have on the rear

sight is the zero of your rifle for that range, for any day *when no wind is blowing*. The second method is not always the better; but after you know how to call your shots and know that you call them correctly, you may use this method. For men who are just beginning to shoot, the first method is better.

RIFLE SCORE CARD

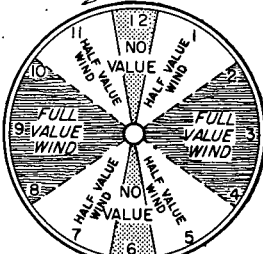
NAME: <i>JOHN R. DOE</i>		GRADE: <i>CPL</i>																		
ASN: <i>8955796</i>		ORGN: <i>Co. A, 24th INF</i>																		
DATE: <i>1-16-51</i>		PLACE: <i>FT. BENNING, GEORGIA</i>																		
COURSE: <i>A COURSE</i>		INSTR OR RECORD																		
RANGE	SCORE	<p>ONE (1) CLICK OF ELEVATION OR WIND-AGE MOVES THE STRIKE OF THE BULLET ONE (1) INCH ON THE TARGET PER ONE HUNDRED YARDS OF RANGE.</p>  <p style="text-align: center;">$\frac{RV}{10} =$ NUMBER OF CLICKS FOR A FULL VALUE WIND. FOR A HALF VALUE WIND USE ONE HALF OF THE RESULTS</p> <p style="text-align: center;"><i>CUT OUT</i></p>																		
KDF TOTAL																				
TABLE TOTAL																				
TABLE TOTAL																				
GRAND TOTAL																				
QUALIFICATION																				
CERTIFIED CORRECT																				
SIGNATURE OF SCORER _____																				
SIGNATURE OF OFFICER _____																				
ZERO RECORD CARD																				
CUT-OUT AND SHELLAC IN THE TRIGGER HOUSING FLOOR PLATE																				
		<table border="1" style="width: 100%; border-collapse: collapse;"> <tr> <td colspan="3">RIFLE NO. <i>762389</i></td> </tr> <tr> <td colspan="3" style="text-align: center;">ZERO</td> </tr> <tr> <td style="width: 30%;">RANGE</td> <td style="width: 30%;">ELEVATION</td> <td style="width: 40%;">WIND</td> </tr> <tr> <td>200</td> <td style="text-align: center;"><i>15</i></td> <td style="text-align: center;"><i>2R</i></td> </tr> <tr> <td>300</td> <td> </td> <td> </td> </tr> <tr> <td>500</td> <td> </td> <td> </td> </tr> </table>	RIFLE NO. <i>762389</i>			ZERO			RANGE	ELEVATION	WIND	200	<i>15</i>	<i>2R</i>	300			500		
RIFLE NO. <i>762389</i>																				
ZERO																				
RANGE	ELEVATION	WIND																		
200	<i>15</i>	<i>2R</i>																		
300																				
500																				

①

Figure 97. The rifle score card. (DA AGO Form 83).

b. Each man must keep a score card on which he records not only the value of the hits but the location of each hit, the sight setting and sight changes, the force and direction of the wind, the light, the hour, the date, and any other data that may be of use in the future. Space for these entries is provided on the score card.

c. The score card is important on the range because—

- (1) It is a permanent record of your range firing.
- (2) It shows the adjustments on the rear sight that are necessary to hit the center of the bull's-eye.
- (3) A comparison of the call column and the corresponding shots plotted on the miniature target show whether you have the correct sight setting and whether you are aiming, squeezing the trigger, following through, and calling the shot correctly.

135. ZERO RECORD CARD

Your ZERO sight setting for 200, 300, and 500 yards is recorded on the ZERO RECORD CARD, which is cut off the score card and shel-lacked to the inside of the trigger housing floor plate.

136. USE OF THE SCORE CARD

a. When you arrive on the range, you will be given time to fill out the heading of your score

card. Make this and later entries as shown in figure 97①.

b. Assume that you are firing from 200 yards with an M1 rifle that has just been issued to you. You will fire first to determine the zero of the rifle at 200 yards. To do this, you will fire three groups of three rounds each. On the command of the officer in charge of the firing line, the target will be pulled and marked after the third shot of each group.

c. On reaching the firing point—

- (1) Take the correct position and place your score card and pencil where you can easily use them without moving from your position.
- (2) Check the weather conditions, particularly the wind, and record it on the score card along with the hour, date, and range.
- (3) Using the first scoring space, strike out the range not being used and the elevation and windage lines for that range as shown in figure 97②.
- (4) As you have never fired this particular rifle, you first set the elevation at 12 clicks (average elevation for 200 yards) and record this figure in the elevation column.
- (5) Assume that you estimate the wind to be 10 miles per hour from 3 o'clock. Using the wind formula, you find that the wind is worth 2 clicks of right windage.

Set your sights accordingly and in the WIND column you record the wind as 2R.

(6) Under remarks write *zeroing* and *prone* position.

d. On command, load your rifle and get ready for the first shot.

e. After the command COMMENCE FIRING, hold your breath, align your sights, and squeeze the trigger in such a way that you do not know exactly when the rifle will fire. Then, at the moment of firing, you are able to *call* your shot correctly.

f. In this case, suppose you call the first shot a *center bull's-eye*. You then put a dot in the center of the circle in the *call* column. Suppose you fire the second shot and call it a center bull's-eye. You again place a dot in the call column just as you did for the first shot. You fire the third shot, calling it a center bull's-eye and again enter a dot in the call column. Lock your rifle and wait for your target to be marked. When the target is marked and disked, you see three spotters very close together at about 8 o'clock. The disk shows that you have three fours. Looking at your target and noting the exact location of the three spotters, you plot the shots on the recording target of the score card. You number each shot with a small figure 1, 2, or 3. Do not fool yourself by plotting the shots out of place, because you are going to make a sight change using this group as you have it plotted.

g. Now determine how far you have to move the center of the group for it to be in the center of the bull's-eye. By using the target dimensions or the elevation and windage lines on the recording target for 200 yards, you determine that you have to add 2 clicks of elevation and 3 clicks of right windage. Enter this on the score card. Under elevation you enter 14 and under wind you enter 5R. Number the spaces for the next three shots as 4, 5, and 6. During the time you were making these sight changes, the target was pulled, pasted, and run back up.

h. On command, load and begin to fire your second group. Suppose you call the fourth shot a center bull's-eye and place a dot in the center of the circle in the call column. You call the fifth shot a high four at 12 o'clock. You indicate this by placing a dot outside the circle in the call column where you think the shot hit. You call the sixth shot a center bull's-eye and plot it. Again the target is pulled, marked, run up, and disked. The three shots of the second group are disked as two fives and a four at 12 o'clock. You plot these on the recording target. The fifth shot was high, as you called it, so the center of the second shot group is determined by the fourth and sixth shots. You also enter "called" in the remark column for the fifth shot.

i. By using the target dimensions or the elevation and windage lines (for 200 yards) on the recording target, you find that it is necessary to make another sight change to place the next three shots in the center of the bull's-eye. You find

that you should add 1 click of elevation, so you enter it in the elevation column, making a total of 15 clicks of elevation. For windage you find that you can take one click of right windage off the rear sight. You record this in the wind column, making a total of four clicks right windage.

j. The target has been pulled, pasted, and run up. On command, you begin to fire the third group. Suppose you flinch on the seventh shot. Because you cannot call the shot, you enter a question mark in the call column and write *flinched* under remarks. You squeeze the trigger correctly for the eighth and ninth shots, call both of them center bull's-eyes, and enter them in the call column. After firing the third shot, lock your rifle. The target is marked and disked as two fives in the center of the bull's-eye and a miss. You plot the two shots and, since you flinched on the seventh shot and could not call it, your seventh shot was the miss. The two fives are then numbered as 8 and 9. After entering the values, total the score and enter it in the space provided.

k. You find that the sight setting which was necessary to hit in the center of the bull's-eye was 15 clicks of elevation and 4 clicks of right windage. You know that the wind was worth 2 clicks of right windage before you began to fire. To get the zero of the rifle, you have to take off the 2 clicks of right windage (subtract it) from the windage setting that you have on the rifle. As you have 4 clicks of right windage on the rear sight, take off the 2 clicks that you originally put on. The remaining 2 clicks of right windage is

the zero windage of your rifle. The zero of your rifle at 200 yards is 15 clicks of elevation and 2 clicks of right windage. Record this in the space provided on the score card. On the zero record card, you enter the 200-yard zero in the space provided, along with your rifle number.

l. Keeping your score card is important because it is a record of your firing. Record everything that you think is necessary to help you remember each shot. Do not let the coach make an entry on *your* score card. Keep it clean and make all entries small and neat.

m. Information collected on the 1,000-inch range is recorded in the same way as that on the 200-yard range. The only exception is that one click of elevation or windage moves the strike of the bullet on the target a quarter of an inch instead of 1 inch.

137. EXAMINATION BEFORE RANGE FIRING

a. An examination is the last step of preparatory marksmanship training. During this step you will be examined in all the previous steps to make sure that you are qualified to fire live ammunition on the range. The examination does not require much time. A chart of your progress is kept during training (par. 76).

b. The examination should be held far enough in advance of range firing to permit additional instruction to be given to those men who make an unsatisfactory showing in any phase of training.

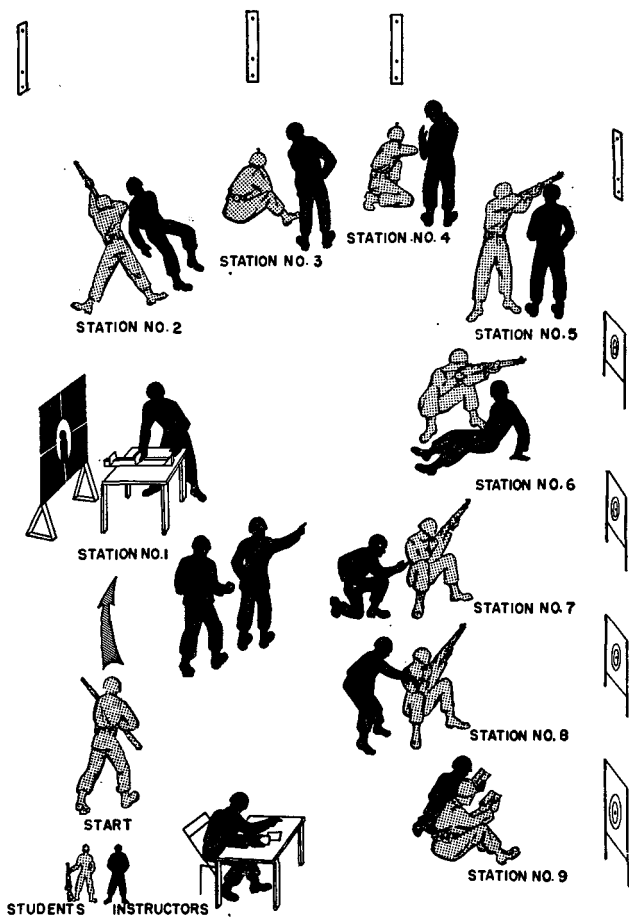

Figure 98. A layout for a county fair method of examination.

c. There are several methods by which you may be examined to see if you are prepared for range firing:

- (1) A written test, an oral test, or a practical work examination using the county fair method may be given (fig. 98).
- (2) The county fair method is the most efficient way to conduct the examination.

d. During these tests, the examiners take the names of the men who need extra instruction. These names are turned over to the instructor in charge who arranges for additional training.

138. QUESTIONS ON PREPARATORY MARKSMANSHIP TRAINING

The following questions cover the important points of preparatory marksmanship training. Study them; know how to answer each one in your own words. When you are in doubt about any point, ask your instructor or leader to explain it.

a. Care and Cleaning.

Q. What four things do you do in cleaning a rifle bore after it has been fired?

A. First, remove the powder fouling from the bore. Second, dry the bore thoroughly of the liquid used to remove the fouling. Third, inspect the bore, repeating the cleaning if necessary. Fourth, oil the bore.

Q. How do you remove the powder fouling from the bore?

A. By swabbing it thoroughly with patches saturated with bore cleaner. In the absence of bore cleaner, use warm soapy water.

Q. How do you dry the bore?

A. By running clean patches through the bore until it is thoroughly dry.

Q. How do you protect the bore from rust?

A. By swabbing it thoroughly with a cleaning patch saturated with special preservative lubricating oil issued for this purpose.

b. Sighting and Aiming.

Q. What is meant by sight alinement?

A. The proper positioning of the front sight post in relation to the peep of the rear sight.

Q. Explain correct sight alinement.

A. You have correct sight alinement when the top of the front sight blade touches an imaginary horizontal line through the center of the peep sight and when an imaginary vertical line through the center of the peep sight divides the front sight in half.

Q. How do you obtain the correct sight picture?

A. Add the bull's-eye to the correct sight alinement so that the bottom of the bull's-eye just touches the center of the top of the front sight.

Q. What is the purpose of the sighting and aiming bar?

A. To teach the rifleman how to aim.

Q. Why is it better than a rifle for this purpose?

A. Because the sights on it are much larger and slight errors can be more easily seen and pointed out.

Q. What does this represent? (The instructor points to the front sight.)

A. The front sight.

Q. And this? (The instructor points to the rear sight.)

A. The rear sight.

Q. What is this? (The instructor points to the eyepiece.)

A. The eyepiece.

Q. What is the eyepiece for?

A. To cause me to place my eye in such a position as to see the sights in the same alinement as that seen by the coach.

Q. Is there an eyepiece on the rifle?

A. No, I learn with the sighting bar how the sights look when properly aligned, and I must hold my head so that I see the sights the same way when aiming a rifle.

Q. How do you hold your head steadily in this position when aiming a rifle?

A. By resting my cheek firmly against the side of the stock and on top of my right thumb.

Q. Where do you focus your eye when aiming a rifle?

A. First I focus on the target, but the last focus of my eye will be on top of the front sight to be sure that I see the front sight sharply defined and properly centered in the rear sight.

Q. Tell me what is wrong with these sights. (The instructor now adjusts the sights of the bar, making various slight errors. He requires the men to point out these errors.)

Q. Now take this sighting bar and adjust the sights properly. (The instructor verifies all adjustments.)

Q. Now that the sights are properly adjusted, move the small bull's-eye until the sights are properly aimed. (The instructor verifies all sight pictures.)

Q. How do you hold your breath while aiming?

A. I draw in an ordinary breath, let out a little of it, and hold the rest by closing my throat. I do not tighten the muscles of my stomach. I hold this breath all the time that I am squeezing the trigger. During sustained fire, I *breathe* after each shot.

c. Positions.

Q. Take the prone position, aim, and simulate firing a shot at that mark. (The instructor points to a target and checks to assure himself that the man knows how to hold his breath properly while aiming. Many men have great difficulty in learning to do this correctly.)

Q. Take this rifle and demonstrate the standing, kneeling, squatting, sitting, and prone positions.

A. You demonstrate these positions.

Q. Now show me how you take the prone, kneeling, squatting, and sitting positions rapidly.

A. You demonstrate these positions.

d. Trigger Squeeze.

Q. How do you squeeze the trigger?

A. I take up the slack with a heavy initial pressure. Then I squeeze the trigger with such a

steady increase of pressure that I do not know exactly when the rifle will fire.

Q. On what do you concentrate while you are squeezing the trigger?

A. I concentrate on keeping a perfect sight alinement.

Q. Is it necessary to take a long time to press the trigger in this way?

A. No, the method of squeezing the trigger is slow at first, but speed is developed by practice.

Q. How do you squeeze the trigger in sustained fire?

A. I squeeze it the same way as in slow fire, with such a steady increase of pressure that I do not know when the rifle will fire.

e. Sustained Fire.

Q. How do you fire sustained fire within the time limit so that you are not compelled to hurry in aiming and squeezing the trigger?

A. By taking the position rapidly, and by reloading smoothly.

Q. Demonstrate how you load a clip of ammunition into the receiver.

A. After placing a full clip on the follower, I ball my right hand into a fist with the thumb extended. With the elbow held high and the thumb on the right side of the clip and on the center of the top round, I push the clip down into the receiver.

Q. In sustained fire, is it important to get into the correct position before beginning to fire?

A. Yes, even though it takes more time, I should always get into the correct position before beginning to fire.

Q. Which is more important in sustained fire, speed or accuracy? Explain.

A. Accuracy. A few accurate shots are better than many scattered ones.

f. *Calling the Shot.*

Q. What is meant by *calling the shot*?

A. To tell where you think the bullet hit the target as soon as you shoot and before the shot is marked.

Q. How can you do this?

A. By following through and by knowing exactly where the sights are pointed when the rifle fires.

Q. If a man cannot call his shot properly, what does it usually indicate?

A. That he did not squeeze the trigger properly and did not know where the sights pointed at the time the rifle was fired.

Section III. COURSES

139. GENERAL

a. Each officer, warrant officer, and enlisted man in the army is authorized to fire a qualification course with his basic weapon and a familiarization course with another weapon. See AR 775-10. With the M1 rifle, there are five rifle qualification courses. This variety of qualification courses is provided to fit the needs of various branches of the Army, some of which devote more time to marksmanship than others, and to give a choice to those posts and camps where the size and number of ranges are limited. No matter where you are stationed, or what unit you are assigned to,

there will always be a qualification course for you to fire.

b. The amount of instruction firing is not limited to that prescribed in the following tables. Such additional practice as time and ammunition allowance permit may be given. No rifleman will be permitted to fire sustained fire until he has demonstrated his ability in slow fire.

c. Although the 1,000-inch range does not appear in the tables for the standard or A, B, and C courses, it can be used to great advantage for instruction firing. When time or personnel for pit details is limited, the 1,000-inch range should be used for the initial phase of instruction firing. At this range, you become accustomed to the noise and recoil of the rifle as you perfect your positions, and the necessity for correct trigger squeeze is made obvious. The use of dummy rounds during 1,000-inch firing is desirable. They can be used to teach trigger squeeze and to detect and correct flinching. Having zeroed your rifle at 1,000 inches, you can use this zero as a basis for zeroing your rifle at the longer ranges. Many men find no difference between the 1,000-inch zero and the 200-yard zero. In short, the rifleman can learn all basic elements of marksmanship by firing on the 1,000-inch range. Pit details and telephone operators are eliminated and, because each hit is visible, the time usually spent in target operation is used for firing practice.

d. You should be given the opportunity to zero your rifle with the bayonet and the grenade launcher attached, preferably at 300 yards. This

firing should be conducted after known distance record firing, but before transition firing. (Note to instructor—conduct this training before firing table VI.)

e. Before range practice, organization commanders should make sure that the qualifying scores agree with the latest published regulations. Pencil changes should be made in all published material that does not agree with the newest regulations.

140. STANDARD COURSE

a. *General.* The standard course is prescribed in eight tables. This course is designed to teach you how to shoot the rifle and how to use the battle sight (zero of the rifle at 300 yards (par. 173)) in firing at field targets at different ranges. When you complete the standard course, you are qualified to advance to the team phase. The standard course includes known distance firing and transition firing.

b. *Known Distance Firing.* The known distance part of the standard course is prescribed in five tables. Tables I, II, and III are fired at least once during instruction for practice. Tables IV and V are fired once for record. During known distance firing you will use the sling. All the principles of rifle marksmanship as taught during preparatory training are applied during the firing.

c. *Transition Firing.* Transition firing, prescribed in tables VI, VII, and VIII, includes firing at field targets from combat type positions as well as firing from the crouch position at surprise

targets from very short ranges. It is preceded by preliminary marksmanship training in the theory and use of the battle sight at ranges up to 400 yards. Instruction is also given in the use of an aiming point (par. 208) and in range estimation (pars. 214–217). While firing table IV, you become familiar with the appearance of targets and the distance to them at various ranges. When firing table VII, the sling should be used in firing from all positions wherever possible (par. 323). You are not permitted to fire tables VII and VIII until after you have demonstrated your ability in firing table VI. Tables VI, VII, and VIII are fired at least once during instruction for practice; then tables VII and VIII are fired once for record.

d. Qualification Scores. The total of your record firing scores for Tables IV, V, VII and VIII determines your classification as a rifleman. The minimum standard course qualifying scores for the three classifications are—

- (1) Expert rifleman450 points
- (2) Sharpshooter360 points
- (3) Marksman300 points

Table I. Standard Course, Instruction Firing, Known Distance Slow Fire

Range (yards)	Time	Rounds	Position	Target	Sling
100	No limit---	*9	Prone-----	A	Loop.
200	---do---	*9	---do---	A	Do.
300	---do---	*9	---do---	A	Do.
500	---do---	*9	---do---	B	Do.

*The rifle is zeroed in 3-round groups.

Table II. Standard Course, Instruction Firing, Known Distance Slow Fire

Range (yards)	Time	Rounds	Position	Target	Sling
100	No limit	*8	Standing----	A	Hasty.
200	----do----	*8	Squatting or sitting.**	A	Loop.
200	----do----	*8	Kneeling or sitting.**	A	Do.
300	----do----	*8	Prone-----	A	Do.
500	----do----	*8	Prone-----	B	Do.

*Four rounds may be fired under reduced ammunition allowance.

**The sitting position may be substituted for either the kneeling or squatting position but not for both.

*Table III. Standard Course, Instruction Firing, Known Distance Sustained Fire**

Range (yards)	Time (seconds)	Rounds	Position	Target	Sling
200	50	9	Kneeling or squatting from standing.**	A	Loop.
200	50	9	Sitting or squatting from standing.**	A	Do.
300	50	9	Prone from standing.	A	Do.
300	50	9	----do-----	A	Do.

*Sustained fire begins with 1 round in the chamber and a loaded clip in the third pocket of the cartridge belt.

**The sitting position may be substituted for either the kneeling or squatting position but not for both.

*Table IV. Standard Course, Record Firing, Known Distance Slow Fire**

Range (yards)	Time (minutes)	Rounds	Position	Target	Sling
100	10	8	Standing-----	A	Hasty.
200	10	8	Kneeling or sitting.**	A	Loop.
200	10	8	Squatting or sitting.**	A	Do.
300	10	8	Prone-----	A	Do.
500	12	10	---do-----	B	Do.

*A time limit in slow fire depends on efficient target service which should average 20 seconds per round for pasting and marking. In case of a breakdown or slow service, the firer is allowed extra time.

**The sitting position may be substituted for either the kneeling or squatting position, but not for both.

*Table V. Standard Course, Record Firing, Known Distance Sustained Fire**

Range (yards)	Time (seconds)	Rounds	Position	Target	Sling
200	50	9	Squatting, sitting, or kneeling from standing.	A	Loop.
300	50	9	Prone from standing.	A	Do.

*Sustained fire begins with 1 round in the chamber and a loaded clip in the third pocket of the cartridge belt.

Table VI. Standard Course, Preliminary Instruction for Transition Firing

Range (yards)	Time	Rounds	Position	Target*	Sling
300	No limit	6	Prone	Silhouette No. 1.	Hasty
300	do	8	do	Silhouette No. 2.	Do.
200	do	3	do	Silhouette No. 1.	Do.
200	do	5	do	Silhouette No. 2.	Do.
400	do	6	do	Silhouette No. 1.	Do.
400	do	8	do	Silhouette No. 2.	Do.

*For target arrangement, see figure 122. Three-round shot groups will be fired on silhouette No. 1; one 3-round shot group will be fired on silhouette No. 2; thereafter, the target will be pulled and marked after each shot. No scoring is required for this table.

Table VII. Standard Course, Instruction and Record Firing, Transition Firing (fig. 123)

Lane	Range (yards)	Time (seconds)	Rounds	Target	Position
1	150-300	60	4	E	Standing fox-hole.
2	200-400	60	4	E	Rubble pile.
3	300-400	60	4	E	Stump.
4	200-325	60	4	E	Window.
5	150-250	60	*4	E	Prone.
6	500	60	4	B	Do.
7	125-400	60	4	E	Barricade.
8	250-350	60	4	E	Ditch.
9	175-325	60	4	E	Roof top.
10	125-275	60	4	E	Log.

*Eight rounds when firing for instruction firing.

Scoring notes—

1. Lanes 1, 2, 3, 4, 5, 7, 8, 9, and 10.

For each hit 5 points

For each unexpended round if both targets are hit 5 points

Possible points for each lane..... 20 points

2. Lane 6.

For each hit 5 points

Possible points for this lane..... 20 points

Total possible points for course..... 200 points

3. Ricochet hits are scored.

*Table VIII. Standard Course, Instruction and Record
Firing, Quick Fire (fig. 124)*

Phase line	Range (yards)	Time (seconds)	Rounds*	Target	Position
First-----	15-35	3	8	1 E	Shoulder or hip.
		3		1 E	
		4		2 E	
		3		2 E	
Second---	15-35	4	8	2 E	Do.
		5		2 E	
		5		3 E	
Third-----	15-45	4	8	2 E	Do.
		5		3 E	
		4		2 E	

*Each firer is issued 24 rounds for the 20 silhouette targets. The four extra rounds are to be used where necessary by the firer.

Scoring notes—

1. For each silhouette hit (ricochets are scored as hits)
2. For each unexpended round if all targets are hit..... 5 points
3. Total possible for course..... 120 points

141. COURSE A

a. General. Course A is prescribed in five tables and is fired when the range facilities required for the standard course are not available. The instruction firing outlined in tables I, II and III is designed to serve as a guide only. With reduced ammunition allowances, the number of shots shown in parentheses may be fired.

b. Qualification Scores. The total of your record firing scores for tables IV and V determines your classification as a rifleman. The minimum course A qualifying scores are—

- (1) Expert 185 points
- (2) Sharpshooter 160 points
- (3) Marksman 135 points

*Table I. Course A, Instruction Firing, Known Distance
Slow Fire*

Range (yards)	Time	Rounds	Target	Position	Sling
200	No limit	4 (4)	A	Prone---	Loop.
200	---do---	8 (4)	A	---do---	Do.
300	---do---	4 (4)	A	---do---	Do.
300	---do---	8 (4)	A	---do---	Do.
500	---do---	4 (4)	B	---do---	Do.
500	---do---	8 (4)	B	---do---	Do.

*Table II. Course A, Instruction Firing, Known Distance
Slow Fire*

Range (yards)	Time	Rounds	Target	Position	Sling
200	No limit	8 (0)	A	Sitting---	Loop.
200	---do---	8 (0)	A	Squatting	Do.
200	---do---	8 (8)	A	Kneeling	Do.
200	---do---	8 (8)	A	Standing	Hasty.
300	---do---	8 (4)	A	Sitting---	Loop.
300	---do---	8 (4)	A	Squatting	Do.
300	---do---	8 (0)	A	Kneeling	Do.

Table III. Course A, Instruction Firing, Known Distance Sustained Fire

Range (yards)	Time (seconds)	Rounds	Target	Position	Sling
1200	26	23 (23)	A	Kneeling or sitting from standing.	Loop.
200	50	39 (39)	A	-----do-----	Do.
1300	26	23 (23)	A	Prone from standing.	Do.
300	50	39 (39)	A	-----do-----	Do.

¹ Fire twice.

² The rifle is to be loaded with one round initially and reloaded with a full clip, only two rounds of which are to be fired.

³ The rifle is to be loaded with one round initially and reloaded with a full clip.

Table IV. Course A, Record Firing, Known Distance Slow Fire

Range (yards)	Time	Rounds	Target	Position	Sling
200	No limit	4	A	Kneeling--	Loop.
200	-----do---	4	A	Standing--	Hasty.
300	-----do---	4	A	Prone-----	Loop.
300	-----do---	4	A	Sitting or squatting.	Do.
500	-----do---	8	B	Prone-----	Do.

Table V. Course A, Record Firing, Known Distance Sustained Fire

Range (yards)	Time (seconds)	Rounds	Target	Position	Sling
200	50	*9	A	Kneeling or sitting from standing.	Loop.
300	50	*9	A	Prone from standing.	Do.

*The rifle is to be loaded with one round initially and reloaded with a full clip.

142. COURSE B

a. General. Course B is prescribed in five tables and is fired when the range facilities for the standard course and course A are not available. The instruction firing outlined in tables I, II, and III is designed to serve as a guide only. With reduced ammunition allowance, the number of rounds shown in parentheses may be fired. Tables II, III, and V of course B are the same as tables II, III, and V of course A (par. 141).

b. Qualification Scores. The total of your record firing scores for tables IV and V determines your qualification as a rifleman. The minimum course B qualifying scores are—

- (1) Expert 185 points
- (2) Sharpshooter 160 points
- (3) Marksman 135 points

*Table I. Course B, Instruction Firing, Known Distance
Slow Fire*

Range (yards)	Time	Rounds	Target	Position	Sling
200	No limit	4 (4)	A	Prone...	Loop.
200	----do---	12 (8)	A	----do---	Do.
300	----do---	4 (4)	A	----do---	Do.
300	----do---	16 (8)	A	----do---	Do.

*Table IV. Course B, Record Firing, Known Distance
Slow Fire*

Range (yards)	Time	Rounds	Target	Position	Sling
200	No limit	6	A	Kneeling--	Loop.
200	----do---	6	A	Standing--	Hasty.
300	----do---	6	A	Prone-----	Loop.
300	----do---	6	A	Sitting or squatting.	Do.

143. COURSE C

a. General. Course C is prescribed in five tables and is fired when the range facilities are not adequate for the standard and the A and B courses. The instruction firing outlined in tables I, II, and III is designed to serve as a guide only.

b. Qualification Scores. The total of your record firing scores for tables IV and V determines your qualification as a rifleman. The minimum course C qualifying scores are—

- (1) Expert 175 points
- (2) Sharpshooter 150 points
- (3) Marksman 125 points

*Table I. Course C, Instruction Firing, Known Distance
Slow Fire. (Fired twice.)*

Range (yards)	Time	Rounds	Target	Position	Sling
200	No limit	4	A	Prone----	Loop.
200	---do---	4	A	---do---	Do.
200	---do---	4	A	Sitting---	Do.
200	---do---	4	A	Squatting	Do.
200	---do---	4	A	Kneeling	Do.
200	---do---	4	A	Standing	Hasty.

*Table II. Course C, Instruction Firing, Known Distance
Sustained Fire. (Fired twice.)*

Range (yards)	Time (seconds)	Rounds	Target	Position	Sling
200	26	*3	A	Prone from standing.	Loop.
200	26	*3	A	Sitting from standing.	Do.
200	26	*3	A	Kneeling or squatting from stand- ing.	Do.

*Rifle is loaded with one round. After the first round is fired, the rifle is to be reloaded with a full clip, only two rounds of which are to be fired.

Table III. Course C, Instruction Firing, Known Distance Sustained Fire

Range (yards)	Time (seconds)	Rounds	Target	Position	Sling
200	50	9	A	Sitting from standing.	Loop.
200	50	9	A	Kneeling or squatting from standing.	Do.
200	50	9	A	Prone from standing.	Do.

Table IV. Course C, Record Firing, Known Distance Slow Fire

Range (yards)	Time	Rounds	Target	Position	Sling
200	No limit	4	A	Squatting or sitting.*	Loop.
200	---do---	4	A	Kneeling or sitting.*	Do.
200	---do---	4	A	Standing----	Hasty.

*The sitting position may be substituted for either the squatting or kneeling position but not for both.

Table V. Course C, Record Firing, Known Distance Sustained Fire

Range (yards)	Time (seconds)	Rounds	Target	Position	Sling
200	50	9	A	Kneeling or squatting from standing.	Loop.
200	50	9	A	Sitting from standing.	Do.
200	50	9	A	Prone from standing.	Do.

144. COURSE D

a. General. Course D is prescribed in four tables and is fired when range facilities required for the standard and the A, B, or C courses are not available or when training time and the availability of ammunition permit 1,000-inch firing before instruction firing of the other courses. The instruction firing outlined in tables I and II is designed to serve as a guide only.

b. Qualification Scores. The total of your record firing scores for tables III and IV determines your qualification as a rifleman. The minimum qualifying scores are—

- (1) Expert 132 points
- (2) Sharpshooter 125 points
- (3) Marksman 100 points

*Table I. Course D, Instruction Firing, 1,000-inch
Slow Fire*

Range (inches)	Time (seconds)	Rounds	Target	Position	Sling
1,000	No limit	8	1,000-inch A	Prone-----	Loop.
1,000	----do---	8	do-----	----do-----	Do.
1,000	----do---	4	----do-----	Sitting-----	Do.
1,000	----do---	4	----do-----	Squatting	Do.
1,000	----do---	4	----do-----	Kneeling--	Do.
1,000	----do---	4	----do-----	Standing--	Hasty.

*Table II. Course D, Instruction Firing, 1,000-inch
Sustained Fire*

Range (inches)	Time (seconds)	Rounds	Target	Position	Sling
1,000	50	9	1000-inch A	Prone from standing.	Loop.
1,000	50	9	----do-----	Squatting or sitting from standing.*	Do.
1,000	50	9	----do-----	Kneeling or sitting from standing.*	Do.

*The sitting position may be substituted for either the kneeling or squatting position but not for both.

*Table III. Course D, Record Firing, 1,000-inch
Slow Fire*

Ranges (inches)	Time (seconds)	Rounds	Target	Position	Sling
1,000	No limit	4	1,000-inch A	Kneeling or sitting.*	Loop.
1,000	-----do-----	4	-----do-----	Standing --	Hasty.
1,000	-----do-----	4	-----do-----	Squatting or sit- ting.*	Loop.

*The sitting position may be substituted for either the kneeling or squatting position but not for both.

Scoring note—

Score only the fives, fours, and threes.

*Table IV. Course D, Record Firing, 1,000-inch
Sustained Fire*

Range (inches)	Time (seconds)	Rounds	Target	Position	Sling
1,000	50	9	1,000-inch A	Kneeling or squatting from stand- ing.	Loop.
1,000	50	9	-----do-----	Prone from standing.	Do.

Scoring note—

Score only the fives, fours, and threes.

145. TRANSITION FIRING—COURSES A, B, C, AND D

a. Transition tables VII and VIII of the standard course may be fired in courses A, B, C, and D. Where range facilities are not available, three alternate transition tables may be fired in lieu of tables VII and VIII. Table VI of the standard

course should be fired in all courses when range facilities are available.

b. While these alternate transition tables are not fired for qualification, the rifleman should attain a satisfactory score as indicated for each table before being considered proficient with his rifle. Those men not attaining a satisfactory score should fire until they do, providing that time and ammunition allowances permit.

c. Alternate transition firing is conducted on the known distance range and transition firing ranges according to the procedure explained in paragraph 325. These tables will be fired after known distance record firing and before firing combat exercises. The exercises are preceded by instruction in range estimation and in the use of an aiming point.

Table I. Alternate Transition Firing

Range (yards)	Time (seconds)	Rounds*	Target**	Position	Sling
200	60	5	3 E	Prone from standing.	Hasty.
300	60	5	3 Edo.....	Do.
500	60	5	3 Edo.....	Do.

*The rifle is to be loaded with a partial clip containing five rounds.

**Targets should be approximately 5 yards apart and as near the prescribed range as the terrain permits.

Scoring notes—

1. For each target hit..... 1 point
2. For each unexpended round, if all targets are hit..... 1 point

Table II. Alternate Transition Firing

Range* (yards)	Time (seconds)	Rounds**	Target	Position	Sling
-----	120	10	6 E	Prone from standing.	Hasty.

*Two targets between ranges of 200 and 300 yards, two targets between 300 and 400 yards, and two between 400 and 500 yards. Each pair of targets will be staggered and separated in depth from 250 to 50 yards.

**The rifle is to be loaded initially with a partial clip of two rounds and reloaded with a full clip.

Scoring notes—

For each target hit—

Between 200 and 300 yards.....	1 point
Between 300 and 400 yards.....	2 points
Between 400 and 500 yards.....	3 points
For each unexpended round, if all targets are hit...	3 points
Satisfactory score	8 points

Table III. Alternate Transition Firing

Range (yards)	Time ¹ (seconds)	Rounds ²	Target	Position ³	Sling
100	3 seconds per round.	5	E	Standing	None.

¹ Target will be exposed for a 3-second period during which rifle will be brought to the shoulder and a round fired.

² Rifle is loaded before start of exercise.

³ Rifle is held at the ready and brought to the shoulder for firing each round.

Scoring note—

For each target hit.....	1 point.
Satisfactory score	4 points

146. FAMILIARIZATION COURSE

Four hours of preliminary instruction are prescribed for those men who are required to familiarize themselves with the rifle. The familiariza-

tion course is fired on the 200-yard known-distance range. The number of rounds to be fired is given in the table which prescribes the course.

*Table I. Familiarization Course, Known-Distance
Slow and Sustained Fire*

Range	Time	Rounds	Target	Position	Remarks
200	No limit---	6	A	Prone-----	Zeroing 3-round groups.
200	8 minutes	8	A	Kneeling and squatting.	Each round loaded separately.
200	4 minutes	4	A	Standing--	
200	50 seconds	9	A	Standing to kneeling or squatting.	1 round in receiver; 8-round clip in cartridge belt.

147. RECORDING FIRING RESULTS ON RIFLE SCORE CARD

Riflemen should use the method shown in figure 99 for recording the conditions and results of firing on the range. Hard lead or indelible pencils should be used, and all entries should be neat and legible. Erasures should be kept to a minimum. During record firing, if the scorer makes an error, it should be crossed out (not erased), the correction entered, and one of the officers of the unit firing should initial the change.

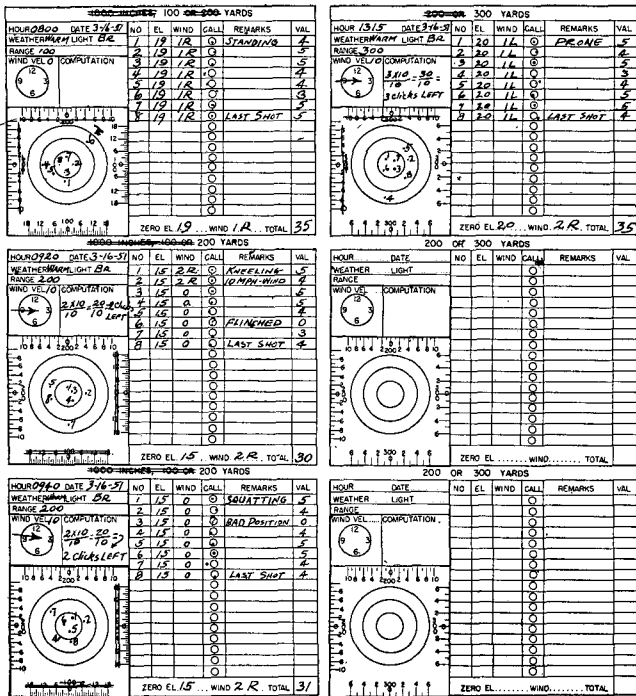

(2)

Figure 99.—Continued.

- an instructor, often carried on by the coach-and-pupil method.
- (2) *Record firing*, which is target practice in which a record is kept. The record is the basis of a soldier's classification in marksmanship.
 - (3) *Familiarization firing*, which is target practice to acquaint a firer with a weapon. It is fired only by those indi-

viduals who are not authorized to fire a record course for qualification.

b. Range firing opens with instruction firing. Each rifleman will complete instruction firing before he begins record firing. Once you start record firing, you must complete it before you are permitted to undertake additional instruction firing. As a rule, record firing will not be fired by any rifleman on the same day that he fires any part of instruction firing. However, when the time allotted to range practice is limited, the unit commander may authorize record firing on the same day. Instruction and record firing will not be conducted at the same time except on ranges where the firing points are in echelon or where the two types of firing are conducted on different parts of the same range.

149. RANGE PERSONNEL

The range must be well organized and closely supervised. Officers and noncommissioned officer assistants should be thoroughly oriented and assigned specific duties before they go on the range.

a. *The range officer* is appointed by the appropriate commander and is responsible to the commander for maintaining and assigning ranges, designating danger zones, and closing roads leading into danger zones. The range officer makes arrangements for material and labor to place the ranges in condition for range practice. He directs and supervises all repairs to shelters, butts, targets, firing points, and telephone lines. He provides for the safety of the target detail and, when

necessary, he provides range guards and instructs them in the methods to be used for the protection of life and property within the danger area.

b. The range noncommissioned officer and such assistants as the commander may consider necessary will be detailed permanently during the range practice season to assist the range officer. This detail is responsible for keeping the equipment in the target pits in a serviceable condition, for having targets ready for use, and for providing all target and pit details with the proper flags, marking disks, pasters, and spotters.

150. UNIT RANGE PERSONNEL

a. A unit range officer is appointed by the commanding officer of the unit using the range when there is no regularly assigned range officer. The unit range officer's duties are similar to those of the range officer.

b. An officer in charge of firing and safety is designated by the responsible commander. He should be the senior officer of the unit occupying the range. The officer in charge of firing or his assistant will be present during all firing. He is responsible for the proper and safe conduct of firing.

c. A pit officer is designated by the commander of the unit firing on the range. For his duties, see paragraph 190.

d. Pit details are provided by the organizations firing. These details supervise, operate, and mark the targets used by their respective organizations, and also serve as telephone operators.

151. ORGANIZATION OF THE FIRING LINE (fig. 100)

The firing line is organized to insure the safe and orderly conduct of range firing and to insure supervision of the entire firing line by the officer in charge of firing. The distances suggested in *b* through *f* below for organizing the firing line may be modified by the officer in charge to meet local conditions.

a. *The line of scorers* is stationed to the rear of the riflemen being scored. This line is usually on the slope or at the top of the slope of the firing line. Ordinarily, scores are set down only during record firing.

b. *The line of telephone operators* is stationed ten yards behind the firing line. There should be one telephone operator to every ten firing points.

c. *The line of ammunition tables* is located by the officer in charge of firing at his discretion with regard to safety. A good location is between the ready line and the telephone line.

d. *The ready line* is the line where the next order for each target is awaiting its turn to fire. This line is located ten yards back of the line of telephone operators.

e. *The line of rifle rests and cleaning racks* is five yards behind the ready line.

f. *The control stand* for the officer in charge of firing is placed twenty yards to the rear of and centered on the firing line. It must be located so the officer in charge of firing can observe and control the operation of the range.

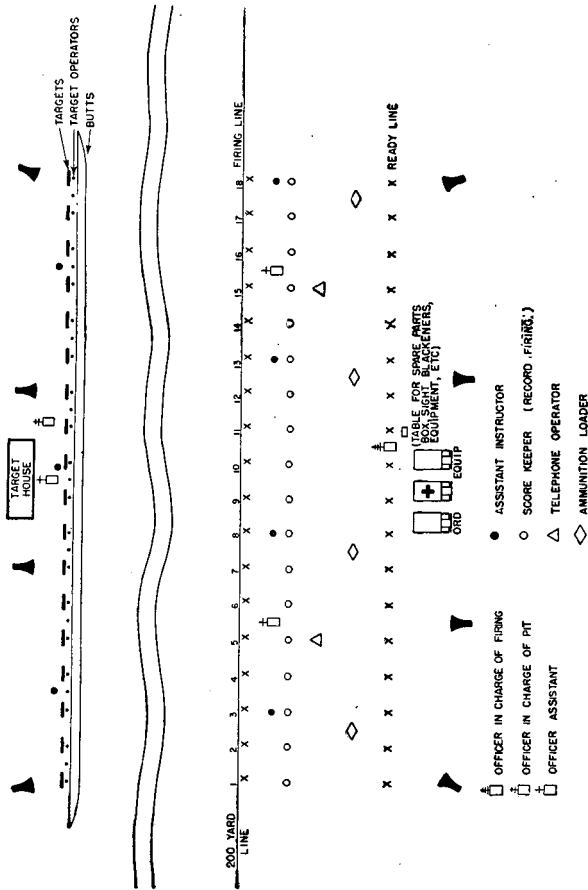

Figure 100. Organization of a known distance range.

g. Ordnance and aid men are located in rear of the center of the ready line.

h. A public address system, if available, is set up near the officer in charge. Enough speakers are placed at intervals behind the ready line to enable all personnel to hear fire commands and other announcements from the officer in charge. A speaker placed in the pit and connected through a telephone terminal to the address system enables the pit officer to hear all commands from the officer in charge of firing.

Section V. SUBJECTS COMMON TO INSTRUCTION AND RECORD FIRING

152. CLOTHING

The uniform which is worn during firing is prescribed by the unit or higher commander. Normally, fatigue clothes are worn. A cartridge belt is worn by the firer during all firing.

153. PADS AND GLOVES

You are encouraged to use pads and gloves to protect your shoulder, elbows, and arms during known-distance firing. The pads ease the shock of recoil and provide comfort so the firer can concentrate on shooting. The use of shooting coats is permissible. If these items are not available, other padding may be used. Only pads of moderate size and thickness may be used. Pads that form an artificial support for the weapon are not used. A hook or other devices on the sleeve are not allowed to keep the sling in place. A glove may be worn on either hand.

154. INSTRUMENTS

Binoculars and spotting scopes are authorized. Instruments may not be used for determining the velocity and direction of the wind during record firing.

155. SHELTERS

Riflemen are not permitted to use sheds or shelter tents on the range.

156. THE RIFLE

a. The rifle as it is issued by the Ordnance Department. The sights should be blacked during all range firing. Weapons and appliances which may have been issued for test purposes will not be used when firing for classification.

b. Trigger pull of the rifle must be at least 4.5 pounds and not more than 7.5 pounds. Before record firing, the trigger pull should be tested.

c. Only ammunition issued by the Ordnance Department will be used. During record firing no one will be issued more than the prescribed number of rounds.

d. The sling will be used on one arm only. No knot will be tied in the sling, and the sling itself will neither be added to nor modified in any manner, except that additional holes may be punched in the sling. The sling should be adjusted on the arm before the firer takes his position on the firing line.

157. RANGE PRECAUTIONS

Safety regulations which must be observed when handling and firing the rifle are covered in paragraph 353.

158. DAMAGED OR BROKEN RIFLES

If a breakage occurs, the rifle will be repaired or a different rifle will be used. If repairs involve the sights or if a different rifle is used, the firer will be allowed to rezero the repaired rifle or to zero the new weapon, and then to refire the exercise.

159. LOADING

Rifles are initially loaded only on command. Thereafter, they will be loaded at will as long as the firer is in the firing position and until he has expended his ammunition or the command CEASE FIRE is given.

160. TELEPHONES

Telephones for the firing line and pit are used for official communications only. Only the officer in charge of the firing or one of his assistants may request the identification of a target operator on any particular target. Pit personnel may not request the name of any particular firer. The following commands should be used over the telephone:

a. When a shot has been fired and the target has not been withdrawn for marking—MARK TARGET NUMBER_____

b. When a spotter has been placed in the target but the target has not been disked—DISK TARGET NUMBER_____

c. When the target has been disked but the value of the shot was not understood—REDISK TARGET NUMBER_____

d. Fire commands as given by the officer in charge of firing. Example—

READY ON THE RIGHT?

READY ON THE LEFT?

READY ON THE FIRING LINE.

161. COACHING

During instruction firing, the coach will help the firer in many ways. The firer must follow the coach's advice. During record firing there are certain limitations imposed on the coach (par. 186). When enough experienced personnel are available, well-trained and well-rehearsed non-commissioned officers will be assigned as coaches. Otherwise, the firers take turns coaching. Most organizations assign specially qualified coaches to several extra targets on one end of the firing line. Firers who have difficulty may be sent to these coaches for assistance and additional instruction. The positions and duties of the coach during preparatory marksmanship training are discussed in paragraphs 75, 103, 104, 109, and 111. The duties of the coach during instruction firing are discussed in paragraphs 178 to 180.

162. SCORE CARD

The score card serves as a firing record of the weapon. The firer must keep his own score card during all of his firing.

Section VI. INSTRUCTION FIRING

163. GENERAL

Instruction firing involves the use of live ammunition in applying the principles taught during preparatory marksmanship training. Instruction firing is outlined in each of the five rifle courses and is designed to serve as a guide only. Within the ammunition allowances of each unit, the number of shots to be fired at each range is determined by the organization commander.

164. DUMMY CARTRIDGES

a. The usefulness of dummy cartridges cannot be overemphasized. They save live ammunition and can be used over and over. Used alone, they are an excellent training aid for simulated firing and, when used with live ammunition, they are highly effective for detecting and putting an end to flinching.

b. To use dummy cartridges during instruction firing, slow fire, the coach, at his discretion, has the pupil look away from his rifle. Then the coach loads either a dummy or live cartridge, or lets the bolt close on an empty chamber. In this way the pupil does not know how the rifle is loaded.

c. Instruction firing in sustained fire should include firing live and dummy cartridges mixed in a clip, thus doubling the amount of practice. The coach operates the bolt each time a dummy cartridge is fired. Because of the slower rate of manual operation of the bolt, additional time should be allowed in firing these mixed clips. This training is needed to develop correct trigger squeeze.

165. ZEROING

One of the purposes of instruction firing is to obtain the *zero* of your rifle. The rifle will be zeroed at each range to be fired for qualification. Be sure to record the zero sight setting on your score card. After instruction firing or when the zero of the rifle has been definitely determined, the *zero record card* of the score card will be cut off and pasted, glued, or shellacked onto the floor plate of the trigger housing group. Then by opening the bolt and looking into the receiver, you can see the zero of your rifle for the different ranges.

166. THE 1,000-INCH RANGE

The target is so devised that when the sights are correctly set and the aim is accurately taken at 6 o'clock on the bull's-eye, the center of the shot group should be in the center of the bull's-eye.

167. ZEROING RIFLE ON THE 1,000-INCH RANGE

Set your sight at 12 clicks of elevation and zero windage. Take a steady aim in the prone position and fire one round. Continue this until you have fired three rounds. You should be able to see your shot group. If the visibility of the shot group is limited, binoculars may be used, or the instructor, after taking necessary safety precautions, may move along the line of targets and announce the corrections to the coaches in terms of inches, or you may go to the line of targets and observe your own shot group. You will then determine how many clicks to move your rear sight, and your coach will verify this change. *On the 1,000-inch range, one click of elevation or windage will move the strike of the bullet one-quarter of an inch.* Corrections are applied after each shot group, if necessary, with the third group being a confirming group.

168. ZEROING RIFLE ON KNOWN-DISTANCE RANGES

The position of the spotters on the target will permit the necessary corrections in elevation and windage to be computed by the elevation and deflection rules. These corrections are then applied to the rear sight. Your coach or an experienced firer should check these changes.

169. ZEROING RIFLE AT 100 YARDS

Raise the elevation 14 clicks from the lowest click on the rear sight and set the windage index

line in the center of the windage gage. To zero your rifle at 100 yards on a day when no wind is blowing, proceed as follows:

a. Load your rifle, take the prone position, get the correct sight picture, and fire a round.

b. Call the shot and enter your call on the score card.

c. Fire two more rounds using the same procedure.

d. When the target is marked, enter on your score card the location of the three shots on the target.

e. Determine how far the center of this shot group is from the center of the bull's-eye.

f. Using the elevation and deflection rules, make a change on your rear sight for elevation and windage to bring the center of your next shot group into the center of the bull's-eye.

g. Fire three more rounds using the same procedure as for the first group.

h. Plot the location of the second shot group and make a sight change, if necessary, to move the center of this group into the center of the bull's-eye.

i. Fire the third group. This group should be in the center of the bull's-eye.

j. The setting that you have on the rear sight is the zero of your rifle at 100 yards on a day when no wind is blowing. Record the setting as your 100-yard zero.

170. ZEROING RIFLE AT 200 YARDS

Raise the elevation only 12 clicks instead of 14 clicks and proceed as you did for 100 yards.

Record the elevation and windage for the 200-yard zero on your score card.

171. DIFFERENCE BETWEEN 100- AND 200-YARD SIGHT SETTING

You may wonder why your rifle requires 14 clicks of elevation at 100 yards and only 12 clicks at 200 yards. To understand the reason for this change, you must realize that although you aim at the bottom of a 12-inch bull's-eye, you have set your sights so that the bullet will strike in the center of the bull's-eye or 6 inches above your aiming point. In rising that 6 inches, at 200 yards the bullet travels on an arc and, by the time it has traveled 100 yards (half the distance), it has climbed approximately 4 inches above the line of aim. Therefore, if the target were at 100 yards and the 200 yards sight setting were used, the bullet would strike 4 inches instead of 6 inches above the bottom of the bull's-eye. Two more clicks of elevation at 100 yards are therefore required to cause the bullet to strike in the center of the bull's-eye.

172. ZEROING RIFLE AT 300 YARDS

Add 3 clicks of elevation to your 200-yard zero on the rear sight, then proceed as you did when you zeroed at 100 yards. Record the elevation and windage for the 300-yard zero on your score card.

173. BATTLE SIGHT

The 300-yard zero of your rifle is also the setting for your BATTLE SIGHT.

a. To set the battle sight (fig. 101), lock the rear sight at the 300-yard zero by tightening the rear sight locking nut; be careful not to disturb this sight setting. Loosen the screw in the elevation knob with the screwdriver blade of the combination tool. Move the elevating knob drum until the index line for BATTLE SIGHT, which is the 300-yard line, is opposite the index line on the receiver. Now tighten the elevating screw. Your sights are now set for the 300-yard or the BATTLE SIGHT zero. This sight setting on your rear sight is most important. During combat,

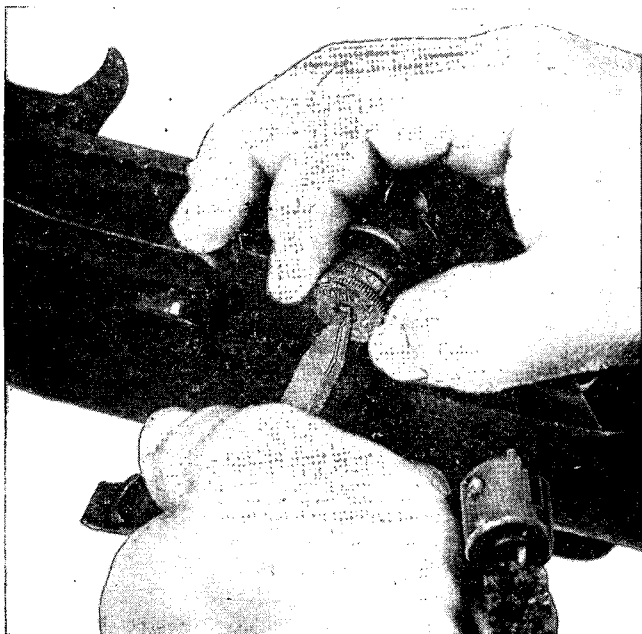

Figure 101. Setting the battle sight.

most of your firing will be done using this sight setting. Keep it on your rifle and keep the rear sight locking nut tight. Record the windage zero on your score card.

b. With the new modified rear sight, there is no way of tightening the elevation knob while the adjustment is being made. For sights of this type, proceed as follows:

- (1) Zero your rifle as described in paragraph 172.
- (2) Run the aperture all the way to the lowest position, counting the number of clicks from the 300-yard setting.
- (3) With the screw driver blade, loosen the elevation knob screw just enough to start it or break it loose, but leave it tight enough to turn the sight.
- (4) Run the sight back up the same number of clicks you counted when running the aperture down to its lowest position; then, holding the elevation knob firmly at this point, loosen the screw. Hold the aperture with the right hand and reset the knob by pulling the knob out and turning it so that its 300-yard range marking is at the index line.
- (5) Hold the knob and tighten the elevation knob screw as firmly as possible, then run the sight all the way up to the highest point and set the screw tight.
- (6) Check the setting by running the sight all the way down and then raising it, counting the number of clicks for the

300-yard setting. If the adjustment of the elevation knob has been done correctly, the 300-yard line will be at the index line on the receiver.

c. The reason for running the sight all the way down before trying to loosen the screw is that at the bottom position the knob will not turn to the left. This furnishes the necessary resistance to hold the pinion shaft while the screw is being turned to the left. In the same way, at the top of its movement, the shaft can turn no further to the right and at that point the elevation knob screw can be tightened firmly.

174. ZEROING RIFLE AT 500 YARDS

Add 7 clicks of elevation to your 300-yard zero. Zero your rifle at the 500-yard range in the same manner as you did for 100 yards. When you obtain a sight setting that allows you to place the center of a shot group in the center of the bull's-eye, you have the zero of your rifle at 500 yards. Record the zero elevation and windage for this range on your score card and memorize this sight setting.

175. ZEROING RIFLE WHEN A WIND IS BLOWING

Determine the zero for each range by using the method for a windless day. Then determine the value of the wind in clicks by using the wind formula $\frac{R \times V}{10}$. Subtract the result of this formula from the windage setting on the rear sight. The sight setting that you now have left on the

rear sight, both in windage and elevation, is the *zero sight setting* for that range on a day with no wind blowing.

176. SLOW FIRE

The first few shots you fire on the range should be slow fire from the prone position. At first, you should concentrate on developing the ability to fire a small group. Pay no attention to the score. Follow this with slow fire in the other positions.

177. SUSTAINED FIRE

No rifleman should fire sustained fire until he has fired a satisfactory group at slow fire. During sustained fire, the tendency to jerk the trigger is increased. You must correct this tendency before it becomes a fixed habit. Before firing a sustained fire run with live ammunition, it is advisable for each order to simulate a run of sustained fire, using dummy cartridges. Following this, the firing of clips mixed with live and dummy ammunition is an important step in learning correct trigger squeeze during sustained fire.

178. COACHING

You will work under the supervision of a coach during instruction firing. This does not mean that you will have an experienced marksman beside you. Any man who has been instructed in preparatory marksmanship training and in coaching methods can coach with good results and should be used when more experienced riflemen are not

available. One or more targets should be set up on one end of the firing line with expert coaches in charge to take care of firers who are having trouble. The coach should be very patient so as not to excite or confuse the rifleman.

a. Position of the Coach. On the firing line the coach should take a position similar to that of the man who is firing so he can watch the firer's trigger finger and observe any indications of flinching.

b. Detecting and Preventing Flinching. Flinching can usually be prevented by efficient coaching. One of the primary duties of a good coach is to detect flinching. An inclination to flinch may be detected by watching the pupil's head and eye at the time he is squeezing the trigger. If the pupil's eye begins to twitch during the application of the trigger squeeze and his head gradually is drawn away from the thumb or stock, the coach has positive indications that his pupil will flinch. As soon as the coach notices a tendency to flinch, he has the pupil bring his rifle down from the firing position and relax for a few minutes. While the pupil is resting, the coach points out the rifleman's errors to him. These usually will be—

- (1) Not taking up the slack with an initial heavy pressure.
- (2) Applying the trigger squeeze by means of a number of jerks of the trigger finger instead of a continuous firm pressure.
- (3) Concentrating on the discharge of the rifle instead of on the sight picture.

c. *Helping the Pupil to Detect Flinching.* After his mistakes have been pointed out, the pupil is permitted to aim again. If the pupil continues to flinch, the coach has him turn his head aside while he, the coach, puts a cartridge in the chamber and closes the bolt. The coach frequently loads a dummy cartridge into the chamber or merely simulates loading without allowing the pupil to know whether the rifle actually is loaded or not. In this way the flinch becomes evident to the pupil as well as to the coach. Indications of flinching are—

- (1) Hunching the right shoulder at the instant the hammer falls.
- (2) Winking the eye.
- (3) Pulling the head away from the rifle.

d. *Remedies for Flinching.* The coach then proceeds to show the pupil that this difficulty may be readily overcome by applying the correct trigger squeeze. The coach will do this by squeezing the trigger several times while the pupil aims the rifle. The shots that are fired when the coach squeezes the trigger usually are good and may prove to the rifleman that he is able to aim correctly and that his inaccurate shooting is caused by incorrect trigger squeeze. To squeeze the trigger for the rifleman, the coach lies with his right elbow on the ground to steady his hand, and places his forefinger against the trigger and his thumb against the back of the trigger guard. In this way, he can apply pressure to the trigger by a pinching action of his thumb and forefinger. The coach must be careful that his application

of force against the trigger is in a line parallel to the line of the sights, otherwise he will pull the sights out of alinement. The coach watches the rifleman's back, and between 5 and 10 seconds after the rifleman begins to hold his breath, he applies enough pressure to fire the rifle. He requires the rifleman to call each shot. After firing the rifle in this way a few times, the coach lets the rifleman try a few shots alone to see if he can squeeze the trigger without knowing just when the rifle will fire. Sometimes it is necessary to repeat this exercise, but the majority of beginners can be cured of the tendency to flinch by a few minutes of this kind of coaching. Men with previous firing experience who still have a habitual tendency to flinch require more time and patience.

179. COACH'S DUTIES DURING SLOW FIRE

The coach observes the pupil carefully and corrects all errors. When necessary, the coach applies the coaching methods of squeezing the trigger to prevent flinching. He requires—

- a.* The sights to be blacked and set at the correct elevation and windage.
- b.* The ammunition to be free from dirt.
- c.* The pupil to adjust the sling properly and to take the correct position.
- d.* The pupil to turn his head away while the coach loads.
- e.* The pupil to hold his breath properly. (He checks by watching the pupil's back.)

f. The pupil to take up the slack promptly and decisively with one motion.

g. The pupil to fire without flinching.

h. The pupil to release the pressure on the trigger, and to lower his rifle for a moment when his shot has not been fired in 8 or 9 seconds after the slack has been taken up.

i. The pupil to call his shot each time he fires.

j. The pupil to keep his score card correctly.

180. COACH'S DUTIES DURING SUSTAINED FIRE

The coach observes the pupil carefully and corrects all errors. He operates the bolt when dummy rounds are used and also watches the pupil's back from time to time to see whether he holds his breath while firing each shot. He notes improper timing, and, in appropriate cases, recommends to the officer in charge of firing that additional preparatory sustained fire practice be given. As the pupil's target is marked, the coach makes sure that the pupil plots his shot group accurately and records everything pertaining to his shots. Each of the following operations is done in sequence, and the coach checks each in turn. He requires—

a. The sights to be blacked and set at the correct elevation and windage.

b. The ammunition to be free from dirt.

c. The pupil to adjust his sling properly and take the correct position.

d. The pupil to take up the slack promptly and decisively in one motion.

- e. The pupil to fire without flinching.
- f. The pupil to count his shots aloud to insure his breathing after each shot.
- g. The pupil to reload properly.
- h. The pupil to plot his shot group on the score card.

Section VII. RECORD FIRING

181. GENERAL

The purpose of record firing is to test the soldier's skill as a rifleman and to determine his qualification. Qualification courses are outlined in each rifle course. The course for qualification to be fired by the individual is directed by Army Regulations or Training Programs. See AR 775-10, ATP 7-300, and ATP 21-110N.

182. RECORD CLASSIFICATION SCORE CARDS

During record firing a scorer is assigned to each firing point. Scorers should be thoroughly oriented in their duties and responsibilities. From a position directly to the rear of the firing point the scorer will record, on a separate score card of the same type used by the firer (fig. 99), the value of each shot as it is signaled from the pits. These score cards constitute the official record of firing for classification purposes. When record firing is completed, the officer in charge of firing will collect all score cards and, after checking and signing them, will turn them over to the organization commander.

183. SLOW FIRE

Only one rifleman in each order will be assigned to a target. When all riflemen are ready to fire, the officer in charge of firing gives the command—LOCK; ONE ROUND, LOAD; COMMENCE FIRING.

As each shot is disked in the pits, the scorer announces its value in a tone loud enough for the firer to hear:

Name	(Sgt Jones)
The number of the shot.....	(1st shot)
The value of the hit.....	(a five)

At this time, if a miss is indicated or if there is any doubt about the value, the firer may challenge this shot. The officer in charge of firing has the pit officer check the target in question. After rechecking, the scorer then records the value of the hit on the score card. At the end of the firing, the officer in charge of firing commands—CEASE FIRING, UNLOAD, CLEAR RIFLES.

184. SUSTAINED FIRE

a. One rifleman in each order will be assigned to a target. The rifleman adjusts the loop or hasty sling on his arm before he takes his position on the firing line. He has one loose round and a clip of eight rounds. *After he checks his clip for long rounds,* the firer places the clip in the third pocket of his cartridge belt. The targets are run up and the firer takes his position and sights on his target. When satisfied with

his position, he rises, relaxes, and waits for the fire command.

b. When all firers have checked their position, the targets are withdrawn and a red flag is displayed at the center target. At this signal, the officer in charge of firing commands—LOCK, ONE ROUND, LOAD.

When the rifle is locked and loaded, the coach steps back two paces. This shows the officer in charge of firing that the firers are ready. He continues with—

READY ON THE RIGHT?

READY ON THE LEFT?

Any firer not ready calls out, NOT READY ON TARGET NUMBER—. When everyone is ready, the fire command is continued—READY ON THE FIRING LINE.

At this command, the firer unlocks his rifle, stands relaxed with his eyes on his target and his right hand on the heel of his rifle butt.

c. At the command READY ON THE FIRING LINE, the read flag is waved for 5 seconds, then lowered. Five seconds after the flag is lowered, the targets appear, and remain exposed for the prescribed length of time. This time starts when the targets reach their highest point.

d. The rifleman takes his position as soon as the target appears and fires the first round; he then reloads with a full clip taken from the belt and attempts to fire the prescribed number of shots.

e. At the end of the prescribed time the targets are withdrawn, and the officer in charge commands—UNLOAD, CLEAR RIFLES.

In case of a stoppage through no fault of his own, the rifleman will be permitted to fire his remaining rounds *if he applied immediate action*. He is given 4 seconds to fire each remaining round and an additional 6 seconds if he has to load a clip into the rifle. If the stoppage was his fault, he will not be permitted to complete the firing. If a rifleman fails to fire at all, he will be given another chance to fire, but if he fires any shots, the score must stand as his record. He will not be permitted to repeat his score on the claim that he was not ready.

f. All unfired cartridges are removed from the rifle and the bolt is left open. The firers remain in position on the firing line until their rifles have been cleared and a clearance of the firing line is announced; they are then ordered off by the officer in charge of firing.

g. As the targets are disked from the pits, the score of each hit is announced by the scorer at the firing line. For example, a score of 9 shots is announced as follows, as each shot is disked:

Target _____. (Number of target)

1-five, 2-fives, 3-fives, 4-fives, 5-fives.

1-four, 2-fours, 3-fours.

1-three.

As soon as the target has been disked, the scorer counts the number of shots disked. If there are more hits than the prescribed number of rounds fired, the scorer requests that the target be re-

disked. When the target shows more than the prescribed number of hits, the rifleman must re-fire the exercise unless all shots on the target have the same value. Targets are usually left up for approximately one minute after disking. This gives each firer time to plot the shot group on his score card. The score card is kept during all firing. Targets may be left up longer on the direction of the officer in charge of firing.

185. SLOW AND SUSTAINED FIRE ON THE 1,000-INCH RANGE

Firing on the 1,000-inch range is done in a manner similar to firing on the known distance range with the following exceptions:

a. The officer in charge of firing gives the commands **COMMENCE FIRING** and **CEASE FIRING**.

b. The prescribed time starts with the command **COMMENCE FIRING** and ends with the command **CEASE FIRING**.

c. On completion of slow fire and sustained fire for each order, the firer and scorer are given time to examine the target for the purpose of recording the scores.

186. REGULATIONS

The record course normally is fired for qualification; thus additional regulations are imposed on record firing. Some of these regulations are—

a. *Restrictions on Identification of the Firer.* Members of the pit detail should not know who

is firing on any particular target and no attempt will be made to obtain this information. Personnel on or in rear of the firing line will not transmit this information to members of the pit detail.

b. Coaching. Coaching is permitted. However, the coach may not touch any part of the firer's body or weapon while he is firing.

c. Warming or Fouling Shots. Warming or fouling shots are not permitted.

d. Cleaning. Cleaning is permitted only between firing exercises.

e. Slow Fire Course Interrupted. If you are interrupted through no fault of your own when firing the slow fire course, the unfired shots necessary to complete the course will be fired at the first opportunity.

f. Misses.

- (1) *Slow fire.* In disking targets during slow fire, before any miss is signaled, the target will be withdrawn and carefully examined, preferably by an officer. Whenever the target is run up and a miss is disked, it will be presumed that this examination has been thoroughly made. If a challenge of a miss is made, the target will be very closely checked and the result disked to the firing line.
- (2) *Sustained fire.* If a challenge is made from the firing line after the target has been marked in sustained fire, it may be withdrawn and reexamined to determine possible corrections in the original

marking. After a challenge, the examination of a sustained fire target for misses will be made, preferably by an officer, before the target is run up to be disked.

g. Accidental Discharge. All the shots you fire after taking your place on the firing line are considered a part of your record score. This applies, regardless of whether your weapon is directed toward the target or fired accidentally.

h. Firing on the Wrong Target. Each shot that you fire on the wrong target is entered as a miss on your score card, regardless of what the value of the shot may be. You receive credit only for those shots which you fire on your own target.

i. More Than the Prescribed Number of Hits on the Target.

- (1) *In slow fire.* If two shots strike your target at nearly the same instant that you fire, you will receive credit for your shot only if both hits are of the same value. The other hit is not recorded. If the hits are of different value you will have to re-fire the shot.
- (2) *In sustained fire.* When your target has more than the prescribed number of hits, the target will not be marked unless all hits have the same value, in which case the target will be marked and you will be given credit for each shot you fired.

j. Withdrawing the Targets Prematurely. Dur-

ing slow fire, if a target is withdrawn just as you fire a shot, report this fact at once to the officer in charge of firing or one of his assistants. You will be allowed to fire another round if the complaint is warranted. The scorekeeper will be directed to disregard your last shot. During sustained fire exercises, you will be allowed to re-fire the exercise if your target is withdrawn prematurely.

k. Stoppages During Sustained Fire. If you have a stoppage during sustained fire, you must apply immediate action and attempt to finish the exercise. If this action does not reduce the stoppage, try to lock the rifle, then raise your hand and call STOPPAGE. The officer in charge of firing or one of his assistants will investigate the cause of the stoppage. When it is determined that the stoppage was caused through your fault or neglect you will not be allowed to complete the exercise. You will receive credit only for the score made on the number of rounds fired. If it is determined that the stoppage was caused through no fault of yours, you will be given permission to re-fire the entire exercise. If time and ammunition are not available, you will be given permission to complete the exercise on the basis of four seconds for each round that remains to be fired. If a clip has to be loaded into the rifle, six additional seconds will be allowed. In no case will you be given any information regarding your previous hits on the target until the exercise is completed.

l. Unfired Rounds in Sustained Fire. Each un-

fired cartridge is recorded as a miss except as stated in *k* above.

m. Damaged Rifle. If your rifle is damaged while firing, through no fault of yours, your last shots will be disregarded and the target will not be marked. You will refire the exercise after your rifle is repaired.

n. Shots Cutting Edge of Bull's-Eye or Any Dividing Line. Any shot cutting the edge of the bull's-eye will be signaled and recorded as a hit in the bull's-eye. Because the limiting line of each division of the target is the outer edge of the line separating it from the next lower division, a shot touching this line will be disked and recorded as a hit in the higher division.

187. FIRE COMMANDS

Each fire command you receive on the range follows a set form. Sample fire commands for slow and sustained fire exercises on the 1,000-inch and known distance ranges are listed below.

a. Fire commands for the 1,000-inch range.

(1) *Slow fire.*

LOCK
ONE ROUND, LOAD
COMMENCE FIRING
CEASE FIRING

(2) *Sustained fire.*

LOCK
ONE ROUND, LOAD
READY ON THE RIGHT?
READY ON THE LEFT?
READY ON THE FIRING LINE

COMMENCE FIRING
CEASE FIRING

b. Fire commands for the known distance ranges.

(1) *Slow fire.*

LOCK

ONE ROUND, LOAD

COMMENCE FIRING

CEASE FIRING

(2) *Sustained fire.*

LOCK

ONE ROUND, LOAD

READY ON THE RIGHT?

READY ON THE LEFT?

READY ON THE FIRING LINE

(Appearance of targets is the signal to commence firing, disappearance of targets is the signal to cease firing.)

c. Explanation of fire commands:

(1) READY ON THE RIGHT (LEFT).

This is the command used to determine whether all firers on the right (left) portion of the firing line are prepared for the firing exercise. If firer is not ready, he raises his hand and calls NOT READY ON TARGET.

(2) READY ON THE FIRING LINE. This

command means that all personnel on the firing line are prepared for the firing exercise. To the officer in charge of the pit detail, this command is a signal to wave the red flag from the center of the line of targets.

- (3) **COMMENCE FIRING.** This command is used to grant permission to the riflemen to start firing. It is used on the known distance range for slow fire and for all 1,000-inch fire commands.
- (4) **CEASE FIRING.** This command means to stop firing at once.
- (5) **UNLOAD.** This command means to unload the unfired cartridge from the chamber and to remove the clip from the rifle.
- (6) **CLEAR RIFLES.** This command means to pull the bolt all the way to the rear and to lock the rifle. The chamber is then inspected by an assistant instructor who is near that section of the firing line.
- (7) **FIRING LINE IS CLEAR.** This command means that the firing has stopped and all rifles have been cleared. Movement in front of the firing line or out of the pit is now safe.

Section VIII. PIT OPERATION

188. GENERAL

The pit detail's efficient operation of the target is essential to good shooting. At some time you will assist in operating the pits. You may be a target operator, a telephone operator, or a non-commissioned officer assisting the pit officer. Whatever your job may be, do it well.

189. ORGANIZATION

When possible, a unit other than the one that is firing provides the pit detail. This is especially desirable during record firing. Although it is desirable to have three or four target operators for each two targets, the pit can be run efficiently with only one operator per target. Besides target operators, an operator must be provided for each telephone and ammunition point. Normally, there is one telephone in the pit for every ten targets. Enough officers and noncommissioned officers are assigned to assist in supervising the pit detail. To insure efficient pit operation, one officer should be assigned to every twenty targets and one non-commissioned officer to every eight targets.

190. PIT OFFICER

The officer in charge of the pit is responsible for the safety of the pit detail and for the efficient operation of the targets. He will arrive on the range in advance of the pit detail and the firing unit to see that everything is in working order and ready to be used. He will know the number of men firing, the number of targets needed, and the number of men he will have to operate the targets, the telephones, and the ammunition points.

191. ORIENTATION

The officer in charge of the pit will explain and demonstrate marking and operation of the targets by using the following equipment:

- a. One A target with several 3-inch spotters

and a short range disk. These are used for the 100-, 200-, and 300-yard ranges.

b. One B target with several 5-inch spotters and a midrange disk. The short range disk is used for 100-, 200-, and 300-yard firing and the midrange disk is used for 500-yard firing. The midrange disk as well as the 5-inch spotters may be used at the 100-, 200-, and 300-yard ranges, if they are needed during periods of poor visibility.

192. MARKING

a. *Use of the Spotter.* In known distance firing the rifleman cannot see where the shot hits the target. To indicate the exact location of the shot, the target operator places a spotter in the bullet hole. He uses the 3-inch spotters when firing is conducted at 100, 200, and 300 yards, and the 5-inch spotters when the firing is done at 500 yards. If the shot hits the target outside of the bull's-eye, he places the spotter in the bullet hole with the black side of the spotter exposed to the firer. If the shot hits the bull's-eye, the spotter is placed in the bullet hole with the white side of the spotter exposed to the firer.

b. *Use of the Disk.* The disk is used to indicate the value of each shot as follows:

<i>Disk</i>	<i>Shot value</i>
White	5
Red	4
White with a black cross.....	3

Note. A red flag indicates a miss. Ricochets are indicated as misses except when specific instructions allow them to be counted as hits.

c. Procedure for Using Disk and Red Flag.

- (1) For a 5- or a 4-ring hit, raise the disk to the upper right hand corner of the target and then lower the disk over the center of the spotter.
- (2) For a 3-ring hit, raise the disk to the upper left hand corner of the target, then lower the disk over the center of the spotter.
- (3) For a miss, move the flag slowly across the front of the target once for each miss. It is advisable during instruction firing to mark the shots that hit outside the 3-ring. They are still recorded as misses, but the location of the shot can be seen from the firing line, enabling the rifleman to make a practical sight change in order to bring the next shot into the center of the bull's-eye. Misses outside the 3-ring will not be marked during record firing.

193. OPERATING AND MARKING TARGETS DURING ZEROING

While zeroing, the firer on your target will fire three rounds to form a group. Leave the target up until you are ordered to withdraw it by the officer in charge of the pit. Place a spotter in each of the three holes, then raise the target. Disk each hit. Hits of the highest value are disked first. Care must be taken that the correct side of the disk is exposed while marking the shots. Disk the shots slowly to avoid confusing the firer.

When one spotter is used to cover more than one hit, the disk is placed over the spotter the required number of times. After disking one hit, the disk is raised to the upper right (or left) corner before disking the next shot. You will then be told to withdraw the target, remove the spotters, paste the bullet holes, and raise the target for the next group of three shots.

194. OPERATING AND MARKING TARGET DURING SLOW FIRE

Withdraw and mark the target for each shot. You must remain alert in order to give good pit operation. Watch and listen for the bullet to strike the target. When your target is hit, pull it down and place a spotter in the hole. Since the rifleman might have fired more than one shot, always check the target for more than one hit. If there is more than one hit, place a spotter in each bullet hole and disk the hits as required. The spotter is left in the target until the next shot is fired. At that time the spotter is removed, placed in the new hole, and the old hole is pasted. If the hit is in the bull's-eye and the spotter interferes with the firer's sight picture, the spotter will be removed and the bullet hole pasted if the firer requests it.

195. OPERATING AND MARKING TARGET DURING SUSTAINED FIRE

You must stand by your target at all times during a sustained fire exercise because the time allowed for the exercise is short. Before the exercise starts, you will be told to raise your target.

This allows the rifleman to check his aim and position. Later, the pit officer will tell you to withdraw the target and stand by for the next command. That command will be **RAISE ALL TARGETS**. A whistle may be used for giving this command. All targets should be raised at the same time. The pit officer times the exercise starting when the targets reach their highest point. Several seconds before the end of the exercise, the pit officer instructs **STAND BY YOUR TARGETS**. The command **TARGETS DOWN** is given so that the targets are lowered just at the expiration of the time limit. All targets should be lowered at the same time. Normally, the targets are raised again before marking in order that those firers with stoppages may fire their alibis. When marking the target for a sustained fire exercise, you need to place only enough spotters in the target to indicate the location of the shot group. When disking the target, however, remember to disk each shot. Write the number of fives, fours, threes, and misses at the bottom of the target. This helps you if the firer should request a redisking of the target after you paste the bullet holes. If there are more hits on your target than the number of rounds fired by the firer, have the target checked by the officer in charge of your section of the pit. After checking, he will notify the officer in charge of the firing line. Usually, you will be directed to paste the target and raise it again so the firer may refire the exercise. If all the hits are of the same value, the exercise is not refired. The firer receives credit for the number of shots he fired.

196. EQUIPMENT

All necessary equipment to be used for marking and pasting targets is found in the target house. For a list of the equipment used in the operation of the pit, see paragraph 199.

a. The *target* is pasted on target cloth which is mounted on a wooden frame 6 feet square. This frame is easily broken and the target can be punctured, so it is best for two men to carry the target and place it in the target carrier.

b. The *target carrier* is mounted on a steel frame for holding the target. The carrier has a counterweight to balance the target. This counterweight may be another target or some other weight. In all cases the carrier must be tied to the steel frame when placing a target in the carrier or when removing the target. Some target carriers have a rope tied to the bottom. This rope can be used to tie the carrier down. If this is not done, the counterweight will drop and may cause personal injuries or damage to the target equipment. If another target is used for counterbalance, the blank side will be placed toward the firing line.

197. LOCATION OF LATRINES AND WATER POINTS

If these are within safety limits, the men may use them at any time. If they are not within the safety limits, the officer in charge of the pit will permit their use only when the firing has ceased and a clearance of the firing line has been given the pit officer by the officer in charge of firing.

198. SAFETY PRECAUTIONS

The following safety precautions must be observed while you are working in the pit:

a. You must remain near your target during all firing. The only exception is in securing marking equipment or using the latrine and water point if they are within the safety limits.

b. Do not expose any part of your body above the butts.

c. Be careful when operating the target carrier so that you do not injure yourself.

d. When handling the disk, take care not to strike other target operators nearby. When you place the disk down, be sure that it is secure so that it will not fall and strike anyone.

e. No one may leave the pit until the firing line is clear. This permission is given by the officer in charge of the pit after he has received clearance from the firing line. If one of two firing sections finishes firing, the pit detail for that section may not leave the pit until authorized by the officer in charge of firing.

Section IX. EQUIPMENT AND TARGETS

199. EQUIPMENT

A great amount of equipment is needed to teach you how to shoot your rifle. There is equipment for the preparatory field, the range, the firing line, and the pit. A list of equipment and its use follows.

a. *Preparatory Marksmanship Equipment.*

- 1 numbered stake per four soldiers or less.
 - 1 rifle rack per 20 soldiers or less.
 - 1 stake (with the A 1,000-inch target bull's-eyes painted or tacked on at heights to correspond to the standing, sitting, and prone positions) per twelve soldiers or less.
 - 1 sighting and aiming bar, complete, for each 2 soldiers.
 - 1 M15 sighting device per 4 soldiers.
 - 1 rifle rest (box) per 4 soldiers.
 - 1 box with white paper, tacked on, per 4 soldiers.
 - 1 bull's-eye disk per 4 soldiers.
 - 1 pencil per 4 soldiers.
 - 1 score card for each soldier
 - 1 clip of dummy rounds per 2 soldiers.
 - 1 stop watch.
 - 1 M2 aiming device per 4 soldiers.
 - 1 table
 - 5 cleaning rods M3.
 - 1 first aid box
 - 1 spare parts box.
 - 1 progress chart to show the progress of each soldier.
- Trash containers.
- Carbide lamps, with carbide and water. Other sight blacking equipment may be used if lamps are not available.
- Waste for cleaning purposes.
- Blackboards, chalk, and erasers to meet requirements.
- Necessary charts to meet requirements.

Public address system (if available).

b. Range Equipment at the Firing Line.

Ammunition.

Carbide lamps or suitable blacking equipment.

Tables (1 per ammunition loader).

Chairs (1 per firing point, telephone operator, and ammunition loader).

Binoculars (1 per point for use by the coach or scorer at the 500-yard line).

Score cards (1 per rifleman).

Cleaning and preserving materials.

Indelible pencils (1 per point, used during record scoring).

Boxes for brass (1 per 10 points).

Boxes for trash (1 per 20 points).

Spare parts box.

Telephones (sufficient number for requirements).

First aid box.

Ambulance.

Cleaning racks (these may be located in the company area).

Dummy rounds (for use in detecting flinching).

Stop watch for officer in charge of firing and officers assistants on the firing line.

Aiming device M2 (to check the sight picture of soldiers not shooting consistently well).

Public address system (if available).

c. Range Equipment in the Pit.

A targets. (1 per target point.)

B targets. (1 per target point.)

3-inch spotters (9 spotters for each A target).

5-inch spotters (1 for each B target).

Marking disks (1 short range and 1 mid-range per target).

Pasters (buff and black) and paste for each target point.

Red flag (1 per target).

Red flag attached to long staff for use by pit officer.

Telephones (1 per phone terminal).

First aid box.

Stop watch and whistle for officer in charge of the pit.

Public address system (if available).

200. TARGETS

a. The A 1,000-inch rifle target is used for all preparatory marksmanship training and firing on the 1,000-inch range. This target is a reduction of the large A rifle target. The value of hits on the reduced target is the same as the value of hits on the large target. Hits in the 2-ring are not scored.

b. The A rifle target (fig. 91) is used for the 100-, 200-, and 300-yard ranges for both slow and sustained fire. It is 6 feet high and 4 feet wide. It has a black circular bull's-eye (the 5 ring) 12

inches in diameter, an inner ring (the 4 ring) 24 inches in diameter, and an outer ring (the 3 ring) 36 inches in diameter. No value is given for hits striking the target outside of the 3 ring.

c. The B rifle target (fig. 92) is used for the 500-yard range and is 6 feet square. It has a black circular bull's-eye 20 inches in diameter, an inner ring 40 inches in diameter, and an outer ring 60 inches in diameter. The value of hits on the B target is the same as the value of hits on the A target.

d. The diameter of the bull's-eye on the A target (12 inches), the width of the 4 ring (6 inches), and the width of the 3 ring (6 inches) are designed to correspond with the change in inches that clicks in elevation and windage cause at 300 yards. For instance, a 2-click change in windage at 300 yards moves the strike of the bullet 6 inches, or the width of the 4 or 3 ring. Similarly, the diameter of the bull's-eye on the B target (20 inches) and the width of the 4 and 3 rings (10 inches each) correspond to the change in inches that clicks in elevation and windage cause at 500 yards. For instance, a 2-click change at 500 yards moves the strike of the bullet 10 inches, or the width of either the 4 or 3 ring.

e. Targets E and F are used for unknown-distance firing and represent a figure about the height of a man in the kneeling and prone positions, respectively. They are constructed by tacking the pasteboard target, E or F, to a target stake.

Section X. SMALL-BORE FIRING

201. PURPOSE

Small-bore firing provides marksmanship training with the caliber .22 rifle and ammunition that represents the application of the principles taught in the preparatory exercises. Small-bore firing provides an excellent means of improving the shooting in organizations and of sustaining interest in marksmanship throughout the year. By firing this course the company commander can determine the state of training of his command. Thus he can concentrate his efforts on training the men who are most deficient in their marksmanship.

202. CONDUCT OF SMALL-BORE FIRING

Small-bore firing may be carried on throughout the year, subject to limitations such as may be imposed by the ammunition allowance. Soldiers who have never been instructed in shooting methods prescribed in this manual will be given preparatory instruction before being permitted to fire on the small-bore range. All small-bore firing will be organized and supervised according to the methods of instruction prescribed in this manual.

203. COURSE E

When time and available facilities permit, organizations may fire the small-bore course outlined below. All firing is at 50 feet on the official 50-foot small-bore target.

a. Instruction firing should be performed at least twice, and may be fired three or more times when ammunition allowances and training time permit.

b. The minimum course E qualifying scores for the three classifications are—

- (1) Expert rifleman 320 points
- (2) Sharpshooter 290 points
- (3) Marksman 260 points

*Table I. Course E, Instruction Firing, Slow Fire
(for Zero)*

Time	Shots	Position	Sling
No limit.....	*10	Prone.....	Loop.

*All slow fire is single loaded.

Table II. Course E, Instruction Firing, Slow Fire

Time	Shots	Position	Sling
No limit.....	*5	Prone.....	Loop.
do.....	*5	Squatting.....	Do.
do.....	*5	Kneeling.....	Do.
do.....	*5	Standing.....	Hasty.

*All slow fire is single loaded.

Table III. Course E, Instruction Firing, Sustained Fire

Time	Shots	Position	Sling
40 seconds	5	Squatting from standing	Loop.
40 seconds	5	Kneeling from standing	Do.
40 seconds	*5	Prone from standing.....	Do.

*Fired twice for one score (a total of 10 rounds from prone).

*Table I. Course E, Record Firing, Slow Fire**

Time	Shots	Position	Sling
5 minutes-----	**5	Prone-----	Loop.
5 minutes-----	**5	Squatting-----	Do.
5 minutes-----	**5	Kneeling-----	Do.
5 minutes-----	**5	Standing-----	Hasty.

*Fired once. In this record firing both slow and sustained fire, one shot only will be fired on each bull's-eye of each 10-bull target.

**All slow fire is single loaded.

*Table II. Course E, Record Firing, Sustained Fire**

Time	Shots	Position	Sling
40 seconds	5	Squatting from standing	Loop.
40 seconds	5	Kneeling from standing	Do.
40 seconds	**5	Prone from standing----	Do.

*Fired once. In this record firing both slow and sustained fire, one shot only will be fired on each bull's-eye of each 10-bull target.

**Fired twice for one score (a total of 10 rounds from prone).

CHAPTER 4

MARKSMANSHIP, MOVING GROUND AND AERIAL TARGETS

Section I. GENERAL

204. INTRODUCTION

a. General. This chapter covers the fundamentals of firing at moving targets. You will be trained to fire at moving men, vehicles, and appropriate aerial targets within the effective range of your rifle. Rifle fire may be used against lightly armored vehicles and motorized troops. It causes more heavily armored vehicles, like tanks, to button up, which restricts the vision of the crew.

b. Effective Range. Under normal conditions moving ground targets may be engaged effectively at ranges up to 400 yards. Effective results beyond 400 yards are considered exceptional. Therefore, training in the technique of fire at moving ground targets is normally limited to ranges up to 400 yards. Against parachutists and slow flying aircraft, the maximum effective range is 500 and 600 yards respectively.

c. Battle Sights. Under combat conditions moving targets are seldom exposed for long periods of time. You can also expect the targets to move quickly while they are exposed. Under these conditions, you may not have time to make sight settings. Therefore, instruction in the technique of

firing at moving targets is based on the use of the battle sight and adjustment of the point of aim on the target.

205. WHEN TO CONDUCT TRAINING

Instruction in the technique of firing at moving targets follows instruction on known distance firing and precedes combat type firing. You will be trained to estimate the range and speed of moving vehicles before you practice firing at moving targets. Instruction in the technique of firing at aerial targets is limited to training in the aerial target firing position and in the leads to be taken for slow-moving aerial targets.

206. SAFETY PRECAUTIONS

For applicable safety precautions, see SR 385-310-1, paragraph 353 of this manual, and local regulations.

Section II. MOVING PERSONNEL

207. TECHNIQUE

In combat, moving enemy soldiers present small fleeting targets. This increases the importance of an accurate sight setting and an accurate lead. When targets appear suddenly, allowing no time for sight adjustment, you will have to use the battle sight and select a proper aiming point with respect to the center of the target so that the moving target and the bullet meet.

208. METHOD OF AIMING

a. *Aiming Point* (fig. 102). When you use your battle sight setting (300 yards zero), the path of the bullet's flight is relatively flat up to a range of 400 yards; when firing at a standing man, you should aim at the center of his body about belt level. Therefore, if the enemy soldier is moving directly toward or away from you,

AIMING POINT USING BATTLE SIGHT (300 YDS) AGAINST PERSONNEL



Figure 102. Aiming point.

use this same aiming point, his belt. Should you find it necessary to engage an enemy soldier at a range greater than 400 yards, effective results can be obtained by setting your sight at the proper range and continuing to use the same aiming point.

b. Leads. To get the proper lead for firing at a man walking across your line of fire, aim the rifle as shown in figure 103. If the man is running, double the lead. Accuracy in this type of firing depends largely on the amount of time you devote to the practice of leading the target, aiming, squeezing the trigger, following through, and the correct battle sight setting. Use the following aiming points as a basis for obtaining the proper leads:

- (1) At ranges less than 300 yards, aim at the forward edge of the body.
- (2) At ranges of 300 yards or more, lead your target by the width of the body.

Section III. MOVING VEHICLES

209. HOW TO DETERMINE THE POINT OF AIM AND TO APPLY LEADS

a. The lead in terms of apparent target length necessary to hit a moving vehicle will depend on the size and speed of the vehicle and on its range. Vehicles moving across country rarely exceed a speed of 7 miles per hour. Vehicles moving on roads near the battle position will move much faster but as a general rule they seldom will be able to exceed a speed of 20 miles per hour.

b. Therefore, it is possible to establish a rule which will enable riflemen to hit most moving vehicles encountered on the battlefield.

- (1) Normally, aim and fire at the leading edge of the target.

LEADS

(MAN WALKING)
USING BATTLE SIGHT (300 YDS)
AGAINST PERSONNEL

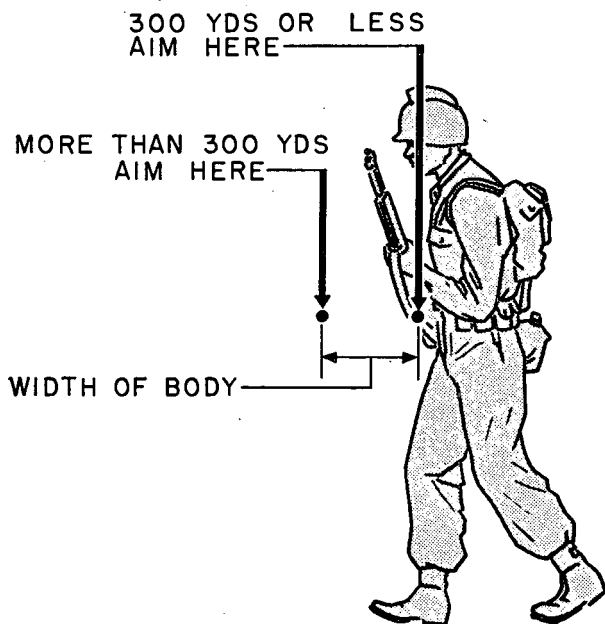

Figure 103. Leads.

- (2) If the speed of the target is greater than 15 miles per hour *and* the range is greater than 300 yards, aim and fire at a point one-half the apparent length of the vehicle ahead of the target. (One-half length lead.)

c. Using the *apparent* target length in establishing the amount of lead makes it unnecessary to correct for the angle at which the target crosses the line of sight. For example, two identical vehicles, A and B, are crossing your sector of fire. Each vehicle is at the same range and is traveling at the same speed. A is moving approximately straight across your front. B is crossing your front at an angle. As you look at the vehicles, A will appear to be moving faster. B will appear shorter and will seem to be moving slower. Any vehicle crossing your front at an angle will require less lead than a vehicle moving straight across your front. The correct amount of lead will be taken automatically when the apparent length of the target is used as a unit of measure.

d. When no other facilities are available, practice in aiming and leading a target may be obtained by tracking vehicles moving along roads near the training areas.

210. TECHNIQUE OF FIRE

The following technique is suggested for firing at moving vehicles, using the battle sight:

a. For approaching or receding targets, hold your aim on the center of the target and squeeze off each shot.

b. For targets crossing your front at any angle, align your sights on the *front edge of the target*; then swing the rifle laterally in the direction the target is moving (if necessary, take and hold the estimated lead), and squeeze off the shots. Swing the rifle with a smooth, uniform motion.

c. Fire as rapidly as accurate aiming and leading will permit.

Section IV. AERIAL TARGET

211. AIRCRAFT AND PARACHUTISTS

a. A volume of rifle fire is effective against low flying troop carrier and slow flying observation aircraft, provided that shots are aimed well ahead of the target. Because of their speed, armor, and tactics, other types of aircraft are not considered suitable targets for rifle fire.

b. Descending parachutists are also targets against which a volume of rifle fire is effective. Airborne troops are particularly vulnerable to collective small-arms fire at the moment of landing and for a short time after landing while they are securing their equipment and attempting to reorganize.

c. The maximum effective range of rifle fire against slow moving aircraft is approximately 600 yards; against parachutists it is 500 yards.

212. TECHNIQUE OF FIRE

a. For aircraft targets descending directly toward or climbing directly from your firing posi-

tion, aim directly at the target and squeeze off your shot.

b. For aerial targets flying across your line of fire and within effective range, aim ahead of the target and distribute your fire *along the path of the target's flight*. When the range to the target exceeds 400 yards, aim the rifle above as well as in front of the target. To estimate the lead, use the length of the target as the unit of measure. A lead of two lengths is recommended for slow flying observation planes, and a lead of one length is suggested for troop carrier planes and gliders. To hit a descending parachutist at a range of 300 yards or less, aim at his feet. At ranges over 300 yards, lead him by one length.

c. After having acquired the fundamentals of good shooting in your course of training in rifle marksmanship, you need only to have practice in swing and follow-through to enable you to fire on aerial targets. Steps to follow in firing at aerial targets are—

- (1) Estimate the required lead, using the length of the target as a unit of measure.
- (2) Align the sights on the target, then rapidly swing ahead to the required lead.
- (3) Swing your rifle with a smooth, uniform motion to maintain your aim along the path of flight and at the required lead.
- (4) Apply correct trigger squeeze to fire as many rounds as possible without disturbing your aim.

d. Infantrymen should be prepared to fire as soon as possible after receiving warning of the

approach of hostile aircraft. You should begin tracking the target before it comes within effective range. This will enable you to track it smoothly and to fire the maximum number of rounds while it is within effective range.

CHAPTER 5

TECHNIQUE OF FIRE OF THE RIFLE SQUAD

Section I. GENERAL

213. INTRODUCTION

The steps in technique of fire training and the sequence in which they are given follow:

- a.* Range determination.
- b.* Rifle and automatic rifle fire and its effect.
- c.* Fire commands.
- d.* Application of fire by the squad.
- e.* Landscape target firing.
- f.* Field target firing.

Section II. RANGE DETERMINATION

214. IMPORTANCE

Range determination is the method of finding out how far it is from your position to another position such as an enemy target. It is important that you know how to determine ranges accurately. Then you will be able to set your sights correctly and place effective fire on enemy targets; you will be able to locate targets quickly from your leader's commands and you will be able to designate accurately the targets which you have located.

215. METHODS

In the field you will use two methods of determining ranges—

a. Estimation by eye.

b. Observation of the strike of tracer or ball ammunition.

216. ESTIMATION BY EYE

You will use this method most frequently in determining ranges. There are two ways to estimate ranges by eye—the mental unit of measure (yardstick) and the appearance of objects. You need training and practice in both methods over varied terrain and under varied conditions of light and weather.

a. *Mental Unit of Measure (Yardstick).*

- (1) You can picture in your mind short units of measure such as an inch, a foot, or a yard. But can you picture 100 yards? Think of the distance from goal to goal on a football field (100 yards). Also think of the distances on the 100-, 200-, and 300-yard rifle ranges. With these mental yardsticks, try to estimate distances on your drill field, on city streets, or across open country. When you have made your estimate, check yourself by stepping off the distance to the estimated point—120 normal steps is about 100 yards. This is a good game you can play alone while you are hiking. With practice you will soon learn to estimate 100 yards quite accurately (fig. 104).

- (2) After you learn to estimate 100 yards accurately, apply your mental yardstick to 200, 300, and then to 500 yards. Dis-

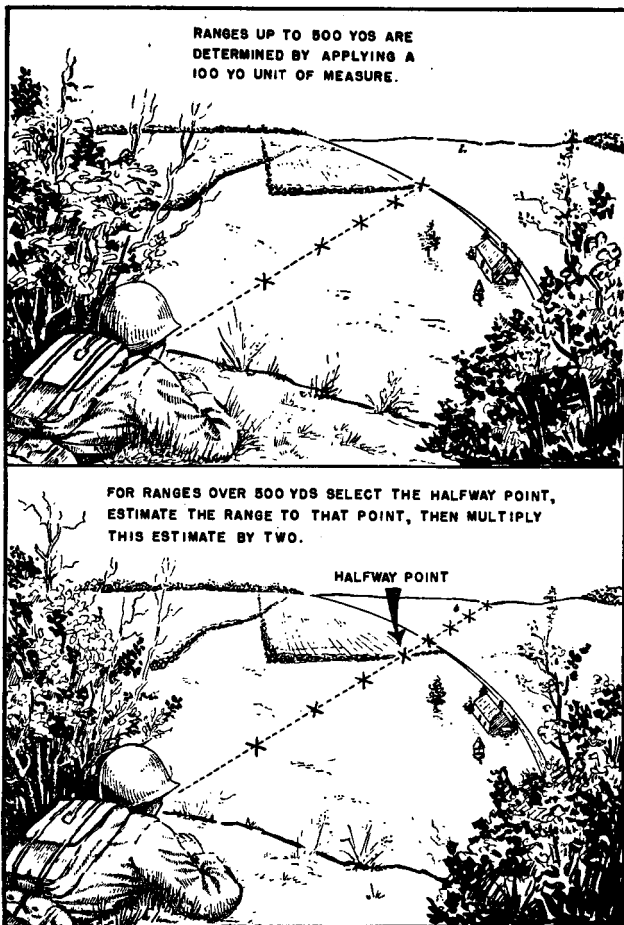

Figure 104. Applying the 100-yard unit of measure in estimating ranges by eye.

tances beyond 500 yards can be measured more accurately by selecting a half-way point. Estimate the distance to this half-way point; then double it.

b. Appearance of Objects.

- (1) When there are hills, woods, or other obstacles between you and the target where most of the ground is hidden from view, it is impractical to apply the 100-yard mental yardstick with accuracy. In such cases you may use another type of yardstick; that is, how an object looks to you at 100 yards and at greater distances. For example, watch a man when he is standing 100 yards away from you. Fix his appearance firmly in your mind: his size and the details of his features and equipment. Watch him in the kneeling position, then in the prone position. By comparing the appearance of a man in several positions at 100, 200, 300, 400, and 500 yards you can establish a series of mental pictures that will give you another mental yardstick. You will find that, as the distance increases, a man's figure becomes smaller. His outline becomes increasingly blurred and his other features gradually fade out.
- (2) In the same way, the appearance of other familiar objects can be applied as a mental yardstick.

c. Factors Affecting Range Estimation by Eye. Once you have established the principles of

Table II. Factors Affecting Estimation of Ranges By Eye

<p>Factors to be considered in estimating range by eye</p>	<p>Objects <i>appear</i> nearer than they really are and ranges are underestimated</p>	<p>Objects <i>appear</i> more distant than they really are and ranges are overestimated</p>
<p>The target—its clearness of outline and details. Nature of the terrain or position of the observer.</p>	<p>When most of the target is visible and offers a clear outline. When looking across a depression, most of which is hidden from view. When looking downward from high ground. When looking down a straight open road or along a railroad track. When looking over uniform surfaces like water, snow, desert, or grain fields. In bright light or when the sun is shining from behind the observer.</p>	<p>When only a small part of the target may be seen or is small in relation to its surroundings. When looking across a depression, all of which is visible. When looking from low ground toward high ground. When vision is narrowly confined as in twisted streets, draws, or forest trails.</p>
<p>Light and atmosphere.</p>	<p>When the target is in sharp contrast with the background, or is silhouetted, by reason of size, shape, or color. When seen in the clear atmosphere of high altitudes.</p>	<p>In poor light such as dawn and dusk, in rain, snow, or fog, or when the sun is in the observer's eyes. When the target blends into the background or terrain.</p>

estimating ranges by eye, you will find it necessary to make allowances for variables like light, weather, and the terrain. Your understanding of the factors shown in table II will help to make your estimates more accurate.

d. In Training, Several Men Should Work Together. When there are differences in estimates, you should determine the reasons for the differences. By adding the estimates of several men together and dividing the result by the number of men, the average obtained will be more accurate than a single estimate. Even in combat when time and circumstances permit, average estimates should be obtained.

217. OBSERVATION OF FIRE

Accurate range determination can be made by observing the strike of tracer or ball ammunition. This method can be used if your presence is known to the enemy or if surprise is not important. An observer is necessary because it is difficult for a firer to follow his own tracer and pick up the strike of his own shot. The procedure follows:

a. The firer estimates the range by eye, sets the rear sight of his rifle for that range, and fires.

b. The observer follows the path of the tracer or picks up the strike of the bullet.

c. The observer gives the firer the correction for the sight setting (up or down) in clicks of elevation necessary to hit the point of aim (target).

d. The firer makes the sight change and continues to fire and make corrections until a hit on the target is observed.

e. The final sight setting to hit the target (with consideration to the zero of the rifle) indicates the range to the target. The firer announces the range by voice or signal.

Section III. RIFLE AND AUTOMATIC RIFLE FIRE AND ITS EFFECT

218. GENERAL

The *second* step in the technique of rifle fire training is rifle and automatic rifle fire and its effect. A knowledge of what the bullet does while it is in flight and an understanding of the effects of your fire on the enemy help you to use your rifle so that its fire is most effective. A study of the terms, principles, and illustrations given in this section will enable you to understand how to use your rifle to the best advantage in combat.

219. TRAJECTORY

a. Trajectory is the path of a bullet in its flight through the air. The bullet of M2 armor-piercing ammunition leaves the muzzle of your rifle at 2800 feet per second (muzzle velocity). At this great speed, the trajectory is almost flat at short ranges. However, as the range increases, the height of the trajectory increases (fig. 105).

b. The space between the rifle and the target, in which the trajectory does not rise above a man of average height, is called the *danger space* (fig.

(H = MAXIMUM ORDINATE - HIGHEST POINT OF TRAJECTORY)

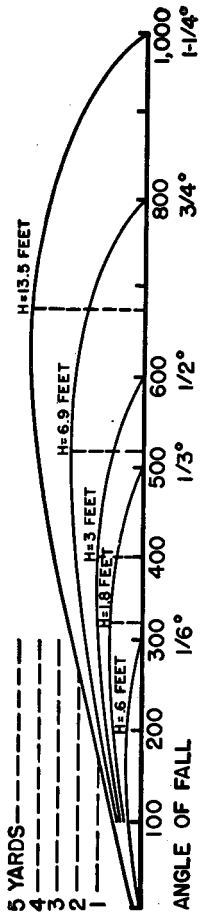

ANGLE OF ONE DEGREE (1°) IS

DANGER SPACES

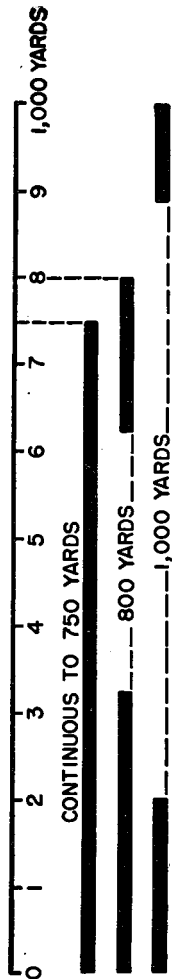

Figure 105. Trajectory diagram.

105). A bullet fired from the rifle or automatic rifle at ground level (prone position) and at a target 750 yards away will not rise more than 68 inches above the ground, providing the ground is level or slopes uniformly. A man of average height standing on the gun-target line would be hit by the bullet; therefore, the entire 750 yards is *danger space*. At ranges greater than 750 yards, only parts of the space between the gun and the target will be *danger space* because the trajectory of the bullet will rise above the head of a man of average height.

220. CONE OF FIRE

Each bullet fired from the M1 rifle or the automatic rifle follows a slightly different path or trajectory through the air. The small differences in trajectories are caused by slight variations in aiming, holding, squeezing, the powder charges, or the wind and atmosphere. As the bullets leave the muzzle of the weapon, their trajectories form a cone shaped figure known as the *cone of fire* (fig. 106).

221. BEATEN ZONE

The area on the ground in which the bullets of the cone of fire strike is called the beaten zone. The cone of fire striking a horizontal target forms a beaten zone which is long and narrow in shape. Because of the variation in the degree of flatness of trajectories at different ranges, the beaten zones on horizontal targets vary in length from 100 yards at long ranges to 400 yards at

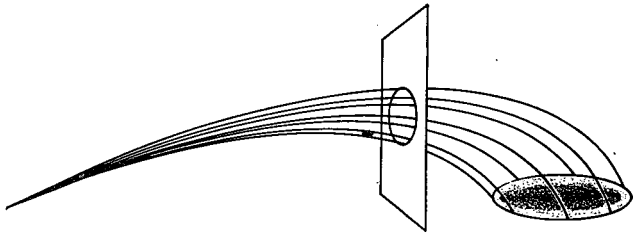

Figure 106. The cone of fire.

short ranges. The slope of the ground affects the size and shape of the beaten zone. Rising ground shortens the beaten zone; ground sloping downward at an angle less than the curve of the trajectories lengthens it. Ground that falls off at an angle greater than the fall of the bullets will not be hit and is said to be in defilade.

222. CLASSES OF FIRE

Rifle and automatic rifle fire is classified both with respect to the target (direction) and with respect to the ground.

a. Fire with respect to the target (fig. 107) is—

- (1) *Frontal fire* when it is delivered at right angles to the front of a target.
- (2) *Flanking fire* when it is delivered against the flank of a target.
- (3) *Oblique fire* when it is delivered so that the long axis of the beaten zone is at an oblique to the long axis of the target.
- (4) *Enfilade fire* when it is delivered so that the long axis of the beaten zone coin-

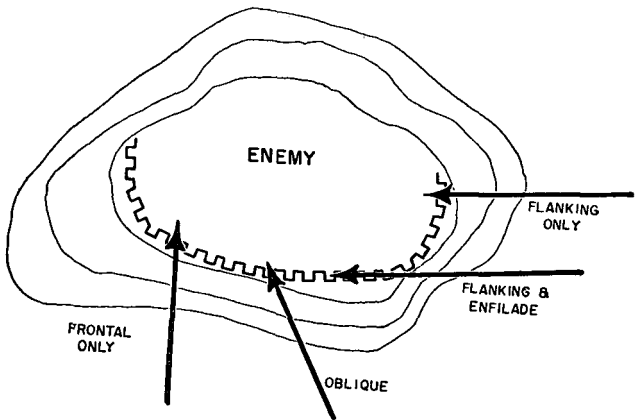

Figure 107. Classes of fire with respect to the target (direction).

cides or nearly coincides with the long axis of the target. Enfilade fire may be either flanking or frontal.

b. Fire with respect to the ground is—

- (1) *Grazing* when the bullets do not rise above the height of a man standing. Rifle and automatic rifle fire from the prone position may provide grazing fire at ranges up to 750 yards over level or uniformly sloping ground.
- (2) *Plunging* when the bullets strike the ground at a high angle, so that the danger space is practically confined to the beaten zone and the length of the beaten zone is materially shortened (fig. 108). Fire at longer ranges becomes increas-

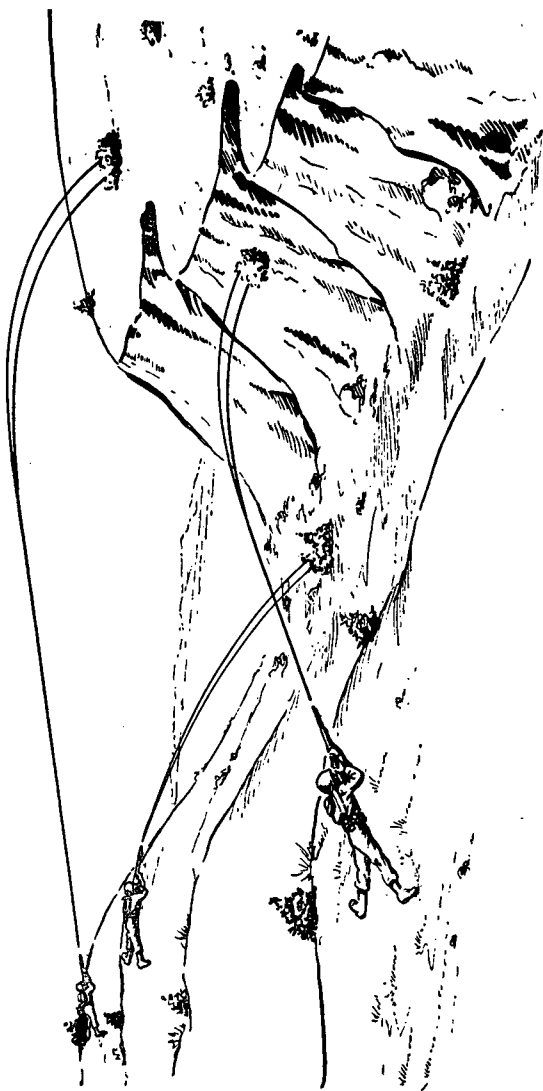

Figure 108. Plunging fire.

ingly plunging because the angle of fall of the bullets becomes greater. Fire from high ground to a target on low ground may be plunging fire. Firing into abruptly rising ground will result in plunging fire at the point of impact.

- (3) *Overhead* when it is delivered over the heads of friendly troops. Rifle and automatic rifle fire is considered safe when the ground offers protection to the friendly troops to the front or if they are in position at a sufficient distance below the line of fire. Its use in any particular case depends on necessity and good judgment.

223. EFFECT OF RIFLE AND AUTOMATIC RIFLE FIRE

a. The most decisive results from rifle and automatic rifle fire are obtained when your squad is close to the enemy. Your unit will use cover and concealment offered by the terrain and will take advantage of the supporting fires of machine guns, mortars, and artillery to advance as near to the enemy as possible before opening fire. Normally, you should not open fire at ranges greater than 500 yards, which is the maximum effective range of your rifle.

b. Under favorable conditions, the automatic rifle may be used against enemy groups or enemy areas at ranges between 500 yards and 1,000 yards.

c. The automatic rifle can be used effectively against a sniper concealed in a tree by firing a sustained burst, sweeping up and down the tree.

d. The fire of the rifle squad can be effective against appropriate vehicle and aerial targets as discussed in paragraph 204-212.

e. Enemy positions are likely to be concealed and difficult to locate exactly. However, the area in which the enemy is located can usually be determined by the sound of his firing. Men may distribute continuous fire in width and depth to cover an entire area, causing the enemy to keep his head down and making his fire ineffective. When covering an area by fire, each rifleman should aim each shot at a likely firing position: a bush, a rock, a stump, a patch of grass, or a fold in the ground.

f. Ricochets are effective if they strike a man shortly after glancing from the ground. Therefore, if there is a question whether to fire short of the target or over it, fire short.

Section IV. FIRE COMMANDS

224. IMPORTANCE AND PURPOSE

To be effective, the collective fire of your squad must neutralize the enemy's fire. Enemy troops will be trained in the use of cover and concealment. Therefore, your targets will be indistinct, rarely exposed, and often invisible to the naked eye. When a target is discovered, leaders and squad members must clearly define its location and nature. Squad members must be trained to

identify the target area quickly and accurately and to place a heavy volume of fire on it even though no enemy personnel are visible. A small point target like an enemy sniper might be assigned to only one or two riflemen, while a target of considerable width like an enemy skirmish line requires the combined fire of the entire squad. The rifle squad leader, having made a decision to fire on a target, gives certain instructions as to how the target is to be engaged. These instructions form the fire command by which he directs and controls the fire of his squad.

225. ELEMENTS

A fire command contains six basic elements that are always announced or implied. Fire commands for all weapons follow a similar order and include similar elements. Only essential elements are included. The six elements are—

- Alert.
- Direction.
- Target description.
- Range.
- Target assignment.
- Fire control.

a. Alert. This element brings the unit to a state of readiness to receive further information. It may also tell who is to fire. Usually it is the command SQUAD; it may be the command AR or RIFLEMEN. However, the leader may alert only a few individuals by calling to them by name or by number.

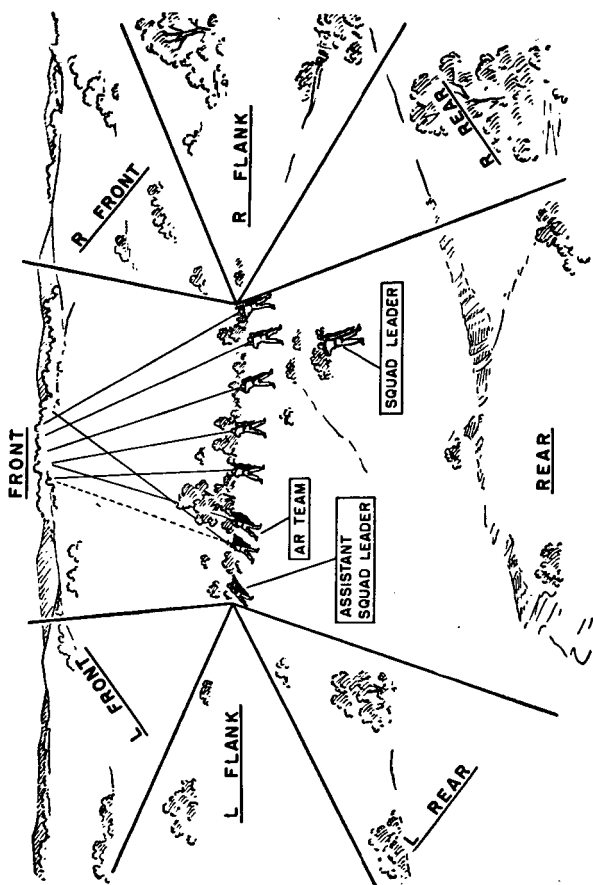

Figure 109. Fire command—general direction.

b. *Direction.*

(1) The direction element tells you which way to look to see the target. This may be given in one, or in a combination, of the following ways:

(a) *Orally.* General directions to the target may be given orally and should tell the relationship between the target and the unit as it is deployed. Figure 109 shows the general directions which may be expressed as FRONT, RIGHT FRONT, LEFT FRONT, RIGHT FLANK, LEFT FLANK, RIGHT REAR, LEFT REAR, REAR.

(b) *Pointing.* Direction may be shown by pointing with the arm or the rifle. When you desire to show directions to individuals, the following methods may be used:

1. Use the arm to point toward the target so that a rifleman standing behind you can look over your shoulder and along your arm and index finger to establish a correct line of sight.
2. To use the rifle to point, put it to your shoulder, cant it to the right, and aim at the target. Move your head to the left without disturbing the rifle so that the men to the rear can move up and look through the rear sight to observe the same sight picture and locate the target.
3. Time permitting, use a rifle rest. A

bayonet stuck into the ground at an angle, a log, or a tree crotch will keep the rifle in place. Once sighted on the target, a number of men can take position behind the weapon and locate the target. The automatic rifle with its bipod can be effectively used in this manner.

4. Tracer ammunition is a quick and sure method of indicating the direction to an indistinct target and is most accurate for pinpointing the flanks of an obscure linear target. When possible, the general direction is given orally to direct the squad's attention to the desired area, for example,

FRONT—WATCH MY
TRACER

(fire 1st round)—RIGHT
FLANK

(fire 2d round)—LEFT FLANK

Firing tracer ammunition to designate targets has limitations. It may disclose your position, and in any event, will make known your presence and lessen the surprise effect of a sudden burst of fire on the enemy position.

(2) Reference points.

- (a) To help the member of the squad locate invisible or indistinct targets, the

squad leader may use reference points to give the direction to the target. He selects a reference point that is near the target and one which is easy to recognize.

Example — Bridge, stone house, church steeple, windmill.

- (b) Terrain features may also be used as reference points. You should be familiar with the names of common terrain features such as — crossroads, road junction, road fork, cut, fill, draw, ravine, bluff, hill, ridge crest, military crest, skyline. (FM 21-25.)
- (c) When using a reference point, use the word REFERENCE in describing the reference point and the word TARGET in describing the target. This is done to show the difference between the two objects. Example—

FRONT

REFERENCE: BUSHY PINE
IN DRAW

TARGET: SNIPER IN
FIRST BUSH
TO THE
RIGHT

LEFT FRONT

REFERENCE: MOUND OF
DIRT IN
BARNYARD
AT A LESS-
ER RANGE

TARGET: M A C H I N E
G U N

FRONT

REFERENCE: ROAD JUNC-
TION; TO
THE RIGHT
OF ROAD
JUNCTION,
CORNER OF
ORCHARD

TARGET: M A C H I N E
G U N.

- (d) In using a reference point always give the direction to the reference point and the range to the target.
- (e) Sometimes a target can best be located by using successive reference points. For example—

LEFT FRONT

REFERENCE: STONEHOUSE.
RIGHT OF
S T O N E
H O U S E ,
S M A L L
B A R N .

TARGET: M A C H I N E
G U N I N
FIRST HAY-
S T A C K
RIGHT OF
B A R N

(3) Finger Measurement.

- (a) Distances across your front, known as lateral distances, are difficult to esti-

mate in terms of feet or yards. To measure the distance right or left of a reference point to a target or to measure the width of a target from one flank to another, finger measurements may be used.

(b) The method of using finger measurements is as follows:

1. Hold your hand at arms length, palm to the rear, index finger pointing upward.
2. Close one eye.
3. Sight along the sides of the finger so that one edge is on the reference point or starting point. Note where the sight over the other side of the finger strikes the ground or target. This is the measurement for *one finger*.
4. For two-finger measurement, hold up the index and middle finger. For three-finger measurement, hold up three fingers, etc.

(c) Examples of use of finger measurements—

REFERENCE:	L O N E P I N E
	T R E E R I G H T
	O N E F I N G E R
TARGET:	M A C H I N E
	G U N I N
	S M A L L
	B U S H

REFERENCE: CROSS ROAD
TARGET: LINE OF
RIFLEMEN
EXTEND-
ING FROM
CROSSROAD
RIGHT
THREE
FINGERS

c. Target Description. The third element of the fire command is a brief and accurate description of the target. You may have a target that extends in depth, or you may have a point, linear, oblique target. Examples of such target descriptions are—SNIPER, MACHINE GUN, LINE OF RIFLEMEN, COLUMN OF RIFLEMEN, TRUCK, MORTAR POSITION.

d. Range. Range, given in yards, tells you how far to look to see the target. It also gives you the information you need to set your sight or to adjust your point of aim with the battle sight. The word RANGE will not be used; it is expressed merely as ONE SEVEN FIVE, TWO FIVE ZERO, or THREE HUNDRED.

e. Target Assignment. The assignment element tells who is to fire on the target. Frequently, the *who* has been announced in the alert element. If this is the case, the target assignment element will be omitted. It is not necessary to repeat information already announced. When the leader intends to alert the entire squad, but plans to use only part of the squad's fire on a target, the target assignment element is included. Examples of

target assignments—RIFLEMEN; AR; JONES AND SMITH; or NOS. 3 AND 4.

f. Fire Control. The fire control element consists of a command or signal to open fire. If surprise fire is not required, the command COMMENCE FIRING normally is given without a pause as the last element of the fire command. If the leader wants all his weapons to open fire at once in order to obtain the maximum surprise and shock effect, he prefaces the command or signal to commence firing by the words, AT MY COMMAND or AT MY SIGNAL. When all the men are ready, the leader gives the command or signal: COMMENCE FIRING. Examples—AR, ONE MAGAZINE, COMMENCE FIRING; AR, ONE MAGAZINE, SHORT BURSTS, COMMENCE FIRING; SQUAD, ONE CLIP, AT MY SIGNAL—(Signal, COMMENCE FIRING).

226. SIGNALS

Since oral commands are likely to be difficult to be heard on the battlefield, it is essential that the squad fully understand all appropriate signals. These signals must be used constantly in training. Improvised signals may be arranged for use under special situations. Signals applicable to fire commands are described in FM 7-10.

227. EXAMPLES

Examples of complete fire commands follow:

a. In this example, the leader desires to place the fire of his entire squad on an easily recognized target.

SQUAD
FRONT
TROOPS
FOUR HUNDRED
COMMENCE FIRING

b. In this example the leader desires to designate the target to his entire squad, but wants only the automatic rifle team to engage it. Because the target is indistinct, he uses a reference point.

SQUAD
FRONT
REFERENCE: RED BARN, RIGHT TWO
FINGERS
TARGET: MACHINE GUN
FOUR FIVE ZERO
AR
COMMENCE FIRING

c. In this example it is assumed that the squad is engaging a target and the squad leader desires to shift the fire of his riflemen to a new target. He does not interrupt the firing of the AR team.

RIFLEMEN
LEFT FLANK
REFERENCE: ROAD JUNCTION
TARGET: RIFLEMEN; EXTENDING
RIGHT THREE FINGERS
THREE FIVE ZERO
COMMENCE FIRING

Section V. APPLICATION OF FIRE BY THE RIFLE SQUAD

228. ORGANIZATION OF RIFLE SQUAD

a. The rifle squad consists of a squad leader, No. 1; five riflemen, Nos. 2, 3, 4, 5, and 6; an automatic rifleman, No. 7; an assistant automatic rifleman, No. 8; and an assistant squad leader, No. 9. The automatic rifleman and his assistant, Nos. 7 and 8, are referred to as the AR team.

b. The squad leader is responsible for the discipline, training, control, and conduct of his squad. His squad is trained to use and care for its weapons and equipment, to move and fight efficiently as individuals, and to function effectively as part of the fighting team.

c. The assistant squad leader performs duties assigned by the squad leader and takes command of the squad in his absence. The assistant squad leader usually controls the automatic rifle team.

229. TACTICAL EMPLOYMENT

a. *Application of Fire for the Attack.* The squad has two general means of action—fire and movement. Fire, movement, assault fire, and close-in fighting are combined in the attack by the squad. The squad and smaller groups must be trained to place a large volume of accurate fire upon visible enemy targets, probable enemy locations, and indistinct or concealed targets such as enemy machine guns or small groups of enemy soldiers. The squad and smaller groups must be trained to apply fire quickly on the order or signal of its leader and, in appropriate circum-

stances, to apply it without an order. The squad leader's primary job during a fire fight is to place effective fire of his squad on the target. In doing this, he keeps in mind the fire power of the automatic rifle team which he uses to place automatic fire on suitable enemy targets such as surprise targets, crew served weapons, or automatic weapons and to support the advance of the other members of his squad. He selects positions for the automatic rifleman from which he can deliver effective fire on any target holding up the remainder of the squad and from which the automatic rifle can fire across the entire squad front. He usually selects a position with the best field of fire; however, tactical or terrain considerations may require that fields of fire be given secondary consideration.

b. Application of Fire for the Defense. In the defense, the fire of a small rifle unit such as a squad is delivered by small groups and individuals from positions which they must hold. Each soldier's firing position is selected so that he has a good field of fire and can take advantage of cover and concealment. The rifle unit can also be used to place grazing fire along predetermined lines to stop an assault. These lines are called final protective lines (FPL). In defensive situations, the possibility of such use should be considered in selecting positions for the riflemen.

c. Application of Fire by the Automatic Rifle Team.

- (1) The automatic rifleman and his assistant work together as a team and alternate

duties during training so that each knows all the duties of the other.

- (2) The automatic rifleman performs the following duties during a fire fight:
 - (a) Receives orders from his squad leader or the assistant squad leader.
 - (b) Takes position and fires on designated targets and other targets that present themselves.
 - (c) Watches for ways to help the advance of the squad by the use of the fire-power of his weapon.
- (3) The assistant automatic rifleman performs the following duties during a fire fight:
 - (a) Selects a position where he can assist the automatic rifleman.
 - (b) Aids the automatic rifleman in adjusting his fire on the target.
 - (c) Transmits orders or signals from the squad leader or assistant squad leader to the automatic rifleman.
 - (d) Watches for new targets.
 - (e) Helps the automatic rifleman to reduce stoppages.
 - (f) Replaces the automatic rifleman if he becomes a casualty.
 - (g) Helps to carry ammunition for the automatic rifle.
 - (h) Participates in the fire fight with his rifle when necessary.

230. METHODS OF APPLYING SQUAD FIRE

a. In combat, the size and nature of a target may call for the fire power of the entire squad or only certain parts of it or of the entire platoon. Fire may be directed at a point or distributed along a line or over an area.

b. Concentrated fire is a term applied to a heavy volume of fire directed at a single point. It is used for knocking out machine guns, other automatic weapons, or enemy concentrations.

c. Distributed fire is a term applied to fire distributed in width so that a wide target can be effectively covered. The rifle squad uses the following method of fire distribution:

- (1) Each rifleman fires his first shot on that portion of the target corresponding generally to his position in the squad (or platoon, if the platoon fires as a unit). He then distributes his remaining shots to the right and left of his first shot, covering that part of the target where he can deliver accurate fire without changing his position. The portion of the target which each rifleman can cover will depend on the range to the target and on his firing position. In some cases, each rifleman will be able to cover the entire target with accurate fire. Fire is not limited to points known to contain an enemy, but is also directed to points which may hide an enemy, a bush, around a tree, a fold in the ground. The flank riflemen are taught to fire beyond

the flanks of the target as designated to insure that both flanks are covered or that the fires of more than one squad overlap. Fire is distributed in this way without command (fig. 110).

- (2) The automatic rifleman distributes his fire over the entire target area, or on any specific target where his fire will best support the advance of the squad.
- (3) Should other targets appear while the squad (or platoon) is employing this method of fire distribution, the squad (or platoon) leader announces necessary changes in the target assignment.

d. Area fire is fire that is distributed in depth as well as width. It is effective in smothering and neutralizing an area. In area fire, each rifleman distributes his fire laterally in the same manner as in distributed fire. In addition, he must distribute his fire in depth. The automatic rifleman distributes his fire at likely targets over the entire area (fig. 111).

e. Assault fire is the violent and heavy fire by assault elements as they close on the enemy at close range. Its purpose is not only to kill or wound the enemy but also to terrify and demoralize him. It keeps the enemy deep in his hole where the shock effect of the supporting fires put him—hugging the ground with his weapon idle—or it forces him into a hurried and disorderly retreat. When assaulting troops reach the assault position, usually from 100 to 150 yards, they are deployed as skirmishers and advance at a rapid walk

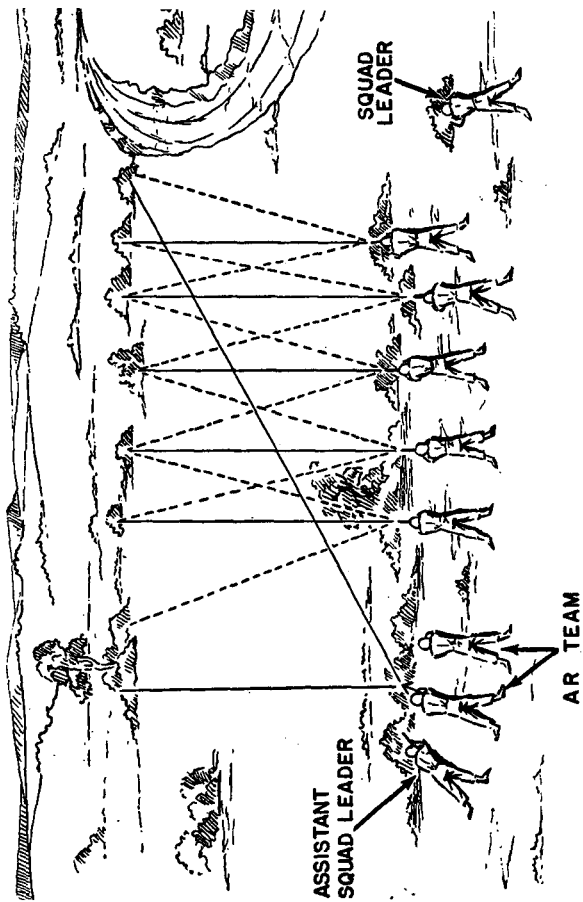

Figure 110. Squad fire distribution on a wide target.

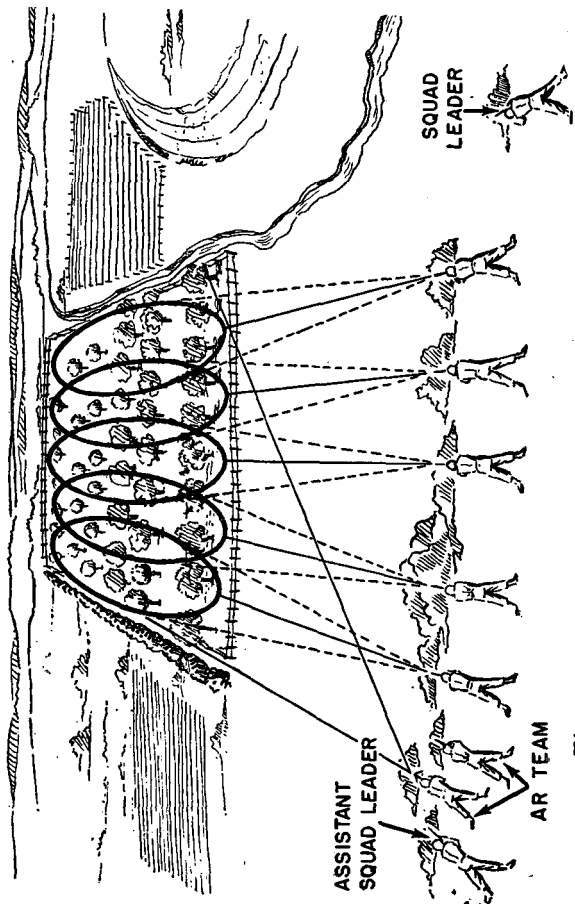

Figure 111. Squad fire distribution on an area target.

toward the objective. The riflemen, with bayonets fixed, deliver a heavy volume of fire, firing every two or three steps from either the shoulder or hip. The automatic rifleman carries the automatic rifle slung over his left shoulder and delivers fire from the hip or crouch position. The assistant automatic rifleman does not fire but assists the automatic rifleman. The squad leader and assistant squad leader seldom fire but take positions in rear of the squad to enforce the continuity of fires and to control the alinement of the men.

231. RATE OF FIRE

The maximum rate at which any rifleman should fire the M1 rifle is determined by his ability to align the sights and squeeze off accurate shots. To exceed this rate is a waste of ammunition. The first few rounds, particularly in the case of surprise fire, should be delivered at the maximum rate in order to pin the enemy to the ground. Thereafter, it should be slowed down to a rate which is just sufficient to maintain fire superiority. This conserves ammunition and allows for adjustment of the fire by the squad leader.

232. FIRE DISCIPLINE

a. Fire discipline is the efficiency with which troops deliver effective fire on designated targets at the commands of their leader. Fire discipline in the rifle squad is achieved through training in the use of weapons and the exact execution of

orders. It requires skill in sight setting, aiming, and trigger squeeze, and close attention to the squad leader and assistant squad leader for signals or orders. Training in fire discipline cannot be completed during the brief period devoted to technique of fire; it starts with the soldier's first drill and continues throughout his military career.

b. Fire discipline also includes the correct response of each member of a unit to emergencies and surprise targets. If the leader becomes a casualty, it is essential that one of the group assume leadership and carry out the assigned mission or that he attach the group to the nearest organized unit. A soldier separated from his squad fights on his own initiative only when he has reason to believe that his singlehanded effort will accomplish some important result; otherwise, he reports to the nearest leader at once. This type of discipline is the result of interchanging squad positions and responsibilities during training.

233. FIRE CONTROL

a. Fire control is the name applied to all operations connected with the planning, preparation, and actual application of fire on a target. The degree of fire control exercised may vary from carefully thought out plans and arrangements to a simple signal by the squad (or platoon) leader. The assistant squad leader assists the squad leader in maintaining control.

b. During a fire fight, a squad leader takes a

position where he can best control his squad. At times the squad leader moves from man to man and personally directs each man's fire to make sure that everyone is firing on the correct target. On orders from his platoon leader, or on his own initiative, he shifts the fire of all or part of his squad to new targets.

c. The irregular formations used for an advance will make control by the squad leader difficult at times. Under these conditions, fire must be opened and maintained on the initiative of individual riflemen as circumstances require. However, the squad leader should seek to gain full control of the fire of his men at the first opportunity.

d. When the platoon is used as the fire unit, the method of fire distribution is basically the same as that used by the squad. The platoon objective (target) is broken down into areas of squad responsibility. The fire of the weapons squad of the platoon is used in much the same manner as the fire of the AR team is used within the rifle squad in that its fire is used to cover all of the platoon target area. The platoon leader controls the fire of the platoon by signals to or direct contact with the squad leaders.

234. LOW VISIBILITY FIRING

a. During night or periods of low visibility and when there is a shortage of automatic weapons, the rifle can be used to deliver fixed grazing fire by using rests for the rifle.

b. When the rifle is to be used for this purpose, the following must be done in daylight.

- (1) Rests are made from any material available for the front hand guard and stock at a point immediately in front of the trigger guard (fig. 112).
- (2) The rifle is placed on the rests and zeroed to hit the desired point. The rests are adjusted so that when the rifle is placed in them it will be pointing in the desired direction and will hold the rifle at the desired elevation.

c. To fire from the rest, the rifleman places his rifle on the rest and takes a prone position with his right shoulder firmly against the butt, his left hand pressing down firmly on the front hand guard, his right hand at the small of the stock. He can deliver fire along the final protective line or at the point target as rapidly as he can manipulate the trigger. He must hold the rifle in the rest in the exact position in which it was held when it was sighted in.

d. By using additional notched stakes, the firer can sight his rifle for use against more than one point (fig. 113).

e. The automatic rifle can be used in a similar manner by use of the bipod and a rest for the trigger guard.

f. For training purposes, firing should be done at night or the rifleman should be blindfolded. This gives him practice in handling the rifle by feel rather than by sight.

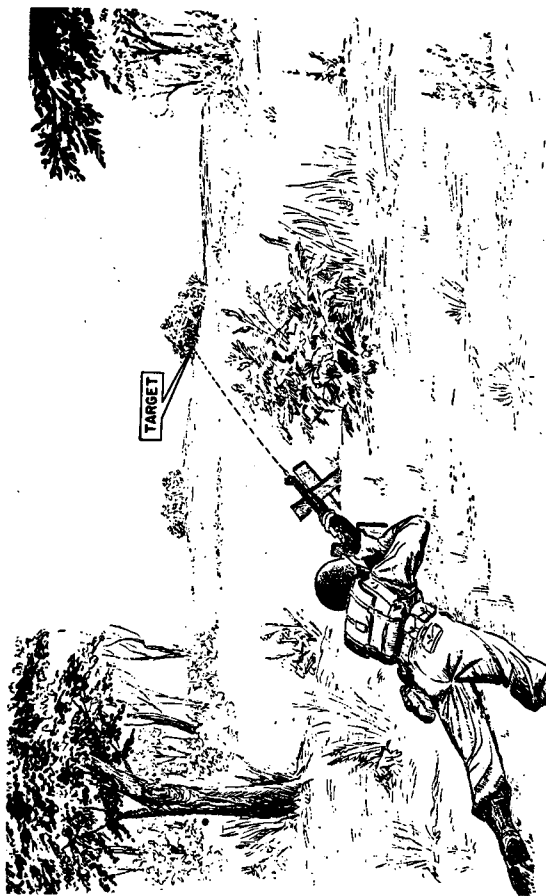

Figure 112. A rifleman using rests to deliver fixed fire on a predetermined point during low visibility.

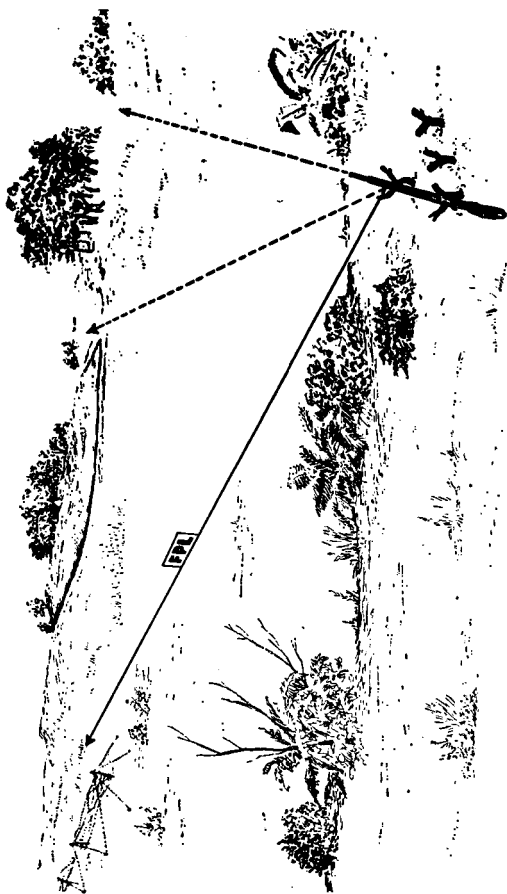

Figure 113. A diagram showing rifle rests for the M1 rifle used in delivering grazing or fixed fire during low visibility.

Section VI. LANDSCAPE TARGET FIRING

235. SCOPE AND ADVANTAGES

a. Landscape target firing is conducted on a 1,000-inch range, firing at panels which contain a picture of a landscape as it might appear to a squad in combat.

b. After you have been trained in the first four steps of the technique of rifle fire, you are ready for training in landscape target firing.

c. Some advantages of landscape target firing are—

- (1) It permits close supervision of all members of the firing unit.
- (2) It clearly and quickly demonstrates the application and effect of fire.
- (3) Advantageous training can be accomplished in a limited area and without the need of personnel to operate targets, telephones, etc.
- (4) It can be conducted indoors when lack of outdoor facilities or when weather conditions make this desirable.

d. Landscape target firing should not be considered a substitute for field target firing but rather a step before and in preparation for field-target firing. Before engaging in field target firing, each squad should receive training in landscape target firing.

236. DESCRIPTION OF LANDSCAPE TARGET

a. General. A landscape target, which is a panoramic picture of a landscape, is drawn so

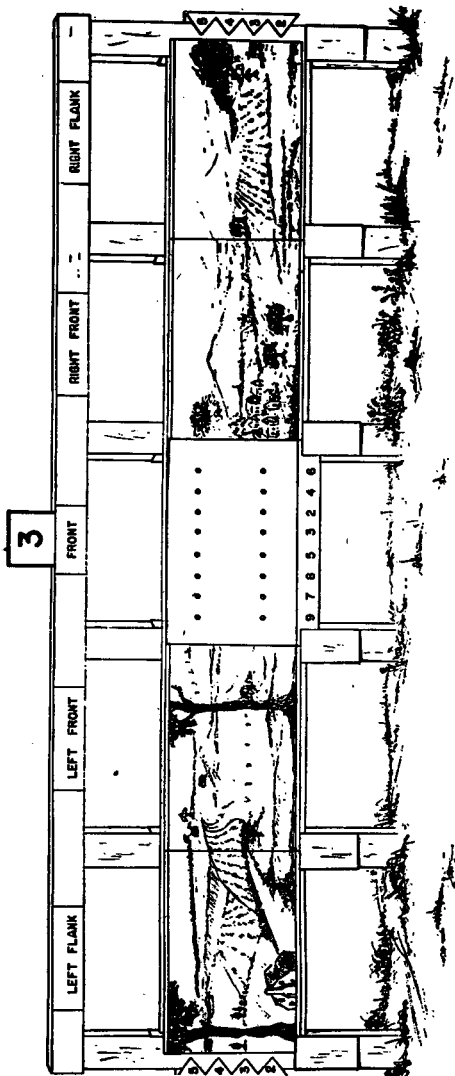

Figure 114. A landscape target.

that all or nearly all of the features are recognizable at a distance of 1,000 inches. The standard target is the series A target of five sheets in black and white.

b. Range Indicators. To designate the targets, assumed ranges are used on landscape targets. Small cards painted with appropriate numbers representing yards of range are tacked along one or both edges of a series of panels (fig. 114). The firer must remember that the range announced is a simulated range designation and that the zero sight setting on his rifle must not be changed.

c. Direction Indicators. To provide the direction element in oral fire commands, small cards on which are painted "front," "right front," "left front," "right flank," "left flank" are tacked above the appropriate panels of the landscape series (fig. 114).

237. WEAPONS TO BE USED

Indoor firing at landscape targets should be conducted with caliber .22 rifles. The M1 rifle, the automatic rifle, or the caliber .22 rifle may be used on an outdoor range.

238. ZEROING OF RIFLES

a. Rifles used in landscape target firing exercises are zeroed for 1,000 inches. A blank target with a row of eight 1-inch-square black pasters is used for this purpose. The black pasters are placed 6 inches from, and parallel to, the bottom of the blank panel (fig. 114). Beneath the zero-

ing panel are numbers which correspond to the firers' positions on the firing line (9-7-8-5-3-2-4-6, indicating a squad deployed with the AR team to the left). Other types of deployment may be used.

b. The procedure follows:

- (1) Rifle sights are blacked.
- (2) The squad is deployed on the firing line in the same order that the numbers appear on the zero panel; the squad leader takes his position behind the squad.
- (3) The instructor requires each rifleman to set his sights at 200 yards elevation and zero windage, or at zero elevation and zero windage for the caliber .22 rifles. The sight setting for the automatic rifle is minimum elevation and zero windage.
- (4) For an aiming point, each man is assigned a spotter.
- (5) Three rounds are issued to each man on the firing point. These rounds are loaded and fired singly, at the command of the instructor, or are loaded as a partial clip of three rounds (par. 39).
- (6) At the command **THREE ROUNDS, COMMENCE FIRING**, each man fires three shots at his paster.
- (7) The instructor commands — **CEASE FIRING, UNLOAD, CLEAR RIFLES**. The squad leader checks to see that the rifles are clear (par. 42).
- (8) The instructor and the squad leader in-

spect the target and, judging from the location of the center of impact of the shot group, give each man the necessary correction for his next shot. They give the correction in terms of clicks. At 1,000 inches, one click of windage or elevation will move the strike of the bullet one-fourth inch.

- (9) The firing continues as outlined above until each rifle is zeroed. The firing of three shot groups should be sufficient to determine the zero.

239. SCORING AND SCORING DEVICES

a. Point Targets.

- (1) A suitable template for scoring point targets can be constructed from celluloid, cardboard, or similar material. The inner rectangle of the template should be $2\frac{1}{2}$ inches high by 2 inches wide, while the outer rectangle should be 5 inches high by 4 inches wide. The template is shown in the insert on figure 115. (It has been found that in firing at a point target at a range of 1,000 inches, 75 percent of the rounds fired will normally hit this target in an area that can be covered by a 4-inch x 5-inch rectangle. At the same time, it was found that 50 percent of the total rounds will hit in an area that can be covered by a 2-inch x $2\frac{1}{2}$ -inch rectangle.) The inner rectangular area is known as the

50 percent zone. The outer rectangular area is known as the 75 percent zone. Each hit in the 50 percent zone counts 2 points. Each hit in the 75 percent zone counts 1 point. Hits cutting or touching the line count where they have the most value.

- (2) The template is placed on the panel with the center of the target exactly centered within the 50 percent zone, and the scoring space is then lightly outlined in pencil. Do not make the marks plain enough to be seen from the firing point. Marking is done before the problems are fired to avoid any tendency to place the template on the shot group so as to receive the maximum score (fig. 115).
- (3) All problems are fired on the basis of 50 rounds per problem. Possible score for any problem is 100. One point target may be designated for the AR team (25 rounds) and a separate point target for the rifleman (25 rounds).

b. Linear Targets.

- (1) The template for scoring linear targets can also be constructed of material similar to that recommended for the point target template. Here, as with point targets, the template outline should be drawn in very lightly before the problem is fired. The insert on figure 116 shows a drawing of the template outline. The 50 percent zone consists of

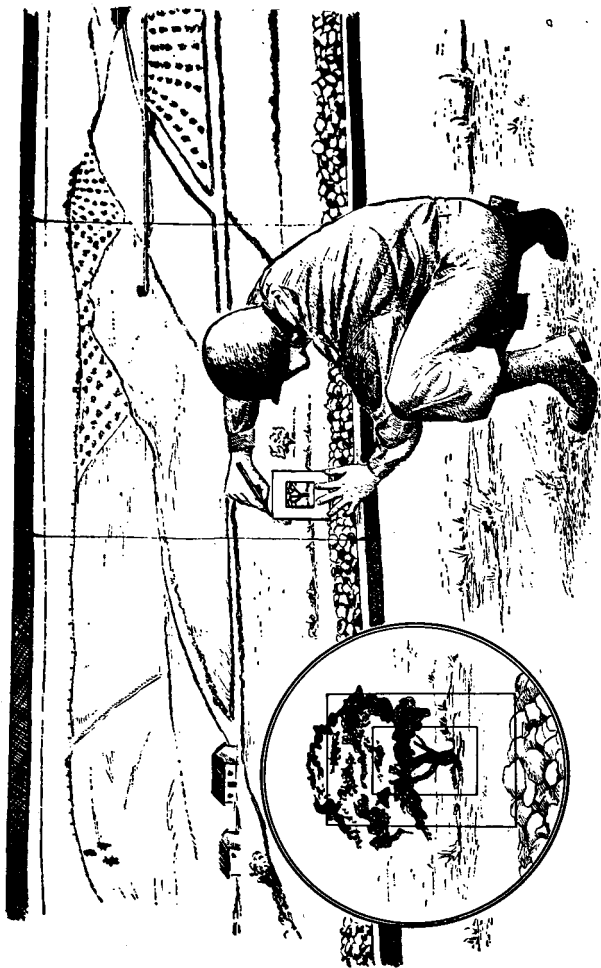

Figure 115. Lining in a scoring area (point target) with the scoring template.

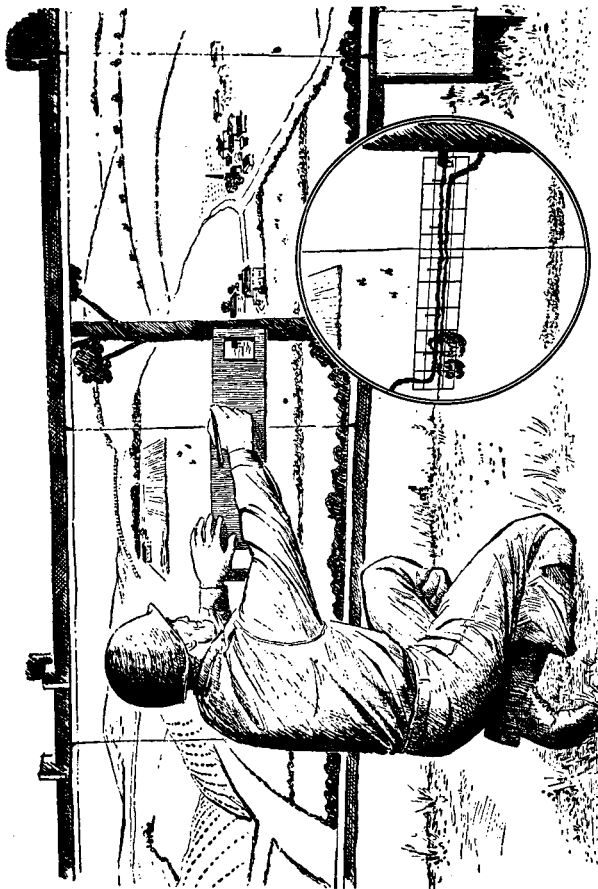

Figure 116. Lining in a scoring area (horizontal linear target) with scoring areas and distribution spaces.

two lines drawn $2\frac{1}{2}$ inches apart parallel to the longer axis of the target. Two additional lines, similarly drawn 5 inches apart above and below the 50 percent zone, constitute the 75 percent zone. Because riflemen and automatic riflemen are taught to distribute their fire beyond the known flanks of the enemy, the template is extended one inch beyond each flank of the target to give additional scoring space for proper fire distribution. The entire area is divided into ten equal parts regardless of the length of the target. These parts are known as distribution spaces (fig. 116).

- (2) Fifty rounds are fired per problem and a problem is scored as follows: Each hit in the 50 percent zone counts 2 points; each hit in the 75 percent zone counts 1 point. The value of each fire distribution space hit at least 3 times is 10 points.
 - (a) No more than 5 hits in any fire distribution space may be counted in the score.
 - (b) The distribution score plus the score for hits divided by 2 is the score for the problem. A total of 100 is a perfect score.

240. PROCEDURE FOR CONDUCTING PROBLEMS

The following procedure is used for conducting firing exercises:

a. All members of the squad except the squad leader face to the rear.

b. The instructor takes the squad leader to the panels and points out the target to him. They return to the firing line; the squad leader takes charge of the squad and has the men resume their firing positions.

c. The squad leader gives the command **LOAD**, and then gives his complete oral fire command. For the first one or two problems it is advisable for the squad leader to give his fire commands without having the rifles loaded. After giving his fire command, the squad leader questions the individual members of the squad as to where they are going to aim their various shots. By doing this the squad leader can find out if every member understands the fire command and the correct method of fire distribution.

d. The squad engages the target with fire.

e. The squad leader commands **CEASE FIRING, UNLOAD, CLEAR RIFLES** and checks to see that all rifles are clear.

f. The squad leader holds a critique immediately after each problem is fired. This score is recorded and posted for comparison and competition with the scores of other squads.

g. Suggested distribution of ammunition is as follows:

(1) When the automatic rifle is used, five rounds are issued to each member of the squad except No. 7 who gets 15 rounds (3 magazines of five rounds each).

(2) When no automatic rifle is used, five

rounds are issued to each of the riflemen, nine rounds to No. 7, eight rounds each to Nos. 8 and 9.

Section VII. FIELD TARGET FIRING

241. SCOPE OF TRAINING

The training in this phase is similar to that which you received in landscape target firing but with the added features of the use of cover and concealment, range determination, firing the rifle and the automatic rifle with live ammunition at field targets at unknown ranges, and fire control under more difficult conditions. Training must be progressive. You will first be given an opportunity to fire at targets that are more or less exposed, followed by fire at targets which are concealed from view but exposed to fire.

242. GENERAL CONSIDERATIONS

a. Progressive Training. Training in moving from an approach march formation or a covered area to firing positions is included under the field target firing phase of training for the following purposes:

- (1) To teach the soldier the use of cover and concealment and how to select firing positions.
- (2) To combine the technique of applying and controlling collective fire with patrolling and other related subjects.

b. Firing Positions and Representation of the Enemy. In battle, no unit, friend or enemy, deploys with troops evenly abreast and at regular

intervals apart. The selection of individual and group positions is governed by the field of fire, cover or concealment while firing, covered routes of approach to those positions, fire control, and the nature of the target. Therefore, in field target training, squad (platoon) firing positions and targets representing the enemy should conform to irregular battle formations.

c. Use of Cover.

- (1) The use of available cover is important because the man who neglects the use of cover will unnecessarily disclose his or his squad's position.
- (2) The individual use of cover and concealment is taught in FM 21-75. The principles outlined in that manual should be followed during training in firing at field targets.
- (3) In seeking covered and concealed firing positions, you must avoid those places which mask the fire of others or where your fire may be dangerous to other men of your unit. Also, if it is likely that the enemy will see you when you are moving into position, seek a covered or concealed route of approach which will permit you to fire from an undisclosed position.

d. Marksmanship Training Applied.

- (1) The principles of rifle and automatic rifle marksmanship training are followed in field target firing.
- (2) These principles should be applied in firing at field targets and in combat in a common sense way. It should be appre-

ciated that the conditions encountered in combat situations will differ from those found on the target range. In firing at field targets and in battle, the soldier takes advantage of trees, rocks, or any other rest which will make his fire more accurate. The positions prescribed in rifle marksmanship training are used whenever the ground will permit, but on rough ground it is often necessary to modify them in order to get a comfortable and steady position. To simulate actual battle conditions, some of the firing should be conducted with bayonets fixed and with grenade launchers attached.

e. Use of the Battle Sight. The battle sight is a sight setting of 300 yards. It is used on targets from 0 to 400 yards when you do not have time to make sight changes. Normally, keep the 300-yard setting on your sight because you can use it for any combat firing emergency.

243. CONDUCT OF EXERCISES

Exercises for firing at field targets should be suitable to the actual terrain upon which they are conducted. They should be repeated until all men have demonstrated their proficiency in firing. Some of the exercises should be fired with the gas mask adjusted. Hand and arm signals should be used frequently to control the action of the squad and for fire control.

a. Each exercise should be started when the unit (squad or platoon) is—

- (1) Already deployed in a firing position; or
- (2) Halted in approach march formation or in a place of concealment with its security element present in the formation, the unit either acting alone or as part of a larger force; or
- (3) Advancing in approach march formation with its own security.

b. Positions should be assumed as follows:

- (1) When the squads are halted with the security element present, and when practicable, squad leaders conduct their squads forward by covered and concealed routes and send the riflemen and the automatic rifleman to their firing positions by individual routes. Each man must try to occupy his firing position without exposing himself.
- (2) When the squad is advancing with the security element out, the security element is held up by either simulated or assumed enemy fire. The squad leader then deploys his squad in a suitable firing position on line with the security element. This will prevent having to withdraw the security element before the squad can open fire.

244. . CRITIQUE OF EXERCISES

On completion of each firing exercise, the instructor conducts a critique. A suggested list of

items to be covered during the critique follows:

a. Purpose of the problem.

b. Orders of the squad leader.

(1) Instructions in preparation for action—
check of equipment, ammunition, duties
of individuals, and special instructions.

(2) Orders for the action.

(3) Fire command (initial).

(4) Fire commands (subsequent).

c. Approach and occupation of the firing position.

(1) Method.

(2) Time taken (if time is a factor).

(3) Deployment.

d. Actions of individuals.

(1) Use of cover and concealment.

(2) Attention to orders.

(3) Looking to the leader for signals.

(4) Individual initiative.

e. Rate of fire.

(1) Initially rapid to pin the enemy to the ground.

(2) Controlled to conserve ammunition while retaining maximum effective fire on the enemy.

f. Fire control.

(1) Position.

(*a*) Initial position of the squad leader.

(*b*) Initial position of the assistant squad leader.

(*c*) Movement of leaders during firing.

(2) Methods used.

- (a) Signals.
 - (b) Oral orders.
 - (c) Use of assistant squad leader.
 - (d) Time required to shift fire to new targets.
- (3) Distribution of fire.
 - (4) Adjustment of fire.
 - (5) Teamwork developed.
- g. Effect of fire.
- (1) Were all targets fired on?
 - (2) Were all targets hit?
 - (3) Score.

Note. Only those items are discussed which apply to the exercise being critiqued.

245. TYPES OF EXERCISES

a. *Exercise No. 1.*

- (1) *Purpose.* Practice in fire commands, application of the fire of a squad in position, fire control, and individual concealment in the occupation of a firing position.
- (2) *Method.* The enemy is represented by one group of targets exposed to fire but partially concealed from view. The targets are indicated to the squad leader who formulates and issues his fire command. The members of the squad engage the targets and cease fire on command or signal from the squad leader.

b. *Exercise No. 2.*

- (1) *Purpose.* To give practice in deployment, individual concealment in the occupation

of the firing position, issuance of fire commands, application of the fire of a rifle squad on a linear target, fire control, and engagement of a surprise target.

- (2) *Method.* Silhouette targets representing a deployed enemy squad are partially concealed from view but exposed to fire. Initially, the squad is in a concealed position behind the firing positions. The squad leader (or a member of the security element) is shown the linear target. He then conducts the squad forward and disposes it in a concealed firing position. The squad leader gives his oral fire command and has the squad engage the target with fire. A surprise target representing an enemy machine gun appears shortly after the squad has engaged the linear target. The squad leader shifts a part of his squad fire to this surprise target.

c. *Exercise No. 3.*

- (1) *Purpose.* To give practice in having a target designated by the security element with tracer ammunition and to give practice in approaching and assuming a squad firing position.
- (2) *Method.* The squad is in the approach march with the security element well forward. When the security element reaches the firing position, they are fired on by an enemy group about 400 yards

to their front (burst of fire from a machine gun in a pit near the targets). They determine the range by firing on the target with tracers. The squad leader directs the remaining members of his squad into appropriate firing positions. The security element designates the target with tracer ammunition and the squad engages the target. When selecting and occupying their position, and when moving up, all men give special attention to the use of cover and concealment.

246. ADDITIONAL EXERCISES

Suggested subject matter for additional problems is listed below:

a. A situation to show the action of the security element, squad leader, and other members of the squad when the security element discovers a group of the enemy without being seen themselves.

b. A situation which requires the leader to use his automatic rifle team while keeping his riflemen under cover initially.

c. A situation which initially requires the use of either a part or all of the riflemen and which, later in the exercise, requires the use of the automatic rifle team against a surprise target.

247. RELATED TRAINING

Depending on the availability of time, range facilities, and ammunition, field target firing exercises should be extended to include tactical situa-

tions requiring actions and orders of platoon, squad, and assistant squad leaders. This type of training is referred to as *combat training exercises*. At the end of this training period, higher commanders conduct *platoon combat proficiency tests* to determine the proficiency of rifle platoons.

CHAPTER 6

ADVICE TO INSTRUCTORS

Section I. GENERAL

248. PURPOSE

The material contained in this chapter is advisory and should be considered as a guide only. It is not meant to limit your imagination, initiative, or the scope of your instruction.

249. ASSISTANT INSTRUCTORS

Train in advance as many noncommissioned officers and selected privates as are necessary to meet your requirements for use as demonstrators and assistant instructors. Rehearse these men carefully in the duties they are to perform so that when they present a demonstration it is correct in every detail and gives a clear picture of the work under discussion.

250. SUBJECT SCHEDULES

To aid in the individual training phase, a subject schedule for a course in rifle marksmanship training is shown in paragraphs 254–255, 282, 290, and 291. This schedule is based on the desirable number of training hours for a rifle course. Use it as a guide in preparing lesson plans. Conditions may require a longer or shorter period to complete the training. When time is available,

more training should be added to the subject schedule. This will help develop efficient and fully trained riflemen. When suggested references, equipment, and training aids are not available, improvise or substitute the best that are available. For men not assigned to a rifle unit, a familiarization subject schedule with accompanying training notes is included in this chapter. All references in the training schedule, unless otherwise noted, may be found in this manual.

251. TRAINING NOTES AND TRAINING PROGRAMS

a. To supplement the subject schedules and to provide the detailed procedure to be followed for each period, training notes are included. During training, reinforce your lectures with demonstrations. Teach at a speed that enables the men to grasp clearly the material presented. Allot most of the training time to applying the principles brought out in the lectures and demonstrations. For this practical work, organize the unit into small groups and place an assistant instructor in charge of each group.

b. The training program included in this section meets the requirements for training riflemen quickly and thoroughly in the basic essentials of rifle marksmanship. Use this program as a guide. When additional training hours are available, the program may be expanded to more adequately train the soldiers. For training purposes, an hour is considered to be 50 minutes except for range firing, when an hour is 60 minutes.

252. ALLOTMENT OF TRAINING HOURS FOR A RIFLE MARKSMANSHIP COURSE

<i>a.</i> Mechanical training	6 hours
<i>b.</i> Preparatory marksmanship training	24 hours
<i>c.</i> Range firing:	
(1) Instruction firing, 1,000-inch....	6 hours
(2) Instruction firing, known-distance	16 hours
(3) Record firing, known-distance..	8 hours
(4) Preliminary transition firing..	6 hours
(5) Transition instruction and record firing	12 hours
	—
Total	78 hours

253. ALLOTMENT OF TRAINING HOURS FOR A FAMILIARIZATION RIFLE MARKSMANSHIP COURSE

<i>a.</i> Mechanical training.....	2 hours
<i>b.</i> Preparatory marksmanship training	2 hours
<i>c.</i> Range firing	4 hours
	—
Total	8 hours

**Section II. SUBJECT SCHEDULES AND TRAINING NOTES
FOR RIFLE MARKSMANSHIP TRAINING**

254. MECHANICAL TRAINING, M1 RIFLE—6 HOURS

P ¹	H ²	Lessons	Text references	Area	Training aids and equipment
1	1	Describe rifle: disassemble into the three main groups. Disassemble and assemble the barrel and receiver group.	Pars. 3-6, 8, 9-12, 22. v	Preferably a large classroom with chairs and tables; otherwise, any suitable training area.	<i>For instructor:</i> Rifle, combination tool, blackboard, dummy round; GTA 9-2, GTA 9-58. <i>For soldier:</i> Rifle, combination tool or dummy round, or both. GTA 9-58.
2	1	Disassemble and assemble the trigger housing group.	Pars. 15, 19.-----	Same as for period one.	<i>For instructor:</i> Same as for period one. <i>For soldier:</i> Same as for period one.

3	1 Functioning of the trigger housing group and the barrel and receiver group (1st phase).	Pars. 26-29	do.	<i>For instructor:</i> Same as for period one plus working model (fig. 145). <i>For soldier:</i> Same as for period one less GTA 9-58.
4	1 Functioning: barrel and receiver group (2d and 3d phases).	Pars. 30, 31	do.	<i>For instructor:</i> Same as for period three. <i>For soldier:</i> Same as for period one less GTA 9-58.
5	1 Functioning: barrel and receiver group (4th phase). Complete the assembly of the rifle. TF 9-1172.	Pars. 23, 32	Classroom with chairs and tables and suitable for showing a training film.	<i>For instructor:</i> Same as for period three plus TF 9-1172, projector, and screen. <i>For soldier:</i> Same as for period one less GTA 9-58.

¹P—period.
²H—hours.

254. MECHANICAL TRAINING, M1 RIFLE—6 HOURS (Cont'd)

P ¹	H ³	Lessons	Text references	Area	Training aids and equipment
6	1	Operation, stoppages, immediate action, spare parts, ammunition, care and cleaning.	Pars. 33-70-----	Same as for period one.	<p><i>For instructor:</i> Rifle, combination tool, dummy rounds GTA 9-2, blackboard and chalk, cleaning and lubricating materials.</p> <p><i>For soldier:</i> Same as for period one less GTA 9-58.</p>

255. PREPARATORY MARKSMANSHIP TRAINING, M1 RIFLE—24 HOURS

7	1	Marksmanship in general, sighting and aiming, 1st sighting and aiming exercise.	Pars. 71-78-----	Drill field or any suitable training area.	<p><i>For instructor:</i> Equipment described in par. 311, GTA 7-1.</p> <p><i>For soldier:</i> M1 rifle, combination tool, cartridge belt, notebook, pencil.</p>
---	---	---	------------------	--	--

8	1	1st and 2d sighting and aiming exercises, use of sighting device M15.	Pars. 79-81-----	Same as for period seven.	<i>For instructor:</i> Same as for period seven, plus 1,000-inch target. <i>For soldier:</i> Same as for period seven, plus one M15 sighting device per 4 soldiers.
9	1	3d sighting and aiming exercise.	Pars. 82-84-----	do-----	<i>For instructor:</i> Same as for period eight. <i>For soldier:</i> Same as for period eight.
10	1	Adjustment of loop sling, prone position.	Pars. 86, 87, 90, 91.	do-----	<i>For instructor:</i> Equipment described in par. 312: <i>For soldier:</i> Same as for period seven.

¹P—period.

²H—hours.

255. PREPARATORY MARKSMANSHIP TRAINING, M1 RIFLE—24 HOURS (Cont'd)

P ¹	H ²	Lessons	Text references	Area	Training aids and equipment
11	1	Kneeling and squatting positions.	Pars. 92-94, 95, 96.	Same as for period seven.	<i>For instructor:</i> Same as for period ten.
12	1	Sitting and crouch positions.	Pars. 97-99, 103	do	<i>For soldier:</i> Same as for period seven. <i>For instructor:</i> Same as for period ten.
13	1	Adjustment of hasty sling and standing position.	Pars. 100-102	do	<i>For soldier:</i> Same as for period seven. <i>For instructor:</i> Same as for period ten.
14	3	Trigger squeeze in prone, kneeling,	Pars. 105-109	do	<i>For soldier:</i> Same as for period seven. <i>For instructor:</i> Same as for period ten.

255. PREPARATORY MARKSMANSHIP TRAINING, M1 RIFLE—24 HOURS (Cont'd)

P ¹	H ²	Lessons	Text references	Area	Training aids and equipment
17	1	Reloading in all positions.	Par. 117-----	Same as for period seven.	<i>For instructor:</i> Same as for period fifteen plus a clip of dummy rounds.
18	2	Second sustained fire exercise in the prone, kneeling, squatting, and sitting positions.	Par. 118-----	do-----	<i>For soldier:</i> Same as for period fifteen plus a clip of dummy rounds per two soldiers. <i>For instructor:</i> Same as for period sixteen.
19	2	Third sustained fire exercise in the prone,	Par. 119-----	do-----	<i>For soldier:</i> Same as for period sixteen. <i>For instructor:</i> Same as for period seventeen.

	kneeling, squatting, and sitting positions.				<i>For soldier:</i> Same as for period seventeen.
20	1 Sight changes; effect of the wind and light.	Pars. 120-132	Classroom or outdoor area; preferably one with bleachers.		<i>For instructor:</i> Blackboard, eraser and chalk; A and B targets, spotters and disks; windage correction device (fig. 149) score card, pencil.
					<i>For soldier:</i> Rifle, combination tool, score card, paper and pencil.
21	1 Use of the score card	Pars. 134-136	Same as for period twenty.		<i>For instructor:</i> Same as for period twenty.
					<i>For soldier:</i> Same as for period twenty.

¹P—period.
²H—hours.

255. PREPARATORY MARKSMANSHIP TRAINING, M1 RIFLE—24 HOURS (Cont'd)

P ¹	H ²	Lessons	Text references	Area	Training aids and equipment
22	1	Zeroing the rifle; battle sight setting.	Pars. 133, 173.	Same as for period twenty.	<i>For instructor:</i> Same as for period twenty. <i>For soldier:</i> Same as for period twenty.
23	1	Range procedure; safety precautions; review all steps of marksmanship.	Pars. 148-198, 350-353.	do	<i>For instructor:</i> All previous equipment.
24	1	Examination before range firing.	Par. 137 plus all previous references.	do	<i>For soldier:</i> Same as for period twenty. <i>For instructor:</i> All previous equipment. <i>For soldier:</i> Same as for period twenty.

¹P—period.²H—hours.

256. TRAINING NOTES, MECHANICAL TRAINING— 6 HOURS

For suggestions as to the class arrangement and method of conducting mechanical training, see paragraphs 298–302.

257. FIRST PERIOD—1 HOUR

The object of this lesson is to teach each man the characteristics, general data, and the disassembly, and assembly of the barrel and receiver group. Nomenclature is learned during mechanical training.

a. With the men seated at the tables, have the rifles checked for safety. Clips of dummy rounds are broken down and checked for live rounds (5 *min.*).

b. Explain and describe the characteristics and general data of the rifle. After the explanation, have an assistant instructor disassemble the rifle into its three main groups (10 *min.*).

c. Explain, demonstrate, and conduct practical work in disassembling and assembling the barrel and receiver group and the bolt, and removing and replacing the gas cylinder lock screw (35 *min.*).

258. SECOND PERIOD—1 HOUR

The object of this period is to familiarize each man with the trigger housing group. Explain, demonstrate, and conduct practical work in the disassembly and assembly of the trigger housing group (50 *min.*).

259. THIRD PERIOD—1 HOUR

The object of this period is to teach the soldier how the trigger housing group functions, and to introduce the functioning of the barrel and receiver group, including the first phase of functioning.

a. Explain and conduct practical work to show how the trigger housing group works (15 min.).

b. Explain and show how the parts of the barrel and receiver group are related to each other before placing a full clip into the receiver (10 min.).

c. Explain and have demonstrated the first phase of functioning of the barrel and receiver group (25 min.).

260. FOURTH PERIOD—1 HOUR

The object of this period is to teach the soldier the second and third phases of functioning of his rifle.

a. Explain and demonstrate the second phase of functioning (10 min.).

b. Explain and demonstrate the third phase of functioning (10 min.).

c. For practical work, have the assistant instructors review the phases of functioning with the members of their groups (30 min.).

261. FIFTH PERIOD—1 HOUR

The object of this period is to teach the soldier the fourth phase of functioning of his rifle and

to review all phases by the use of a training film.

a. Explain, demonstrate, and conduct practical work in the fourth phase of functioning (20 min.).

b. Show training film 9-1172 (20 min.).

c. Complete the assembly of the rifle (10 min.).

262. SIXTH PERIOD—1 HOUR

The object of this lesson is to teach the soldier how to operate his rifle; what causes stoppages and how to clear them; how to apply immediate action; what spare parts he needs for the rifle; what types of ammunition are used; and how to care for and clean the rifle.

a. Explain and demonstrate the operation of the rifle (5 min.).

b. Name the different types of stoppages and explain each one by a series of set-ups and a chart based on table I (10 min.).

c. Explain and demonstrate how to apply immediate action when a stoppage occurs (5 min.).

d. Explain, and have for display, spare parts and ammunition (5 min.).

e. Explain the importance of care and cleaning. Discuss and demonstrate authorized cleaning materials, lubricants, rust preventives, and the accessories used in cleaning. Explain care and cleaning in garrison, before firing, during firing, and after firing. Care and cleaning under unusual conditions is ordinarily taught before these conditions are actually encountered (25 min.).

263. TRAINING NOTES, PREPARATORY MARKSMANSHIP TRAINING, M1 RIFLE

a. Preparatory instruction in marksmanship follows mechanical training. At this point in training, the trainee must be cautioned as to the importance of the habit of accurate rifle firing; why he must do everything exactly right; that, to acquire good shooting habits, he must practice and exert the maximum effort. Once the habit of exactness is formed, speed and smoothness can be developed with practice.

b. The preparatory marksmanship training steps are taught in the order that they are listed in paragraph 74. Each step includes the principles covered in the preceding steps. Example: to squeeze the trigger correctly, the firer must have a steady position and a correct sight picture. The fifth step, which includes the effect of wind, sight changes, and use of the score card, may be taught at any time before the examination prior to range firing.

264. SEVENTH PERIOD—1 HOUR

The object of this lesson is to teach each man why he must practice before he begins to shoot; to show him the correct sight alignment and sight picture; to have him go through the first sighting and aiming exercise; and to show him how to apply himself both as a coach and as a pupil.

a. Explain preparatory marksmanship training and its importance (*15 min.*).

b. Explain and demonstrate correct sight alignment and sight picture. Show why sight align-

ment is more important than sight picture (10 min.).

c. Explain and demonstrate the first sighting and aiming exercise (10 min.).

d. Conduct practical work in the first sighting and aiming exercise (15 min.).

265. EIGHTH PERIOD—1 HOUR

The object of this lesson is to teach the men the use of the sighting device, M15, and the second sighting and aiming exercise.

a. Explain and demonstrate the use of the sighting device, M15 (5 min.).

b. Explain and demonstrate the second sighting and aiming exercise (10 min.).

c. Conduct practical work in the second sighting and aiming exercise (35 min.).

266. NINTH PERIOD—1 HOUR

The object of this lesson is to demonstrate the importance of maintaining an accurate sight alignment and sight picture in firing the M1 rifle and to determine if the men thoroughly understand the principles of sighting and aiming.

a. Explain and demonstrate the third sighting and aiming exercise (10 min.).

b. Each man should make at least two plotted shot groups which are small enough to be covered by the unsharpened end of a lead pencil. Each shot group must be examined and discussed before the soldier is permitted to make a succeeding shot group (40 min.).

267. TENTH PERIOD—1 HOUR

The object of this lesson is to teach the man how to make the loop sling, how to adjust it to his arm, and how to assume the correct prone position.

a. Explain and demonstrate the loop sling and its adjustment (5 min.).

b. Explain and demonstrate the prone position and the common errors found in this position (10 min.).

c. Conduct practical work in adjustment of the loop sling and the prone position (35 min.).

268. ELEVENTH PERIOD—1 HOUR

The object of this lesson is to teach the men the kneeling and squatting positions.

a. Explain and demonstrate the kneeling and squatting positions and the common errors found in each position (15 min.).

b. Conduct practical work in the kneeling and squatting positions (35 min.).

269. TWELFTH PERIOD—1 HOUR

The object of this lesson is to teach the men the sitting and crouch positions.

a. Explain and demonstrate the sitting and crouch positions (15 min.).

b. Conduct practical work in the sitting and crouch positions (35 min.).

270. THIRTEENTH PERIOD—1 HOUR

The object of this lesson is to teach the men

the hasty sling adjustment and the standing position.

a. Explain and demonstrate the hasty sling and its adjustment (5 min.).

b. Conduct practical work in the adjustment of the hasty sling (10 min.).

c. Explain and demonstrate the standing position. Emphasize the need for a steady, well balanced position to cut down the natural wobble of the muzzle in this position (10 min.).

d. Conduct practical work in the standing position (25 min.).

271. FOURTEENTH PERIOD—3 HOURS

The object of this lesson is to teach the men the correct principles of trigger squeeze, to develop their ability to squeeze the trigger properly, and to provide additional practice in assuming all positions. The M2 aiming device should be used to check the sight picture as each soldier practices this exercise.

a. Explain and demonstrate trigger squeeze, emphasizing its importance in shooting (15 min.).

b. Explain and demonstrate the use of the M2 aiming device (5 min.).

c. Conduct practical work in trigger squeeze in all positions (except the crouch position) (130 min.).

272. FIFTEENTH PERIOD—2 HOURS

The object of this lesson is to teach the men the principles of firing at the sustained rate of fire.

a. Explain the principles of and reasons for sustained fire. Give a brief explanation of the three exercises used to teach sustained fire (20 min.).

b. Conduct practical work in the first sustained fire exercise in all positions except the standing and crouch positions (80 min.).

273. SIXTEENTH PERIOD—2 HOURS

The object of this lesson is to teach the men how to take positions rapidly.

a. Explain and demonstrate taking the prone and kneeling positions rapidly (10 min.).

b. Conduct practical work in taking the prone and kneeling positions rapidly (40 min.).

c. Explain and demonstrate taking the squatting and sitting positions rapidly (10 min.).

d. Conduct practical work in taking the squatting and sitting positions rapidly (40 min.).

274. SEVENTEENTH PERIOD—1 HOUR

The object of this lesson is to teach the men how to reload in all positions.

a. Explain and demonstrate reloading in the prone, kneeling, squatting, and sitting positions (15 min.).

b. Conduct practical work in reloading in the prone, kneeling, squatting, and sitting positions (35 min.).

275. EIGHTEENTH PERIOD—2 HOURS

The object of this lesson is to teach the men to fire nine rounds (one round, simulate reloading

eight more rounds) in 50 seconds, from standing to the prone, kneeling, squatting, and sitting positions.

a. Explain and demonstrate the second sustained fire exercise in the prone and kneeling positions (10 min.).

b. Conduct practical work in the second sustained fire exercise in the prone and kneeling positions (40 min.).

c. Explain and demonstrate the second sustained fire exercise in the squatting and sitting positions (10 min.).

d. Conduct practical work in the second sustained fire exercise in the squatting and sitting positions (40 min.).

276. NINETEENTH PERIOD—2 HOURS

The object of this lesson is to teach the men how to fire nine rounds (one round, reload with a clip of dummy rounds and fire eight rounds) in 50 seconds in the prone, kneeling, squatting, and sitting positions. Conduct practical work in the third sustained fire exercise in the prone, kneeling, squatting, and sitting positions (120 min.).

277. TWENTIETH PERIOD—1 HOUR

The object of this lesson is to teach the men how to make sight changes, how the wind affects the flight of the bullet, and how to use the windage and elevation rules.

a. Describe the rear sight. Explain how and in which direction to move the windage and

elevating knobs; that sight changes are made by clicks; how far each click will move the strike of the bullet at different ranges (15 min.).

b. Explain the dimensions of the A and B targets. Explain how to determine the velocity of the wind and how to use the wind rule. Explain all wind values (10 min.).

c. Conduct practical work problems in making sight changes, with and without a wind (25 min.).

278. TWENTY-FIRST PERIOD—1 HOUR

The object of this lesson is to teach the use of the score card. Explain and conduct problems in filling out the score card. During these problems the men will make the changes on their rear sight (50 min.).

279. TWENTY-SECOND PERIOD—1 HOUR

The object of this lesson is to teach the men how to zero their rifles at different ranges. Explain how to set the rear sight for the battle sight after having zeroed at 300 yards.

a. Explain the zero of a rifle. Explain how to zero the rifle at 100, 200, 300, and 500 yards when no wind is blowing, then how to zero the rifle at these ranges when a wind is blowing (40 min.).

b. Explain and demonstrate how to set the rear sight on battle sight after zeroing the rifle at 300 yards (10 min.).

280. TWENTY-THIRD PERIOD—1 HOUR

The object of this lesson is to teach range procedure and safety precautions and to review important points of preparatory marksmanship.

a. Explain range procedure and safety precautions (15 min.).

b. Review all important steps covered in previous instruction and answer by explanations and demonstration (if necessary) all questions that the men may ask (35 min.).

281. TWENTY-FOURTH PERIOD—1 HOUR

The object of this examination is to test the men in all the steps of preparatory marksmanship before going on the range for firing. Conduct an examination to test the men in all steps of preparatory marksmanship (50 min.).

282. RANGE FIRING—48 HOURS

P ¹	H ²	Lessons	Text references	Range	Training aids and equipment
25	6	Instruction firing tables I and II, course D. Use 1,000-inch A target throughout.	Par. 144	1,000-inch range	<i>For instructor:</i> 1,000-inch range equipment. <i>For soldier:</i> Rifle, combination tool, and score card. (Shooting coat if available.)
26	16	Zeroing rifle, instruction firing, slow fire, tables I, II, and III, standard course.	Pars. 133, 140, 173. SR 385-310-1.	Known-distance range.	<i>For instructor:</i> All equipment listed in par. 199b, c. <i>For soldier:</i> Rifle, combination tool, score card and pencil. (Shooting coat if available.)
27	8	Record firing, standard course tables IV and V.	---do---	---do---	<i>For instructor:</i> Same as for period twenty-six plus score cards.

28	6 Instruction firing table VI, standard course.	Par. 140	do	<i>For soldier:</i> Same as for period twenty-six plus score cards. <i>For instructor:</i> Known distance range equipment and binoculars for each firing point.
29	6 Instruction firing tables VII and VIII, standard course.	do	Transition range	<i>For soldier:</i> Rifle, combination tool and score card. <i>For instructor:</i> Transition range equipment.
30	6 Record firing tables VII and VIII, standard course.	do	do	<i>For soldier:</i> Rifle, combination tool and score card. <i>For instructor:</i> Same as for period twenty-nine. <i>For soldier:</i> Same as for period twenty-nine.

1P—period. 2H—hours.

283. TRAINING NOTES, RANGE FIRING

For a detailed discussion of the method of conducting range firing, see paragraph 317.

284. TWENTY-FIFTH PERIOD—6 HOURS

The object of this lesson is to have the men become familiar with firing live ammunition and to apply the principles of good shooting taught during preparatory marksmanship training.

a. Explain and demonstrate the value of using dummy cartridges during 1,000-inch firing (20 *min.*).

b. Conduct instruction firing tables I and II, course D (par. 144). Use the 1,000-inch A target throughout (340 *min.*).

285. TWENTY-SIXTH PERIOD—16 HOURS

The object of this lesson is to have the men zero their rifles with live ammunition and perfect their shooting ability before firing for qualification. Conduct instruction firing, slow and sustained fire, tables I, II, and III, standard course (960 *min.*).

286. TWENTY-SEVENTH PERIOD—8 HOURS

The object of this lesson is to test the men for qualification in rifle marksmanship. Fire for record tables IV and V of the standard course (480 *min.*).

287. TWENTY-EIGHTH PERIOD—6 HOURS

The object of this lesson is to familiarize men

with the use of the common aiming point while using the battle sight at 200, 300 and 400 yards. Conduct instruction firing, table VI, standard course (360 min.).

288. TWENTY-NINTH PERIOD—6 HOURS

The object of this lesson is to have men perfect their ability to engage field type targets at unknown ranges, using the battle sight before firing for qualification. Conduct instruction firing, tables VII and VIII, standard course. (360 min.).

289. THIRTIETH PERIOD—6 HOURS

The object of this lesson is to test men for qualification in transition firing. Fire for record tables VI and VII of the standard course (360 min.).

**Section III. SUBJECT SCHEDULE AND TRAINING NOTES FOR
FAMILIARIZATION RIFLE MARKSMANSHIP TRAINING
290. FAMILIARIZATION COURSE, M1 RIFLE—4 HOURS**

P ¹	H ²	Lessons	Text references	Area	Training aids and equipment
1	1	Description, capabilities and limitations of the rifle. Disassembly of the rifle into three main groups. Disassembly of the barrel and receiver group, less the bolt. Assembly of rifle and explanation of stoppages and immediate action.	Pars. 3, 4, 6, 8-12, 22, 23, 45-47.	Preferably large classroom with chairs and tables, otherwise any suitable training area.	<i>For instructor:</i> Rifle, combination tool, blackboard, dummy round, GTA 9-2, GTA 9-58. <i>For soldier:</i> Rifle, combination tool and/or dummy round.
2	1	Marksmanship in general, sighting and aiming, adjustment of loop sling and prone position.	Pars. 72-91.	Drill field or any suitable training area.	<i>For instructor:</i> Rifle, rifle rest, blackboard, 1,000-inch A rifle target, GTA 7-1.

3	1 Kneeling and squatting positions, adjustment of the hasty sling, standing and crouch positions; trigger squeeze.	Pars. 92-96, 100-103, 105-109.	Same as for period two.	<i>For soldier:</i> Rifle, combination tool, and sighting device, M15. <i>For instructor:</i> Same as for period two.
4	1 Sustained fire; sight changes, care and cleaning; safety precautions and range procedure.	Pars. 48-57, 110-112, 114, 115, 117-122, 124, 126-132, 168-180, 350-353. SR 385-310-1.	do.-----	<i>For instructor:</i> Same as for period two, plus score card, cleaning and lubricating material. <i>For soldier:</i> Same as for period two, plus clip with wooden block, score card and pencil.

¹P—period.
²H—hours.

291. MARKSMANSHIP (FAMILIARIZATION)—4 HOURS

P ¹	H ²	Lessons	Text references	Range	Training aids and equipment
5	4	Familiarization course.	Par. 146. SR 385-310-1.	Known-distance range.	<p><i>For instructor:</i> Equipment listed in paragraph 199b and c.</p> <p><i>For soldier:</i> Rifle, combination tool, score card, pencil, shooting coat if available.</p>

¹P—period.

²H—hours.

292. TRAINING NOTES, MECHANICAL TRAINING AND PREPARATORY MARKSMANSHIP

The purpose of the familiarization course is to give the soldier enough training to enable him to maintain and operate the rifle during an emergency. For suggestions as to the class arrangement and method of conducting mechanical training, see paragraphs 298-302.

293. FIRST PERIOD—1 HOUR

The object of this lesson is to teach the men the capabilities, limitations, and maintenance of the rifle.

a. Explain and describe the characteristics and general data of the rifle (5 min.).

b. Explain and have the assistant instructors to demonstrate the disassembly of the rifle into its three main groups (5 min.).

c. Conduct practical work in disassembling the rifle into the three main groups (5 min.).

d. Explain and demonstrate the disassembly and assembly of the barrel and receiver group, excluding the bolt (5 min.).

e. Conduct practical work in the disassembly and assembly of the barrel and receiver group excluding the bolt (10 min.).

f. Explain and demonstrate stoppages and immediate action (10 min.).

g. Conduct practical work in applying immediate action (5 min.).

h. Assemble the rifle (5 min.).

294. SECOND PERIOD—1 HOUR

The object of this lesson is to teach the value of marksmanship, how to correctly aim the rifle, the adjustment of the loop sling, and the prone position.

a. Explain the value of rifle marksmanship and why each man, regardless of prior experience or qualification must take it (5 min.).

b. Explain and demonstrate the first sighting and aiming exercise and the use of the M15 sighting device (10 min.).

c. Conduct practical work in the first sighting and aiming exercise (15 min.).

d. Explain and demonstrate the adjustment of the loop sling and the prone position (10 min.).

e. Conduct practical work in adjustment of the loop sling and the prone position (10 min.).

295. THIRD PERIOD—1 HOUR

The object of this lesson is to teach the kneeling, squatting, and sitting positions; adjustment of the hasty sling; the standing and crouch positions; and trigger squeeze.

a. Explain and demonstrate the kneeling, squatting, and sitting positions (10 min.).

b. Explain and demonstrate the hasty sling and the standing and crouch positions (10 min.).

c. Explain and demonstrate trigger squeeze and the use of the M2 aiming device (5 min.).

d. Conduct practical work in trigger squeeze in the prone, kneeling, squatting, and standing positions. (Coaches use M2 aiming device.) (25 min.).

296. FOURTH PERIOD—1 HOUR

The object of this lesson is to teach sustained fire, sight changes, care and cleaning, safety precautions, and range procedure.

a. Explain and demonstrate sustained fire (10 *min.*).

b. Conduct practical work in sustained fire in the kneeling and squatting positions (15 *min.*).

c. Explain and demonstrate sight changes (10 *min.*).

d. Explain care and cleaning (5 *min.*).

e. Explain and discuss safety precautions and range procedure (10 *min.*).

297. FIFTH PERIOD, RANGE FIRING—4 HOURS

The object of this lesson is to have the men apply with live ammunition the principles as taught during preparatory marksmanship training. Conduct familiarization firing as outlined in paragraph 146 (240 *min.*).

Section IV. MECHANICAL TRAINING

298. GENERAL

a. The suggestions in this section are made to fit the needs of officers and noncommissioned officers who are training a large number of troops. Do not let this section limit your initiative and originality in any way except to observe all safety precautions.

b. In teaching mechanical training, arrange your instruction so the class as a whole will pro-

gress together. Explain each step, then have each step demonstrated in detail in each subgroup of the class. After each step is explained and demonstrated, have each man perform that step. Whenever you or your assistants find a man whose progress is slow, give him special help.

c. This instruction can best be conducted indoors. However, outdoor areas may be used when the weather permits. It is desirable to seat the men at tables. When tables are not available, shelter halves may be spread on the floor or the ground as an expedient. Arrange the tables or shelter halves to accommodate groups of 4 to 8 men. A trained assistant instructor should be in charge of each group. Provide space between groups to allow movement of other instructors through the assembled class. Rehearse each class with your assistant instructors beforehand so they will know what you are explaining or describing. They must know what you want demonstrated and exactly how and when to do it.

d. If available, use a public address system for large classes.

e. Make all charts and working models large enough to be clearly seen by all men. If they are not large and clear enough, do not use them in your lectures but display them in the instructional area. During breaks the men can study this display.

f. In conducting instruction, be sure to allow ample time for demonstrations by the assistant instructors and for practical work by the men.

g. Each group of men should be provided with the following equipment:

Two clips of dummy rounds.

Ball of waste or rags.

Small wire pointer for the assistant instructor, M1 rifle, complete with combination tool, and oil and thong case for each man.

299. DISASSEMBLY AND ASSEMBLY

After disassembling the rifle into its three groups, have the men lay aside the groups not in use to make room for the parts with which they are working. With the rifle separated into its three main groups, conduct the disassembly and assembly of the barrel and receiver group and the trigger housing group. Have the men lay the parts out, from left to right, in the order that the parts are removed. This will aid in the assembly of the groups and will help them to learn and remember the names of each part. Encourage the men to ask questions so you can clarify points that are not understood.

300. FUNCTIONING

a. Explanation. Some men will have difficulty in understanding the functioning of the rifle the first time they receive such instruction; therefore, you must be prepared to explain each step in more than one way.

b. Time. In arranging your instruction, do not cover more than one phase of functioning at a time. Each period of instruction should allow some time for the instruction to be understood,

for the men to ask questions, and for you to repeat various steps when necessary.

c. Training Aids.

- (1) If you use a large working model to explain a step in functioning, each assistant instructor with the rifle should explain the same step to his group.
- (2) A chart that lists the four phases of functioning and separate charts that list the steps in each phase will aid your instruction.

301. STOPPAGES AND IMMEDIATE ACTION

Explain the cause for each type of stoppage. Use a chart listing the types and causes of stoppages. Using a chart, explain how to apply immediate action. Have the assistant instructors demonstrate it at each group. Require the men to practice applying immediate action several times.

302. CARE AND CLEANING

The assistant instructors should demonstrate each step in cleaning the rifle. All necessary equipment and materials, including rifle bore cleaner and oil, should be used for these demonstrations.

Section V. PREPARATORY TRAINING

303. GENERAL

a. Arrange preparatory marksmanship training to give the soldier short conferences followed

by periods of practical work in each step of instruction. Make each man want to become an expert shot. It is your duty as an instructor to give your men confidence in their weapon.

b. Units should be relieved from routine duty during preparatory marksmanship training and range firing so that all men will spend a maximum of training time learning to shoot the rifle.

304. ASSISTANT INSTRUCTORS

Train your assistant instructors in advance in the methods of instruction and the material to be presented. If you use well trained, rehearsed assistant instructors, your instruction will be well presented and supervised and the men will progress in their training. These assistant instructors must be able to assume the correct positions during demonstrations and, if possible, they should be experts with the rifle.

305. EQUIPMENT

a. All equipment used in preparatory exercises must be accurately and carefully made. One of the objects of these exercises is to cultivate a sense of exactness and carefulness in the minds of the men undergoing training. They cannot be exact and they will not be careful when working with equipment that is carelessly made.

b. You, the instructor, should personally inspect the equipment for the preparatory exercises before training begins. If the equipment is to be constructed by the units, have a model set available to be used as a pattern. If the equipment is

already available, the condition and amount of it must be closely checked.

306. INSPECTION OF RIFLES

No man is expected to fire with an unserviceable or inaccurate rifle. All rifles should be carefully inspected far enough in advance to permit organization commanders to replace all inaccurate or defective rifles before the training period begins. Rifles having badly pitted barrels should not be used.

307. PREPARATORY MARKSMANSHIP FIELDS

The preparatory marksmanship training field is selected, inspected, and prepared in advance, and the equipment and training aids are moved to the training area and set up for use before the class arrives. There are two types of preparatory marksmanship training fields—the parallel line type, and the circular type. The parallel line and circular fields are discussed in succeeding paragraphs.

308. PREPARATORY MARKSMANSHIP FIELD (TEMPORARY)

The parallel line type and modified circular type preparatory fields are temporary installations. Therefore, when they are not in use for marksmanship training, the areas may be used for other purposes.

a. Organization of the parallel line type. The class is organized in two parallel lines facing

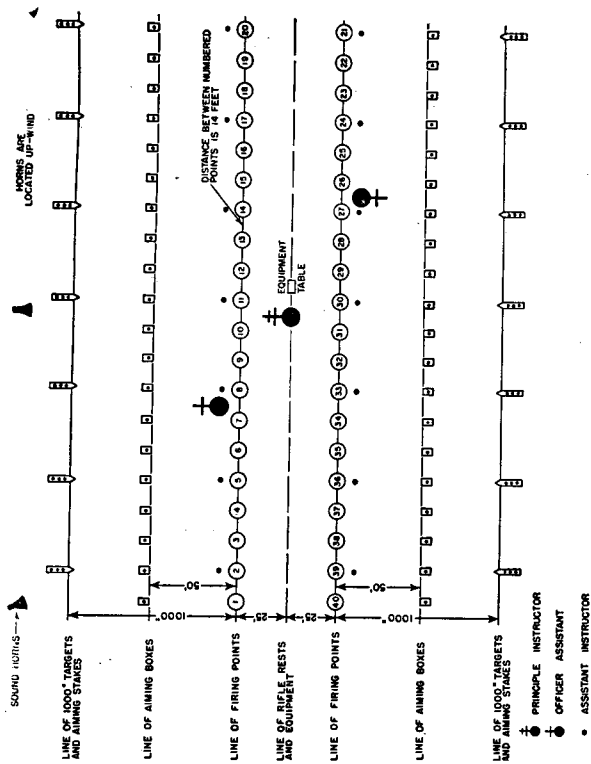

Figure 117. Detailed layout of the preparatory marksmanship field, parallel type (temporary).

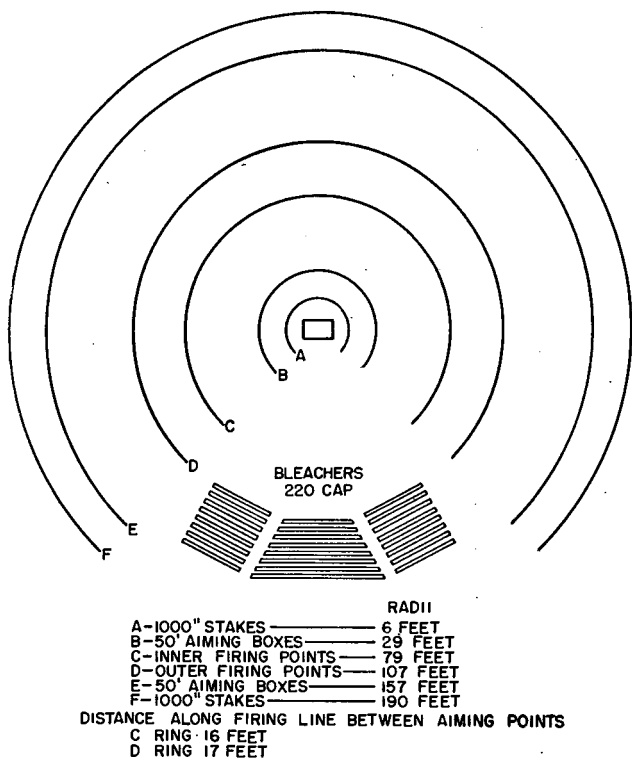

Figure 118. Detailed layout of the preparatory marksmanship field, modified circular type (temporary).

away from each other. The preparatory field is organized as shown in figure 117.

b. Organization of the modified circular type. This preparatory field is organized as shown in figure 118. Observe the following guides in organizing the training area:

- (1) Bleachers are placed on the circle as

shown in figure 122. All periods of conference and demonstration are conducted in front of the bleachers.

- (2) The public address system, if available, is located around the control stand so that announcements can be heard by everyone on the field.

309. PREPARATORY MARKSMANSHIP FIELD (PERMANENT)

a. General. The preparatory marksmanship instruction circle is a permanent installation; therefore, this training area cannot be used for other instruction.

b. Organization. The preparatory marksmanship instruction circle may consist of four concentric circles (for two companies) or two concentric circles (for one company). The two-company installation (four concentric circles) is organized as shown in figure 119. Observe the following guides in organizing the training area:

- (1) The field is centered around a demonstration platform which is fronted by bleachers for seating the class. A sliding target frame, similar to the type used on the known-distance range, may be constructed on the rear of the demonstration platform for use as a training aid. Other training aids may be required for each step of the instruction.
- (2) The inner and outer circles consist of manually operated disappearing targets for sustained fire exercises (figs. 120 and

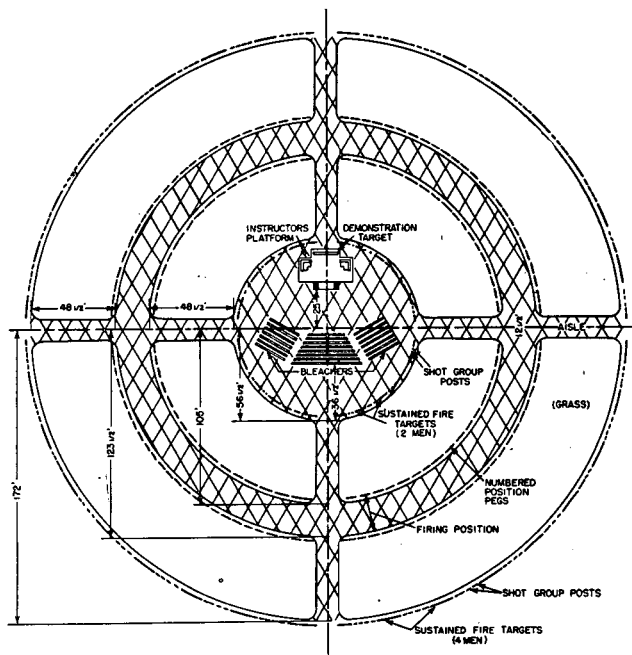

Figure 119. Detailed layout of the two company circular preparatory marksmanship field (permanent).

121) and vertical posts 51½ inches wide for the second and third sighting and aiming exercises. The men take positions at the numbered stakes which are placed on the circular lane formed by the two middle circles and face the targets indicated above. If the installation is designed for one company, the men take positions on either circle facing the targets on the other circle.

DISAPPEARING TARGET
TYPE - A

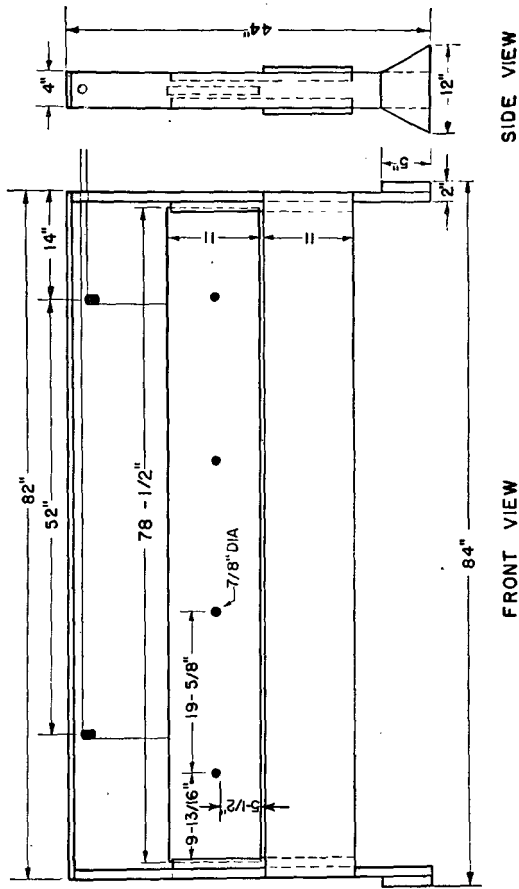
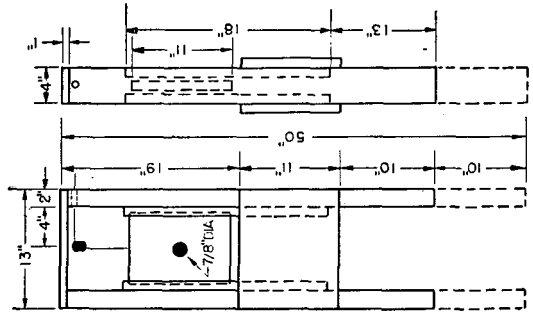
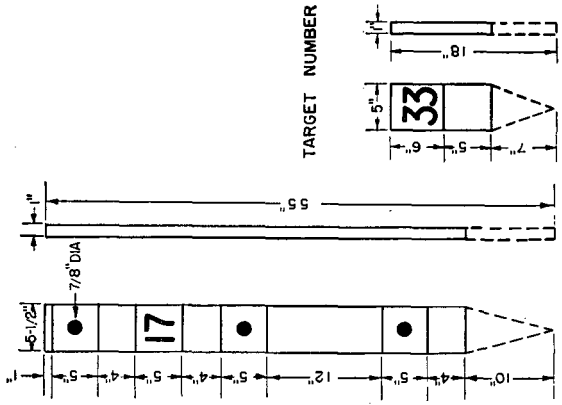

Figure 120. Disappearing target, type A.

DISAPPEARING TARGET



STAKE TARGET



TARGET NUMBER

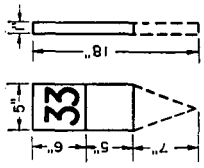

Figure 121. Disappearing target, type B, and stake target.

- (3) Lanes or aisles are provided so that the assistant instructors may move freely in supervising the work and so that the men may move from the bleachers to their numbered positions on the circles.
- (4) Several sustained fire targets can be operated simultaneously by connecting them with a draw rope.
- (5) The public address system, if available, is located around the control and demonstration stand so that announcements can be heard by everyone on the field.

310. LECTURE AND DEMONSTRATIONS

At the beginning of each step of instruction, it is desirable to give a short explanation to assembled groups undergoing preparatory rifle training. These talks should be made by selected officers who are expert shots or at least experienced riflemen.

311. SIGHTING AND AIMING

The class is assembled where all can hear the instructor and see the demonstrations.

a. Equipment. The following equipment should be provided:

- 1 sighting bar complete.
- 1 sighting device (M15).
- 1 rifle rest.
- 1 rifle.
- 1 small sighting disk.
- 1 small box with paper, pencil, and thumb tacks.

Material for blacking sights.

1 enlarged model of sight pictures.

1 blackboard with chalk, or chart.

b. Orientation. The following subjects are covered in the first conference as an orientation for sighting and aiming exercises. Use these points as a basis for your conference. This in no way limits your initiative or the scope of your conference.

(1) *Value of knowing how to shoot.*

(a) The rifle is the basic arm of the infantry.

(b) Every infantryman must know how to fire the rifle.

(c) If you know that you can hit the enemy, you will have confidence in your rifle.

(d) As you gain skill in the use of your rifle, the efficiency of the infantry increases.

(e) Firing the rifle is good sport and is a challenge to every man.

(f) YOUR LIFE MAY, AND PROBABLY WILL, DEPEND ON YOUR ABILITY TO SHOOT TO KILL.

(2) *Objects of target practice.*

(a) To teach the men to use good shooting habits instinctively.

(b) To show the men how to teach others.

(c) To train future instructors.

(3) *Training to shoot well.*

(a) Good firing requires coordination of your mind and body.

- (b) Any man who is physically fit can be taught to shoot well.
 - (c) Shooting requires no inborn talent, just the desire to shoot and to do well in what you undertake.
- (4) *Coach and pupil method.*
- (a) Each man will act as a coach and a pupil.
 - (b) A good coach, who demands perfection, will usually teach his pupil to shoot well.
 - (c) Coaching is an important duty and everyone should do his best to be a good coach.
 - (d) Coaching is continuous.
- (5) *Importance of accuracy.* Impress the men with the need for carefulness and accuracy in performing each step of the preparatory exercises; emphasize the fact that good shooting habits result from precision acquired in preparatory marksmanship training.
- (6) *Progress chart.* Explain that a progress chart will be kept on each man to measure his ability to use the rifle. The marking system should be explained by using a blackboard or chart.
- (7) *Examination of men on preparatory work.* Explain that each man will be examined on all preparatory marksmanship steps before going on the range.
- c. *Sighting and aiming exercises.*
- (1) *Sight alinement.* Show by use of the

model sight picture, or by use of a black-board, the correct sight alinement. Explain its importance.

- (2) *Sight picture.* By adding the bull's-eye to the sight alinement, the sight picture is completed. Show this by using the model sight picture device or a black-board.
- (3) *Coach and pupil training.* Show how the men will be organized into coach and pupil teams.
- (4) *First sighting and aiming exercise.* Explain the purpose of this exercise and give a demonstration to show how it is conducted.
- (5) *Blacking the sights.* Explain why the sights should be blacked and demonstrate how to do it.
- (6) *Second sighting and aiming exercise.* After the men are qualified in the first exercise, explain and demonstrate the second sighting and aiming exercise.
- (7) *Third sighting and aiming exercise.* Assuming that the men know the second exercise, explain and demonstrate the third sighting and aiming exercise. At this stage of the training, the shot groups will show you the progress that the men are making.
- (8) *Attitude of instructor and assistants.* If the instructor and his assistants are interested, enthusiastic, and energetic, the men will be the same. If the instructor and his assistants are inattentive, care-

less, and bored, the men will be the same, and the scores will reflect this attitude.

- (9) *Suggestions.* Before concluding each portion of the lecture, the instructor will ask if there are any questions. If no questions are asked, he should have several questions to ask members of the class. He requires all leaders to keep the progress charts up to date. The work should be organized so that the men are kept busy at all times. Allow ample time for your assistant instructors and coaches to make corrections. The men should be allowed a 10-minute break during each hour. Short periods of calisthenics involving stretching provide relief from possible tedium and also condition men for position exercises. Do not hesitate to reassemble the class to point out or demonstrate the most frequent errors noted and to emphasize or clarify important points. Before the class is dismissed; it should be given information and study references about the period of instruction for the next day.

312. POSITIONS

a. General. The class is assembled where all can hear and see the instructor and demonstrations.

b. Equipment. The following equipment should be provided for this lecture and demonstration:

1 rifle with sling.

1 stake or box with 1,000-inch target.

c. Orientation. The instructor explains that the steps in preparatory marksmanship training include all instructional matters covered during the preceding classes and that each of the essentials of good shooting should be learned thoroughly and should be practiced repeatedly. Men who assume poor positions for firing are seldom good shots. A good shot's firing positions will not vary much from the prescribed positions. Instruction in firing positions includes correct aiming and breathing but does not include trigger squeeze.

(1) *Holding the breath.* The instructor explains, demonstrates, and has the men practice the correct manner of holding the breath. The instructor then explains how a coach, by watching the pupil's back, should observe whether his pupil is breathing.

(2) *Position of the thumb and cheek.* The instructor explains that the thumb is not placed along the right side of the stock because this makes it difficult to grasp the small of the stock securely and awkward to apply pressure straight to the rear when squeezing the trigger. By placing the thumb over the small of the stock or on top of it with the cheek resting on top of the thumb (spot weld), the following advantages are obtained:

(a) The eye can be placed at the same

distance from the peep sight for each shot.

- (b) The small of the stock can be more easily grasped.
 - (c) Pressure can be applied on the trigger, straight to the rear, more easily and uniformly.
- (3) *Position of the trigger finger.* The position of the forefinger on the trigger will depend upon the conformation of the firer's hand. No part of the finger should bear against the stock. This insures that all pressure, when exerted, will be applied straight to the rear.
- (4) *Progress charts.* Leaders are reminded that the progress chart of their men will be kept up to date and that each man should have a mark for each of the items shown that have been covered in his training.
- (5) *Relaxation and bone support.* The instructor explains that complete muscular relaxation and bone support is the goal to be attained in taking all positions. He should show with each exercise how a man may test any position for naturalness and relaxation. This method is as follows: have him take what he believes to be a correct position with his sights aligned on the target correctly; have him close his eyes and consciously relax his muscles for 5 or 6 seconds;

have him open his eyes and again look through his sights. If his position is correct, his sight picture will still be correct or very nearly so. Otherwise, the position is faulty and should be corrected by moving the whole body and repeating the entire process until a correct position has been attained.

- (6) *Coach.* The instructor explains and demonstrates that in each position the coach should take a position from which he can observe the pupil's trigger finger and the eyes.

d. Prone Position.

- (1) Explain and demonstrate the correct prone position, calling attention to the elements which go toward making a correct position—gun sling properly adjusted, body at the correct angle, legs spread apart, position of the butt plate on the shoulder, position of the hands on the rifle, position of the cheek against the stock and on top of the right thumb, and position of the elbows. Stress the fact that when pupils take a position they should always aim at a target.
- (2) Demonstrate the errors which most frequently occur in taking the prone position and show the methods for correcting them.
- (3) Show how the work is organized, using the coach and pupil method, so that every man is kept busy.

e. Squatting, Sitting, Kneeling, Standing, and Crouch Positions. Explain and demonstrate these positions in the same manner described above for the prone position.

f. Aerial Target Position. Explain and demonstrate this position in the same manner described above for prone position.

g. Instructor's Procedure. After each position has been explained and demonstrated, send the class to their designated positions on the preparatory field for practical work.

313. TRIGGER SQUEEZE

a. General. Read paragraph 105. Explain that there is only one correct method of squeezing the trigger—a firm initial pressure which is constantly increased so that the rifleman does not know when the explosion will take place. Emphasize the fact that this method of squeezing the trigger produces the best results and must be applied in both slow and sustained fire.

b. Accuracy. Regardless of how well a man may have been instructed in the sighting and aiming exercises and in position exercises, if he fails to squeeze the trigger correctly, he will not shoot well. Consequently, the instructor should demonstrate that, in the final analysis, the accuracy of rifle fire—all other things being satisfactory—depends upon correct trigger squeeze.

c. Improper Trigger Squeeze. To demonstrate how improper trigger squeeze affects the shot, place the rifle on a table and tell the men to assume that it is pointing at a target 500 yards

away and that the rifle is in a machine rest that runs on a track parallel to the line of targets. Tell the men to assume that you have fired a shot that hits the left edge of the 20-inch bull's-eye; then move the rifle 20 inches to the right. Call attention to the fact that the rear and front sights move the same distance and in the same direction. Explain why a shot fired from this position will hit the right edge of the bull's-eye. Move the rifle backward and forward between these two positions, commenting that the front and rear sights move the same distance in the same direction. Explain why a shot fired while the rifle is moving will hit in the bull's-eye. Now move the butt of the rifle while holding it at the stock ferrule swivel. Point out that this causes the muzzle to move in the opposite direction and explain why it would cause a shot to miss the target. Reemphasize that a shot hits the target when the whole rifle is moved parallel to the line of sight but misses the target when one end is moved in one direction while the other end remains stationary or moves in the opposite direction. The man who moves his shoulder forward into the butt of the rifle to catch the recoil or moves his shoulder back to lessen the recoil will have a bad shot because he is actually pivoting the rifle about a point. Breathing will cause the same result. As the man inhales, the shoulders and butt end of the rifle rise and the muzzle end of the rifle is lowered. The shot will be low. A firer prevents these errors by holding his breath while he aims, applies correct trigger squeeze, and follows through.

d. *Aim and Hold.* Any man can easily learn to hold a good aim for 15 to 20 seconds, which is a much longer period than is necessary to squeeze off a well-aimed shot. Require the men to practice holding the aim for a short period of time to develop steadiness.

e. *Coach Squeezing the Trigger.* When the coach squeezes the trigger for the pupil, the fact that the shot is almost invariably a good one proves that poor shooting is caused principally by errors in the trigger squeeze. By watching the firer's back, the coach knows when the rifleman has stopped breathing and is aiming. During such time, the coach presses steadily on the trigger. Demonstrate how this is done.

f. *When the Rifle is Fired Before the Man is Ready.* Often a man who has been doing poor shooting will state upon firing a shot, "I cannot call that shot. I didn't know it was going off." Almost invariably these shots are well placed. His poor shots have been caused by getting set for them.

g. *Follow-Through.* Explain the meaning of following through (par. 107) and why it is important.

h. *Calling the Shot.* Explain the meaning of calling the shot (par. 106) and why this is done.

i. *Application.* Demonstrate the duties of the coach during practical work involving trigger squeeze. Do this by calling attention to each of the checks that the coach must make on the firer. Practice trigger squeeze in all positions. Each coach should assure himself that his pupil under-

stands how to squeeze the trigger properly. He does this by placing his own finger on the trigger. The pupil then applies the squeeze on the coach's finger. The M2 aiming device should be used during these periods.

j. Instructor's Procedure. See paragraph 108. Do not let the practical work lag; keep the men busy. Explain that it requires a lot of practice to train the muscles to do the right thing. In order to have the training progress satisfactorily, do not hesitate to assemble the group to emphasize certain points and to make necessary corrections.

314. SUSTAINED FIRE

a. Equipment. The following equipment is required for this lecture and demonstration:

- 1 rifle with sling.
- 1 clip fitted with wooden block to be inserted into the receiver.
- 2 clips of dummy rounds.
- 1 stake or box with 1,000-inch target.

b. Sustained Fire Exercises. The following subjects should be included in the discussion:

- (1) Superiority of fire in battle depends on the *ability to deliver sustained and accurate fire* on the enemy. Both the amount and accuracy of fire are obtained by careful training and practice.
- (2) *Trigger squeeze* is applied the same in sustained fire as in slow fire.
- (3) Explain the advantages of *keeping the eye on the target*. Time is not lost and

the chance of firing on the wrong target is eliminated. In combat the target must be kept in sight and not become lost.

- (4) Emphasize that *accuracy* of performance for *each shot* is of primary importance in the sustained fire exercises. Speed is secondary and will increase with experience. The coach should never urge his pupil to increase his rate of fire at a sacrifice of accuracy.
- (5) Explain that *a certain time is allotted* for each part of sustained fire—10 seconds to take the position and fire the first round, 10 seconds to reload and fire the second round, then 4 seconds for each remaining round. A cushion of 2 seconds is provided, making a total of 50 seconds.

c. Taking Positions Rapidly. Explain and demonstrate the method of going into each position rapidly and firing the first shot. The time prescribed in sustained fire for assuming the prone, kneeling, sitting, and squatting positions and firing the first round is 10 seconds. Send the class to the preparatory field for practice in taking all positions rapidly. A time greater than 10 seconds may be used to begin with.

d. Reloading in all Positions. Explain and demonstrate *loading and unloading in all positions*. To practice reloading, the clip of dummy rounds should be placed in the third pocket of the cartridge belt. Explain the duties of the coach in all positions.

e. First Exercise (Cadence).

- (1) Explain what is meant by cadence in firing and the necessity for it.
- (2) Explain that the starting cadence for beginners is 5 seconds, and that as skill increases, it is reduced to 4 seconds. A cadence of 4 seconds is the ideal time to fire each round.
- (3) Demonstrate the use of the clip with the wooden block in it. Have the coach demonstrate how to cock the rifle during the cadence exercise.

f. Second Exercise.

- (1) Demonstrate the exercise in all positions, pointing out the use of the clip with the wooden block and the manner in which the coach cocks the rifle.
- (2) Reemphasize the fact that exactness in performance is the goal and that speed is of secondary importance.

g. Third Exercise.

- (1) Explain that in this exercise the pupil is required to fire nine dummy rounds at the sustained fire cadence, going from standing to the prescribed position and reloading from the belt.
- (2) Demonstrate the exercise in each position, pointing out the duties of the coach.
- (3) Emphasize the fact that smoothness and accuracy are more important than speed.

h. Conclusion. Following the explanation and demonstration of each exercise, send the class to

the preparatory field for practical work in each of the sustained fire exercises as prescribed in paragraph 119.

315. SIGHT CHANGES, EFFECT OF THE WIND, AND USE OF THE SCORE CARD

a. *Equipment.* The following equipment is needed for this lecture and demonstration:

- 1 blackboard, chalk, and eraser.
- 1 enlarged chart of the score card (painted or drawn on a blackboard).
- 1 A and B target with necessary spotters. (Each man should have his rifle, score card, and pencil.)

b. *Sight Changes.*

- (1) Explain that elevation and deflection is measured in clicks. Explain approximately how far a click will move the strike of the bullet for each 100 yards. Require the men to work various problems involving application of this rule.
- (2) Explain the dimensions of the A and B targets.
- (3) Explain how wind affects the flight of the bullet and the methods of determining the direction and velocity of the wind. Work several examples on the blackboard. Require the men to work several of these problems.

- (4) Explain the wind formula $\frac{RV}{10}$. Work

several examples and then give the men several problems to solve.

c. Zero of the Rifle.

- (1) Explain what is meant by the zero of a rifle.
- (2) Explain that rifles differ and that each man must find the zero of *his own rifle*.

d. Use of the Score Card.

- (1) Explain the score card.
- (2) Using the score card, an A target, and spotters, solve a problem to determine the zero of a rifle at 100, 200, and 300 yards when no wind is blowing. Now determine the zero of the rifle at these ranges when a wind is blowing.
- (3) Using the score card, B target, and spotters, determine the zero of a rifle at 500 yards.

316. EXAMINATION BEFORE RANGE FIRING

a. If each step of the instruction in the preparatory marksmanship training has been presented carefully and thoroughly, all men should be well qualified by the time the examination is given. Progress charts based on daily observation or preliminary examinations should have been kept on each man and should be studied continually to determine those men who are weak in the various phases of marksmanship. These men should receive additional instruction.

- (1) *Time of holding the examination.* The examination should not require an ex-

cessive amount of time. It should be held well in advance of range firing to permit additional instruction to be given to those men who are found unsatisfactory in any phase of training.

(2) *Preparation.* The questions and answers (par. 138) covering the preparatory training should serve as a guide to instructors while conducting this examination. The examination outline by these questions and answers should supplement rather than take the place of practical tests during the various phases of instruction. All required equipment should be assembled and set up prior to the time of the examination.

(3) *Plan of conducting the examination.* The following is an efficient plan for giving the examination that covers each step of preparatory marksmanship training (fig. 98).

(a) Designate enough qualified noncommissioned officers to act as examiners.

(b) Lay out stations to cover the examination in the following steps:

Sighting and aiming.

Positions (one station for each position).

Trigger squeeze.

Sustained fire.

Sight changes.

Wind estimations and corrections.

Use of the score card.

- (c) Assign examiners to each station to insure prompt and thorough examinations. Duplicate stations will save time.
- (4) *Supervision.* The leaders move from station to station and, by questioning, assure themselves that examinations are given as prescribed. Names of men who are found to be deficient in any phase of instruction are noted by the examiners on a slip of paper. The names are turned over to the platoon leader, who arranges for the necessary additional training.

b. The following check list may be reproduced and used in examining each soldier. The officer or noncommissioned officer conducting each step of the examination enters the appropriate rating.

Company... **D** ... 1st Inf.

Name..... **John, F. A.** Rank... **Pvt.** ...

Squad..... **1st** Platoon..... **2d**

Subject		Examination		Reexaminat'n	
		Sat.	Unsat.	Sat.	Unsat.
1	Mechanical training		X	X	
2	Functioning		X	X	
3	Care and cleaning	X			
4	Sighting bar	X			
5	Shot group exercises	X			

Subject		Examination		Reexamination	
		Sat.	Unsat.	Sat.	Unsat.
6	Loop sling		X	X	
7	Prone position	X			
8	Squatting position	X			
9	Kneeling } Sitting } positions	X			
10	Hasty sling	X			
11	Standing } Crouch } positions		X	X	
12	Trigger squeeze		X	X	
13	1st sustained fire exercise (cadence)		X	X	
14	Taking prone position rapidly		X	X	
15	Taking squatting position rapidly	X			
16	Taking kneeling position rapidly	X			
17	2d sustained fire exercise	X			
18	3d sustained fire exercise (with dummy rounds)		X	X	
19	Immediate action		X	X	
20	Stoppages		X	X	
21	Effect of wind and sight changes		X	X	
22	Score card	X			

317. RANGE FIRING

a. The range work should be organized so that each man loses only a minimum of his firing time. Long periods of inactivity while awaiting a turn on the firing line should be avoided. To do this—

- (1) Six men per target are about the maximum and three men per target the minimum for efficient handling.
- (2) When four orders are designated on each target, the double coaching system may be employed. This system is particularly desirable because all men are kept busy and get additional practice (dry firing).

b. To organize the range for this system, divide the class into groups of four men each; each group constitutes four orders. At the commencement of firing, order No. 1 fires from the right side of the numbered stake or firing point, coached by order No. 3. On the left side of the numbered stake, No. 2 is dry firing, coached by No. 4. No. 1 sets the pace; that is, he fires the course using the allotted time as directed and as it fits his particular needs. No. 2 keeps pace with No. 1, dry firing in each position until No. 1 has but two shots left in his last position. At this point, No. 1 informs No. 2 that he has but two shots remaining, whereupon No. 2 adjusts his sling for the first firing position, ready to commence firing when No. 1 has finished. At the completion of his firing, No. 1 clears his rifle (No. 2 begins his firing). An officer or noncommissioned officer in-

spects the rifle. No. 1 then returns from the firing line and deposits his equipment. No. 3 gets his rifle, comes up and begins dry firing on the right of the stake while No. 2 is firing on the left. No. 1 coaches No. 3. No. 4 coaches No. 2. This procedure is continued until the four orders have completed all firing. This procedure keeps each man of a four-man group busy all of the time. The double coaching system may be used in both slow and sustained fire.

c. Subject to ammunition allowances, the following range firing has been found to produce uniformly excellent results when the full allowance of time is devoted to this phase of training.

- (1) Firing is begun by a group consisting of approximately half of each organization. This group is made up of those men found to be best qualified as a result of the examination on preparatory work and those known to be good shots. The men who are not included in this first group make up all fatigue details and undergo additional preparatory training.
- (2) After the first group, except those few who have not been firing well, completes its instruction firing, they then fire for record. After these men have completed record firing, they then perform fatigue duties.
- (3) When the first group has completed firing, the second group, made up of those

who have not fired and those who were rejected from the first group, begin instruction firing.

- (4) When the second group completes instruction firing, those who have been firing well and who have a very good chance to qualify, fire for record.
- (5) During the remainder of the allotted time, officers and noncommissioned officers concentrate their efforts on the men who were not considered ready to fire for record with the second group. This last group must complete firing for record by the end of the allotted time for range firing.

d. When range facilities are limited so the entire organization cannot fire at one time without having more than four, or at most, six men per target, the same general scheme as that outlined above may be applied.

- (1) Firing is begun with all of the men of the unit taking part.
- (2) At the completion of instruction firing, all men who have been firing well fire for record.
- (3) The instructors concentrate on the remainder of the organization for the rest of the allotted time.

e. Another system may be used whereby units the size of a company are broken down and the double coaching system is used. The company is organized into three groups. Each group, con-

sisting of about one-third of the company, takes its turn in one of the three stages.

Preparatory training.

Range firing.

Pit detail and interior fatigue tasks of the company.

This reduces the groups to a size that permits four orders per target on the range and further insures that men actually in the process of training can devote their entire time and attention to that training.

f. In preliminary range firing, a time limit of $1\frac{1}{2}$ minutes per shot may be allowed each rifleman. This time limit will not affect the good shots and may be of help to the poor shots. It will prevent waste of time by some men and will help the unskilled rifleman to fire his shots without becoming fatigued.

318. AMMUNITION

The best ammunition available should be reserved for record firing, and the men should have a chance to make their sight settings with that ammunition before record firing begins. Ammunition of different lot numbers should not be mixed.

319. RANGE PROCEDURE

When taking a unit on the range for its first firing, a period of instruction on range procedure should be conducted.

a. The following equipment is required for the lecture demonstration:

1 rifle with sling.

Material for blacking the sights.

Dummy cartridges.

b. The following subjects should be discussed prior to instruction firing.

- (1) *Preparatory work applied.* Range firing is carried on practically the same as a trigger squeeze exercise, except that live ammunition is used.
- (2) *Spotters.* Explain the use of spotters.
- (3) *Disks.* Explain value, color, and use of disks.
- (4) *Duties of the coach.* Explain and demonstrate the duties of the coach while on the firing line. Demonstrate the position of the coach in each position. Officers and noncommissioned officers supervise and assist the men who are acting as coaches and personally coach pupils who are having difficulty.
- (5) *Dummy cartridges.* Explain and demonstrate the use of dummy rounds during range firing.
- (6) *Trigger squeeze.* Explain that if the pupil has not fired a slow fire shot in 10 seconds after he has begun to hold his breath and started his trigger squeeze, his coach should require him to release the pressure on the trigger, look away from the target, breathe, and then start over again. Shots which take a long time to get off are seldom good.

- (7) *Use of telephones.* Explain how the telephone operator, the rifleman, noncommissioned officers, and officer in charge of the firing use the telephone.
- (8) *Shot group.* Explain what is meant by shooting for a group and how this grouping of shots is an indication of correct and expert shooting ability.
- (9) *Accuracy before speed.* Explain that sustained fire is identical to slow fire in all respects except for the fact that the time interval between successive shots is reduced and that all shots should be fired within a given time limit.

Section VI. TRANSITION AND MOVING TARGET FIRING

320. PREPARATION

a. All men must complete the known-distance qualification firing before they are trained in transition firing and in the technique of engaging moving targets.

b. The officer in charge of instruction must be sure that there are enough officers and noncommissioned officers assigned as assistants and that demonstration groups are trained and available before the initial period of instruction. He must make and check arrangements for ranges, target and pit equipment, and communication to have them available for rehearsals and instruction.

321. TRANSITION FIRING

Transition firing is designed to bridge the gap between known-distance firing and field target firing. Individual combat marksmanship is developed by requiring the firer to search for indistinct targets, to estimate ranges, and to place accurate fire on targets within a limited time. The initial step in transition firing is instruction in the theory and use of the battle sight. It includes the use of an aiming point on targets within 400 yards and the application of leads in firing at moving men (par. 208). Three phases of transition firing (tables VI, VII, and VIII) are prescribed for riflemen in the standard qualification course.

322. TABLE VI, PRELIMINARY INSTRUCTION

a. Instruction for firing on a silhouette target, using an aiming point, is given on the known-distance range in much the same manner as for known-distance firing. The target is made locally by pasting two paper E kneeling silhouette targets (ORD Stock No. L001-60-06874) 18 inches apart and equidistant from the center of the target panel on a blank target frame. Approximately in the center of the left silhouette, paste or stencil an aiming point at least 8 inches in diameter. A sheet of white letter size paper (8" x 10½") serves very well with the lower edge 16 inches above the bottom of the silhouette (fig. 122).

b. All firing for table VI is done with the 300-

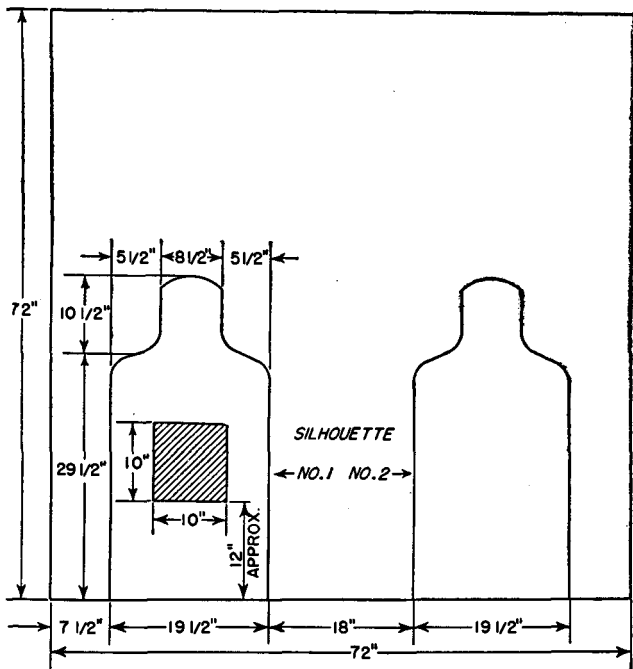

Figure 122. Target used for instruction firing on an aiming point (table VI).

yard battle sight setting. Firing is begun on the 300-yard line. Two shot groups of three rounds each are fired on the left silhouette, using the aiming point to confirm the battle sight and to familiarize the firer with the point of aim. Targets are pulled and spotted after each group is fired. One shot group of three rounds and five single rounds are then fired at the right silhouette. When firing on the right silhouette, the firer is taught to aim at the center of mass (the common

aiming point) using the 300-yard battle sight setting. Targets are pulled and spotted after the shot group of three rounds is fired and after each of the five single rounds is fired. Similarly, firing is done at 200 yards and at 400 yards to provide practice in engaging field type silhouette targets using the battle sight setting.

c. Table VI should be fired at least once and the riflemen should demonstrate proficiency in the use of the battle sight before progressing to tables VII and VIII.

d. While table VI is being fired, give rear area instruction to small groups for firing tables VII and VIII. For example, have the groups practice taking combat firing positions, using mockups of the target positions used in firing table VII. Have them practice the crouch position and alertness while simulating the engagement of surprise targets while advancing.

323. TABLE VII, TRANSITION FIRING

A field target range of the type shown in figure 123 is used for firing table VII. Ranges may vary slightly to fit local terrain conditions. Except for lane 6, no range will be over 400 yards long. (A range for automatic rifle transition firing may be superimposed on the first six lanes of the rifle transition range using the same pits and communications. Three additional pits in lanes 3 and 4 will be necessary if this is done.)

a. Conduct of Fire.

(1) *Sights.* All firing except on the target

in lane 6 is done with the battle sight. Use of the loop sling is prohibited, but firers should be encouraged to use the

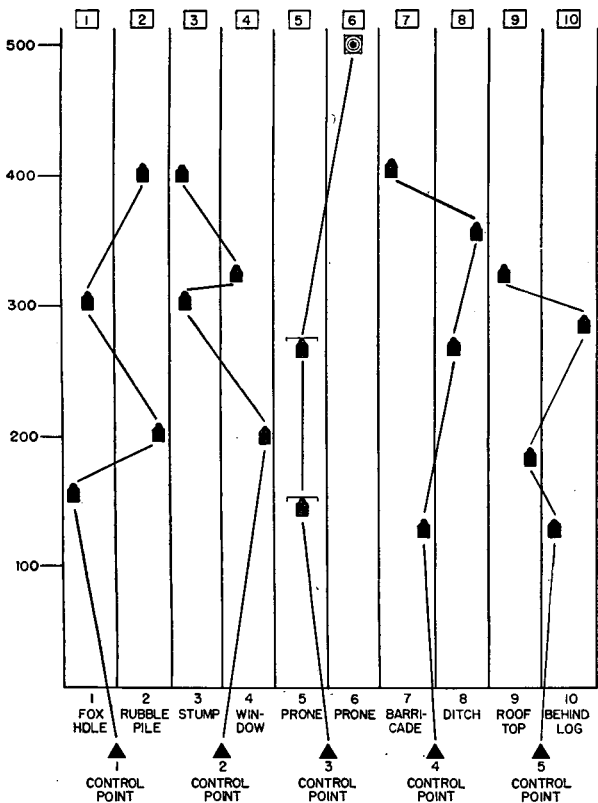

NOTE:

PLACE THE 500-YARD TARGET IN LANE 6 ADJACENT TO THE MOVING TARGET LANE TO FACILITATE SUPERIMPOSING THE BAR TRANSITION COURSE ON THE FIRST 6 LANES OF THE RIFLE TRANSITION COURSE.

LEGEND:

- SINGLE "E" SILHOUETTE
- MOVING TARGET—ONE SILHOUETTE
- "B" TARGET

Figure 123. Layout for a rifle transition range for firing table VII.

hasty sling when the position permits. When firing from the window, the firer should not expose himself, but should engage the target from a position well back from the sill.

- (2) *Targets.* E silhouette targets are used in all lanes except lane 6. A 6 x 6 foot B target is used for lane 6; this target represents the front of a motor vehicle. The moving targets in lane 5 traverse right and left for 30 feet. The direction of movement differs for each of the two targets fired on by the same man.
- (3) *Ammunition.* The firer is limited to four rounds of ammunition on each lane. Except for lane 6, a maximum of two rounds may be used on the first target to appear in each lane.

b. *Procedure for Firing.*

- (1) *Control.* Firing is controlled by an officer who is assisted by a noncommissioned officer (scorer) at each firing point. Each set of two lanes has a control point (telephone) operator who controls the raising or lowering of the targets by verbal messages to the pit operators.
- (2) *Scorers.* The noncommissioned officers (scorers):
 - (a) Designate the limits of the firing lane.
 - (b) Signal the control point operator for targets to be exposed, observe the tar-

gets for hits, and record the scores. The control point operator tells him the number of hits made in lane 6.

- (c) Are constantly on the alert to insure that safety precautions are carried out and, on orders of the officer in charge, check weapons for clearance.

(3) *Suggested method of range control.*

- (a) The men are detailed to firing orders of 10 men each and they line up behind the firing points on each lane. On command of the officer in charge, each firer in the first order examines his rifle to see that it is ready for firing, checks his battle sight setting, moves to the firing point, and assumes the position required for the lane on which he is to fire.

- (b) On a ready signal from the scorers, the officer in charge commands:

LOCK, FOUR ROUNDS, LOAD
READY ON THE RIGHT?
READY ON THE LEFT?
READY ON THE FIRING LINE
COMMENCE FIRING

At the command COMMENCE FIRING, the control operators display either of the two targets in their lanes. To require the firer to search for the targets, the sequence of their exposure in each lane should not be fixed.

- (c) Each target is exposed for 1 minute

unless it is hit. When the target appears, the firer fires on it. If he does not get a hit with his first shot, he fires one more round. As soon as the target is hit, the pit operator twirls the target, withdraws it immediately, and the second target is exposed. If the firer fails to hit the first target, it is withdrawn after it is exposed for 1 minute and the second target is then exposed for 1 minute or until it is hit. The timing is done by the control operators.

- (d) In lane 6, the firer estimates the range, sets the elevation on the rear sight, and has one minute in which to fire four rounds at the B target. As the target represents the front of a motor vehicle, the pit operator scores all hits within the three ring and reports them to the control point operator.
- (e) After completing a lane, each firer moves to the right to the next position except the man on lane No. 10, who moves left to lane No. 1. This procedure is repeated until each man has fired on all 10 lanes. Movement is made on command of the officer in charge and only after all weapons have been cleared. When the first order has fired on all ten points, the second order is rotated through the course. Table

VIII can be run concurrently with table VII and other training may be done in the rear areas at the same time.

324. TABLE VIII, TRANSITION (QUICK) FIRING

A field target range of the type shown in figure 124 is used for firing table VIII. The number of lanes is determined by local terrain and safety conditions. (This layout with minor modifications also accommodates the transition (quick) firing range requirements for the automatic rifle (FM 23-15).)

a. Target Operation.

- (1) Targets between phase lines are exposed in sequence on the signal of the control officer. Signals should not be visible or audible to the firer.
- (2) Phase lines are placed after targets D and G to permit the firer to reload and to aid in the enforcement of safety precautions. A single E silhouette represents an enemy rifleman and is exposed for 3 seconds. A double silhouette represents an enemy automatic rifle team and is exposed for 4 seconds. A triple silhouette represents an enemy machine gun and is exposed for 5 seconds.

b. Firing Procedure.

- (1) At the starting line a control officer orders the firer to lock and load 8 rounds, and to take the prone position.

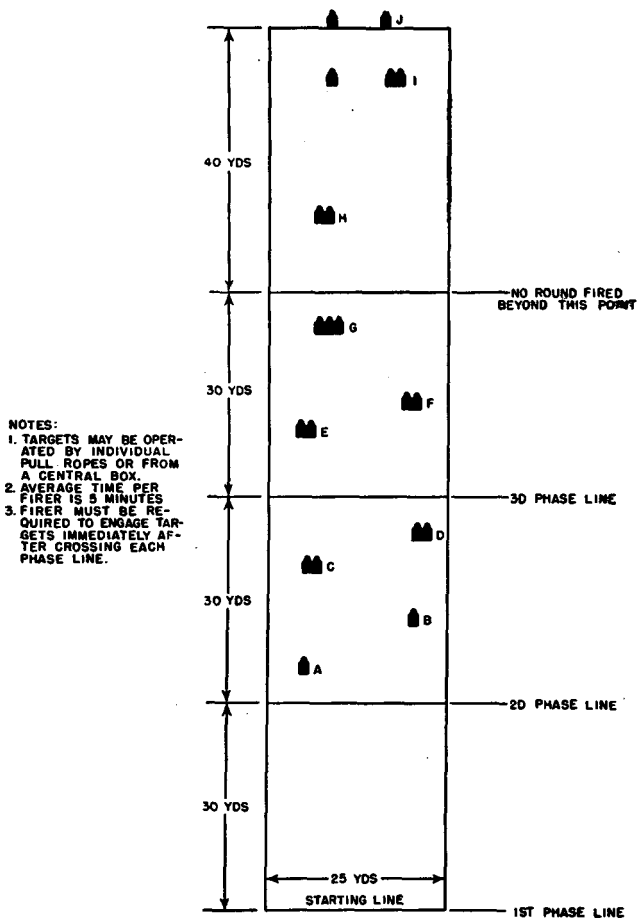

Figure 124. Rifle transition course for table VIII.

Two additional 8 round clips are carried in the firer's belt.

- (2) On signal from the control officer, the firer rises, unlocks his rifle, and ad-

vances down the lane on the alert. As the targets are exposed, the firer fires one round at each individual silhouette. He may fire from the standing position or from the hip (crouch position) and he is required to move forward after engaging each target.

- (3) The control officer or noncommissioned officer accompanies the firer through the course to insure control, to enforce safety precautions, and to critique the firer upon completion. They are followed closely by a scorer who records the hits and pastes the bullet holes.

325. ALTERNATE TRANSITION FIRING COURSE

At installations where facilities are not available for firing transition tables VII and VIII for the standard qualification course, an alternate course may be used. This course may be adapted to existing transition ranges and should conform to tables VII and VIII as nearly as possible.

326. MARKSMANSHIP—MOVING VEHICLES

While there is no prescribed marksmanship course for engaging moving vehicles, this type of training should not be overlooked. This training can be done best with small groups in rear areas concurrently with other range firing. The officer responsible for training in combat marksmanship, through initiative and ingenuity, can set up a number of exercises that will provide profitable instruction. For example:

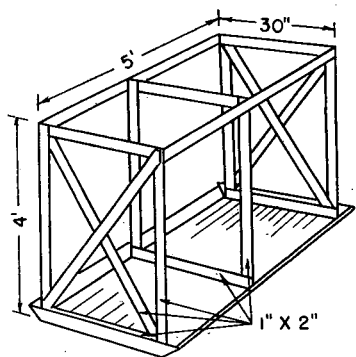

TARGET FRAME

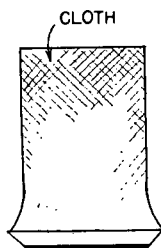

FRONT VIEW OF TARGET

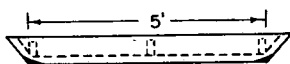

EDGE COVERED WITH SHEET METAL

ELEVATION OF BASE

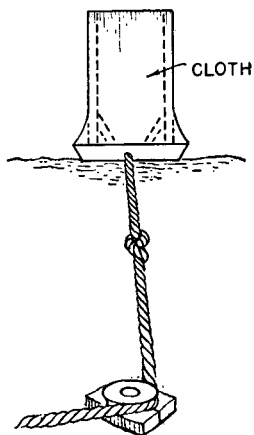

Figure 125. Ground-towed target.

a. Vehicles moving at predetermined speeds at various angles in relation to the position of the group may be used to provide practical work in estimating speed and in judging leads.

b. Practice in aiming and leading can also be obtained by tracking vehicles in the traffic along the roads near the training area.

c. Moving target firing is valuable training when time and facilities permit.

(1) A sled target, with a low center of gravity, of the type shown in figure 125 can be constructed of scrap material and can be towed over rough ground.

(2) To tow this target with a vehicle, use 500 yards of half-inch rope. The pulley seen in figure 130 is a channel wheel bolted to a wooden or metal base which is firmly staked down. A knot is made in the tow rope 10 to 12 feet from the target. This will hit the wheel and throw the rope off the pulley, causing the direction of the target to change. A schematic layout for a moving target range is shown in figure 126.

Section VII. TECHNIQUE OF FIRE

327. GENERAL

The instructor should secure equipment, inspect ranges, and detail and train his assistants, including demonstration units, before the first period of instruction. Instructors should use their initiative in arranging additional exercises

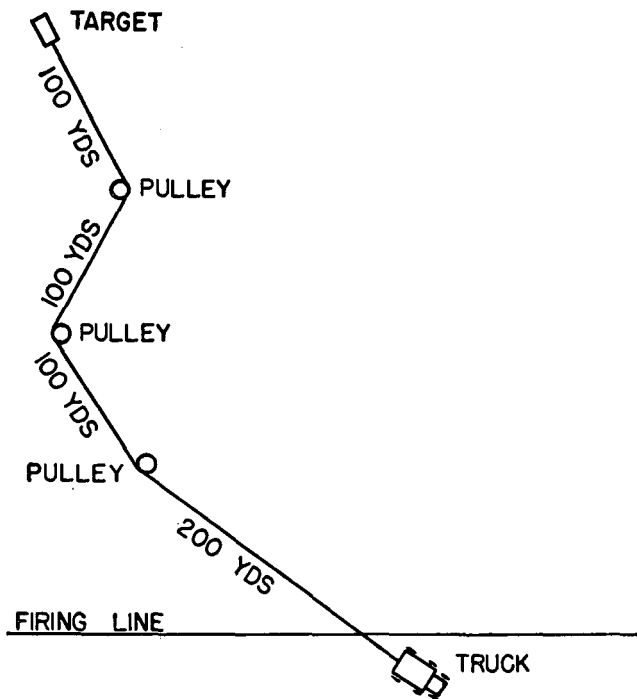

Figure 126. Setup for towed target firing.

to apply the fundamentals and methods that follow. Explain to the students how the exercises are used to illustrate the technique of fire.

328. RANGE DETERMINATION

a. To train men to estimate range, particularly by eye, the 100-yard unit of measure must be established in their minds. Their attention is called first to measured units laid out in the bar-

racks and training areas. During marches and field exercises they are given practice in estimating ranges to prominent terrain features such as buildings, trees, and road intersections. In a similar manner, they are taught to observe the appearance of objects at known distances.

b. Plan for a number of range estimation areas as shown in figure 127. When facilities permit, these areas should be near other training locations so that practice in range estimation can be conducted along with other training.

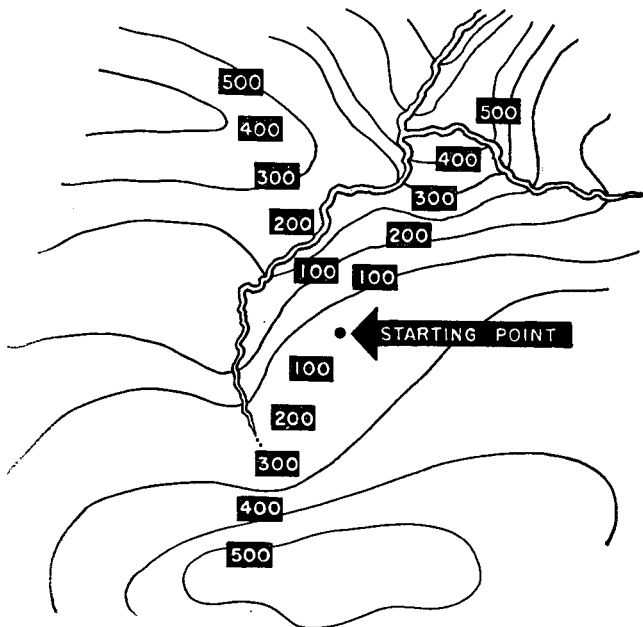

Figure 127. Diagram of an area used for teaching the application of the 100-yard unit of measure (schematic).

c. The range estimation cards shown in figures 128① and 128② are used in the initial instruction to provide a record of progressive proficiency. Squad leaders are required to check their men and give individual attention to those men found to be below standard. If the soldier can recognize an error and if he understands *why* an error is made, he will learn to make the necessary allowance for factors of light, weather, and terrain.

RANGE ESTIMATION CARD

Name Cpl John A. Smith
 Company Ab'l Company, 1st Inf.
 Squad 2d Squad

NUMBER	ESTIMATE	CORRECT	%	REMARKS	NUMBER	ESTIMATE	CORRECT	%	REMARKS
1	325	250	30	Guess!	21				
2	420	500	16	Bright sun!	22				
3	250	175	40	Deep Gully!	23				
4	275	325	15	Target too dim!	24				
5	500	675	27	and windy ground	25				
6					26				
7					27				
8					28				
9					29				
10					30				
11					31				
12					32				
13					33				
14					34				
15					35				
16					36				
17					37				
18					38				
19					39				
20					40				

①

Range estimation card.

Figure 128.

TABLE FOR COMPUTING ERRORS IN RANGE ESTIMATION

Range in Yards	Error in Yards										
	5	10	15	20	25	30	35	40	45	50	100
250	2	4	6	8	10	12	14	16	18	20	40
275	2	4	5	8	9	11	13	15	16	18	36
300	2	3	5	7	8	10	12	13	15	17	33
330	2	3	5	6	8	9	11	12	14	15	30
350	1	3	4	6	7	9	10	11	13	14	29
380	1	3	4	5	7	8	9	11	12	13	26
400	1	3	4	5	6	8	9	10	11	13	25
420	1	2	4	5	6	7	8	10	11	12	24
440	1	2	3	4	6	7	8	9	10	11	23
460	1	2	3	4	5	7	8	9	10	11	22
480	1	2	3	4	5	6	7	8	9	10	21
500	1	2	3	4	5	6	7	8	9	10	20
520	1	2	3	4	5	6	7	8	9	10	19
540	1	2	3	4	5	6	7	8	9	10	19
560	1	2	3	4	4	5	6	7	8	9	18
580	1	2	3	3	4	5	6	7	8	9	17
600	1	2	3	3	4	5	6	7	8	8	17
620	1	2	2	3	4	5	5	6	7	8	16
640	1	2	2	3	4	5	5	6	7	8	16
660	1	2	2	3	4	5	5	6	7	8	15
680	1	1	2	3	4	4	5	6	7	8	15
700	1	1	2	3	3	4	5	6	6	7	14
720	1	1	2	3	3	4	5	6	6	7	14
740	1	1	2	3	3	4	5	6	6	7	14
760	0	1	2	3	3	4	5	5	6	7	13
780	0	1	2	3	3	4	4	5	6	6	13
800	0	1	2	3	3	4	4	5	6	6	13
850	0	1	2	2	3	3	4	5	5	6	12
900	0	1	2	2	3	3	4	4	5	6	11
950	0	1	2	2	3	3	4	4	5	5	11
1000	0	1	2	2	3	3	4	4	5	5	10

NOTE.—Example of the use of this table: Suppose the correct range to be 695 yards and the estimated range to be 635. The "error in estimate" is consequently 60 yards. Select two "errors in estimate" in the 700-yard space (the nearest to the correct range given in the table) whose sum is 60 yards, as 50 and 10. Add the percentages shown thereunder, and the result will be approximately your error. In this case:

$$7 \text{ plus } 1 = 8\%$$

- (2) Reverse side of range estimation card. (Table for computing errors in range estimation by eye.)

Figure 128—Continued.

The unskilled man's average error in estimating range is about 30 percent. The training objective is to reduce the percentage of error to the minimum.

329. EXERCISES IN RANGE DETERMINATION

The exercises suggested in this section are designed to give the soldier a thorough understanding of the principles to be used in estimating ranges by eye. These exercises alone are not enough to insure continued proficiency in this subject. Proficiency can be acquired, maintained, and improved only by regular periods of practical work. When possible, short periods of practical work should be included in all types of field training.

330. EXERCISE NO. 1

a. Purpose. This exercise familiarizes the soldier with the 100-yard unit of measure, and the method of applying it in estimating ranges on varied terrain.

b. Method. The unit of measure (100 yards) is staked out on one or more courses over varied terrain, using markers that are visible at 500 yards. The men start from a centrally located point if more than one course is to be practiced. From this point they can compare the appearance of the 100-yard units of measure over the varied terrain. They are then moved to a point (400-yard marker) within 100 yards of a selected 500-yard marker and are formed facing that marker.

They are given an opportunity to study and to fix firmly in their minds, the 100-yard mental unit of measure. Then they move back toward the starting point until all are on line with the 300-yard marker (200 yards from the 500-yard marker). They are then moved to a point on line with the 200-yard and then the 100-yard markers, thence to the starting point. At each stopping point, they study the appearance of the 100-yard unit of measure and apply it successively up to 500 yards. This exercise should be practiced at each of the ranges in the prone, kneeling, and standing positions. The unit receiving instruction may be divided into two or more smaller groups. These groups are rotated over several courses in the area.

331. EXERCISE NO. 2

a. Purpose. This exercise provides the soldier with practice in applying the unit of measure.

b. Method.

- (1) Ranges up to 500 yards are measured accurately and marked at every 100 yards by large markers on target frames, each bearing a number to indicate its range. The men take positions at least 25 yards to the flank of this course. They are directed to hold some object before their eyes to obstruct their view of the markers. Then they estimate 100-yard units of measure along a line parallel to the unseen line of markers. When they have

mentally selected the five 100-yard units of measure, they compare their estimated 100-yard units with the markers. Repetition of this exercise will help to develop accuracy.

- (2) Ranges greater than 500 yards are estimated in a similar manner. The men estimate ranges to points which are obviously more than 500 yards away and a little to one side of the line of markers. As soon as they have announced each range, they check the range to the target and to the halfway point by means of the markers. The prone, standing, and kneeling positions are used in this exercise.

332. EXERCISE NO. 3

a. Purpose. This exercise provides practice in range estimation.

b. Method. Ranges are measured from a suitable position to various objects within 1,000 yards. The objects selected should be so located that the men cannot make comparative judgments of range, but will have to make independent estimates. The instructor points out these objects and the men enter their estimates on range estimation cards or work sheets (fig. 128①). They should make at least one-half of their estimates from the prone or kneeling positions. Not more than thirty seconds is allowed for each estimate. When the men have entered their estimated ranges to five or six objects, the instructor an-

nounces the true ranges and requires the men to compute their percentage of error in each estimate. In the remarks column of the range estimation card, the men enter any comment, such as the nature of the terrain or the climatic condition which caused the error. By maintaining individual records and squad averages, interest and competition can be developed. Also, the men who are below standard are readily spotted and can be given additional instruction.

333. EXERCISE NO. 4

a. Purpose. This is an exercise to demonstrate a soldier's appearance at different ranges.

b. Method. From a suitable position on level open terrain, men are placed in concealed positions at 100-yard intervals for a distance of 500 yards. The class studies the appearance of the men at different ranges.

- (1) On signal, all men down range stand up. The instructor points out that the men seem to decrease in size as the distance to them increases. He calls attention to the gradual disappearance of details (facial features, hands, arms, legs, helmet, belt, and rifle). The class is required to make notes of the ranges at which the details are no longer visible.
- (2) On signal, all posted men kneel. The class then studies the kneeling figures. The instructor calls the class's attention to the details of the kneeling men. They will seem to disappear at closer ranges

than when they were standing. Again the class makes a note of the ranges at which the details are no longer visible.

- (3) On signal, all posted men take up the prone firing position and aim their rifles at the class. The class studies the appearance of the prone figures. The instructor points out that fewer details are visible now, even at the shorter ranges. The class makes a note of the ranges at which details are no longer visible.
- (4) The exercise must be practiced with the class facing the sun and facing away from the sun.
- (5) Similar exercises should be given using vehicles and several types of crew-served weapons to demonstrate the appearance of common items of equipment at various ranges.

334. RULES FOR INSTRUCTORS

- a.* Know the exact ranges used in the exercises.
- b.* Announce the ranges to each target after the men have made their estimates and before any change occurs in light conditions.
- c.* Point out why an object appears to be nearer or more distant.
- d.* Move to new terrain as often as possible and teach each man to make his estimate without props or aids.
- e.* Teach the men to study the ground between

them and the target. Use typical combat targets, to include trees, bushes, rocks, ridge lines, edges of woods, weapons, positions, buildings, and bridges.

f. Use varied backgrounds such as the sky, woods, open fields, and bodies of water.

g. Give the men practice in estimating varied ranges from 100 to 1,000 yards; however, concentrate on ranges of 600 yards and under.

335. EFFECT OF RIFLE AND AUTOMATIC RIFLE FIRE

Use the blackboard for instruction and demonstrate the effects of rifle fire by having several riflemen fire tracer bullets. Trajectory, danger space, dispersion, classes of fire, and related matters should be covered. All men should be required to have a ready understanding of the common terms used in this phase of training.

336. FIRE COMMANDS

a. Begin with targets that are clearly visible and easily recognized. Have the men keep their fire commands brief, clear, and simple. When they progress to indistinct targets, encourage them to use reference points and finger measurements in their commands.

b. Landscape target panels can be effectively used during fire command training. In inclement weather they can be used indoors.

337. APPLICATION OF FIRE

a. Devote enough time and explanation to the

method of fire distribution (using a blackboard) to insure that all men fully understand it and can explain it in their own words.

b. Use a squad firing tracer ammunition to demonstrate the methods of applying fire.

Section VIII. LANDSCAPE TARGET FIRING

338. GENERAL

Explain and demonstrate the procedure for scoring, for zeroing rifles, and for firing on the landscape targets. The ability to give and understand an oral fire command is important in this phase of training. Before firing any exercise, give all the men practical work in giving oral fire commands for targets on the landscape panels.

339. EXERCISE NO. 1

a. Purpose. This exercise is used to teach target designation and to show the effect of concentrated fire.

b. Method. The squad leader directs the fire of his squad at a point target indicated to him by the instructor.

340. EXERCISE NO. 2

a. Purpose. This exercise is used to teach target designation and the division of the squad fire on two point targets.

b. Method. The instructor indicates two point targets to the squad leader. The squad leader

divides his squad fire between the two targets as directed by the instructor. The scores on each target are combined to give the total score for the exercise.

341. EXERCISE NO. 3

a. Purpose. This exercise is used to teach fire commands, fire distribution, and fire control for diverting part of the fire of the squad to a suddenly appearing target.

b. Method. The instructor indicates a target of width (linear target) to the squad leader. The squad leader applies the fire of his squad to this target. After firing has commenced, the instructor indicates and gives the nature of a point target on either flank. He then directs the squad leader to shift the fire from the first to the second target. A simple method of scoring this type of exercise is to add the value of hits on the point target, the value of hits on the target of width, and the score for distribution on the target of width, and divide this sum by two. This provides a score for the problem on a basis of a possible 100 points.

Section IX. FIELD TARGET FIRING

342. TERRAIN

a. In preparing problems for field target firing, an important consideration is the selection of terrain which fulfills the requirements of safe-

ty regulations (SR 385-310-1). Safety angles, target positions, and other related details should be plotted on a map and coordinated with units in adjoining areas.

b. Where possible, select varied terrain suitable for several squads firing at one time. Control the firing from a centrally located position. If possible, use ground that is not familiar to the men being trained.

343. THE RANGE

a. Ranges for field firing exercises can be efficiently operated without an elaborate system of shelters and dugouts. Simple pits to accommodate the target operators are sufficient (fig. 129).

b. Avoid altering the natural appearance of the terrain when locating and camouflaging targets and when locating and constructing pits.

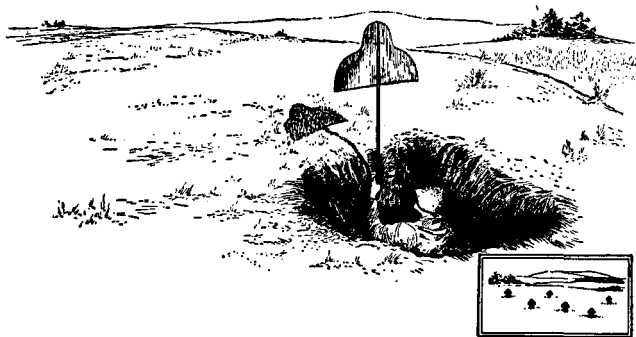

Figure 129. A method of displaying a surprise target to represent skirmishers. (Cutaway behind pit prevents ricochet rounds from rebounding into pit.)



Figure 130. A surprise target at the pit. (See figure 131 for details of operation.)

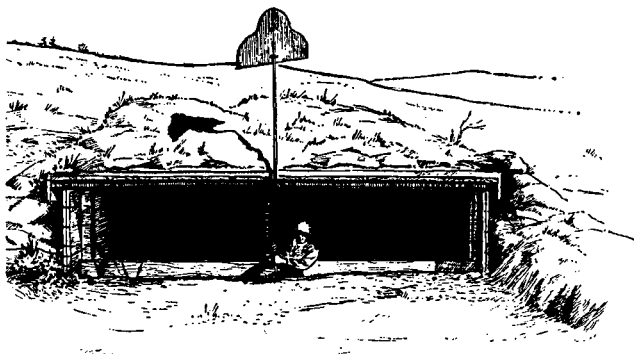

Figure 131. A method of exposing a surprise target. (See figure 130 for front view.)

c. When targets are placed in the rear or to one side of the pits, the likelihood of ricochets falling into the pits is minimized. If tracer ammunition is to be used, it is best to have covered pits. See figure 130 for a view from the firing line and figures 131 and 132 for rear views. It

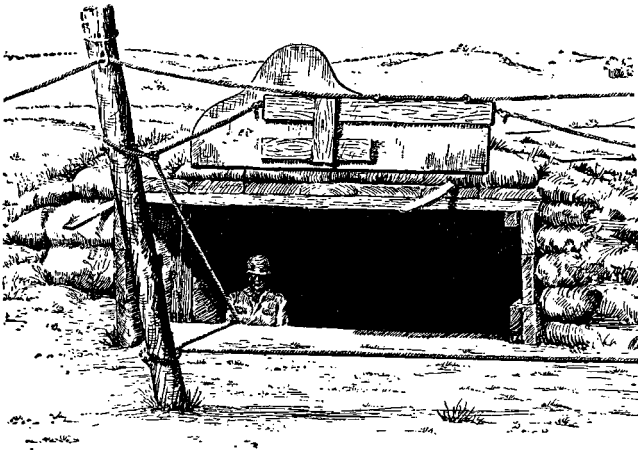

Figure 132. A method of exposing a surprise target moving along the ground (crawling man).

is desirable to have all pits and the firing line connected by telephone. If available, small portable two-way voice radio sets may be used.

344. TARGETS

a. Targets may be improvised or they may be obtained from the Ordnance Department.

b. A stationary target may be represented by E or F (ordnance) targets placed on stakes and driven in the ground or set in sockets.

c. A surprise target that can appear and disappear may be made by using E or F targets fastened to an I-beam, rope, or pole, and operated by a man in a pit (figs. 129–132, 134–138).

d. A movable field target may be made by fastening E or F targets to a sled, or by suspending such targets from a wire (figs. 133 and 138).

e. In the field, targets should be placed in locations that would be used by an intelligent enemy. They should not be prominently exposed nor should they be in a regular line (figs. 139 and 140). Targets should vary in size and in degree of concealment. The exposure of surprise targets, kept out of sight at the beginning of an exercise, may be indicated by firing blank ammunition or by using other noise- or smoke-producing

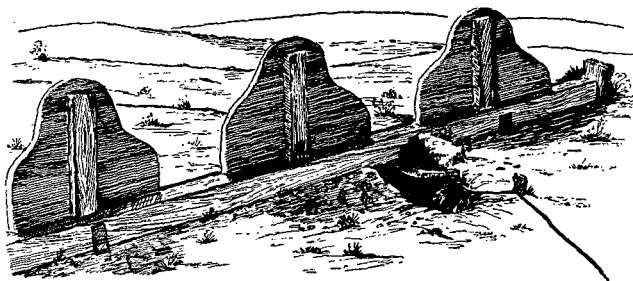

Figure 133. A method of raising surprise point targets. (Pull rope and counterweight in rear.)

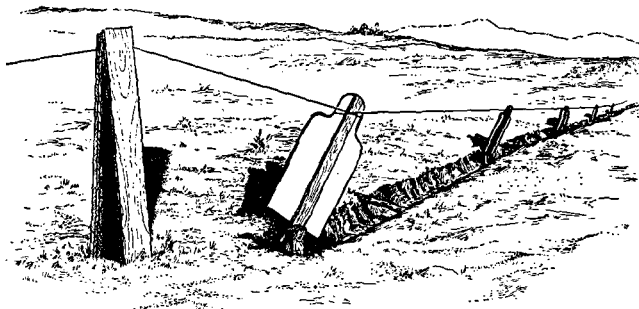

Figure 134. A method of raising surprise targets (linear target).

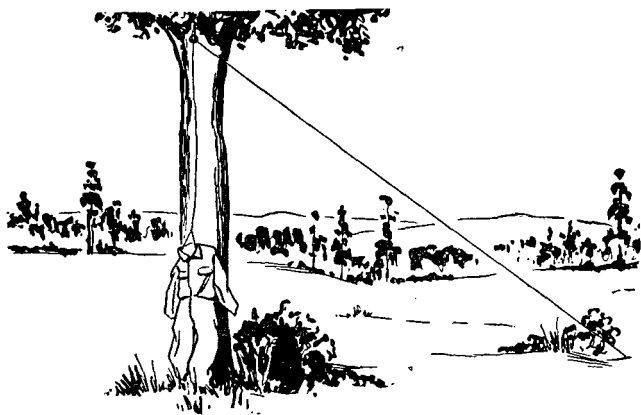

Figure 135. A method of raising a surprise target in a tree (sniper).

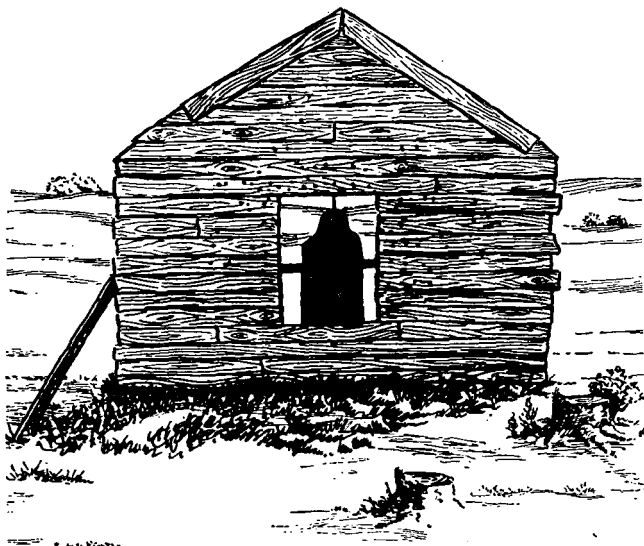

Figure 136. A surprise target appearing in a window.

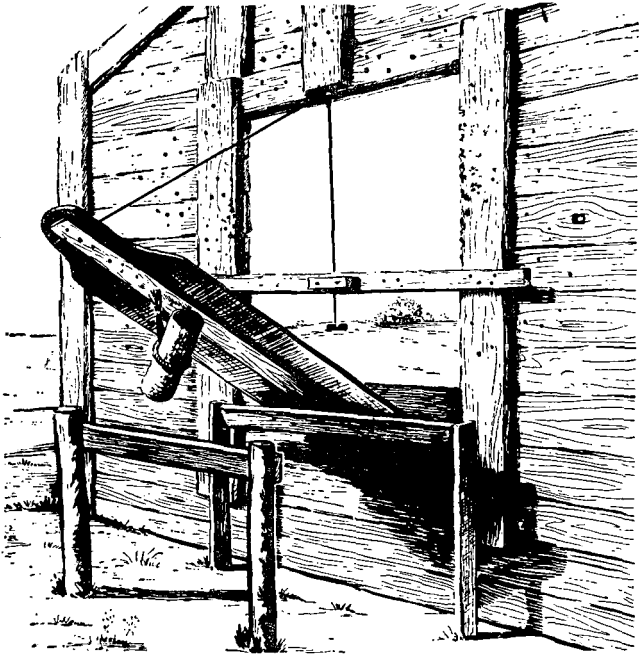

Figure 137. A method of raising a surprise target from the pit.

equipment near the target (figs. 141, 142, and 143). To test the skill of the squad leader in designating targets and in adjusting fire, targets may be placed so they can be seen with the binocular but not with the naked eye.

f. The appearance of the targets from the firing line will depend a great deal on the direction of the sun, the background of the targets, and the angle at which the targets are placed. These

factors should be considered when placing targets for an exercise.

345. SAFETY

a. In general, safety precautions for known-distance range firing apply with equal force to field target firing (SR 385-310-1). Safety of personnel is of primary importance during exercises fired with live ammunition. To this end, exercises should be planned to fit the training stage of each unit.

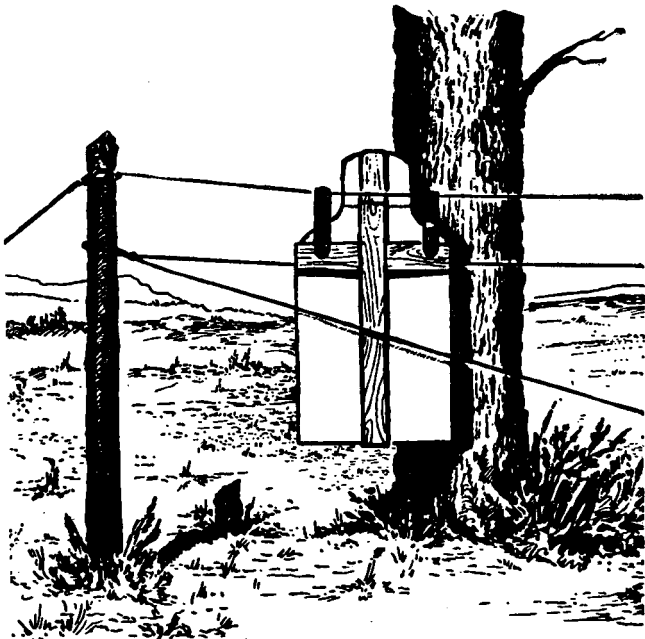

Figure 138. An arrangement for moving a surprise target along a horizontal line (running figure).

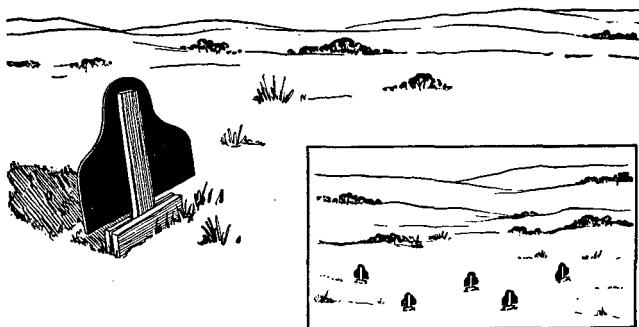

Figure 139. A method of setting up targets to represent skirmishers.

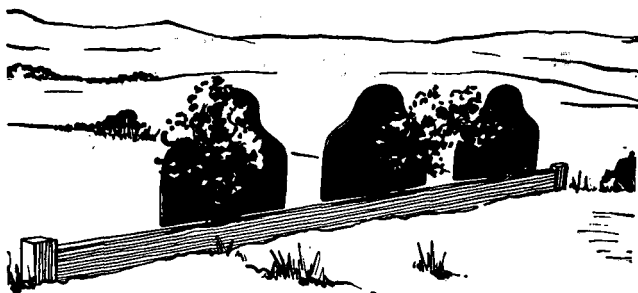

Figure 140. A method of breaking the outlines of silhouette targets.

b. The officer in charge of an exercise is responsible for the safe conduct of the firing. It is his duty to initiate and enforce instructions that will provide maximum personnel safety. No officer may modify his instructions who does not assume responsibility for the safety of the firing.

c. Firing will not start until the range is clear, the pit details are under cover, and all safety

precautions have been complied with. On completion of each exercise, the officer in charge will have all rifles unloaded and inspected and all ammunition collected. After all rifles are cleared, the targets are scored for hits.

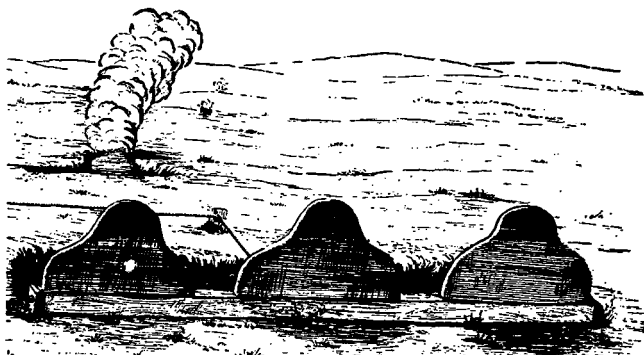

Figure 141. An arrangement for showing a surprise (point) target and creating machine gun fire for sound effect. Note that dust is raised by the strike of light machine gun rounds into the earth.

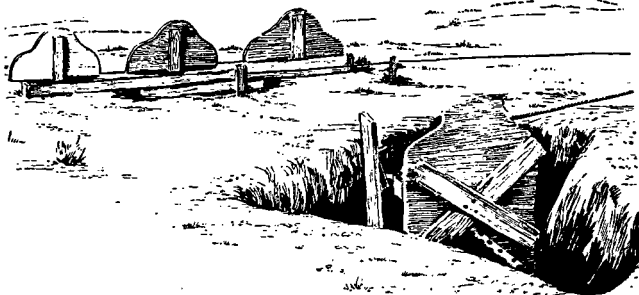

Figure 142. An arrangement for raising surprise targets and producing fire to attract attention. (A cardboard shield protects the light machine gun from dirt.)

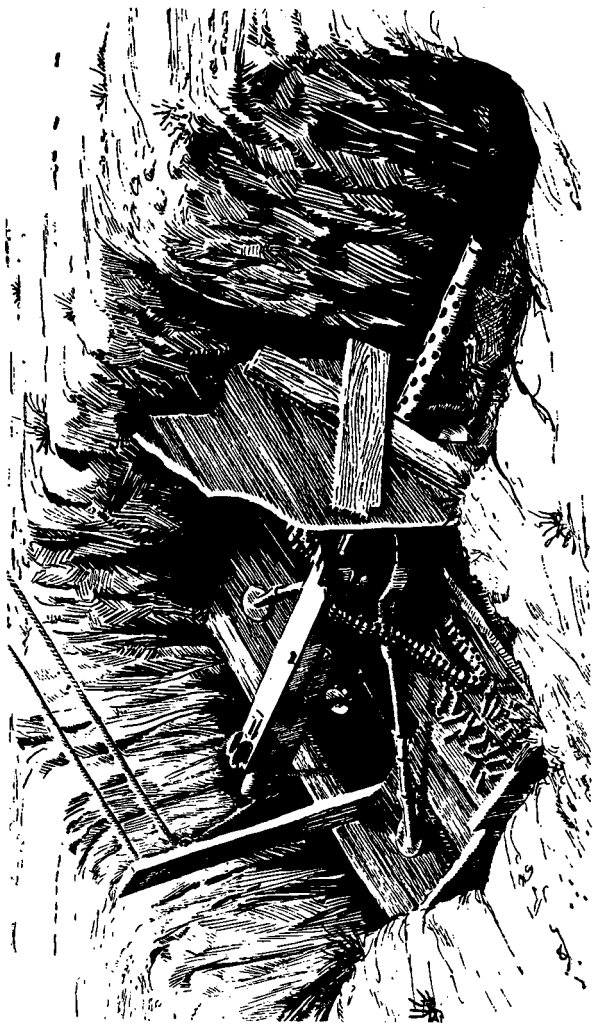

Figure 143. Details showing a method of installing a light machine gun to produce a sound effect.

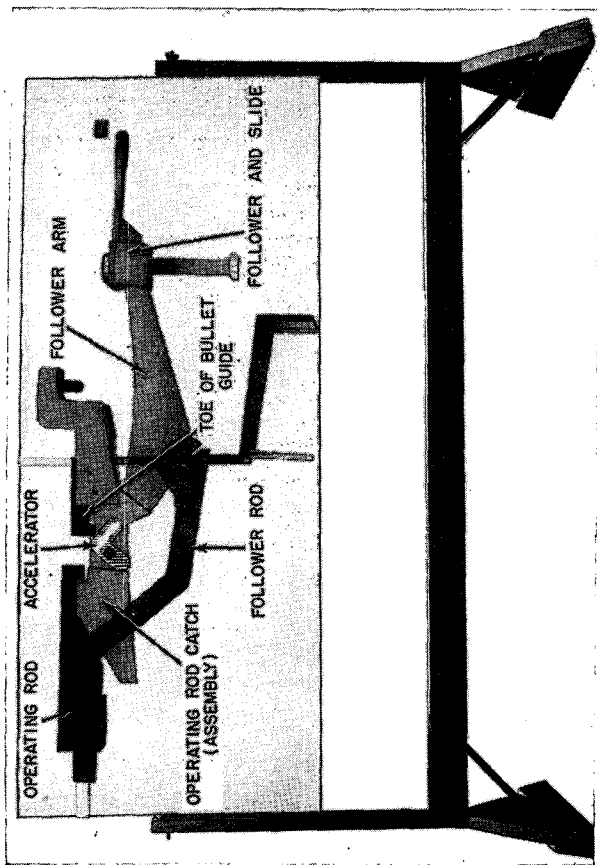

Figure 144. A working model of the barrel and receiver group.

Section X. TRAINING AIDS

346. GENERAL

There is an old saying that one picture is worth a thousand words. With this principle in mind, our army uses working models, charts, and other suitable visual training aids for conducting training. Excellent rifle training aids are available through normal supply channels or they can be constructed locally. Some recommendations and suggestions concerning the construction and use of the various rifle training aids are listed below.

a. Scrap lumber in good condition may be used to construct models. Hardwood is recommended for model parts that rub together or have strain on them. Other materials which are needed in making models are nails, screws, and lengths of screen door spring.

b. Charts and models should be painted with contrasting colors to help the class locate the various parts.

c. Models should be mounted on stands so they can be seen by the entire class.

d. Working models are designed only to show the functioning of the parts, so they will lack some of the refinements of the weapon. Some of the parts on the model are cut away in order to show parts not otherwise visible which play an important role in functioning.

e. A scale of one to ten will enlarge drawings or models to a size large enough to be seen at a distance of 75 feet.

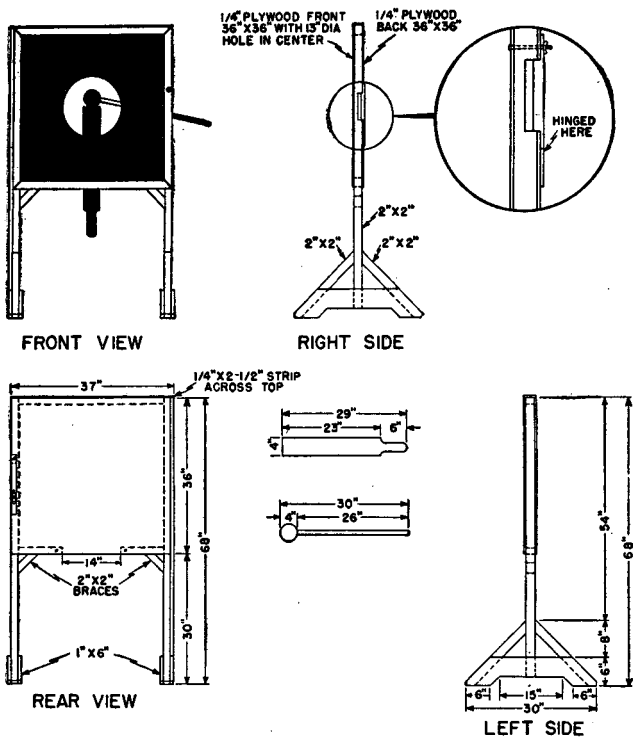

Figure 145. A model sight picture device.

f. All lettering on charts, models, and other training aids must be large enough to read easily. Lettering $2\frac{1}{2}$ inches high can be read at a distance of 75 feet.

g. Charts which are painted or drawn on heavy paper will be just as satisfactory as those painted on wood. Charts painted on wood will withstand harder usage than paper charts.

h. Before using a multicolored chart or work-

ing model, explain the significance of the various colors.

347. WOODEN WORKING MODELS

Large scale working models (fig. 144) are excellent training aids in teaching the functioning of the M1 rifle. When such working models are

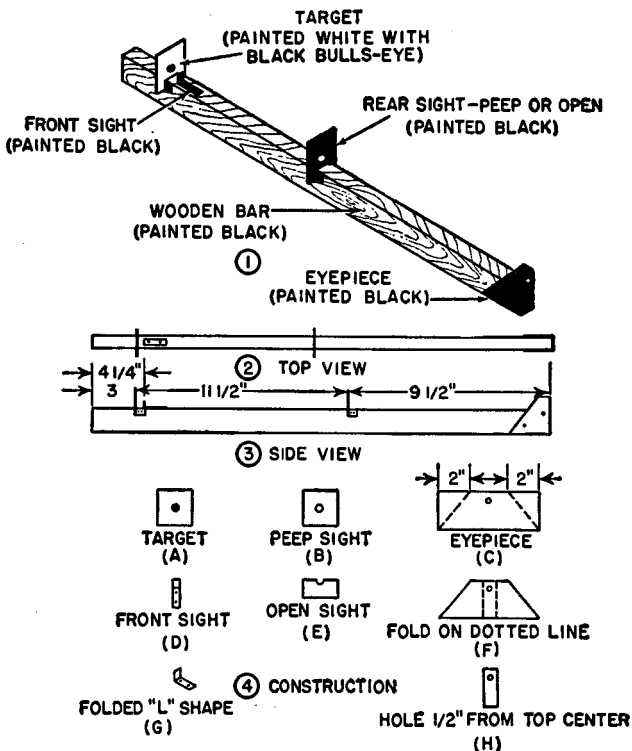

Figure 146. Diagram for making a sighting and aiming bar.

not already available, their construction for use on a one-time basis is not recommended. However when they are to be used by several units or can be used repeatedly by the same unit, their construction is warranted.

348. EXAMPLES OF TRAINING AIDS

a. Figures 145 to 150 show some of the more important training aids that easily can be constructed and profitably used in teaching rifle marksmanship.

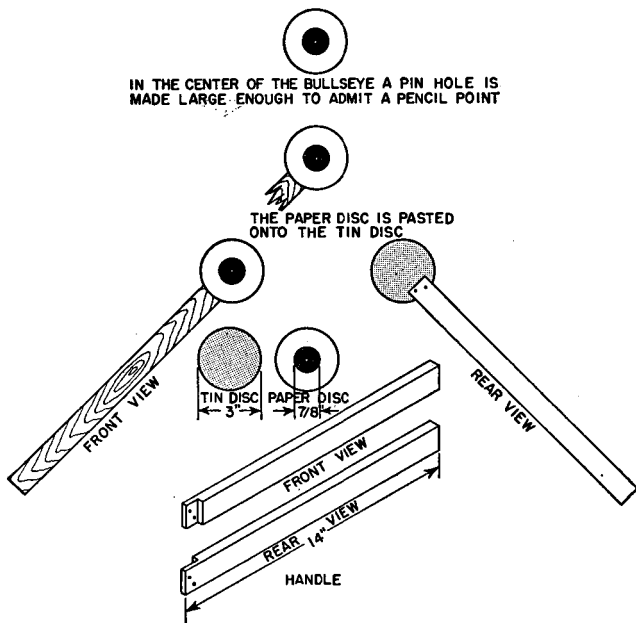

Figure 147. The sighting disk.

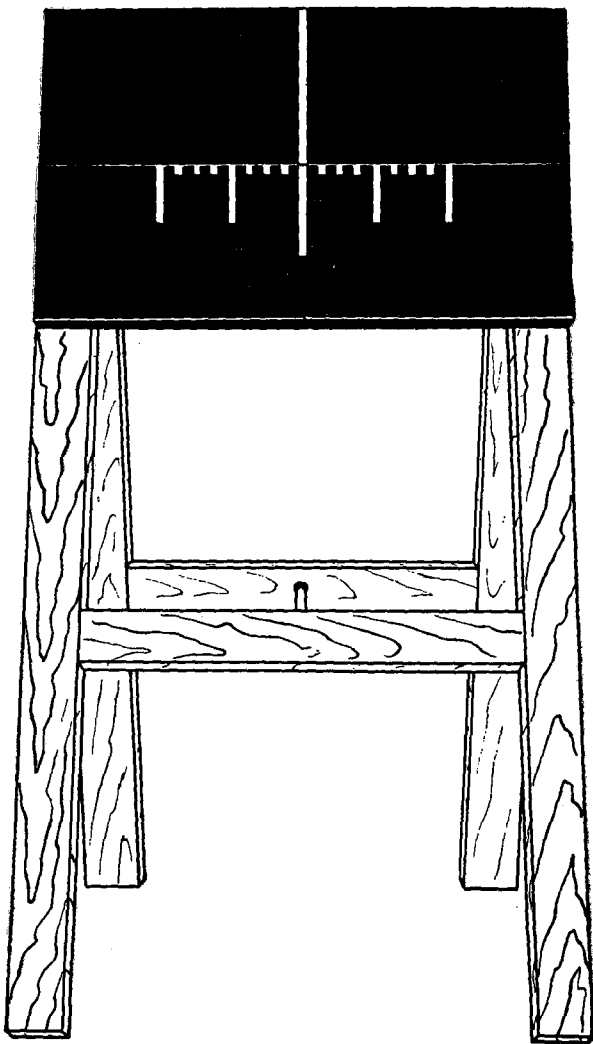

Figure 148. The rear sight windage gage.



Figure 149. The one-man sighting and aiming device.

b. A device similar to the one shown in figures 149 and 150 can be used to show a sight picture, with or without a bull's-eye and with or without errors in alinement.

c. By using your imagination and ingenuity, you can improvise other training aids with available material to help you to clarify your instruction.

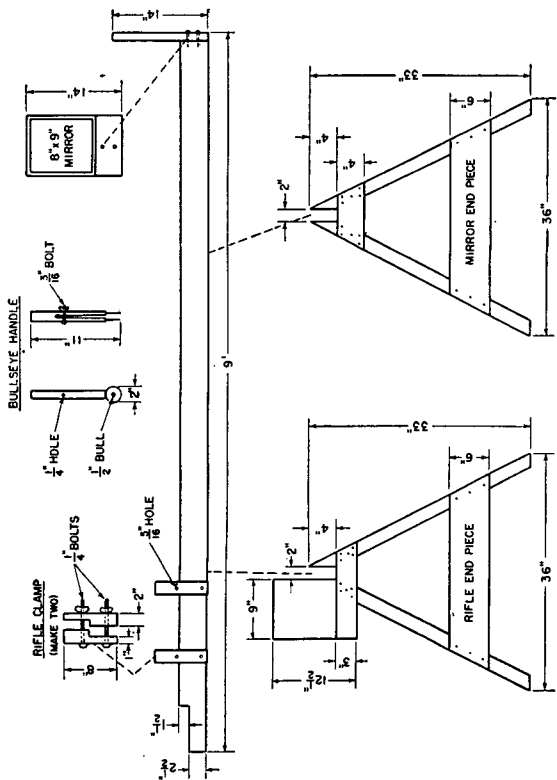

ONE MAN SIGHTING AND AIMING DEVICE

Figure 150. A dimensional drawing of the one-man sighting and aiming device.

RIFLE, U.S., CAL..30, M1

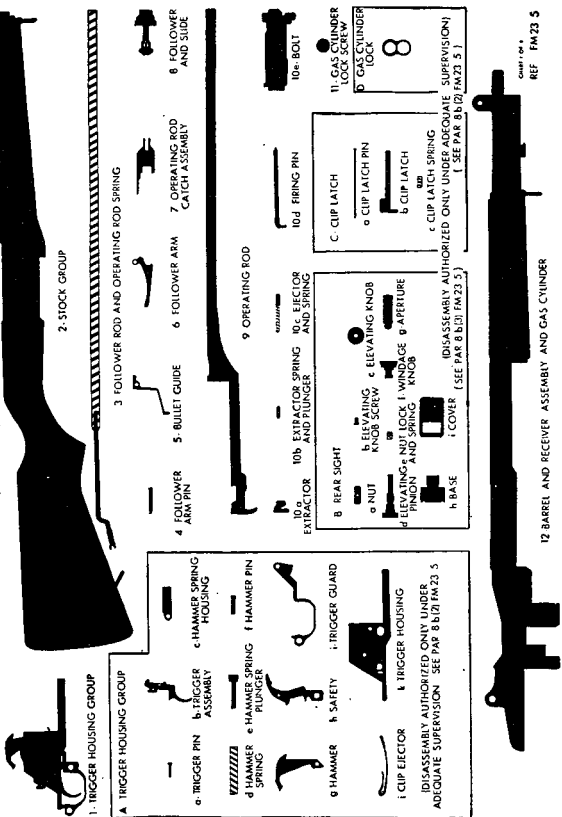

Figure 151. Graphic training aid 9-58.

349. CHARTS

a. Charts may be made to illustrate any part of the manual if they will aid the instruction. Some of the points that can best be presented by a chart are—

- (1) Steps in functioning.
- (2) Stoppages.
- (3) Steps in cleaning the rifle.
- (4) Clock system of describing wind direction.
- (5) Elements of the fire command and target designation.

b. Use these and other charts in conjunction with lectures and demonstrations to help convey important points of instruction.

c. Other training aids which will be of great help and which can be obtained through normal supply channels are—

- (1) Appropriate training films and film strips.
- (2) Graphic training aids. One such graphic training aid is shown in figure 151. This is a plastic disassembly mat used during instruction in mechanical training.

CHAPTER 7

SAFETY PRECAUTIONS

350. GENERAL

a. The safety of personnel is the first concern of everyone during any exercises in which live ammunition is fired. To minimize the possibility of accidents, certain safety regulations have been established (SR 385-310-1). All officers conducting any type of firing are responsible for—

- (1) Becoming familiar with the safety rules covered in these regulations and any additional safety rules pertaining to the handling of specific weapons or ammunition as found in field and technical manuals or local safety precautions.
- (2) Teaching you the meaning of these safety regulations.

b. You are responsible for your own safety and that of others around you. You are also required to help enforce safety regulations on the range.

c. The precautions covered in this chapter are not intended to replace the regulations contained in SR 385-310-1.

351. SAFETY PRECAUTIONS, MECHANICAL TRAINING

The following list gives the more important safety precautions to be observed during mechanical training.

a. Start observing safety precautions as soon as you receive a weapon.

b. Never playfully or carelessly point your weapon at anyone.

c. Check the chamber and receiver to see that there are no live rounds in the weapon.

d. Check among the spare parts and tools to make sure that there are no live rounds among them.

e. Check all dummy rounds to make sure that there is no live ammunition among them.

352. SAFETY PRECAUTIONS, PREPARATORY MARKSMANSHIP TRAINING

The following list covers safety precautions for you to observe during preparatory marksmanship.

a. Comply with all safety precautions prescribed for mechanical training.

b. On the command CEASE FIRING, take your finger off the trigger and lock the rifle.

c. Before leaving the preparatory line, clear your rifle, open the bolt, and lock the rifle.

d. Keep the muzzle pointed in the air and down range. (On the range you will often hear your instructor tell you to keep your weapon pointing in the air and down range. You will first hear this precautionary warning during preparatory marksmanship. Observe this rule whether you are on the preparatory field or carrying your rifle to or from the firing line on the range.)

353. SAFETY PRECAUTIONS, RANGE FIRING

a. Safety precautions are important during all training, especially on the range. Do not relax your observance of safety precautions or assume that a weapon is unloaded until you have checked it carefully.

b. Safety precautions that have been established for mechanical training and preparatory marksmanship phases of instruction also apply during range practice. In addition to those safety precautions, observe the following:

- (1) Do not draw or issue ammunition until the officer in charge of firing gives the command.
- (2) Do not start firing until all safety requirements have been fulfilled. These requirements include:
 - (a) Orientation of all firers regarding safety regulations and other pertinent information.
 - (b) All designated road blocks and road guards are established and maintained until the completion of firing.
 - (c) The officer in charge of operating the pits, who is responsible for the safety of the pit detail, reports on clearance of the pits to the officer in charge of firing. A red flag is displayed above the pits until a clearance has been given to the officer in charge of firing. The command to lower the flag is given by the officer in charge of firing.

- (d) A red streamer is displayed from a prominent place on the range during all firing. Do not fire unless it is displayed. The range streamer serves as a warning to everyone who enters the range that firing is being conducted.
- (e) All weapons are checked by an officer to see that none contain live ammunition. Your weapon is checked as soon as you arrive on the range. Consider every weapon as being loaded until it is examined and found to be unloaded.
- (f) At the same time weapons are checked for safety clearance, they are checked for obstructions in the bore such as rust-preventive compound, cleaning patches, and mud or snow.
- (g) There are safety limits on the right and left flank of the range. Do not fire past them. You will be given necessary information about the right and left safety limits before firing.

c. During firing.

- (1) Load and unload your weapon only on the firing line.
- (2) Load your weapon only on command of the officer in charge of firing.
- (3) The commands COMMENCE FIRING and CEASE FIRING are made loud and clear. When you hear the command CEASE FIRING, take your finger off the trigger and lock the rifle. Wait for

further instructions. *Anyone* who considers it necessary, to insure safety, may give the command CEASE FIRING.

- (4) As soon as the firing exercise is completed or on command, clear your weapon—open the bolt and lock the rifle.
- (5) Do not move in front of the firing line for any reason unless you are directed to do so by the officer in charge of firing. Before this permission is granted, he will order all rifles to be cleared and will have each one checked by an officer or noncommissioned officer in charge of that portion of the firing line.
- (6) No rifle is moved in front of the firing line.
- (7) When moving back and forth to the firing line, carry your weapon pointing in the air and down range at all times.
- (8) Do not remove your weapon from the firing line without permission. The safety officer or one of his representatives will check your weapon to see that it is clear.
- (9) Do not carry your rifle loaded except in combat or during combat firing exercises. During combat firing exercises you are told *when* to load your weapon.
- (10) You may practice positions and trigger squeeze on an extension of the firing line. No practice may be done behind the firing line.

- (11) Take proper care of the ammunition. Do not grease or oil it. Do not allow it to remain in the direct rays of the sun. Inspect the ammunition carefully. Turn in any defective rounds including misfires. Do not alter ammunition in any way.
- (12) Report all accidents to the officer in charge of firing at once. SR 385-310-1 prescribes the report that he makes for accidents involving faulty weapons or ammunition. SR 385-10-40 prescribes the report to be made for accidents that are not the result of faulty weapons or ammunition.
- (13) Before throwing away cardboard ammunition cartons, inspect them to see that they contain no live rounds or brass.
- (14) No member of the pit detail leaves the pits until the pit officer obtains authority to do so from the safety firing officer.

d. After firing.

- (1) Separate and turn in all brass and live rounds. When turning in brass, check it to see that there are no empty cases with unexploded primers.
- (2) Before leaving the range your weapon is inspected again for live ammunition.
- (3) An inspection is also made to make sure that no one carries live ammunition or empty cartridges from the range.

e. When firing at moving targets.

- (1) Do not fire until the right and left safety limits are determined. The officer in charge of firing sees that markers clearly identify safety limits. Do not fire outside these limits.
- (2) Whenever going into the moving target area for any reason, such as making repairs, you must carry a red flag, whether on foot or in a vehicle.

APPENDIX I

REFERENCES

- AR 775-10 Qualification in Arms and Ammunition Allowances
- SR 110-1-1 Index of Army Motion Pictures and Film Strips
- SR 310-20-3 Military Publications
Index of Technical Manuals, Technical Regulations, Technical Bulletins, Supply Bulletins, Lubrication Orders, Modification Work Orders, Tables of Organization and Equipment, Reduction Tables, Tables of Allowances, Tables of Organization, and Tables of Equipment.
- SR 320-5-1 Dictionary of United States Army Terms
- SR 385-10-40 Reports of Accident Experience
- SR 385-310-1 Regulations for Firing Ammunition for Training, Target Practice, and Combat
- FM 7-10 Rifle Company, Infantry Regiment
- FM 21-5 Military Training
- FM 21-8 Military Training Aids
- FM 21-25 Elementary Map and Aerial Photograph Reading
- FM 21-40 Defense Against Chemical Attack

FM 21-75	Combat Training of the Individual Soldier and Patrolling
FM 23-15	Browning Automatic Rifle, Caliber .30, M1918A2
FM 23-30	Hand and Rifle Grenades
TM 3-220	Decontamination
TM 9-855	Targets, Target Material, and Training Course Lay-Out
TM 9-1275	Ordnance Maintenance, U. S. Rifles, Caliber .30
TM 9-1900	Ammunition, General
ATP 7-300	Infantry Regiment
ATP 21-110N	Basic Military Training

APPENDIX II

DESTRUCTION OF ORDNANCE MATÉRIEL

1. DESTROYING THE RIFLE IN EVENT OF IMMINENT CAPTURE

a. The destruction of ordnance matériel to prevent its capture and use by the enemy is ordered and carried out only on authority delegated by the division or higher commander.

b. The following principles govern the destruction of small arms:

- (1) Make the destruction as complete as the circumstances permit.
- (2) When there is not enough time for complete destruction, destroy the parts essential to the operation of the weapon. Begin with those parts most difficult for the enemy to duplicate.
- (3) *Destroy the same essential parts of each weapon to prevent the enemy from reconstructing a complete weapon from several damaged ones.*

c. Before they reach the combat zone, individuals will be trained to destroy the weapons with which they are armed. Training will not involve the actual destruction of matériel.

d. Of the two methods outlined below for destroying the rifle, follow the first when possible.

- (1) *Method No. 1.* Dismount the rifle into three main groups. Remove the operat-

ing rod spring, operating rod, and the bolt. Grasp the rear end of barrel and receiver group with both hands and smash the barrel against a tree, rock, or firm ground until it is bent. Distort the operating rod spring. Remove the firing pin, insert its point into the hole in the face of the bolt and break it off. Wedge the operating rod handle into the receiver, stand on the receiver, and by pulling up on the operating rod tube, bend the operating rod. Break off the hammer hooks by striking against the receiver. Break the stock group. The time required for this method: $2\frac{1}{2}$ minutes.

- (2) *Method No. 2.* Insert the bullet end of a complete round into the muzzle and bend the case slightly, distending the mouth of the case to permit pulling out the bullet. Spill some of the powder; retain a sufficient amount to cover the bottom of the case to a depth of approximately one-eighth inch. Reinsert the bullet in the case, *point first*. Chamber and fire this round with the reduced charge; the bullet will stick in the bore. Chamber one complete round, lay the rifle on the ground and fire it, using a 30-foot lanyard. (A lanyard may be improvised by tying together several thongs from oiler and thong cases). Use the best available cover, as this means of

destruction may be dangerous to the person destroying the weapon. The time required for this method: 2 or 3 minutes.

- (3) *Warning.* Do not attempt to destroy the rifle by firing it with the muzzle stuck in the ground.

2. DESTRUCTION OF AMMUNITION

When time and materials are available, ammunition may be destroyed as follows: break out all packed ammunition from boxes or cartons. Stack the ammunition in a heap. Stack or pile wood, or available gasoline and oil in cans or drums, around the ammunition. Throw onto the pile all available inflammable material such as scrap wood and brush. Pour any remaining gasoline or oil over the pile. Sufficient inflammable material must be used to insure a very hot fire. Ignite the materials and take cover. Thirty to 60 minutes will be required to destroy the ammunition carried by small combat units.

INDEX

	<i>Paragraph</i>	<i>Page</i>
Accessories, rifle, description and use of.....	60	104
Action of rifle:		
After firing last round.....	32	72
On loading a full clip.....	29	66
Advice to instructors.....	248-349	387
Aerial targets.....	211, 212	228
Firing position for.....	104	192
Technique of fire.....	212	228
Aid men, location of.....	151	278
Aiming:		
Box and disk.....	81, 82	138, 140
Device, M2.....	60	104
Point:		
In combat.....	208	324
Determination of.....	209	325
Moving personnel.....	208	324
Moving vehicles.....	209	325
Sighting and, demonstration.....	311	431
Aircraft, firing on.....	211	328
Alert, use in fire commands.....	225	345
Ammunition.....	61-70	115
Allowances:		
Record firing.....	318	453
Transition firing.....	323	458
Ballistic data.....	67	122
Blank, precautions in use.....	68	123
Boxes, markings.....	65	120
Care, handling and preservation.....	65	120
Care during chemical attack.....	56	98
Classification.....	62	118
Description.....	61	115

	<i>Paragraph</i>	<i>Page</i>
Ammunition—Continued		
Destruction.....	App. II	509
Distribution during firing exercises.....	240	376
Handling.....	65	120
Hangfires.....	70	124
Identification.....	64	119
Lot number.....	63	119
Service, precautions in firing.....	69	123
Storage.....	66	122
Tables, line of.....	151	278
Tracer.....	217	336
Appendages, rifle.....	59	103
Area fire, definition and use.....	230	358
Assault fire, description.....	230	358
Assembly:		
Barrel and receiver group.....	22, 23	45, 56
Bolt.....	22	45
Bullet guide.....	22	45
Clip ejector.....	19	39
Clip latch.....	20	43
Follower arm.....	22	45
Follower assembly.....	22	45
Follower rod.....	22	45
Gas cylinder, lock.....	18	38
Hammer spring housing.....	19	39
Operating rod.....	22	45
Operating rod catch assembly.....	22	45
Operating rod spring.....	22	45
Rear sight, modified.....	21	43
Rifle.....	17	37
Stock group.....	11	12
Test for.....	24	56
Three main groups.....	23	56
Trigger housing group.....	19	39
Assistant instructors, training of.....	249, 304	387, 423
A target:		
Description of.....	200	317
1,000-inch range.....	200	317
100-yard.....	200	317
Attack, fire for the.....	229	355

Automatic rifle:		
Effect of fire.....	223	343
Ballistics, data, .30 caliber ammunition.....	67	122
Bar, sighting and aiming:		
How to make.....	348	494
Use of.....	79	133
Barrel:		
Reflector, description.....	60	104
Rifle.....	3	4
Barrel and receiver group:		
Assembly.....	22, 23	45, 56
Disassembly.....	11, 12	12, 14
Battle sight:		
To set.....	173	288
Use in combat.....	242	378
Use with moving targets.....	204	322
Bayonet.....	59	103
Beaten zone.....	221	339
Blacking, sight.....	80	137
Blank ammunition, precautions in firing.....	68	123
Bolt:		
Assembly.....	22	45
Disassembly.....	12	14
Bone support in firing positions.....	89	155
Boxes, ammunition, marking of.....	64	119
Breakage, rifle, procedure in case of.....	158	282
Breathing:		
Demonstration by instructor.....	312	435
During firing.....	88	155
Brush and thong, use of.....	60	104
B Target, use and description.....	200	317
Bullet guide:		
Assembly.....	22	45
Disassembly.....	12	14
Bullet, observing the strike.....	217	336
Cadence, sustained fire exercise.....	111	202
Calling the shot.....	106	198
Questions on.....	138	248
Using clock system.....	123	228

	<i>Paragraph</i>	<i>Page</i>
Care and cleaning (rifle):		
After firing.....	52	92
Before and during range firing.....	51	89
Bolt.....	52, 53	92, 94
Bore.....	49, 52, 53	84, 92, 94
Chamber.....	52	92
Chemical attack.....	56	98
Climatic conditions.....	57	100
Cold climates.....	57	100
Combat, during.....	53	94
Gas cylinder.....	52	92
Instructor's demonstration.....	302	422
Materials, lubricants, rust preventives.....	49	84
Questions on.....	138	248
Storage, preparation for.....	54	96
Storage, when received from.....	55	98
Surfaces, outer.....	52	92
When exposed to salt water, rain.....	53	94
When no firing is done.....	50	88
Care of ammunition.....	65	120
Carrier, target.....	196	313
Cartridge:		
Classification.....	62	118
Dummy:		
Advantages in instruction firing.....	164	284
Use.....	34	74
Extractor.....	60	104
Identification.....	64	119
Parts of the.....	61	115
Chambering:		
During forward movement.....	30	67
Failure to chamber.....	47	83
Firing cycle, in.....	25	57
Characteristics, rifle.....	3	4
Charts:		
Construction.....	346	491
(of) Disassembly.....	8	9
Progress, marksmanship training.....	76	128
Use as training aids.....	349	499
Chemical attack, care of rifle during.....	56	98

	<i>Paragraph</i>	<i>Page</i>
Cleaning materials, rifle.....	49	84
Cleaning rod, M3.....	60	104
Clearing the rifle.....	42	80
Clicks.....	43	80
Clip:		
Action when loading.....	29	66
Loading.....	35	74
Partial loading.....	39	77
Clip ejector:		
Assembly.....	19	39
Disassembly.....	15	29
Function.....	26	58
Clip latch:		
Action in loading.....	29	66
Assembly.....	20	43
Disassembly.....	14	29
Clock system, to name wind direction.....	126	231
Clock system, use in calling shots.....	123	228
Clothing to be worn during firing.....	152	280
Coach, duties of, during:		
Aerial target firing.....	104	192
Instruction firing.....	161	283
Preparatory work.....	75	128
Slow fire.....	179	295
Sustained fire.....	180	296
Trigger squeeze exercises.....	109, 313	200, 439
Coaching.....	161	283
Instruction firing.....	178	292
Position of coach.....	178	292
Restrictions during record firing.....	186	301
Cocking:		
Definition.....	25	57
During rearward movement of operating rod.....	31	69
Combination tool, description and use.....	60	104
Commands:		
Fire:		
Elements of.....	225	345
Known-distance range.....	187	305
1,000-inch range.....	187	305
Slow fire.....	183, 187	298, 305

Commands—Continued

Fire—Continued		
Sustained fire.....	118, 187	219, 305
Reloading.....	117	216
Telephone.....	160	282
Concentrated fire, explanation, use.....	230	358
Cone of fire.....	220	339
Contamination of rifle from chemical attack.....	56	98
Control, fire.....	233	363
Control stand.....	151	278
Courses, firing:		
A.....	141	261
B.....	142	264
C.....	143	265
D.....	144	268
E.....	203	319
Alternate transition.....	145, 325	270, 465
Familiarization.....	146	272
Standard.....	140	255
Cover, use in combat.....	242	378
Critique after firing exercises.....	244	381
Cross-ankled position.....	99	177
Cross-legged position.....	99	177
Crouch position.....	103	189
Cycle, functioning.....	27	62
Damages to rifle, procedure in case of.....	158	282
Danger space within trajectory.....	219	337
Decontaminating agents.....	49	84
Defense, fire in the.....	229	355
Defensive position:		
Platoon.....	230	358
Squad.....	230	358
Deflection rule:		
Explanation.....	121	226
Use.....	122	226
Demonstrations during instruction.....	310	431
Destruction of ordnance matériel.....	App. II	509
Determination, range:		
Advice to instructors.....	328	468

	<i>Paragraph</i>	<i>Page</i>
Determination, range—Continued		
Exercises in.....	329-333	472
Methods.....	215	332
Rules for instructors.....	334	476
Direction:		
Fire command for.....	225	345
To target.....	225	345
Discipline, fire.....	232	362
Disking:		
Procedure.....	192	309
Regulations governing.....	186	301
Disassembly:		
Advice to instructor.....	299	421
Barrel and receiver group.....	11, 12	12, 14
Bolt.....	12	14
Bullet guide.....	12	14
Chart for.....	8	9
Clip ejector.....	15	29
Clip latch.....	14	29
Ejector and spring.....	12	14
Field stripping.....	9	10
Follower arm.....	12	14
Follower arm pin.....	12	14
Follower assembly.....	12	14
Follower rod.....	12	14
Gas cylinder.....	16	34
Hammer pin.....	15	29
Hammer spring housing.....	15	29
Method of.....	10	12
Operating catch assembly.....	12	14
Operating rod.....	12	14
Operating rod spring.....	12	14
Rear sight.....	13	25
Stock group.....	11	12
Three main groups.....	11	12
Trigger housing group.....	11, 15	12, 29
Dispersion, explanation, cone of.....	220	339
Distributed fire.....	230	358
Dry cleaning solvent.....	49	84
Dummy cartridges, use.....	34, 164	74, 284

	<i>Paragraph</i>	<i>Page</i>
E target.....	200	317
Ejection:		
Definition.....	25	57
During firing.....	31	69
Ejector and spring:		
Assembly.....	22	45
Disassembly.....	12	14
Elements of fire commands.....	225	345
Elevation and deflection rule:		
Adjusting rear sight for.....	120	222
Explanation.....	121	226
Use.....	122	226
Enemy, representation in field target firing.....	242	378
Enfilade fire, definition.....	222	340
Equipment:		
Firing line.....	199	314
Known-distance target.....	305	423
Marksmanship.....	199	314
Pit.....	199	314
Positions, firing.....	312	435
Preparatory field.....	199	314
Range.....	199	314
Range firing.....	199	314
Range procedure demonstration.....	319	453
Sighting and aiming exercises.....	77, 311	130, 431
Standards.....	305	423
Sustained fire demonstration.....	314	442
Target.....	196	313
Zeroing rifle demonstration.....	315	445
Estimation, range:		
By eye.....	216	332
Exercises.....	328-334	468
Finger measurement method.....	225	345
Instruction notes.....	328-334	468
Lateral distances.....	225	345
Tables, factors affecting.....	216	332
Using tracer ammunition and observation of fire.....	217	336
100-yard unit.....	216, 328-334	332, 468

Examination:		
Before range firing.....	137, 316	246, 446
Check list.....	316	446
County fair method.....	137	246
Exercises:		
Field target firing.....	243	380
Firing, procedure for conducting.....	243	380
Landscape target firing.....	338-341	478
Position.....	85	144
Range determination (estimation).....	328-334	468
Reloading.....	117	216
Sighting and aiming:		
With sighting bar.....	79	133
With aiming box.....	81, 82	138, 140
Sustained fire.....	119, 314	221, 442
Extraction:		
Action during firing.....	31	69
Definition.....	25	57
Extractor:		
Assembly.....	22	45
Disassembly.....	12	14
Extractor, ruptured cartridge.....	60	104
F target.....	200	317
Familiarization course:		
Allotment of hours.....	253	389
Explanation.....	146	272
Subject schedule.....	290, 291	414, 416
Familiarization firing, definition.....	148	247
Feeding:		
Definition.....	25	57
During rearward movement of the operating rod.....	31	69
Fields, preparatory marksmanship.....	307-309	424
Field stripping:		
Definition.....	5	7
Explanation.....	9	10
Field target firing:		
Safety precautions.....	345	486
Targets for.....	344	482

	<i>Paragraph</i>	<i>Page</i>
Field target firing—Continued		
Terrain for.....	342	479
Training.....	241	378
Field target location.....	344	482
Finger measurement.....	225	345
Fire:		
(on) Aircraft.....	211	328
Application of.....	337	477
Area.....	230	358
Assault.....	230	358
Classes of.....	222	340
Commands, slow and sustained.....	187	305
Concentrated.....	230	358
Conduct of (transition).....	323	458
Control.....	233	363
Command.....	225	345
Critique.....	244	381
Transition firing.....	323	458
Discipline.....	232	362
Distributed.....	230	358
Distribution.....	230	358
Effect of, rifle and automatic rifle.....	218-223	337
Critique.....	244	381
Discussion by instructor.....	335	477
Fixed.....	234	364
Flanking.....	222	340
Frontal.....	222	340
Grazing.....	222	340
Landscape target.....	235-240, 338-341	368, 478
Oblique.....	222	340
Observation of.....	217	336
Overhead.....	222	340
Plunging.....	222	340
Power.....	4	6
Rate:	231	362
Discussion and critique.....	244	381
Sustained fire exercises.....	110, 111, 118, 119	201, 202, 219, 221

	Paragraph	Page
Fire—Continued		
Technique.....	207, 210, 323, 327, 212	327, 328
Technique of instructing.....	327	467
Firing:		
During low visibility.....	234	364
Field target.....	241-247, 342-345	378, 479
Instruction, course E.....	203	319
Landscape target.....	235-240, 338-341	368, 478
Line, organization.....	151	278
Pin.....	12	14
Alignment.....	30	67
Withdrawal.....	31	69
Position, critique.....	244	381
Positions, choice in combat.....	242	378
Procedure, transition firing.....	320-326	455
Range (see <i>Range, firing</i>)		
Tables, instruction.....	140-144	255
Flag, red, use in marking targets.....	192	309
Flanking fire.....	222	340
Flinching; detection, prevention, remedies for.....	178	292
Follower arm:		
Assembly.....	22	45
Disassembly.....	12	14
Follower arm pin:		
Assembly.....	22	45
Disassembly.....	12	14
Follower assembly:		
Assembly.....	22	45
Disassembly.....	12	14
Follower rod:		
Assembly.....	22	45
Disassembly.....	12	14
Follow-through.....	107	198
Forward movement, operating rod.....	30	67
Frontal fire.....	222	340

	<i>Paragraph</i>	<i>Page</i>
Functioning:		
Advice to instructor.....	300	421
Cycle of.....	25, 27	62
Rifle.....	25-32	57
Rifle, loaded with a full clip.....	27	62
Trigger housing group.....	26	58
Gas, action during firing.....	31	69
Gas cylinder:		
Assembly.....	18	38
Disassembly.....	16	34
Gas cylinder lock screw:		
Assembly.....	18	38
Disassembly.....	16	34
Gloves, use during firing.....	153	280
Graduations, rear sight.....	43	80
Grazing fire.....	222	340
Grenade launcher.....	59	103
Grooves and lands.....	3	4
Groups, three main; of rifle:		
Assembly.....	23	56
Disassembly.....	10, 11	12
Gun slings:		
Adjustment:		
Hasty sling (leather).....	100	180
Hasty sling (web).....	100	180
Loop sling (leather).....	86	145
Loop sling (web).....	87	150
Placing on rifle.....	60	104
Use of.....	85	144
Hammer pin:		
Assembly.....	19	39
Disassembly.....	15	29
Hammer spring housing:		
Assembly.....	19	39
Disassembly.....	15	29
Handling ammunition.....	65	120
Hangfires.....	70	124

	<i>Paragraph</i>	<i>Page</i>
Hasty sling:		
Adjustment, leather.....	100	180
Adjustment, web.....	100	180
Hot climates, care and cleaning in.....	57	100
Identification, ammunition.....	64	119
Immediate action:		
Advice to instructors.....	301	422
Application.....	46	82
Definition.....	45	82
Stoppages, use in.....	45-47	82
Importance of rifle training.....	2	2
Inspection of rifles.....	306	424
Instruction firing.....	163-180	284
Course A.....	141	261
Course B.....	142	264
Course C.....	143	265
Course D.....	144	268
Course E.....	203	319
Course, standard.....	140	255
Definition.....	140	255
Explanation.....	139	253
Instructors, advice to:		
Firing:		
Field target.....	342-345	479
Landscape target.....	338-341	478
Moving target.....	320-326	455
Transition.....	320-326	455
Mechanical training.....	298-303	419
Rules for.....	334	476
Subject schedules and training notes:		
Familiarization.....	290-297	414
Marksmanship.....	254-289	390
Technique of fire.....	327-337	467
Training aids.....	346-349	491
Training of assistant.....	249	387
Instruments authorized for use on range.....	154	281
Kneeling position:		
Advice to instructor.....	312	435
Alternate position.....	94	169

	<i>Paragraph</i>	<i>Page</i>
Kneeling position—Continued		
Assuming the.....	92	163
Errors in.....	93	168
From standing.....	114	212
Reloading in.....	117	216
Known-distance firing.....	140	255
Known-distance range:		
Organization.....	151	278
Zeroing on.....	168	286
Lands, grooves and.....	3	4
Landscape target.....	235, 236	368
Direction indicators.....	236	368
Range indicators.....	236	368
Lateral distances, estimation.....	225	345
Latrines, location.....	197	313
Leads:		
Aerial target firing.....	212	328
Moving figures in combat.....	208	324
Moving vehicles.....	209	325
Leather sling:		
Adjusting.....	86	145
Use.....	85	144
Lecture and demonstrations:		
Positions.....	312	435
Sight changes, effect of wind, use of score card.....	315	445
Sighting and aiming.....	311	431
Sustained fire.....	314	442
Trigger squeeze.....	313	439
Light, effect on aim.....	132	236
Limitations of the rifle.....	156	281
Linear targets.....	239	372
Loading:		
Action with full clip.....	29	66
Cartridge clip.....	35	74
During record firing.....	159	282
How to load rifle.....	35	74
How to partially load a clip.....	39	77
Operating rifle as a single loader.....	38	77

	<i>Paragraph</i>	<i>Page</i>
Lock, gas cylinder, replacing the.....	18	38
Locking:		
Definition.....	25	57
Explanation.....	30	67
Loop sling adjustment.....	86	145
Lot number, ammunition.....	63	119
Lubricants.....	49	84
 Main groups, three:		
Assembly.....	23	56
Disassembly.....	11	12
Markings, ammunition box.....	64	119
Marking targets:		
Equipment for.....	192	309
Slow fire.....	194	311
Sustained fire.....	195	311
Zeroing.....	193	310
Marksmanship fields.....	307-309	424
Marksmanship, moving targets:		
Aerial targets.....	211, 212	328
Fundamentals.....	204-206	322
Personnel.....	207, 208	323, 324
Vehicles.....	209, 210	325, 327
Marksmanship training:		
Allotment of hours.....	252	389
Courses.....	139-147	253
Equipment and targets.....	199, 200	314, 317
Fundamentals.....	71-73	125
Instruction firing.....	163-180	284
Moving vehicles.....	326	465
Phases.....	73	126
Pit operation.....	188-198	307
Preparatory.....	74-138	127
Principles.....	242	378
Range firing.....	148-151	274
Record firing.....	181-187	297
Small-bore firing.....	201-203	319
Subjects, common to.....	152-162	280
Materials, cleaning.....	49	84
Matériel, destruction.....	App. II	509

	<i>Paragraph</i>	<i>Page</i>
Measure, unit of.....	216	332
Measurement, finger.....	225	345
Mechanical training:		
Instruction.....	298	419
Safety precautions.....	351	500
Subject schedule.....	254	390
Training notes.....	256-262 292-297	399, 417
Medical aid men.....	151	278
Method of determining range.....	215	332
Method of disassembly.....	10	12
Misses.....	186	301
Models, construction.....	346	491
Models, wooden working.....	347	493
Modified rear sight:		
Assembly.....	21	43
Battle sight.....	173	288
Disassembly.....	13	25
Moving target firing instruction.....	320-326	455
Moving targets.....	204-212	322
Nomenclature of rifle parts.....	7	7
Objects, appearance in range estimation.....	216	332
Oblique fire.....	222	340
Observation of fire.....	217	336
Officer:		
In charge of firing.....	150	277
Noncommissioned, range.....	149	276
Pit.....	150	277
Range.....	149	276
Unit range.....	150	277
One-hand loading.....	39	77
Operating rod:		
Assembly.....	22	45
Disassembly.....	12	14
Operating rod and spring, action of.....	31	69
Operating rod catch assembly:		
Assembly.....	22	45
Disassembly.....	12	14

	<i>Paragraph</i>	<i>Page</i>
Operating rod spring:		
Assembly	22	45
Disassembly	12	14
Operation of rifle	33-44	74
Operation, single load	38	77
Operation, target:		
Slow fire	194	311
Sustained fire	195	311
Transition firing	324	463
Zeroing	193	310
Oral directions, target designation	225	345
Orders, critique of	244	381
Ordnance material, destruction of	App. II	509
Ordnance men	151	278
Organization, firing line	151	278
Organization, pit	189	308
Orientation:		
Instructors' conference	311, 312	431, 435
Pit	191	308
Positions, firing	312	435
Sighting and aiming	311	431
Overhead fire	222	340
Pads and gloves, regulations concerning	153	280
Parachutists, firing on	211	328
Parallel type marksmanship field	308	424
Permanent field, preparatory marksmanship	309	427
Personnel, range	149, 150	276, 277
Pit:		
Construction	343	480
Detail	150	277
Officer	150	277
Duties	190	308
Operation	188-198	307
Organization	189	308
Orientation	191	308
Safety precautions	198	314
Plunging fire	222	340
Pointing to direction, target designation	225	345
Points, reference, target designation	225	345

	<i>Paragraph</i>	<i>Page</i>
Point targets, scoring.....	239	372
Positions:		
Aerial target.....	104	192
Coach (of) on firing line.....	178	292
Cross-ankled.....	99	177
Cross-legged.....	99	177
Crouch.....	103	189
Discussion of.....	312	435
Exercises.....	85	144
Field target.....	242	378
Firing, during combat.....	229, 242	255, 378
Kneeling:		
Alternate.....	94	169
Assuming.....	92	163
Errors in.....	93	168
From standing.....	114	212
Prone:		
Assuming.....	90	158
Errors in.....	91	161
From standing.....	113	206
Questions on.....	138	248
Relaxation and bone support.....	89	155
Reloading (in crouch position).....	117	216
Sitting:		
Alternate.....	99	177
Assuming.....	97	172
Errors in.....	98	176
From standing.....	116	215
Squatting:		
Assuming.....	95	169
Errors in.....	96	172
From standing.....	115	215
Standing:		
Assuming.....	101	185
Errors in.....	102	189
Sustained fire practice.....	111	202
Taking, rapidly.....	112	204
Demonstration of.....	314	442
Precautions:		
Ammunition.....	68, 69	123

	<i>Paragraph</i>	<i>Page</i>
Precautions—Continued		
Range.....	157	282
Preliminary instruction, table VI.....	322	456
Preparation for transition firing.....	320	455
Preparatory marksmanship:		
Fields.....	307-309	424
Questions on.....	138	248
Training.....	74-138	127
Training notes.....	263-281	402,
	292-297	417
Training subject schedule.....	255	392
Preservation of ammunition.....	65	120
Programs, training.....	251-253	388
Progress chart, preparatory marksmanship.....	76	128
Prone position:		
Assuming.....	90	158
Demonstration.....	312	435
Errors in.....	91	161
From standing.....	113	206
Reloading in the.....	117	216
Public address system.....	151	278
Qualification scores:		
Course A.....	141	261
Course B.....	142	264
Course C.....	143	265
Course D.....	144	268
Course E.....	203	319
Standard course.....	140	255
Questions and answers, preparatory marksmanship.....	138	248
Quick firing, transition.....	324	463
Racks, cleaning.....	151	278
Range:		
Determination.....	214-217	331
(<i>see also</i> Estimation)		
Estimation:		
Advice to instructors.....	328, 334	468, 476
By eye.....	216	332
Exercises.....	329-333	472
Lateral distances.....	216	332

Range—Continued

Estimation—Continued

Table, factors affecting.....	216	332
Use of tracer ammunition and observation of fire.....	217	336

Firing:

Advice to instructors.....	317	450
Examination before.....	137, 316	246, 446
Explanation of.....	148	274
Safety precautions for.....	157, 353	282, 502
Subject schedule.....	282	410
Training notes.....	283-289	412

Maximum effective.....	3	4
------------------------	---	---

Moving targets, effective for.....	204	322
------------------------------------	-----	-----

Personnel, duties.....	149, 150	276, 277
------------------------	----------	----------

Procedure:

Advice to instructors.....	319	453
----------------------------	-----	-----

Record firing.....	181-187	297
--------------------	---------	-----

Transition firing (table VII).....	323	458
------------------------------------	-----	-----

Alternate.....	325	465
----------------	-----	-----

Quick (table VIII).....	324	463
-------------------------	-----	-----

Zeroing (see *Zeroing*)

Rate of fire:

Critique.....	244	381
---------------	-----	-----

Maximum.....	231	362
--------------	-----	-----

Ready line.....	151	278
-----------------	-----	-----

Rear Sight:

Adjustment of.....	43	80
--------------------	----	----

For battle sight.....	173	288
-----------------------	-----	-----

For windage and elevation.....	120	222
--------------------------------	-----	-----

Assembly.....	21	43
---------------	----	----

Disassembly.....	13	25
------------------	----	----

Rearward movement of rifle operating parts.....	31	69
---	----	----

Record:

Card, zero, use of.....	135, 165	241, 285
-------------------------	----------	----------

Firing.....	181-187	297
-------------	---------	-----

Definition.....	148	274
-----------------	-----	-----

Regulations.....	186	301
------------------	-----	-----

Small-bore, course E.....	203	319
---------------------------	-----	-----

Tables.....	140-144	255
-------------	---------	-----

	<i>Paragraph</i>	<i>Page</i>
Record—Continued		
Score card.....	182	297
Red flag, procedure for using.....	192	309
Reference points.....	225	345
References, text.....	App. I	507
Reflector, barrel.....	60	104
Regulations, record course.....	186	301
Relaxation and bone support.....	89	155
Reloading:		
Advice to instructors.....	314	442
Exercises.....	117	216
Restrictions on identification of firer (on range).....	186	301
Rifle:		
Description.....	3	4
Destruction.....	App. II	509
Fire, effect.....	218-223	337
How it works.....	25-32	57
Loading.....	36	75
Operation.....	33-44	74
Adjusting the rear sight.....	43	80
Clearing.....	42	80
Setting at safe.....	41	79
Preparation for storage.....	54	96
Rests:		
Location of line.....	151	278
Use in low visibility firing.....	234	364
Use in target designation.....	225	345
Safety precautions.....	44	81
Single loader, operation as.....	38	77
Unloading.....	37	76
Rifling.....	3	4
Rod, cleaning, M3.....	60	104
Rules for instructors.....	334	476
Ruptured cartridge extractor.....	60	104
Rust preventives.....	49	84
Safety:		
Piece.....	26	58
Precautions.....	350-353	500
Field target firing.....	345	486

	<i>Paragraph</i>	<i>Page</i>
Safety—Continued		
Precautions—Continued		
Handling the rifle.....	44	81
Mechanical training.....	351	500
Pit detail.....	198	314
Preparatory marksmanship.....	352	501
Range practice.....	353	502
References to.....	206	323
Setting.....	41	79
Unseating.....	15	29
Score card:		
Importance.....	134	240
Instruction in use.....	135, 136,	241,
	147, 162,	273, 284
	182, 315	297, 445
Scorers:		
Duties during transition firing.....	323	458
Location on firing line.....	151	278
Scores, qualifying:		
Course A.....	141	261
Course B.....	142	264
Course C.....	143	265
Course D.....	144	268
Standard course.....	140	255
Transition firing.....	145	270
Scoring:		
Landscape target firing.....	239	372
Screw, gas cylinder lock, replacing the.....	18	38
Service ammunition, precautions.....	69	123
Shelters.....	155	281
Shot groups:		
Advice to instructor.....	319	453
Calling the shot.....	106	198
Calling the shot using the clock system.....	123	228
Errors.....	83	142
Sighting and aiming exercises.....	81, 82	138, 140
Sight:		
Adjustment.....	120, 124,	222, 229,
	125	230
Alinement.....	79	133

	<i>Paragraph</i>	<i>Page</i>
Sight—Continued		
Battle sight for moving targets.....	204	322
Blacking.....	80	137
Changes.....	315	445
Description.....	3	4
Modified.....	13	25
Picture.....	77	130
Rear:		
Assembly.....	21	43
Disassembly.....	13	25
Settings.....	171	288
Use of battle sight in transition firing.....	323	458
Sighting and aiming:		
Bar.....	79	133
Exercises.....	77, 79,	130, 133,
	81, 82	138, 140
Procedure for exercises.....	311	431
Questions.....	138	248
Sighting device, M15.....	78	133
Signal, fire control.....	226	353
Silhouette target.....	322	456
Sitting position:		
Alternate.....	99	177
Assuming.....	97	172
Errors in.....	98	176
From standing.....	116	215
Reloading in the.....	117	216
Sled target.....	326	465
Sling:		
Hasty, adjustment.....	100	180
Limitation on use of the.....	156	281
Loop, adjustment.....	86, 87	145, 150
M1, web.....	60	104
M1907.....	60	104
Slow fire.....		
Coach, duties of.....	178, 179	292, 295
Course E.....	203	319
Misses.....	186	301
Scoring.....	183	298
Target operation.....	194	311

	<i>Paragraph</i>	<i>Page</i>
Slow fire—Continued		
1,000-inch range.....	185	301
Small-bore firing.....	201-203	319
Spare parts.....	58	103
Spotter, use of.....	192	309
Spot weld.....	90	158
Squad, rifle, technique of fire.....	230	358
Squatting position:		
Assuming.....	95	169
Errors in.....	96	172
From standing.....	115	215
Reloading in.....	117	216
Standard course.....	140	255
Standing position:		
Assuming.....	101	185
Errors in.....	102	189
To kneeling position.....	114	212
To prone position.....	113	206
To sitting position.....	116	215
To squatting position.....	115	215
Stationary target.....	344	482
Stock group.....	11	12
Stoppages:		
Advice to instructor.....	301	422
Causes.....	47	83
Definition.....	45	82
During sustained fire.....	186	301
Immediate action.....	45-47	82
Malfunctions (table I).....	47	83
Storage:		
Ammunition.....	66	122
Cleaning weapons received from.....	55	98
Preparation of rifle for.....	54	96
Subject schedule:		
Familiarization course.....	290	414
Familiarization course, marksmanship.....	291	416
Marksmanship training.....	255	392
Mechanical training.....	254	390
Preparatory marksmanship training.....	255	392
Range firing.....	287	412

	<i>Paragraph</i>	<i>Page</i>
Support, bone.....	89	155
Surprise target.....	344	482
Sustained fire.....	110, 177	201, 292
Advice to instructors.....	314	442
Coaches' duties during.....	180	296
Course E.....	203	319
Exercises.....	111, 118,	202, 219
	119	221
Marking target during.....	195	311
Misses.....	186	301
Positions.....	112	204
Questions on.....	138	248
Range procedure.....	184	298
Record firing.....	184	298
Scoring.....	184	298
Target, operation of.....	195	311
1,000-inch range.....	185	301

Tables, firing:

Course:

A.....	141	261
Alternate transition.....	145	270
B.....	142	264
C.....	143	265
D.....	144	268
E.....	203	319
Familiarization.....	146	272
Preliminary instruction.....	322	456
Standard.....	140	255
Transition firing.....	323, 324	458, 463

Target:

Aerial.....	211, 212	328
Battlefield.....	2	2
Carrier.....	196	313
Description of:		
A, B, E, F, A 1,000-inch targets.....	200	317
Field firing target.....	344	482
Silhouette (E) target.....	322	456
Transition firing target.....	323	458
Designation.....	224-227	344

	<i>Paragraph</i>	<i>Page</i>
Target—Continued		
Direction.....	225	345
Equipment.....	199	314
Field firing.....	241-247	378
Instructing notes.....	342-349	479
Ground-towed.....	326	465
Landscape.....	236	368
Marking, slow fire.....	194	311
Marking, sustained fire.....	195	311
Moving.....	204-212	322
Operation in transition firing.....	324	463
Technique of fire:		
(on) Aircraft.....	212	328
Application of fire.....	228-234	355
Combat (enemy personnel).....	207	323
Field target firing.....	241-247	378
Instruction notes.....	327	467
Landscape target firing.....	235-240	368
Moving targets.....	207, 210, 212	323, 327, 328
Moving vehicles.....	210	327
Range determination.....	214-217	331
Rifle fire, effect.....	218-223	337
Rifle squad.....	228-234	355
Telephones:		
(on) Firing range.....	160	282
Operators.....	151	278
Use.....	319	453
Termination of forward movement.....	30	67
Terrain, selection of.....	342	479
Thong, brush and.....	60	104
Tool, combination.....	60	104
Tools, rifle.....	60	104
Tracer ammunition:		
Range determination with.....	217	336
Target designation with.....	225	345
Training:		
Aids:		
Instructing notes.....	300	421
Rifle marksmanship.....	346-349	491

	<i>Paragraph</i>	<i>Page</i>
Training—Continued		
Field target firing.....	241	378
Hours, allotment of.....	252, 253	389
Landscape target firing.....	235	368
Marksmanship.....	71-203	125
Principles of.....	242	378
Mechanical.....	5	7
Training:		
Notes:		
Familiarization.....	287-289,	412,
	292-297	417
Mechanical training.....	256-262,	399,
	298-302	419
Preparatory marksmanship.....	263-281	402
Program.....	251	388
Range firing.....	283-289	412
Phases of.....	73	123
Trajectory.....	219	237
Transition firing:		
Alternate course.....	325	465
Courses A, B, C, D.....	145	270
Instruction notes.....	320-325	455
Standard course.....	140	255
Tables.....	140, 145,	255, 270,
	323, 324	458
Trigger:		
Housing group:		
Assembly.....	19	39
Disassembly.....	11, 15	12, 29
Functioning.....	26	58
Pull.....	156	281
Squeeze:		
Importance of.....	105	194
Instruction notes.....	313, 319	439
Procedure in conducting exercises.....	108	199
Questions on.....	138	248
Two-hand loading.....	39	77
Uniform prescribed for firing.....	152	280

	<i>Paragraph</i>	<i>Page</i>
Unit of measure:		
Estimation by eye.....	216	332
Exercises.....	330-333	432
Method, 100-yard unit.....	330	432
Rules for instructors.....	334	476
Use in range estimation.....	330	432
Unit range personnel.....	150	277
Unloading.....	37	76
Unlocking:		
Automatic.....	31	69
Definition.....	25	57
Vehicles, moving.....	209, 210	325, 327
Targets.....	326	465
Velocity, muzzle.....	219	337
Visibility, low, firing during.....	234	364
Water points, location of.....	197	313
Weapons to be used for firing, indoor, outdoor.....	237	370
Web sling, adjustment of, firing positions.....	87	150
Wind:		
Adjusting rear sight for.....	120	222
Direction.....	126	231
Effect.....	129	233
Estimating speed of.....	127	231
Formula, examples.....	131	236
Rule.....	130	235
Speed.....	128	233
Values.....	129	233
Zeroing in a.....	175	291
Zeroing:		
Advice to instructor.....	315	445
Definition.....	133	237
Method:		
Known-distance range.....	168	286
Landscape target firing.....	238	370
When a wind is blowing.....	175	291
When no wind is blowing.....	133	237
1,000-inch range.....	167	286
100-yard range.....	169	286

	<i>Paragraph</i>	<i>Page</i>
Zeroing—Continued		
Method—Continued		
200-yard range.....	170	287
300-yard range.....	172	288
500-yard range.....	174	291
Record card, use:		
200-, 300-, 500-yard range.....	135	241
Qualification courses.....	165	285
Score card, use.....	136	241
Target, operation during.....	193	310
Zone, beaten.....	221	339