

MHI  
Copy 3

FM 23-80

WAR DEPARTMENT

BASIC FIELD MANUAL



37-MM GUN, TANK, M5  
(MOUNTED IN TANKS)

June 25, 1941

**FM 23-80**

**BASIC FIELD MANUAL**



**37-MM GUN, TANK, M5  
(MOUNTED IN TANKS)**

---

**Prepared under direction of the  
Chief of the Armored Force**



**UNITED STATES  
GOVERNMENT PRINTING OFFICE  
WASHINGTON : 1941**

WAR DEPARTMENT,  
WASHINGTON, June 25, 1941.

FM 23-80, 37-mm Gun, Tank, M5 (Mounted in Tanks), is published for the information and guidance of all concerned.  
[A. G. 062.11 (8-28-40).]

BY ORDER OF THE SECRETARY OF WAR:

G. C. MARSHALL,  
*Chief of Staff.*

OFFICIAL:

E. S. ADAMS,  
*Major General,*

*The Adjutant General.*

DISTRIBUTION:

D 2, 7, 17 (8); R 17 (10); Bn 9 (2), 17 (5); C 9 (2),  
17 (5); I C 17 (20).

(For explanation of symbols, see FM 21-6.)

## TABLE OF CONTENTS

	Paragraphs	Page
<b>CHAPTER 1. MECHANICAL TRAINING.</b>		
<b>SECTION I. Characteristics and description.</b>	1- 5	1
II. Disassembling, assembling, and changing parts	6- 7	16
III. Functioning	8-13	20
IV. Care and cleaning of gun, mount, and spare parts	14-22	25
V. Stoppages and immediate action	23-25	35
VI. Mounting gun and telescopic sight in tank	26-28	38
VII. Accessories and spare parts	29-30	46
VIII. Ammunition	31-41	47
IX. Subcaliber equipment	42-48	55
X. Individual safety precautions	49-54	56
<b>CHAPTER 2. TRAINING FOR PLACING GUN IN ACTION.</b>	55-61	58
<b>CHAPTER 3. MARKSMANSHIP.</b>		
<b>Section I. General</b>	62-64	64
II. Preparatory training	65-75	65
III. Preliminary gunners' examina- tion	76	84
IV. Range practice, including qualifi- cation courses	77-80	85
V. Conduct of range practice includ- ing record practice and individ- ual safety precautions	81-92	89
VI. Targets, ranges, and range pre- cautions	93-97	102
<b>CHAPTER 4. TECHNIQUE OF FIRE.</b>		
<b>Section I. General</b>	98-99	113
II. Characteristics and classes of fire	100-104	113
III. Range determination and target speeds	105-111	115
IV. Target designation	112-115	117
V. Fire distribution	116-119	120
VI. Fire control	120-127	123
VII. Fire orders	128-129	126
<b>CHAPTER 5. FIRING AT FIELD TARGETS.</b>		
<b>Section I. General</b>	130-133	128
II. Preparatory exercises	134-135	129
III. Firing exercises	136-138	134
IV. Construction of targets, ranges, and equipment	139-140	136
V. Safety precautions	141-142	139
<b>CHAPTER 6. ADVICE TO INSTRUCTORS.</b>		
<b>Section I. General</b>	143-146	140
II. Mechanical training	147-153	142
III. Training for placing gun in action	154-155	143
IV. Marksmanship	156-158	144
V. Firing at field targets	159-160	146
<b>INDEX</b>		149

# BASIC FIELD MANUAL

## 37-MM GUN, TANK, M5

### (MOUNTED IN TANKS)

#### CHAPTER 1

#### MECHANICAL TRAINING

	Paragraphs
SECTION I. Characteristics and description.....	1-5
II. Disassembling, assembling, and changing parts...	6-7
III. Functioning .....	8-13
IV. Care and cleaning of gun, mount, and spare parts .....	14-22
V. Stoppages and immediate action.....	23-25
VI. Mounting gun and telescopic sight in tank.....	26-28
VII. Accessories and spare parts.....	29-30
VIII. Ammunition .....	31-41
IX. Subcaliber equipment.....	42-48
X. Individual safety precautions.....	49-54

#### SECTION I

#### CHARACTERISTICS AND DESCRIPTION

■ 1. **CHARACTERISTICS** (fig. 1).—The 37-mm tank gun, M5, is a flat trajectory weapon of the field gun type. It is single shot with a drop type of breechblock. It fires projectiles which weigh approximately 2 pounds.

■ 2. **MOUNTING**.—The gun is mounted on tank mounts of several different types depending upon the type of tank and the position within the tank in which it is mounted. Mounts are designed to permit fixed fire or free manipulations of the gun by hand.

■ 3. **DESCRIPTION**.—*a. Barrel assembly*.—The barrel assembly consists of the following principal parts:

(1) *Barrel*.—(a) The barrel is a one-piece forging with rifled bore threaded to screw into the breech ring. There are two bearings, one near the breech end and one at midlength that support the barrel and aline it in the yokes of the sleigh. The front bearing has a flange at the rear and is threaded

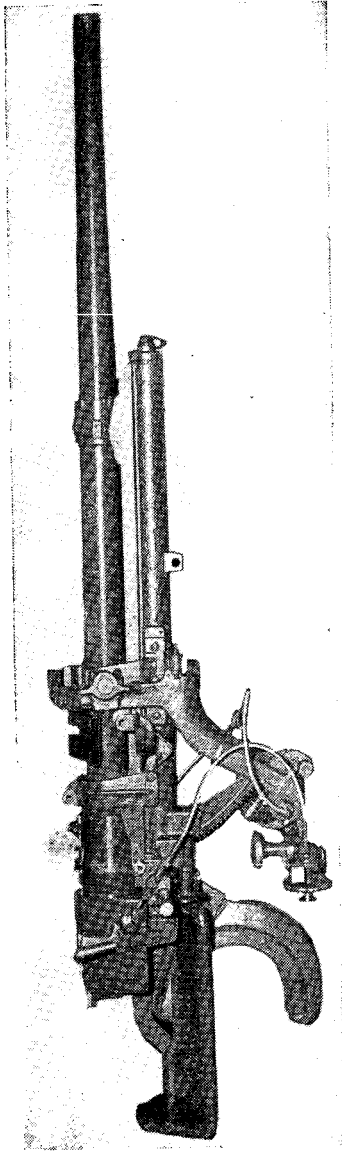

① Right side view.

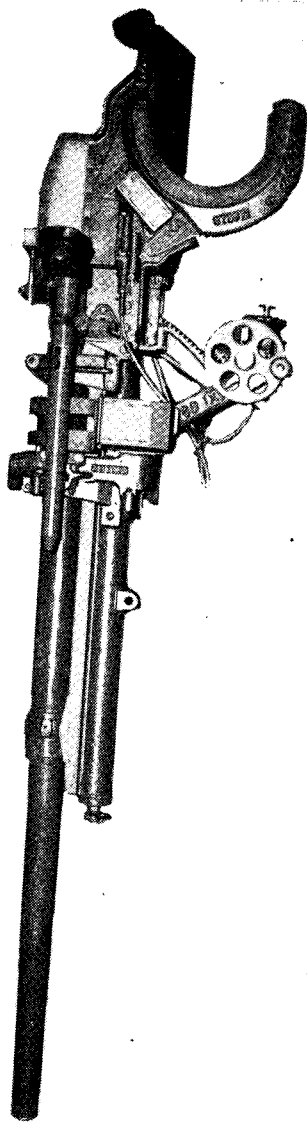

FIGURE 1.—37-mm tank gun, M5.  
② Left side view.

for a lock nut to secure the position. Keyways in the right and left rim of the flange engage keys in the yoke to prevent rotation of the barrel.

(b) The breech face of the barrel is recessed on each side of the bore to form extractor pockets.

**Note.**—Interchange of the tubes of the M5 and M6, 37-mm tank gun, is prohibited. Although these tubes are mechanically interchangeable, the M5 gun is  $3\frac{1}{2}$  calibers shorter and when assembled to the M6 breech mechanism gives an undesirable breech preponderance. For identification the model number of each gun is stamped in the top of the tube about mid-length.

(2) *Breech ring* (fig. 2).—(a) The breech ring is bored and threaded in front to receive the barrel. A locking key secures the breech ring to the barrel; lugs on the bottom of the breech ring are bored to provide a hole for attaching the breech ring to the recoil mechanism and the operating shaft. The rear hole is for the operating shaft.

(b) The operating handle latch catch is attached on the right side of the breech ring.

(c) The rear half of the breech ring is slotted vertically to receive the breechblock. The rear of the breech ring is formed to a U-shape to facilitate loading. The cylindrical studs inside the ring serve as extractor pivots. The hole through the lower left wall forms the trigger bearing and a counterbore inside provides a pocket for the tripper.

(3) *Extractors.*—The extractors are positioned against the side walls of the breech recess. The lips of the longer upper arms lie in pockets on each side of the chamber and engage the flange of the cartridge. Camming lugs on the lower arms project inward to engage the cammed surface of the breechblock.

(4) *Breechblock assembly* (fig. 3).—(a) The breechblock assembly consists of the breechblock, bushing, and firing spring retainer pin. The large center hole in the breechblock houses the firing pin guide assembly. The breechblock bushing is screwed into the forward end of the hole and machined off. The firing spring retainer pin and the interrupted shoulder inside the hole form a joint to hold the firing spring retainer and prevent rotation. Grooves in the hole receive and guide the cocking and sear lugs of the firing pin guide.

(b) The bottom of the block is cut from front to rear by a T-slot which inclines downward to the rear. The crank trunnions slide in the T-slot to raise and lower the block.



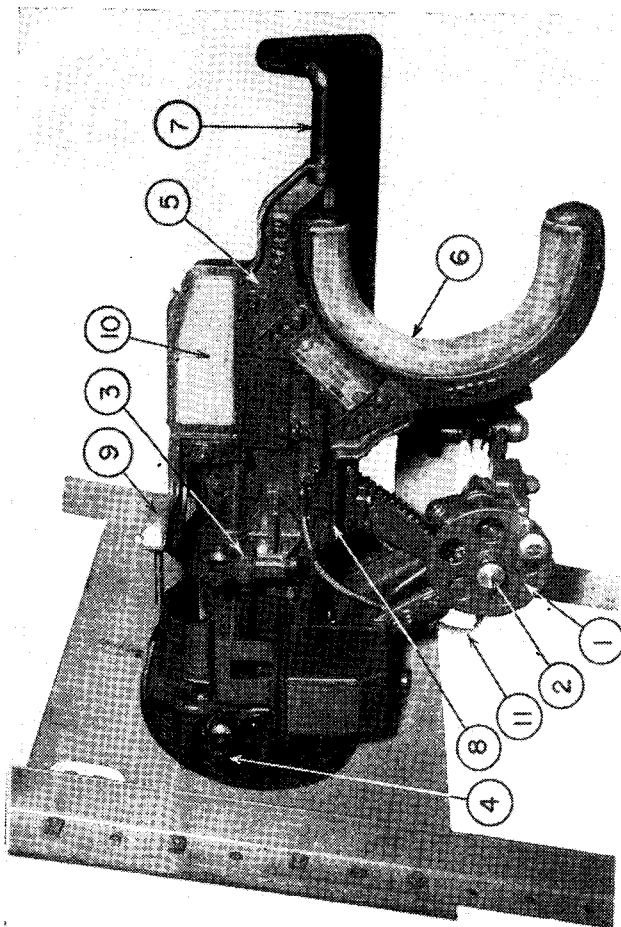

① Left rear view, mounted on dual mount, M20.  
FIGURE 2.—37-mm tank gun, M5.

1. Elevating handwheel.
2. 37-mm trigger actuator plunger.
3. Rear sight bracket (Wildrick sight adjusting bracket).
4. Front sight bracket.
5. Shoulder guard.
6. Shoulder rest.
7. Recoil guard.
8. Hand bracket (left).
9. Headrest (forward).
10. Headrest (right side).
11. 37-mm trigger actuating cable.

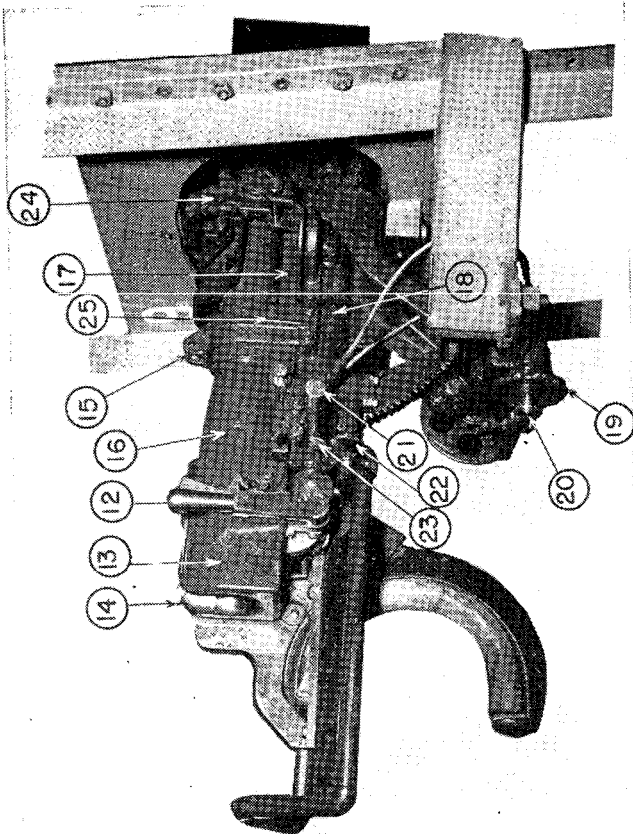

② Right rear view, mounted on dual mount, M20.  
 FIGURE 2.—37-mm tank gun, M5—Continued.

- 12. Operating handle.
- 13. Breech ring.
- 14. Cocking lever.
- 15. Traveling lock hook.
- 16. Barrel.
- 17. Cradle.
- 18. Recoil cylinder.
- 19. Traversing handwheel.
- 20. Caliber .30 machine gun trigger actuator plunger.
- 21. Hand bracket (right).
- 22. 37-mm trigger bar actuator.
- 23. Caliber .30 machine gun trigger actuator.
- 24. Trunnion.
- 25. Yoke.

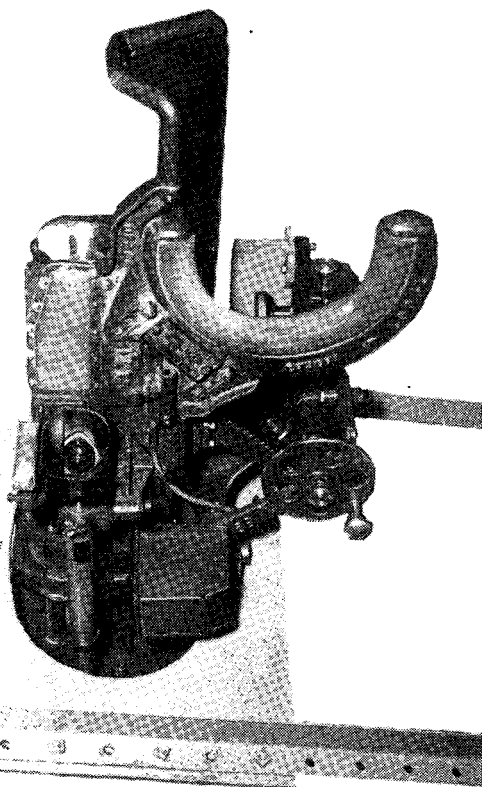

③ Left rear view, with telescope sight, M5A1, mounted.  
 FIGURE 2.—37-mm tank gun, M5—Continued.

The top of the block is U-shaped to guide the cartridge into the chamber. A hole with a slot for the sear arm is on the left side of the block; it houses and guides the sear and sear spring. The upper left side of the block is recessed to receive the cocking lever. A hole in the rear face of the recess houses the cocking lever plunger and spring.

(5) *Crank*.—The crank with splined hub is mounted on the shaft of the operating handle. Extending upward and for-

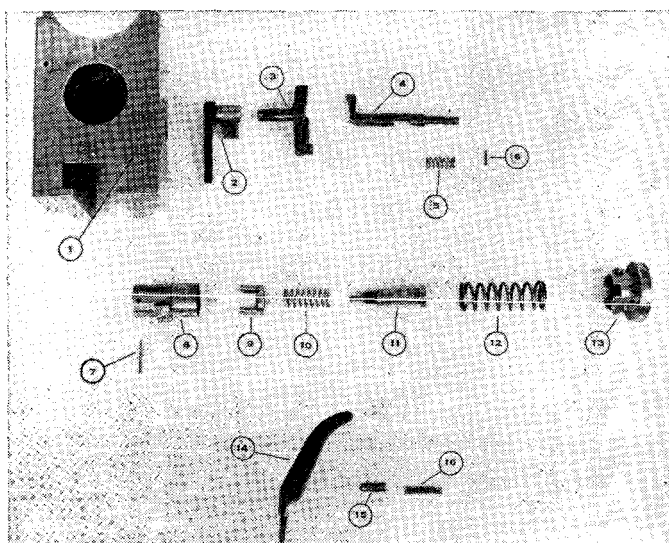

- |                 |                                   |
|-----------------|-----------------------------------|
| 1. Breechblock. | 9. Stop.                          |
| 2. Trigger.     | 10. Retracting spring.            |
| 3. Tripper.     | 11. Firing pin.                   |
| 4. Sear.        | 12. Firing spring.                |
| 5. Sear spring. | 13. Retainer.                     |
| 6. Sear pin.    | 14. Cocking lever.                |
| 7. Guide pin.   | 15. Cocking lever plunger.        |
| 8. Guide.       | 16. Cocking lever plunger spring. |

FIGURE 3.—Breechblock assembly.

ward, it terminates in a pair of trunnions which project right and left. These trunnions engage and slide in the T-slot in the breechblock to raise and lower the block as the operating handle is rotated. There is only one stop surface. It limits the throw of the downward movement of the crank. The upward movement of the crank is stopped by the trunnions striking the rear end of the barrel.

(6) *Operating handle assembly* (fig. 2).—The operating handle assembly consists of the operating handle, latch, spring, and pin.

(7) *Firing mechanism* (fig. 4).—The firing mechanism consists of two groups of components which are assembled in the breechblock and the breech ring.

(a) The firing pin and guide assembly, retainer, firing spring, sear, sear spring, and sear-retaining pin, and the cocking lever and cocking-lever plunger and spring are supported in the breechblock.

1. The firing pin and guide assembly consists of the firing pin, guide, stop, retracting spring, and guide pin. The guide is a cylindrical tube, with lugs on the bottom and left sides for engagement with the sear and cocking lever. The firing pin is screwed into the guide. The stop, which is in the form of a ring with two prongs on its front face, fits in the guide with the prongs protruding through holes in the closed end. The retracting spring is mounted on the body of the firing pin.

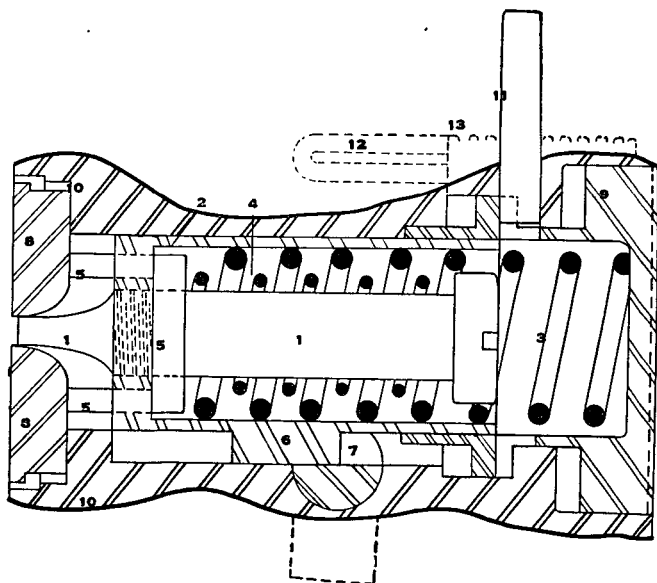

- |                       |                                   |
|-----------------------|-----------------------------------|
| 1. Firing pin.        | 8. Breechblock bushing.           |
| 2. Guide.             | 9. Retainer.                      |
| 3. Firing spring.     | 10. Breechblock.                  |
| 4. Retracting spring. | 11. Retainer pin.                 |
| 5. Stop.              | 12. Cocking lever plunger.        |
| 6. Sear lug.          | 13. Cocking lever plunger spring. |
| 7. Sear.              |                                   |

FIGURE 4.—Firing mechanism.

The assembly is carried by the guide which slides in the recess of the breechblock.

2. The retainer is a round plug which closes the rear of the guide assembly hole in the breechblock and retains the firing pin guide assembly and firing spring.
3. The firing spring bears rearward on the retainer and forward on the stop.
4. The sear is notched for engagement of the sear lug of the guide. The sear passes through the breechblock and the sear and the spring are secured by a pin.
5. The cocking lever is pivoted on a hub in the upper left side of the breechblock. The upper arm projects upward and rearward from the block and terminates above the rear wall of the breech ring. The lower arm extends forward and downward, terminating in a lug which engages and forces the guide rearward to cock the mechanism. A plunger and spring return the lever to position as the upper end is released.

(b) The tripper, trigger, trigger plunger, and spring are supported in the breech ring.

1. The tripper is within the breech ring. The operating arm of the tripper extends upward and carries a cam surface for actuating the sear. The lower arm of the tripper carries a horizontal safety lug, which in the idle position of the trigger and tripper, extends inward below and forward of the left lower edge of the breechblock. Lowering the block places this shoulder behind the lug of the tripper and prevents actuation when the breech is open.
2. The trigger consists of a tapered arm with a hollow cylindrical hub; the hub enters a hole in the breech ring. The trigger plunger and spring which are seated in the cheek of the breech ring retain the trigger in position and return it to a forward position after firing.

*b. Sleigh and recoil mechanism (fig. 5).—(1) Recoil mechanism.*—The recoil cylinder houses the recoil mechanism and is assembled with the trunnions which are mounted in the trunnion bearing of the yoke.

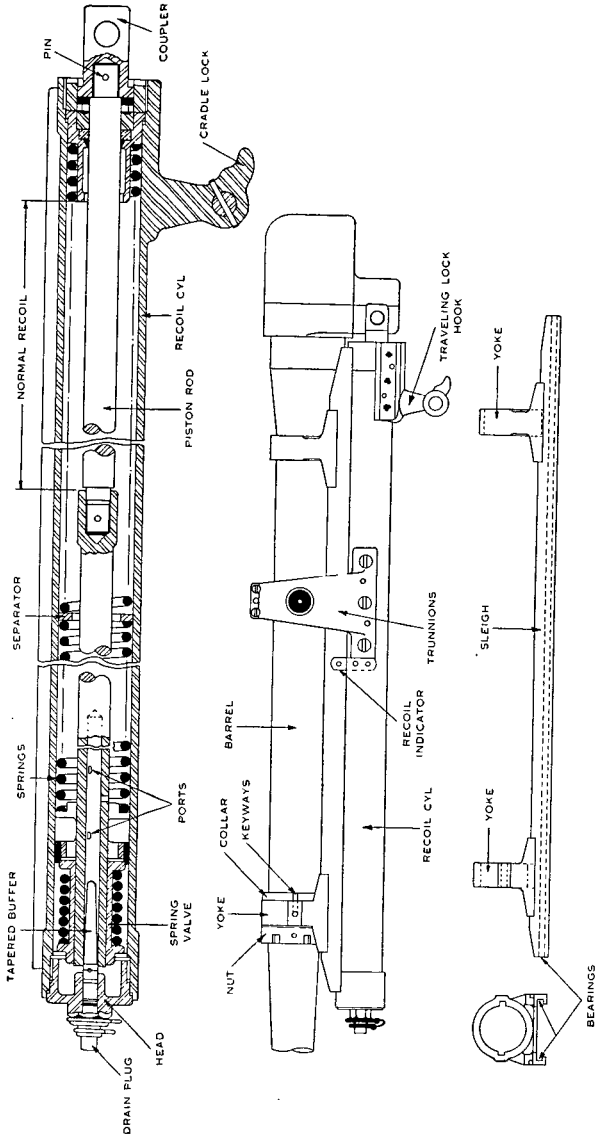

FIGURE 5.—Recoil mechanism.

(2) *Recoil cylinder.*—The recoil cylinder is provided with rails which guide the sleigh during the recoil movement of the gun. The gun and the piston rod of the recoil mechanism are connected by a coupler and coupler pin. The shoulder guard is bolted to the recoil cylinder.

(3) *Sleigh.*—The sleigh is of built-up steel construction and mounts the gun in yokes.

(4) *Trunnions.*—The trunnions are made in two halves, doweled to each side of the recoil cylinder and locked by a screw.

(5) *Recoil system.*—The recoil system is the hydrospring type. It includes the recoiling mechanism, which absorbs the recoiling energy of the gun after it is fired; the counter-recoil mechanism, which returns the gun into battery; and the buffer mechanism, which absorbs the last portion of the counterrecoil action to prevent damage to the weapon due to sudden stopping of the movement of the recoiling parts.

*c. Elevating mechanism, traversing mechanism, and trigger actuator (figs. 2 and 6).*—(1) *Elevating mechanism.*—(a) Adjustment of the gun in elevation is transmitted from the handwheel to the barrel by a shaft and a system of gears. The shaft is mounted on antifriction bearings.

(b) For quick adjustment of the gun in elevation, the worm gear drive is equipped with a throw-out lever which disengages the gear drive and permits free movement of the gun in elevation. This release mechanism is actuated by pulling out (to the right) the throw-out release handle, spring actuated lock and pushing the throw-out handle forward to its farthest position. To reengage the gears and lock the gun to the elevating mechanism pull out (to the right) the throw-out release handle, spring actuated lock and pull the throw-out handle to the rear. It locks in the rearmost recess when the worm gear segment and sector gear are positively engaged.

(2) *Traversing mechanism.*—Adjustment of the gun in traverse is transmitted by means of a knob and swivel shaft. to the traversing bar. The traversing knob lock when tightened locks the gun for traverse. When not locked the friction of the gears is such that either free movement of the gun may be obtained for traverse or adjustment may be made by means of the traversing knob. Traverse of the gun is



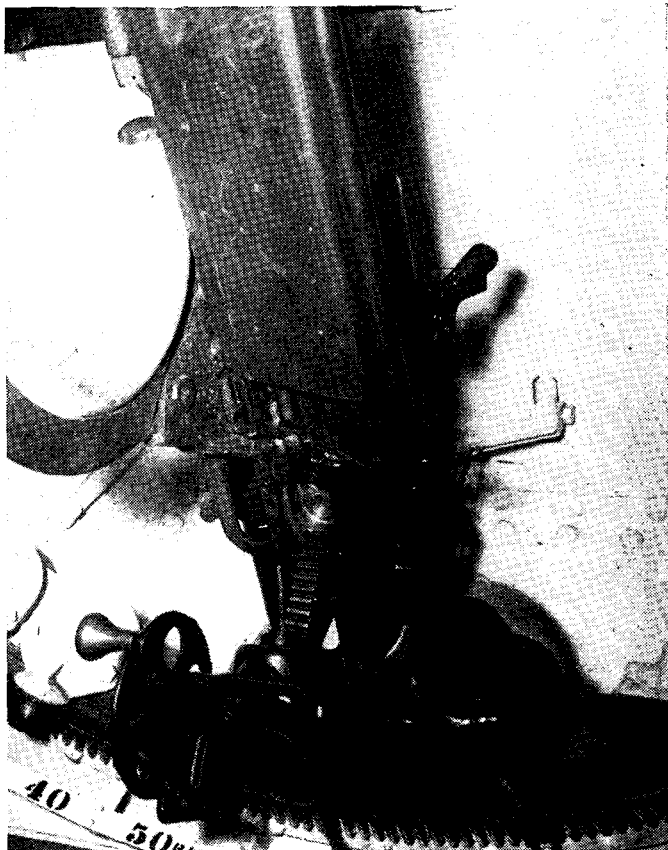

① Bottom rear view, mounted in M19 mount.

FIGURE 6.—37-mm tank gun, M5.

further augmented by rotation of the turret either by mechanical or manual means.

(3) *Trigger actuator.*—Two means of firing the gun are provided in the form of two types of trigger actuators:

(a) The first consists of a trigger actuator assembled into the hub of the elevating wheel and consists of a plunger button, spring cable, actuator plunger, and with or without a trigger lever.

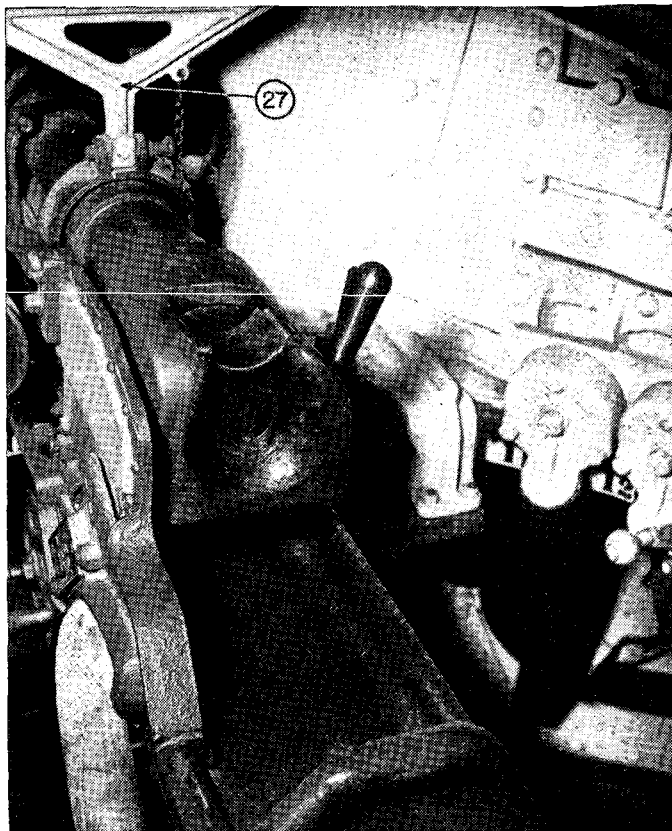

27. Traveling lock (in locked position).

⊙ Upper left view, mounted in M19 mount.

FIGURE 6.—37-mm tank gun, M5—Continued.

(b) The second consists of a trigger bar pivoted at approximately the center in a bracket affixed to the base of the recoil cylinder, the left end of which engages directly with the actuator plunger. It consists of a bar, pivot pin, and retracting spring.

d. *Shield and traveling lock.*—(1) *Shield.*—The shield is made of 1-inch armor plate assembled in two pieces—a

right and a left half. It is fixed to the yoke and recoil cylinder by means of bolts. One bolt at the bottom locks the two halves together at the bottom and to the recoil cylinder. One bolt at the top locks the two halves together. Two additional bolts (one in each half) lock the shield to the yoke.

(2) *Traveling lock.*—The traveling lock is hinged by means of two bolts to a bracket mounted in the turret top. In traveling position, it is fastened to the bracket on the recoil cylinder. In firing position, the lock is in the raised and inactive position in the turret top.

#### ■ 4. GENERAL DATA.

Total weight of gun (approx.)..... 700 pounds  
 Weight of barrel assembly..... 185 do  
 Length of barrel (approx.)..... 73 inches

##### a. With gun mount, M19.

Total weight of gun (including mount and sight (approx.))..... 700 pounds  
 Length of recoil..... 6 to 8 inches  
 Oil capacity of cradle..... 5 pints  
 Amount of traverse..... 10° L to 10° R  
 Amount of elevation..... 10° to 20°

##### b. With combination gun mount, M20.

Total weight of gun (including mount and sight (approx.))..... 730 pounds  
 Length of recoil..... 8 inches  
 Oil capacity of cradle..... 5 pints  
 Amount of traverse..... 10° L to 10° R  
 Amount of elevation..... 10° to 20°

##### c. Ammunition.

Type	Shell, fixed, A.P., M51 and practice	Shell, fixed, HE, Mk. II	Shell, fixed, HE, M63
Weight of round, pounds.....	3.34	2.72	3.03
Weight of projectile, pounds.....	1.92	1.23	1.61
Approximate muzzle velocity, f/s.....	2,550	2,700	2,650
Terminal velocity at 1,000 yds., f/s.....	<sup>1</sup> 2,050	(?)	(?)
Maximum ordinate at 1,000 yds., f/s., feet.....	8	(?)	(?)
Chamber pressure, $\psi$ .....	36,000	25,000	36,000

<sup>1</sup> For penetration.

<sup>2</sup> No data.

Penetration (see graphs)— $1\frac{1}{2}$  inches at 1,000 yards at  $20^\circ$  angle of incidence.

■ 5. SIGHTS AND HOW MOUNTED.—The telescope, M5A1 (sec. VI), is at present standard for use in standard automotive equipment including tanks. It is normally attached to the gun and mount by means of brackets. (See fig. 6.) (See also par. 28.)

## SECTION II

### DISASSEMBLING, ASSEMBLING, AND CHANGING PARTS

■ 6. GENERAL.—Disassembling may be considered under two general heads: removal of groups to the extent required for ordinary cleaning and minor repairs; and detailed disassembling, involving removal of all components from each group. The explanation given here includes that part of complete disassembly and assembly of the gun and the groups essential for normal care, cleaning, adjustment, and repair to be accomplished by the using services. The procedure that follows is written primarily for disassembling and reassembling of the gun as mounted in tanks. All other guns may be disassembled and assembled by this method.

■ 7. DISASSEMBLING AND ASSEMBLING.—*a. To remove firing pin and guide assembly from breechblock (assembled in gun).—*Close the breech and actuate the trigger. Press the retainer into the breechblock about  $\frac{1}{8}$  of an inch and rotate it either way one quarter of a turn (rotate the slot to the horizontal position). Release the pressure and remove the retainer. Withdraw the firing spring. Cup the left hand over the recess in the rear of the breechblock and with the right hand rotate the cocking lever forward smartly. The firing pin guide assembly will be ejected.

(1) *Disassembly of firing pin guide assembly (to be disassembled only when absolutely necessary).—*Using the 37-mm combination tool drive out the guide pin from the forward end of the firing pin guide. With a screw driver unscrew the firing pin from the guide and remove the firing pin, retracting spring and stop.

(2) *To assemble firing pin guide assembly.—*Replace the stop into the guide with the prongs protruding through the forward end of the guide. Place the retracting spring onto

the firing pin and insert the firing pin and retracting spring into the guide with the striker end of the firing pin to the front. Screw the firing pin into the guide as far as it will go and then back it off just enough to clear the hole for the guide pin. Drive in the guide pin until it is just flush on both sides of the guide. Be careful not to injure the guide when removing or replacing the guide pin.

*b. To replace firing pin guide assembly.*—Insert the firing pin guide assembly into the firing pin guide chamber in the breechblock. Make sure the sear lug on the bottom of the guide is down (the sear lug is cut off at an angle) and the stop is to the front. Hold the trigger to the rear (push the trigger bar forward) and push the firing pin guide assembly forward until the prongs of the stop strike the breechblock bushing. Release the trigger. Insert the firing spring into the guide. Place the cupped end of the retainer over the rear end of the firing spring, keeping the slot on the rear face of the retainer horizontal. Press the retainer into the face of the breechblock about  $\frac{1}{8}$  of an inch and rotate it until the slot is in the vertical position; then release the pressure.

*c. To remove breechblock.*—Remove the firing pin guide assembly (see *a* above). Remove the operating handle detent by placing a combination screw driver or similar tool on the knurled end of the detent between the actuator plunger and the left breech ring lug. Rotate the detent forward until the knurled end clears the breech ring lug. Remove the operating handle detent. Support the breechblock by inserting the thumb of the left hand into the firing pin guide assembly housing. With the right hand withdraw the operating handle when in the forward position to the right. Allow the breechblock to slide down just far enough to clear the trunnions of the crank. With the right hand remove the crank from the inclined T-slot in the bottom of the breechblock. Slowly lift the breechblock out of its recess in the breech ring.

*d. To remove firing mechanism group from breechblock.*—  
(1) *Cocking lever.*—Insert the index finger of the left hand between the apron of the cocking lever and the nose of the cocking lever plunger. Depress the plunger and at the same time remove the cocking lever with the right hand. *Be careful not to let the plunger or spring fly out of the breechblock.* Release the plunger and remove it and the spring.

(2) *Sear and sear spring.*—Place the breechblock with the front face down. Press the arm of the sear into its recess as far as it will go and expose the sear retaining pin. Remove the pin. Release the pressure and withdraw the sear and sear spring. Place the sear retaining pin in the retainer so as not to lose it.

*e. To replace firing mechanism group in breechblock.*—(1) *Sear and sear spring.*—Place the sear spring over the small end of the sear and insert the sear and spring into the sear recess in the breechblock. Aline the arm of the sear with the slot, press the sear until the pin hole in the sear is exposed. Insert the sear retaining pin and release the pressure on the sear spring making sure the pin enters the counterbore in the block.

(2) *Cocking lever.*—Insert the cocking lever plunger spring into its hole in the top of the recess in the left side of the block. With the index finger of the left hand press the cocking lever plunger into the hole, flat end against the spring. With the right hand insert the cocking lever into its recess with the short arm down.

*f. To assemble breechblock to gun.*—Rotate the upper arms of the extractors fully forward. Start the breechblock into its recess in the top of the breech ring keeping the cocking lever up and pointing to the rear. Support the breechblock by inserting the thumb of the right hand in the firing pin guide assembly housing. With the left hand press in on the sear and slide the breechblock downward until the T-slot clears the bottom of the breech ring. Place the trunnions of the crank into the T-slot with the left hand keeping the convex curve to the rear. Engage the hub of the crank in between the breech ring lugs and slide the breechblock to the fully raised position. Support the block by holding the crank between the breech ring lug with the left hand and with the operating handle in its forward position insert it to the left with the right hand. From the rear engage the operating handle detent on the shaft and rotate it forward until it springs into its recess in the breech ring lug.

*g. To remove firing and extracting mechanism group of breech ring (with the breechblock removed).*—(1) *Extractors.*—Rotate the extractors to a vertical position and remove them from their pivots.

(2) *Tripper.*—Reach into the breech recess from below,

grasp the tripper with the fingers, and withdraw it from the trigger hub.

(3) *Trigger (not to be removed from tank's guns except when absolutely necessary).*—Level the gun and remove the coupler pin by using a screw driver and the proper wrench. Slide the barrel back to between 8 and 10 inches which will clear the trigger from the recoil guard. Insert the tip of the index finger of the right hand between the apron and the trigger plunger and press the plunger rearward to free the lug on the trigger apron. Hold the plunger depressed and remove the trigger to the left. Release the pressure on the plunger and remove the plunger and spring.

*h. To assemble firing and extracting mechanism group of breech ring.*—(1) *Trigger.*—Replace the trigger spring and plunger into the hole with the right forefinger. Press the trigger plunger to the rear. Slide the trigger hub into the hole at the top of the notch until the shoulder contacts the cheek of the breech ring. Release the plunger. Slide the barrel to the forward position and replace the coupler pin.

(2) *Tripper.*—Insert the shaft of the tripper into the hub of the trigger, with the short arm vertical. Slide the tripper shaft through until the flattened end on the end of the shaft enters the slot in the trigger hub and the short arm of the tripper enters its recess inside the breech ring.

(3) *Extractors.*—Slide the extractors onto their pivots while in the vertical position. Keep the lips of the extractor up and to the front.

*i. To disassemble trigger actuator assembly.*—(1) Disconnect the cable of the 37-mm trigger actuating mechanism from its housing (left side of gun mount), by loosening the "Allen" set screw in the trigger actuating housing using the  $\frac{1}{16}$ -inch Allen set screw wrench. Remove the end of the cable from the housing.

(2) Remove the two cap screws (using  $\frac{1}{2}$ -inch box wrench) holding the trigger actuating housing to the body of the shoulder rest. Remove the recoil cylinder cross head bolt (using  $\frac{15}{16}$ -inch wrench on nut). Pull the gun tube to the rear about 6 inches and remove the trigger actuating housing to the right (under the gun tube).

NOTE.—Normally the trigger actuator assembly will be disassembled only to the extent required to attach the trigger cable and assembly of the subcaliber trigger mechanism.

*j. To assemble 37-mm trigger actuator.*—Proceed in reverse order of disassembling.

*k. To assemble trigger actuator assembly of subcaliber mount.*—(1) The subcaliber trigger actuator cable is led in between the left side of the breech ring and top of the shoulder piece. It is attached to the trigger actuating housing in the lower tube of the trigger actuating housing by inserting the cable head into the front of the lower tube (having first removed the cable head arm). Replace the cable head arm from the rear of the tube and attach with screw bolt. Replace the trigger actuating housing *from the left* and affix in position by means of the two cap screws, care being exercised that the stud, or arm, on the end of the subcaliber trigger actuating cable is positioned in rear of the 37-mm trigger bar. Replace the 37-mm trigger actuating cable (see *i* and *j* above). Move the 37-mm gun forward and replace the cross head bolt. When cocking the subcaliber gun, should the subcaliber trigger actuating cable tend to stick, back off on the hexagonal locking nut on the rear of the cable (to the left and below the cocking pin).

(2) To disassemble the subcaliber trigger actuator assembly reverse the above procedure.

*l. Miscellaneous.*—Operations not covered herein are a function of ordnance personnel.

### SECTION III

#### FUNCTIONING

■ 8. GENERAL.—The soldier should have a practical working knowledge of the mechanical operation of the gun so that he will be able to keep it in action during combat. Although many parts of the gun operate simultaneously, the subject of functioning is divided into phases to facilitate instruction. The explanation of mechanical functioning begins with the assumption that the gun has just been fired.

■ 9. OPENING BREECH, EXTRACTION, AND COCKING.—*a. First phase—opening the breech.*—The movement of the operating handle to the rear is transmitted through the operating shaft to the crank. The trunnions on the crank move downward to the rear in the inclined T-slot in the breechblock and slide the block downward in the breech recess. The mo-



tion is stopped by the impact of the stop surface of the crank hub on the shoulders of the breech ring lugs.

*b. Second phase—extraction.*—As the breechlock nears its lowermost position, the cam shoulders on the front face of the breechblock contact the round cams on the lower ends of the two extractors. This imparts a sharp rearward throw to the extractor lips on the upper arms of the extractors. Since the extractor lips are behind the rim of the shell, the case is extracted from the chamber and ejected clear of the breech end of the gun. The breech is then open ready for loading.

*c. Third phase—cocking.*—As the cocking lever is carried down with the breechblock, the projecting arm of the cocking lever is cammed forward into the breech recess by the cam surface inside the rear wall of the recess. The lower arm is rotated rearward to engage the cocking lug on the firing pin guide and to move the guide toward the rear. This movement of the firing pin guide assembly compresses the firing spring sufficiently to permit the engagement of the sear. (As the guide is moved to the rear, the sear lug cams the sear to the right. When the sear lug clears the sear, the sear notch springs to the left and in front of the sear lug by the action of the sear spring and holds the firing pin guide assembly to the rear or in the cocked position.)

■ 10. CLOSING BREECH AND FIRING.—*a. Fourth phase—closing breech.*—A round is inserted into the gun chamber through the breech opening. The shell is positioned by the engagement of its rim with the lips of the extractors. The breech is closed by rotating the operating handle forward into the latched position. The forward movement of the operating handle, through the action of the crank, raises the breechblock to the closed position. As the breechblock is raised the forcing bevel cams the shell into the chamber and the cocking lever is released. The firing pin guide assembly is retained in the cocked position by the sear. As the breechblock nears its upper limit of travel, the upper arm of the cocking lever, actuated by the cocking lever plunger and spring, emerges from the breech recess and returns to its normal position with the projecting arm pointing rearward and the lower arm forward and clear of the path of the cocking lug. The upward movement of the breechblock is

stopped by the impact of the crank trunnions on the rear end of the barrel; the toe of the operating handle latch engages the catch on the breech ring and the breech is locked, ready to fire.

*b. Fifth phase—firing the piece.—(1) Actuation by the disk plunger on the elevating handwheel.—*A push on the disk plunger moves the cable, through its flexible housing, so as to force the actuator plunger to the rear. The actuator plunger contacts the lower portion of the trigger arm and moves the trigger to the rear. Upon release of the disk plunger the actuator plunger, by the action of the actuator plunger spring, returns to its forward position. The trigger must be in its forward position before the breech can be opened, therefore the disk plunger must be released after each firing. (*When the trigger is in its rearward position the safety lug on the lower arm of the tripper remains under the bottom surface of the breechblock and will not allow the block to be lowered.*)

*(2) Actuation by the trigger bar.—*When the trigger bar is pushed forward, since it is pivoted in the center, the left arm moves to the rear. As the left arm moves to the rear, it contacts the actuator plunger projection and moves the plunger to the rear. The plunger contacts the lower portion of the trigger arm and moves the trigger to the rear. Upon release of the trigger bar the actuator plunger returns to its normal position by the action of the actuator plunger spring. The trigger bar returns to its rearward position by the action of the trigger bar spring.

*c. Sixth phase—operation of the firing mechanism.—*The arm of the trigger, which was forced to the rear by the actuator plunger, transmits this motion through the trigger hub to the shaft of the tripper, throwing the upper arm of the tripper forward. The tripper arm cams the sear to the right, releasing the sear lug of the firing pin guide from the sear notch. The firing pin guide assembly being released is impelled forward by the compressed firing spring to fire the round.

*d. Seventh phase—operation of the firing pin guide assembly.—*The firing spring, being compressed between the base of the stop and the retainer, forces the firing pin guide assembly forward. The prongs of the stop strike the breechblock bush-

ing and stops the action of the firing spring. The firing pin and guide, since they are locked together by the guide pin, continue forward under inertia to strike the primer. During this movement the retracting spring is being compressed between the base of the stop and the head of the firing pin. The striker end of the firing pin strikes the primer and stops the forward movement of the guide just before it contacts the breechblock bushing. The retracting spring which has been compressed then retracts the guide and firing pin to their normal position with the firing pin point flush with, or slightly in rear of, the front face of the breechblock.

■ 11. RECOCKING.—The firing mechanism can be cocked without opening the breech, by rotating the projecting arm of the cocking lever forward.

■ 12. RECOIL MECHANISM. — *a. Eighth phase — backward movement of the barrel assembly.*—The action of the powder gases on the breechblock at the moment of discharge causes the recoil of the barrel assembly and drives it rearward about 8 inches. The recoil is resisted, its speed regulated, and the movement stopped by the action of the recoil mechanism which is attached to the barrel assembly by the coupler and coupler pin. As the piston head in the recoil cylinder moves to the rear with the piston rod, two forces resist the movement, the two counterrecoil springs are compressed and the movement of the piston head is resisted by the oil in the cylinder. The oil follows two courses as it flows to the front of the piston head—

(1) It forces the piston valve back against the resistance of the piston valve spring and flows through the holes in the piston head which are uncovered as the valve moves away from the piston.

(2) It passes through the ports, thence through the hollow portion of the forward end of the piston rod and out around the tapered buffer. As the barrel assembly moves backward the piston rod moves away from the tapered buffer (which remains stationary). The hole in the end of the piston rod is gradually opened; thus the oil is restricted greatly at the instant of discharge and restricted less and less as the barrel assembly moves to the maximum length of recoil. The combination of the resistance of the counterrecoil springs and

the restriction of the oil stops the rearward movement of the barrel assembly at the maximum recoil without appreciable shock to the gun.

*b. Ninth phase—forward movement of the barrel assembly.*—(1) Recoil being stopped, the recoiling parts are instantly moved forward by the action of the compressed counterrecoil springs against the piston bracket. The piston valve, by the action of the valve spring, closes the holes in the piston head as the counterrecoil starts. The oil has only one course to follow, through the hollow end of the piston rod and the ports in its walls to the rear of the piston head.

(2) The added restriction during the counterrecoil causes the barrel assembly to move slowly back into the battery.

(3) The final movement is stopped by the action of the counterrecoil buffer entering the hollow end of the piston rod. The counterrecoil buffer, due to its tapered construction, progressively closes the hollow portion of the piston rod through which the oil must flow. This action throttles the flow of oil and permits the gun to return to battery without appreciable shock.

■ 13. SAFETY FEATURES OF FIRING MECHANISM.—*a. Tripper.*—

As the breechblock is lowered, the left shoulder of the block passes immediately to the rear of the safety lug on the lower arm of the tripper, thus preventing the operation of the tripper and holding the trigger in the forward position until the breech is closed.

*b. Locking lever.*—The offset lower arm of the cocking lever engages the cocking lug of the guide early in the downward movement of the breechblock and remains in the path of this lug until the block is returned to approximately its closed position. This eliminates the possibility of having the firing pin move forward to strike the cartridge due to the premature release of the sear or other failure on the part of the sear to hold the mechanism cocked until the breech is fully closed.

*c. Alinement of firing pin.*—As the breechblock is lowered it carries the firing pin down with it, thus the firing pin will not be alined with the primer of the shell until the breech is fully closed.

## SECTION IV

## CARE AND CLEANING OF GUN, MOUNT, AND SPARE PARTS

■ 14. GENERAL CARE.—*a.* This section contains information and instructions pertaining to the care and maintenance of the 37-mm tank gun, M5. Laxity in proper care and maintenance will soon result in deterioration to the extent of appreciably reducing the accuracy and dependability of the gun. It must always be kept clean and covered with a light coat of oil. Care and cleaning will not be confined to the gun alone but will include the mount, spare parts, and all accessories. Ammunition must be kept clean and dry. Guns mounted in vehicles are normally locked in the traveling position unless their early use is anticipated. Muzzle covers are provided to prevent dirt from entering the gun through the bore. Detailed information pertaining to cleaning, preserving, and lubrication materials and their authorized use will be found in TM 9-850 (now published as TR 1395-A). The use of materials other than those authorized for the purpose mentioned is strictly forbidden. Dirt and grit which accumulates on the gun and mount and in the operating mechanism while traveling, and from the blast of the piece in firing, settle on the bearing surfaces. This dirt and grit in combination with the lubricant form a grinding compound. Powder fouling attracts moisture and hastens the formation of rust. Therefore, whenever possible, as during lulls in combat, clean the gun as soon as practicable after firing. Dirt on nonbearing surfaces can usually be removed by water. Lubricated or other greasy parts must be cleaned with a dry-cleaning solvent applied with a rag. The procedure in cleaning the bore, chamber, and breech ring is covered in paragraph 16*d*(2). The following materials are issued by the Ordnance Department for use in the field (see SNL K-1):

(1) *Soda ash* (dehydrated sal soda).—This is used for cleaning the bore, breech mechanism, and firing mechanism after firing.

(2) *Dry-cleaning solvent*.—This is used for removing grease. It is preferred to kerosene because it does not leave a corrosive film. The use of gasoline is prohibited since it is inflammable.

(3) *Crocus cloth*.—This is the most coarse abrasive permitted for cleaning mist and stain from bearing surfaces.

(4) *Emery cloth*.—This is used in cleaning unfinished or nonbearing surfaces only. It is issued in 5 degrees of coarseness, of which "00" is the finest.

(5) *Burlap, jute*.—This is issued for cleaning the bore.

(6) *Cotton waste, clean rags, and sponges*.—These are for general cleaning purposes.

b. Tank commanders are responsible for the daily inspection of the 37-mm guns and immediately take the proper action necessary to keep the gun in excellent condition.

■ 15. SPECIAL PRECAUTIONS.—The following practices should be avoided in the use and operation of the gun:

a. Removing the breechblock without first removing the firing pin guide assembly.

b. Putting a strain on the recoil guard or shoulder rest while getting into or out of the vehicle.

c. Putting unnecessary strain on the actuator cables.

d. Not locking the gun into the traveling position when not in use.

e. Injuring the sight or other accessories because of faulty setting of elevating and traversing stops.

f. Attempting to open the breechblock while actuating the trigger.

g. Banging the breechblock while opening and closing the breech.

h. Pressing either trigger actuator before the breech is completely closed.

i. Firing the gun before the recoil tube has been checked for proper amount of recoil oil.

j. Hitting the trigger actuators in attempting to fire without checking the position of the safety levers.

k. Jamming the gears at maximum and minimum elevating points.

l. Disconnecting the worm gear from the sector gear without supporting the breech end of the gun.

m. Disconnecting the worm gear from the sector gear and not locking the throw-out lever in the forward position.

n. Jamming the worm and sector gear while changing from free to fixed gun.

o. Leaving a live round in the chamber of a hot gun.

The using services equipped with tanks having combination gun mounts will, in addition to those precautions listed above, observe the precautions for the caliber .30 machine gun as listed in FM 23-50.

■ 16. **DETAIL CARE AND CLEANING.**—*a. Care and cleaning in garrison use.*—During periods when no firing is done in garrison, post, and camp, care and cleaning of matériel should include routine maintenance as prescribed in paragraphs 14, 17, and 18. The provisions of these paragraphs should be modified to meet the conditions under which the equipment is being used. Care should insure proper preservation and appearance of the gun, mount, and accessories at all times. The exterior parts should be cleaned and protected with a film of oil after every drill. The gun will be thoroughly cleaned and protected at least once a week and immediately following its use in inclement weather. For garrison cleaning the procedure indicated for care and cleaning after firing in *d* below should be followed except that the bore and chamber will not be swabbed with water or soda ash solution but will be cleaned with a dry rag and then oiled. If, upon inspection, no corrosion is detected, a coating of rust-preventive compound (cosmic) may be placed in the bore and chamber instead of light oil.

*b. Care and cleaning before drill or firing.*—The gun crew should be trained to make a routine inspection of the matériel before its use. If the gun and mount have been cared for as prescribed above, they should require very little servicing. However, as a precaution, an inspection should always be made to verify that the mechanism functions properly and is clean and well-lubricated. If firing is contemplated, the presence of adequate oil in the recoil cylinder should be verified (see par. 18). Before firing, particularly if the tank has been traveling for some distance over muddy or dusty roads, it is important that all mechanism, especially the trigger actuator, be manually tested to insure proper functioning (see par. 20).

*c. Care and cleaning during firing.*—The gun crew should take advantage of lulls in combat to swab the bore and chamber, clean and oil the breech, firing and trigger actuator mechanism, and all other exposed bearing surfaces. The cleaning brush should be used to swab the bore and chamber; clean water should also be used if available and time permits.

The functioning of the recoil mechanism should be observed and proper measures taken to avoid or correct malfunctioning. (See pars. 18, 21, and 24.)

*d. Care and cleaning after firing.*—(1) *General.*—As soon as practicable after firing, the bore, chamber, breech ring, breechblock, firing mechanism, and trigger actuator should be cleaned and oiled. The recoil cylinder should be filled and the guides of the sleigh and rails of the recoil cylinder cleaned and oiled if necessary.

(2) *Bore, chamber, and breech ring.*—After removing the breechblock and firing mechanism in the breech ring, thoroughly sluice and sponge the bore and chamber with a solution of  $\frac{1}{2}$  pound of soda ash in 1 gallon of water, or hot water and issue soap, hot water alone, or in the absence of these with cold water. Then swab the bore and chamber with dry waste or rags until they are perfectly dry. Inspect the bore and chamber for any remaining residue. If they are not clean, repeat the swabbing and drying. A small piece of burlap jute used as a patch over the end of the brush of the rammer is effective for cleaning the bore. When all powder fouling has been removed, dry the bore and chamber thoroughly and cover with a light coat of lubricating oil. Whenever the soda ash solution is used for cleaning, all of the parts cleaned should be swabbed or rinsed with clear water and dried before oiling. It is of particular importance, when using a cleaning process like the one described above, that all parts and surfaces, recesses, etc., be thoroughly dried before they are oiled. The parts of the firing mechanism removed from the breech ring and the interior of the breech ring should be cleaned with a dry rag and then wiped with an oily rag.

(3) *Breechblock.*—Having removed the breechblock from the breech ring, disassemble it. With a dry rag clean the dirt and oil from the block and all parts contained therein. Lubricate all recesses for moving parts with light oil. With an oily rag wipe the breechblock and all other parts of the firing mechanism leaving a thin coating of oil.

(4) *Trigger actuating mechanism.*—All exposed and accessible parts of the trigger actuator mechanism extending throughout the system from the trigger actuator to the trigger arm should be thoroughly cleaned and oiled. Dry-cleaning solvent will assist materially. This mechanism is particu-



larly vulnerable to mud and dust accumulated while traveling or during action and unless given careful and detailed care will fail to operate freely.

(5) *Outer surfaces of the gun.*—Clean the outer surfaces, using damp rag or dry-cleaning solvent when necessary, then dry and wipe all exposed metal parts with an oily rag. Do not apply oil to painted surfaces. Oil collects dirt and grit and makes daily cleaning more difficult.

(6) *Other parts.*—For care of other parts, see paragraphs 14, 17, and 18.

■ 17. LUBRICATION.—*a.* Excessive wear can be prevented by keeping the matériel clean and well-lubricated. The life of the matériel depends on proper lubrication. Particular attention should be given to sliding and bearing surfaces of the cradle and breech mechanism.

*b.* Lubricating oils and greases as shown in the lubrication chart must be used as prescribed. (See lubrication chart below.)

*c.* Moving parts, not specifically mentioned, should be cleaned and a film of oil, SAE 10-W below 32° F. and SAE 20 above 32° F., applied.

*d.* Lubricating fittings will be painted red for ease in locating. Oil holes are encircled by a red ring.

*e.* The oil gun should be worked slowly and the parts oiled should be maneuvered to insure proper distribution of the lubricant.

*f.* Should an oiler valve stick and prevent the passage of the oil, it may be loosened with a piece of wire pushed through the hole. Care should be taken not to damage the valve.

*g.* Care must be taken when cleaning oil and grease compartments to insure the complete removal of all residue or sediment. Dirt or other foreign matter should not be allowed to drop into any of the lubricating compartments.

*h.* Lubrication frequencies are based on continuous use of the matériel with frequent firing.

*i.* No lubricants other than those prescribed will be used without the authority of the Ordnance Department.

LUBRICATION CHART  
37-MM GUN M5, TANK MOUNT, M19, M20, M21, M22, M23, M24\*

Parts lubricated Name	No.	Frequency		Method of application	Required lubricants		Amount	Remarks
		Miles	Time		Below 32° F.	Above 32° F.		
•Traversing mechanism: Traversing gears (open)	}		Daily	Oiler	SAE 10-W	SAE 20	Light film	{ Clean and lubricate daily.
•Elevated mechanism: Elevating gears (open)	}		do.	do.	do.	do.	do.	Do.
Elevating rack	}		do.	do.	do.	do.	do.	Coat on assembly.
Trigger actuator			Monthly	Hand	Chassis lubricant, winter grade		Light coating	
Elevating gears (M24) (inclosed).								
Cradle:								
Recoil rails				Oiler	SAE 10-W SAE 20		{ Light film	} Avoid waste.
Sleigh guides			Daily	do.			{ do.	
Trunnion bearings	1			Oil cup			{ Fill	
Gun: Bore			Daily	(See remarks)	do.	do.	Light film	For care and cleaning, follow prescribed instructions in par. 16 d (2).

	1	Monthly	Grease fittings	Chassis lubricant, winter grade	Several turns on grease gun, Light film	Test frequently, Clean and lubricate.
Firing mechanism, cable bushing.						
Firing mechanism, breechblock and ring.		Daily	Oiler	SAE 10-W. SAE 20		
Miscellaneous:						
Pintle pins (top and bottom)	2		Oil cups		Fill	
Exposed friction points and bearing surfaces.		Daily	Oiler	SAE 10-W. SAE 20	Light film	Avoid waste.

\* In general where lubrication is required and not mentioned in this chart, the following procedure will apply:

1. For antifriction bearings—pack bearings with chassis lubricant—winter grade.
2. For journal bearings—clean and lubricate with the above described oils.
3. Exposed gears, racks, etc.—clean and lubricate with the above described oils.
4. For sealed gear cases—clean and fill with the above described oils.

■ 18. FILLING RECOIL CYLINDER.—The capacity of the recoil cylinder varies with the type of mount used. The M19 and M20 mounts have a capacity of about 2½ quarts of recoil oil.

a. The recoil cylinder must be kept filled in accordance with the following instructions or damage to the gun will probably result. The Ordnance Department will furnish the proper grade of oil for the recoil cylinder which will be designated, "Oil, recoil, heavy, low-pour-point." The substitution of any filler other than that issued by the Ordnance Department is prohibited.

b. The amount of oil in the recoil cylinder should be such that the movement of the gun in recoil is smooth and of uniformly decreasing velocity, and the maximum point of recoil is reached without shock; the counterrecoil mechanism will then return the gun completely to battery without shock. Too rapid recoil, and shock at the end of recoil is usually caused by too little oil in the recoil cylinder. Failure to return completely to battery is usually caused by too much oil in the recoil cylinder or may be due to lack of oil or the presence of foreign matter on the guides or rails.

c. To fill the recoil cylinder proceed as follows:

(1) Elevate the muzzle slightly.

(2) Fill the oil gun with oil. When filling, have the nozzle well under the surface of the oil supply to avoid drawing in air. After filling, point the nozzle upward, push the piston until the oil starts to flow in order to force out any air in the oil gun.

(3) Remove the front (filler) plug and screw the nozzle of the oil gun into position in its stead, keeping a slight pressure on the oil gun piston as the oil gun is being seated.

(4) Remove the rear plug in the right side of the recoil cylinder.

(5) Introduce the oil into the recoil cylinder by slowly pushing on the piston of the oil gun until the oil flows out of the rear hole.

(6) Fully depress the muzzle (approximately 10°) and continue to force oil slowly through the cylinder and out of the rear hole until no more bubbles emerge with the oil.

(7) Screw in the rear plug tightly.

(8) Fully elevate the muzzle, unscrew the oil gun, and replace the front plug.

d. The filling of the recoil mechanism should be carefully done to insure that all air has been "bled off" and that the mechanism is completely full. The presence of air can be detected by "air bubbles" appearing in the oil. After completing the above filling process, it is sometimes found necessary to drain off a small amount of oil from the recoil cylinder. This establishes a "void" which compensates for an expansion of the oil during firing. If draining is found necessary, elevate the muzzle slightly and unscrew (crack) the rear filler plug sufficiently to permit about one tablespoonful of oil to flow out. The amount of oil in the mechanism should be such that the gun returns completely into battery and does not end the action of recoil with any appreciable jar.

e. Excess oil used during filling should be caught in a clean receptacle and must be strained through a clean cloth before being used again.

□ 19. CARE DURING GAS ATTACK.—a. Whenever nonpersistent gas attacks are anticipated, all unpainted surfaces of the gun and instruments should be covered with oil in order to protect them against the corrosive effects of chemicals of this type. After the gas attack, the oil is wiped off and fresh oil applied. Ammunition should be covered or kept in boxes if practicable; after the attack, it should be wiped with an oily rag and fired as soon as conditions permit.

b. When persistent gas attacks are anticipated, the protective muzzle cover should be kept on the gun when it is not in use. After a persistent gas attack, the contaminated material should be cleaned with gasoline or kerosene, if available, and then thoroughly swabbed with chloride of lime mixed with water. If practicable, this paste is allowed to remain on the weapon for about 2 hours. Since chloride of lime is very corrosive to metals, all weapons that have been treated with it should be thoroughly cleaned with water and well oiled. If the special noncorrosive decontaminating agent is available, it should be used instead of chloride of lime. When used, it is sprayed on all affected parts and allowed to remain for a few minutes, then the weapon is cleaned and oiled. In all cleaning operations, the gas mask and protective clothing, if available, should be worn. All cleaning rags, sticks, etc., used in the operation are disposed of by burying.

■ 20. CARE DURING COLD WEATHER.—In cold weather, the gun mechanism should be tested frequently by hand manipulation to insure that it is functioning properly.

■ 21. CARE AND CLEANING FOR STORAGE.—If the weapon is to be stored or if climatic conditions are conducive to the formation of rust, thoroughly clean all parts and inspect for the presence of corrosion. If no corrosion is present, cover all exposed metal surfaces thoroughly with a coating of rust-preventive compound.

■ 22. POINTS TO BE OBSERVED BEFORE, DURING, AND AFTER FIRING.—*a. Before firing.*—(1) See that bore is clear and clean and remove excess oil.

(2) See that working parts of the gun are clean, oiled, and functioning smoothly.

(3) See that the telescopic sight is clamped firmly and headrest adjusted.

(4) Secure sufficient supply of ammunition.

(5) Place ammunition out of path of recoiling parts and inspect it for dirty or defective rounds.

(6) Check position of body and make sure no one is in the path of recoiling parts.

(7) Load when directed.

*b. During firing.*—(1) Observe the functioning of the gun to anticipate failures and lubricate working parts when necessary.

(2) Check bore and chamber for obstructions.

(3) Continually check the functioning of the recoil.

*c. After firing.*—(1) Clear gun.

(2) Disassemble the breech. Clean and oil the parts carefully to prevent rust.

(3) Swab the bore, with hot water and soda ash when possible, immediately after firing, then dry thoroughly and protect with a light coating of oil.

(4) Upon assembling, check the operation, insuring that the gun is functioning properly.

(5) Release the firing spring by pressing the trigger.

(6) Dismount the telescopic sight (where applicable) clean thoroughly and replace in case unless otherwise directed.

(7) At first opportunity inspect all parts and make needed repairs.

(8) Replenish ammunition when directed.

## SECTION V

### STOPPAGES AND IMMEDIATE ACTION

■ 23. DEFINITIONS.—*a.* A stoppage is any unintentional cessation of fire.

*b.* Immediate action is the procedure used for the prompt reduction of usual stoppages.

■ 24. STOPPAGES.—*a. Prevention.*—Stoppages will be reduced to the minimum if the gunner and loader have a practical working knowledge of the weapon and apply the points which should be observed before firing. *Prevention is the best remedy for all stoppages.*

*b. Causes.*—A stoppage will occur if the breech fails to open, if the gun fails to extract, fails to feed, or fails to fire.

(1) *When the breech cannot be opened.*—(a) Failure to release pressure on trigger actuator after firing.

(b) Weak or broken trigger plunger spring.

(c) Weak or broken firing pin retractor spring.

(2) *When the gun fails to eject empty cartridge cases.*—

(a) Failure to open breech smartly.

(b) Defective ammunition.

(c) Broken or worn extractor.

(d) Dirty chamber.

(3) *When the gun fails to feed.*—(a) Defective ammunition (bulged round).

(b) Dirty chamber.

(4) *When the gun fails to fire.*—(a) Broken or burred firing pin.

(b) Weak or broken firing spring.

(c) Defective trigger actuator mechanism.

(d) Damaged or missing trigger plunger spring.

(e) Broken trigger arm.

(f) Defective cartridge primer.

(5) *When gun fails to return completely into battery.*—

(a) Too little oil in recoil cylinder.

(b) Dirty or burred rails or guides; lack of lubrication on rails or guides.

*c. Frequency.*—Defects and stoppages do not occur with sufficient frequency to warrant a special form of drill in remedying them. They are listed herein for information. Such instruction will be given the soldier in their nature and the action necessary to remedy them as will insure the most efficient operation of the gun.

■ 25. IMMEDIATE ACTION.—*a.* The procedure prescribed in immediate action for the reduction of stoppages is based in the frequency with which the various types of stoppages occur. Execution of this procedure by the gunner, or loader (or both) will enable him to remedy the majority of stoppages immediately without attempting to analyze the cause. Immediate action is performed by the gunner, by the loader, or by both together. All personnel required to fire the gun will be proficient in immediate action. The procedure for immediate action is shown in the diagram below:



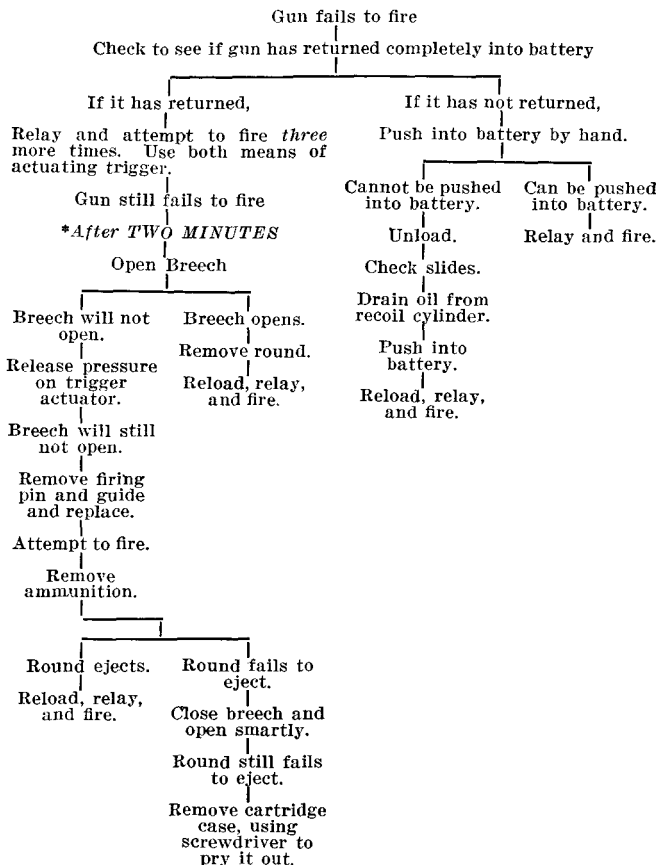

If application of the procedure does not remedy the stoppage, the gunner, the loader, or both together, must examine the mechanism of the gun in order to locate and remedy the trouble.

\*In peacetime this procedure will be strictly adhered to but in combat, the existing situation will govern.

b. To remove a case stuck in the chamber, pry the cartridge case from the chamber by means of a screw driver or similar tool. If the case cannot be extracted by this means, remove it with the rammer staff by inserting the staff through the bore from the muzzle.

c. In the event of a broken trigger plunger spring, *in an emergency*, the gun may be continued in action by manually returning the trigger to its normal position after each round is fired.

d. (1) When recoil and counterrecoil is sluggish, if necessary to continue firing, push the gun forward into battery by hand. When necessity for fire ceases, clean and grease the rails and guides. If slightly burred, smooth them carefully with crocus cloth. If burs cannot be removed with crocus cloth, turn material over to ordnance maintenance personnel for remedy.

(2) If slides or guides are not dirty or burred, remove about a tablespoon of oil from the recoil cylinder.

e. When the stoppage cannot be corrected by the application of the "immediate action" and other remedial action described above, or when no simple remedy can be applied, the gun should be turned over to competent ordnance personnel for examination and repair.

## SECTION VI

### MOUNTING GUN AND TELESCOPIC SIGHT IN TANK

■ 26. MOUNT.—The mounts provided for mounting the gun in the tank are of several different types depending upon the type of tank, the type of turret, and the position in the tank or turret in which the gun is mounted. Basically the mounts used are the double trunnion type. These mounts are attached to the tank either directly to the frame, hull, or turret, by bolts or trunnion studs; or by blocks operating on a rack or track in the turret. The majority include a gun cradle which is designed to permit free manipulation within the limits of elevation and deflection of the mount. Some of the cradles are provided with a slow motion manipulating mechanism which permits the gun to be moved through small angles of elevation or traverse when the mount and cradle are clamped. A dual cradle is provided when two guns are to be mounted in the same mount. (The caliber .30 machine gun mounted dually with the 37-mm tank gun is the HB, M1919A4 gun of the fixed type, that is, with the vertical recoil buffer backplate. Damage will result if attempts are made to install the flexible guns with their relatively bulky type of back-

plate.) The mount is designed for one-man control of elevating, traversing, aiming, and firing. The mount may provide means whereby the gun may be of the fixed or free type. A common type of tank mount now in use is shown in figures 7 and 8. (For a more detailed description of any particular mount, see the technical manual issued with the vehicle concerned.)

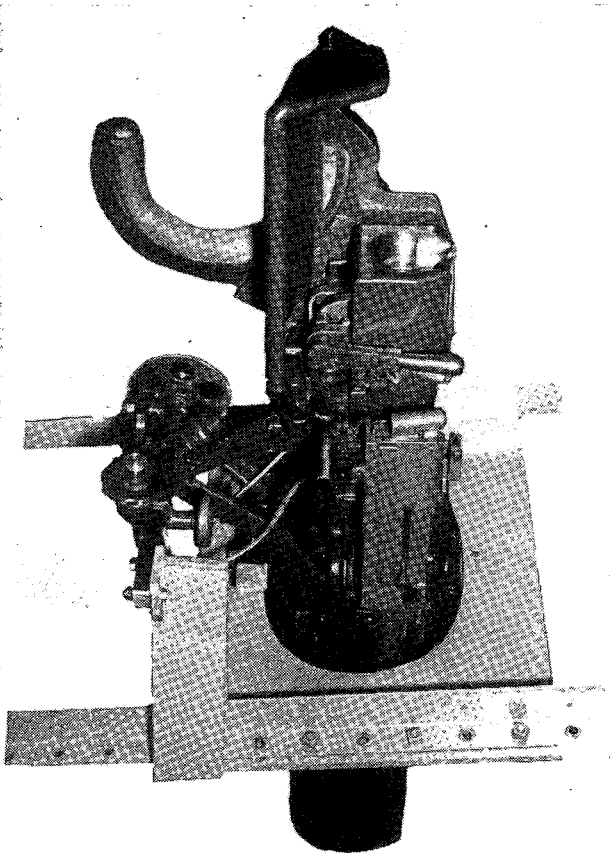

FIGURE 7.—Combination gun mount, M20 (upper right rear view).

NOTE 1. The M19, 37-mm tank gun mount is a single mount and was issued primarily for use in medium tanks. After it was in use a short while it was found that the recoil tube guard could be eliminated by making the recoil tube shorter and bringing it inside of the tank for protection. This eliminated some of the muzzle preponderance. This modification was approved and the new mount was designated as the M21 mount as is now issued.

2. The M20 tank gun mount, a combination mount, designed for use in light tanks was also modified in the above manner and is redesignated as the M22 mount, as is now issued.

3. Other type mounts are still being developed by the ordnance.

■ 27. MOUNTING THE GUN.—The mounting and dismounting of the gun is, at present, a function of ordnance personnel.

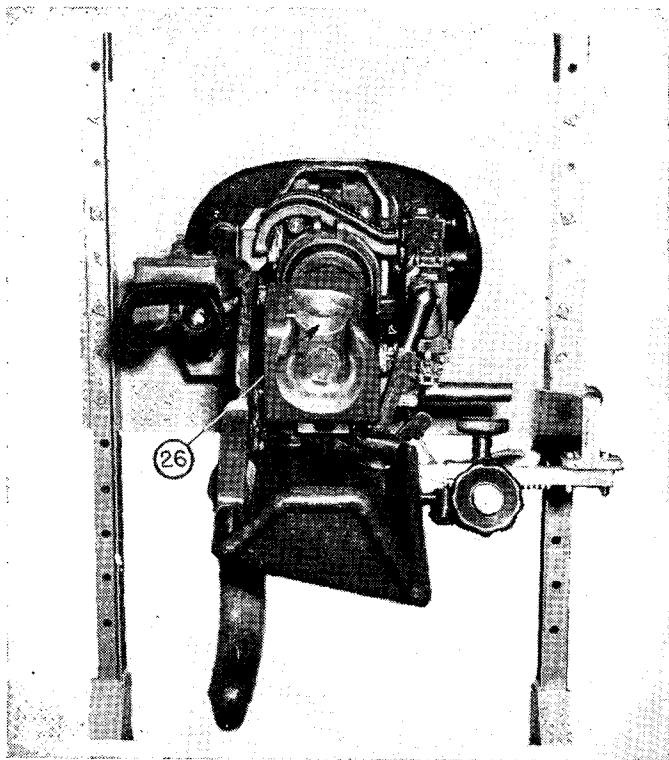

FIGURE 8.—Combination gun mount, M20 (rear view).

■ 28. SIGHTS AND HOW MOUNTED.—*a. Telescopic sight.*—The telescope, M5A1 (fig. 9), is the present standard for use in standard mechanized equipment, including tanks. The telescope is a straight tube type, using a lens erecting system. The objective end is designed to provide a very small frontal target, which also requires only a small hole in the armor plate (shield). The telescope has a magnifying power of 1 to 1.12 diameters and a field of 31°. A vertical line and horizontal line (cross hairs) are etched in the reticle of the sight. When aiming, the intersection of the cross hairs, which marks the optical center of the telescope, is placed on the point of aim (see fig. 19).

*b. Mount.*—The telescopic sight is mounted on two brackets. The front bracket has a push fit bearing to accommodate the forward end of the telescope. The rear bracket houses one of several types of adjustment devices used to target the gun.

*c. Mounting the telescopic sight.*—(1) The type of sight adjustment device on the rear bracket will alter slightly the procedure for installing the sight. At present the adjustment of the sight is accomplished by one of three methods:

(a) Four screws located radially about the rear bracket.

(b) An eccentric ring housed in the rear bracket.

(c) Vertical and horizontal slides housed in the rear bracket and operated by means of thumb screws. (The Wildrick sight adjusting bracket.)

(2) The procedure for mounting the sight (fig. 9) in the more recent model ((1) (c) above) is described below. For detailed information on the other types, see the pertinent technical manual.

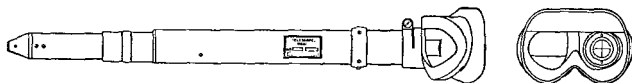

FIGURE 9.—Telescope, M5A1.

RAFSO 835

- (a) Remove sight from case.
- (b) Remove headrest.
- (c) Loosen wing nut and open swing bolt on clamping bracket.

(d) Insert sight, tapered end forward, through front bracket and push forward until front bearing is seated in front bracket.

(e) Seat anticant pin in its seat in lower half of clamping bracket.

(f) Close clamping bracket and swing bolt and tighten wing nut.

(g) Adjustment is made by turning elevation and deflection thumbscrews in the desired direction. (One click equals  $\frac{1}{2}$  mil.)

(h) Replace and adjust headrest. Particular attention must be given to the adjustment of this headrest. It should be adjusted for the gunner while his head is held in the firing position. In the firing position the head should be pressed firmly to the right against the shoulder rest body and forward against the headrest. The headrest is so adjusted that while the tank is in motion the eyes do not press against the protective rubber covering over the eyepiece of the telescope causing vision to be blacked out.

*d. Bore sight adjustment.*—(1) *Purpose.*—The purpose of bore sight adjustment is to parallel the line of sight passing through the telescope with the horizontal and vertical axes of bore of gun.

(2) *Description.*—(a) Bore sights issued with each gun consist of cross hairs to be stretched across the muzzle face of the tube or a muzzle bore sight (fig. 10 ①), and a metal disk with a centered peephole to be placed in the breech end of the bore called the breech bore sight (fig. 10 ②).

(b) Breech bore sight is a steel disk (1) having a small peephole (2) in its center and a larger hole (3) to one side of the center to permit approximate aiming. It also has a short handle (6) riveted to it, to facilitate its placement in position and withdrawing. In position, it occupies a position in the breech chamber of the gun. (Improvised methods may be employed in an emergency, such as sighting through a cartridge case from which the primer has been removed.)

(c) Muzzle bore sight is a steel disk containing a semicircular opening formed by two triangular pieces (4) projecting toward the center of the disk. A small space between these pieces, which interrupts the diametrical straightedge of the semicircle, indicates the center of the sight. A short handle is riveted to the disk to facilitate its placement in position

and withdrawing. In use, it occupies a position about 2 inches inside the bore of the gun at the muzzle. (Improved methods of accomplishing the purpose for which muzzle bore sights are provided would be to use pieces of string, wire, or horsehair stretched across the muzzle face of the tube.)

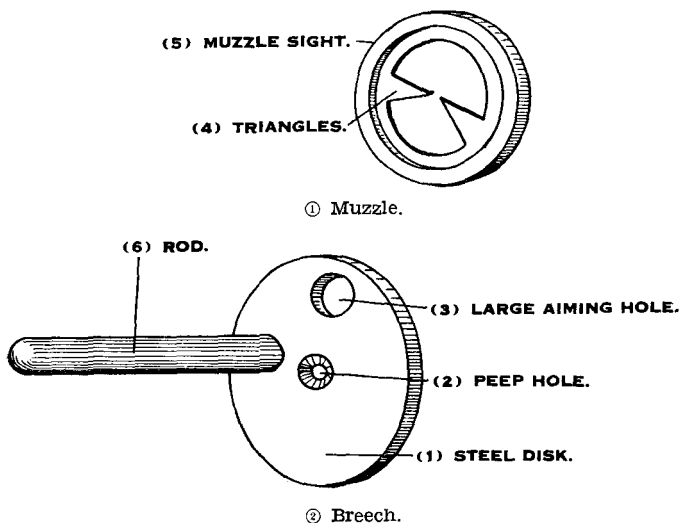

FIGURE 10.—Bore sights.

(3) *Use.*—Use of the bore sights is described in *a* above.

(4) *Adjustment.*—The bore sights have no provision for adjustment.

(5) *Care and preservation.*—The bore sights should be kept clean and free from rust. When not in use they are kept slightly oiled and, if stored for any length of time, are coated with heavy grease and packed in such a manner as to prevent their being damaged by other metallic articles.

(6) *Testing targets.*—The target used in bore sighting may be a distant terrain object or a test target for use in close proximity. Testing targets (fig. 11) for bore sighting are issued with the 37-mm tank gun. Their use is described in *e*(3) below. They are normally issued in sets of six in manila envelopes. Targets similar to that shown in figure 11 can be made on stiff paper or other suitable material. Where

a terrain object is used, it should be more than 1,000 yards away to avoid errors due to parallax.

*e. Bore sight adjustment.*—(1) *Purpose.*—The purpose of bore sight adjustment is to parallel the line of sight passing through the telescope with horizontal and vertical axis of bore of gun.

(2) *Equipment.*—Bore sights, testing target, and target frame.

(3) *Procedure.*—(a) Spot tank on fairly level ground.

(b) Insert muzzle bore sight about  $1\frac{1}{2}$  inches into bore at muzzle with bars of sight in line with horizontal marks in muzzle of gun (or stretch cross hairs across muzzle of gun using horizontal and vertical marks on muzzle face of tube for proper alinement and affix in position using chewing gum, adhesive tape, or the like). Insert breech bore sight about 2 inches into chamber of gun.

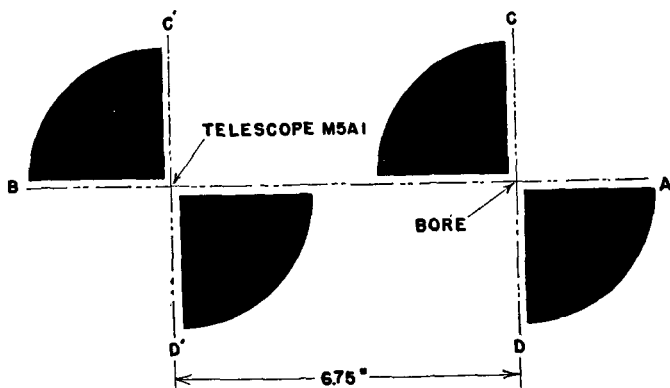

FIGURE 11.—Testing target.

(c) Suspend testing targets (d(6) above) in a plane perpendicular to axis of bore at a distance of about 80 feet from gun. In order to hold testing target in a fixed position, it is mounted on a piece of beaverboard or like substance and held against some suitable object, perpendicular to the line of sighting.

(d) Move testing target until center line of bore pierces testing target so as to bring horizontal line of muzzle bore



sight coincident with horizontal line *A-B* (fig. 11) within right figure of testing target.

(e) Rotate muzzle bore sight until bars are in line with vertical marks on muzzle face of tube and again bore sight. Move testing target until center line of bore pierces target so that vertical line of muzzle bore sight coincides with vertical line *C-D* (fig. 11) within right hand figure of testing target.

(f) With the eye properly placed at the telescope ascertain whether or not the horizontal and vertical lines on reticle are coincident with horizontal and vertical lines, *A-B*, and *C-D*, respectively (fig. 11), of left figure on testing target. If they are not, then by means of the adjusting knob on the sight adjusting bracket cause these lines to become coincident. Note carefully the readings on both the horizontal and vertical scales of the sight adjusting bracket.

(g) Recheck alinement of testing target and bore by again bore sighting. This is done to make sure that gun and target have not been thrown out of alinement during process of alining telescope. If out of alinement, reset testing target as described in (d) and (e) above. Then make a final check on alinement of sight and testing target, adjusting telescope as described in (f) above, if necessary.

**NOTE.**—Telescopes and telescope mounts are not interchangeable without adjustment. Each different telescope and telescope mount used with the same gun must be adjusted by bore sighting with that particular gun and mount.

*f. Care and preservation.*—(1) Keep clamping bolts and other bolts and nuts on telescope mounts securely tightened at all times.

(2) Exercise care to prevent denting locating surfaces on telescope and holder. Remove telescope from mount and place it in its container when not in use.

(3) Keep window in telescope and telescope holder clean. Illumination of reticle is reduced considerably by oil or dust accumulating on the glass.

(4) To remove dust from optical surfaces, brush glass lightly with a clean camel's-hair brush.

(5) To remove oil or grease from glass, apply alcohol with a clean cloth or camel's-hair brush and rub off gently with a clean, dry cloth or lens paper. If alcohol is not available, breathe heavily on the glass and wipe off as directed above. Do not wipe lenses or window with fingers or an oily cloth.

## SECTION VII

## ACCESSORIES AND SPARE PARTS

■ 29. ACCESSORIES.—Accessories include tools for such assembling and disassembling as is covered in section II, making adjustments, and cleaning gun, as well as auxiliary equipment. The names or characteristics of the accessories provided with the gun indicate their use. Therefore, no detailed description or method of use is outlined herein. A complete list of accessories may be found in SNL A-45. The principal accessories used by the gun crew consist of—

*a. Bore brush and rammer.*—(1) The bore brush is made of fiber bristles. The lower end of the brush is provided with an external threaded stud which can be screwed into the thread end of the forward section of the rammer. The brush is carried in the tool kit.

(2) The rammer consists of two sections. The forward section is threaded at both ends. One end is threaded to receive the cleaning brush and the other end the rear section of the rammer.

*b. Protective muzzle cover.*—The muzzle cover (M302) is provided to protect the gun from dirt, moisture, or obstructions. It fits over the muzzle of the gun. It is made of heavy leather to protect the muzzle if it should strike any obstacle while in travel.

*c. Oil can, 1 quart.*—This can is for recoil cylinder oil. It is carried in its compartment of the tool case.

*d. Oiler, oval, 3-ounce.*—This is the spout type oiler. It should be filled with light lubricating oil and carried in the tool case.

*e. Grease gun (Lincoln No. 5951).*—This grease gun is made to fit onto the lubricating fixtures of the gun and mount. It is carried in the tool case.

*f. Oil gun, with cap.*—This oil gun is used in refilling the recoil cylinder. It is made of brass and has a fixed threaded spout which fits the filler hole of the recoil cylinder.

*g. Tool roll, M6.*—This roll is made of canvas and is designed to carry the tools.

*h. Assorted tools.*—The tools furnished with the guns are:  
Hammer, machine, ball-peen, 8-ounce.  
Pliers, combination, slip-joint.

Punch, drive pin, standard  $\frac{3}{32}$ -inch point, 4 inches long.

Screw driver, regular, 3-inch.

Wrench, adjustable, 8-inch.

Wrench, engineer's, double head,  $\frac{3}{8}$ -inch and  $\frac{1}{2}$ -inch.

Wrench, socket, head, set screw,  $\frac{3}{32}$ -inch hexagonal.

Wrench, socket, head, set screw,  $\frac{1}{8}$ -inch hexagonal.

The tool roll and tools are carried in the crew compartment of the tank.

■ **30. SPARE PARTS.**—The spare parts for the gun and mounts are listed in SNL A-45.

## SECTION VIII

### AMMUNITION

■ **31. GENERAL.**—The information in this section pertaining to the several types of fixed complete rounds authorized for use in the 37-mm tank gun, M5, includes a description of the rounds, means of identification, care, use, and ballistic data. The ammunition used in the 37-mm tank gun, M5, is known as fixed ammunition, because the round is issued complete with the cartridge case containing the propelling charge and primer rigidly crimped to the projectile. Thus all components of the round are loaded into the gun as a unit and by one operation.

■ **32. CLASSIFICATION.**—*a.* The ammunition provided for use in this gun is classified, according to the type of projectile to be fired, as armor piercing, high explosive, canister, and target practice.

(1) The shell, 37-mm, HE (high explosive), for use against targets of opportunity, where the explosive feature of the shell will prove more destructive than armor-piercing shot.

(2) The shot, 37-mm, AP (armor piercing), M51, is for general service use, such as against armored vehicles, concrete shelters, and similar bullet resisting targets. It has an armor-piercing projectile which bears tracer compounds; it contains no explosive charge.

(3) The shot, 37-mm, TP (target practice), M51, is for use in target practice and for general field training. The projectile bears tracer compound to facilitate fire adjustment; it contains no explosive charge; the canister projectile also contains no explosive.

b. Other types provided for special purposes in which no projectile is to be fired are blank and drill.

(1) The cartridge, drill, M13, 37-mm gun, M3 and M5 for training. This type ammunition is completely inert.

(2) Blank, for simulated fire and salutes. This type ammunition has no projectile.

■ 33. FIRING TABLES.—Firing tables are not applicable.

■ 34. IDENTIFICATION.—Ammunition, including components, is completely identified by means of the painting, marking, and accompanying ammunition data card.

■ 35. MARK OR MODEL.—To identify a particular design, a model designation is assigned at the time the design is classified as an adopted type. This model designation becomes an essential part of the standard nomenclature of the item and is included in the marking on the item. Prior to July 1, 1925, it was the practice to assign mark numbers, the word "Mark" being abbreviated "Mk," which was followed by a roman numeral; for example, SHELL, HE, Mk. II. The present system of model designation consists of the letter "M" followed by an arabic numeral. Modifications are indicated by adding a letter "A" and the appropriate arabic numeral. Thus M38A1 indicates the first modification of an item for which the original model designation was M38.

■ 36. LOT NUMBER.—a. When ammunition is manufactured, an ammunition lot number, which becomes an essential part of the marking, is assigned in accordance with pertinent specifications. This lot number is stamped or marked on each loaded complete round, on all packing containers, and on the accompanying ammunition data card. It is required for all purposes of record including reports on condition, functioning, and accidents in which the ammunition is involved. To provide for the most uniform functioning, all of the rounds in any one lot of fixed ammunition consist of—

(1) Projectiles of one lot number.

(2) Fuzes of one lot number (when the projectile is fuzed).

(3) Primers of one lot number.

(4) Propellant powder of one lot number.

b. To obtain the greatest accuracy in any firing, successive rounds should be from the same ammunition lot whenever practicable.

■ 37. DATA CARD.—A 5- by 8-inch card, known as ammunition data card, is packed in each packing box with the ammunition. When required, assembling or firing instructions are printed on the reverse side of the card.

■ 38. PAINTING AND MARKING.—*a. Painting.*—(1) All projectiles are painted to prevent rust, and by means of the color to provide a ready means for identification as to type. The color scheme is as follows:

Armor piercing_____	Black.	(For 37-mm projectiles which contain no explosive filler or only a tracer.)
High explosive_____	Yellow.	
Practice_____	Blue.	(Projectile may be inert or may contain a live fuze with spotting charge of black powder.)
Inert (dummy or drill)_____	Black.	(Contains no explosive.)

(2) In the case of packing boxes, a blue band painted thereon indicates that the box contains practice ammunition.

*b. Marking.*—(1) The following information is stenciled on the projectile:

- (a) Caliber and type of cannon in which fired.
- (b) Kind of filler.
- (c) Mark or model of projectile.
- (d) Lot number of loaded projectile.

(2) Because the lot number of the loaded projectile is ordinarily not required after assembly of the complete round, it is stenciled below the rotating band where it is covered by the neck of the cartridge case.

(3) The following is stenciled on the base of the cartridge case:

- (a) Ammunition lot number.
- (b) Model of projectile.

■ 39. CARE, HANDLING, AND PRESERVATION.—*a.* Complete rounds and ammunition components are packed to withstand conditions ordinarily encountered in the field. The ammunition described herein is packed in sealed, metal-lined packing

boxes. Nevertheless, since explosives are adversely affected by moisture and high temperature, due consideration should be given to protect the ammunition from such conditions.

b. Explosive ammunition must be handled with appropriate care at all times. The explosive elements in primers and fuzes are particularly sensitive to undue shock and high temperatures.

c. Do not break moisture-resistant seal until ammunition is to be used.

d. Do not attempt to disassemble any complete rounds or any fuze.

e. Do not allow ammunition to be exposed to the direct rays of the sun for any length of time. More uniform firing is obtained if the rounds are at the same temperature.

f. The complete round should be free of any foreign matter (sand, mud, grease, etc.) before loading it into the gun. If it gets wet or dirty, wipe it off at once.

g. Rounds prepared for firing, but not fired, will be returned to their original packings and appropriately marked. Such components will be used in subsequent firing in order that stocks in opened packings may be kept at a minimum.

h. Do not handle duds. After firing, fuzes are extremely dangerous. Duds are disposed of in accordance with TM 9-1900 (now published as TR 1370-A).

■ 40. AUTHORIZED ROUNDS.—*a.* Ammunition authorized for use in the 37-mm gun, M5, is listed in the table below. It will be noted that the designation completely identifies the ammunition as to type and model of the projectile and the caliber and model of the gun in which fired.

## AMMUNITION FOR 37-MM TANK GUN, M5

Nomenclature	Prescribed fuzes		Approximate weight of projectile (pounds)
	Model	Action	
<i>Service ammunition</i>			
Shot, fixed, AP, M51 with tracer, 37-mm guns, M3 and M5.....			1.92
Shell, fixed, HE, Mk. II, with BDF M38A1, 37-mm guns, M3 and M5.....	<sup>1</sup> M38A1	<sup>2</sup> ND	1.23
Shell, fixed, HE, M63, with BDF, M58, 37-mm guns, M3, M5, and M6.....	M58	<sup>2</sup> ND	1.61
<i>Target practice ammunition</i>			
Shot, fixed, TP, M51, with tracer, 37-mm guns, M3 and M5.....			1.92
<i>Blank ammunition</i>			
Shell, shotgun, 10-gage, blank (8 gr. black powder with dry felt wads) <sup>3</sup> .....			
<i>Drill ammunition</i>			
Cartridge, drill, M13, 37-mm guns, M3 and M5.....			1.92

<sup>1</sup> This fuze not classified as bore safe.

<sup>2</sup> ND—Nondelay.

<sup>3</sup> Requires adapter, shot shell (10-gage) M2, shown on G. A. 1785. This adapter consists of a standard cartridge case modified by the addition of a liner which is chambered for a standard 10-gage shotgun shell.

b. All of the ammunition mentioned above is bore safe *except the shell, 37-mm, HE, Mk, II, which is not.* See paragraph 142 for instructions relative to precautions required when firing this high-explosive shell during peacetime.

■ 41. PACKING.—Twenty rounds are packed in a sealed metal-lined packing box. The following data for the armor-piercing ammunition are considered representative for estimating weight and volume requirements:

	Weight (pounds)	Volume (cubic feet)
Complete round without packing material.....	3.4	--
20 rounds in metal-lined packing box.....	100	2.3

The over-all dimensions of the packing box are 17½ by 12<sup>15</sup>/<sub>16</sub> by 17<sup>21</sup>/<sub>32</sub> inches.

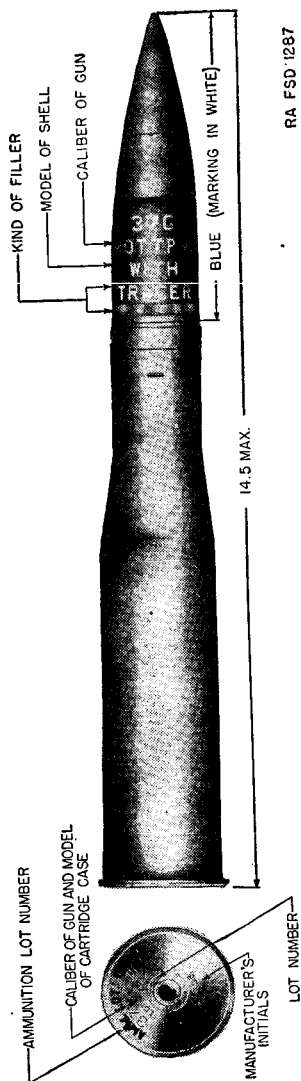

FIGURE 12.—Shot fixed, AP, M51, with tracer, for 37-mm guns, M3 and M5.

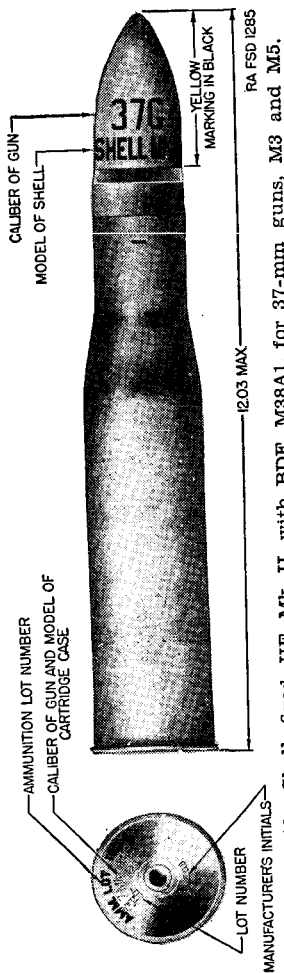
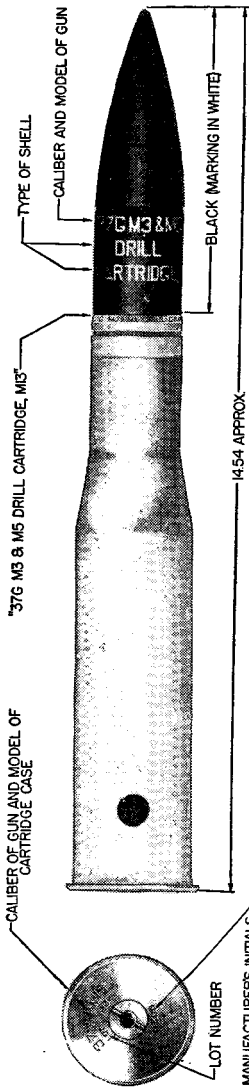

FIGURE 13.—Shell, fixed, HE, Mk. II, with BDF, M38A1, for 37-mm guns, M3 and M5.





RA FSD 1286

FIGURE 14.—Cartridge, drill, M13, for 37-mm guns, M3 and M5.

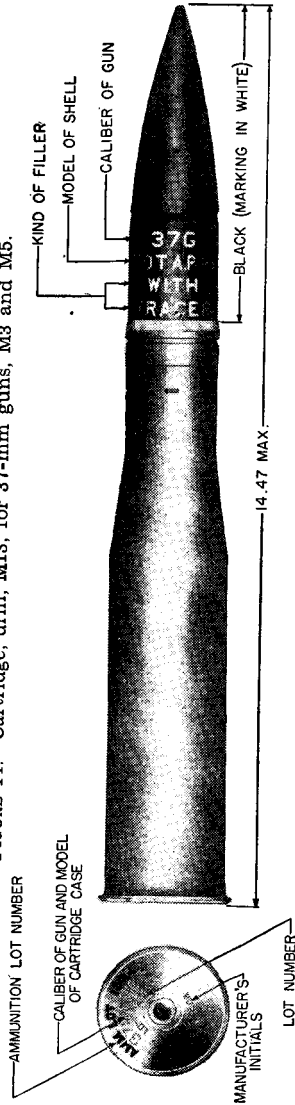

RA FSD 1284

FIGURE 15.—Shot, fixed, TP, M51, with tracer, for 37-mm guns, M3 and M5.

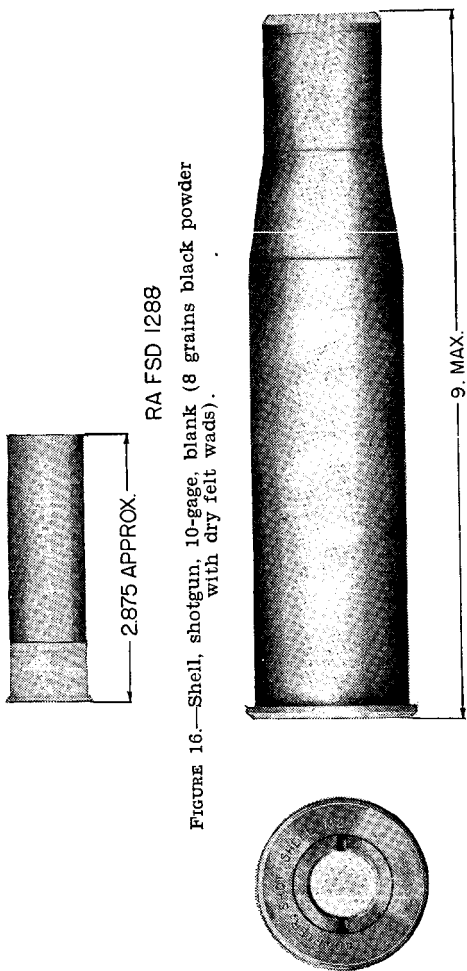

## SECTION IX

## SUBCALIBER EQUIPMENT

■ 42. GENERAL.—Subcaliber equipment at present available and being issued normally with each 37-mm tank gun is:

Caliber .22-.30 subcaliber mount M7A1.

Caliber .30, subcaliber rifle, M1903A2.

Caliber .22, subcaliber rifle, M2A1.

This equipment is issued for instructional purposes only and will not be taken into the field.

■ 43. SUBCALIBER MOUNT.—The subcaliber mount consists of a long tube, which extends the full length of the 37-mm barrel, a recoil housing, which acts as a rear bushing for the mount, and a receiver locking frame, which will receive either caliber .30 or caliber .22 subcaliber rifles. The mount is retained in place in the barrel of the gun by means of a nut which screws on the tube of the subcaliber device and bears against the muzzle of the 37-mm gun.

■ 44. TO INSTALL SUBCALIBER MOUNT.—To install the subcaliber mount in the tank mount(s) it is necessary first to remove the breechblock and tripper and the recoil guard (these parts are left out during the time the subcaliber mount is installed). To remove the recoil guard, remove the recoil cylinder cross head bolt (see par. 7i(2)), then pull the gun tube to the rear about 6 inches and remove the cap screws (thus made accessible) holding the recoil guard to the body of the shoulder rest. Remove the rear pin holding the recoil guard and pull the recoil guard to the rear. These two steps having been taken, insert the long extension tube completely through the barrel of the 37-mm gun. (*Make sure that the axis of the bore (37-mm gun) is in line with the rear pistol port (door) of the turret.*) Push the recoil housing into the breech with the rifle bolt up, making sure that the cuts in the sides are in line with the extractors. Place the fiber washer over the protruding end of the tube. Rotate the nut in the threaded end of the tube, using spanner wrench provided, in order to securely retain the mount in place. Disassemble cable and fittings assembly of 37-mm gun as described in paragraph 7i. Install cable and fittings assembly of subcaliber mount as described in paragraph 7k.

■ 45. TO INSTALL EITHER SUBCALIBER RIFLE IN SUBCALIBER MOUNT.—To install either the caliber .30 or caliber .22 sub-caliber rifle in the subcaliber mount, remove the magazine floor plate, the follower spring, and follower from the rifle. Remove the front and rear trigger guard screws. Insert the rifle muzzle and forward barrel bushing into the subcaliber mount rear housing, until the rifle is completely seated, with bolt up. Insert the trigger guard assembly in the receiver locking frame. Swing the locking frame into its close position. Replace the front and rear trigger guard screws. Replace the magazine floor plate, follower spring, and follower. Check to make sure that the trigger arm of the subcaliber mount is ahead of the rifle trigger.

■ 46. TO REMOVE EITHER SUBCALIBER RIFLE FROM SUBCALIBER MOUNT.—Remove the magazine floor plate, the follower spring, and follower. Remove the front and rear trigger guard screws. Swing the receiver locking frame downward, until the rifle trigger is cleared. Remove the subcaliber rifle to the rear.

NOTE.—Always check to see that the brass forward barrel bushing is in the muzzle of the rifle before inserting it in the subcaliber mount. Only one of these bushings is issued with the equipment; it fits both the caliber .30 and caliber .22 rifle. Whenever the caliber of the firing is changed, it is necessary to change the bushing from one rifle to the other. To remove, tap the rear of the bushing gently with a drift.

■ 47. ADDITIONAL ARTICLES FOR INSTRUCTIONAL PURPOSES.—Additional articles for instructional purposes consist of:

Adapter, blank cartridge, 37-mm gun, M3 and M5.

Cartridge, drill, M13, 37-mm gun, M3 and M5.

Chart, instruction, ammunition, 37-mm gun, M3 and M5.

(Detailed information is to be included when data become available.)

■ 48. ACCESSORIES AND SPARE PARTS.—The accessories for the rifles and mount are listed in SNL A-45 (page 10).

## SECTION X

### INDIVIDUAL SAFETY PRECAUTIONS

■ 49. GENERAL.—This section prescribes the safety precautions to be taken by individuals during practice in firing the 37-mm tank gun, M5, in order to minimize the possibility of

accidents. (See AR 750-10 and TM 9-1900 (now published as TR 1370-A).)

■ 50. PRECAUTIONS DURING PRACTICE FIRING.—*a.* Any individual who observes a condition which makes firing dangerous will immediately call: **CEASE FIRING**, and if at a distance from the unit firing, will make the prescribed signal therefor.

*b.* Firing will cease immediately at the command **CEASE FIRING** regardless of the source of the command.

*c.* No firing will be done except under the direct supervision of an officer.

*d.* Guns will be loaded only on command of the officer or noncommissioned officer in charge of the firing.

*e.* Firing will commence on any range only after it has been determined that the range is clear and the officer in charge of firing gives the order: **COMMENCE FIRING**.

*f.* For safety precautions observed when firing high-explosive shell, which is not bore safe, see paragraph 142.

■ 51. INSPECTION DURING FIRING.—*a.* Before each day's practice firing, each gun will be inspected by an officer to insure that the bore is free of obstructions and that excess oil or grease has been removed therefrom.

*b.* After firing and prior to moving the gun from a firing position, it will be inspected by an officer to see that it is unloaded.

*c.* The gun will be cleared as prescribed in paragraph 61*h* before anyone moves in front of the muzzle or the gun is moved.

■ 52. PRECAUTIONS BEFORE FIRING.—*a.* The gunner will check his position to make certain he is not leaning against the shoulder guard and that no part of his body will be in the path of the gun upon recoil.

*b.* The loader will check his position to be certain his body is clear of the rear of the gun.

*c.* All ammunition at the firing point must be placed so that it will be impossible to ignite, explode, or detonate it in case of an accident at the gun. Ammunition should be kept in a dry place and protected from the direct rays of the sun. Erratic shots and possibly dangerously high powder pressure may result from overheated ammunition.

■ 53. PRECAUTIONS DURING FIRING.—*a.* The individual safety precautions listed in paragraph 52 will be taken during the firing of the gun.

*b.* Ammunition will be inspected to see that it is clean and free of grease and oil.

■ 54. MISFIRES.—*a.* When a misfire occurs, the gun will be cocked by hand, and without opening the breech, the trigger actuator plunger will again be pressed. During practice firing, at least three attempts to fire the round will be made; if the round still fails to fire, the breech will not be opened until 2 minutes have elapsed. In recocking gun by hand, keep the body clear of the gun. (See pars. 24 and 25.)

*b.* When rounds which misfire are removed from the gun, they will be placed at a designated point away from the gun position. They will be destroyed under the direct supervision of an officer in accordance with specific local regulations or in accordance with instructions contained in TM 9-1900 (now published as TR 1370-A).

## CHAPTER 2

### TRAINING FOR PLACING GUN IN ACTION

■ 55. GENERAL.—*a.* (1) The purpose of training for placing the 37-mm tank gun in action is to develop the gun crew to function as a team with precision and speed in putting the gun into action and taking it out of action, in servicing it during firing, and in continuing it in action. Throughout training, speed in preparing for action and firing rapidly requires the coordinated effort of each member of the gun crew and should be emphasized.

(2) Teamwork is attained when each member of the gun crew thoroughly understands the importance of his duties, their relation to and the effect upon duties to be performed by the other member of the gun crew.

(3) Precision is acquired by performing each operation and making each move in proper sequence with exactness and in accordance with prescribed procedure. Speed is developed through practice, during which both members of the crew acquire the facility to perform each operation automatically.

(4) Continuation of the gun in action is assured by training each member of the gun crew in the duties of the other member. This is accomplished by rotating the members during drill.

(5) During the early stages of instruction, movements are carefully explained and demonstrated. The individuals will then be required to execute the movements slowly and carefully. The tempo of the drill is gradually increased until all positions can be assumed and all movements executed rapidly without confusion or lost motion.

(6) When not specifically prescribed, the instructor takes position from which he can best supervise and direct training. This is usually on top of the tank in rear of the turret.

b. The 37-mm tank gun, M5, mounted in the tank, is normally installed in the vehicle park or other permanent or semipermanent establishment. The gun remains mounted in the tank at all times unless removed by qualified personnel.

c. No drill is prescribed for mounting and dismounting of the gun in the vehicle. Ammunition and accessories are placed in the vehicle under the supervision of the tank commander.

d. Upon receipt of an order to mount the tank weapons, the tank commander causes the procedure prescribed in FM 23-65 and FM 23-50 to be followed. For the 37-mm gun this procedure consists of mounting the telescopic sight, adjusting the headpiece, and verifying the presence of ammunition, essential accessories, and spare parts. The report of **READY**, to the next higher commander indicates that this has been accomplished.

e. When used in this manual the term "gunner" refers to the tank commander and the term "loader" refers to the tank gunner as so designated in the Tables of Organization.

■ 56. **ACTION NOT IMMEDIATE.**—When tanks are in parks, bivouacs, or other installations provided with local security by other units, or are making moves during which action is not imminent, the 37-mm gun will be locked in the traveling position (fig. 6②).

■ 57. **ACTION IMMEDIATE.**—When action is imminent, the guns will be released from their traveling position. Ammunition and accessories will be placed in the most convenient position for immediate use. The gunner and loader will be in position and on the alert to engage immediately any suitable target which presents itself. Consistent with previous orders, when suitable targets are expected, the piece is loaded and the gunner engages the target.

■ 58. ABANDONING DISABLED TANK.—On the battlefield, the decision to abandon a disabled tank is made by the tank commander. The 37-mm gun not being provided with a ground mount is disabled by removing the firing pin and guide assembly from the breechlock (see par. 7a).

■ 59. DISMOUNTING FROM TANK FOR DISMOUNTED ACTION.—When directed, the weapons, other than the 37-mm gun, may be dismounted and disposed for ground use. (See FM 23-65 and FM 23-50.) Tanks are normally disposed for their own security. When such action is directed, the drivers remain with the tanks to operate remaining weapons.

■ 60. TRAINING.—The tank crews of the various types and classes of tanks must be trained to install the accessories to the gun in the tank, engage typical targets with speed and facility (see paragraph 155 for suggested exercise) and to abandon the vehicle and disable the gun (when necessary).

■ 61. SERVICE OF PIECE.—*a. General.*—Efficient service of the piece requires the coordinated effort of both members of the gun crew. Therefore, prior to firing subcaliber or service ammunition, the pair will be thoroughly trained in the mechanics of servicing the piece. They will be trained to function as a team while simulating firing, going through the motions with dummy ammunition, of loading, firing, and unloading. Rapid loading and unloading will permit rapid firing and should be emphasized. Prior to conducting this training, sufficient instruction must be given to the gunner in the use of the sight and in laying the piece to enable him to aim properly. Initially, only fixed targets which are easily discernible and a "fixed gun" should be employed. As marksmanship instruction progresses, all types of targets and a "free gun" may be used.

*b. To prepare gun for firing.*—Preparing the gun for firing includes the checks prescribed in paragraph 22 and in addition the following—the gunner takes a position on the left side of the gun and mount. The loader takes a position on the right side of the gun.

(1) The loader unlocks the piece from the traveling lock and places the traveling lock in the raised and inactive position in the turret top. He then takes his firing position, opens the breech, and inspects to see that the chamber and bore are clean and clear.



(2) The gunner installs the telescopic sight (see par. 28) and takes his firing position, tests the elevating and traversing mechanism and trigger actuator mechanisms and if found to be in working order calls: UP.

(3) Any deficiencies noted in matériel or ammunition by either the gunner or the loader while preparing the gun for action will be immediately reported to the platoon leader or platoon sergeant.

*c. Positions of gun crew during firing.*—The gunner either stands on the left of the piece or occupies the gunner's seat.

(1) *While firing a "fixed" gun.*—(a) The left hand is placed on the actuating knob of the elevating handwheel, the shoulder firmly against the shoulder guard and the right arm under the gun mount with the right hand on the right hand support bracket whereby he actuates either gun (37-mm or cal. .30) with his right thumb. (*Because of the recoil of the gun, he avoids extending his right arm over the shoulder guard.*) He operates the elevating mechanism with his left hand and the traversing mechanism by physical pressure against the mount. This position is most applicable when firing the gun, in combat, from positions of partial tank defilade.

(b) The gun may be traversed by means of the traversing handwheel. In this method of firing the turret gun(s), the right hand is placed on the elevating handwheel with the thumb on the caliber .30 trigger actuator. The 37-mm gun must then be fired, using the left hand, by means of the trigger actuator plunger in the hub of the elevating handwheel.

(2) *While firing a "free" gun.*—(a) The left hand grasps the mount by means of the hand support bracket on the left of the mount. The shoulder is firmly against the shoulder guard and the right arm under the gun mount with the right hand on the hand support bracket on the right of the mount. The guns are actuated with the right thumb. He is trained to elevate, traverse, and fire the gun simultaneously, in an accurate and rapid manner. He aims and lays the gun as described in paragraphs 70, 72, and 73.

(b) The loader assumes a position at the gun, on the right, that will avoid his injury by the recoil. He either occupies the right turret seat or takes a position so that he loads, with his left hand, and opens and closes the breech with his right

hand. He insures that sufficient ammunition is kept within convenient reach.

*d. To load.*—(1) Unless specifically ordered otherwise, the gun is loaded when directed by the gunner (tank commander). Exceptions to this procedure occur during marksmanship instruction where, as a safety precaution or for control purposes, it is necessary to announce the number of rounds to be fired in an exercise and to specify when the gun is to be loaded (see par. 82c).

(2) To load the gun, the loader grasps a cartridge at the base with his left hand turning the projectile to the front as he swings his arm toward the breech, and carefully inserts the round in the breech opening, pushing it into the gun chamber with the fingers until the rim of the cartridge contacts the extractor lips. He then quickly closes the breech with the right hand. As soon as the breech is closed, the loader calls: UP, or touches the gunner, so that the gunner will know that the gun is ready to fire. After inserting the round in the chamber, the loader shall immediately withdraw his left hand to the left rear, and obtain the next round.

*e. To fire gun.*—The gun having been loaded (and the command COMMENCE FIRING having been given), the gunner will open fire as soon as he is laid on the target. To fire the gun, the gunner pushes sharply on the trigger actuator and quickly releases it.

NOTE.—During all firing of the gun(s) the points to be observed during firing will be carefully observed.

*f. To unload.*—(1) To remove the empty casing after firing, the loader opens the breech smartly with his right hand. He immediately reloads the gun as described in *d* above, unless the gunner indicates otherwise. The empty casings are allowed to drop onto the floor during firing and are replaced or disposed of at the first opportunity.

(2) To unload a round which has not been fired, the loader slowly opens the breech with the right hand, grasps the round with the left hand as it is extracted from the chamber.

(3) To unload when the extractor fails to function, the loader will attempt to pry the cartridge case or round from the chamber by inserting a screw driver or similar tool between the base of the case and the chamber. In the event the round cannot be removed by this method (and until some

other means is devised) the gun will of necessity remain inactive until such time as it will be practicable for the tank to stop and the rammer staff can be inserted into the bore at the muzzle and the empty casing removed by pushing with a steady pressure on the head of the rammer staff. The loader, at the breech, receives the ejected round.

(4) In the event of a misfire (during practice firing), the procedure described in paragraphs 24 and 54 will be followed. The gunner will make three successive attempts to fire the piece by cocking it by hand and operating the firing mechanism. If the gun still fails to fire, *and when 2 minutes have elapsed after the last attempt to fire* (AR 750-10), the loader will unload the gun as described in *f* above, and will pass the defective round to a member of the crew who will remove it from the vicinity of the firing position to a place indicated by the officer in charge.

*g. To cease or suspend firing.*—(1) *Cease firing.*—Firing is stopped and the gun, if loaded, is unloaded on command or signal **CEASE FIRING**. The members of the gun crew may leave their firing positions. **CEASE FIRING** is used to announce long pauses while firing.

(2) *Suspend firing.*—At the command **SUSPEND FIRING**, firing stops, the gun is loaded and remains ready, or is made ready, for instant resumption of fire. The posts of the gun crew remain unchanged. The gunner continues to observe and lay on the target or lays on a new target, if one is designated, so that he may resume fire with the least practical delay the instant resume firing is directed. **SUSPEND FIRING** is used for short pauses in the firing. For example, when the target disappears temporarily or moves out of range, or when shifting to a new target.

(3) *Application.*—The formal commands **CEASE FIRING** and **SUSPEND FIRING** are used only during instruction of personnel and during practice firing.

*h. To clear gun.*—If the gun has been put into action with service or subcaliber ammunition present, the gun must be cleared before anyone moves in front of the muzzle. At the command: **CLEAR GUN**, the loader unloads the gun and leaves the breech open. During practice firing, an officer will then inspect the gun to make sure that there is no ammunition in it. Under service conditions, or in the absence of an officer, the tank commander will make the above inspection.

When using subcaliber ammunition, the same procedure is followed, except that—

(1) When firing the caliber .30 subcaliber rifle, all rounds will be ejected from the chamber and receiver and the bolt left open after ejecting the last round.

(2) When firing the caliber .22 subcaliber rifle, the ammunition magazine will be removed, the chamber emptied, and the bolt left open.

*i. To go out of action.*—The command is: **OUT OF ACTION.**

(1) The loader unloads the gun, if loaded, and closes the breech. The gunner releases the trigger by pressing on either trigger actuator and calls: **CLEAR**, to the tank commander.

(2) The gunner then manipulates the gun so that the loader can lock the gun in the traveling lock.

(3) The gunner then removes the sight (if so directed) and replaces it into the carrying case.

(4) In the meantime, the loader moves the ammunition clear of the gun and replaces the unused rounds into the ammunition containers. Empty cases are placed in containers or otherwise disposed of.

## CHAPTER 3

### MARKSMANSHIP

	Paragraphs
SECTION I. General.....	62-64
II. Preparatory training.....	65-75
III. Preliminary gunners' examination.....	76
IV. Range practice, including qualification courses.....	77-80
V. Conduct of range practice, including record practice and individual safety precautions.....	81-92
VI. Targets, ranges, and range precautions.....	93-97

#### SECTION I

#### GENERAL

■ **62. PURPOSE.**—The purpose of marksmanship instruction with the 37-mm tank gun is to train personnel to deliver prompt and accurate fire on moving or stationary targets. The final measure of the effectiveness of the 37-mm tank gun in battle is its ability to destroy or neutralize rapidly the targets it is employed to engage.

■ 63. SCOPE.—*a.* Training in marksmanship with the 37-mm tank gun is divided into the following phases:

(1) Preparatory marksmanship training.

(2) Subcaliber instruction and record firing practice on the 1,000-inch moving target range.

(3) Instruction and record firing practice on the moving target field ranges.

*b.* Instruction in the first phase of training forms the basis for training in the second and third phases. It is therefore essential that the sequence of instruction be such that each man become proficient in one phase before proceeding to the next.

■ 64. PRIOR TRAINING.—Before receiving instruction in marksmanship, the soldier will be proficient in mechanical training, elementary training for placing the gun in action, and service of the piece as contained in chapters 1 and 2.

## SECTION II

### PREPARATORY TRAINING

■ 65. GENERAL.—During preparatory marksmanship training, the soldier is taught to align his sight properly on an aiming point, to assume the proper position at the gun, to manipulate the gun, to aim, to lead and track a moving target, and to target the gun for firing.

■ 66. SCOPE.—Preparatory training consists of the following exercises which have for their purpose the progressive instruction and training of the soldier in the fundamentals of marksmanship:

*a.* Aiming exercises.

*b.* Tracking exercises.

■ 67. METHOD OF INSTRUCTION.—*a.* The applicatory method of instruction is used throughout. Each exercise is first explained and demonstrated to all the men undergoing instruction. The demonstration should be performed by a group which has been previously trained to perform the exercise. Each man is then given practical work in the exercise. Finally, the men are examined in order to determine their progress or proficiency.

*b.* The officer in charge of instruction should detail such assistants as he may require. Assistant instructors will

usually be the various leaders of the units undergoing instruction; however, specially selected men may be used for this duty. The platoon is about the largest group that can be efficiently instructed by a single instructor, who will usually be the platoon leader. Platoon sergeants and tank commanders should act as assistant instructors to organize and supervise the work. The tank commanders should act as gun crew instructors and conduct instruction at each gun. It is an advantage to have the assistant instructors trained in advance, but it is not essential where units are being hastily organized and time is not available.

c. The instruction must be individual and thorough. A tank crew is about the largest unit in which each individual can be closely supervised; therefore, if guns are available, it is preferable to assign a crew to each gun. Each man must be brought to as high a state of proficiency as time permits.

d. The coach-and-pupil method should be used wherever applicable. Under this method the men are grouped in pairs and take turns in coaching each other.

e. Upon the completion of the explanation and demonstration of any exercise the instructor sends the men to their guns, where, under the supervision of the platoon sergeants, the gun crew instructors (tank commanders or specially selected men) conduct practical work.

f. When conducting aiming and tracking exercises, instruction may be expedited by having all or part of the guns execute the same exercise simultaneously, in which case the exercises are conducted by one individual, who issues the orders and causes the target(s) to be operated in a manner similar to that employed in conducting 1,000-inch range firing. During each exercise, a careful check is made at each gun (by use of aiming device—if available) to insure correct and accurate aiming and smooth tracking.

g. Throughout marksmanship instruction, a competitive spirit should be developed between gun crews and individuals. During preparatory instruction, as the men become trained in fundamentals, competitive exercises should be devised to create added interest in the work. *Speed in manipulation and accuracy in aiming should be emphasized throughout.* Each individual performing an operation must be carefully

checked by platoon leaders and tank commanders to insure correct application of prescribed methods of aiming and tracking. Failure to make such a check may permit the development of speed at the expense of accuracy, which is not desirable.

■ 68. EQUIPMENT.—Assuming that one platoon (four tanks) is undergoing instruction simultaneously, the following equipment, in addition to the four tanks with guns mounted, is required for preparatory training.

a. Small portable blackboard.

b. Two portable standing frames and the following aiming silhouette targets (par. 93):

(1) Two single tanks.

(2) Two multiple tanks.

c. One sled, target carrier (par. 96).

d. One 1,000-inch range apparatus for operating moving targets (par. 95).

e. Stop watch.

f. Tape measure, 50 feet or longer.

g. One progress and proficiency card for each tank crew undergoing instruction.

■ 69. PROCEDURE.—a. Initial training in preparatory marksmanship can usually be conducted in the immediate vicinity of barracks or camp. For outdoor instruction, a cleared, fairly level area of ground measuring about 75 by 200 feet will accommodate two platoons of an armored regiment (light or medium). If floor space, lighting facilities, and training mounts (figs. 18 and 19) are available, some of the instruction may be conducted indoors. More advanced preparatory training in marksmanship should be conducted on the 1,000-inch moving target range.

b. A compact and convenient arrangement of guns and targets for preparatory marksmanship training is shown in figure 20. This arrangement is particularly desirable because it permits simultaneous instruction of all gun crews within a relatively small area; this will facilitate control and supervision by the instructor. Instruction for the assembled group is conducted in the vicinity of some convenient spot, such as *D*. Upon the completion of this instruction, the men are sent to

their respective guns along the lines *A-B* and *E-F*, where the tank commanders conduct individual instruction under the direct supervision of platoon sergeants or other designated noncommissioned officers. The instructor and assistants are free to move about and generally supervise the instruction. For aiming exercises, the portable aiming targets, which bear aiming tank silhouettes on both sides, are arranged along line *C-D*. When tracking exercises are conducted, the sled target is pulled along the line *C-D* at specified speeds. All guns can participate simultaneously in the same tracking exercise by following the procedure outlined in paragraph 135*k*.

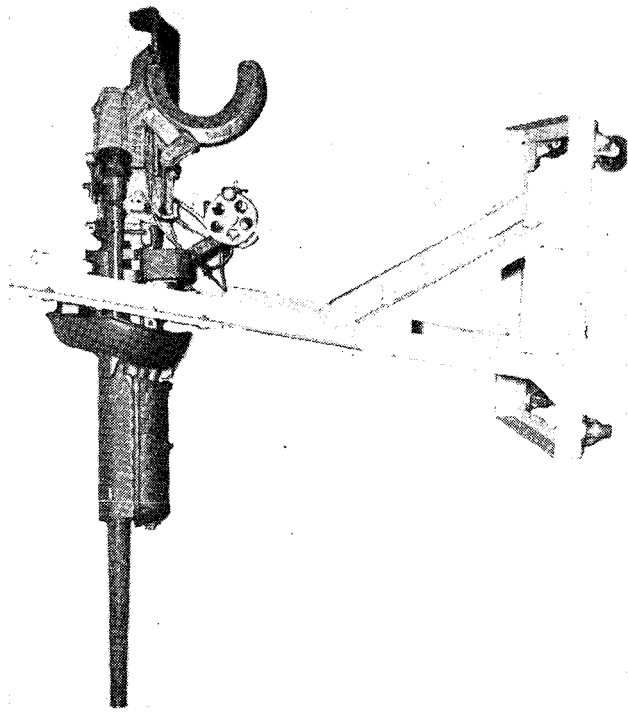

FIGURE 18.—37-mm tank gun, M5 training mount.



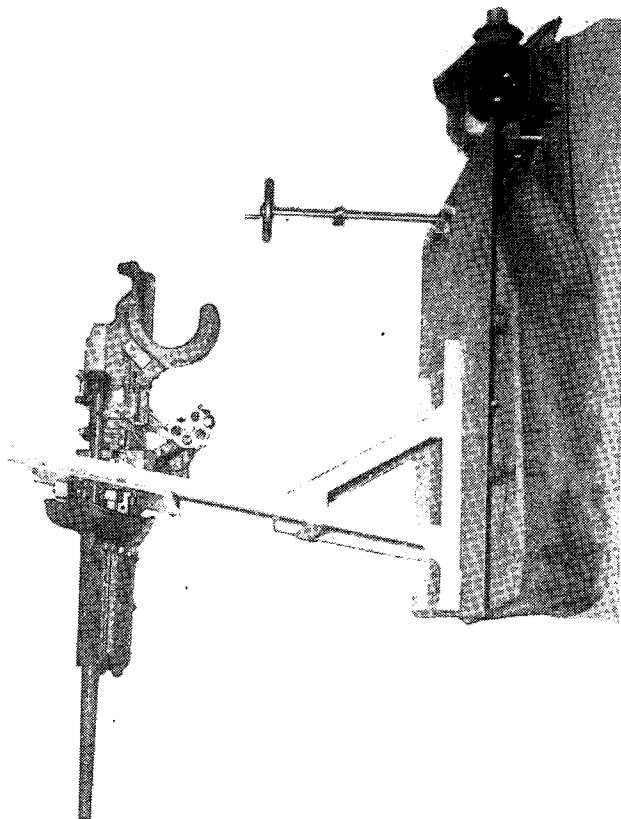

FIGURE 19.—37-mm tank gun, M5 training mount.

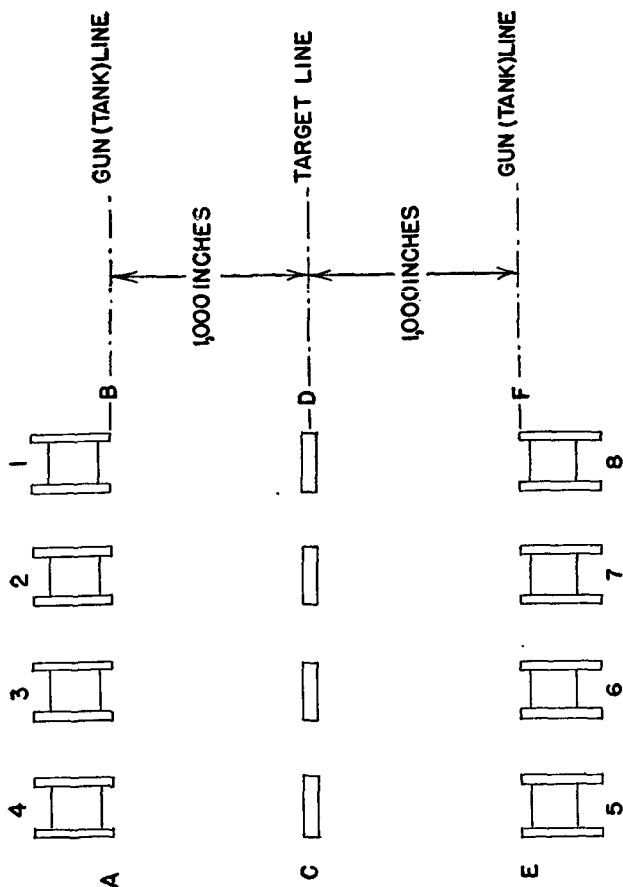

FIGURE 20.—Gun (tank) and target arrangement for preparatory marksmanship training.

■ 70. SIGHTING AND AIMING.—*a. Definitions.*

(1) *Sighting*.—Sighting consists of placing the eye at a position from which the sights are seen in their proper relation to each other (not applicable to the telescopic sight).

(2) *Aiming*.—Aiming consists of moving the gun so that the target is seen in proper relation to the sights.

*b. Exercises*.—The purpose of the sighting and aiming exercises is to teach the soldier to align the sights properly on the

target. This is accomplished in three exercises as follows:

(1) *First exercise.*—The soldier is—

(a) Shown by charts or other means the correct picture which should be seen through the sights when the sights are properly alined (fig. 21 ①).

(b) Shown the correct picture which should be seen when the sights are properly alined on the target (see figs. 21 ② and 22).

(c) Required to adjust the sight on a fixed gun to show the correct sight picture and to detect small errors in the adjustment made by other members of the group.

(2) *Second exercise* (figs. 23 and 24).—The soldier is required to direct the movement of an aiming point (spotter) on a target about 1,000 inches from the gun so that the correct sight picture is seen through the sights. Additional members of the group are used to assist in signaling and in moving the aiming point (see fig. 24).

(3) *Third exercise.*—In order to emphasize the importance of exactness and uniformity of aim, the soldier is required to repeat (2) above, until he is able to adjust the aiming point (spotter) with such accuracy that the triangle made by the points marking the center of the spotter on three successive adjustments may be inclosed with a circle  $\frac{1}{2}$  inch in diameter. The sights, the gun, and the target (upon which the spotter is being moved) must remain in exactly the same position during these three successive adjustments. The position of the spotter on the target is recorded by inserting a pencil point through a hole in the center of the spotter and marking the point on the target.

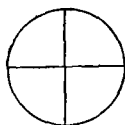

① Without target.

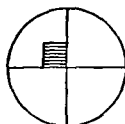

② With target.

FIGURE 21.—Telescopic sights.

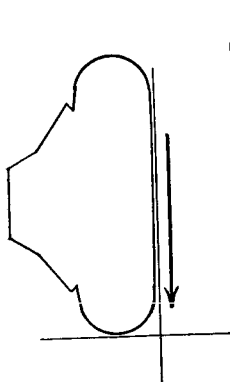

**MOVING FROM RIGHT TO LEFT**

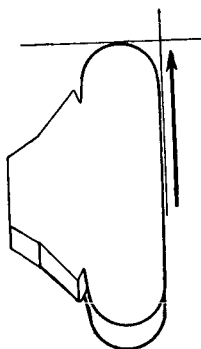

**MOVING AWAY FROM GUN AT AN  
ANGLE FROM LEFT TO RIGHT**

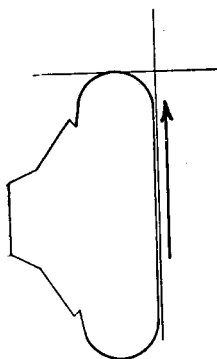

**MOVING FROM LEFT TO RIGHT**

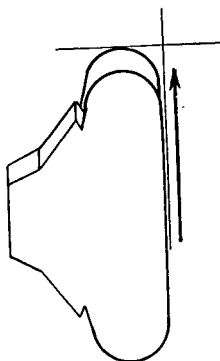

**MOVING TOWARDS GUN AT AN  
ANGLE FROM LEFT TO RIGHT**

**FIGURE 22.**—Aiming on moving silhouette targets. (Intersection of cross hairs indicates point of aim; arrow indicates direction of travel.)

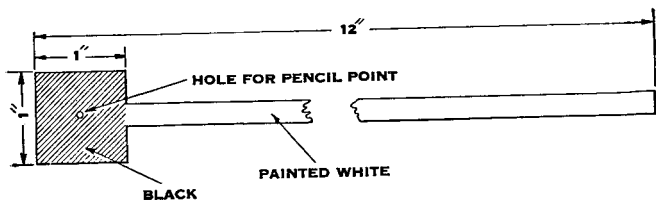

**FIGURE 23.**—Spotter used in second and third exercises.

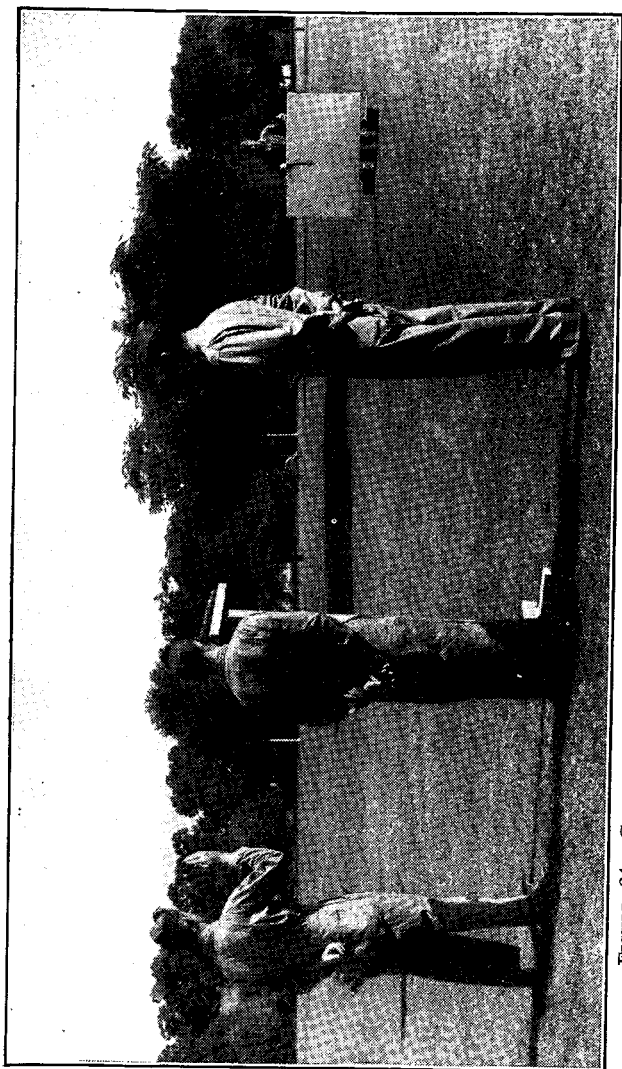

FIGURE 24.—Group executing second or third exercise (with telescopic sight).

■ 71. POSITIONS.—*a. For guns mounted in tank.*—The gunner takes a position which will permit him to brace himself without constraint and at the same time efficiently control his gun. This position will vary for men of different conformation and according to vehicle or mount used. The hands will be placed in such positions as will best facilitate manipulating and firing (see ch. 2). A free gun should be held securely but without rigidity. Riding the gun in an effort to hold it on the target will result in dispersion and unsatisfactory performance. The head is placed in a position best suited to aline the sights and to observe the target and the effect of fire. The sling seat or other standard equipment issued for the support of the gunner may be used. *The use of pillows, pads, or other improvised supports or aids for the gunner or the mount (with the exception of the adjustable shoulder rest, where applicable) is prohibited during record firing.* Position exercises, using a target or other aiming point, will be conducted to insure that each man can take a suitable position at the gun and aim it without delay.

*b. For rapidly moving ground or air targets.*—When firing on rapidly moving ground or air targets, the gunner will, when possible, assume a position which will permit him to manipulate the mount freely through large angles and to observe the tracers in prolongation of the bore.

■ 72. MANIPULATION.—*a.* Manipulation consists of shifting the direction of the gun from one point to another definite point. After the soldier understands the fundamentals of sighting and aiming and can assume a satisfactory position at the gun, he will be given instruction in manipulating the gun so that he can initially lay the gun, then shift the direction of the gun to successive points with accuracy, facility, and speed. When manipulating to track a rapidly moving target, the mount should be adjusted to permit free movement of the gun, except that when firing from a stationary position the elevating mechanism should be used for making changes in elevation.

*b.* When manipulating to cover a stationary target, the soldier should be required to manipulate slowly over the target upon which he is to fire, his accuracy being checked by a coach or assistant instructor. As he gains facility in

manipulation, the time should be decreased until he is capable of accurately manipulating over the target, without firing within approximately two-thirds of the authorized time limit.

■ 73. AIMING.—The telescopic sight being habitually used with the gun, the soldier will be given the instruction necessary to insure his ability to aim on the target accurately and rapidly. Accuracy of the aiming is checked by an assistant or coach. As soon as the gunner gains facility, the permissible time limit is reduced.

■ 74. LEADING AND TRACKING.—*a. General.*—(1) The gunner will complete a course of instruction in firing the machine gun mounted in the tank from a stationary tank at stationary and moving targets, and from a moving tank at stationary and moving targets before he is given similar instruction with the 37-mm tank gun.

(2) Battlefield targets to be engaged by a 37-mm tank gunner may be either moving or stationary. Hence he must be taught to engage both with equal speed and facility. The technique of engaging a moving target or a stationary target from a moving tank differs from that of engaging a stationary target from a stationary tank in that the gun must be aimed ahead of the target at a sufficient distance to cause the projectile and the target to arrive simultaneously at the same point. This distance is measured in target lengths, one target length, as seen by the gunner, being one lead (see fig. 25). The number of leads necessary will depend upon the range, and speed and direction of movement of the tank and of the target. To hit the target, the gunner aims at a point ahead of the target equal to the estimated number of leads, maintains this lead by tracking the target (manipulating the gun at the same angular speed as that of the target), and then fires. Fire is adjusted by observation of strike or trace. To accomplish this, exercises are conducted on targets moving over courses designed to give practice in tracking and firing at targets which, as to speed and direction and irregularity of approach or movement, approximate those that will be encountered in combat.

*b. Procedure.*—These exercises are conducted on the 1,000-inch range and the procedure corresponds as nearly as practicable to that followed when conducting 1,000-inch range

firing (see pars. 82 and 88). By so doing, the group undergoing instruction will receive early training in a systematic and orderly range procedure which is considered necessary for efficient conduct of firing exercises.

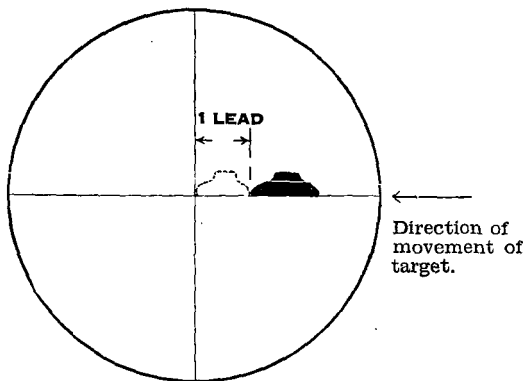

FIGURE 25.—M5A1 telescopic sight with one target-length lead.

*c. Equipment.*—The standard range equipment described in paragraphs 95 and 96 is necessary. Either target similar to those used for the aiming exercises or the standard 1,000-inch range targets may be used (pars. 93 and 94). All targets should have the silhouette aiming tanks on both sides.

*d. Organization.*—(1) *Platoon leader.*—Conducts instruction and supervises generally the work of the entire platoon.

(2) *Platoon sergeant.*—Issues the orders for conducting the exercises and controls, by signal, operation of the target.

(3) *Gun commanders.*—Supervise the work in each tank; relay orders from the platoon sergeant to the crew. Signal the platoon sergeant "Ready" when the gun in their tank is ready to engage the target.

(4) *One assistant instructor.*—Timekeeper. Starts target on signal from platoon sergeant and regulates time of exposure in accordance with his orders. Specifies to men operating drum the time of exposure of the target for each run. At intervals, as an aid to regulating the target speed, calls out the time consumed as the target travels across the course.

(5) *Two drum operators.*—Operate the drum so that the



target will be exposed as nearly as possible for the time specified by the assistant instructor, (4) above. Regulate the speed at which they turn the drum so as to obtain a uniform rate of travel for the target throughout its entire course.

(6) *Coaches*.—At the guns. Conduct individual instruction, check execution of the exercises by the gunners.

(7) *Gunners*.—Execute the exercises at the guns. The loaders, who operate the breech when firing is simulated, assist in coaching as directed by the tank commander.

(8) *Remainder of platoon*.—Held well clear of the tanks, arranged numerically, ready to move forward to take their turn at the guns when so directed.

*e. Leads*.—(1) *Lead table*.—Mathematical computation, or the use of a voluminous lead table to obtain the exact lead to be used on a moving target, is impracticable in combat. The simple lead table shown below gives the amount of lead necessary to hit a target moving at right angles, 90°, to the direction of fire at the speed indicated.

Miles per hour	-----	7½	15	30
Leads	-----	1	2	4

(a) For ease in remembering the table, memorize the leads required for 15 miles per hour; those required for 7½ and 30 miles per hour and one-half and double the amount required for 15 miles per hour.

(b) The angle at which the target is moving will alter the amount of lead to be taken; that is, if the angle between the line of fire and the line of travel of the target is less than 45°, use one-half the lead shown in the table.

(c) For targets moving directly toward or away from the gun, no lead is taken.

(d) When firing from moving tanks at stationary targets, rear leads are taken in accordance with the speed of the tank. When firing from moving tanks at moving targets the difference in speed of each is used in estimating the number of leads.

(e) It is contemplated that the lead table will furnish the amount of lead to be used for the first round; necessary corrections thereafter should be based upon observation of strike or tracer. *Too much lead is better than too little* because the target runs into the fire and because the observation of strike is easier. *The intelligent use of the lead table includes the*

*immediate application of fire with the estimated lead followed by the necessary corrections based upon observation of strike or tracer.* The gunner must make corrections as the conditions change.

(2) *Lead exercises (1,000-inch).*—(a) The gunner is required to take a position at the gun, swing the gun through the announced target silhouette on the 1,000-inch antitank target, and aim at a point ahead of the target equal to the prescribed lead (fig. 25).

(b) He then directs an assistant to move the marking silhouette (fig. 26) until the forward edge is at the point of aim (fig. 27).

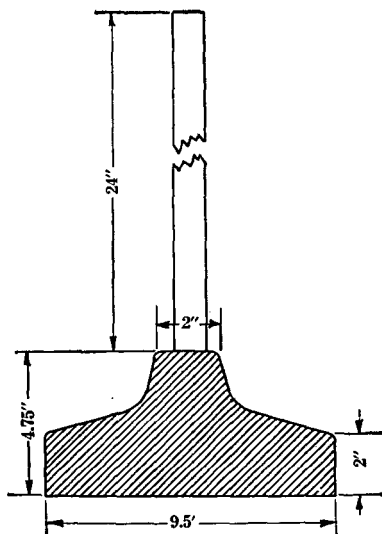

FIGURE 26.—Marking silhouette.

(c) The assistant then places a pencil dot at this point. The exercise is repeated, making triangles by marking the points at the forward edge of the marking silhouette for each adjustment until the gunner can make at least two out of three triangles which can be inclosed in a circle 1 inch in diameter.

(d) This exercise should be conducted for varying right and left leads.

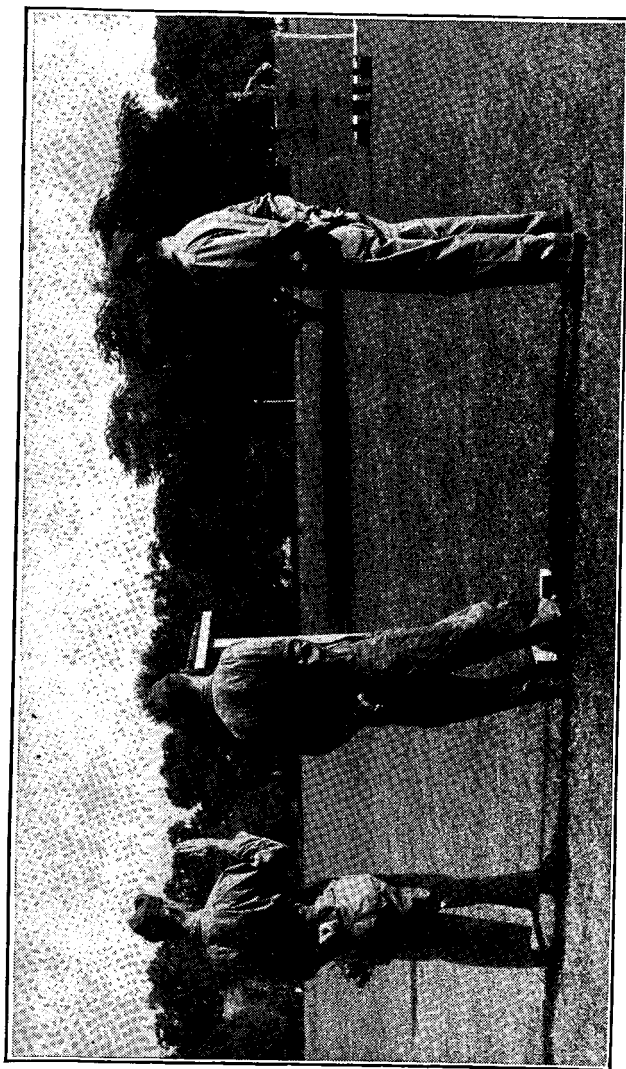

FIGURE 27.—Group executing lead exercise (with telescopic sight M5A1).

*f. Tracking.*—(1) *General.*—Tracking consists of maintaining the correct alinement of the sights (with or without a lead) on a moving target by moving the gun at the same angular speed as that of the target.

(2) *Tracking exercise.*—(a) The gunner is required to aim at a prescribed point (leading edge) on the silhouette target and to maintain that aim during the uniform movement of the target. As instruction progresses, the speeds used should differ for successive runs of the target, and finally the target should be moved at erratic speeds.

(b) The approximate speeds at which 1,000-inch moving targets should be run to represent speeds at various ranges are shown in the following table.

TARGET SPEEDS, 1,000-INCH MOVING TARGETS

Target speeds in m. p. h.	Target speeds in inches per second corresponding to—					
	300 yds.	500 yds.	600 yds.	800 yds.	900 yds.	1,200 yds.
7½.....	12	7	6	5	4	3
10.....	16	-----	8	-----	5	4
15.....	24	15	12	10	8	6
20.....	33	-----	16	-----	11	8
30.....	49	30	24	21	16	12

The time of exposure of a target for a particular run may be determined by dividing the distance to be traveled in inches by the target speed in inches per second shown in the table. Thus, if it is desired to determine how long a target should take to traverse the 500 inches between screens on the 1,000-inch moving target range, so that its speed will correspond to the speed of a target traveling at 30 miles per hour at a range of 600 yards, divide 500 inches by 24 inches per second; the target should be exposed for 21 seconds.

(c) Initially, in conducting the tracking exercises, the slower speeds should be used, as instruction progresses, the speeds used for successive runs of the targets should be varied and increased and finally the target should be moved at erratic speeds.

(d) Prior to starting the tracking exercises, the instructor should explain how the range and targets on the 1,000-

inch moving target range are operated and the speeds at which 1,000-inch targets should be run.

*g. Combined leading and tracking exercises.*—After the gunner has gained facility in tracking the target, he is required to repeat the tracking exercise while using a designated lead and to simulate firing when his sight is properly alined.

(1) *First exercise.*—(a) *Purpose.*—This exercise has for its purpose the development of the gunner's skill in tracking and operating the firing mechanism when engaging a target moving directly across the front of the gun and over comparatively level ground. Throughout the exercise, emphasis should be placed on the importance of smooth manipulation of the gun and keeping the gun moving through the same angular speed as the target while simulating fire.

(b) *Procedure.*

1. The exercise is conducted on the parallel-level course of the 1,000-inch moving target range (par. 95). The gunner executing the exercise, and the loader who acts as coach when so directed, take position at each gun. When all are ready the target is operated, the sequence of commands and procedure being similar to that described in paragraph 88. No commands for loading are given. An example of the sequence of command is, ALL GUNS; when all guns have been alerted and are ready, the command LEFT FRONT, TANK, 600, ZERO LEAD, TRACK is given.
2. At the command LEFT FRONT, the gunner traverses to the left and as the target comes into view he aims with the announced range and lead on the forward end of the aiming silhouette, as previously instructed and tracks the target. As soon as the target is obscured from view by the screen, and without further command, it is immediately set in motion in the opposite direction. As the target reappears, the gunner relays on the aiming silhouette and tracks, using the same range and lead but shifting to the opposite end of the aiming silhouette to correspond to the new direction of travel of the target.

3. The passage of the target across the course once is known as a "run." A "double run" is a passage of the target over the course once in each direction. The exercise is continued until two double runs are completed and then the next relay takes position. *Frequent changes of gunners and coaches are advisable to avoid monotony.*
4. While the gunner is executing the exercise, the gun instructor or the loader will observe. A check is made on the correctness of the point of aim, whether or not the correct range and lead are used, and on the accuracy and smoothness of tracking. Errors detected should be called immediately to the gunner's attention. Throughout the travel of the target, the gunner should remain correctly and continuously laid on the aiming silhouette.
5. As soon as the gunner develops some degree of facility in tracking, he is required to simulate firing four or five rounds during each run of the target. To accomplish this, the order issued for the exercise is modified thus, ALL GUNS, SIMULATE FIRE, FIVE ROUNDS EACH RUN; then when all are ready, LEFT FRONT, TANK, 800, ZERO LEAD, COMMENCE FIRING. The gunner engages the aiming silhouette as before but adds the operation of simulating fire by pressing on either trigger actuator and actuating the firing mechanism. After each firing operation, the loader opens the breechblock and simulates loading. The gunner disturbs his aim on the target as little as possible by the added operation of firing. The instructor checks the gunner's tracking and firing operations; he must develop in the gunner an ability to track and manipulate the trigger actuator simultaneously. Accurate and continuous tracking while firing requires great skill and coordination; *beginners have a tendency to cease tracking whenever they push the trigger plunger; this can be overcome only by a great deal of practice and careful instruction.*
6. The exercise begins with the target operated at the slow speeds; only ranges and leads for which

specific aiming pictures are known are designated. As the instruction progresses, the target speed is increased and varied range and lead combinations are used. To be proficient, the gunner should be able to track and simulate fire on a target moving at a speed representing 30 miles per hour at any range and lead.

(2) *Second exercise.*—(a) *Purpose.*—The purpose of this exercise is to develop skill in tracking and simulating fire on a target moving over undulating ground directly across the front of the gun position.

(b) *Procedure.*—The exercise is conducted on the parallel-hilly course of the 1,000-inch moving target range (par. 95). The procedure is the same as that described in (1) above.

(3) *Third exercise.*—(a) *Purpose.*—The purpose of this exercise is to develop skill in tracking and simulating fire on a target approaching and receding from the gun position at an angle and traveling over undulating ground.

(b) *Procedure.*—The exercise is conducted on the oblique course of the 1,000-inch moving target range (par. 95). The procedure is the same as that described in (1) above.

(4) *Fourth exercise.*—(a) *Purpose.*—This exercise is a modification of the three preceding exercises. Its purpose is to develop the gunner's skill to track and simulate fire on successive targets; it visualizes a situation where the gunner must engage several tanks in rapid succession.

(b) *Procedure.*—All the courses of the 1,000-inch moving target range may be used. The sled is equipped with the multiple track tank target (par. 93b). The commands for conducting the exercise are modified so as to indicate which aiming silhouette the gunner is to engage initially, thus, \* \* \*; LEFT FRONT, CENTER, TANK, 600, ONE LEAD, TRACK OF COMMENCE FIRING, if firing is to be simulated. When the target appears, the gunner engages the center tank. During the progress of the target over the course the command to change aiming silhouettes is given thus, TOP RIGHT TANK, OF LOWER LEFT TANK, etc. At this command, the gunner ceases tracking the center tank and engages the newly designated tank. Initially only one or two changes in aiming tanks are ordered during a run of the target; as the men develop skill in manipulation,

three or four changes can be made. Changes in the speed of the target and in range and lead may also be made if desired. All the gunner's work should be carefully observed and criticized by the gun commander.

■ 75. RECORD OF PROGRESS.—A record of progress covering the work of each man undergoing instruction in preparatory range training is maintained throughout the course of instruction. The purpose of this record is to keep a current account of each man's progress so that no man will be permitted to start firing instruction on the 1,000-inch and field firing moving target range until he has become proficient in the execution of all the aiming and tracking exercises.

### SECTION III

#### PRELIMINARY GUNNER'S EXAMINATION

■ 76. EXAMINATION.—Prior to current record firing practice, each individual will be examined to determine his proficiency in mechanical training, elementary training for placing the gun in action, and service of the piece and practical ability to execute satisfactorily the aiming and tracking exercises prescribed in paragraphs 73 and 74.

*a. Scope.*—The examination will consist of a practical demonstration by the candidate of his understanding and ability to perform satisfactorily specific tests in each phase and exercise. The extensiveness of the examination and the standard of excellence demanded of the candidate are the responsibility of the organization commander concerned.

*b. Conduct.*—(1) The examination will be conducted by an officer or qualified noncommissioned officer.

(2) Company or similar unit commanders will determine the detailed procedure and time of the examination. They are responsible that all men in their organization satisfactorily complete the examination within a period of 6 months prior to the time they fire any part of the qualification course.

*c. Record.*—A record of the date of the satisfactory completion of the examination in preliminary marksmanship will be entered on each individual's score card prior to initiating record firing practice.



## SECTION IV

## RANGE PRACTICE, INCLUDING QUALIFICATION COURSES

■ 77. GENERAL.—*a.* Each man of units equipped with the 37-mm tank gun, M5 (mounted in tanks), will fire one of the courses given below for qualification. The course to be fired will be designated by higher headquarters. Ammunition allowances and qualification scores are prescribed in AR 775-10; records and reports, in AR 345-1000; compensation, in AR 35-2380.

*b.* (1) Prior to any firing with the 37-mm tank gun, M5 (mounted in tanks), all men to fire will have completed (within the preceding 3 months) marksmanship firing with the caliber .30 machine gun (mounted in tanks), as prescribed in FM 23-50.

(2) Prior to firing on the 1,000-inch range, all men will complete a thorough course in preparatory marksmanship training. Before firing record practice, each man must satisfactorily pass an examination as prescribed in paragraph 76.

*c.* Rules governing the firing of qualification courses for record practice are prescribed in paragraph 89.

*d.* Pending the complete development of any other sub-caliber devices and weapons, for all firing prescribed in this section to be conducted on the 1,000-inch target range, the caliber .22—.30, subcaliber mount, M7A1, bearing the caliber .22, subcaliber rifle, M2A1, as issued by the Ordnance Department without modification, will be used. The range will be constructed as prescribed in paragraphs 95 and 97. The targets used will be targets *A* and *B* as prescribed in paragraph 94.

*e.* All firing will be executed with an assumed range of 400 yards and all leads will be taken accordingly.

■ 78. COURSE A.—Ranges: as indicated under each table, Targets: for tables I, II, and III, target *A*; for table IV, target *B*.

*a.* *Instruction practice.*—(Fire tables I, II, III, and IV three times.)

NOTE.—Instruction and record practice firing of tables I, II, and III will be completed before proceeding to table IV.

TABLE I.—PARALLEL-LEVEL COURSE (STATIONARY TANK—MOVING TARGET)

Range	No. of rounds	Speed, inches per second	Seconds to traverse course	Lead	Direction of movement of target
1,000-inch.....	5	12	41	0	L to R.
Do.....	5	12	41	0	R to L.
Do.....	5	16	31	1	L to R.
Do.....	5	16	31	1	R to L.
Do.....	5	24	21	2	L to R.
Do.....	5	21	21	2	R to L.

TABLE II.—PARALLEL-HILLY COURSE (STATIONARY TANK—MOVING TARGET)

Range	No. of rounds	Speed, inches per second	Seconds to traverse course	Lead	Direction of movement of target
1,000-inch.....	5	12	41	0	L to R.
Do.....	5	12	41	0	R to L.
Do.....	5	16	31	1	L to R.
Do.....	5	16	31	1	R to L.
Do.....	5	24	21	2	L to R.
Do.....	5	24	21	2	R to L.

TABLE III.—OBLIQUE COURSE (STATIONARY TANK—MOVING TARGET)

Range	No. of rounds	Speed, inches per second	Seconds to traverse course	Lead	Direction of movement of target
1,000-inch.....	5	16	42	0	L to R.
Do.....	5	16	42	0	R to L.
Do.....	5	24	28	0	L to R.
Do.....	5	24	28	0	R to L.

TABLE IV<sup>1</sup>  
(STATIONARY TANK—MOVING TARGET ON FIELD RANGE)

Range	No. of rounds	Speed	Lead	Direction of movement of target
Field range (not less than 400 yards).	<sup>2</sup> 10	Uniform speed of approximately 15 m. p. h.	As necessary.	L to R and back to L (or reverse). Exposed 15 seconds each direction.

<sup>1</sup> For firing this table 37-mm shot, fixed, TP, M51, with tracer for 37-mm guns, M3 and M5 will be used.

<sup>2</sup> Instruction practice will consist of firing five rounds.

*b. Record practice.*—Fire tables I, II, III, and IV of course A, once, under prescribed record firing conditions. (See note under *a* above.)

■ 79. COURSE B.—Range: 1,000 inches. Targets: target A.

*a. Instruction practice.*—(Fire tables V, VI, and VII three times.)

TABLE V.—PARALLEL-LEVEL COURSE  
(STATIONARY TANK—MOVING TARGET)

No. of rounds	Speed, inches per second	Seconds to traverse course	Lead	Direction of movement of target
5.....	12	41	0	L to R.
5.....	12	41	0	R to L.
5.....	16	31	1	L to R.
5.....	16	31	1	R to L.

TABLE VI.—PARALLEL-HILLY COURSE  
(STATIONARY TANK—MOVING TARGET)

No. of rounds	Speed, inches per second	Seconds to traverse course	Lead	Direction of movement of target
5.....	12	41	0	L to R.
5.....	12	41	0	R to L.
5.....	16	31	1	L to R.
5.....	16	31	1	R to L.

TABLE VII.—OBLIQUE COURSE  
(STATIONARY TANK—MOVING TARGET)

No. of rounds	Speed, inches per second	Seconds to traverse course	Lead	Direction of move- ment of target
5.....	16	42	0	L to R.
5.....	16	42	0	R to L.
5.....	24	28	0	L to R.
5.....	24	28	0	R to L.

*b. Record practice.*—Fire tables V, VI, and VII of course B, once, under prescribed record firing conditions.

■ 80. COURSE C.—Range: 1,000 inches. Target: target A.

*a. Instruction practice.*—(Fire tables VIII, IX, and X three times.)

TABLE VIII.—PARALLEL-LEVEL COURSE  
(STATIONARY TANK—MOVING TARGET)

No. of rounds	Speed, inches per second	Seconds to traverse course	Lead	Direction of move- ment of target
5.....	16	31	1	L to R.
5.....	16	31	1	R to L.

TABLE IX.—PARALLEL-HILLY COURSE  
(STATIONARY TANK—MOVING TARGET)

No. of rounds	Speed, inches per second	Seconds to traverse course	Lead	Direction of move- ment of target
5.....	16	31	1	L to R.
5.....	16	31	1	R to L.

TABLE X.—OBLIQUE COURSE  
(STATIONARY TANK—MOVING TARGET)

No. of rounds	Speed, inches per second	Seconds to traverse course	Lead	Direction of movement of target
5.....	16	42	0	L to R.
5.....	16	42	0	R to L.

*b. Record practice.*—Fire tables VIII, IX, and X of course C, once, under prescribed record firing conditions.

### SECTION V

#### CONDUCT OF RANGE PRACTICE, INCLUDING RECORD PRACTICE AND INDIVIDUAL SAFETY PRECAUTIONS

■ 81. **GENERAL.**—This section prescribes the rules and regulations governing range practice in order to secure uniformity throughout the service.

■ 82. **DUTIES OF PERSONNEL.**—*a. Officer in charge.*—The officer in charge of range practice, detailed by the unit commander, is responsible for—

(1) Assignment, coordination, and supervision of ranges and firing areas.

(2) Timely arrangements with the range officer for repairs or alterations of installations.

(3) Procurement of supplies for firing units.

(4) Enforcement, by firing units, of safety precautions prescribed herein, in AR 750-10, and by the local commander.

(5) For interpretation of such parts of this manual as may be referred to him for decision.

*b. Range officer.*—The range officer is normally a member of the unit or post commander's staff. He is responsible for—

(1) Procurement and distribution of range supplies.

(2) Supervision of construction, alteration, or repair of range installations.

(3) Establishment of safety limits of ranges and coordination of firing to comply with the provisions of AR 750-10.

*c. Company commander.*—(1) The company commander is responsible for the efficiency of the marksmanship training of

his organization and the conduct of its firing in accordance with the provisions of this manual.

(2) During 1,000-inch target firing he, or his commissioned representative, will personally supervise and control all firing by one of the following methods—

(a) Give the commands **COMMENCE FIRING** and **CEASE FIRING** for each order.

(b) Give the command **COMMENCE FIRING**, then permit tanks to fire individually, observing the safety precautions prescribed in paragraph 53, until he gives the command **CEASE FIRING**.

(3) During moving target firing, he or his commissioned representative will control the firing and the movement of the target(s) by appropriate fire orders and signals. A typical order would be: **LOAD. 1. RANGE 600, RIGHT ONE LEAD, TARGET NO. 1, 2. COMMENCE FIRING.**

(4) During all firing, he or his commissioned representative will rigidly enforce local range regulations, safety precautions as prescribed in section VI, and instructions pertaining to the service of the piece contained in paragraph 61.

*d. Scoring officers.*—(1) Scoring officers will be detailed to supervise record firing practice. Officers for this duty will be detailed from organizations other than the one firing. They will familiarize themselves thoroughly with their duties and firing procedure on the 1,000-inch and field firing ranges prior to the date of commencement of record firing practice. The number of scoring officers detailed during record firing practice will not be less than one for each four tanks firing (or for each 1,000-inch range unit being operated in the case of 1,000-inch moving targets). An assistant to the scoring officer will be present in each tank during the firing.

(2) Specific duties of the scoring officers are to—

(a) Inspect loaded magazines and count number of rounds of ammunition to be fired by the gunner for each score exercise. (This may be delegated to the assistant scorer.)

(b) Check dimensions of the targets, aiming silhouettes, and scoring spaces, and see that the range is laid out as prescribed.

(c) See that firing is conducted in accordance with the prescribed procedure.

(d) Verify and render decisions on all misfires, stoppages, and malfunctions at the guns.

(e) Render a decision in event of breakage or stoppages in any of the range apparatus or mechanism.

(f) Inspect each target before it is placed on the sled. Make sure that initially it contains no shot holes and that after being fired on, it has no unpasted shot holes before the start of another score.

(g) Count the number of shot holes in appropriate scoring space for each score fired, score target(s), and record the score.

(h) Check time of exposure of target on each run and render a decision in event of irregularities. (See par. 89.)

(3) Additional specific duties of assistants to the scoring officers are to—

(a) Count ammunition when so directed.

(b) Relay commands to gun crew.

(c) During moving target firing, give the commands or signals for COMMENCE FIRING and CEASE FIRING when target enters and leaves the zone for firing.

(d) See that gunner executes firing in accordance with prescribed procedure.

(e) Report all stoppages and discrepancies to scoring officer for decision.

(f) See that gun is properly cleared at completion of firing.

*e. Coaches.*—(1) *General.*—(a) *During instruction firing.*—Efficient instruction is the foundation of successful firing. The proficiency attained by each man will be in direct ratio to the manner in which each coach performs his duties. During all preparatory training and instruction firing, there will be a coach at each firing gun (tank). It is his task to see that the gun crew executes all operations in accordance with the prescribed procedure. His main mission is to detect errors and cause the gun crew to correct them.

(b) *During record firing practice.*—*The gunner will not be coached or instructed in any way. Coaches will not be allowed at or near the guns.*

(2) *Specific duties of the coach are to*—(a) Require each man functioning at his gun to observe all pertinent individual and general safety precautions as prescribed in paragraph 83, and see that the instructions pertaining to the service of the piece contained in chapter 2 are complied with.

(b) See that the proper amount of ammunition is at the

gun and that magazines are loaded with the specified number of rounds for each exercise.

(c) Supervise generally the work at the gun, making sure that the commands LOAD, COMMENCE FIRING, CEASE FIRING, UNLOAD, and CLEAR GUN are properly executed. He will repeat orders or instructions when necessary to insure correct understanding and timely execution by the gunner and loader.

(d) See that the gunner executes the firing exercises in accordance with prescribed procedure.

(e) Report all misfires, stoppages, malfunctions, or discrepancies to the officer conducting firing.

(f) Score the target when directed and discuss and criticize the execution of the exercise (during instruction practice only) with the gunner.

*f. Gunner.*—The gunner will fire the prescribed tables in accordance with the procedure given in paragraph 88.

*g. Loader.*—(1) *General.*—The primary duty of the loader is to serve the piece in that capacity during all firing exercises. During instruction practice he may also perform additional duties at the gun or act as an assistant coach in accordance with orders of the coach. *During record firing practice, he performs only the specific duties of loader hereinafter prescribed; he does not coach or instruct the gunner in any way.*

(2) *Specific duties of the loader are to—*(a) Secure and have ready for use at the gun the prescribed number of magazines properly loaded for each exercise.

(b) Serve the piece as loader as prescribed in chapter 2. In this connection he will—

1. Load the piece, or subcaliber rifle, in accordance with the commands of the officer conducting the firing.
2. When the piece, or rifle, is loaded and ready to fire, report "Up" to the gunner, and when the gunner is ready to begin the exercise, signal "Ready" to the officer conducting firing.
3. Repeat all orders to unload, cease and suspend firing, and clear gun, and see that the orders are complied with as described in chapter 2.
4. Announce for the gunner's benefit when the prescribed number of rounds for each run of the target have been fired, thus, "Five rounds complete."



(c) Report all misfires and malfunctions or stoppages to the coach (or to the scoring officer during record firing practice). During instruction firing, in case of a misfire immediately recock the rifle without command by raising the bolt handle, and endeavor to render the gun ready for firing as quickly as practicable. In case of a minor malfunction or stoppage, such as failure to feed another round into the chamber when the bolt is operated or failure to extract, etc., remedy the condition without command as quickly as practicable. In case of a misfire, stoppage, or minor malfunction during record firing practice, proceed as described in paragraph 90.

(d) Without command, reload the gun upon the completion of a run of the target as prescribed in paragraph 88d(8).

■ 83. SAFETY PRECAUTIONS.—*a. Responsibility.*—The responsibility and duties of individuals incident to the observation and enforcement of safety precautions are given in paragraph 82.

*b. Ranges.*—The specifications for laying out ranges to comply with safety requirements for the various types of firing are given in AR 750-10.

*c. General and individual safety precautions.*—The safety measures to be observed while firing ammunition in peacetime are laid down in AR 750-10; however, the following precautions are given for emphasis—

(1) Danger flags will be displayed at prominent positions on the range during all firing.

(2) Such range guards as may be needed will be posted.

(3) During moving target firing, conspicuous markers will be placed to indicate the right and left safety limits of the range. All concerned will be instructed in the significance of these markers.

(4) Firing on any range will not commence until it has been determined that the range is clear and that the officer in charge of firing has given his authority to fire.

(5) No firing will be done except under the direct supervision of an officer.

(6) No gun will be loaded until a command to do so has been given.

(7) No person will be allowed in front of a tank for any purpose until so directed by an officer or noncommissioned

officer, who has ascertained that all guns of the tank are cleared.

(8) No gun (tank) will be removed from the firing point where it has been firing until an officer has inspected the guns to see that they are unloaded. As part of this inspection, the breech of the gun or subcaliber rifle will be examined as prescribed in paragraph 51, and prior to closing the breech or bolt, the finger will be inserted in the chamber to make sure that it is empty.

(9) A scarlet flag will be displayed on each tank from which firing is being conducted. This flag will not be removed until all guns in the tank concerned have been cleared.

(10) Decision as to whether it will be necessary to have flank tanks clear guns to permit adjacent tanks to change targets will be made by the officer in charge of range practice.

(11) No personnel except the driver will enter or leave the tank from the front.

■ 84. GUNS, MOUNTS, AND TELESCOPES.—*a.* The gun, mount, telescope, and subcaliber .22 rifle will be used as issued by the Ordnance Department without addition or modification, except as specifically authorized hereafter. A shade (where not provided on the mount shield) may be used to protect the front lens of the telescope from sun glare. During 1,000-inch firing, range reflectors or tunnels may be used. The sling seat or other standard equipment issued for the support of the gunner and loader is authorized. No other improvised supports for the gun or gun crew members will be employed during record firing.

*b.* (1) Before marksmanship firing is begun, each gun, mount, telescope, and accessories to be used will be thoroughly examined and repaired or adjusted to insure their efficient functioning. Excessive play will be removed from the guns and mounts and adjustments made to permit smooth manipulation.

(2) Prior to firing, the alinement of the telescope on each gun will be verified and, if necessary, adjusted as described in paragraph 28*c*; this being done, each gun will be carefully bore sighted as prescribed in paragraph 28*d*. The telescope with which the gun is to be equipped during marksmanship firing will be used for bore sighting. The location of the offset scoring spaces on target A used on the

1,000-inch range is based on an accurately bore sighted gun, therefore the accuracy of the bore sighting operation is of particular importance.

■ 85. **TARGETING.**—Guns will be targeted or retargeted as directed by the officer conducting the firing, except that during the firing of a record practice exercise the gun will not be retargeted before the exercise is completed. In event of a stoppage during record practice, the reduction of which requires that the gun be retargeted, the officer in charge of range practice will render the decision as to whether the exercise will be continued or refired. The gun will not be targeted on the same target upon which a record score is being fired.

■ 86. **AMMUNITION.**—Ammunition in the amounts shown in the tables for each score will be loaded in magazines (caliber .22) and inspected before firing.

■ 87. **TARGETS.**—The target used, its course of movement, and its speed will be as prescribed for the particular table being fired. For a complete description of targets, see section VI. If prepared locally, the outlines of the scoring spaces (1,000-inch targets) will be drawn so that the lines are not visible from the gun position. The targets used for the 1,000-inch firing may be placed on frames, racks, or carriages to elevate them to the height of the gun or to facilitate handling. The targets will be installed, engaged, and operated as described in section VI.

■ 88. **PROCEDURE FOR FIRING.**—*a. General.*—(1) All firing will be controlled by definite fire orders.

(2) During the initial phases of instruction firing the officer conducting firing may at his discretion reduce the speed, targets, and the number of rounds fired from those prescribed in the tables. The object of this procedure is to place emphasis initially upon smooth continuous tracking.

(3) A run of the target across the course once in each direction at the same speed will constitute a single score and is known as a "double run." A double run constitutes an exercise.

(4) Scores are fired in the order in which exercises are listed in the tables.

(5) Each table can be completed on one target.

(6) During instruction firing only, when time is available, the firing of each table may be preceded by one or more dry runs.

*b. Organization.*—For functional purposes, an organization similar to that described in preparatory marksmanship training (par. 74*d*) is suggested. The organization must be modified to meet the requirements of firing live ammunition. During instruction firing only two guns (tanks) can fire on each range unit.

*c. Duties.*—All personnel will perform the duties prescribed in paragraph 82. During instruction firing, a coach, gunner, and a loader will be at each gun. A fourth man may be assigned the duty of loading magazines and furnishing them to the loader. A line of small loading benches placed a short distance in rear of the tanks will facilitate loading and assure a prompt supply of ammunition to the guns. Other members may be employed in operating the range and preparing targets for firing.

*d. Instruction firing.*—Before firing on either the 1,000-inch or field firing range, the officer conducting firing will give a general description of the range and announce specific instructions pertaining to firing procedure.

(1) When firing at 1,000-inch moving targets two tanks are placed on the firing line to the right and left of the center stake (par. 95*g*) and as close together as possible *with the base of the front sloping plate of turrets 998 inches from the targets for the parallel-level course*. Another gun may be added for dry shooting if desired. They are numbered from left to right.

(2) No 1 gun is assigned the top aiming silhouette target(s) No. 2, gun the lower aiming silhouette target(s).

(3) The coach, gunner, and loader take position at the gun. The gunner tests the firing, elevating, and traversing mechanisms. The loader secures the necessary ammunition.

(4) When directed to do so by the coach or assistant scorer, the gunner will fire his sighting shots.

(5) When the sighting shots have been fired, the coach or assistant scorer, all safety precautions having been previously taken, gives or relays the fire order.

(6) An example of the sequence of a fire order is as follows:

(a) TWO CLIPS, FIVE ROUNDS EACH. LOAD. At

these commands the gunner points his gun in the direction from which he expects the target to appear and the loader reports "Up" when loaded and ready to fire. When the gunner is ready to begin the exercise, he so indicates to the loader who signals READY.

(b) In the meantime the individual conducting firing will have specified to the timekeeper at the drum the course to be traveled by the target and the time of exposure for the run (firing tables, pars. 78, 79, and 80).

(c) When all guns have signaled ready, the individual conducting firing will give a signal to start the target and simultaneously order: 1. LEFT (RIGHT) FRONT, RANGE 600, ZERO (ONE, TWO) LEAD(S), TARGET NO. 1 (2); 2. COMMENCE FIRING.

(7) As the phase, LEFT (RIGHT) FRONT of the fire order is given, the gunner will start traversing toward the left (right) of the range. Upon its appearance from behind the screen, he will engage the target, using the announced lead and firing the number of rounds contained in the magazine. For training purposes, the gunners will be required to track the target during its entire time of exposure, even though they have fired the required number of rounds for the run.

(8) When the target is obscured behind the screen and prior to its return run the loader will, without command, rapidly remove the used magazine and all unfired rounds remaining in the rifle, and reload with the second magazine provided for the return run of the exercise. As soon as this operation is complete, he will signal READY to the officer conducting firing.

(9) Immediately upon indication that all guns are ready and without further oral orders, the officer conducting firing will cause the target to be started upon its return run. The gunner engages the target as indicated in (6) above, completing his score. While the target is obscured between runs of a score the gunner will continue to aim at the place where the target disappeared, prepared to reengage it the instant it reappears.

(10) Upon the completion of a score, guns are cleared, targets are brought to the gun positions and the results recorded, analyzed, and discussed.

(11) Upon orders from the officer conducting firing, targets will be replaced.

(12) Thereafter firing is continued and for each score (exercise) fired the procedure described in (3) to (11) above will be followed. Upon completion of the firing of each table, a new order is started.

■ 89. RULES AND PROCEDURE FOR RECORD FIRING PRACTICE.—*a.* Record firing practice will consist of firing one of the courses prescribed in section IV. Except as hereinafter specifically stated, or as specifically modified therein, the rules for conducting instruction firing practice as set forth in section IV and paragraphs 82 to 88, inclusive, will apply to record practice as well.

*b.* Each man will complete the prescribed instruction firing for the course specified prior to firing record practice.

*c.* No individual will be permitted to fire record practice unless his individual score card shows an entry initialed by his organization commander that he has satisfactorily completed the examination prescribed in paragraph 76.

*d.* Once record practice of an individual has commenced, it will be completed without interruption by any other form of firing.

*e.* As a rule, record firing practice will not be fired by any candidate on the same day that he fires any part of instruction firing practice. However, when the time allotted to range practice is very limited, the officer in charge of range practice may authorize record firing on the same day.

*f.* No organization (company or platoon) will conduct instruction firing and record firing practice simultaneously on the same 1,000-inch moving target range unit.

*g.* Before firing any exercise for record, the gunner will be required, and will be given a reasonable time, to check the condition of his gun, telescope, and ammunition.

*h.* For record firing practice, only one gun (tank) will fire on each 1,000-inch moving target range unit at a time. The tank will be placed so that the pintle of the gun is in the center of the range and 1,000 inches from the target of the parallel runway. (998 inches measured from the base of the front sloping plate of the turret will give the required measurement.) No improvised supports for the gun or gunner will be employed during firing.

*i.* A gunner and loader only will be at each gun during record firing. The presence of any other individual except

the scoring officer at or near the gun while a soldier is firing or preparing to fire record practice is prohibited. During this firing, the gunner must perform all of the operations required in firing, such as laying the gun, manipulation, and firing, without any coaching or assistance whatsoever. The duties of the loader during this firing are specified in paragraphs 82*g* and 88.

*j.* Each gunner will complete one table of the prescribed qualification course during one order at the gun.

*k.* The target speed for any run will not be announced to the gunner.

*l.* The speed of the target and its time of exposure for each run are specified in section IV. The decision to disregard a score because of a failure to comply with the specified times or because of faulty operation of the target rests with the scoring officer. He will require that the target be operated in such a manner that it will traverse the prescribed course for each run at a relatively uniform rate of speed throughout its entire time of exposure. A variance of 3 seconds under or over the prescribed time for any run will be permitted. If the time of exposure exceeds the prescribed time by more than 3 seconds, the score will be disregarded. If the time of exposure is less than the prescribed time by more than 3 seconds, the gunner will be required to state whether or not he wants the score to stand before he examines the target. If he chooses to fire the exercise again he will be permitted to do so, otherwise the score will be recorded as fired.

*m.* The runs of an exercise will be fired in as rapid succession as possible. When the target disappears behind the screen at the end of the first run of an exercise, the loader will be required to load the gun for the return run as rapidly as practicable and signal **READY** as soon as the gun is ready for firing. Without further orders to the gunner and within 5 seconds after the loader(s) has signaled **READY**, the target will be started on its return run.

■ 90. **STOPPAGES.**—*a.* In record firing practice when a misfire, stoppage, or malfunction occurs, the gunner or loader will hold up his hand and call "Stoppage." Thereafter neither the gunner nor loader will touch the gun until so instructed by the scoring officer. A scoring officer will examine the gun.

*b.* If a misfire, stoppage, or malfunction exists which was

not the fault of the gunner, the score will be disregarded and the gunner will be permitted to refire the exercise.

c. If the misfire, stoppage, or malfunction is manifestly the fault of the gunner due to incorrect manipulation of the gun, the gunner will not be permitted to refire the exercise. Only that part of the exercise which was completed will be scored.

d. Should a breakage occur, the gun or subcaliber rifle will be repaired or a different gun (tank) or subcaliber rifle substituted and the exercise refired. Substituted guns which have been repaired may be re-boresighted when the scoring officer considers it to be justified.

■ 91. SCORING.—*a. General.*—Any departure from the mandatory provisions of this manual will disqualify the man affected for qualification.

(1) After a man has taken his place at the gun, all shots fired by him will count as a part of that exercise.

(2) Failure to use the prescribed aiming silhouette for an exercise or any part thereof will result in hits in the wrong horizontal row of scoring spaces. The gunner who places his hits in the wrong row of scoring spaces will not be permitted to refire the exercise and will be scored only those hits which are found in the appropriate space for the designated aiming silhouette.

(3) A hit will be scored for each bullet hole found in the correct scoring space, except that no more hits will be counted in any scoring space(s) than the number of rounds (10) authorized to be fired for the exercise (when a single scoring space is used for an exercise) or for a run (5) (when a separate scoring space is used for each run of an exercise).

(4) The shot holes in the target will be counted. If the number of holes exceeds the amount of ammunition authorized for the exercise, the gunner will be penalized five points for each round in excess of the allowance.

(5) During record firing, the name of the individual will be placed beside the row of scoring spaces he is to use for a table before he fires on it. No person will handle the target until after it is scored except under the direct supervision of the scoring officer or his assistant.

(6) A bullet hole which touches the line of a scoring space will be counted as a hit. (The paper having been broken into a scoring line does not necessarily mean a hit.)



(7) Ammunition not fired during the time of exposure of the target for each run of an exercise will be forfeited.

(8) Holes which obviously have been made by ricocheting bullets will be counted as hits. Holes made by rocks or other foreign matter will not be counted.

(9) After the score has been recorded for each exercise, all holes in the target will be crossed with a pencil mark and covered with a paster.

*b. Computation of scores.*—(1) Subject to the conditions specified in *a* above, a total of five points will be counted for each hit in a correct scoring space at 1,000 inches and for each hit on the moving target at field range (table IV).

(2) The following indicates the total possible score for the three authorized courses:

	Table I	Table II	Table III	Table IV	Total possible
Course A.....	150	150	100	50	450
	Table V	Table VI	Table VII		Total possible
Course B.....	100	100	100	-----	300
	Table VIII	Table IX	Table X		Total possible
Course C.....	50	50	50	-----	150

*c. Score cards.*—A score card will be kept for each person firing. This card will show the scores made during record firing practice. Each individual entry for record practice will be made in ink or indelible pencil and will be authenticated by the scoring officer. Erasures are not permitted. Alterations will be made only by the company commander or the officer who acted as scorer. Such corrections will be authenticated by the officer making the correction. Date of completion of the examination prescribed in paragraph 76 will be entered in the space provided and authenticated by the company commander concerned.

■ 92. INDIVIDUAL CLASSIFICATION AND QUALIFICATION.—For individual classification and qualification scores, see AR 775-10.

## SECTION VI

## TARGETS, RANGES, AND RANGE PRECAUTIONS

■ 93. AIMING TARGETS.—Two types of aiming targets are used in preparatory marksmanship training. Each type is placed on the standard 1,000-inch frame (par. 94) adapted to provide identical targets on both sides. To make the double-faced frame, two standard 1,000-inch frames may be bound together back to back or one frame may be covered with target cloth on both sides. Both surfaces are covered with blank white paper.

a. The target used in all of the aiming and tracking exercises described in paragraphs 70 and 74, except the successive target exercises described in paragraph 74g(4), is constructed by cutting out a single aiming silhouette of the size prescribed in figure 28 and pasting it in the center of blank white paper on each face of the target. The frame is placed in a portable standard to hold it vertically when placed on the ground. The standard or target holder which is attached to the sled is suitable for this purpose.

b. The target used in the aiming and tracking exercises described in paragraphs 70 and 74 is similar to the aiming target described above except that three rows of three aiming silhouettes each or nine silhouettes are equally spaced on the blank white paper on each face of the target frame.

■ 94. MARKSMANSHIP TARGETS.—The targets used for firing marksmanship courses are as follows:

a. *1,000-inch, 37-mm tank gun target.*—(1) The target frame for all 1,000-inch firing is 3 feet 6 inches by 2 feet 6 inches. It is made of  $\frac{3}{4}$ - by  $1\frac{1}{2}$ -inch lumber, halved and joined squarely at the corners. The frame is covered with target cloth to provide a bearing surface for the paper target.

(2) The target for 1,000-inch firing labeled A is shown in figure 28. Aiming silhouette and scoring spaces are provided for two individual scores. The aiming silhouettes represent the apparent size of a tank at a distance of 800 yards. For all firing, the aiming point on the aiming silhouette will correspond to those shown in figure 22. The target is printed with four solid black silhouettes or aiming targets. The upper pair of silhouettes is used for one complete score comprising two runs of the target over either course, one from right to

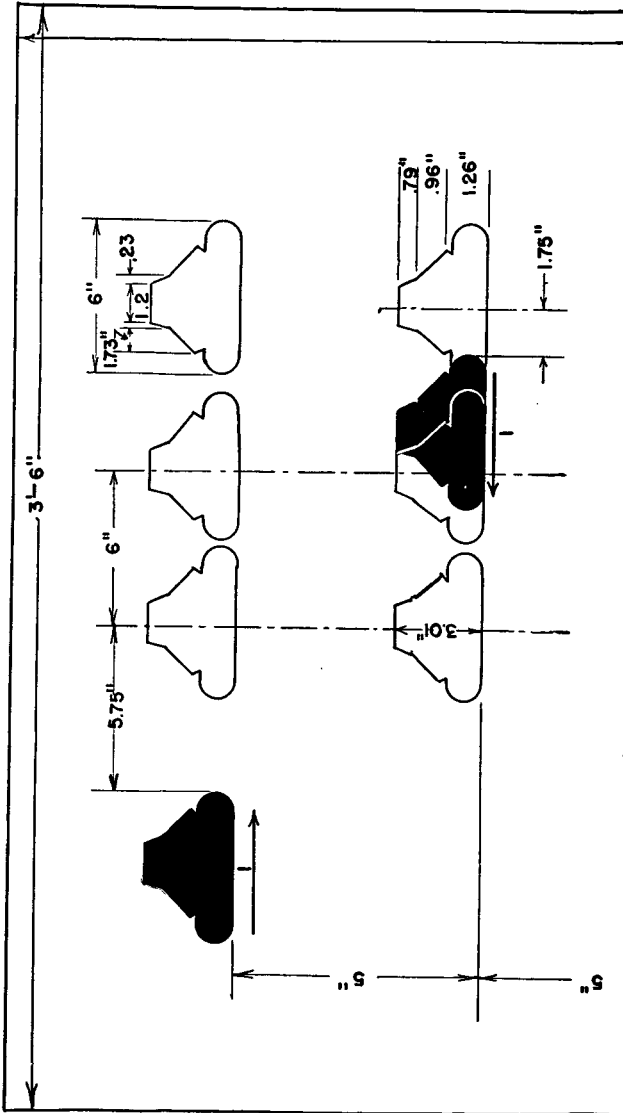

FIGURE 28.—Target A, 1,000-inch range.

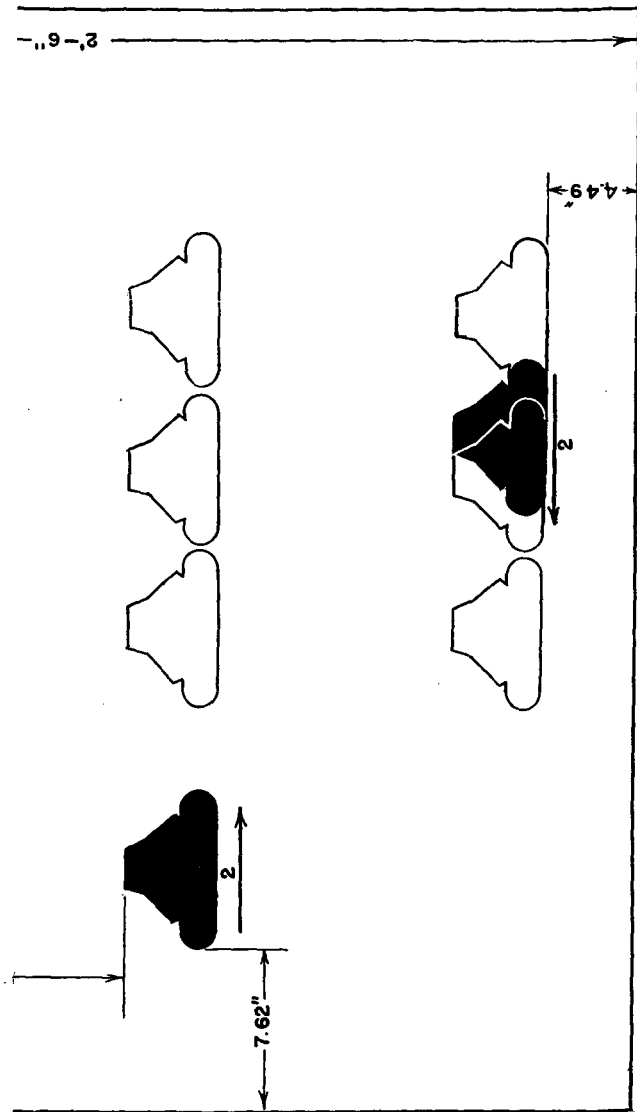

FIGURE 28.—Target A, 1,000-inch range—Continued.

left, the other from left to right. The lower pair of silhouettes is similarly used. The aiming target or tank to be used depends on the direction of movement of the target which is indicated by the arrows printed beneath each silhouette. The first scoring space (outlined tank) to the right of each aiming silhouette is the space in which hits are scored when no lead is taken with the target moving in either direction as indicated by arrow beneath silhouettes. The next scoring space to the right (left) of the center tank is used when one lead is taken with the target moving toward the right (left) of the gunner and the second scoring tank to right (left) is for two leads in the same direction.

*b. Field range 37-mm tank gun target.*—The target for field range firing, labeled *B*, is a 5- by 8-foot plain light colored panel used when firing the preliminary and record practices of table IV. (See par. 95.)

■ 95. CONSTRUCTION OF 1,000-INCH MOVING TARGET RANGE.—AR 750-10 prescribes the danger areas for target ranges. Due to the small size of the 1,000-inch range, a location can usually be found without difficulty. A level open space about 70 yards long (in the direction of fire) and about 20 yards wide is required for each moving target range unit. A single unit is necessary for each tank platoon. It will greatly facilitate the conduct of 1,000-inch firing to have two of these range units per platoon. A range unit consists of three runways in which a sled target moves to simulate the various directions of movement and speeds of probable combat targets. Movement of the sled is actuated by a wire cable which runs from a hand-operated drum through a system of pulleys and is fastened to both ends of the sled.

*a.* The dimensions and plan of construction of the three runways, that is, the parallel-level, parallel-hilly, and oblique courses, are given in figure 29. Figure 30 shows the details of construction of the apex of the oblique course. The sled target makes a sharp turn at this point and smooth operation depends on the careful construction of this corner.

*b.* Figure 31 is a sketch of the arrangement of the whole unit showing the positions of the pulleys and the hand-operated drum (reel). Pulleys numbered 1 to 10 are fastened to the tops of 4- by 4-inch posts. These are standard 2½-inch side pulleys. Pulleys P2, P3, P6, P7, P9, and P10 are adapted

for "snatching" by cutting an opening in one side just large enough to allow the wire cable to pass through the side so that it may be removed or replaced on the pulley wheel.

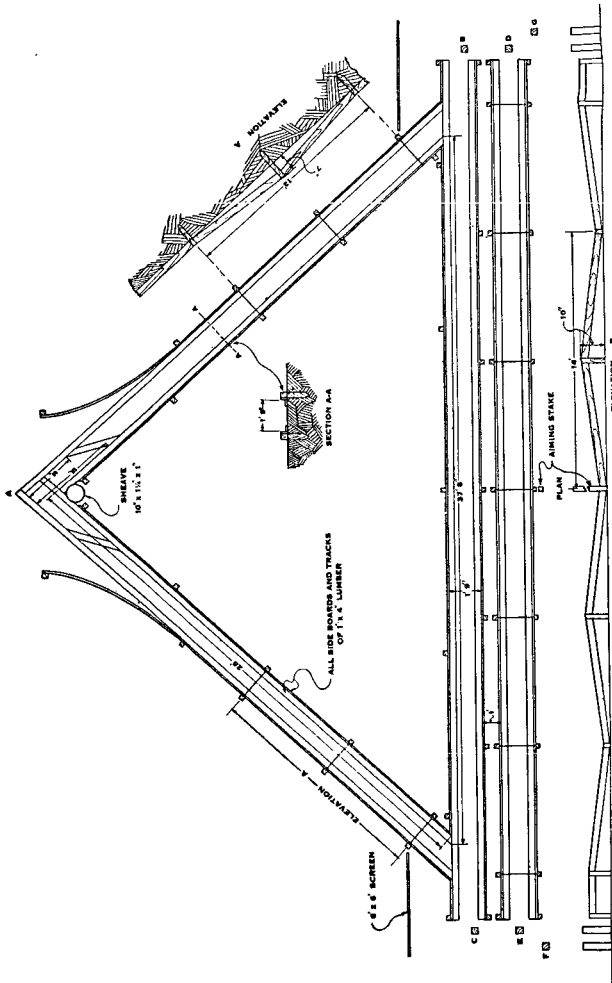

FIGURE 29.—Dimensions and plan of construction, 1,000-inch moving target range.

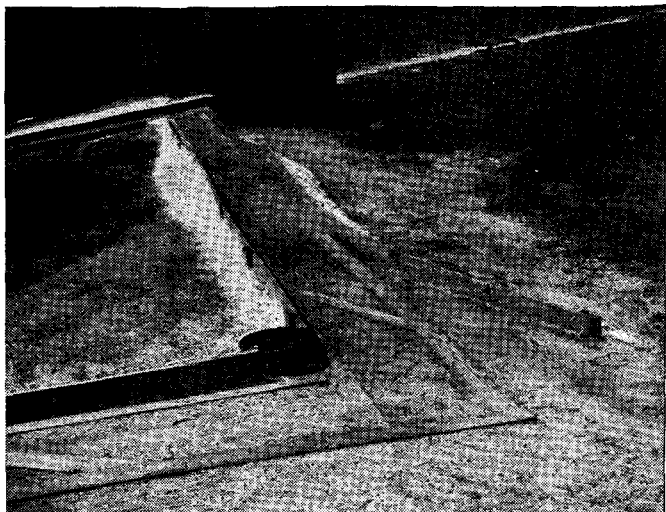

FIGURE 30.—Detailed construction of apex, oblique course, 1,000-inch moving target range.

c. Figure 32 shows the hand-operated drum. A commercial wooden cable drum was used to make this reel. The weight and relatively large diameter of the drum tends to resist sudden changes in speed, thus insuring smooth operation of the sled. Two 2½-inch swivel eye pulleys (one is shown in fig. 32) are attached to the base of the drum mount to bring the running cable close to the ground.

d. A twisted steel wire between No. 9 and No. 12 gage will make the most satisfactory cable. Two swivel rope snaps are fastened to the ends of the cable for attachment to the sled. The operating length of the cable is fixed as follows: Place the sled across the apex of the oblique course with the center of one side bearing on the sheave. Place the spool or coil of twisted wire on the ground at the same point. With the spool at the apex of the oblique course (fig. 31) run off the correct length of wire by passing the free end through pulleys P5, P8, and reel pulley, lapping the wires 10 times around the drum and then through the second reel

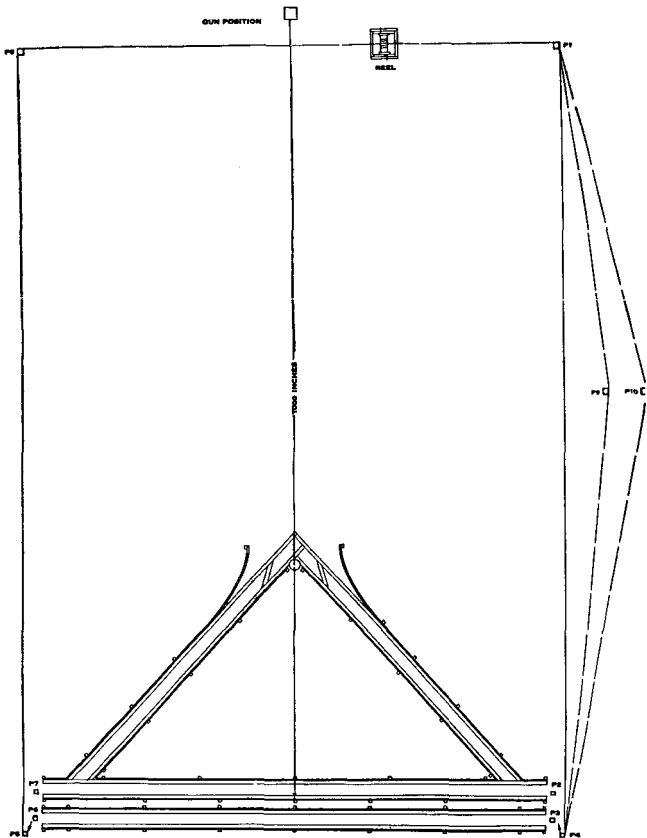

FIGURE 31.—Arrangement of 1,000-inch moving target range unit, showing positions of pulleys and hand-operated drum (reel).

pulley, P1 and P4, back to the sled. Fasten a rope snap to each end of the sled, cut the wire at the spool, and tie both ends to the swivel eyes of the rope snaps making the wire taut. Further adjustment in the length of the cable may have to be made to obtain smooth operation of the sled around the apex of the oblique course.



e. The offset pulleys, P9 and P10, are snatch pulleys, so placed that when the sled is used on the parallel and parallel-hilly course, the wire may be run around one of them as shown by the dotted lines in figure 31 to take up the slack due to the difference in length of each course.

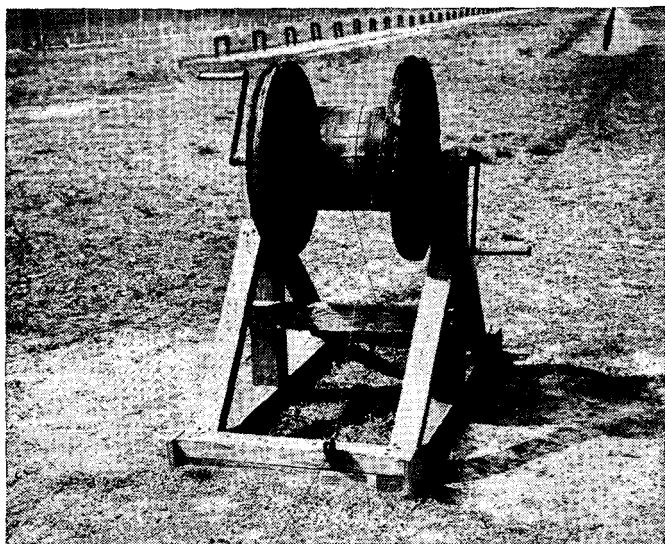

FIGURE 32.—Hand-operated drum (reel), 1,000-inch moving target range.

f. For the parallel course, the wire runs from the reel through P1, P9, P4, P2 to the sled and from the opposite end of the sled through P7, P5, P8 to the reel. For the parallel-hilly course the circuit is: Reel, P1, P10, P4, P3, sled, P6, P5, P8, and reel.

g. The position of the gun (pintle) for record firing is marked by placing a stake in the center of the range against which the center of the forward edge of the hull is placed. (See par. 89h.)

■ 96. TARGET SLED.—The sled in which the 1,000-inch moving targets are mounted should be heavy lumber in order to provide a low center of gravity which is necessary for

smooth operation of the sled. The target holder can be made of  $\frac{3}{4}$ -inch material. The bottom surface of the sled should be covered with tin so that it will slide easily in the runways of the 1,000-inch range. The standard which is attached to the top of the sled to receive the target frame should consist of two upright slots. The slots should be made to hold the target firmly and still allow it to be withdrawn easily. A piece of twisted wire cable should be fastened across each open end of the sled to provide a means for attaching the snaps of the towing cable, allowing free lateral movement of the snap along the wire when the sled changes direction.

■ 97. CONSTRUCTION FOR CALIBER .30 OR 37-MM KNOWN RANGE MOVING TARGET FIRING.—*a.* An approximately level or gently rising piece of ground should be selected for this range. It should be at least 500 yards in depth and of sufficient length to permit convenient operation of the moving target. Figures 33 and 34 show a moving target range, including two methods of towing the target. The construction of pits for the scoring and target details will facilitate scoring and changing targets. It is desirable also to have telephone communication between the pits and the firing line.

*b.* The set-up shown in figures 33 and 34 is flexible; that is, the length of the target run and the distance between firing line and target can be varied as desired. By placing the gun in successive firing positions, ranges between 200 and 500 yards may be obtained. Flags are placed as shown in figures 33 and 34 to indicate the right and left firing limit. These limits will vary with the distance from gun to target. They must conform to the conditions prescribed in AR 750-10. The target used when firing on this range is a 5- by 8-foot plain light-colored panel. The panel is mounted, long edge horizontal, on a suitable sled or carriage as indicated in figure 35.

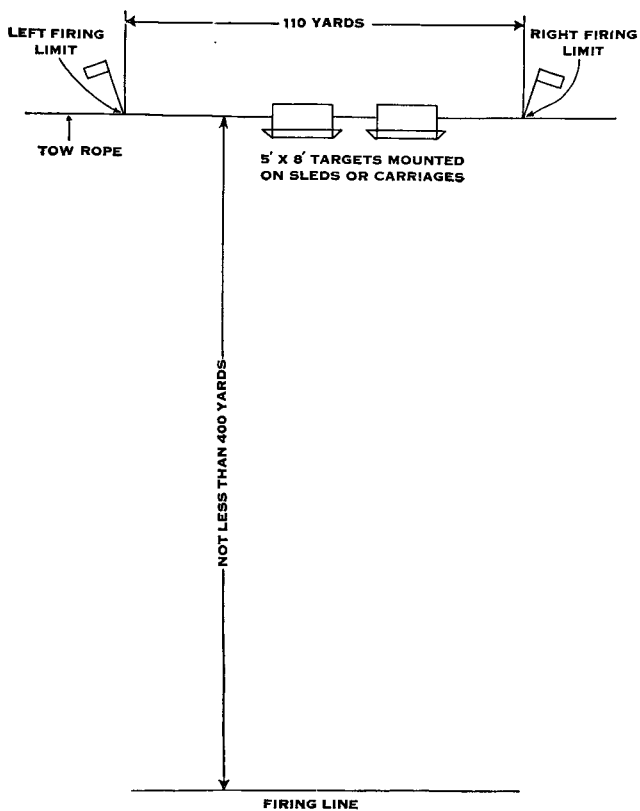

FIGURE 33.—Moving target, combat range.

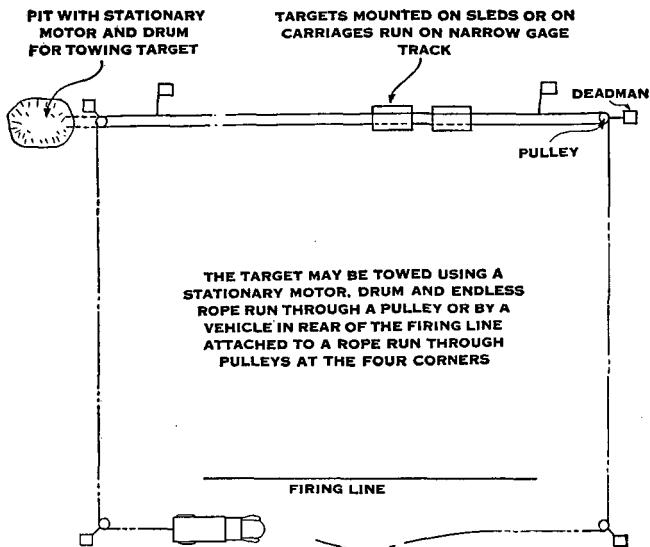

FIGURE 34.—Range for caliber .30 or 37-mm moving field target.

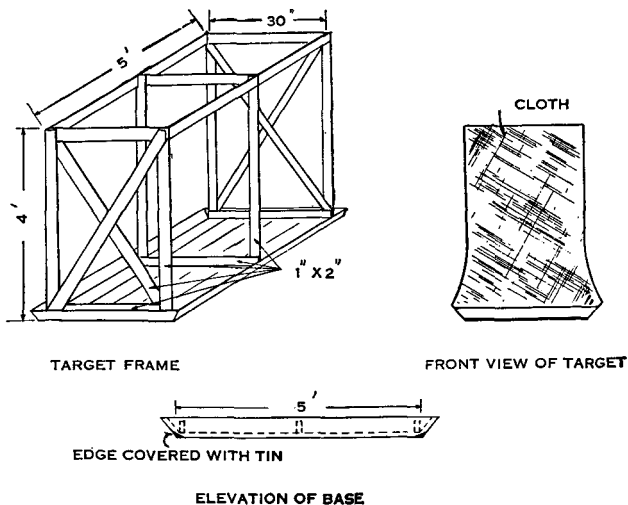

FIGURE 35.—Target frame and sled for towed-target range.

## CHAPTER 4

### TECHNIQUE OF FIRE

	Paragraphs
SECTION I. General.....	98- 99
II. Characteristics and classes of fire.....	100-104
III. Range determination and target speeds.....	105-111
IV. Target designation.....	112-115
V. Fire distribution.....	116-119
VI. Fire control.....	120-127
VII. Fire orders.....	128-129

#### SECTION I

#### GENERAL

■ 98. DEFINITION.—The application of effective fire upon a target is called “technique of fire.”

NOTE.—Chapter 5 contains descriptions of range lay-outs and exercises which will provide a practical basis of instruction for much of the technique of fire covered in this chapter.

■ 99. SCOPE.—*a.* This chapter describes the technique necessary for the preparation and conduct of fire of the 37-mm tank gun. The tank is the fire unit, even though its weapons are of different types.

*b.* In marksmanship, the soldier is taught to serve and fire a single gun at vertical screen targets under formal rules and situations. Next he must be trained to deliver his fire effectively in combat, acting on his own initiative or as a member of a tank, platoon, or higher unit team.

*c.* Technique of fire embraces—

- (1) Characteristics and classes of fire.
- (2) Range determination and target speeds.
- (3) Target designation.
- (4) Fire distribution.
- (5) Fire control.
- (6) Fire orders.

#### SECTION II

#### CHARACTERISTICS AND CLASSES OF FIRE

■ 100. CHARACTERISTICS.—*a.* The 37-mm tank gun is a flat trajectory weapon of the field gun type. The gun has maximum ranges as follows:

Armor-piercing M51 and practice M51 ammunition..... 8,500 yards at 15° elevation

High-explosive ammunition.....	5,300 yards at 15° elevation
Armor-piercing M51 and practice M51 ammunition.....	12,750 yards at 45° elevation
High-explosive ammunition.....	8,000 yards at 45° elevation

b. This gun is intended primarily for use against armor-protected antimechanized weapons, armor-protected vehicles, and lightly constructed, raised emplacements; the ease and speed with which it can be manipulated makes it particularly suitable for engaging moving targets. It has a muzzle velocity of 2,600 foot-seconds, and fires both armor-piercing and high-explosive shells. The armor-piercing ammunition is for use against armored vehicles and will penetrate 1½ inches of armor at 1,000 yards, at 20° impact. High-explosive ammunition is for use against unarmored vehicles, exposed personnel, and open emplacements.

■ 101. LIMITATIONS.—The free use of the capabilities of this weapon in tanks is restricted by the gun mount, the telescopic sight, and more or less by the vehicle itself.

a. Any type of mount now in use relays the movement of the tank to the gun and limits the manipulation of the gun. Hence the gunner's aim is subject to constant interruptions and his selection of targets is confined to those which appear within the angles of fire inherent in the mount, and in some cases, to those which can be engaged without interference with other guns using the same mount. Where the mount is attached to a rotating turret, the gunner may increase the angles of fire consistent with the characteristics of the turret and with the use of other weapons attached thereto.

b. The vision apertures for the telescopic sights of guns so equipped provide a very restricted field of vision.

c. The tank while in motion further hinders a free application of the powers of the gun by having the gunner on a constantly jerking platform, by constricting his position and his manipulation of the gun in its mount to the limits of the compartment provided, by reducing audibility, and by continually changing the range to the target and the position of the target by its direction of motion. The speed of the tank, coupled with the irregularities of the terrain, allows the gunner only fleeting opportunities to fire.

■ 102. **TRAJECTORY.**—The trajectory is the path followed by the projectile in its flight through the air. Because of the great speed with which the projectile leaves the 37-mm gun, the trajectory is very flat. At a range of 1,000 yards, its highest point is 6.5 feet.

■ 103. **ELEVATION TABLE.**—The elevation table specifies the time of flight of the projectile at various ranges and was used in determining the lead table contained in paragraph 74e.

37-MM TANK GUN, M5—ARMOR-PIERCING  
SHOT, M51

[Weight, 1.92 lbs. Muzzle velocity, 2,600 f/s (792.5m/s) ]

ELEVATION TABLE

Range in yards	Angle of elevation, mils	Time of flight, seconds	Range in yards	Angle of elevation, mils	Time of flight, seconds
0	0.0	0.00	1,100	8.6	1.43
100	0.7	.12	1,200	9.5	1.57
200	1.4	.24	1,300	10.4	1.72
300	2.1	.36	1,400	11.3	1.86
400	2.8	.48	1,500	12.3	2.01
500	3.6	.61	1,600	13.3	2.16
600	4.4	.74	1,700	14.3	2.31
700	5.2	.88	1,800	15.4	2.47
800	6.0	1.01	1,900	16.5	2.63
900	6.8	1.15	2,000	17.5	2.78
1,000	7.7	1.29			

■ 104. **CLASSES OF FIRE.**—*a. Fixed fire.*—Fixed, concentrated, or point fire is that fire which is delivered with the intention of having all projectiles strike the same point. Successive points are engaged by manipulating the gun to change its elevation and direction as required.

*b. Leading fire.*—Fire delivered to strike a moving target is termed “leading fire.”

### SECTION III

#### RANGE DETERMINATION AND TARGET SPEEDS

■ 105. **GENERAL.**—Since direct fire only is employed, the initial data necessary to the gunner for firing include only a

determination of the range and, when engaging a moving target, the lead.

■ 106. RANGE.—Accuracy in determining the range to a target is important to the effective use of the range and lead tables discussed in paragraphs 110 and 74e.

■ 107. METHODS OF RANGE DETERMINATION.—Ranges are determined by—

- a. Estimating distance by eye.
- b. Firing gun.
- c. Use of map.
- d. Obtaining from other units.

■ 108. ESTIMATING DISTANCE BY EYE.—a. *Necessity for training.*—As estimation by eye must be depended upon in combat, all men should be trained in this method. Stress should be placed on estimating ranges between 200 and 1,500 yards. The estimation by eye of untrained men is little better than a guess and the average error of such men will be at least 15 percent of the range. A definite system of range estimation, frequently practiced, is the only way to make estimation by eye sufficiently reliable.

b. *Application.*—Estimation by eye consists of measuring the range by applying to it a unit of measure 100 yards long. This is accomplished by the use of an accurate mental picture of one 100-yard length which the man applies the proper number of times to the distance. Application of the unit of measure beyond 500 yards is difficult. For this reason, in ranges over 500 yards, it is better to select a point halfway to the target, apply the 100-yard unit up to this halfway point, and multiply the estimated distance by two. An understanding of the size of tanks and other ordinary objects at the most used ranges will be of assistance. All tank personnel will be trained in estimating ranges by eye. The average of a number of estimates by different men will generally be more accurate than a single estimate. This variation of the suggested method is used when time permits by taking the average of the estimates of members of the tank crew or of specially qualified men.

■ 109. FIRING GUN.—Under favorable conditions, the method of determining the range most applicable to the tank is firing the caliber .30 machine gun that is mounted coaxially.



The gunner opens fire at the estimated range, then by observation of strike or tracer, places the strike on the target.

■ 110. **TARGET SPEEDS.**—The 37-mm tank gunner will also be trained thoroughly in estimating the speed of moving vehicles. This training is accomplished by exercises which present vehicles at the various close combat ranges moving at the probable combat speeds. By repetition of the exercises, the gunner will be given a clear idea of speeds under and over 15 miles an hour as associated with ranges under and over 300 yards. (See par. 135*d*.)

■ 111. **LEADS.**—*a.* The technique of engaging a moving target differs from that of engaging a stationary target in that the axis of the bore must be aimed ahead of the target, along its line of travel, to cause the projectile and the target to arrive simultaneously at the same point. This distance is equal to the distance the target will travel between the time the projectile leaves the gun and its trajectory crosses the path of the target, and will vary with the range and speed of the target. To hit a moving target, the gunner lays on the target with the announced range and lead, maintains this lay by tracking the target (manipulating the gun at the same angular speed as that of the target), and then fires.

*b.* When firing from a moving tank at a stationary target rear leads must be taken in the same manner as described heretofore.

*c. Lead table.*—See paragraph 74*e*.

#### SECTION IV

#### TARGET DESIGNATION

■ 112. **GENERAL.**—The ability to recognize, select, and designate battlefield targets is very important.

*a.* The recognition of targets embraces a knowledge of the distinctive battlefield appearance of the various weapons that may be expected to oppose the gunner, their flash and smoke characteristics, their methods of concealment, and their logical locations with respect to the ground and to each other. The gunner must appreciate the effect of limited vision, smoke, and the wearing of the gas mask upon his ability to locate targets. (See par. 135*e*.)

*b.* To select targets the 37-mm tank gunner must appre-

ciate their relative importance; for example, he must know that, to the tank in action, the following named targets have priority in the order of their danger to him: Antimechanized gun or mechanized vehicle, field artillery, machine gun, personnel. He must understand the capabilities of each target as they affect the immediate success of the tank unit and the supported troops. The tank unit will not be successful if its vehicles are disabled by antimechanized guns or enemy combat vehicles. Therefore, these, where present, constitute the targets of first priority. The enemy machine guns must be silenced to facilitate the advance of the supported troops; consequently, machine guns are next in importance to weapons and vehicles which oppose primarily the tank itself. (See par. 135e.)

c. The 37-mm tank gunner will be taught to designate targets by giving in sequence the necessary information relative to range, direction, and description. *Where one or more of these elements is obvious, it is omitted from the information furnished.* (See par. 114.)

■ 113. PRELIMINARY TRAINING.—As a preliminary to practical work in target designation, the gunner must have a knowledge of the military and topographical terms employed in designating targets, such as crest, hill, gully, ridge, crossroads, right, left, flank, skirmishers, column, and patrol. He must understand the meaning of such terms as horizontal, vertical, mil, yard, and pace. He must learn to use his eyes and to retain mental pictures of what he sees. (See par. 135f.)

■ 114. METHODS OF DESIGNATING TARGETS.—The methods used to designate targets are oral designation, pointing or firing a gun, code or signal designation. The method used will be the one which will bring fire to bear on the target in the shortest possible time.

a. *Oral designation.*—By this means, the target is designated by mouth, with or without mechanical aids such as interphones and radiophones but assisted, where applicable, by simple signals such as pointing the arm. (See par. 135g.)

(1) *Range.*—The range is announced by the command, RANGE, followed by a statement of the yardage, such as “four hundred.”

(2) *Direction.*—Wherever practicable, the direction will be given by pointing, using only such words as are necessary;

for example, "Front, right (left) front, right (left) flank, right (left) rear, rear." For a very obscure target, a clearly distinguishable reference point will facilitate the rapid location of the target. Thus, "Reference, disabled vehicle; right 50 yards; target, antitank gun."

(3) *Description*.—Usually a word or two is enough to describe the target; for example, "machine gun." If reference points are included in the order, the word "target" precedes the appropriate words in (2) above. (See par. 135g.)

*b. Firing a gun*.—Designating a target by firing a gun is a quick and simple method in applicable cases. The leader or gunner announces, "Range 300, front, watch my fire" or just "Watch my fire," fires one or more times on the target with his gun and completes the designation orally, as "Antitank gun."

*c. Code designation*.—(1) For units and tanks equipped wholly or partially with key radio (CW), the following code designation of targets will serve in suitable cases:

<i>Element</i>	<i>Code designation</i>
Tank:	
No. 1_____	1
No. 2_____	2
No. 3_____	3
No. 4_____	4
No. 5_____	5
Range to target:	
100 yards to 900 yards, respectively_____	1, 2, 3, 4, 5, 6, 7, 8, 9
Direction:	
Front (12 o'clock)_____	1
Right front (1:30 o'clock)_____	2
Right flank (3 o'clock)_____	3
Right rear (4:30 o'clock)_____	4
Rear (6 o'clock)_____	6
Left rear (7:30 o'clock)_____	8
Left flank (9 o'clock)_____	9
Left front (10:30 o'clock)_____	0
Description of target:	
Antitank gun (or combat vehicle)_____	A
Machine gun_____	M
Other targets_____	O

(2) Example of use by radio within a vehicle.

<i>Element</i>	<i>Voice</i>	<i>Key (code)</i>
Range.....	Range 400.....	4
Direction.....	Right front.....	2
Description.....	Antitank gun.....	A

Thus the key (code) designation would be: 4, 2, A. (See par. 135i.)

■ 115. TOUCH SIGNAL DESIGNATION.—The following touch signals will serve where both the designator and gunner are not equipped with earphones:

<i>Element</i>	<i>Signal designation</i>
Attention.....	Grasp a portion of the gunner's clothing and jerk him.

Range:

100 to 400 yards..... Expose one finger to gunner for each 100 yards of range to include 400 yards (four fingers).

Above 500 yards..... Expose closed fist once for each 500 yards, plus one finger for each 100 yards above a multiple of 500. (600 yards, one closed fist, followed by one finger.)

Direction..... Point in direction of target.

Description..... None.

(See par. 135 i.)

## SECTION V

### FIRE DISTRIBUTION

■ 116. GENERAL.—*a.* The tank is the fire unit, even though its weapons are of different types.

*b.* Fire, to accomplish maximum results, must be placed quickly and accurately on successive targets. The prompt destruction of antitank guns and combat vehicles by the 37-mm tank gunner will permit the caliber .30 gunners to utilize more of their fire on targets which oppose supported troops. Fire distribution, then, embraces the following factors in the order named: *Subdivisions of the target*, and *sequence of distribution*.

■ 117. SUBDIVISION OF TARGETS.—The unit commander will be able frequently to subdivide targets and areas so that each

tank will be responsible particularly for a more or less equal part of the whole target or area. Special targets may be assigned to all 37-mm tank guns on proper occasion.

*a.* Where tank units such as the section or platoon, move forward, each tank is concerned primarily with an area which will be passed through partially or in its entirety as the tank moves over its selected route to its assigned part of the objective. All or part of this zone or lane will contain targets. Thus the vital part of the area assigned to a tank is that part of the target position which lies on either side of the route of advance, the width of the zone being determined generally by the interval between tanks. Except where irregularities of terrain occur, the lanes will be more or less equal in width and parallel. Converging or diverging routes may be used in approaching appropriate objectives.

*b.* Where a tank section or platoon occupies a stationary position of partial tank defilade, large areas will be subdivided laterally, more or less equally by tank, the number of subdivisions depending usually on the number of tanks in the unit, such as the right fourth (fifth) to the right tank of fire. At times, to utilize frontal defilade fully, it will be desirable for certain tanks or units to employ cross-fire; that is, to fire on targets which are opposite other tanks or units. This method is used for training, when all tanks fire from a designated line.

■ 118. **ENGAGEMENT OF TARGETS.**—*a.* To secure the maximum effectiveness of fires, the ideal method is to have 37-mm tank guns engage only remunerative targets which have been definitely located. However, where the tank unit closely supports other troops it will be concerned usually with an area which contains various types of targets. The definite location of certain of these targets may have been determined prior to the close engagement of the unit, but more often the targets will be obscure or unknown and will disclose themselves after engagement by the unfolding of the terrain, movement, and muzzle blast. Even after being located, many will be indistinct because of natural or artificial methods of concealment. (See par. 135e.) In all possible cases, knowledge must be gained as to the definite location of targets by persistent reconnaissance and requests for such information from supported troops.

b. After areas have been subdivided among individual tanks in applicable situations, the various types of guns of each tank must distribute their fire on targets in the proper sequence. *The 37-mm tank gunner picks his targets in the order of their immediate danger to his own unit regardless of whether or not targets are within the particular area assigned to his tank.* The circumstances may require a tank to disregard its predetermined route and area temporarily, to permit it to engage certain targets. The priority of basic targets is discussed in paragraph 112b.

c. The range to the target and speed at which the tank is moving determines the time within which the target can be brought under effective fire by tank weapons. The fire from tank weapons in the moving tank loses much of its effectiveness as the range increases. The 37-mm tank gun using the telescopic sight is targeted to fire most effectively at a given range, usually 300 yards for the moving tank. However, regardless of these limitations on the effectiveness of fires, important targets such as antitank guns and vehicles will be engaged at any reasonable range where circumstances warrant. Unless enemy machine guns have penetrating effect against the type of friendly tank used, they can best be engaged by the tank at a range of 300 yards or less.

■ 119. METHODS OF ENGAGING TARGETS.—*a. Point target.*—To engage a point target, the gunner will place the strike on the target and maintain it by successive shots for the time necessary to neutralize or destroy the target.

*b. Rapidly moving ground target.*—(1) Fire at rapidly moving ground targets requires the use of leads, and a rapid manipulation of the gun to maintain direction and elevation. (For leads and their use, see par. 74e.)

(2) In an attack formation, each tank will engage first the leading target representing an enemy combat vehicle in its own zone; however, enemy command vehicles, recognized, must receive priority if the situation permits. Stationary vehicles firing from partial tank defilade may have occasion to concentrate all fires on the leading vehicle with effect, such as engaging the leading vehicle of an enemy column passing along a road in order to block the road by disabling the leading vehicle. (See par. 135k.)

## SECTION VI

## FIRE CONTROL

■ 120. GENERAL.—*a.* Fire control implies the ability of the leader to open fire at the instant he desires, adjust the fire of his guns upon the target, shift it from one target to another, regulate its rate, and cease firing at will. The lack of proper control results in loss of surprise, misapplication of fire on less important targets, loss of time, and wastage of ammunition.

*b.* Fire control is founded primarily on thorough discipline and technical training. There must be an adequate decentralization to compensate for the difficulties encountered in firing guns from tanks.

■ 121. CHAIN OF FIRE CONTROL.—The company commander usually gives his initial orders orally direct to the platoon leader on the ground, and subsequent orders by radio or signal from his command vehicle. The platoon leader will communicate similarly his fire orders to his section leaders and tank commanders, and they in turn communicate their own to their gunners. Due to such factors as noise, semi-isolation of firing compartments, limited vision, and fleeting opportunity, fire control for moving tanks must be based on simple methods to insure effective execution and the engagement of new and unexpected targets which appear after the unit has become engaged. In the tank, the gunner does not have an assistant to watch for signals while he is watching the effect of his fire; consequently, in action, recourse to sound and touch signals will be necessary to supplement the full use of prearranged decentralization through initial orders issued prior to close combat. (See par. 135.)

■ 122. ADJUSTMENT OF FIRE.—*a. General.*—Observation and adjustment of fire are the most important elements of fire control. The gunner observes and corrects his own fire without command; however, the tank commander, if not the gunner, must at all times exercise adequate supervision and control.

(1) The most important feature of firing at any target is to get a shot off quickly with the estimated data and then adjust fire to bring the strike into the target. Upon observation of the first round, the range point in the sight is raised or

lowered on the target and the amount of lead is altered to obtain a hit.

(2) No mathematical or mechanical means are available at the gun or on the gun sight to make small or exact range or lead corrections. However, extensive firing practice and careful coordination of effort by the gunner, loader, and other tank crew members will give excellent results. A thorough understanding and application of the rules of marksmanship, particularly insofar as the use of the range and lead table is concerned, are essential.

(3) While it is true that the gunner can observe to a limited extent the tracer through the sight and often can without help establish the correct aiming point and lead to obtain a hit, he is materially assisted in the process of firing by having the loader and other tank crew members caution: AHEAD; BEHIND; OVER; SHORT; USE MORE (LESS) LEAD; INCREASE (DECREASE) TO ONE (TWO, ONE-HALF) LEAD, etc. The gunner makes the necessary corrections as he is tracking the target and fires.

(4) In applicable cases, where the fire may be observed and directed by another, maladjustments will be announced or signaled:

Gunner's fire is—	Stationary target	Moving target
Above or over target.....	Over.....	Over.
Below or under target.....	Short.....	Short.
Right or left of target.....	Right of; left of.....	
Ahead or behind target.....	.....	Ahead, behind.

(5) The following signals will be used in adjusting fire where they will expedite results:

Maladjustment	Radio key	Voice	Touch
Above or over....	O	Over.....	Pull up on clothing.
Below or under....	U	Under.....	Pull down on clothing.
Right of (left of)....	R (L)	Right of (left of)....	Pull clothing to right (left).
Ahead.....	A	Ahead.....	Pull clothing to right (left) or down (up).*
Behind.....	B	Behind.....	Pull clothing to right (left) or down (up).*

\*Applies to moving target.



*b. Switching fire.*—When a hit is made, the designated observer calls out "HIT!" The gunner continues to fire at the target until it is stopped or disappears. After stopping a target, the gunner as quickly as possible switches the fire of his gun to the next most dangerous target.

*c. Rate of fire.*—The rate of fire will be determined by the number, range, and visibility of the targets. At more distant ranges, the fire will necessarily be slow due to the difficulty in accurately tracking the target. At close range, targets must be fired on with great rapidity. The ammunition supply may prove the determining factor in deciding upon the rate of fire. It is controlled by designating the number of rounds to be fired at a given target.

*d. Interruption of fire.*—To interrupt fire, the command or signal CEASE OR SUSPEND FIRING is given. Observation of the targets must be continued during these interruptions.

*e. Serious malfunction.*—In case of a serious mechanical malfunctioning of the gun during firing, the tank should be returned to the initial position for repair of the guns at the first opportunity.

■ 123. LEAVING ROUTES.—The platoon leader, in cases involving the delivery of fire from a moving formation, will make timely announcements of authority to leave zones of advance for special purposes. However, *the leaving of designated routes temporarily to fire point blank on targets representing antitank guns or combat vehicles will be routine.*

■ 124. CRUISING FIRE.—Specific orders will often be required to insure the efficiency of fires for tanks which cruise on an objective, the safety of fires with respect to supported troops, and the suspension of fire.

■ 125. KIND OF AMMUNITION.—The kind of ammunition used will depend on the type of target and the conditions affecting visibility.

■ 126. TIME OF OPENING FIRE.—*a.* The fire of a number of guns from tanks should be opened simultaneously where possible to gain the maximum in surprise effect and the most effective fire insofar as range is concerned. Depending on the situation, it may be opened upon command or signal, on a predetermined line; occasionally on an undetermined line to

be announced by radiophone or prearranged signal; or by tank on opportunity as suitable targets are disclosed. In the use of signals for the purpose of opening fire, certainty of reception by all elements concerned is essential. (Use in connection with exercises in par. 135.)

b. Methods of transmitting the command:

Signal	Voice or radiophone	Key radio	Touch
Prescribed arm-and-hand or flag.	Commence firing..	F	Tap gunner with the hand.

■ 127. TIME TO CEASE FIRING.—a. Upon the accomplishment of a mission, the loss of opportunity, or the endangering of friendly personnel, firing will cease by command or signal, on arrival at a predetermined line, or on the judgment of the gunner. (Use in connection with exercises in par. 135.)

b. Methods of transmitting the command:

Signal	Voice or radiophone	Key radio	Touch
Prescribed arm-and-hand or flag.	Cease firing.....	SF	Tap gunner with the hand.

## SECTION VII

### FIRE ORDERS

■ 128. BASIC ELEMENTS.—The necessary elements of target designation, fire distribution, and fire control, where combined in the order named, constitute fire orders. The considerations governing these basic elements will be found in the preceding sections. Although reference in any fire order is made only to the essential basic elements or parts thereof, the sequence of the parts used will follow that given in the illustrative table below. Fire orders issued prior to engagement will follow frequently the more detailed, complete form; *those issued during action must be abbreviated and terse.*

a. There are two general classes of fire orders:

- (1) Those employed when engaging moving targets.
- (2) Those employed when engaging stationary or small fixed targets.

b. The elements that make up each class of order are generally the same; however, in the second class the elements pertaining to the description of the target and direction thereto are usually more detailed.

c. Three types of ammunition (AP, TP, and HE) may be employed. No mention of the type of ammunition to be employed will be included in any fire order unless the high-explosive shell is to be used, in which case the command HIGH EXPLOSIVE will constitute the first element of the order.

■ 129. INITIAL AND SUBSEQUENT FIRE ORDERS.—*a. Initial order.*—The initial fire order (which contains the data for firing the first round) will contain the information shown below and will be given in the following sequence:

- (1) Type of shell (*only when HE is used*).
- (2) Range.
- (3) Direction.
- (4) Description.
- (5) Lead (*moving targets only*).
- (6) Fire distribution, which includes—
  - (a) Subdivision of target.
  - (b) Type of distribution.
- (7) Fire control, which includes—
  - (a) Number of rounds to be fired (*only when restriction on number of rounds is necessary*).
  - (b) Time of opening fire.
  - (c) Time to cease or suspend firing.

*b. Subsequent orders.*—Initial fire orders will usually be in complete form. Subsequent orders, issued during the fire fight to switch to a new moving target, etc., will be abbreviated to include only the data which are to be changed.

## ILLUSTRATIVE TABLE FOR FIRE ORDERS

Element and part	Example
Ammunition:	
Type of shell.....	HE (high explosive). <i>No mention of the type of shell is made unless an open or unarmored vehicle is engaged, upon which it is desired to use the high-explosive shell.</i>
Target designation:	
Range.....	Range 400; No. 1 (tank), range 300 (37-mm) gun(s), range 500; first platoon, range 600.
Direction.....	Front; right (left) front; right (left) flank; right (left) rear; rear.
Description.....	Antitank gun; machine gun; trench; tank (combat, armored, scout car); that (such-and-such hill) (column, area); reference lone pine, right (left, up, down) 50 yards corner of trench, target antitank gun.
Lead (moving targets only).	Zero lead; one lead.
Fire distribution:	
Subdivision of target.....	No. 4 (tank), right fifth (such-and-such); No. 5 (tank) . left (such-and-such) zone (sector); first platoon (objective, sector, zone), right of that trail (such-and-such).
Type of distribution.....	Fixed (concentrated, point); located targets.
Fire control:	
Rate of fire.....	Rapid; slow.
Time of opening fire.....	Commence firing; upon signal (so-and-so); on that (such-and-such) line; on opportunity.
Time to cease firing.....	Cease firing; upon signal (so-and-so) (on loss of opportunity) (on that line) (at such-and-such time) (on leaving objective), cease firing.

## CHAPTER 5

## FIRING AT FIELD TARGETS

SECTION I. General.....	Paragraphs 130-133
II. Preparatory exercises.....	134-135
III. Firing exercises.....	136-138
IV. Construction of targets, ranges, and equipment.....	139-140
V. Safety precautions.....	141-142

## SECTION I

## GENERAL

■ 130. PURPOSE.—The purpose of this phase of training is to instruct leaders in the control of their units under simulated battle conditions and individual members of the tank crews

to act as a fighting team in the performance of their various duties so as to secure maximum fire efficiency.

■ 131. SCOPE.—Training in firing at field targets will include instruction in preparing the gun for firing under the conditions described in chapter 2, and technique of engaging various types of combat targets.

■ 132. PRIOR TRAINING.—Before a unit receives training in firing at field targets, all men should receive instruction in training for placing the gun in action, marksmanship, and technique of fire.

■ 133. EQUIPMENT.—Instruction in field firing requires ranges, equipment, and supplies which must be prepared or obtained in advance. Supplies and ranges should be requested early to prevent any interruption in the training schedule. Section IV describes the ranges and necessary equipment.

## SECTION II

### PREPARATORY EXERCISES

■ 134. GENERAL.—*a.* Preparatory exercises precede field firing. Their purpose is to train each individual to estimate the ranges and speeds of vehicles and to determine the correct lead.

*b.* The size of a combat target (armored car or tank) will have a definite influence upon the estimation of its range and speed. Before beginning the exercises described below, the men should be given an opportunity to note the appearance of available types of armored vehicles at ranges between 200 and 1,200 yards. They should be placed so that they may be seen at different angles, front, side, etc.

*c.* Figure 36 illustrates the appearance of combat vehicles as seen by the gunner under varying conditions of movement. It is highly desirable as a preliminary step in this phase of training to use a tank to demonstrate where the gunner should aim in each different situation. The vehicle should be placed so that the group will obtain the same point of view the gunner would have when looking through the telescope at targets moving at various angles to his line of sight. In each case, the instructor should point out the correct point of aim.

*d.* Figure 37 illustrates the use of various types of combat vehicles operating at constant speeds through known dis-

tances. It lends reality to the instruction to use different types of armored vehicles, when available, for this training. This or a similar set-up should be used in conducting exercise No. 4 as hereinafter described.

■ 135. EXERCISES.—*a. No. 1.*—(1) *Purpose.*—To familiarize men with the 100-yard unit of measure for use in estimating distances by eye.

(2) *Method.*—Stake out previously on diversified terrain, markers which will be visible up to 500 yards. Impress the men with the appearance of the unit of measure at various ranges from the prone, crouching, and standing position, and from the tank. To do this, move the men away from and in prolongation of the units staked out and cause them to study the appearance of the unit of measure from distances of 100, 200, 300, and 400 yards.

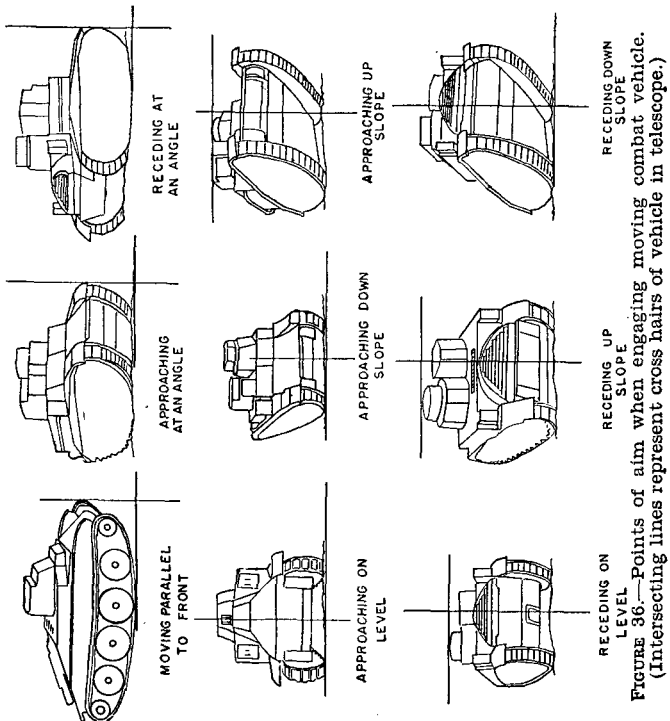

Figure 36.—Points of aim when engaging moving combat vehicle. (Intersecting lines represent cross hairs of vehicle in telescope.)

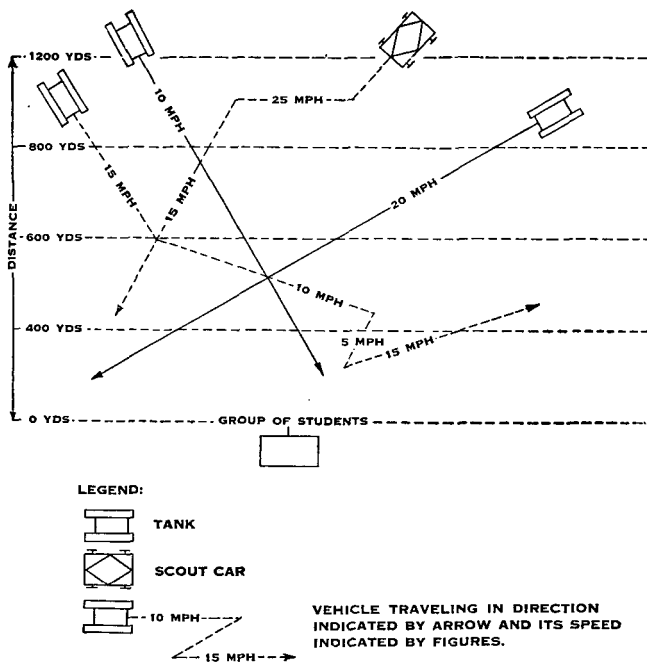

FIGURE 37.—Course for training in estimation of range and speeds.

*b. No. 2.*—(1) *Purpose.*—To apply the unit of measure in estimating distances by eye.

(2) *Method.*—(a) Mark ranges up to 900 yards by placing large markers or target frames at every 100 yards of the distance, each marker bearing a number to indicate its range. Place the soldiers undergoing instruction about 25 yards to one side of the prolonged line of markers and have each man hold a blind beside his eyes so as to hide all the markers from his view. Then direct the men to apply the unit of measure three times along a straight line in the general direction but slightly to one side of the markers. Have the eye cover removed as soon as the man has applied the unit of measure to the ground the required number of times by mental process. Check the estimations of the successive

100-yard points and the final 300-yard point against the markers. Repeat the exercise to gain accuracy.

(b) Next use ranges over 300 yards. Have the men first determine the 300-yard range then apply it as a unit to the total range.

(c) Require estimation from the prone, crouching, and standing positions, and from the tank, closed as for combat.

*c. No. 3.—(1) Purpose.*—To give practice in range estimation after accomplishing exercises Nos. 1 and 2.

(2) *Method.*—From a suitable point, measure the range to objects within 900 yards. Conduct the men to the selected point and require them to write on paper their estimates of the ranges. Allow 30 seconds for each estimate with the men using the various dismounted positions and the pertinent vehicle. Collect the papers and announce the ranges. Post individual and crew averages on a bulletin board accessible to all participants.

*d. No. 4.—(1) Purpose.*—To demonstrate and practice the estimation of vehicle speeds, ranges, and leads.

(2) *Method.*—On a fairly level piece of ground, place the soldiers undergoing instruction, first dismounted and then in the tank, so that they can observe vehicles moving on cross courses, 300, 500, and 900 yards away on oblique courses from respective far corners to opposite near corners and vice versa, and on a perpendicular course from front to rear and vice versa. Have a vehicle move over such course a number of times at speeds of  $7\frac{1}{2}$ , 15, and 30 miles an hour. Initially, announce each speed prior to the run; later, diversify the runs and speeds announced. Stress the importance of estimating speeds, direction of movement, and ranges from within the vehicle, halted and moving. The men are required to estimate range and speed of the target and announce the corresponding lead listed in the lead table (par. 74e). Have estimates of unannounced speeds and appropriate leads recorded and published as prescribed for exercise No. 3.

*e. No. 5.—(1) Purpose.*—To teach the recognition of distinct and indistinct targets in their logical locations under varying conditions of combat.

(2) *Method.*—(a) Select two or more pieces of terrain suitable as infantry company or battalion defensive positions. One piece should be comparatively open and another



covered with diversified vegetation and trees. Indicate several platoon defense groups with prone silhouettes and put at least four machine guns and two antitank guns with crews in their probable forward and rear locations. In one exercise, have targets and guns partially concealed by use of natural or artificial cover.

(b) Move vehicles, in column, from a given line of departure, through the area from front to rear a number of times under each of the following conditions:

1. Doors and turrets open.
2. Doors and turrets closed.
3. Enemy guns firing blank ammunition.
4. Vehicle personnel wearing gas masks.
5. Route of the vehicles concealed with smoke.

(c) Have the vehicle guns locate, point out, and track targets.

(d) Exercise care to prevent the ground personnel from being overrun by the vehicles.

*f. No. 6.*—(1) *Purpose.*—To point out the military and topographical terms used in designating targets.

(2) *Method.*—Select a diversified terrain to meet the requirements of paragraph 113. Assemble the personnel undergoing instruction at a suitable point or points where the greatest number of terrain features and terms can be pointed out or applied. The use of set-ups for exercise No. 7 will add to the training in the meaning of military terms.

*g. No. 7.*—(1) *Purpose.*—To teach oral target designation.

(2) *Method.*—Use set-up for exercise No. 5. Have each man designate various targets.

*h. No. 8.*—(1) *Purpose.*—To illustrate target designation by firing and pointing a gun and by using stakes.

(2) *Method.*—Demonstrate the three methods and test the men in their use by having them convey the information pointed out by means of oral designation.

*i. No. 9.*—(1) *Purpose.*—To practice the designation of targets by radio code and touch signals.

(2) *Method.*—Use set-ups similar to those suggested for exercises Nos. 5 and 11. First conduct the practice by vehicle, later by platoon. At the critiques, have individual gunners and vehicle commanders give the oral designation of the targets pointed out to them in code or by touch signals.

*j. No. 10.*—(1) *Purpose.*—To show the proper engagement of a point target.

(2) *Method.*—Set up a target at 300 and 600 yards. Fire for adjustment, and then place a designated number of rounds on the target using tracer or ball and tracer ammunition (cal. .30).

*k. No. 11.*—(1) *Purpose.*—To practice the delivery of fire on moving targets.

(2) *Method.*—See the suggested set-ups and procedure outlined in sections III and IV.

### SECTION III

#### FIRING EXERCISES

■ 135. **GENERAL.**—Field firing at moving targets should follow the methods of preparatory training; slow speeds and short ranges should be used initially. In all of the firing at field targets described hereinafter, only the unit instructor, gunner (No. 1), and loader (No. 2), are necessary. Each individual performs the duties prescribed for his position in the preceding chapters. The first phase of this training is conducted using caliber .30 tracer ammunition. Ammunition allowances restrict the use of 37-mm ammunition. Thorough training for all men in caliber .30 firing exercises is necessary, therefore, to insure the maximum efficiency when firing 37-mm ammunition in subsequent exercises.

■ 137. **SUBCALIBER.**—These exercises are conducted on the range described in paragraph 97. This range has a single target course which runs parallel to the front of the gun position. The maximum range used is 500 yards, since at greater ranges the trajectory and time of flight of caliber .30 ammunition vary so much from that of 37-mm ammunition that the value of this training is greatly reduced. Various ranges between 200 and 500 yards are obtained by moving the tank to successive firing positions. At each range, firing is begun with the target moving at 5 miles per hour and gradually increased to 15 miles per hour, the maximum speed practicable on this range. Targets arranged in tandem as shown in figure 34 permit the firing of two tanks simultaneously, or when a single tank is used, practice is afforded in shifting fire from one target to another.

■ 138. USING 37-MM AMMUNITION.—Instruction in firing with 37-mm. ammunition should be conducted in two phases: firing at stationary or fixed targets and firing at moving targets.

*a. Firing at stationary or fixed targets.*—This firing should be conducted on varied terrain and should include firing on screen targets approximately the size of a tank and at natural features of the terrain. *If high-explosive shell is used on the latter type targets, the safety precautions required when firing this type of ammunition will be rigidly enforced.* (See par. 142.)

*b. Firing at moving targets.*—(1) The range set-up described in paragraph 140 provides four moving target courses. Courses 1 and 2 run parallel to the front of the firing line at range of 400 and 600 yards, respectively. Courses 3 and 4 offer various directions of movement approaching and receding from the gun. As in previous exercises, target speeds should start at 5 miles per hour and gradually increase to 15 miles per hour or greater depending on the efficiency of the equipment.

(2) Initially, the firing exercise should be directed toward the training of efficient gun crews. The unit instructor, gunner (No. 1), loader (No. 2), and No. 3 are at the gun. Upon the appearance of the target or start of a run, the unit instructor is required to issue a fire order and the gunner engages the target with a specified amount of ammunition. During this firing, emphasis is placed on correct technique of fire and service of the piece.

(3) Subsequent exercises combining simple tactical situations and firing should be conducted with a view to training the tank crews as a combat team. These exercises may be conducted on the range described in paragraph 140. However, it is highly desirable when possible, to use terrain that is not familiar to the men in order to avoid the artificiality which results from using a permanent familiar set-up. A flexible arrangement which can be readily installed on any terrain is to use one pulley, emplaced as shown in figure 39, to obtain one change of direction. The target is concealed at its starting point. The unit required to perform the exercise is brought to the area and given a simple situation requiring the application of the various elements of advanced training in going into action and engaging a target. Set-ups

should be varied as much as possible for each exercise in order to keep up interest. In these exercises, the instructor acts as umpire, presenting the situation and requirements, and holding a critique at the end of each exercise.

## SECTION IV

## CONSTRUCTION OF TARGETS, RANGES, AND EQUIPMENT

■ 139. RANGE FOR CALIBER .30 FIELD FIRING.—See paragraph 97.

■ 140. RANGE FOR 37-MM FIRING AT TOWED TARGETS.—*a. Setup.*—The range shown in figure 38 may be modified to suit limiting conditions such as available terrain and equipment.

*b. Terrain.*—The terrain selected should permit changes in elevation as well as direction. The course may be extended to obtain range up to 1,200 yards.

*c. Towrope and accessories.*—(1) A ¼-inch wire cable may

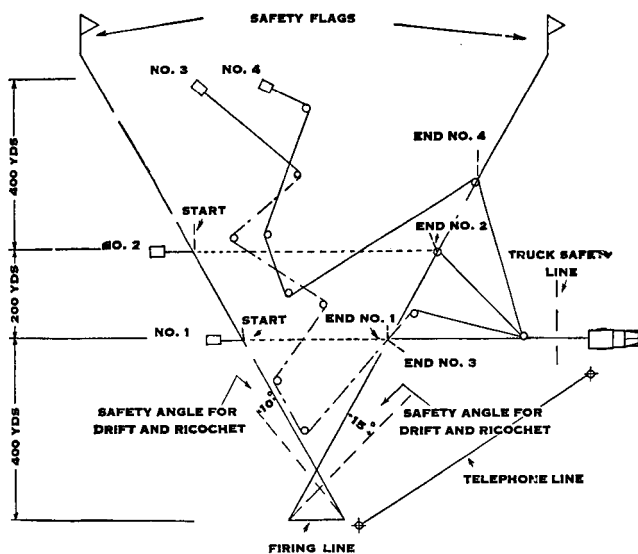

FIGURE 38.—Range for firing 37-mm ammunition at stationary or towed targets.

be used for towing, but it is difficult to splice; unless the ground is rocky, a  $\frac{3}{4}$ -inch manila hemp rope is better.

(2) Figure 39 shows the pulley lay-out to create changes in direction of the target. In the absence of pulleys, a piece of 4-inch pipe, driven into the ground until 5 or 6 inches protrude, will serve. With the pulley arrangement, the tow-rope is attached to the top edge of the target sled and a large knot about 8 inches in diameter, or preferably a wooden ball, is placed in the rope approximately 15 feet ahead of the target to cause the rope to jump the pulley. If the pipe is used, the towrope is attached to the target on a special bracket about 18 inches from the ground.

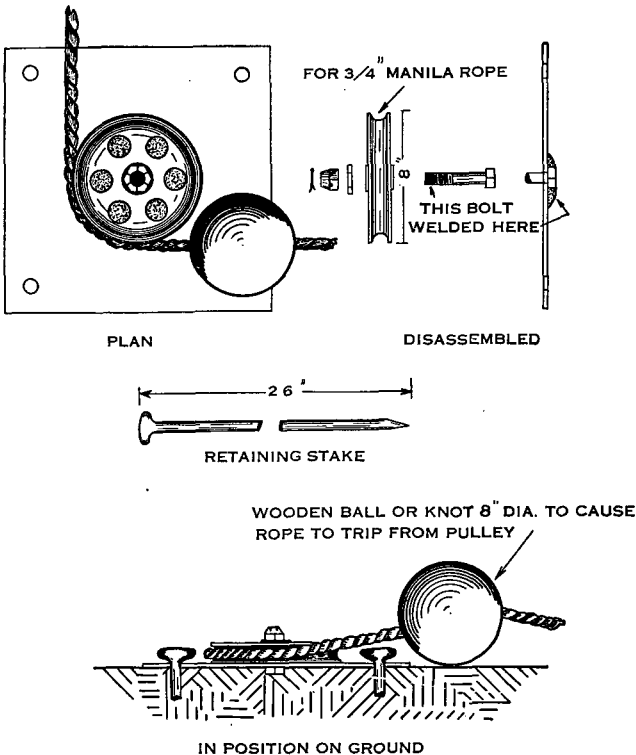

FIGURE 39.—Pulley lay-out for towed target range shown in figure 38.

(3) A drum similar to the one shown in figure 40 is installed at each curve in the road traveled by the towing vehicle.

(4) Details of construction of the sled target are shown in figure 35. A larger target, more nearly corresponding to the size of a tank, may be used; however, its increased weight will reduce smoothness of operation.

*d. Operation.*—(1) After training the operating personnel, an exercise may be fired every 6 or 8 minutes, provided two towing vehicles are used.

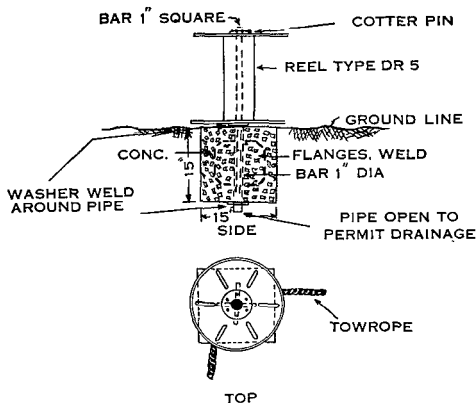

FIGURE 40.—Roadway drum for towed target range shown in figure 38.

(2) The second vehicle, as soon as safety permits after each run, moves to the old target. The towrope is unhooked from the old target and fastened to a new one. The second truck then proceeds around the course in the reverse order while personnel following in rear of the truck engage the towrope over the successive pulleys. The target is returned to its starting position, the forward end of the towrope is attached to the towing vehicle, and the firing line is notified that the operating detail is ready.

(3) When available, two radio sets may be used for communication between the target detail and the firing line. The set with the target detail may be placed on the second vehicle, allowing continuous communication while replacing the target. This arrangement saves time and makes the system more flexible.

(4) The starting and final positions of the towing vehicle are marked by flags.

(5) The safety limits for all firing on the range are established to conform with AR 750-10 and are marked by flags as shown in figure 38. Additional safety precautions are contained in section V.

## SECTION V

### SAFETY PRECAUTIONS

■ 141. GENERAL.—Range areas and safety precautions for 37-mm. tank guns firing must conform with instructions set forth in AR 750-10.

■ 142. ADDITIONAL SAFETY PRECAUTION.—*a. Misfires.*—The procedure in handling misfires during peacetime is explained in paragraphs 54 and 61f(4).

*b. Precautions when firing high-explosive shell.*—The fuze of the high-explosive shell used in the 37-mm tank gun is not bore safe. Therefore, during peacetime, it is necessary to provide positive protection against premature bursts in or out of the bore for persons in vicinity of the firing point. The form of protection required is specified in paragraph 14a, AR 750-10. To comply with these instructions, the gun crew and all other persons within an area of 200 yards from the firing gun must be protected by one of the methods specified.

*c. Additional range precautions.*—(1) Markers will be placed so as to define clearly the right and left limits of fire.

(2) The starting point of the towing vehicle will be a safe distance on the flank opposite to that on which the target appears.

(3) Vehicles and personnel working on the course will be equipped with red flags and must be directed by definite signals or commands.

(4) There will be a safety officer or noncommissioned officer for each firing gun who will see that the gunner—

(a) Never endangers the target detail.

(b) Never fires outside the prescribed safety limits.

(c) Ceases firing upon command.

(d) Clears his gun and stands away from it before the target detail moves onto the range.

(e) Does not load until the range is clear.

## CHAPTER 6

## ADVICE TO INSTRUCTORS

	Paragraphs
SECTION I. General.....	143-146
II. Mechanical training.....	147-153
III. Training for placing gun in action.....	154-155
IV. Marksmanship.....	156-158
V. Firing at field targets.....	159-160

## SECTION I

## GENERAL

■ 143. **PURPOSE.**—The provisions of this chapter are to be accepted as a guide and will not be considered as having the force of regulations. *They are particularly applicable to emergency conditions when large bodies of troops are being trained under officers and noncommissioned officers who are not thoroughly familiar with approved training methods.*

■ 144. **ASSISTANT INSTRUCTORS.**—When practicable a number of noncommissioned officers and selected privates are given prior instruction in order to act as assistant instructors for the remainder of the organization.

■ 145. **METHOD OF INSTRUCTION.**—The applicatory system of instruction is normally used for instruction in subjects of the nature found in this manual. This system consists of explanation, demonstration, application (practical work), and examination.

*a. Explanation.*—The initial explanation and demonstration of any particular phase of the instruction are presented to the assembled unit by the instructor, assisted by essential demonstration personnel. The general purpose of the entire course or period of instruction should be explained first. The various phases or steps of the course should then be presented in a series of explanations and demonstrations.

*b. Demonstration.*—(1) Demonstrations which are skillfully conceived and executed expedite and simplify instruction as well as stimulate interest. Successful demonstrations are usually short and concise. They leave the student with an exact impression stripped of superfluous details. The demonstrations incident to all subjects should be arranged in progressive sequence, and where practicable should alternate



with practical work to permit the student to fix these successive phases of instruction in his mind.

(2) The men who constitute the demonstration unit should be carefully selected for their intelligence, ability, and appearance. They should be thoroughly trained and rehearsed in the duties they are to perform so that the demonstration will proceed smoothly and illustrate clearly and simply the phase of instruction being presented.

(3) The equipment used for demonstrations should be the best available. A demonstration platform or an area in which the students can be assembled quickly at a position from which they can see and hear every part of the demonstration is essential.

(4) Interest is added and valuable instruction given by repeating demonstrations, including common errors, and requiring the students to detect these errors.

*c. Application (practical work).*—(1) This third step of instruction is of major importance since it gives the student an opportunity to accomplish actually that which has been previously explained and demonstrated.

(2) During the practical work phase of instruction, best results are obtained if the unit is divided into groups. Each group is provided with a set of equipment and placed under the direct supervision of a trained assistant instructor. The group then executes the previously demonstrated phase of instruction, rotating within the groups, until all men have mastered the instruction.

(3) The initial allotment of time and equipment should be made carefully. However, the instructor should not hesitate to alter this allotment if the majority of the men fail to master the instruction within the allotted time or are kept at one exercise to the point of boredom. The frequent rotation of duties within each group is preferable to keeping each man in one position for a long time.

*d. Examination.*—An informal oral or practical examination or critique should be conducted upon completion of each phase of instruction. In addition to the required preliminary gunner's test, the organization commander should conduct such additional examinations as are necessary to assure him that all men have satisfactorily completed the various courses of instruction.

■ 146. ALLOTMENT OF TIME IN TRAINING PROGRAM.—*a.* A total allotment of approximately 218 hours is considered suitable for training a tank unit in the matter contained in this manual. Training in combat fundamentals of the various tank units, squad, platoon, etc., should proceed concurrently with technical instructions. The following apportionment of time is suggested:

<i>Subject</i>	<i>Time allotted (hours)</i>
Mechanical training.....	40
Training for placing gun in action.....	16
Marksmanship.....	74
Technique of fire.....	20
Firing at field targets.....	68

*b.* The above hours may be changed to meet local conditions and the state of training of the men undergoing instruction. If but a small amount of ammunition is made available for firing at field targets, or range facilities are inadequate for firing 37-mm ammunition, the time allotted for field firing should be reduced accordingly and more time devoted to advanced training for placing the gun in action.

## SECTION II

### MECHANICAL TRAINING

■ 147. GENERAL.—*a.* Instruction in mechanical training lends itself readily to the use of the applicatory method of instruction.

*b.* The unit under instruction is divided into groups of four to eight men each. Each group is assembled at the place of instruction with its own gun or set of equipment under the direct supervision of an assistant instructor.

*c.* Instruction is centralized under the unit instructor. The assistant demonstrates each step of the particular phase of instruction as explained by the instructor. For short periods of practical work instruction is decentralized under the assistant instructors.

■ 148. DISASSEMBLING AND ASSEMBLING.—*a.* Men are instructed in the disassembly and assembly of the gun to include only those groups described in paragraph 3.

b. Each man is required to disassemble and assemble each group and give the nomenclature of each part of the group as he handles it.

■ 149. CARE AND CLEANING.—*a.* The various elements of preventive maintenance are explained.

b. The various materials which are authorized for cleaning, lubricating, and preserving the different parts of the gun are exhibited and their use explained.

c. Various parts to be lubricated, kind of lubricant, and schedule for lubrication is discussed. Necessary modifications in this schedule to meet the different conditions under which the equipment is being used should be discussed.

*d.* The method of filling the recoil cylinder as described in paragraph 18 is demonstrated by the instructor.

■ 150. FUNCTIONING.—The use of charts or models to illustrate the functioning of the various groups will facilitate instruction in this subject. *The men should be taught to visualize the functioning of the parts rather than to memorize it.* To accomplish this, the instructor describes the action of one part upon another in its proper sequence as a chain of events proceeding logically from cause to effect.

■ 151. STOPPAGES AND IMMEDIATE ACTIONS.—It is not practicable to prepare actual stoppages without damage to the gun. The instructor should, however, thoroughly explain the causes of different stoppages and how to detect them. The action to be taken for each type of stoppage is explained and the men are required by their group instructor to give similar explanation in their own words calling upon other members of the group for corrections until each has a practical working knowledge of the subject.

■ 152. MOUNTING GUN AND TELESCOPIC SIGHT IN VEHICLE.—See paragraphs 26 to 28, inclusive.

■ 153. ACCESSORIES.—Instruction in the use of accessories is accomplished concurrently with other mechanical instruction.

### SECTION III

#### TRAINING FOR PLACING GUN IN ACTION

■ 154. GENERAL.—The 37-mm gun is mounted in and dismounted from tanks by the Ordnance Department personnel.

**■ 155. ELEMENTARY TRAINING.—a. Method of instruction.—**

(1) When giving instruction in elementary training (drill) for placing the gun in action (ch. 2), demonstrations by a demonstration unit of selected, previously trained men should be used freely. The officer conducting training arranges the individuals or units under instruction so that the demonstration unit can be plainly seen and explains that the demonstration unit will perform each step as he explains them.

(2) Elements (usually tank crews) are then formed with their equipment by assistant instructors who require them to execute the movement or operation demonstrated. Each drill movement is first executed slowly, step by step, until the assistant instructor is satisfied with the performance of each man.

(3) To avoid monotony, periods of instruction in drill should be short and interchanged with other phases of instruction. Games, quickening exercises, and short rests should be interspersed throughout the training. Speed competitions in executing the various drill movements should be used to create interest and encourage teamwork within gun crews.

*b. Repeated changing of telescope during training.—*Since it has a tendency to wear down the bearing surfaces on the telescope and mount, repeated installing and removal of the telescope from the telescope holder should be avoided during elementary drill.

*c. Manipulation of trigger actuator.—*Constant manipulation of the trigger actuator on an empty chamber in true simulation of fire during training for placing the gun in action will not cause damage to any part of the mechanism. This same fact is applicable to preparatory marksmanship and field firing exercises.

**SECTION IV****MARKSMANSHIP**

**■ 156. GENERAL.—a. Marksmanship is the basic step in training the gunner to employ his weapon successfully in combat. A gunner will subconsciously apply in combat the fundamentals he has been taught in marksmanship, hence these fundamentals must be sound. This fact should be kept uppermost in the mind of the instructor and constant effort made**

to eliminate artificialities which tend to creep in for the purpose of obtaining high scores.

b. The procedure used in conducting marksmanship instruction parallels closely that used for mechanical training except that it is of necessity more decentralized. During instruction in the preparatory exercises, the entire unit is initially assembled and attention focused on the instructor and a single demonstration unit. Following the demonstration, the groups move to their individual sets of equipment for practical work under the direct supervision of assistant instructors.

c. Firing exercises on the 1,000-inch range, except for tanks firing on a stationary target, are best conducted under centralized control.

■ 157. PREPARATORY RANGE TRAINING.—*a.* When the range is not available or for short periods in the daily schedule in advance of the regular marksmanship season, many of the preparatory exercises can be conducted on the drill field in the vicinity of barracks. This advance training will expedite the conduct of marksmanship training during the regular season.

b. In the event any of the tracking exercises described in paragraph 74 are conducted, an arrangement of the tanks similar to that described in paragraph 69 should be employed. A sled similar in design to the one used on the 1,000-inch moving target range may be adapted for towing between the line of guns by fastening ropes to both ends. Some of the exercises may have to be modified to meet the lack of facilities normally found on the 1,000-inch range. Hills of dirt similar to those found on the 1,000-inch range may be easily improvised.

■ 158. ORGANIZATION OF WORK.—*a.* Careful thought must be given to allotment of personnel and use of time during marksmanship training.

b. A schedule should be prepared making a specific allotment of time for each step in the training. The progress of the individual man should be watched carefully and recorded to insure that the instruction is progressing satisfactorily and that all men understand the instruction being given. Frequent rotation of duties within each group, with each man performing each phase of an exercise several times, is preferable to keeping one man at one position a long time.

c. When firing on the 1,000-inch range is contemplated, a sufficient number of targets should be prepared well in advance and the necessity for other equipment and spare parts foreseen so that firing need not be stopped because of failure to anticipate needs.

(1) The following is a check list of equipment necessary for training on the 1,000-inch range:

- Target frames and different type targets.
- Target paste and paste brush.
- Pasters (black and white).
- Ammunition, caliber .22.
- Magazines, caliber .22.
- Stop watch.
- Pencils.
- Record of progress.
- Repair tools for guns and range.

(2) Prior to day of firing—

(a) Repair and have in working order all range equipment and apparatus.

(b) Bore sight and check parallelism of each gun to be fired.

(c) Have orders ready for firing.

(d) Have a chart for recording all scores fired.

(e) Check with range officer on availability of range and mark range with safety flags.

d. The prompt publication on a bulletin board of the score made during instruction and record practice will be of great value in stimulating interest and arousing a spirit of competition.

## SECTION V

### FIRING AT FIELD TARGETS

■ 159. CONDUCT OF FIRING EXERCISES.—a. The instructor acts as umpire in all exercises combining the various elements of training to place the gun in action and firing at a towed target (par. 138). He presents the situations, observes execution of the exercise, and conducts the critique.

b. In the early stages of training, value of the instruction may be increased by suspending the exercise and comment-

ing upon errors at the time they are made. As training progresses, an exercise should be permitted to continue regardless of errors. As a general rule, the instructor should interfere as little as possible during the progress of an exercise and allow the tank, section, or platoon commander to solve the requirements in his own way.

c. In all exercises, the time of starting the target on its course is artificial insofar as simulating actual combat conditions are concerned. However, this feature cannot be avoided due mainly to the fact that on most ranges the time required for the target to traverse its course is so short that, if it is released at the start of an exercise, it will have completed its run before the gun crew will have time to engage it. Consequently, the time for releasing the target is specified in each exercise. If desired, this time may be varied to meet local range conditions. It is necessary, however, to coordinate the time of release with the operations at the gun(s).

■ 160. CRITIQUE.—*a.* The basis of good instruction in these exercises is intelligent, tactful, and constructive criticism. The critique should constitute a discussion of each step in the solution of the requirements. It should be given on the ground used for the exercise immediately after the conclusion of the exercise.

*b.* The officer conducting the critique should commend that which was well done and call attention to that which was poorly or incorrectly done. Where errors have been committed, a correct solution should be indicated. In making corrections, the instructor should avoid ridicule, sarcasm, or any remarks which might be harmful to morale or initiative or which might lead to a dread of assuming responsibility in the minds of the men.

*c.* He must be careful not to base his judgment of execution of the exercise too much on effect of the firing. The proper use of fire orders, fire discipline, and fire control must be given due consideration.





## INDEX

	Paragraphs	Pages
Accessories.....	29	46
Instruction in use of.....	60, 153	60, 143
Action:		
Dismounted.....	59	60
Imminent, position of gun for.....	57	59
Not imminent, position of gun.....	56	59
To go out of.....	61	60
Training for placing gun in.....	55, 61	58, 60
Ammunition:		
Authorized rounds.....	40	50
Care, handling, and preservation.....	39	49
Classification.....	32	47
Data card.....	37	49
General description.....	31	47
Identification of.....	34	48
Kinds for combat.....	125	125
Lot number.....	36	48
Mark or model.....	35	48
Packing of.....	41	51
Painting and marking.....	38	49
Assembling.....	7, 148	16, 142
Barrel assembly.....	3	1
Breech ring.....	3	1
Breechblock assembly.....	3	1
Care and cleaning:		
Before, during, and after firing.....	16	27
Before storage.....	21	34
During cold weather.....	20	34
During gas attack.....	19	33
General instruction and scope.....	14	25
In garrison.....	16	27
Materials issued for.....	14	25
Training in.....	149	143
Cessation of fire, combat.....	127	126
Characteristics—		
Of fire.....	100	113
Of weapons.....	1	1
Classes of fire.....	104	115
Construction:		
Caliber .30 or 37-mm moving target firing, known distance.....	97	110
1,000-inch moving target range.....	95	105
Target sled for.....	96	109
Courses, instruction and record firing.....	78, 79, 80	85, 87, 88
Designating targets, methods of.....	114, 115	118, 120
Disabled tank, disabling gun in.....	58	59
Disassembling.....	7, 148	16, 142
Dismounted action data.....	59	60
Elementary training method.....	155	144
Elevating mechanism.....	3	1
Elevation table.....	103	115

INDEX

	Paragraph	Page
Examination, preliminary gunner's.....	76	84
Extractor .....	3	1
Field firing, safety precautions.....	141, 142	139
Field target firing.....	130, 131	128, 129
Conduct of .....	159, 160	146, 147
Equipment .....	133	129
Exercises.....	136, 137, 138	134, 135
Preparatory exercises.....	134, 135	129, 130
Prior training.....	132	129
Ranges for.....	139, 140	136
Safety data.....	141, 142	139
Fire control:		
Adjustment .....	122	123
Chain of .....	121	123
Cruising fire .....	124	125
General scope.....	120	123
Leaving routes.....	123	125
Time of opening fire.....	126	125
Time to cease firing.....	127	126
Fire distribution:		
Engagement of targets.....	118, 119	121, 122
Factors .....	116	120
Subdivision of targets.....	117	120
Fire orders.....	127, 128, 129	126, 127
Firing:		
Cease or suspend.....	61	60
Clear gun.....	61	60
Gun.....	61, 109	60, 116
Out of action.....	61	60
Positions of gun crew.....	61	60
Preparation of gun.....	61	60
Procedure for range.....	88, 89	95, 98
Tables.....	33	48
Unloading .....	61	60
Functioning:		
Basis for instruction in.....	8	20
Closing breech and firing.....	10	21
Cocking .....	9	20
Extraction .....	9	20
Opening breech .....	9	20
Recocking .....	11	23
Recoil mechanism.....	12	23
Safety features.....	13	24
Training .....	150	143
General data and statistics.....	4	15
Immediate action.....	25	36
Individual classification and qualification.....	92	101
Inspection:		
Daily .....	14	25
Before, during, and after firing.....	51	57
Instruction, additional articles for.....	47	56
Instructors, advice on—		
Elementary training.....	155	144
Field firing.....	159, 160	146, 147
Marksmanship.....	156, 157, 158	144, 145
Mechanical training.....	147, 148, 149, 150	142, 143

## INDEX

	Paragraph	Page
Instructors, advice to:		
Allotment of time in training program-----	146	142
Assistants-----	144	140
Methods-----	145	140
Purpose-----	143	140
Lead table-----	74	75
Leading and tracking-----	74	75
Leads-----	111	117
Limitations of fire-----	101	114
Lubrication:		
Marking of fittings-----	17	29
Table-----	17	29
Use-----	17	29
Manipulation of gun-----	72	74
Marksmanship:		
Advice to instructors-----	156	144
Leading and tracking-----	74	75
Method of instruction-----	67	65
Positions-----	71	74
Preparatory training-----	65, 66, 68	65, 67
Prior training-----	64	65
Procedure-----	69	67
Scope-----	63	65
Sighting and aiming exercises-----	70	70
Misfires-----	54	58
Mount, subcaliber-----	43, 44	55
Mounting-----	2, 154	1, 143
Mounts-----	26	38
Opening fire, time of, in combat-----	126	125
Parts, spare-----	30	47
Penetration-----	4	15
Points, to be observed before, during, and after firing-----	22	34
Position of gun:		
Action imminent-----	57	59
Action not imminent-----	56	59
Position of gunner-----	61, 71	60, 74
Precautions:		
Before firing-----	52	57
During firing-----	53	58
During practice firing-----	50	57
Misfires-----	54	58
Safety, individual-----	49, 50, 51, 52, 53	56, 57, 58
Special-----	15	26
Preparatory marksmanship training:		
Aiming-----	73	75
Equipment for instruction-----	68	67
Examination-----	76	84
Leading and tracking-----	74	75
Manipulation-----	72	74
Method of instruction-----	67	65
Positions-----	71	74
Procedure-----	69	67
Scope-----	65, 66	65
Sighting and aiming exercises-----	70	70

INDEX

	Paragraph	Page
Preparatory range training:		
Advice to instructors.....	157, 158	145
Record of progress.....	75	84
Range:		
Determination .....	106, 107, 108	116
Field firing at towed targets.....	140	136
Firing:		
Ammunition.....	86	95
Equipment.....	84	94
Targeting gun.....	85	95
Safety precautions.....	83	93
Practice:		
Courses.....	78, 79, 80	85, 87, 88
Duties of personnel.....	82	89
Personnel to fire and rules.....	77	85
Recoil cylinder filling.....	18	32
Record firing:		
Examination for proficiency before.....	76	84
Practice rules and procedure.....	89	98
Rule for stoppages, misfire, and malfunction.....	90	99
Computation of scores.....	91	100
Individual qualification.....	92	101
Record practice, scoring.....	91	100
Safety:		
Features of firing mechanism.....	13	24
Individual precautions during practice firing.....	50, 52, 53	57, 58
Inspection, before and after firing.....	51	57
Precautions, 37-mm range.....	141, 142	139
Service of piece.....	61	60
Shield.....	3	1
Sight, telescopic.....	5, 28	16, 41
Sighting and aiming, definition and exercises.....	70	70
Sleigh and recoil mechanism.....	3	1
Stoppages:		
Causes.....	24	35
Definition.....	23	35
Immediate action, training in.....	151	143
In record firing.....	90	99
Prevention.....	24	35
Subcaliber:		
Equipment.....	42	55
Mount.....	43	55
To install mount.....	44	55
To install subcaliber rifle in subcaliber mount.....	45	56
To remove subcaliber rifle.....	46	56
Targeting the gun.....	28	41
Targets:		
Aiming.....	93	102
Combat, engagement of.....	118, 119	121, 122
Designation:		
General.....	112	117
Methods of.....	114	118
Preliminary training for.....	113	118
Touch signal.....	115	120
For firing.....	87	95

## INDEX

	Paragraph	Page
Targets—Continued:		
Marksmanship -----	94	102
Sled -----	96	109
Speeds -----	110	117
Technique of fire:		
Definition -----	98	113
Limitations of gun -----	101	114
Scope -----	99	113
Training:		
Installation of accessories to gun -----	60	60
Placing gun in action -----	61, 155	60, 144
Program, allotment of time -----	146	142
Trajectory -----	102	115
Traveling lock -----	3	1
Traversing mechanism -----	3	1
Trigger actuator -----	3	1
Weight:		
Complete round -----	4	15
Gun -----	4	15
Projectile -----	4	15

