

WAR DEPARTMENT

MHI

Copy 3

BASIC FIELD MANUAL

37-MM GUN, TANK, M6
(MOUNTED IN TANKS)

April 8, 1942

FILE DO NOT REMOVE

*Rec. letter from
Army School Force
1 Oct 1942*

OFFICIAL COPY

RETURN TO

RECEIVED SECTION

BASIC FIELD MANUAL

37-MM GUN, TANK, M6 (MOUNTED IN TANKS)

CHANGES }
No. 3 }

WAR DEPARTMENT,
WASHINGTON, November 2, 1942.

FM 23-81, April 3, 1942, is changed as follows:

■ 5. FIRING PIN AND GUIDE ASSEMBLY.

* * * * *

b. Disassembly of firing pin guide assembly (to be disassembled only when absolutely necessary).—Press the prongs of the firing spring stop into the guide and, using the 37-mm combination tool, drive out the guide pin from the forward end of the firing pin guide. With a screw driver * * * firing pin stop.

c. Assembly.—Replace the stop * * * firing pin to the front. Screw the firing pin into the guide as far as it will go, hold the prongs of the stop into the firing pin, and then back the firing pin out until the holes of the pin and guide are alined. Drive in the guide pin until it is just flush on both sides of the guide. Release the pressure on the firing spring stop. Be careful not to injure the guide when removing or replacing the guide pin.

* * * * *

[A. G. 062.11 (10-7-42).] (C 3, Nov. 2, 1942.)

■ 6. BREECBLOCK.—*a. Removal from gun.*—Actuate the trigger. Remove * * * right hand under it. With the left hand remove the closing spring locking pin. Lower the breechblock and then remove the lever arm shaft. Remove the crank assembly and the breechblock together from the breech ring. Disengage the crank trunnions from the T-slot.

* * * * *

d. To replace breechblock in gun.—Rotate the upper arms of the extractors fully forward. Insert trunnions of crank in the T-slot upper arm of the crank to the right, and replace crank assembly and breechblock into the breech ring, keeping the cocking lever up and pointing to the rear. Support the breechblock with the right hand. Rotate the crank into position

in line with the holes in the breech ring lugs. Support the breechblock in a partially lowered position, and insert the lever arm shaft into the holes in the breech ring and the crank assembly. Secure the lever * * * allow the block to close.

[A. G. 062.11 (10-7-42).] (C 3, Nov. 2, 1942.)

■ 7. CLOSING SPRING AND HOUSING.—*a. Disassembly.*—(1) *Method.*—Remove the left guard from the gun. Remove the breechblock. Level the gun and remove the coupler key by using a screw driver and the proper wrench. Slide the barrel far enough to the rear to permit removal of the closing spring housing. Unscrew the closing spring housing. Compress the closing spring * * * retainer, and closing spring.

* * * * *

b. Assembly.—Replace the closing spring * * * onto the housing body. Slide barrel forward and replace coupler key. Replace left guard.

[A. G. 062.11 (10-7-42).] (C 3, Nov. 2, 1942.)

■ 8. FIRING AND EXTRACTING MECHANISM GROUP OF BREECH RING (with breechblock removed).—*a. Disassembly.*

* * * * *

(3) *Trigger* (not to be removed from gun except when absolutely necessary).—Remove the left guard from the gun. Level the gun and remove the coupler key by using a screw driver and the proper wrench. Slide the barrel * * * plunger and spring.

* * * * *

[A. G. 062.11 (10-7-42).] (C 3, Nov. 2, 1942.)

■ 36 (Superseded). ADJUSTMENT OF SIGHTS.—*a. Telescopic sight M19.*—For field and combat firing the telescopic sight M19 is adjusted so that the line of sight through the zero range dot and the axis of the bore are parallel. All spare sights must be adjusted.

(1) *Adjustment by use of testing target.*—(a) Place tank on fairly level ground.

(b) Place the testing target (fig. 13) at least 80 feet from the gun.

(c) Place the muzzle sight (fig. 12) in the muzzle so that the bar of the muzzle sight, that is, the straight side of the triangles, is even with the horizontal marking on the muzzle of the gun. Open the breech, look through the tube, and manipulate the gun until the testing target can be seen. Insert the breech sight about 2 inches into the chamber.

(d) Have the testing target moved until it is perpendicular to the axis of the bore. Sight through the peep hole; manipulate the gun until the space between the points of the triangles of the muzzle is on the center of the gun target of the testing target. Have the testing target rotated in a plane perpendicular to the axis of the bore, until the bar coincides with the line AB . Now rotate the muzzle sight until the edge of the bar coincides with the vertical marks on the muzzle of the gun. Move the testing target until the edge of the bar coincides with the line CD .

(e) Without disturbing the gun, manipulate the sight until the zero range dot is at the intersection of the lines $A'B'$ and $C'D'$. Check to see that the vertical line of dots coincides with the line $C'D'$. If they do not, realine the gun on its part of the testing target and readjust the sight.

(f) If bore sights are not available, stretch thin strings across the muzzle using the horizontal and vertical marks on the muzzle to center them. Remove the firing pin guide assembly and use the hole in the breechblock bushing as a peep sight.

(2) *Use of distant aiming point.*—Select a distant aiming point at least 1,000 yards from the gun. If possible, select an object such as a building, smokestack, or lone tree. With bore sights (fig. 12) or by means of strings as described above, lay the gun on the aiming point making use of horizontal and vertical edges to assure accurate aiming. Do not aim on centers of trees or buildings. Adjust sight on the same aiming point as described above.

b. M5A1 telescopic sight.—Since this sight has only one horizontal cross hair, this cross hair should be adjusted to give a range setting between 600 and 800 yards. Adjust the sight as in *a* above, using the intersection of the cross hair as the zero range point. Then lower the line of sight 5 mils by raising the rear of the sight by means of the sight adjustment screw. Depending

on the ammunition being fired, this will give approximately the following range settings: Shot, TP M51 (w/o windshield) (2,450 ft./sec. muzzle velocity) 600 yards; shell, HE M63 (2,600 ft./sec. muzzle velocity) 700 yards; shot APC M51 (2900 ft./sec. muzzle velocity) 800 yards.

c. Adjustment for 1,000-inch range firing.—(1) For 1,000-inch range firing, the abnormally short range and the miniature target make it necessary to give a nonparallel relation between the line of sighting and the center line (axis) of the gun. The instructor should explain the reason for this artificial distortion of the line of sighting; he should point out that on a life-size target at a proper range for service ammunition the line of sighting and center line of the gun should always be parallel; and should also show how the distortion used on the 1,000-inch range would cause increasingly great errors if the gun were aimed at more distant targets.

(2) For firing on the 1,000-inch range, both the M19 and the M5A1 telescopic sights are adjusted so that the line through the zero range of the sight and the center of impact coincide at 1,000 inches. On a target 1,000 inches distant, fire one round. Center a black paster over the shot hole. Without disturbing the laying of the gun, adjust the sight so the zero range dot or the intersection of the cross hairs, whichever sight is used, is on the center of the paster. Fire a confirming round on another paster.

[A. G. 062.11 (10-7-42).] (C 3, Nov. 2, 1942.)

BY ORDER OF THE SECRETARY OF WAR.

G. C. MARSHALL,

Chief of Staff.

OFFICIAL:

J. A. ULIO,

Major General,

The Adjutant General.

FM 23-81

BASIC FIELD MANUAL

**37-MM GUN, TANK, M6
(MOUNTED IN TANKS)**



**UNITED STATES
GOVERNMENT PRINTING OFFICE
WASHINGTON : 1942**

WAR DEPARTMENT,
WASHINGTON, April 3, 1942.

FM 23-81, 37-mm Gun, Tank, M6 (Mounted in Tanks), is published for the information and guidance of all concerned.

[A. G. 062.11 (1-2-42).]

BY ORDER OF THE SECRETARY OF WAR:

G. C. MARSHALL,
Chief of Staff.

OFFICIAL:

J. A. ULIO,
Major General.
The Adjutant General.

DISTRIBUTION:

D 2, 7, 17 (8); R 17 (10); Bn 9 (2), 17 (5); C 9 (2), 17 (5); IC 17 (20).

(For explanation of symbols see FM 21-6.)

TABLE OF CONTENTS

	Paragraphs	Page
CHAPTER 1. MECHANICAL TRAINING.		
SECTION I. Characteristics and description	1-3	1
II. Disassembly and assembly.....	4-9	14
III. Functioning.....	10-21	18
IV. Care and cleaning of gun, mount, and spare parts.....	22-31	23
V. Stoppages and immediate action.....	32-33	33
VI. Mounts and sights.....	34-36	35
VII. Power traverse.....	37-38	43
VIII. Accessories and spare parts.....	39-40	43
IX. Ammunition.....	41-46	45
X. Individual safety precautions.....	47-51	51
CHAPTER 2. TRAINING FOR PUTTING GUN IN ACTION.	52-54	53
CHAPTER 3. MARKSMANSHIP.		
SECTION I. General	55-57	57
II. Preparatory marksmanship.....	58-63	58
III. Preliminary gunner's examination.....	64	66
IV. Range practice, including qualifica- tion courses.....	65-68	67
V. Conduct of range practice, includ- ing record practice and individual safety precautions.....	69-85	70
CHAPTER 4. TECHNIQUE OF FIRE.		
SECTION I. General	86-87	89
II. Characteristics and classes of fire.....	88-89	89
III. Terrain features and their relation to targets.....	90-91	90
IV. Types of targets and ammunition to be used on each.....	92-93	90
V. Range determination.....	94-96	92
VI. Target speeds.....	97-98	93
VII. Target designation.....	99-104	94
VIII. Fire distribution, adjustment, con- trol, and orders.....	105-108	97
CHAPTER 5. COMBAT FIRING PRACTICE.	109-113	105
CHAPTER 6. ADVICE TO INSTRUCTORS.		
SECTION I. General	114-117	112
II. Mechanical training.....	118-124	113
III. Training for placing gun in action.....	125-128	114
IV. Marksmanship	129-131	114
V. Combat firing practice.....	132-133	116
INDEX		118

BASIC FIELD MANUAL

37-MM GUN, TANK, M6 (MOUNTED IN TANKS)

(This manual supersedes so much of section I, Training Circular No. 39, War Department, 1941, as pertains to FM 23-81.)

CHAPTER 1

MECHANICAL TRAINING

	Paragraphs
SECTION I. Characteristics and description.....	1-3
II. Disassembly and assembly.....	4-9
III. Functioning.....	10-21
IV. Care and cleaning of gun, mount, and spare parts..	22-31
V. Stoppages and immediate action.....	32-33
VI. Mounts and sights.....	34-36
VII. Power traverse.....	37-38
VIII. Accessories and spare parts.....	39-40
IX. Ammunition.....	41-46
X. Individual safety precautions.....	47-51

SECTION I

CHARACTERISTICS AND DESCRIPTION

■ 1. DESCRIPTION.—*a. General.*—(1) *Comparison with M5 gun.*—The 37-mm tank gun M6 is a flat trajectory weapon of the field gun type similar to the M5 gun described in FM 23-80. It fires projectiles which weigh about 2 pounds. The main features distinguishing the M6 gun from the M5 is that it has a longer barrel, the breechblock is operated automatically, and the mount is provided with a breech operating mechanism.

(2) *Interchanging of tubes of M5 and M6, 37-mm tank guns, is prohibited.*—Although the tubes are mechanically interchangeable, the M5 gun is 3½ calibers shorter than the M6 and when assembled in the M6 breech mechanism gives an undesirable breech preponderance. The model number of each gun is stamped on the top of the tube about mid-length.

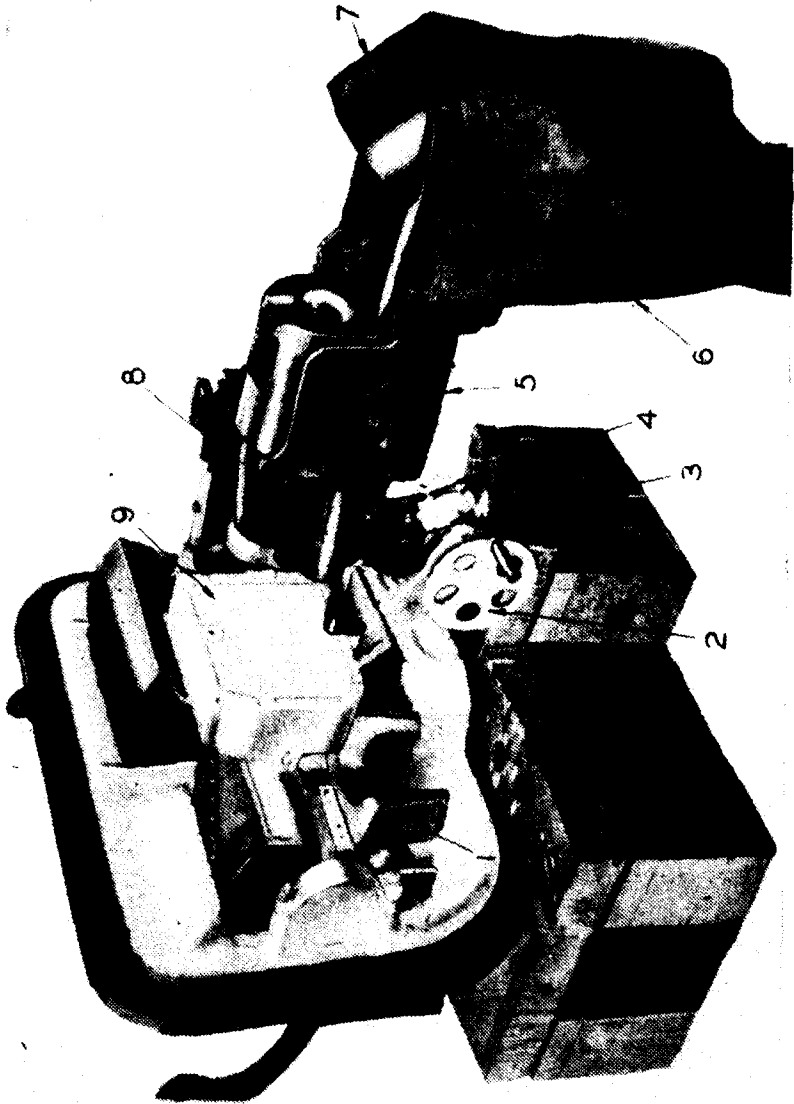

- | | |
|---------------------------------|----------------------------------|
| 1. Sight recess. | 6. Empty case bag. |
| 2. Elevating handwheel. | 7. Empty case deflector. |
| 3. Solenoid firing device. | 8. Closing spring housing. |
| 4. Trigger actuating mechanism. | 9. Machine-gun ammunition chest. |
| 5. Left guard. | |

FIGURE 1.—37-mm tank gun M6 in M24 mount, left side view.

NOTE.—This mount allows for changes in elevation only. Changes in traverse are obtained by rotating the turret.

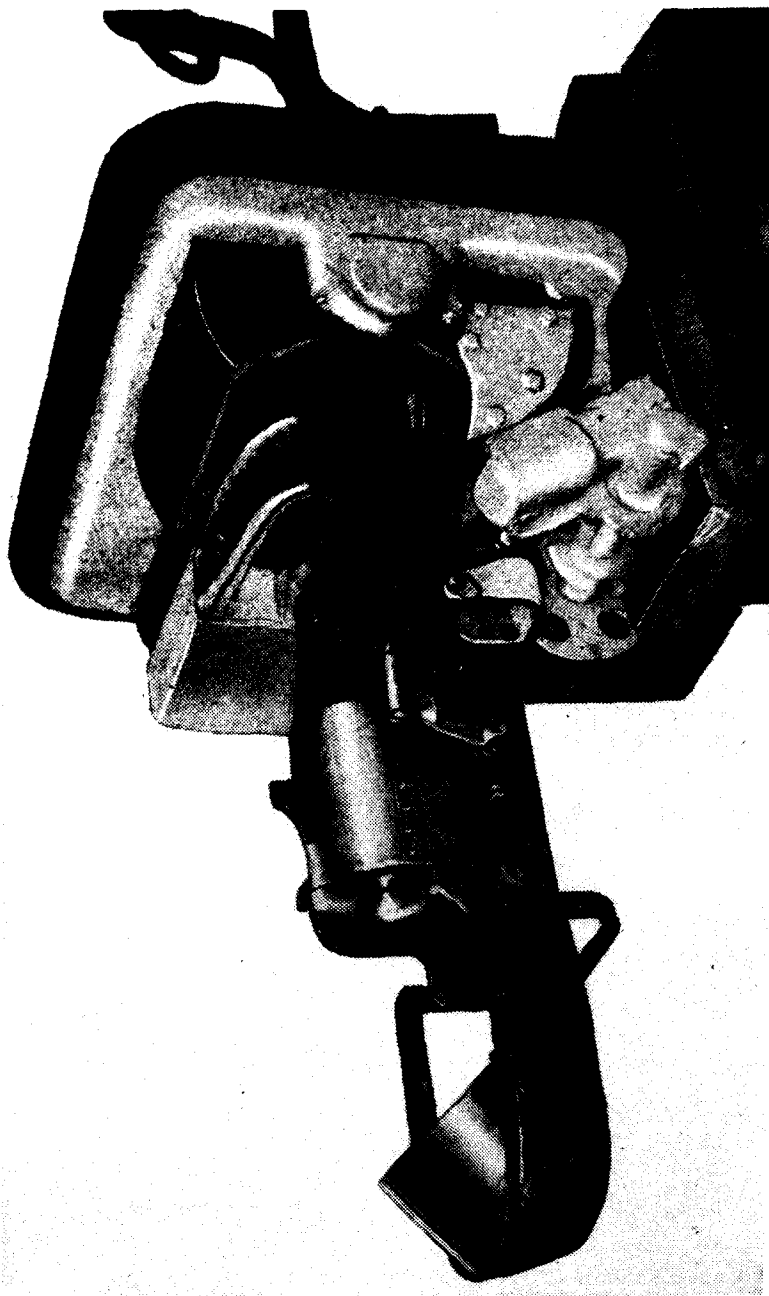
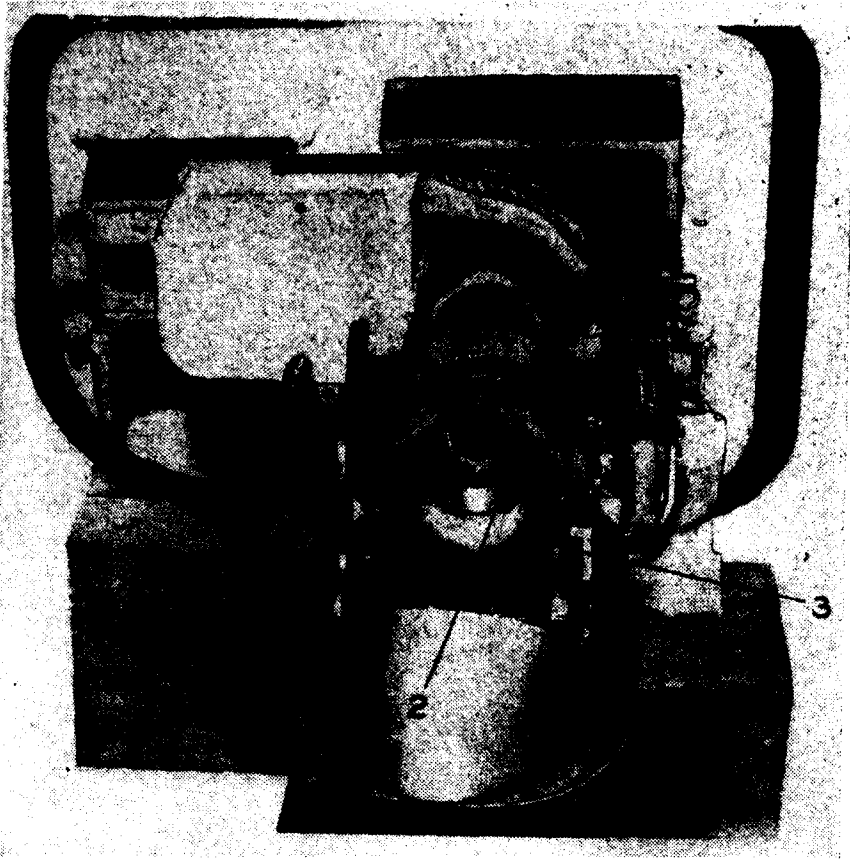

FIGURE 2.—37-mm tank gun M6 in mount M24, right side view.



1. Left guard. 3. Breech operating mechanism.
 2. Breechblock recess.

FIGURE 3.—37-mm tank gun M6 in M24 mount, rear view.

b. Mounting.—The type of mount used with the gun depends upon the type of tank in which the gun is mounted and the position within the tank. When the gun is mounted in the turret of tanks having manually operated turret only, the mount is designed to permit elevating and some traversing independent of the turret. When the gun is mounted in the turret of tanks having power operated turrets, the mount permits elevating but all traverse is by the turret.

c. Barrel assembly.—The barrel assembly consists of the following principal parts:

(1) *Barrel*.—(a) The barrel is a one-piece forging with rifled bore threaded to screw into the breech ring. There are two bearings, one near the breech end and one at mid-length that support the barrel and align it in the yokes of the sleigh. The front bearing has a flange at the rear and is threaded for a lock nut to secure the position. Keyways in the right and left rim of the flange engage keys in the yoke to prevent rotation of the barrel.

(b) The lower part of breech ring is recessed on each side of the bore to form extractor pockets. The lower part of each pocket has been drilled to hold the extractor springs and plungers.

(2) *Breech ring*.—(a) The breech ring is bored and threaded in front to receive the barrel and is secured to the barrel by a locking key. Holes bored in the lugs on the bottom of the breech ring provide means for attaching the breech ring to the recoil mechanism and the lever arm shaft. The rear hole is for the lever arm shaft.

(b) The rear half of the breech ring is slotted vertically to receive the breechblock. The rear of the breech ring is U-shaped to facilitate loading (see fig. 3). The cylindrical studs inside the ring serve as extractor pivots. The hole through the lower left wall forms the trigger bearing and a counterbore inside provides a pocket for the tripper.

(c) A breech operating mechanism containing the operating cam and guide is bolted to a pad located on the right side of the recoil cylinder (see fig. 3).

(d) The closing spring housing is attached to the left forward end of the breech ring.

(3) *Extractors*.—The extractors are positioned against the side walls of the breech recess. The lips of the longer upper arms lie in pockets on each side of the chamber and engage the flange of the cartridge. Camming lugs on the lower arms project inward to engage the cammed surface of the breechblock. (See fig. 4.) The camming lugs being held to the front by the extractor plunger springs lock the breechblock in the open position by engaging the locking studs on the face of the breechblock. Two holes in the rear face of the breech ring contain the extractor springs and plungers.

(4) *Breechblock assembly* (figs. 4 and 5).—(a) The

breechblock assembly consists of the breechblock, bushing, and firing spring retainer pin. The large center hole in the breechblock houses the firing pin guide assembly. The breechblock bushing is screwed into the forward end of the hole and machined off. The firing spring retainer pin and the interrupted shoulder inside the hole form a joint to hold the firing spring retainer and prevent rotation. Grooves in the hole receive and guide the cocking and sear lugs of the firing pin guide.

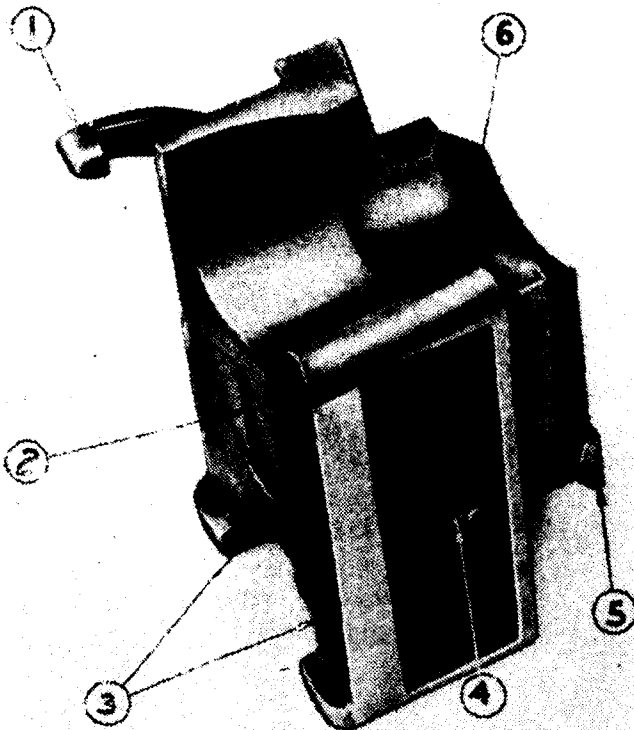

- | | |
|-------------------------------|------------------|
| 1. Cocking lever. | 4. Sear pin. |
| 2. Firing pin guide retainer. | 5. Locking lug. |
| 3. T-slots. | 6. Beveled face. |

FIGURE 4.--Breechblock.

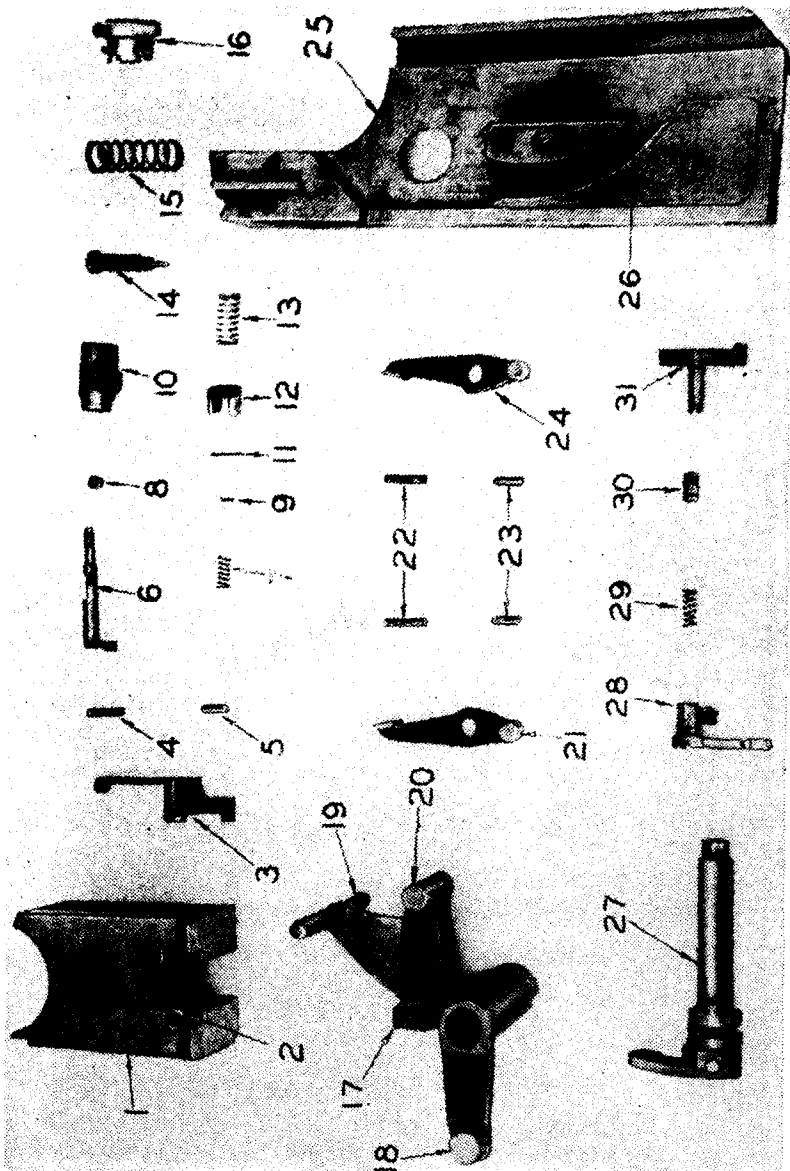

- | | | |
|----------------------------------|------------------------|---------------------------------|
| 1. Breechblock. | 11. Guide pin. | 23. Extractor plungers. |
| 2. T-slot. | 12. Stop. | 24. Extractor, right. |
| 3. Cocking lever. | 13. Retracting spring. | 25. Breech operating mechanism. |
| 4. Cocking lever plunger spring. | 14. Firing pin. | 26. Breech operating cam. |
| 5. Cocking lever plunger. | 15. Firing spring. | 27. Lever arm shaft. |
| 6. Sear. | 16. Retainer. | 28. Trigger. |
| 7. Sear spring. | 17. Crank. | 29. Trigger spring. |
| 8. Sear retaining lock. | 18. Operating lug. | 30. Trigger plunger. |
| 9. Sear pin. | 19. T-handle. | 31. Tripper. |
| 10. Guide. | 20. Trunnion. | |
| | 21. Extractor, left. | |
| | 22. Extractor springs. | |

FIGURE 5.—Breechblock assembly; firing pin and guide assembly, crank, extractors, and breech operating mechanism.



FIGURE 6.--Cutaway showing firing and operating mechanism.

- | | |
|-----------------------------|--------------------------------------|
| 1. Closing spring. | 16. Breechblock bushing. |
| 2. Closing spring housing. | 17. Firing pin. |
| 3. Closing spring nut. | 18. Firing spring. |
| 4. Closing spring rod. | 19. Firing pin retracting spring. |
| 5. Link pin. | 20. Firing spring retainer. |
| 6. Lever arm shaft link. | 21. Breechblock. |
| 7. Closing spring lock pin. | 22. Cocking lever. |
| 8. Lever arm shaft. | 23. Cocking lever plunger
spring. |
| 9. Trigger. | 24. Cocking lever plunger. |
| 10. Operating lug. | 25. Breech ring. |
| 11. Operating cam. | 26. Stop. |
| 12. Crank trunnion. | 27. Guide. |
| 13. Upper arm of tripper. | 28. Coupler key and nuts. |
| 14. Sear. | |
| 15. Sear lug. | |

(b) The bottom of the breechblock is cut from front to rear by a T-slot which inclines downward to the rear. The crank trunnions slide in the T-slot to raise and lower the breechblock. The top of the block is U-shaped to guide the shell into the chamber and has a beveled surface to force the shell home as the block rises. A hole with a slot for the sear arm is on the left side of the block; it houses and guides the sear and sear spring. The upper left side of the block is recessed to receive the cocking lever. A hole in the rear face of this recess houses the cocking lever plunger and spring. Portions of the right and left sides of the breechblock have been cut away to reduce weight. Locking studs are provided on the breechblock face to hold the breechblock in the open position. Two stopping lugs on the rear base of the breechblock stop its upper movement.

(5) *Firing mechanism.*

(a)

1. The firing spring bears rearward on the retainer and forward on the stop.
2. The sear is notched for engagement of the sear lug of the guide. The sear passes through the breechblock horizontally, perpendicular to the guide and the sear and spring are secured by a pin.
3. The cocking lever pin pivots in a hole in the upper left side of the breechblock. The upper arm projects upward and rearward from the block and terminates above the rear wall of the breech ring. The lower arm extends forward and downward, terminating in a lug which engages and forces the

firing pin guide rearward to cock the mechanism. A plunger and spring return the lever to position as the upper end is released.

(b) The tripper, trigger, trigger plunger, and spring are supported in the breech ring.

1. The tripper is within the breech ring. The operating arm of the tripper extends upward and carries a cam surface for actuating the sear. The lower arm of the tripper carries a horizontal safety lug, which in the idle position of the trigger and tripper, extends inward below and forward of the left lower edge of the breechblock. Lowering the block places this shoulder behind the lug of the tripper and prevents actuation when the breech is open. The trigger is mounted on the tripper hub.

2. The trigger consists of a tapered arm with a hollow cylindrical hub; the hub enters a hole in the breech ring. The trigger plunger and spring which are seated in the cheek of the breech ring retain the trigger in position and return it to a forward position after firing.

d. Sleigh and recoil mechanism.—(1) *Recoil mechanism.*—The recoil cylinder houses the recoil mechanism and is assembled with the trunnion pins which are mounted in the trunnions of the yoke.

(2) *Recoil cylinder.*—The recoil cylinder is provided with rails which guide the sleigh during the movement of the gun. The gun and the piston rod of the recoil mechanism are connected by a coupler and coupler pin. A shoulder guard is also bolted to the recoil cylinder.

(3) *Sleigh.*—The sleigh is of built-up steel construction and mounts the gun barrel in yokes.

(4) *Trunnions.*—The trunnions are made in two halves, doweled to each side of the recoil cylinder and locked by a screw.

(5) *Recoil system.*—The recoil system is the hydrospring type. It includes the recoil mechanism, which absorbs the recoiling energy of the gun after it is fired; the counterrecoil mechanism, which returns the gun into battery; and the

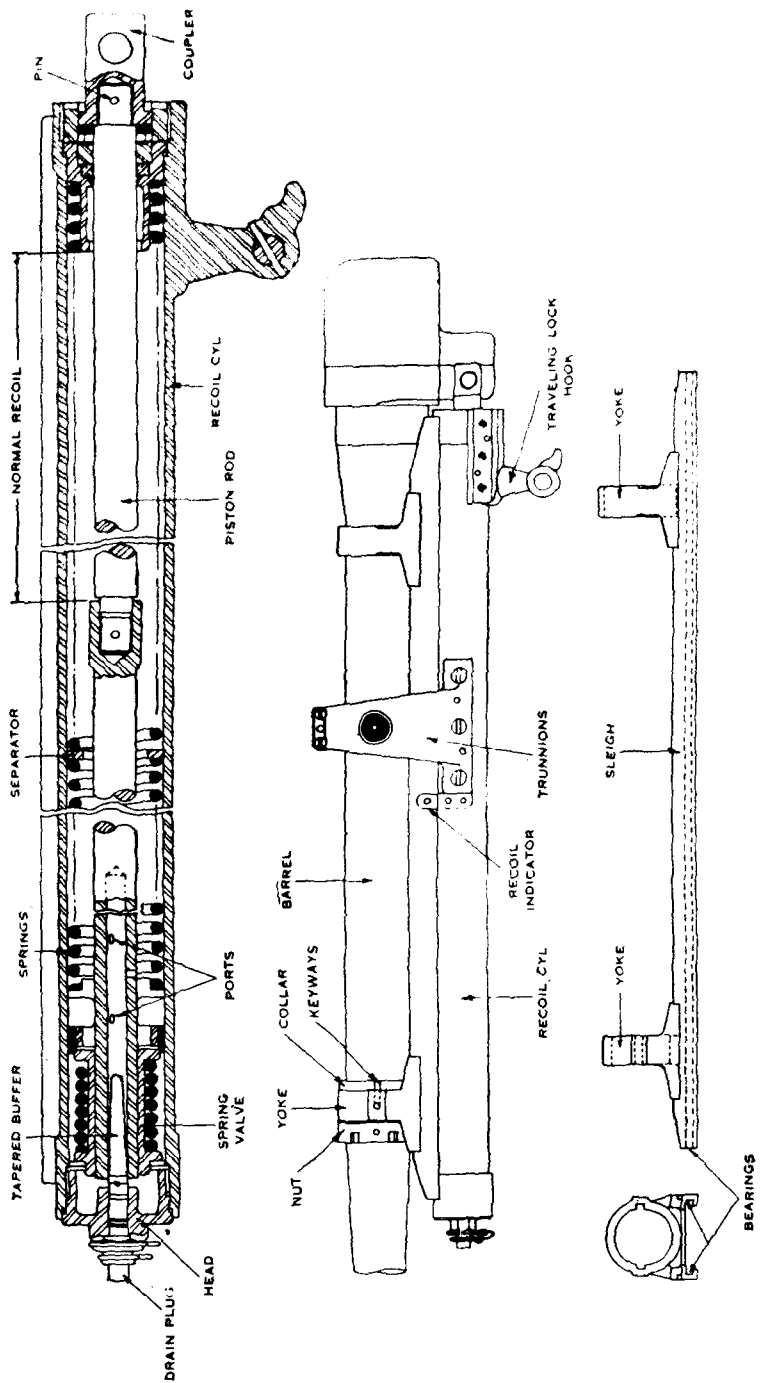

FIGURE 7.—Recoil mechanism.

buffer mechanism which absorbs the last portion of the counterrecoil action to prevent damage to the weapon due to sudden stopping of the movement of the recoil parts.

e. Elevating mechanism.—(1) Adjustment of the gun in elevation is transmitted from the handwheel to the barrel by a shaft and a system of gears (see fig. 1).

(2) For quick adjustment of the gun in elevation, the worm gear drive is equipped with a throw-out lever which disengages the gear drive and permits free movement of the gun. This release mechanism is actuated by pulling out (to the right) the throw-out release handle spring actuated lock and pushing the throw-out handle forward to its farthest position. To reengage the gears and lock the gun to the elevating mechanism pull out (to the right) the throw-out release handle spring actuated lock and pull the throw-out handle to the rear. It locks in the rearmost recess when the worm gear segment and sector gear are positively engaged.

f. Traversing mechanism.—(1) In tanks equipped with power traverse mechanism the gun is fixed in the mount and traverse is obtained by rotating the turret. This is accomplished as described in paragraph 38. The power traverse turret may also be manually operated.

(2) In tanks equipped with manually operated turrets only, the gun can be traversed 10° right and left from the center by means of a knob and swivel shaft to the traversing bar. The traversing knob lock when tightened locks the gun for traverse. When the gun is not locked for traverse the friction of the gears is such that either free movement of the gun may be obtained for traverse or adjustment may be made by means of the traversing knob. When traverse of the gun beyond the traverse permitted by the mount is necessary, the turret must be rotated or the tank turned in direction.

g. Trigger actuator.—(1) In tanks equipped with power traverse mechanism the gun is fired electrically by a solenoid firing device connected with the trigger. The solenoid firing device is actuated by a switch on the power traversing lever. A forefinger safety lever on the control grip must also be depressed to fire the gun. The gun may be fired by manual

operation of the trigger actuator mechanism. (See (2)(b) below.)

(2) In tanks not equipped with a power traverse mechanism two means of firing the gun are provided in the form of two types of trigger actuators:

(a) The first consists of a trigger actuator assembled into the hub of the elevating wheel and consists of a plunger button, spring cable, actuator plunger, and with or without a trigger lever.

(b) The second consists of a trigger bar pivoted at approximately the center in a bracket affixed to the base of the recoil cylinder, the left end of which engages directly with the actuator plunger. It consists of a bar, pivot pin, and retracting spring.

h. Shield.—The shield varies in design and thickness with the mount used. It is attached to the yoke and recoil cylinders by bolts or, in some tanks, direct to the turret.

i. Traveling lock.—The traveling lock is hinged by means of bolts to a bracket mounted inside the turret. In the traveling position it is fastened to a bracket on the recoil cylinder. In order to prevent undue wear on the elevating mechanism, whenever the gun is not being operated, the elevating worm gear should be disengaged from the gear sector and the traveling lock engaged. When the gun is to be used the lock should be in the raised position in the turret top.

j. Spent case deflector and bag.—The spent case deflector is bolted to the recoil cylinder and has suspended from it a bag to receive the spent cases.

■ 2. GENERAL DATA.

Total weight of gun (approx.)	700 pounds.
Length of barrel	78 inches.
Traverse (manually operated turret)	10° L to 10° R.
Elevation	-10° to +20°.
Length of recoil	6 to 8 inches.
Capacity recoil cylinder	5 pints.

■ 3. AMMUNITION AND SIGHTS.—See paragraph 35 and section IX.

SECTION II

DISASSEMBLY AND ASSEMBLY

■ 4. GENERAL.—*a.* The disassembling and assembling described herein can, unless otherwise noted, be done with the gun mounted in the tank. Any disassembly or assembly not described in the following paragraphs is a function of ordnance personnel only.

b. All members of the tank crew must be taught to disassemble and assemble the various groups of the gun as described in the following paragraphs. *This instruction must include disassembling and assembling with the gunner blindfolded.*

■ 5. FIRING PIN AND GUIDE ASSEMBLY.—*a. Removal from breechblock.*—The firing pin and guide assembly may be removed from the breechblock with the block either in or out of the gun. Close the breechblock and actuate the trigger or if the breechblock has been removed from the gun, place it with the firing pin guide retainer toward the operator and retainer slot in vertical position. With the right hand press the retainer into the breechblock about $\frac{1}{8}$ inch and rotate it either way one-quarter of a turn (rotate slot to the horizontal position). Release the pressure and remove the retainer and the firing spring. Cup the left hand over the recess in the rear of the breechblock and with the right hand rotate the cocking lever forward smartly. The firing pin guide assembly will be ejected.

b. Disassembly of firing pin guide assembly (to be disassembled only when absolutely necessary).—Using the 37-mm combination tool, drive out the guide pin from the forward end of the firing pin guide. With a screw driver unscrew the firing pin from the guide and remove the firing pin, retracting spring, and firing spring stop.

c. Assembly.—Replace the stop into the guide with the prongs protruding through the forward end of the guide. Place the retracting spring onto the firing pin and insert the firing pin and retracting spring into the guide with the striker end of the firing pin to the front. Screw the firing pin into the guide as far as it will go and then back it off

just enough to clear the hole for the guide pin. Drive in the guide pin until it is just flush on both sides of the guide. Be careful not to injure the guide when removing or replacing the guide pin.

d. To replace.—Insert the firing pin guide assembly into the firing pin guide chamber in the breechblock. Make sure the sear lug on the bottom of the guide is down (the sear lug is cut off at an angle) and the stop is to the front. Hold the trigger to the rear (push the trigger bar forward) and push the firing pin guide assembly forward until the prongs of the stop strike the breechblock bushing. Release the trigger. Insert the firing spring into the guide. Place the cupped end of the retainer over the rear end of the firing spring, keeping the slot on the rear face of the retainer horizontal. Press the retainer into the face of the breechblock about $\frac{1}{8}$ inch and rotate it until the slot is in the vertical position; then release the pressure.

■ **6. BREECHBLOCK.**—*a. Removal from gun.*—Actuate the trigger. Remove firing pin and guide assembly (par. 5a). Pull down on the crank until the hole in the closing spring rod coincides with the hole in the housing body. Insert a retaining pin in these holes to hold the closing spring rod. Support the breechblock by placing the right hand under it. With the left hand remove the closing spring locking pin and then the lever arm shaft. Withdraw the crank and remove the breechblock.

b. Disassembly.—(1) *Cocking lever.*—Insert the index finger of the left hand between the apron of the cocking lever and the nose of the cocking lever plunger. Depress the plunger and at the same time remove the cocking lever with the right hand. Be careful not to let the plunger or spring fly out of the breechblock. Release the plunger and remove it and the spring.

(2) *Sear and sear spring.*—Place the breechblock with the front face down. Press the arm of the sear into its recess as far as it will go and remove the sear retaining lock and washer. Release the pressure and withdraw the sear and sear spring.

c. Assembly.—(1) *Sear and sear spring.*—Place the sear spring over the small end of the sear and insert the sear

and sear spring into the sear recess in the breechblock. Align the arm of the sear with the slot and press the sear into its recess as far as it will go. Replace the sear retaining lock and washer. Release the pressure on the sear spring.

(2) *Cocking lever.*—Insert the cocking lever plunger spring into its hole in the top of the recess in the left side of the breechblock. Press the cocking lever plunger into the hole, flat end against the spring. With the index finger of the left hand depress the cocking lever plunger and, at the same time, with the right hand replace the cocking lever in its recess, short arm of the lever down. Release the pressure.

d. To replace breechblock in gun.—Rotate the upper arms of the extractors fully forward. Start the breechblock into its recess in the bottom of the breech ring keeping the cocking lever up and pointing to the rear. Support the breechblock with the right hand. Insert the crank trunnions in the T-slots in the bottom of the breechblock, upper arm of the crank to the right. Rotate the crank into position in line with the holes in the breech ring lugs. Insert the lever arm shaft into the holes in the breech ring and the crank. Secure the lever arm to the link by inserting the closing spring rod. Release the T-handle and allow the breech to close. To test the operation of the breechblock pull down on the T-handle until the breechblock is opened and locked. Press forward on the tips of the extractors with the base of a shell case to unlock the breechblock and allow the block to close.

■ 7. CLOSING SPRING AND HOUSING.—*a. Disassembly.*—(1) *Method.*—Remove the breechblock. Unscrew the closing spring housing. Compress the closing spring slightly to enable another operator to remove the retaining pin. Gradually release the pressure. Remove the closing spring assembly. Unscrew the housing body screw and remove the housing body and the housing body pin. Remove the lever arm shaft link pin, the link, the retainer, and closing spring.

(2) *Alternate method.*—To remove the closing spring without removing its housing, remove the breechblock and reinsert the crank, lever arm shaft, and closing spring lock pin. Push down on the operating lug until the hole in the closing spring rod is in line with the hole in the housing. Insert a retain-

ing pin through both these holes. Release the operating lug and remove the closing spring lock pin. Remove the retaining pin and push the closing spring assembly out the front of the housing.

NOTE.—The closing spring and housing will be removed and disassembled only in case of necessity.

b. Assembly.—Replace the closing spring and closing spring retainer on the closing spring rod. Attach the lever arm shaft link by means of the link pin. Attach the housing body to the breech ring by means of the dovetail connection and the housing body pin. Screw in the housing body screw. Insert the closing spring assembly into the housing body with the lever arm shaft link first. Compress the closing spring sufficiently to enable another operator to insert a retaining pin through the centered holes of the housing body and the closing spring rod. Connect the lever arm shaft and link by means of the closing spring lock pin. Remove the retaining pin and screw the housing onto the housing body.

■ 8. **FIRING AND EXTRACTING MECHANISM GROUP OF BREECH RING** (with breechblock removed).—*a. Disassembly.*—(1) *Extractors.*—Rotate the extractors to a vertical position and remove them from their pivots. The extractor spring plungers and extractor springs are removed by ordnance personnel only.

(2) *Tripper.*—Reach into the breech recess from below, grasp the tripper with the fingers and withdraw it from the trigger hub.

(3) *Trigger* (not to be removed from gun except when absolutely necessary).—When necessary to clear the trigger from the recoil guard, level the gun and remove the coupler pin by using a screw driver and the proper wrench. Slide the barrel back to between the apron and the trigger plunger and press the plunger rearward to free the lug on the trigger apron. Hold the plunger depressed and remove the trigger to the left. Release the pressure on the plunger and remove the plunger and spring.

b. Assembly.—(1) *Trigger.*—Replace the trigger spring and plunger and press the trigger plunger to the rear, slide the trigger hub into the hole at the top of the notch until the shoulder contacts the cheek of the breech ring. Release the

plunger. Slide the barrel to the forward position and replace the coupler pin.

(2) *Tripper*.—Insert the shaft of the tripper into the hub of the trigger with the short arm vertical. Slide the tripper shaft through until the flattened end of the shaft enters the slot in the trigger hub and the short arm of the tripper enters its recess inside the breech ring.

(3) *Extractors*.—Keeping the lips of the extractor up and to the front, engage the shoulders of the extractor in the extractor plunger. While forcing the plunger in against the action of the extractor spring, slide the extractor onto the pivot.

■ 9. TO DISASSEMBLE TRIGGER ACTUATOR ASSEMBLY.—*a. On tanks not equipped with solenoid firing device*.—(1) Disconnect the cable of the 37-mm trigger actuating mechanism from its housing (left side of gun mount), by loosening the Allen setscrew in the trigger actuating housing using the $\frac{1}{16}$ -inch Allen setscrew wrench. Remove the end of the cable from the housing.

(2) Remove the two cap screws (using $\frac{1}{2}$ -inch box wrench) holding the trigger actuating housing to the body of the shoulder rest. Remove the recoil cylinder cross head bolt (using $\frac{15}{16}$ -inch wrench on nut). Pull the gun tube to the rear about 6 inches and remove the trigger actuating housing to the right (under the gun tube).

NOTE.—Normally the trigger actuator assembly will be disassembled only to the extent required to attach the trigger cable.

b. On tanks equipped with solenoid firing device.—On tanks equipped with solenoid firing devices, extra devices will be carried and tank crews will be permitted to replace these only.

c. To assemble 37-mm trigger actuator.—Proceed in reverse order of disassembling.

SECTION III

FUNCTIONING

■ 10. GENERAL.—*a.* The enlisted man should have a working knowledge of the mechanical operation of the gun so that he will be able to keep it in action during combat. Although

many parts of the gun operate simultaneously, the subject of functioning is divided into phases to facilitate instruction. The explanation of mechanical functioning begins with the assumption that the gun is unloaded and breechblock open.

b. The breech mechanism of the gun is designed to be either operated by hand or automatically opened by the force of recoil.

■ 11. **FIRST PHASE—LOADING.**—As a round is inserted into the gun chamber the cartridge rim strikes the lips of the extractors and rotates them forward into the pockets in the breech face of the tube. At the same time, the lower arms of the extractors are disengaged from the breechblock and the block moves up to the closed position under action of the closing spring. With the breech closed, the lower arm of the cocking lever projects forward clear of the cocking lug on the guide.

■ 12. **SECOND PHASE—ACTION OF TRIGGER ACTUATOR.**—*a. On tanks having disk plunger on traversing handwheel.*—A push on the button in the center of the traversing handwheel moves the cable, through its flexible housing, so as to force the actuator plunger to the rear. The actuator plunger contacts the lower portion of the trigger arm and moves the trigger to the rear. Upon release of the disk plunger, the actuator plunger spring forces the actuator plunger to return to its forward position.

b. On tanks having solenoid firing device.—When the safety trigger on the pistol grip control of the power traversing system is pressed, the toggle firing switch (thumb button switch on some tanks) may be closed. When the switch is closed the solenoid firing device, through linkage causes the trigger arm to rotate to the rear.

■ 13. **THIRD PHASE—TRIGGER ACTION.**—As the lower arm of the trigger is forced to the rear, the trigger hub operating on the tripper shaft, moves the upper arm of the tripper forward. As the tripper arm moves forward it forces the sear to the right until the sear notch is in line with the sear lug on the firing pin guide and the sear lug can then move forward through the sear notch.

■ 14. **FOURTH PHASE—OPERATION OF FIRING PIN GUIDE ASSEMBLY.**—The firing spring being compressed between the base of the stop and the retainer, forces the firing pin guide assembly forward. The prongs of the stop strike the breechblock bushing and stop the action of the firing spring. The firing pin and guide, since they are locked together by the guide pin, continue forward under inertia to strike the primer and fire the piece. During this movement the retracting spring is being compressed between the base of the stop and the head of the firing pin. The striker end of the firing pin strikes the primer and stops the forward movement of the guide just before it contacts the breechblock bushing. The retracting spring which has been compressed then retracts the guide and firing pin to their normal position with the firing pin point flush with, or slightly in rear of, the front face of the breechblock.

■ 15. **FIFTH PHASE—BACKWARD MOVEMENT OF BARREL ASSEMBLY.**—The action of the powder gases on the breechblock at the moment of discharge causes the recoil of the barrel assembly and drives it rearward about 8 inches. The recoil is resisted, its speed regulated, and the movement stopped by the action of the recoil mechanism which is attached to the barrel assembly by the coupler and coupler pin. As the piston head in the recoil cylinder moves to the rear with the piston rod, two forces resist the movement, the two counterrecoil springs are compressed and the movement of the piston head is resisted by the oil in the cylinder. The oil follows two courses as it flows to the front of the piston head:

a. It forces the piston valve back against the resistance of the piston valve spring and flows through the holes in the piston head which are uncovered as the valve moves away from the piston.

b. It passes through the ports, thence through the hollow portion of the forward end of the piston rod and out around the tapered buffer. As the barrel assembly moves backward the piston rod moves away from the tapered buffer (which is gradually opened) thus the oil is restricted greatly at the instant of discharge and restricted less and less as the barrel assembly moves to the maximum length of recoil. The com-

ination of the resistance of the counterrecoil springs and the restriction of the oil stops the rearward movement of the barrel assembly at the maximum recoil without appreciable shock to the gun.

c. As the barrel assembly moves to the rear, the lower arm of the trigger is forced to the front by action of the trigger spring and plunger. This motion of the trigger causes the upper arm of the tripper to move to the rear, withdrawing the safety lug on the lower arm of the tripper from under the lower surface of the breechblock, thus permitting the breechblock to open. A bevel surface on the lower left guide of the breechblock also forces the tripper forward should the trigger spring be broken.

■ 16. SIXTH PHASE—AUTOMATIC OPENING OF BREECH.—During recoil the lug on the right-hand side of the crank is cammed in the crank cam of the breech operating mechanism. This movement causes the trunnions of the crank to slide downward in the T-slot to open the breech. As the crank rotates, the lever arm which is keyed to the crank rotates to the rear and brings with it the link and the closing spring rod and compresses the closing spring. The downward movement of the breechblock is stopped by the impact of the stop surface of the crank hub on the shoulders of the breechblock ring.

■ 17. SEVENTH PHASE—ACTION OF EXTRACTORS.—As the breechblock nears its lowermost position, the cam shoulders on the front face of the breechblock contact the round cams on the lower ends of the two extractors. This imparts a sharp rearward throw to the extractor lips on the upper arm of the extractor. Since the extractor lips are behind the rim of the shell, the case is extracted from the chamber and ejected clear of the breech end of the gun. The breech is then open ready for loading. The camming lugs on the bottom of the extractors are held to the front by the extractor spring plungers and lock the breechblock in the open position by engaging the locking studs on the face of the breechblock.

■ 18. EIGHTH PHASE—COCKING ACTION.—As the cocking lever is carried down with the breechblock, the projecting arm of the cocking lever is forced forward by the cam surface

inside the rear wall of the breech recess. The lower arm is rotated rearward to engage the cocking lug on the firing pin guide and to move the guide toward the rear. This rearward movement of the firing pin guide assembly compresses the firing spring sufficiently to permit the engagement of the sear. (As the guide is moved to the rear, the sear lug cams the sear to the right. When the sear lug clears the sear, the sear springs to the left and in front of the sear lug under the action of the sear spring and holds the firing pin guide assembly to the rear in the cocked position.)

■ 19. NINTH PHASE—FORWARD MOVEMENT OF RECOILING PARTS.—*a.* Recoil being stopped, the recoiling parts are instantly moved forward by the action of the compressed counterrecoil springs against the piston bracket. The piston valve, by the action of the valve spring, closes the holes in the piston head as the counterrecoil starts. The oil has only one course to follow through the hollow end of the piston rod and the ports in its walls to the rear of the piston head.

b. The added restriction during the counterrecoil causes the barrel assembly to move slowly back into the battery.

c. The final movement is stopped by the action of the counterrecoil buffer entering the hollow end of the piston rod. The counterrecoil buffer, due to its tapered construction, progressively closes the hollow portion of the piston rod through which the oil must flow. This action throttles the flow of oil and permits the gun to return to battery without appreciable shock.

■ 20. RECOCKING.—The firing mechanism can be cocked without opening the breech, by rotating the projecting arm of the cocking lever forward and releasing it.

■ 21. SAFETY FEATURES OF FIRING MECHANISM.—*a. Tripper.*—(1) As the breechblock is lowered, the left shoulder of the block passes immediately to the rear of the safety lug on the lower arm of the tripper, thus preventing the operation of the tripper and holding the trigger in the forward position until the breech is closed.

(2) When the breechblock starts to open the bevel on the front of the lower left guide forces the tripper forward if it has not already been forced forward by the action of the trigger spring and trigger.

b. Locking lever.—The offset lower arm of the cocking lever engages the cocking lug of the guide early in the downward movement of the breechblock and remains in the path of this lug until the block is returned to approximately its closed position. This eliminates the possibility of having the firing pin move forward to strike the cartridge due to the premature release of the sear or other failure on the part of sear to hold the mechanism cocked until the breech is fully closed.

c. Alinement of firing pin.—As the breechblock is lowered it carries the firing pin down with it, thus the firing pin will not be alined with the primer of the shell except when the breech is fully closed.

SECTION IV

CARE AND CLEANING OF GUN, MOUNT, AND SPARE PARTS

■ 22. GENERAL CARE.—*a.* Laxity in proper care and maintenance will soon result in deterioration to the extent of appreciably reducing the accuracy and dependability of the gun. It must always be kept clean and covered with a light coat of oil. Care and cleaning is not confined to the gun alone but includes the mount, spare parts, and all accessories. Ammunition must be kept clean and dry. Guns mounted in vehicles should be locked in the traveling position unless their early use is anticipated. Muzzle covers are provided to prevent dirt from entering the gun through the bore. Detailed information pertaining to cleaning, preserving, and lubrication materials and their authorized use will be found in TM 9-850. The use of materials other than those authorized for the purpose mentioned is strictly forbidden. Dirt and grit which accumulate on the gun and mount and in the operating mechanism while traveling, and from the blast of the piece in firing, settle on the bearing surfaces. This

dirt and grit in combination with the lubricant form a grinding compound. Powder fouling attracts moisture and hastens the formation of rust. Therefore, whenever possible, as during lulls in combat, clean the gun as soon as practicable after firing. Dirt on nonbearing surfaces can usually be removed by water. Lubricated or other greasy parts must be cleaned with a dry-cleaning solvent applied with a rag. The procedure in cleaning the bore, chamber, and breech ring is covered in paragraph 24. The following materials are issued by the Ordnance Department for use in the field (see SNL K-1):

(1) *Soda ash (dehydrated sal soda)*.—This is used for cleaning the bore, breech mechanism, and firing mechanism after firing.

(2) *Dry-cleaning solvent*.—This is used for removing grease. It is preferred to kerosene because it does not leave a corrosive film. The use of gasoline is prohibited because it is too inflammable.

(3) *Crocus cloth*.—This is the coarsest abrasive permitted for cleaning mist and stain from bearing surfaces.

(4) *Emery cloth*.—This is used in cleaning unfinished or nonbearing surfaces only. It is issued in 5° of coarseness, of which "00" is the finest.

(5) *Burlap, jute*.—This is issued for cleaning the bore.

(6) *Cotton waste, clean rags, and sponges*.—These are for general cleaning purposes.

b. Tank commanders are responsible for the daily inspection of the 37-mm guns and immediately take the proper action necessary to keep the gun in excellent condition.

■ 23. SPECIAL PRECAUTIONS.—The following precautions should be taken in the use and operation of the gun:

a. Remove the firing pin guide assembly before removing the breechblock.

b. Do not put a strain on the recoil guard or shoulder rest while getting into or out of the vehicle.

c. Do not put unnecessary strain on the actuator or solenoid cables.

d. Lock the gun in the traveling position unless early use is contemplated.

e. Do not attempt to open the breechblock while actuating the trigger.

f. Do not fire the gun before the recoil tube has been checked for the proper amount of recoil oil.

g. Do not jam the gears at maximum and minimum elevating points.

h. Do not disconnect the worm gear sector without supporting the breech end of the gun.

i. If the firing device fails to fire make certain the gun is not set on safety. Jiggle it slightly.

j. Do not load the gun until use is contemplated.

k. Do not leave a live round in the chamber of a hot gun.

l. Inspect to see that gun is unloaded before placing it in the traveling position.

m. The precautions for coaxially mounted machine gun are as given in FM 23-50.

■ 24. CARE AND CLEANING.—*a. Garrison.*—The exterior parts should be protected with a film of oil after every drill. The gun will be thoroughly cleaned and protected at least once a week and immediately following its use in inclement weather. For garrison cleaning the procedure indicated for care and cleaning after firing in *d* below, should be followed except that the bore and chamber will not be swabbed with water or soda ash solution but will be cleaned with a dry rag and then oiled. If, upon inspection, no corrosion is detected, a coating of rust-preventive compound (cosmic) may be placed in the bore and chamber instead of light oil.

b. Before drill or firing.—Before drill or firing, the gun is inspected for proper functioning, lubrication, and cleanliness. When firing is contemplated the recoil cylinder is checked for proper amount of oil (see par. 26). All mechanism, particularly trigger actuator, and other exposed surfaces are cleaned and oiled as necessary, and are manually tested to insure proper functioning.

c. During firing.—The bore and chamber should be swabbed frequently. The breech, firing and trigger actuator mechanism, and other exposed surfaces are cleaned and oiled as necessary.

d. After firing.—(1) *General.*—As soon as practicable after firing, the bore, chamber, breech ring, breechblock, firing mechanism, and trigger actuator should be cleaned and oiled. The recoil cylinder should be filled and the guides of the sleigh and rails of the recoil cylinder cleaned and oiled if necessary.

(2) *Bore, chamber, and breech ring.*—After removing the breechblock and firing mechanism in the breech ring, thoroughly sluice and sponge the bore and chamber with a solution of $\frac{1}{2}$ pound of soda ash in 1 gallon of water, or hot water and issue soap, hot water alone, or in the absence of these with cold water. Then swab the bore and chamber with dry waste or rags until they are perfectly dry. Inspect the bore and chamber for any remaining residue. If they are not clean, repeat the swabbing and drying. A small piece of burlap jute used as a patch over the end of the brush of the rammer is effective for cleaning the bore. When all powder fouling has been removed, dry the bore and chamber thoroughly and cover with a light coat of lubricating oil. Whenever the soda ash solution is used for cleaning, all of the parts cleaned should be swabbed or rinsed with clear water and dried before oiling. It is of particular importance, when using a cleaning process like the one described above, that all parts and surfaces, recesses, etc., be thoroughly dried before they are oiled. The parts of the firing mechanism removed from the breech ring and the interior of the breech ring should be cleaned with a dry rag and then wiped with an oily rag. Apply one or two drops of oil to the closing spring.

(3) *Breechblock.*—Having removed the breechblock from the breech ring, disassemble it. With a dry rag clean the dirt and oil from the block and all parts contained therein. Lubricate all recesses for moving parts with light oil. With an oily rag wipe the breechblock and all other parts of the firing mechanism leaving a thin coating of oil.

(4) *Trigger actuating mechanism.*—The solenoid and piston should be cleaned. All exposed and accessible parts of the trigger actuator mechanism extending arm should be thor-

oroughly cleaned and oiled. Dry-cleaning solvent will assist materially. This mechanism is particularly vulnerable to mud and dust accumulated while traveling or during action and unless given careful and detailed care will fail to operate freely.

(5) *Outer surfaces of gun.*—Clean the outer surfaces, using damp rag or dry-cleaning solvent when necessary, then dry and wipe all exposed metal parts with an oily rag. Do not apply oil to painted surfaces. Oil collects dirt and grit and makes daily cleaning more difficult.

■ 25. LUBRICATION.—*a.* Excessive wear can be prevented by keeping the matériel clean and well lubricated. The life of the matériel depends on proper lubrication. Particular attention should be given to sliding and bearing surfaces of the cradle and breech mechanism.

b. Lubricating oils and greases as shown in the lubrication chart must be used as prescribed. No lubricants other than those prescribed will be used without the authority of the Ordnance Department. (See lubrication chart on following pages.)

c. Lubricating fittings will be painted red for ease in locating. Oilholes are encircled by a red ring.

d. The oil gun should be worked slowly and the parts oiled should be maneuvered to insure proper distribution of the lubricant.

e. Should an oiler valve stick and prevent the passage of the oil, it may be loosened with a piece of wire pushed through the hole. Care should be taken not to damage the valve.

f. Care must be taken when cleaning oil and grease compartments to insure the complete removal of all residue or sediment. Dirt or other foreign matter should not be allowed to drop into any of the lubricating compartments.

LUBRICATION CHART.

Parts lubricated (name)	No.	Frequency		Method of application
		Miles	Time	
*Traversing mechanism:				
Traversing gears (open)	}		Daily	Oiler
Traversing rack				
*Elevating mechanism:				
Elevating gears (open)			do	do
Elevating rack			do	do
Trigger actuator			do	do
Elevating gears (M24) (inclosed)			Monthly	Hand
Cradle:				
Recoil rails				Oiler
Sleigh guides			Daily	do
Trunnion bearings	1			Oil cup
Gun:				
Bore			Daily	(See remarks)
Firing mechanism, cable bushing.	1		Monthly	Grease fittings
Firing mechanism, breechblock and ring.			Daily	Oiler
Miscellaneous:				
Pintle pins (top and bottom)	2			Oil cups
Exposed friction points and bearing surfaces.			Daily	Oiler

*In general where lubrication is required and not mentioned in this chart, the

1. *Antifriction bearings.*—Pack bearings with grease, O. D., No. 0.
2. *Journal bearings.*—Clean and lubricate with the above described oils.
3. *Exposed gears, racks, etc.*—Clean and lubricate with the above described oils.
4. *Sealed gear cases.*—Clean and fill with the above described oils.

■ 26. **FILLING RECOIL CYLINDER.**—*a.* The recoil cylinder must be kept filled in accordance with the following instructions or damage to the gun will probably result. The Ordnance Department will furnish the proper grade of oil for the recoil cylinder—oil, recoil, heavy, low pour-point. The substitution of any filler other than that issued by the Ordnance Department is prohibited.

37-mm tank gun, M6

Required lubricants		Amount	Remarks
Below 32° F.	Above 32° F.		
SAE 10	SAE 30	Light film	Clean and lubricate daily.
do	do	do	Do.
Grease O. D., No. 0		Light coating	Coat on assembly.
SAE 10	SAE 30	Light film	} Avoid waste.
		do	
Fill			
do	do	Light film	For care and cleaning, follow prescribed instructions in par. 24.
Grease, O. D., No. 0		Several turns on grease gun.	Test frequently. Clean and lubricate.
SAE 10	SAE 30	Light film	
		Fill	
SAE 10	SAE 30	Light film	} Avoid waste. Make sure no heavy grease is on the firing pin guide.

Following procedure will apply:

b. The amount of oil in the recoil cylinder should be such that the movement of the gun in recoil is smooth and of uniformly decreasing velocity, and the maximum point of recoil is reached without shock; the counterrecoil mechanism will then return the gun completely to battery without shock. Too rapid recoil, and shock at the end of recoil is usually caused by too little oil in the recoil cylinder. Failure to

return completely to battery is usually caused by too much oil in the recoil cylinder or may be due to lack of lubrication or the presence of foreign matter on the guides or rails.

c. To fill the recoil cylinder proceed as follows:

(1) Elevate the muzzle slightly.

(2) Fill the oil gun with oil. When filling, keep the nozzle well under the surface of the oil supply to avoid drawing in air. After filling, point the nozzle upward, push the piston until the oil starts to flow in order to force out any air in the oil gun.

(3) Remove the front (filler) plug and screw the nozzle of the oil gun into position in its stead, keeping a slight pressure on the oil gun piston as the oil gun is being seated.

(4) Remove the rear plug in the right side of the recoil cylinder.

(5) Introduce the oil into the recoil cylinder by slowly pushing on the piston of the oil gun until the oil flows out of the rear hole.

(6) Fully depress the muzzle (approximately 10°) and continue to slowly force oil through the cylinder and out of the rear hole until no more bubbles emerge with the oil.

(7) Screw in the rear plug tightly.

(8) Fully elevate the muzzle, unscrew the oil gun, and replace the front plug.

d. The filling of the recoil mechanism should be carefully done to insure that all air has been "bled off" and that the mechanism is completely full. The presence of air can be detected by "air bubbles" appearing in the oil. After completing the above filling process, it is sometimes found necessary to drain off a small amount of oil from the recoil cylinder. This establishes a "void" which compensates for an expansion of the oil during firing. If draining is found necessary, elevate the muzzle slightly and unscrew (crack) the rear filler plug sufficiently to permit about one tablespoonful of oil to flow out. The amount of oil in the mechanism should be such that the gun returns completely into battery and does not end the action of recoil with any appreciable jar.

e. Excess oil used during filling should be caught in a clean receptacle and must be strained through a clean cloth before being used again.

■ 27. PROTECTION AND CLEANING OF MATERIAL AFFECTED BY GAS.—*a. Protection against phosgene, chlorine, and other nonvesicants.*—(1) For material which is in constant danger of gas attacks, whether from gas clouds or gas shells, care should be taken to keep all bright parts of the gun, mountings, and accessories well coated with oil.

(2) All bright parts of guns and mounts, together with all accessories and spare parts exposed to the gas, must be cleaned and wiped dry as soon as possible after the attack, and in any case within 24 hours, after which they should be thoroughly coated afresh with oil. The same applies to contaminated ammunition. Ammunition which for any reason has not been oiled must be cleaned and oiled.

(3) Sights and all instruments should also be covered with oil and protected with covers when not in actual use, care being taken that the oil does not come in contact with any glass or find its way into the interior of the instruments.

(4) All uncapped fuzes or fuzes which have been removed from their containers should be wiped over with oil as soon as possible and protected with a cover.

b. Protection against mustard and other vesicant gases.—It must be remembered that practically all fabrics and material such as wool, cotton, rubber, and oilcloth can be penetrated by mustard gas if exposed to it a sufficient length of time. Mustard gas is absorbed by these materials and penetrates them by a slow process of diffusion. In general, it may be said that the greater the length of time allowed for penetration, the greater the danger in wearing these articles. For instance, rubber boots which have been worn in an area shelled heavily with mustard gas may be a grave danger to men who wear them several days after the bombardment. Fabrics thoroughly impregnated with boiled linseed oil will resist penetration by mustard gas over an hour, but after this time these articles are dangerous because the mustard gas dissolves in the linseed oil and they must be destroyed.

■ 28. DISINFECTION OF MATERIAL AFFECTED BY MUSTARD AND OTHER VESICANT GASES.—The following measures should be taken for the removal of gas from various materials and equipment (weapons, projectiles, cases, wood, metals, rope, etc.) which have come in contact with mustard gas. For all

of the operations indicated below, the gas mask and protective clothing, including protective shoes and gloves, must be worn.

a. Commence by freeing the objects of dirt, excess grease, and liquid with wooden spatulas and rags.

b. Swab the gun, mountings, and accessories with rags saturated in kerosene. If kerosene is not available, gasoline may be used but extreme care must be exercised to avoid possibility of it becoming ignited.

c. Spray the parts with a solution of noncorrosive decontaminating agent, using the 1½-quart or 3-gallon decontaminating apparatus. After 15 minutes, wash this off with soap and water, wipe dry, and apply a thin layer of oil. Bury, or preferably burn, all rags and wooden spatulas used in the process, at the same time insuring that no personnel are in the immediate vicinity downwind.

d. Alternate methods employ a solution of bleaching powder, hot sodium sulfide, or "green solution" in place of the non-corrosive decontaminating agent. For further information on decontamination, see FM 21-40.

■ 29. CARE DURING COLD WEATHER.—In cold weather, the gun mechanism should be tested frequently by hand manipulation to insure that it is functioning properly.

■ 30. CARE AND CLEANING FOR STORAGE.—If the weapon is to be stored or if climatic conditions are conducive to the formation of rust, thoroughly clean all parts and inspect for the presence of corrosion. If no corrosion is present, cover all exposed metal surfaces thoroughly with a coating of rust-preventive compound.

■ 31. POINTS TO BE OBSERVED BEFORE, DURING, AND AFTER FIRING.—a. *Before firing.*—(1) See that bore is clear and clean and remove excess oil.

(2) See that working parts of the gun are clean, oiled, and functioning smoothly.

(3) See that the telescopic sight is clamped firmly and headrest adjusted.

(4) Secure sufficient supply of ammunition.

(5) Check position of body and make sure no one is in the path of recoiling parts.

(6) Load when directed.

b. During firing.—(1) Observe the functioning of the gun to anticipate failures and lubricate working parts when necessary.

(2) Check bore and chamber for obstructions.

(3) Continually check the functioning of the recoil.

c. After firing.—(1) Clear gun.

(2) Disassemble the breech. Clean and oil the parts carefully to prevent rust.

(3) Swab the bore, with hot water and soda ash when possible, immediately after firing, then dry thoroughly and protect with a light coating of oil.

(4) Upon assembling, check the operation, insuring that the gun is functioning properly.

(5) Release the firing spring by pressing the trigger.

(6) Dismount the telescopic sight (where applicable), clean thoroughly.

(7) At first opportunity inspect all parts and make needed repairs.

(8) Replenish ammunition when directed.

SECTION V

STOPPAGES AND IMMEDIATE ACTION

■ 32. GENERAL.—*a.* A stoppage is cessation of fire caused by the malfunction of the gun or ammunition.

b. Immediate action is the procedure used to promptly reduce a stoppage.

c. Most stoppages are prevented by proper care and cleaning of gun and ammunition.

■ 33. STOPPAGES, THEIR CAUSES, AND IMMEDIATE ACTION.—*a.* *Gun fails to fire.*—(1) *Causes.*—(*a.*) Gun on safety or safety switch not pressed.

(*b.*) Gun fails to return completely to battery.

(*c.*) Breechblock fails to close.

(*d.*) Defective trigger actuator mechanism, or defective solenoid or switch.

(*e.*) Broken or bent trigger arm.

(*f.*) Broken, bent, or burred firing pin.

(*g.*) Weak or broken firing spring.

(*h.*) Dirty or defective sear.

- (i) Weak or broken sear spring.
- (j) Dirty sear lug or firing pin guide.
- (k) Dirty firing pin and guide assembly.
- (l) Lack of lubrication.
- (m) Defective ammunition.

(2) *Immediate action.*—(a) Check to see if the gun is on safety. If it is, take it off safety, relay, and fire.

(b) Gun is not on safety. Check to see if the gun has returned to battery. If it has not, push it into battery by hand, relay, and fire. If the gun cannot be pushed into battery, unload, check recoil cylinders for proper amount of oil. Drain out about a teaspoonful if necessary. If gun still will not return to battery, check slides and guides for burrs, dirt, and lack of lubrication. Clean, remove burrs, lubricate, reload, relay, and fire. If the burrs cannot be removed turn the gun over to the ordnance for repair. (The gun may be continued in action by pushing it into battery each time. It should be checked and repaired at the first opportunity.)

(c) *Gun is in battery.*—Check to see if breechblock has closed. If breechblock has not closed—

1. Close it manually, relay, and fire.
2. If it will not close, see if ammunition is seated. If ammunition will not seat, remove round, reload, relay, and fire. If ammunition still will not seat, clean chamber, reload, relay, and fire.
3. Ammunition is seated. Check for broken or worn extractor, replace as necessary. Check for broken or weak closing spring. Adjust or replace as necessary. Clean and lubricate bearing surfaces of breechblock as necessary.

(d) Breechblock is closed. Recock the piece.

1. If cocking action shows that the piece is still cocked (indicated by no resistance other than the cocking lever spring to be overcome) examine for bent or broken trigger arm and for malfunction of trigger actuator mechanism. Replace parts as necessary, relay, and fire. If trigger mechanism is not defective, remove firing mechanism and check for weak or broken firing spring.

2. If cocking action indicates that the firing pin guide sear lug has been released from the sear (indicated by heavy resistance to cocking action), relay and fire. If gun still fails to fire after twice repeating this action, *after 2 minutes* remove firing pin and guide, clean, lubricate, replace defective parts, re-cock, relay, and fire.
3. If gun still fails to fire, wait *2 minutes*, unload, load with a new round, relay, and fire.
4. If cocking action shows that the firing pin guide sear lug will not remain engaged in the sear, after *2 minutes* unload, disassemble breechblock, clean and replace defective parts.

b. Failure to feed.—(1) *Causes.*—(a) Defective or dirty ammunition.

(b) Dirty chamber.

(c) Round loaded with insufficient force to trip extractor.

(2) *Immediate action.*—See a(2)(c) 2 above.

c. Failure to extract.—(1) *Causes.*—(a) Defective ammunition.

(b) Dirty chamber.

(c) Broken or worn extractor.

(2) *Immediate action.*—Pry out empty case by inserting a sharp tool in front of the flange of the case or drive it out by inserting a cleaning staff in the muzzle of the gun. Clean the chamber. Examine extractors and replace as necessary.

d. Failure of breechblock to stay open.—(1) *Causes.*—(a) Broken or worn extractor.

(b) Broken or weak extractor plunger springs.

(2) *Immediate action.*—See a(2) above.

SECTION VI

MOUNTS AND SIGHTS

34. **MOUNTS.**—The M24 mount as shown in figures 1 and 3 is the mount used for the 37-mm tank gun M6 mounted in the M3 medium tank. The mount is attached to the turret. A machine gun, caliber .30, HB, M1919A4, is mounted coaxially with the 37-mm gun. The machine gun may be mounted and dismounted by the tank crew. The 37-mm

gun is mounted and dismounted by ordnance personnel only. The modified M22 mount will be used in the light tank.

■ 35. SIGHTS AND HOW MOUNTED.—Two types of sights are furnished for the 37-mm tank gun M6: the telescopic sight M5A1; and the periscopic sight M19 with the periscope M2.

a. Telescopic sight M5A1 (fig. 8).—(1) General.—The telescope M5A1 is the present standard for use with the M22 mount. The telescope is a straight tube type, using a lens erecting system. The objective end is designed to provide a very small frontal target, which also requires only a small hole in the armor plate (shield). The telescope has a magnifying power of 1 to 1.12 diameters and a field of 31°. Vertical and horizontal lines (cross hairs) are etched in the reticle of the sight.

(2) Mount.—The telescopic sight is mounted on two brackets. The front bracket has a push fit bearing to accommodate the forward end of the telescope. The rear bracket houses one of several types of adjustment devices used to target the gun.

(3) Mounting telescopic sight.—(a) The type of sight adjustment device on the rear bracket will alter slightly the procedure for installing the sight. At present the adjustment of the sight is accomplished by one of three methods:

1. Four screws located radially about the rear bracket.
2. An eccentric ring housed in the rear bracket.
3. Vertical and horizontal slides housed in the rear bracket and operated by means of thumbscrews.
(The Wildrick sight adjusting bracket.)

(b) The procedure for mounting the sight in the more recent model is described below. For detailed information on the other types see the pertinent Technical Manual.

1. Remove sight from case.
2. Remove headrest.
3. Loosen wing nut and open swing bolt on clamping bracket.
4. Insert sight, tapered end forward, through front bracket and push forward until front bearing is seated in front bracket.

5. Seat anticant pin in its seat in lower half of clamping bracket.
6. Close clamping bracket and swing bolt and tighten wing nut.
7. Adjustment is made by turning elevation deflection thumbscrews in the desired direction. One click equals $\frac{1}{2}$ mil.
8. Replace and adjust headrest. Particular attention must be given to this adjustment. It should be adjusted for the gunner while his head is held in the firing position. In the firing position the head should be pressed forward against the headrest. The headrest is so adjusted that while the tank is in motion the eyes do not press against the protective rubber over the eyepiece of the telescope causing vision to be blacked out.

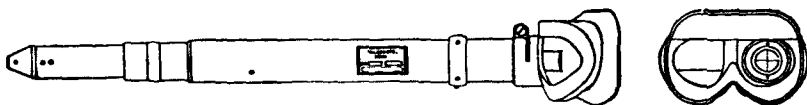

RAPID 838

FIGURE 8.—Telescopic sight M5A1.

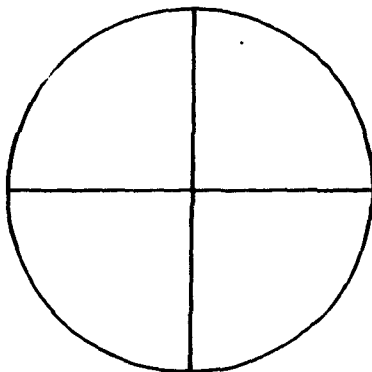

FIGURE 9.—M5A1 telescopic sight reticle.

b. Sight M19 with periscope M2.—(1) This sight is designed for use with guns mounted in power operated turrets. The sight assembly consists of the periscope M2 and telescope M19 mounted in a case (fig. 10).

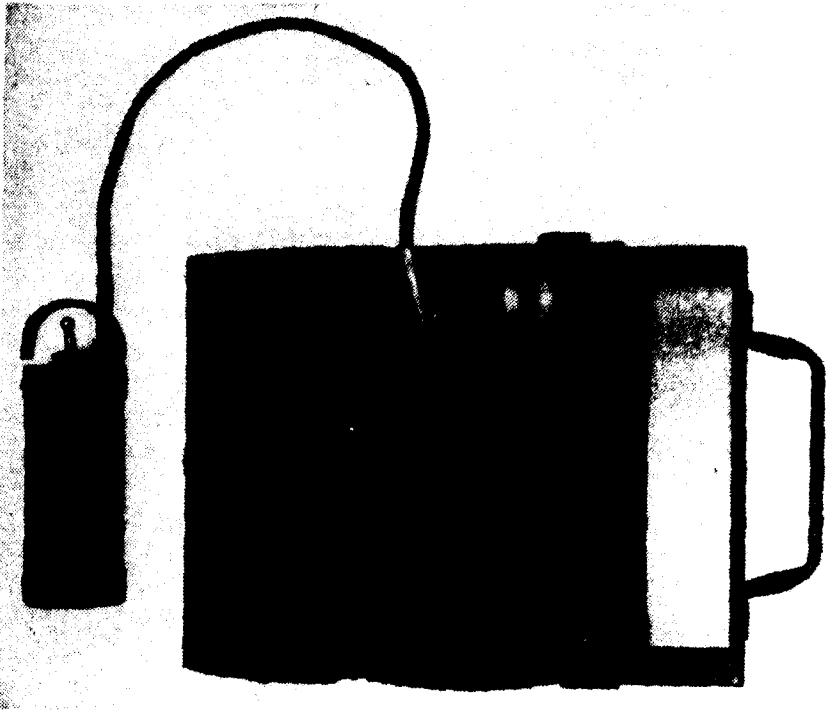

FIGURE 10.—Periscopic sight with periscope M2 and telescopic sight M19.

(2) The periscope has two mirrors, one top and one bottom, mounted in the case. The telescope is mounted vertically within the case on the right-hand side. The sight assembly is mounted in the tank by slipping the case handle down into the sight recess (see fig. 10), clamping it into place, and placing the battery container in the clips provided above the sight.

(3) (a) The telescope M2 is a straight tube telescope with no magnification. Some of these sights have been issued with the cross hair reticle similar to the telescopic sight M5A1. (See fig. 9.) The reticle to be used on latest sights is as shown in figure 11. The vertical axis is marked by the vertical lines above the upper and lower dots respectively. The figure is self-explanatory as to the meaning of the various dots. The reticle is illuminated by a small bulb.

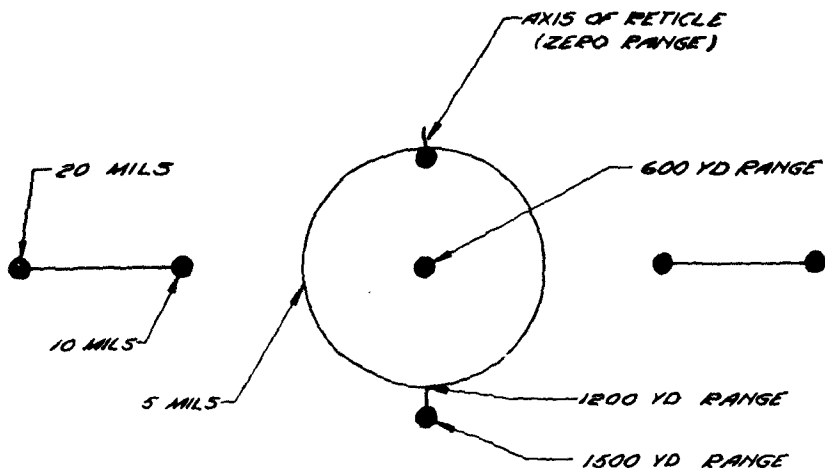

FIGURE 11.—Reticle telescopic sight M19.

(b) On some mounts, the sight is mounted in prolongation of the axis of the trunnions of the mount. Adjustments of the telescope are made by the adjusting screws. (See fig. 10.) On other mounts the sight is connected to the mount trunnions by linkage and adjustment is made both by adjusting the linkage and by means of the adjusting screws on the sight.

■ 36. **HOW TO ZERO SIGHTS.**—For field range and combat firing, the sight is adjusted so that the line of sight and the axis of the bore are parallel. For 1,000-inch range firing, the sight is adjusted so that the line of sight and the center of impact of the 37-mm gun or the machine gun, whichever is being used, intersect at 1,000 inches. Three methods are used to zero the sights.

a. *Bore sights.*—The bore sights issued with the 37-mm gun consist of a muzzle sight and a breech sight. (See fig. 12.) A testing target (see fig. 13) issued by the Ordnance Department or improvised may be used with the bore sights.

(1) *Use of testing targets.*—The testing target is placed in a plane perpendicular to the axis of the bore at a distance of 80 feet from the gun. The tank should be on fairly level ground. Place the muzzle sight about 1½ inches into the

muzzle of the gun with the bore of the sight in line with the horizontal marks in the muzzle of the gun. Insert the breech bore sight about 2 inches into the chamber of the gun. Look through the bore sights and have the testing target moved until the center line of the bore pierces the testing target so as to bring the horizontal line of the muzzle bore sight coincident with the horizontal line *A-B* on the right hand figure of the target. Now, rotate the muzzle bore

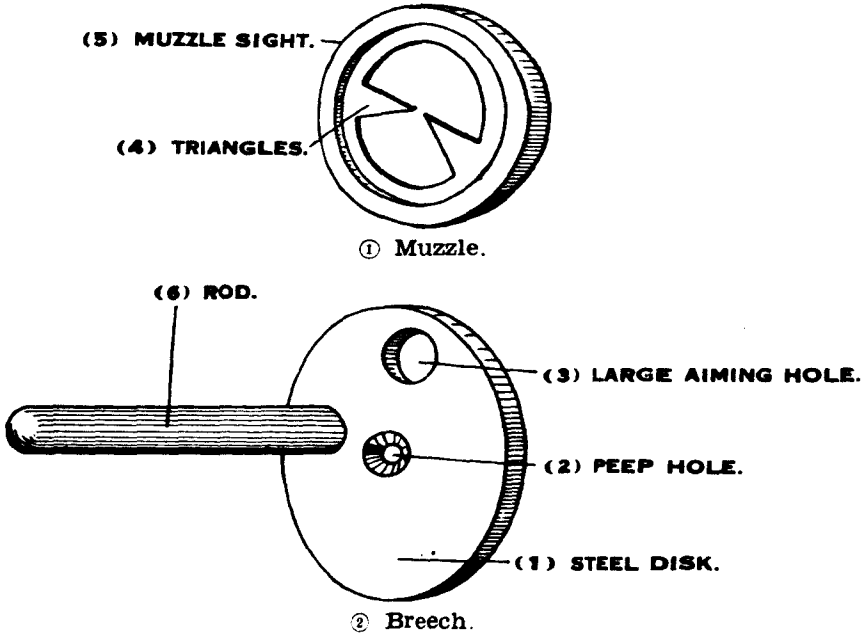
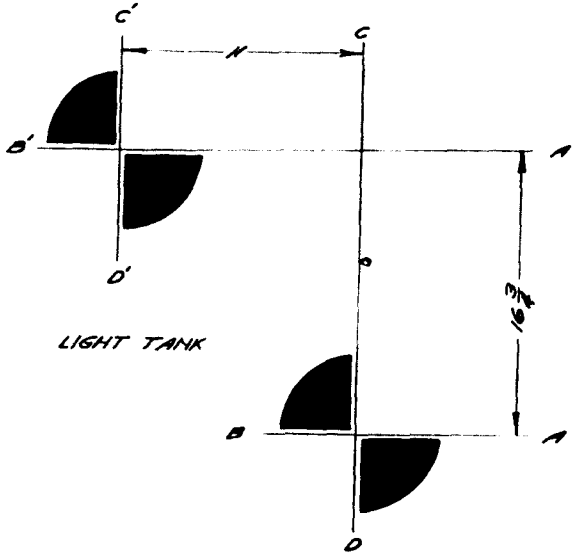

FIGURE 12.—Bore sights.

sight 90° , that is, until the bar is in line with the vertical marks on the face of the muzzle. Move the testing target until the vertical line of the muzzle bore sight is coincident with the vertical line of the target *C-D*. Look through the sight and adjust it so the horizontal and vertical cross hairs coincide with the lines *AB* and *C'D'*. With the dot reticle sight, adjust until the center dot is in the center of the target and the horizontal and vertical lines of dots coincide with the lines *A'B'* and *C'D'*.

(2) *Without testing target.*—Place bore sights in the bore. Select a distinct point on which to aim at a range of at least 600 yards. Aim on this point with the bore sights. Without



① M22 mount.

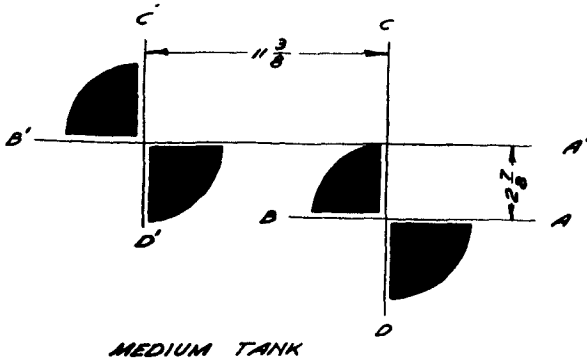

MEDIUM TANK

② M24 mount.

FIGURE 13.—Testing targets.

disturbing the laying of the gun, adjust the sight so as to aim on the selected point.

b. Quick field adjustment.—Remove the firing pin and guide assembly from the gun. Select an aiming point at least 2,000 yards from the gun. By looking through the hole in the breechblock bushing, bore sight the gun on the

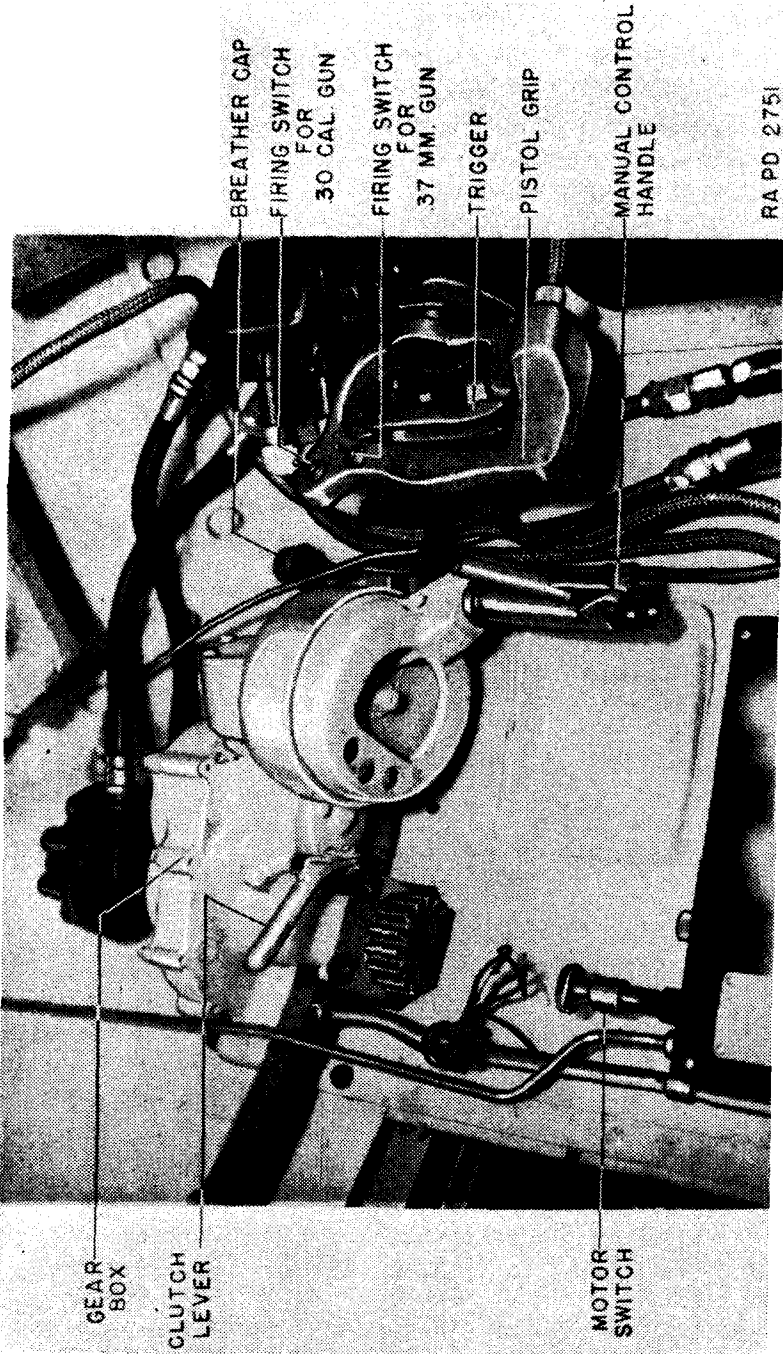

FIGURE 14.—One form of power traverse.

target. Without disturbing the laying of the gun, adjust the sights on the target.

c. *Zeroing on 1,000-inch range.*—Fire a shot on any point of the target with the machine gun. Center a black paster over the shot hole. Without disturbing the laying of the gun, adjust cross hairs (600-yard dot) of the sight on the target.

SECTION VII

POWER TRAVERSE

■ **37. POWER TRAVERSE.**—When guns are mounted in tanks having power operated turrets, all traverse is by the turret. For description of the power traverse see appropriate Technical Manuals. The power traverse turret may be operated manually by engaging the manual operating handle.

■ **38. OPERATION.**—The power traverse mechanism is controlled by an operating handle on which is mounted the safety, trigger and firing switches for the 37-mm gun and the coaxially mounted machine gun. This handle has a pistol grip. Rotation of the grip clockwise causes the turret to move to the right and rotation counterclockwise causes movement to the left. The speed of movement of the turret is controlled by the amount of such rotation. The gunner grips the control with his left hand, with his fingers grasping the safety switch and his thumb in position to operate the firing switches.

SECTION VIII

ACCESSORIES AND SPARE PARTS

■ **39. ACCESSORIES.**—Accessories include tools for such assembling and disassembling as are covered in section II, making adjustments, and cleaning gun, as well as auxiliary equipment. The names or characteristics of the accessories provided with the gun indicate their use, therefore, no detailed description or method of use is outlined herein. A complete list of accessories may be found in SNL A-45. The principal accessories used by the gun crew consist of—

a. *Bore brush and rammer.*—(1) The bore brush is made of fiber bristles. The lower end of the brush is provided

with an external threaded stud which can be screwed into the thread end of the forward section of the rammer. The brush is carried in the tool kit.

(2) The rammer consists of two sections. The forward section is threaded at both ends. One end is threaded to receive the cleaning brush and the other end the rear section of the rammer.

b. Protective muzzle cover.—The muzzle cover (M302) is provided to protect the gun from dirt, moisture, or obstructions. It fits over the muzzle of the gun. It is made of heavy leather and protects the bore from dirt and water.

c. Oilcan, 1 quart.—This can is for recoil cylinder oil. It is carried in its compartment of the tool case.

d. Oiler, oval, 3-ounce.—This is the spout type oiler. It should be filled with light lubricating oil and carried in the tool case.

e. Grease gun (Lincoln No. 5951).—This grease gun fits the lubricating fixtures of the gun and mount and is carried in the tool case.

f. Oil gun, with cap.—This oil gun is used in refilling the recoil cylinder. It is made of brass and has a fixed threaded spout which fits the filler hole of the recoil cylinder.

g. Tool roll M6.—This roll is made of canvas and is designed to carry the tools.

h. Assorted tools.—The tools furnished with the guns are:

- (1) Hammer, machine, ball-peen, 8-ounce.
- (2) Pliers, combination, slip-joint.
- (3) Punch, drive pin, standard $\frac{3}{32}$ -inch point, 4 inches long.
- (4) Screw driver, regular, 3-inch.
- (5) Wrench, adjustable, 8-inch.
- (6) Wrench, engineer's, double head, $\frac{3}{8}$ -inch and $\frac{1}{2}$ -inch
- (7) Wrench, socket, head, setscrew, $\frac{3}{32}$ -inch hexagonal.
- (8) Wrench, socket, head, setscrew, $\frac{1}{8}$ -inch hexagonal.

(9) The tool roll and tools are carried in the crew compartment of the tank.

■ 40. SPARE PARTS.—The spare parts for the gun and mounts are listed in the Standard Nomenclature List.

SECTION IX
AMMUNITION

■ 41. AMMUNITION USED.—*a.* Ammunition authorized for use in the 37-mm tank gun, M6, is listed in the table below. Note that the table completely identifies the ammunition as to type and model of the projectile and the caliber and model of the gun in which fired.

Nomenclature	Prescribed fuzes		Approximate weight of projectile (pounds)
	Model	Action	
<i>Service ammunition</i>			
Canister, fixed, M2, 37-mm guns M3, M5, and M6			1.89
Shell, fixed, HE, M63, with fuze, BD, M58, 37-mm guns M3, M5, and M6.	M58 ¹	ND ²	1.61
Shell, fixed, HE, Mk. II, with fuze, BD, M38A1, 37-mm guns M3, M5, and M6.	M38A1 ¹	ND ²	1.24
Shot, fixed, AP, with tracer, 37-mm guns M3, M5, and M6.			1.92
<i>Target practice ammunition</i>			
Shot, fixed, TP, M51, with tracer, 37-mm guns M3, M5, and M6.			1.92
<i>Blank ammunition</i>			
Cartridge, blank, 10-gage, 37-mm guns M3, M5, and M6 ³ .			
<i>Drill ammunition</i>			
Cartridge, drill, M13, 37-mm guns M3, M5, and M6			1.92

¹ This fuze is not classified as bore safe.

² ND—Nondelay.

³ Requires adapter, shot shell (10-gage), M2. This adapter consists of a standard cartridge case modified by the addition of a liner which is chambered for a standard 10-gage shotgun shell.

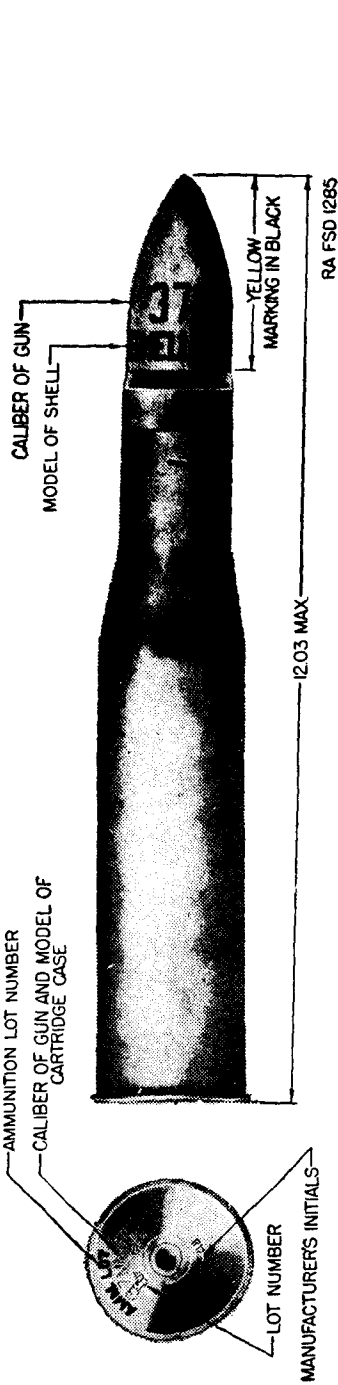

FIGURE 15.—Shell fixed, HE, Mk. II, with fuze BD, M38A1.

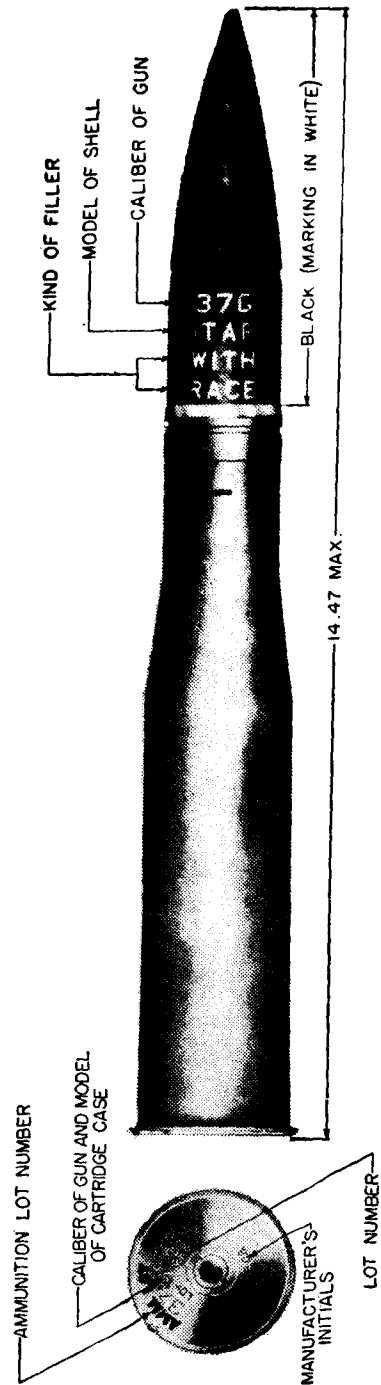
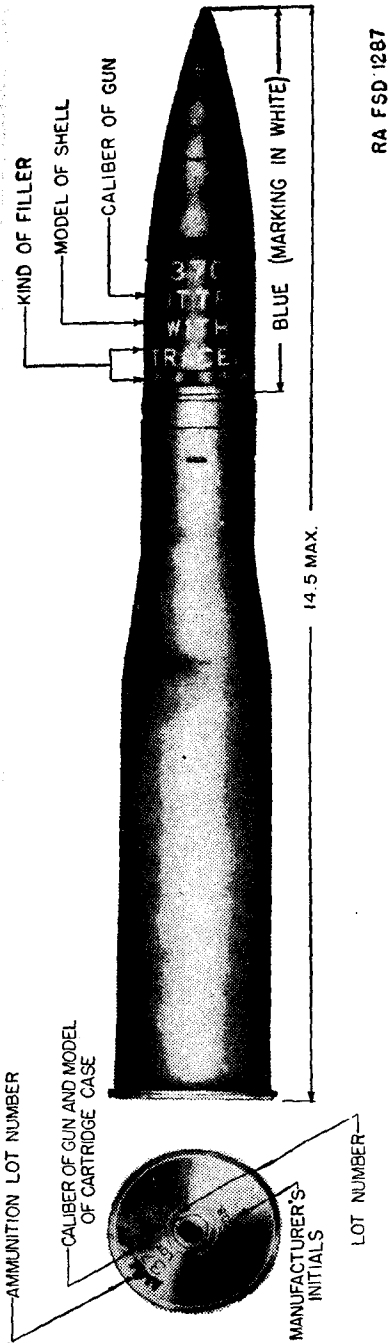
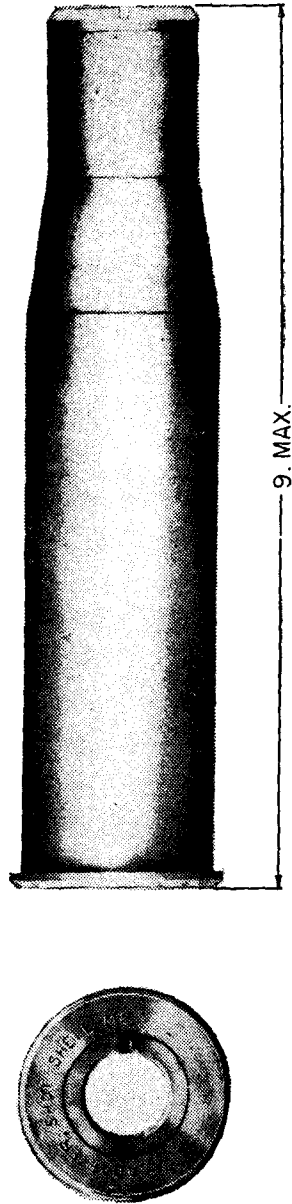

FIGURE 16.—Shot, fixed, AP, M51, with tracer.



RA FSD 1287

FIGURE 17.—Shot, fixed, TP, M51, with tracer.



RA FSD 1289

FIGURE 18.—Adapter, shot shell (10-gauge), M2.

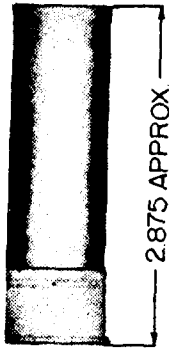

RA FSD 1288

FIGURE 19.—Shell, shotgun, 10-gage, blank (8 grains black powder with dry felt wads).

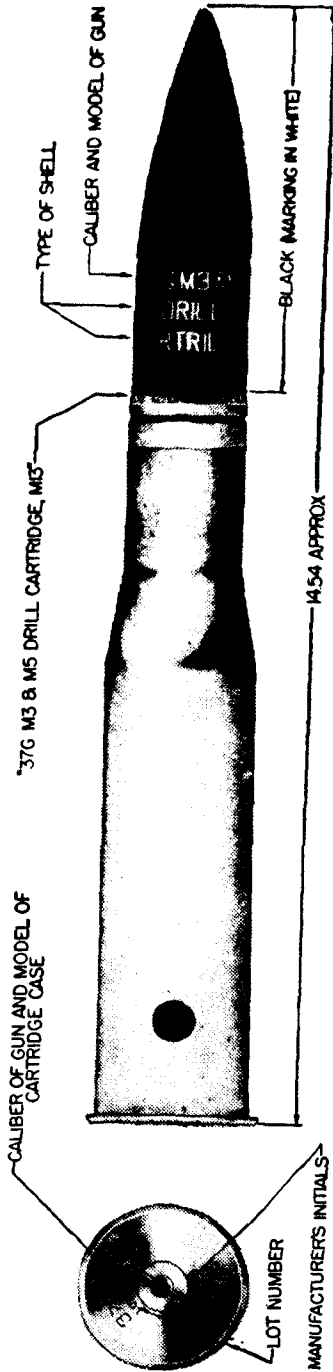

RA FSD 1286

FIGURE 20.—Cartridge, drill, M13.

b. Drill and blank ammunition are provided for special purposes when no targets are to be fired at or for simulating fire. Blank ammunition may also be used for firing salutes.

■ 42. LOT NUMBER.—*a.* When ammunition is manufactured, an ammunition lot number, which becomes an essential part of the marking, is assigned in accordance with pertinent specifications. This lot number is stamped or marked on each loaded complete round, on all packing containers, and on the accompanying ammunition data card. It is required for all purposes of record including reports on conditions, functioning, and accidents in which the ammunition is involved. To provide for the most uniform functioning, all of the rounds in any one lot of fixed ammunition consist of—

- (1) Projectile of one lot number, such as J 321530-P63.
- (2) Fuzes of one lot number (when the projectile is fuzed).
- (3) Primers of one lot number.
- (4) Propellant powder of one lot number.

b. To obtain the greatest accuracy in any firing, successive rounds should be from the same ammunition lot whenever practicable.

■ 43. DATA CARD.—A 5- by 8-inch card, known as ammunition data card, is packed in each packing box with the ammunition. When required, assembling or firing instructions are printed on the reverse side of the card.

■ 44. PACKING.—Twenty rounds are packed in sealed metal-lined packing box. The following data for the armor-piercing ammunition are considered representative for estimating weight and volume requirements:

	Weight (pounds)	Volume (cubic feet)
Complete rounds without packing material.....	3.4	---
20 rounds in metal-lined packing box.....	100	2.3

The over-all dimensions of the packing box are $17\frac{1}{8}$ by $12\frac{15}{16}$ by $17\frac{21}{32}$ inches.

■ 45. PAINTING AND MARKING.—*a. Painting.*—(1) All projectiles are painted to prevent rust, and by means of the color to

provide a ready means for identification as to type. The color scheme is as follows:

Armor piercing Black. (For 37-mm projectiles which contain no explosive filler or only a tracer.)

High explosive Yellow.

Practice Blue. (Projectile may be inert or may contain a live fuze with spotting charge of black powder.)

Inert (dummy or drill) .. Black. (Contains no explosive.)

(2) In the case of packing boxes, a blue band painted thereon indicates that the box contains practice ammunition.

b. Marking.—(1) The following information is stenciled on the projectile:

- (a) Caliber and type of cannon in which fired.
- (b) Kind of filler.
- (c) Mark or model of projectile.
- (d) Lot number of loaded projectile.

(2) Because the lot number of the loaded projectile is ordinarily not required after assembly of the complete round, it is stenciled below the rotating band where it is covered by the neck of the cartridge case.

(3) The following is stenciled on the base of the cartridge case:

- (a) Ammunition lot number.
- (b) Model of projectile.

■ 46. CARE, HANDLING, AND PRESERVATION.—*a.* Complete rounds and ammunition components are packed to withstand conditions ordinarily encountered in the field. The ammunition described herein is packed in sealed, metal-lined packing boxes. Nevertheless, since explosives are adversely affected by moisture and high temperature, due consideration should be given to protect it.

b. Explosive ammunition must be handled with appropriate care at all times. The explosive elements in primers and fuzes are particularly sensitive to undue shock and high temperatures.

c. Do not break moisture-resistant seal until ammunition is to be used.

d. Do not attempt to disassemble any complete rounds or any fuze.

e. Do not allow ammunition to be exposed to the direct rays of the sun for any length of time. More uniform firing is obtained if the rounds are at the same temperature.

f. The complete round should be free of any foreign matter (sand, mud, grease, etc.) before loading it into the gun. If it gets wet or dirty wipe it off at once.

g. Rounds prepared for firing, but not fired, will be returned to their original packings and appropriately marked. Such components will be used in subsequent firing in order that stocks in opened packings may be kept at a minimum.

h. Do not handle duds. After firing, fuzes are extremely dangerous. Duds are disposed of in accordance with TM 9-1900.

SECTION X

INDIVIDUAL SAFETY PRECAUTIONS

■ 47. GENERAL.—This section prescribes the safety precautions to be taken by individuals during practice in firing the 37-mm tank gun M6 in order to minimize the possibility of accidents. (See AR 750-10 and TM 9-1900.)

■ 48. PRECAUTIONS DURING PRACTICE FIRING.—*a.* Any individual who observes a condition which makes firing dangerous will immediately call **CEASE FIRING** and if at a distance from the unit firing, will make the prescribed signal therefor.

b. Firing will cease immediately at the command **CEASE FIRING** regardless of the source of the command.

c. No firing will be done except under the direct supervision of an officer.

d. Guns will be loaded only on command of the officer or noncommissioned officer in charge of the firing.

e. Firing will commence on any range only after it has been determined that the range is clear and the officer in charge of firing gives the order: **COMMENCE FIRING**.

■ 49. INSPECTION DURING FIRING.—*a.* Before each day's practice firing, each gun will be inspected to insure that the bore is free of obstructions and that excess oil or grease has been removed therefrom.

b. After firing and prior to moving the gun from a firing position, it will be inspected by an officer to see that it is unloaded.

c. The gun will be cleared as prescribed in paragraph 54 before anyone moves in front of the muzzle or the gun is moved.

■ 50. PRECAUTIONS BEFORE FIRING.—*a.* The gunner will check his position to make certain he is not leaning against the shoulder guard and that no part of his body will be in the path of the gun upon recoil.

b. The loader will check his position to be certain his body is clear of the rear of the gun. (See ch. 2.)

c. Ammunition will be inspected to see that it is clean and free of grease and oil.

d. The individual safety precautions listed in paragraph 54 will be taken during the firing of the gun.

■ 51. MISFIRES.—*a.* When a misfire occurs proceed as in section V.

b. When rounds which misfire are removed from the gun, they will be placed at a designated point away from the gun position. They will be destroyed under the direct supervision of an officer in accordance with specific local regulations or in accordance with instructions contained in TM 9-1900.

CHAPTER 2

TRAINING FOR PUTTING GUN IN ACTION

■ 52. GENERAL.—*a.* The drill of the tank crew is covered in FM 17-5.

b. Training for putting the gun in action is held for the purpose of developing precision and speed of movement in order that the gun may be effectively operated. The tank commander, gunner, and assistant gunner (loader) must function as a well-coordinated team in order to obtain the maximum effectiveness of the gun.

c. Equipment is loaded into the tank under the supervision of the tank commander. The gunner installs the sight.

d. When action is not imminent, the gun is locked in the traveling position. When action is imminent, the gun is released from its firing position.

e. For action in abandoning a disabled tank and for mounting and dismounting from the tank see FM 17-5.

■ 53. POSITIONS OF GUN CREW.—*a. On tanks having power traverse.*—(1) The gunner sits on the seat to the left of the gun, places his right hand on the elevating handwheel, his left hand on the power traverse operating handle, and his head against the sight headrest. He makes sure that no part of his body is in the path of the recoil of the gun.

(2) The assistant gunner stands on the right side of the gun or sits in the seat on that side. He makes sure that no part of his body is in the path of the recoil of the gun.

b. On tanks having manual traverse only.—(1) *General.*—The gunner either stands on the left of the piece or occupies the gunner's seat.

(2) *While firing "fixed" gun.*—(a) The left hand is placed on the actuating knob of the elevating handwheel, the shoulder firmly against the shoulder guard and the right arm under the gun mount with the right hand on the right-hand support bracket whereby he actuates either gun, 37-mm or caliber .30, with his right thumb. (Because of the recoil of the gun, he avoids extending his right arm over the

shoulder guard.) He operates the elevating mechanism with his left hand and the traversing mechanism by physical pressure against the mount. The position is most applicable when firing the gun, in combat, from positions of partial tank defilade.

(b) The gun may be traversed by means of the traversing handwheel. In this method of firing the turret gun(s), the right hand is placed on the traversing handwheel with the thumb on the caliber .30 trigger actuator. The 37-mm gun must then be fired, using the left hand, by means of the trigger actuator plunger in the hub of the elevating handwheel.

(3) *While firing "free" gun.*—(a) The left hand grasps the mount by means of the hand support bracket on the left. The shoulder is firmly against the shoulder guard and the right arm under the gun mount with the right hand on the hand support bracket on the right of the mount. The guns are actuated with the right thumb. The gunner is trained to elevate, traverse, and fire the gun simultaneously in an accurate and rapid manner.

(b) The assistant gunner takes post, as in a(2) above, on the right of the gun in such position that will avoid his injury by the recoil.

■ 54. SERVICE OF THE PIECE.—a. *To prepare gun for firing.*—

(1) The gunner, assisted by the assistant gunner, checks the recoil cylinder for proper amount of oil. He then—

(a) Installs the sight and checks the light in the M19 sight when that sight is used.

(b) Checks the gun for cleanliness and lubrication.

(c) Checks the trigger actuator mechanism.

(d) Checks traversing and elevating mechanism.

(e) Takes his position at the gun.

(2) The assistant gunner assists the gunner in checking the recoil cylinder. He then—

(a) Inspects the ammunition for proper amount, types, loading, and cleanliness.

(b) Inspects to see that no rounds or empty cases are on the floor.

(c) Checks operation of the breechblock.

(d) Unlocks the gun from its traveling position.

(e) Takes his position at the gun.

b. *To load.*—(1) Unless specifically ordered otherwise, the gun is loaded when directed by the gunner (tank commander). Exceptions to this procedure occur during marksmanship instruction where, as a safety precaution or for control purposes it is necessary to announce the number of rounds to be fired in an exercise and to specify when the gun is to be loaded.

(2) To load the gun, the assistant gunner grasps a cartridge at the base with his left hand, turns the projectile to the front, swings his arm toward the breech, and inserts the round into the opening. After the nose of the projectile enters the chamber, the gunner propels the round forward with a quick push with his thumb and fingers. He then passes his left arm under the gun and taps the gunner on the back. **Caution:** The assistant gunner must be sure that no part of his body is in the path of recoil as the breechblock starts to close as the gunner may fire the piece immediately. The left arm must be lifted above the gun. After tapping the gunner, the assistant gunner immediately grasps another round. (The closing breechblock will not catch or injure the hand.)

c. *To fire gun.*—The gun having been loaded (and the signal of COMMENCE FIRING having been given), the gunner will open fire as soon as he is laid on the target. To fire the gun, the gunner pushes sharply on the trigger actuator and quickly releases it or presses the safety switch on the power traverse operating handle and the 37-mm gun switch.

Caution: The gunner must not fire the gun until he has been tapped by the assistant gunner.

d. *To unload.*—The gun automatically ejects the empty case. To unload an unfired round, pull down on the operating handle. For immediate action, when gun fails to fire see section V, chapter 1.

e. *To cease or suspend firing.*—(1) *Cease firing.*—Firing is stopped and the gun, if loaded, is unloaded. The members of the crew may leave their firing positions. CEASE FIRING is used for long pauses in firing.

(2) *Suspend firing.*—At the command **SUSPEND FIRING**, firing stops, the gun is loaded and remains ready, or is made ready, for instant resumption of fire. The posts of the gun crew remain unchanged. The gunner continues to observe and lay on the target or lays on a new target, if one is designated, so that he may resume fire with the least practical delay the instant **RESUME FIRING** is directed. **SUSPEND FIRING** is used for short pauses in the firing. For example, when the target disappears temporarily or moves out of range, or when shifting to a new target.

(3) *Application.*—The formal commands **CEASE FIRING** and **SUSPEND FIRING** are used only during instruction of personnel and during practice firing.

f. To clear gun.—If the gun has been put into action with service or subcaliber ammunition present, the gun must be cleared before anyone moves in front of the muzzle. At the command **CLEAR GUN**, the loader unloads the gun and leaves the breech open. During practice firing, an officer will then inspect the gun to make sure that there is no ammunition in it. Under service conditions or in the absence of an officer, the tank commander will make the above inspection.

g. To go out of action.—The command is **OUT OF ACTION**.

(1) The loader unloads the gun if loaded and closes the breech. The gunner releases the trigger by pressing on the trigger actuator and calls "Clear" to the tank commander.

(2) The gunner then manipulates the gun so that the loader can lock the gun in the traveling lock.

(3) The gunner then removes the sight (if so directed).

(4) In the meantime, the loader moves the ammunition clear of the gun and replaces the unused rounds into the ammunition containers. Empty cases are placed in containers or otherwise disposed of.

CHAPTER 3

MARKSMANSHIP

	Paragraphs
SECTION I. General.....	55-57
II. Preparatory marksmanship.....	58-63
III. Preliminary gunner's examination.....	64
IV. Range practice, including qualification courses....	65-68
V. Conduct of range practice, including record practice and individual safety precautions.....	69-85

SECTION I

GENERAL

■ 55. PHASES OF TRAINING.—*a.* Marksmanship training with the 37-mm tank gun M6 is divided into three phases:

- (1) Preparatory marksmanship training.
- (2) Subcaliber instruction and record firing practice on the 1,000-inch moving target range.
- (3) Instruction and record firing practice on the moving target field ranges.

b. The above phases are listed in the order of instruction. Each man must become proficient in one phase before proceeding to the next.

■ 56. PRIOR TRAINING.—Before receiving instruction in marksmanship, the enlisted man must be proficient in mechanical training and training for placing the gun in action, as described in chapters 1 and 2. He must also have fired the machine-gun course as prescribed in FM 23-50.

■ 57. METHOD OF INSTRUCTION.—*a.* The applicatory method of instruction as prescribed in FM 21-5 is used in instruction in marksmanship.

b. The platoon is the largest unit that can economically be handled for individual instruction. Explanation and demonstration may be given to groups as large as the company. The coach-and-pupil method of instruction is used to the maximum.

c. The platoon sergeant and the tank commander act as assistant instructors. The tank commander instructs his own tank crew and the platoon sergeant assists the platoon leader in supervising instruction.

d. In aiming and tracking exercises and during instruction and record firing practice, time is saved by having all guns operated simultaneously; the platoon leader or an assistant instructor giving the necessary commands.

SECTION II

PREPARATORY MARKSMANSHIP

■ 58. **PHASES.**—Preparatory marksmanship is divided into two phases:

- a.* Aiming exercises.
- b.* Tracking exercises.

■ 59. **EQUIPMENT.**—In addition to the tanks with guns installed, the following equipment is necessary for one tank platoon:

- 1 small portable blackboard.
- 1 portable standing frame for each two tanks.
- 1 target *A*, 1,000-inch for each tank.
- 1 sled carrier.
- 1 stop watch.
- 1 tape measure, 50 feet or longer.
- 1 1,000-inch apparatus for operating moving targets.
- 1 progress and proficiency chart for each tank crew.
- 1 chart showing aiming pictures (figs. 22 and 23).

■ 60. **AREA OF INSTRUCTION.**—*a.* Initial preliminary marksmanship training may be held near the barracks or camp. A fairly level, cleared area approximately 75 by 200 feet will accommodate two platoons. More advanced training is conducted on the 1,000-inch moving target range. Figure 21 shows a convenient arrangement of material in the instruction area.

b. Group instruction is held at a convenient place in front of the tanks. The crew is then sent to the tank where individual instruction is conducted by the tank commander.

■ 61. **AIMING EXERCISES.**—These exercises are conducted on the 1,000-inch target *A* and consist of—

- Aiming for range.
- Aiming for lead.
- Aiming for range and lead.

a. Aiming for range.—(1) The instructor by means of the aiming chart, figures 22 and 23 indicates the proper point for aiming on fixed targets at various ranges and explains that as the target nears the gun it appears larger in the sight. Aiming silhouettes Nos. 1, 2, and 3 on the 1,000-inch target represent the apparent size of tanks at 300, 600, and 900 yards respectively.

(2) The gunner and assistant instructor then go to the gun. The assistant instructor explains the operation of the

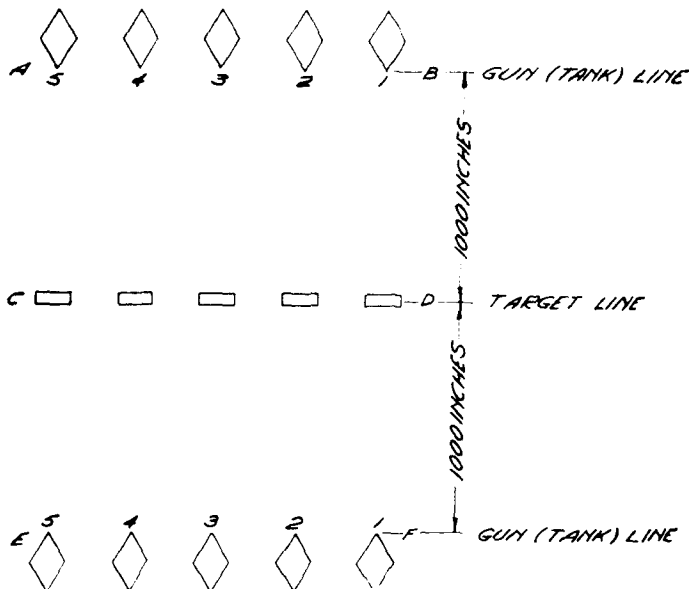

FIGURE 21.—Tank and target arrangement for initial preparatory marksmanship training for two tank platoons.

elevating mechanism. He then aims the gun for various ranges for stationary target firing and causes the gunner to look through the sights after each aiming. The gunner then takes his position at the gun and is required to lay the gun for various announced ranges. Each aiming is checked by the assistant instructor and errors pointed out.

b. Aiming for lead.—(1) This instruction is carried out as in *a* above. The instructor explains that—

(a) When firing at a moving target the gun must be pointed ahead of the target to allow for the travel of the

target during the time of flight of the projectile. This distance is known as the lead and is measured in target lengths, one target length being one lead. (See figs. 22 and 23.) The following is a lead table used for firing the first round:

Target moving at right angle to line of fire. Speed (mph)	Leads		
	100 to 400 yards	400 to 700 yards	700 to 1,000 yards
Slow—less than 10.....	½	1	1¼
Medium—10 to 20.....	1	2	3
Fast—over 20.....	2	3	4

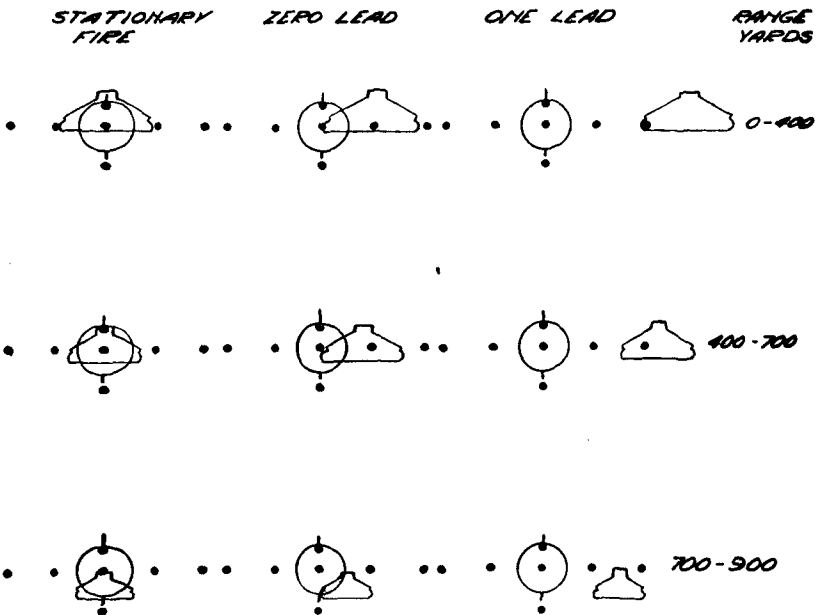

FIGURE 22.—Sight pictures when aiming at stationary and moving targets with the M19 dot reticle sight. (Note change in size of silhouettes as range increases.)

1. The angle at which the target is moving will affect the amount of lead to be taken. If the angle between the line of fire and the line of travel of the target is less than 45° , use one-half the lead shown in the table.
2. For targets moving directly toward or directly away from the gun, no lead is taken except when it is moving up or down a steep slope.
3. When firing from moving tanks at stationary targets, rear leads (aiming to the rear of the target) are taken in accordance with the speed of the tank. When firing from moving tanks at moving targets, the difference in speed is used in estimating the number of leads.
4. The table above gives the amount of lead for the first round; corrections are then made, based upon observation of the strike or tracer. *Too much lead*

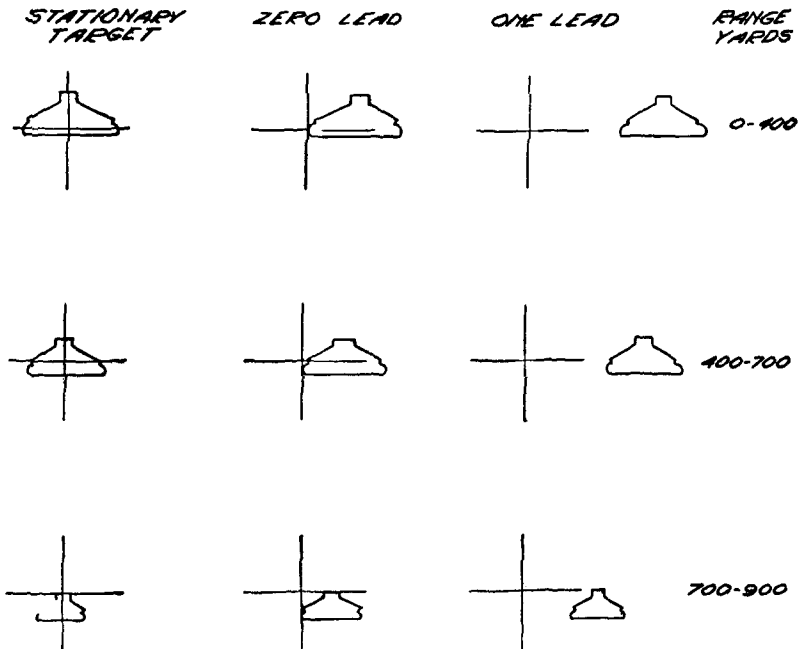

FIGURE 23.—Sight pictures when aiming at stationary and moving targets with the cross hair reticle. (Note change in size of silhouettes as range increases.)

is better than too little as the target runs into the fire and observation of the strike is easier. Intelligent use of the lead table includes the immediate application of fire with the estimated lead followed by the necessary corrections based upon observation of strike and tracer.

(b) Except as explained in notes to the table above, the vertical line of the telescope reticle should be ahead of the target.

(c) For initial aim at a moving target, lay the sight on the rear of the target with the proper range. Swing the gun through the target in the direction of movement to the estimated or designated number of leads. When this point is reached, keep the gun moving uniformly with the target, and fire. Observe the strike, estimate corrections, and again aim and fire.

(2) The assistant instructor and gunner go to the gun. The assistant instructor explains and demonstrates how to traverse the gun. He then lays the gun for various leads using the 400- to 700-yard range zone. (See figs. 22 and 23.) The gunner looks through the sights after each aiming. The gunner then takes his position at the gun and aims it for ranges of 400 to 700 yards. The assistant instructor checks each laying of the gun and points out errors.

c. Aiming for range and lead.—By means of the sight picture charts the instructor shows the proper aiming for various ranges and leads. The assistant instructor demonstrates these to the gunner. The gunner then takes his position at the gun and is required to aim for various ranges and leads announced by the assistant instructor. The assistant instructor checks the laying, points out errors, and lays the gun off the target before announcing a new range and lead.

■ 62. TRACKING EXERCISES.—*a. Organization.*—These exercises are conducted on the 1,000-inch moving target range and the 1,000-inch target is used. The following organization is recommended:

(1) *Platoon leader.*—Conducts instruction and supervises generally the work of the entire platoon.

(2) *Platoon sergeant.*—Issues the orders for conducting the exercises and controls, by signal, the operation of the target.

(3) *Tank commanders*.—Supervise the work in their tank; relay orders from the platoon sergeant to the crew. Signal the platoon sergeant "Ready" when the gun in their tank is ready to engage the target.

(4) *Assistant instructor—timekeeper*.—Starts target on signal from platoon sergeant and regulates time of exposure in accordance with his orders. Specifies to the men operating the drum the time of exposure of the target for each run. At intervals, as an aid to regulating the target speed, calls out the time consumed as the target travels across the course.

(5) *Two drum operators*.—Operate the drum so that the target will be exposed as nearly as possible for the time specified by the assistant instructor ((4) above). Regulate the speed at which they turn the drum so as to obtain a uniform rate of travel for the target throughout its entire course.

(6) *Coaches*.—At the guns. Conduct individual instruction; check execution of the exercises by the gunners.

(7) *Gunners*.—Execute the exercises at the guns. The loaders assist in coaching as directed by the tank commander.

(8) *Remainder of platoon*.—Held well clear of the tanks, arranged numerically, ready to move forward to take their turn at the guns when so directed.

b. Speed of targets.—(1) The following table shows the approximate speed at which 1,000-inch moving targets should be run to represent speeds of various ranges:

Target speeds in mph	Target speeds in inches per second corresponding to—		
	400 yards	600 yards	900 yards
10	12	8	5
15	19	12	8
20	24	16	11

The time of exposure of a target for a particular run may be determined by dividing the distance to be traveled in inches by the target speed in inches per second shown in the table.

(2) Initially, in conducting the tracking exercises, the slower speeds should be used; as instruction progresses, the speeds used for successive runs of the targets should be varied and increased and finally the target should be moved at erratic speeds.

c. Correct lead.—The instructor explains that the method of obtaining the correct lead is as shown in paragraph 61. Once the lead is obtained the gun is traversed and elevated uniformly with the speed of the target.

d. Smoothness of operation.—The first exercises should be held with the target moving slowly and later exercises with increased speeds. Emphasis is placed upon smoothness of operation and accuracy of laying.

e. Procedure.—Each exercise is begun by a command such as **LEFT FRONT, UPPER SILHOUETTE, 600, TRACK.** At the command **LEFT FRONT,** the gunner traverses the gun to the left and when the target appears, aims with the announced range and lead. When the target disappears behind the screen on the right of the range, the gunner keeps his gun pointed at the point of disappearance. When the target reappears the gunner immediately begins tracking. As the gunner develops facility in tracking he is required to simulate firing.

f. Traverse.—Traverse of the target across the range in one direction is known as a run and traverse across and back is known as a double run. No commands are given for traversing the target back across the range.

g. First exercise.—(1) This exercise is conducted on the parallel-level 1,000-inch course.

(2) The gunner takes his position at the gun and when the target appears aims with the prescribed lead and range and tracks the target. Initially only the 400 to 700 range zone is used. Later other range zones are included.

h. Second exercise.—This exercise is conducted on the parallel-hilly 1,000-inch range course. The procedure is the same as described in *g* above. The instructor explains that the target must be lead both horizontally and vertically, that is, the point of aim must be on the axis of motion. When the target reaches its highest point and then starts down, the gunner must continue traversing and at the same time rapidly depress the gun to put the point of aim again

on the axis of motion. When the target reaches its lowest point this process is reversed. Figure 24 shows a method of tracking targets on the parallel-hilly course.

■ 63. RECORD OF PROGRESS.—A record of progress covering the work of each man undergoing instruction in preparatory

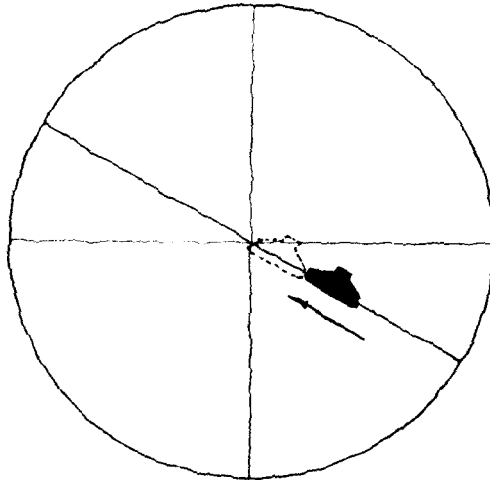

① Cross hair reticle.

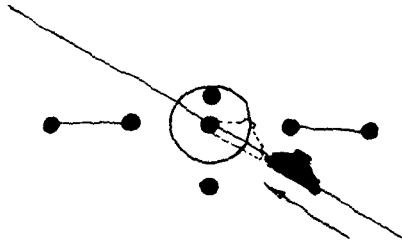

② Dot reticle.

FIGURE 24.—Method of tracking moving targets on parallel-hilly course of 1,000-inch range.

range training is maintained throughout the course of instruction. The purpose of this record is to keep a current account of each man's progress so that no man will be permitted to start firing instruction on the 1,000-inch and field firing moving target range until he has satisfactorily completed preparatory training.

FORM FOR RECORDING PROGRESS OF MEN IN PREPARATORY EXERCISES

Names	Aiming exercises				Tracking exercises		
	Aiming for range, fixed targets	Aiming for range, moving targets	Aiming for leads, moving targets	Aiming for leads and range, moving targets	Tracking, parallel-level course	Tracking, parallel-hilly course	Tracking, successive targets
	Grades						

Method of grading:

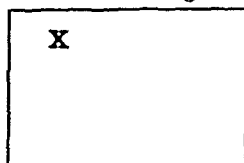

Unsatisfactory

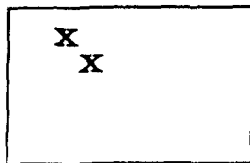

Satisfactory

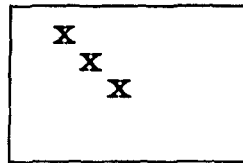

Satisfactory and has instructional ability

SECTION III

PRELIMINARY GUNNER'S EXAMINATION

■ 64. EXAMINATION.—Prior to current record firing practice, each individual will be examined to determine his proficiency in mechanical training, elementary training for placing the gun in action, and service of the piece and practical ability to execute satisfactorily the aiming and tracking exercises prescribed in paragraphs 61 and 62.

a. Scope.—The examination will consist of a practical demonstration by the candidate of his understanding and ability to perform satisfactorily specific tests in each phase and exercise. The extensiveness of the examination and the

standard of excellence demanded of the candidate are the responsibility of the organization commander concerned.

b. Conduct.—(1) The examination will be conducted by an officer or qualified noncommissioned officer.

(2) Company or similar unit commanders will determine the detailed procedure and time of the examination. They are responsible that all men in their organization satisfactorily complete the examination within a period of 6 months prior to the time they fire any part of the qualification course.

c. Record.—A record of the date of the satisfactory completion of the examination in preliminary marksmanship will be entered on each individual's score card prior to initiating record firing practice.

SECTION IV

RANGE PRACTICE, INCLUDING QUALIFICATION COURSES

■ 65. GENERAL.—*a.* Each man of units equipped with the 37-mm tank gun M6 (mounted in tanks) will fire one of the courses given below for qualification. The course to be fired will be designated by higher headquarters. Ammunition allowances and qualification scores are prescribed in AR 775-10; records and reports, in AR 345-1000; compensation, in AR 35-2380.

b. (1) Prior to any firing with the 37-mm tank gun M6 (mounted in tanks), all men to fire will have completed (within the preceding 3 months) marksmanship firing with the caliber .30 machine gun (mounted in tanks), as prescribed in FM 23-50.

(2) Prior to firing on the 1,000-inch range, all men will complete a thorough course in preparatory marksmanship training. Before firing record practice, each man must satisfactorily pass an examination as prescribed in paragraph 64.

c. Rules governing the firing of qualification courses for record practice are prescribed in paragraph 77.

d. For firing on the field ranges, the caliber .30 machine gun HB, M1919A4, mounted coaxially with the 37-mm gun will be used. For 1,000-inch firing, the caliber .30 coaxial machine gun with the caliber .22 trainer will be used. Prior

to beginning of range practice the linkage on the trigger actuators or the wires on the solenoid firing devices will be crossed so that the actuator or switch for the 37-mm gun will fire the machine gun. Ammunition for the machine gun will be loaded alternate live and dummy rounds and the loader will reload after each round is fired.

e. All firing will be executed with an assumed range of 600 yards.

■ 66. COURSE A.—Ranges: as indicated under each table. Targets: for tables I and II, target A, silhouette as indicated; for table III, target B.

a. *Instruction practice.*—(Fire tables I, II, and III three times.)

NOTE.—Instruction and record practice firing of tables I and II will be completed before proceeding to table III.

TABLE I.—*Parallel-level course* (stationary tank—moving target)

Range	Silhouette No.	Number of rounds	Speed, inches per second	Time of traverse, seconds	Lead	Direction of movement of target
1,000-inch	1	5	8	44	0	L to R.
Do	1	5	8	44	0	R to L.
Do	2	5	12	30	1	L to R.
Do	2	5	12	30	1	R to L.
Do	3	5	16	22	2	L to R.
Do	3	5	16	22	2	R to L.

TABLE II.—*Parallel-hilly course* (stationary tank—moving target)

Range	Silhouette No.	Number of rounds	Speed, inches per second	Time of traverse, seconds	Lead	Direction of movement of target
1,000-inch	1	5	8	44	0	L to R.
Do	1	5	8	44	0	R to L.
Do	2	5	12	30	1	L to R.
Do	2	5	12	30	1	R to L.
Do	3	5	16	22	2	L to R.
Do	3	5	16	22	2	R to L.

TABLE III

Range	Number of rounds	Speed	Lead	Direction of movement of target
Field range (not less than 400 yards).	110	Uniform speed of approximately 15 mph.	As necessary.	L. to R. and back to L. Exposed 15 seconds each direction. Gunner fires one round for each exposure.

¹ The caliber .30 tracer ammunition is used in this firing.

b. Record practice.—Fire tables I, II, and III, course A, once under prescribed record firing conditions.

■ 67. COURSE B.—Range: 1,000 inches. Targets: target A, silhouette as indicated.

a. Instruction practice.—(Fire tables IV and V three times.)

TABLE IV.—Parallel-level course (stationary tank—moving target)

Range	Silhouette No.	Number of rounds	Speed, inches per second	Seconds to traverse course	Lead	Direction of movement of target
1,000-inch	1	5	8	44	0	L. to R.
Do.....	1	5	8	44	0	R. to L.
Do.....	2	5	12	30	1	L. to R.
Do.....	2	5	12	30	1	R. to L.

TABLE V.—Parallel-hilly course (stationary tank—moving target)

Range	Silhouette No.	Number of rounds	Speed, inches per second	Seconds to traverse course	Lead	Direction of movement of target
1,000-inch	1	5	8	44	0	L. to R.
Do.....	1	5	8	44	0	R. to L.
Do.....	2	5	12	30	1	L. to R.
Do.....	2	5	12	30	1	R. to L.

b. Record practice.—Fire tables IV and V of course B, once, under prescribed record firing conditions.

■ 68. COURSE C.—Range: 1,000 inches. Target: target A silhouette No. 2.

a. *Instruction practice.*—(Fire tables VI and VII three times.)

TABLE VI.—*Parallel-level course* (stationary tank—moving target)

Range	Silhouette No.	Number of rounds	Speed, inches per second	Seconds to traverse course	Lead	Direction of movement of target
1,000-inch.....	2	5	12	30	1	L. to R.
Do.....	2	5	12	30	1	R. to L.

TABLE VII.—*Parallel-hilly course* (stationary tank—moving target)

Range	Silhouette No.	Number of rounds	Speed, inches per second	Seconds to traverse course	Lead	Direction of movement of target
1,000-inch.....	2	5	12	30	1	L. to R.
Do.....	2	5	12	30	1	R. to L.

b. *Record practice.*—Fire tables VI and VII, course C, once under prescribed record firing conditions.

SECTION V

CONDUCT OF RANGE PRACTICE, INCLUDING RECORD PRACTICE AND INDIVIDUAL SAFETY PRECAUTIONS

■ 69. GENERAL.—Rules and regulations governing range practice are prescribed herein to secure uniformity throughout the service.

■ 70. DUTIES OF PERSONNEL.—a. *Officer in charge.*—The officer in charge of range practice, detailed by the unit commander, is responsible for—

(1) Assignment, coordination, and supervision of ranges and firing areas.

(2) Timely arrangements with the range officer for repairs or alterations of installations.

(3) Procurement of supplies for firing units.

(4) Enforcement by firing units of safety precautions prescribed herein, in AR 750-10, and by the local commander.

(5) For interpretation of such parts of this manual as may be referred to him for decision.

b. Range officer.—The range officer is normally a member of the unit or post commander's staff. He is responsible for—

(1) Procurement and distribution of range supplies.

(2) Supervision of construction, alteration, or repair of range installations.

(3) Establishment of safety limits of ranges and coordination of firing to comply with the provisions of AR 750-10.

c. Company commander.—(1) The company commander is responsible for the efficiency of the marksmanship training of his organization and the conduct of its firing in accordance with the provisions of this manual.

(2) During 1,000-inch target firing he, or his commissioned representative, will personally supervise and control all firing by one of the following methods:

(a) Give the commands **COMMENCE FIRING** and **CEASE FIRING** for each order.

(b) Give the command **COMMENCE FIRING**, then permit tanks to fire individually, observing the safety precautions prescribed in paragraph 71, until he gives the command **CEASE FIRING**.

(3) During moving target firing, he or his commissioned representative will control the firing and the movement of the target(s) by appropriate fire orders and signals. A typical order would be: **LOAD. 1. RANGE 600, RIGHT ONE LEAD, UPPER SILHOUTTE, 2. COMMENCE FIRING.**

(4) During all firing, he or his commissioned representative will rigidly enforce local range regulations, safety precautions as prescribed in this section, and instructions pertaining to the service of the piece contained in chapter 1.

d. Scoring officers.—(1) Scoring officers will be detailed to supervise record firing practice. Officers for this duty will be detailed from organizations other than the one firing. They will familiarize themselves thoroughly with their duties and firing procedure on the 1,000-inch and field firing ranges prior to the date of commencement of record firing practice.

The number of scoring officers detailed during record firing practice will not be less than one for each four tanks firing (or for each 1,000-inch range unit being operated in the case of 1,000-inch moving targets). An assistant to the scoring officer will be present in each tank during the firing.

(2) Specific duties of the scoring officers are to—

(a) Inspect loaded belts and count number of rounds of ammunition to be fired by the gunner for each exercise. (This may be delegated to the assistant scorer.)

(b) Check dimensions of the targets, aiming silhouettes, and scoring spaces, and see that the range is laid out as prescribed.

(c) See that firing is conducted in accordance with the prescribed procedure.

(d) Verify and render decisions on all misfires, stoppages, and malfunctions of the guns. (See par. 78.)

(e) Render a decision in event of breakage or stoppages in any of the range apparatus or mechanism.

(f) Inspect each target before it is placed on the sled. Make sure that initially it contains no shot holes and that after being fired on, it has no unpasted shot holes before the start of another score.

(g) Count the number of shot holes in appropriate scoring space for each score fired, score target(s), and record the score.

(h) Check time of exposure of target on each run and render a decision in event of irregularities. (See par. 77.)

(3) Additional specific duties of assistant to the scoring officers are to—

(a) Count ammunition when so directed.

(b) Relay commands to gun crew.

(c) During moving target firing, give the commands or signals for COMMENCE FIRING and CEASE FIRING when target enters and leaves the zone for firing.

(d) See that gunner executes firing in accordance with prescribed procedure.

(e) Report all stoppages and discrepancies to scoring officer for decision.

(f) See that gun is properly cleared at completion of firing.

e. Coaches.—(1) During all preparatory training and instruction firing, there will be a coach at each firing gun (tank). It is his task to see that the gun crew executes all operations in accordance with the prescribed procedure. His main procedure is to detect errors and cause the gun crew to correct them.

(2) Specific duties of the coach are to—

(a) Require each man functioning at his gun to observe all pertinent individual and general safety precautions as prescribed in paragraph 71, and see that the instructions pertaining to the service of the piece contained in chapter 2 are complied with.

(b) See that the proper amount of ammunition is at the gun and that belts are loaded with the specified number of rounds for each exercise.

(c) Supervise generally the work at the gun, making sure that the commands **LOAD**, **COMMENCE FIRING**, **CEASE FIRING**, **UNLOAD**, and **CLEAR GUN** are properly executed. He will repeat orders or instructions when necessary to insure correct understanding and timely execution by the gunner and loader.

(d) See that the gunner executes the firing exercises in accordance with prescribed procedure.

(e) Report all misfires, stoppages, malfunctions, or discrepancies to the officer conducting firing.

(f) Score the target when directed and discuss the execution of the exercise (during instruction practice only) with the gunner.

f. Gunner.—The gunner will fire the prescribed tables in accordance with the procedure given in paragraph 77.

g. Loader.—(1) The primary duty of the loader is to serve the piece in that capacity during all firing exercises. During instruction practice he may also perform additional duties at the gun or act as an assistant coach in accordance with orders of the coach. During record firing practice, he performs only the specific duties of loader hereinafter prescribed; he does not coach or instruct the gunner in any way.

(2) Specific duties of the loader are to—

(a) Secure and have ready for use at the gun the prescribed number of belts properly loaded for each exercise.

(b) Serve the piece as loader as prescribed in chapter 2. In this connection he will—

1. Load the 37-mm gun or machine gun in accordance with the commands of the officer conducting the firing and tap the gunner on the back when the gun is loaded.
2. When the 37-mm gun or machine gun is loaded and ready to fire and when the gunner is ready to begin the exercise, signal "Ready" to the officer conducting firing.
3. Repeat all orders to unload, cease and suspend firing, and clear gun.
4. Announce for the gunner's benefit when the prescribed number of rounds for each run of the target have been fired, thus, "Five rounds complete."

(c) Report all misfires and malfunctions or stoppages to the coach (or to the scoring officer during record firing practice). During instruction firing, in case of a misfire immediately reload without command and endeavor to render the gun ready for firing as quickly as practicable. In case of a misfire, stoppage, or minor malfunction during record firing practice, proceed as described in paragraph 78.

(d) Without command, reload the gun upon the completion of a run of the target.

■ 71. SAFETY PRECAUTIONS.—*a. Responsibility.*—The responsibility and duties of individuals incident to the observation and enforcement of safety precautions are given in the preceding paragraph.

b. Ranges.—The specifications for laying out ranges to comply with safety requirements for the various types of firing are given in AR 750-10.

c. General and individual safety precautions.—The safety measures to be observed while firing ammunition during training and target practice are laid down in AR 750-10; however, the following precautions are given for emphasis:

- (1) Danger flags will be displayed at prominent positions on the range during all firing.
- (2) Such range guards as may be needed will be posted.

(3) During moving target firing, conspicuous markers will be placed to indicate the right and left safety limits of the range. All concerned will be instructed in the significance of these markers.

(4) Firing on any range will not commence until it has been determined that the range is clear and that the officer in charge of firing has given his authority to fire.

(5) No firing will be done except under the direct supervision of an officer.

(6) No gun will be loaded until a command to do so has been given.

(7) No person will be allowed in front of a tank for any purpose until so directed by an officer or noncommissioned officer, who has ascertained that all guns of the tank are cleared.

(8) No gun (tank) will be removed from the firing point until an officer has inspected the gun to see that it is unloaded. As part of this inspection a cleaning rod is passed through the barrel of each machine gun from the muzzle and *immediately removed*.

(9) A scarlet flag will be displayed on each tank from which firing is being conducted. This flag will not be removed until all guns in the tank concerned have been cleared.

(10) Decision as to whether it will be necessary to have flank tanks clear guns to permit adjacent tanks to change targets will be made by the officer in charge of range practice.

(11) No personnel except the driver will enter or leave the tank from the front.

■ 72. GUNS, MOUNTS, AND TELESCOPES.—*a.* The gun, mount, and telescope will be used as issued by the Ordnance Department without addition or modification, except as specifically authorized hereafter. During 1,000-inch firing, range reflectors or tunnels may be used. The sling seat or other standard equipment issued for the support of the gunner and loader is authorized. No other improvised supports for the gun or gun crew members will be employed during record firing.

b. Before marksmanship firing is begun, each gun, mount, telescope, and accessories to be used will be thoroughly examined and repaired or adjusted to insure their efficient func-

tioning. Excessive play will be removed from the guns and mounts and adjustments made to permit smooth manipulation.

■ 73. TARGETING.—*a.* Prior to firing, the alinement of the telescope on each gun will be verified and, if necessary, adjusted and the gun targeted as prescribed in paragraph 36. The telescope with which the gun is to be equipped during marksmanship firing will be used for targeting.

b. Guns will be targeted or retargeted as directed by the officer in charge conducting firing. During a record practice exercise the gun will not be retargeted before completion of the exercise except when the reduction of a stoppage makes retargeting necessary. The officer in charge of range practice will render a decision as to whether the gun will be retargeted. He will also decide whether the exercise will be continued or refired. The gun will not be targeted on a target upon which a record score is being fired.

■ 74. AMMUNITION.—Ammunition in the amounts shown in the tables for each score will be loaded in belts and inspected before firing.

■ 75. TARGETS.—The target used, its course of movement, and its speed will be as prescribed for the particular table being fired. For a complete description of targets see paragraph 82. If prepared locally, the outlines of the scoring spaces (1,000-inch targets) will be drawn so that the lines are not visible from the gun position. The targets used for the 1,000-inch firing may be placed on frames, racks, or carriages to elevate them to the height of the gun or to facilitate handling.

■ 76. PROCEDURE FOR FIRING.—*a. General.*—(1) All firing will be controlled by definite fire orders.

(2) During the initial phases of instruction firing the officer conducting firing may at his discretion reduce the speed, targets, and the number of rounds fired from those prescribed in the tables. The object of this procedure is to place emphasis initially upon smooth continuous tracking.

(3) A run of the target across the course once in each direction at the same speed will constitute a single score and is known as a "double run." A double run constitutes an exercise.

(4) Scores are fired in the order in which exercises are listed in the tables.

(5) During instruction firing only, when time is available, the firing of each table may be preceded by one or more practice runs.

b. Organization.—For functional purposes, an organization similar to that described in preparatory marksmanship training (par. 62) is suggested. The organization must be modified to meet the requirements of firing live ammunition.

c. Instruction firing.—Before firing on either the 1,000-inch or field firing range, the officer conducting firing will give a general description of the range and announce specific instructions pertaining to firing procedure.

(1) When firing at 1,000-inch moving targets two tanks are placed on the firing line to the right and left of the center stake and as close together as possible with the base of the front sloping plate of turrets 998 inches from the targets for the parallel-level course. Another gun may be added for practice shooting if desired. They are numbered from left to right.

(2) Machine-gun belts are loaded alternate live and dummy rounds, live rounds being first and last in the belt. By this means the gunner is permitted to fire only one round at a time. To reload the gun, the loader pulls the bolt handle back once and releases it. All rounds for a double run may be loaded in one belt provided empty loops are left between the last round of ammunition for the first run and the first round of ammunition for the second run.

(3) (a) The loader secures the ammunition and inspects to see that it is properly loaded in the belt.

(b) The coach (assistant scorer in record firing), gunner, and loader then take position at the gun. The gunner inspects the firing, elevating, and traversing mechanism and indicates that he is ready. The coach transmits this information to the officer conducting the firing.

(c) When all gunners are ready the officer conducting the firing, having previously indicated to the timekeeper at the drum the course to be traveled by the target and the time of exposure for the run, commands: LOAD.

(d) At this command the gunner points the gun in the direction from which he expects the target to appear. The loader fully loads the machine gun and calls "Up." The gunner calls "Ready" when ready to commence the exercise. The coach signals "Ready" to the officer conducting the firing.

(e) When all gunners are ready the officer conducting the firing gives a signal to start the target and at the same time commands: 1. LEFT (RIGHT) FRONT, RANGE 600, ZERO (ONE, TWO) LEAD (S), SILHOUETTE NO. 1 (2), 2. COMMENCE FIRING.

(4) As the phase LEFT (RIGHT) FRONT of the fire order is given, the gunner will start traversing toward the left (right) of the range. Upon its appearance from behind the screen, he will engage the target, using the announced lead and firing the number of rounds contained in the belt.

(5) Immediately upon indication that all guns are ready and without further oral orders, the officer conducting firing will cause the target to be started upon its return run. The gunner engages the target as indicated in (4) above, completing his score. While the target is obscured between runs of a score the gunner will continue to aim at the place where the target disappeared, prepared to reengage it the instant it reappears.

(6) Upon the completion of a score, guns are cleared, targets are brought to the gun positions, and the results recorded, analyzed, and discussed.

(7) Upon orders from the officer conducting firing, targets will be replaced.

■ 77. RULES AND PROCEDURE FOR RECORD FIRING PRACTICE.—a. Record firing practice will consist of firing one of the courses prescribed in section IV. Except as hereinafter specifically stated, or as specifically modified therein, the rules for conducting instruction firing practice as set forth in this section will apply to record practice as well.

b. Each man will complete the prescribed instruction firing for the course specified prior to firing record practice.

c. Once record practice of an individual has commenced, it will be completed without interruption by any other form of firing.

d. As a rule, record firing practice will not be fired by any candidate on the same day that he fires any part of instruction firing practice. However, when the time allotted to range practice is very limited, the officer in charge of range practice may authorize instruction and record firing on the same day.

e. No organization (company or platoon) will conduct instruction firing and record firing practice simultaneously on the same 1,000-inch moving target range unit.

f. Before firing any exercise of record, the gunner will be required, and will be given a reasonable time, to check the condition of his gun, telescope, and ammunition. (See par. 72.)

g. For record firing practice, only one gun (tank) will fire on each 1,000-inch moving target range unit at a time. The tank will be placed so that the pintle of the gun is in the center of the range and 1,000 inches from the target of the parallel runway. (998 inches measured from the base of the front sloping plate of the turret will give the required measurement.) No improvised supports for the gun or gunner will be employed during firing.

h. A gunner and loader only will be at each gun during record firing. The presence of any other individual except the scoring officer and loader at or near the gun while an enlisted man is firing or preparing to fire record practice is prohibited. During this firing, the gunner must perform all of the operations required in firing, such as laying the gun, manipulation, and firing, without any coaching or assistance whatsoever. The loader will only reload the gun and will give no other assistance to the gunner.

i. The power traverse will be used instead of hand traverse on all tanks equipped with power traverse.

j. Each gunner will complete one table of the prescribed qualification course during one order at the gun.

k. The speed of the target and its time of exposure for each run are specified in section II. The decision to disregard a score because of a failure to comply with the specified times or because of faulty operation of the target rests with the scoring officer. He will require that the target be operated in such a manner that it will traverse the prescribed

course for each run at a relatively uniform rate of speed throughout its entire time of exposure. A variance of 3 seconds under or over the prescribed time for any run will be permitted. If the time of exposure exceeds the prescribed time by more than 3 seconds the score will be disregarded. If the time of exposure is less than the prescribed time by more than 3 seconds, the gunner will be required to state whether or not he wants the score to stand before he examines the target. If he chooses to fire the exercise again he will be permitted to do so, otherwise the score will be recorded as fired.

■ 78. STOPPAGES.—*a.* In record firing practice when a misfire, stoppage, or malfunction occurs, the gunner loader will hold up his hand and call "Stoppage." Thereafter neither the gunner nor loader will touch the gun until so instructed by the scoring officer. A scoring officer will examine the gun.

b. If a misfire, stoppage, or malfunction exists which was not the fault of the gunner, the score for that run will be disregarded and the gunner will be permitted to refire that part of the exercise.

c. If the misfire, stoppage, or malfunction is manifestly the fault of the gunner due to incorrect manipulation of the gun, the gunner will not be permitted to refire the exercise. Only that part of the exercise which was completed will be scored.

d. Should a breakage occur, the gun will be repaired or a different gun (tank) will be substituted and that part of the exercise on which the stoppage occurs will be refired. Substituted guns which have been repaired may be retargeted when the scoring officer considers such action justified.

■ 79. SCORING.—*a. General.*—Any departure from the mandatory provisions of this manual will disqualify the man affected for qualification.

(1) After a man has taken his place at the gun, all shots fired by him will count as a part of that exercise except as in paragraph 78.

(2) Failure to use the prescribed aiming silhouette for an exercise or any part thereof will result in hits in the

wrong row of scoring spaces. The gunner will not be permitted to re-fire the exercise and will be scored only those hits which are found in the appropriate space for the designated aiming silhouette.

(3) A hit will be scored for each bullet hole found in the correct scoring space, except that no more hits will be counted in any scoring space(s) than the number of rounds authorized to be fired for the exercise (when a single scoring space is used for each run of an exercise).

(4) The shot holes in the target will be counted. If the number of holes exceeds the amount of ammunition authorized for the exercise, the gunner will be penalized five points for each round in excess of the allowance.

(5) During record firing, the name of the individual will be placed on his target. No person will handle the target until after it is scored except under the direct supervision of the scoring officer or his assistant.

(6) A bullet hole which touches the line of a scoring space will be counted as a hit. (The paper having been broken into a scoring line does not necessarily mean a hit.)

(7) Holes which obviously have been made by ricocheting bullets will be counted as hits. Holes made by rocks or other foreign matter will not be counted.

(8) Ammunition not fired during the time of exposure of the target for each run of an exercise will be forfeited.

(9) After the score has been recorded for each exercise, all holes in the target will be crossed with a pencil mark and covered with a paster.

b. Computation of scores.—(1) Subject to the conditions specified in *a* above, a total of five points will be counted for each hit in a correct scoring space at 1,000 inches and for each hit on the moving target at field range (table III).

(2) The following indicates the total possible score for the three authorized courses:

	Table I	Table II	Table III	Total possible
Course A.....	150	150	50	350

	Table IV	Table V		Total possible
Course B	100	100		200

	Table VI	Table VII		Total possible
Course C	50	50		100

c. Score cards.—A score card will be kept for each person firing. This card will show the scores made during record firing practice. Each individual entry for record practice will be made in ink or indelible pencil and will be authenticated by the scoring officer. Erasures are not permitted. Alterations will be made only by the company commander or the officer who acted as scorer. Such corrections will be authenticated by the officer making the correction. Date of completion of the examination prescribed in paragraph 64 will be entered in the space provided and authenticated by the company commander concerned.

■ 80. INDIVIDUAL CLASSIFICATION AND QUALIFICATION.—For individual classification and qualification scores see AR 775-10.

■ 81. SUSPENSION OF COACHING RESTRICTIONS DURING RECORD FIRING.—The provision of this manual which prohibits coaching during record practice is suspended *during the period for which no additional compensation for arms qualification is authorized*, with the following exceptions:

a. The coach will not use any mechanical aid, such as an aiming device, to assist the gunner.

b. The coach will not touch any part of the gunner's body while the gunner is sighting or firing.

■ 82. MARKSMANSHIP TARGETS.—The targets used for firing marksmanship courses are as follows:

a. *1,000-inch moving target.*—(1) The target frame for all 1,000-inch firing is 3 feet 6 inches by 2 feet 6 inches. It is made of $\frac{3}{4}$ - by $1\frac{1}{2}$ -inch lumber, halved and joined squarely at the corners. The frame is covered with target cloth to provide a bearing surface for the paper target.

(2) The 1,000-inch target is shown in figure 25. Silhouette No. 1 represents the size of a tank at approximately 400 yards, No. 2 represents 700 yards, and No. 3 represents 900 yards.

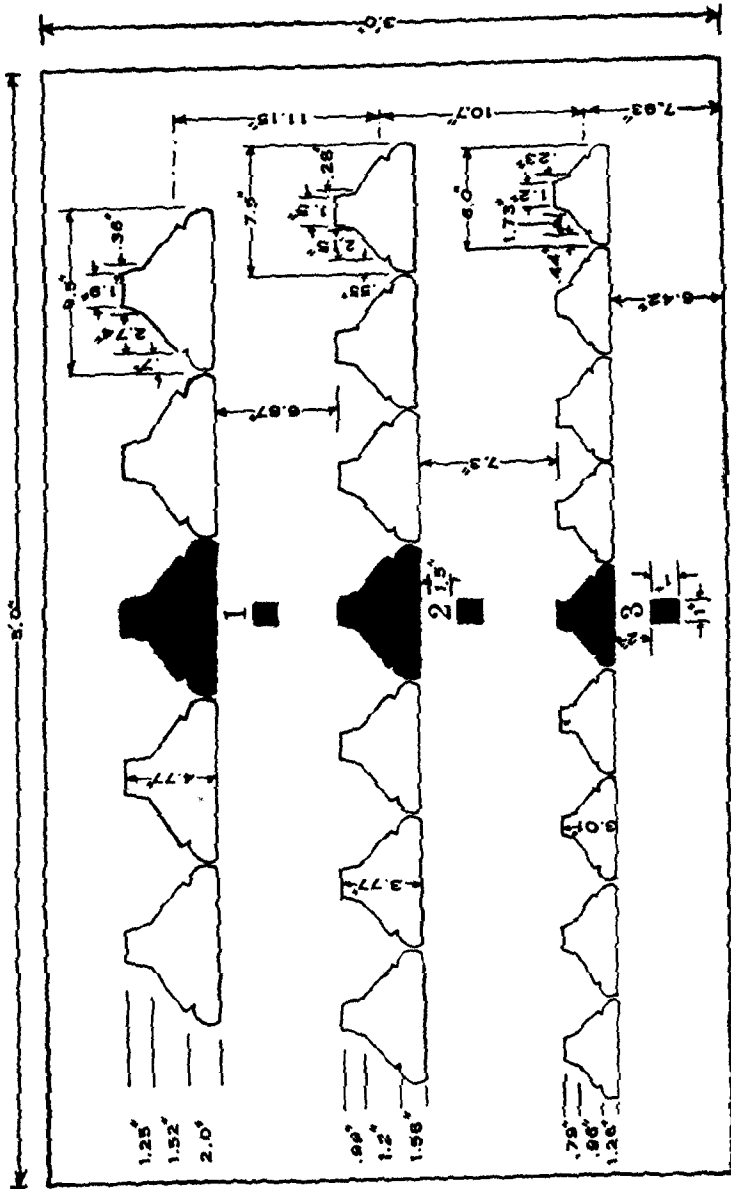

Figure 25.—1,000-inch moving target.

b. Field range 37-mm tank gun target.—The target for field range firing is a 5 by 8 foot plain light-colored panel used when firing the preliminary and record practices of table III.

■ 83. CONSTRUCTION OF 1,000-INCH MOVING TARGET RANGE.—AR 750-10 prescribes the danger areas for target ranges. Due to the small size of the 1,000-inch range, a location can usually be found without difficulty. A level open space about 70 yards long (in the direction of fire) and about 20 yards wide is required for each moving target range unit. A single unit is necessary for each tank platoon. It will greatly facilitate the conduct of 1,000-inch firing to have two of these range units per platoon. A range unit consists of two runways in which a sled target moves to simulate the various directions of movement and speeds of probable combat targets. Movement of the sled is actuated by a wire cable which runs from a hand-operated drum through a system of pulleys and is fastened to both ends of the sled.

a. The dimensions and plan of construction of the two runways, that is, the parallel-level and parallel-hilly courses are given in figure 26. Figure 27 is a sketch of the arrangement of the whole unit showing the positions of the pulleys and the hand-operated drum (reel).

b. Figure 28 shows the hand-operated drum. A commercial wooden cable drum was used to make this reel. The weight and relatively large diameter of the drum tends to resist sudden changes in speed, thus insuring smooth operation of the sled. Two 2½-inch swivel eye pulleys (one is shown in fig. 28) are attached to the base of the drum mount to bring the running cable close to the ground.

c. The offset pulley P2 is a snatch pulley, so placed that when the sled is used on the parallel-hilly course, the wire may be run around it as shown by the dotted lines in figure 27 to take up the slack due to the difference in length of each course.

d. For the parallel course, the wire runs from the reel through P1, P3 to the sled then to P6, P2 and the reel. For the parallel-hilly course the circuit is: reel, P1, P2, P3 to the sled, P5, P6, P7, and reel.

e. The position of the gun (pintle) for record firing is marked by placing a stake in the center of the range against which the center of the forward edge of the hull is placed.

■ 84. TARGET SLED.—The sled in which the 1,000-inch moving targets are mounted should be be heavy lumber in order to provide a low center of gravity which is necessary for smooth operation of the sled. The target holder can be made of $\frac{3}{4}$ -inch material. The sled should be mounted on casters. The standard which is attached to the top of the sled should

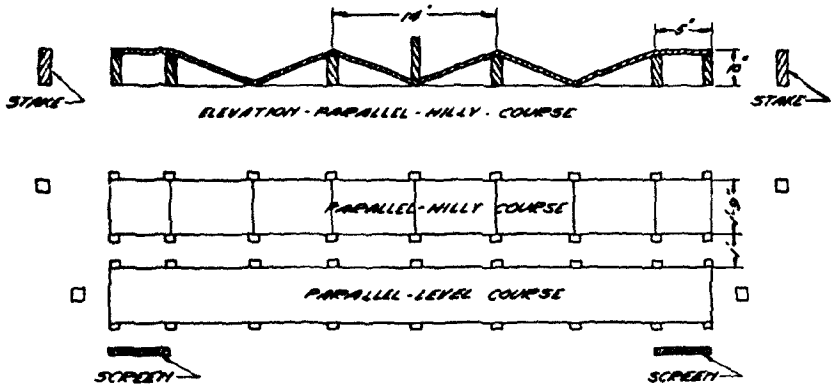

FIGURE 26.—Dimensions and plan of construction; 1,000-inch moving target range.

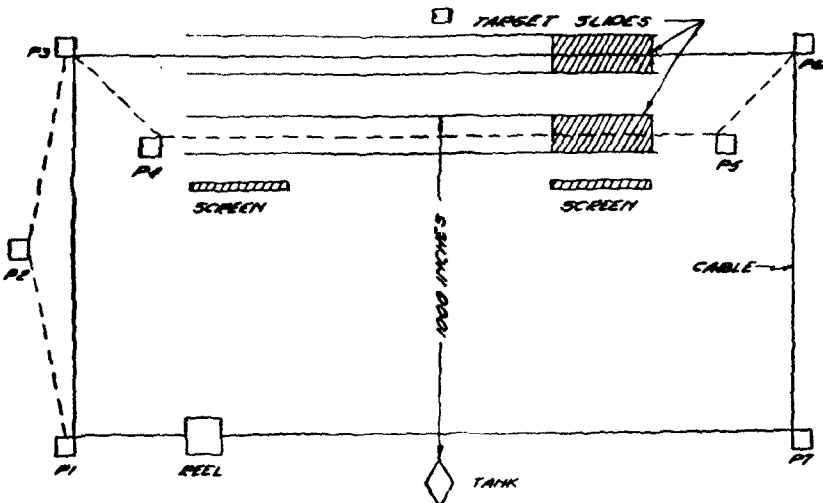

FIGURE 27.—Arrangement of 1,000-inch moving target range unit, showing positions of pulleys and hand-operated drum (reel).

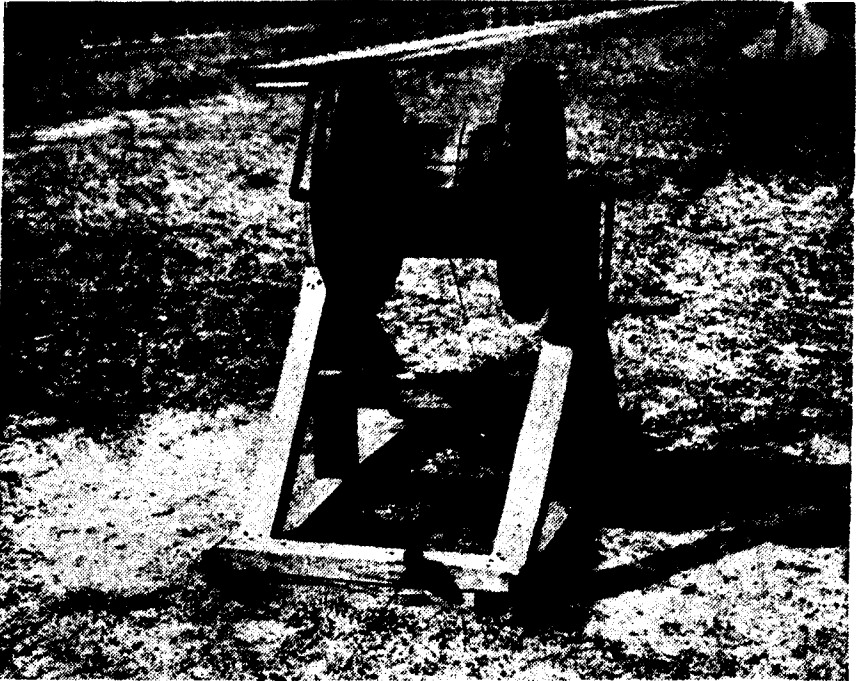

FIGURE 28.—Hand-operated drum (reel), 1,000-inch moving target range.

be made to hold the target firmly and still allow it to be withdrawn easily. A piece of twisted wire cable should be fastened across each end of the sled to provide a means for attaching the snaps of the towing cable.

■ 85. CONSTRUCTION FOR CALIBER 30 OR 37-MM KNOWN RANGE, MOVING TARGET FIRING.—*a.* An approximately level or gently rising piece of ground should be selected for this range. It should be at least 500 yards in depth and of sufficient length to permit convenient operation of the moving target. Figures 29 and 30 show a moving target range, including two methods of towing the target. The construction of pits for the scoring and target details will facilitate scoring and changing targets. It is desirable also to have telephone communication between the pits and the firing line.

b. The set-up shown in figures 29 and 30 is flexible; that is, the length of the target run and the distance between firing line and target can be varied as desired. By placing the gun

in successive firing positions, ranges between 200 and 500 yards may be obtained. Flags are placed as shown in the figures to indicate the right and left firing limit. These limits will vary with the distance from gun to target. They must conform to the conditions prescribed in AR 750-10. The target used when firing on this range is a 5- by 8-foot plain light-colored panel. The panel is mounted, long edge horizontal, on a suitable sled or carriage as indicated in figure 31.

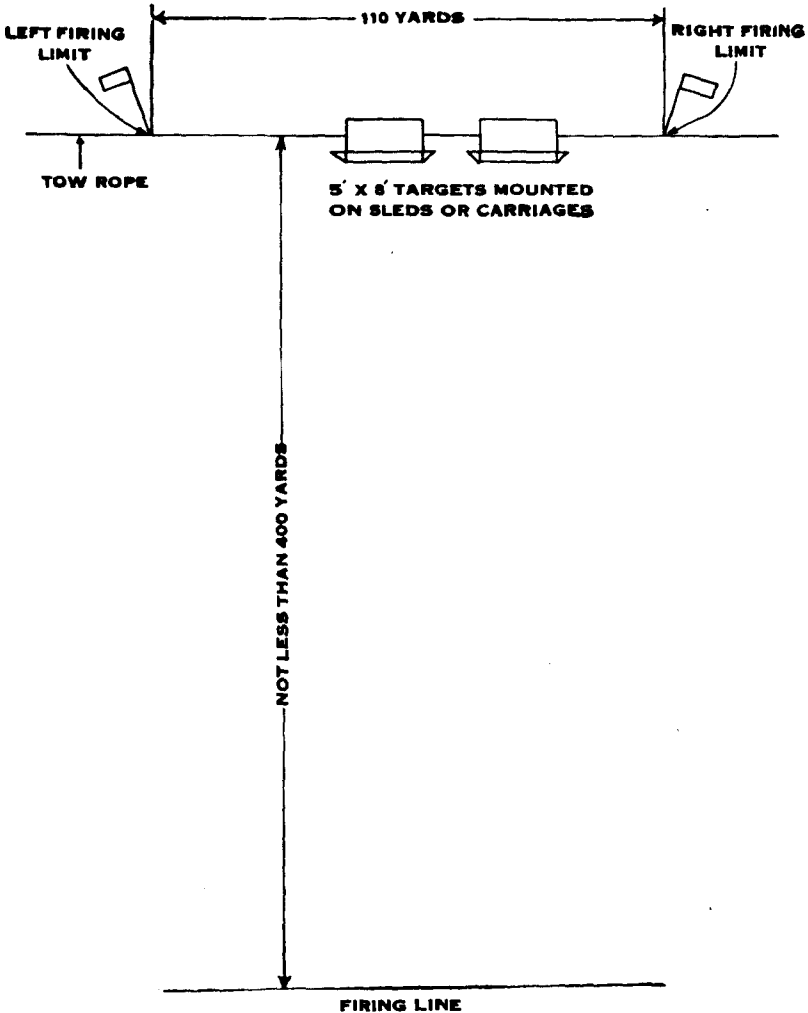

FIGURE 29.—Moving target, range.

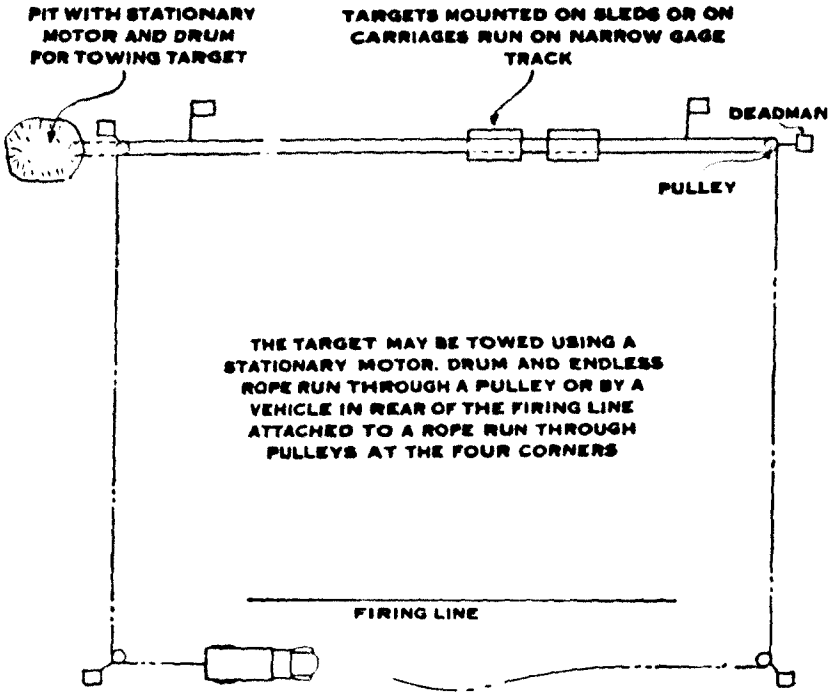

FIGURE 30.—Range for caliber .30 or 37-mm moving field target.

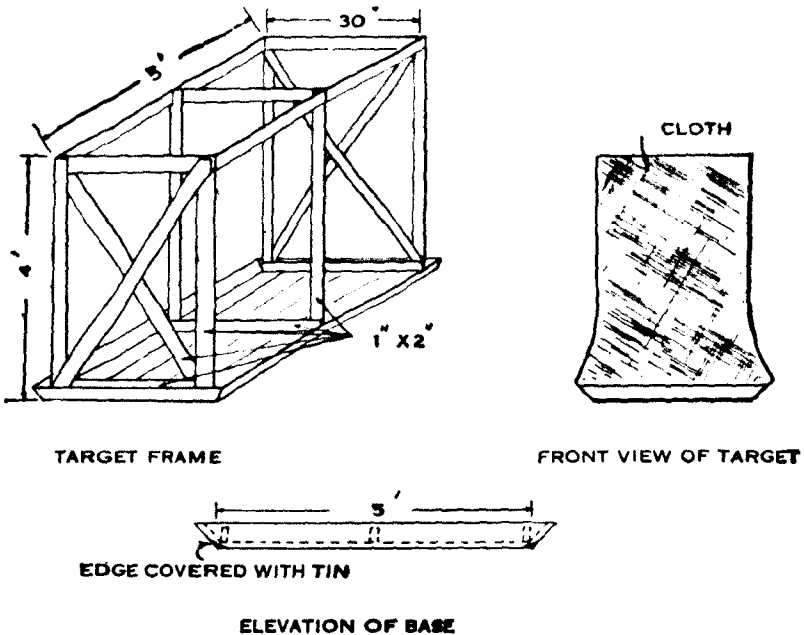

FIGURE 31.—Target frame and sled for towed-target range.

CHAPTER 4

TECHNIQUE OF FIRE

	Paragraphs
SECTION I. General.....	86-87
II. Characteristics and classes of fire.....	88-89
III. Terrain features and their relation to targets.....	90-91
IV. Types of targets and ammunition to be used on each.....	92-93
V. Range determination.....	94-96
VI. Target speeds.....	97-98
VII. Target designation.....	99-104
VIII. Fire distribution, adjustment, control, and orders.....	105-108

SECTION I

GENERAL

- 86. **DEFINITION.**—The application of effective fire on the target is called technique of fire.
- 87. **SCOPE.**—The technique of fire as discussed in this chapter includes—
- Characteristics and classes of fire.
 - Terrain features and their relation to targets.
 - Types of targets and ammunition to be used on each.
 - Range determination.
 - Estimation of target speeds.
 - Target designation.
 - Fire, distribution, adjustment, control, and orders.

SECTION II

CHARACTERISTICS AND CLASSES OF FIRE

■ 88. **CHARACTERISTICS.**—*a.* The 37-mm tank gun M6 is a flat trajectory weapon. At a range of 1,000 yards the highest point of the trajectory is approximately $6\frac{1}{2}$ feet above the line gun-target.

b. The maximum range at 45° elevation with armor-piercing M51 ammunition is 12,750 yards and with high explosive ammunition, 9,000 yards.

c. Poor vision, the oscillating motion of the tank, and the cramped crew compartment, all tend to hamper free use of the gun.

■ 89. **CLASSES OF FIRE.**—*a.* Fire with the gun is classed as fixed or leading with respect to the target and stationary or moving with respect to the tank.

b. Fixed fire is fire where the gunner aims directly at the target, usually a stationary target, a moving target at very close range, or a target moving directly toward or away from the gun on level ground.

c. Leading fire is fire where the gunner aims ahead of or behind a target.

SECTION III.

TERRAIN FEATURES AND THEIR RELATION TO TARGETS

■ 90. **TERRAIN FEATURES.**—Each man must be taught the names of common terrain features such as hill, valley, creek, brush. Instruction is held on a varied piece of terrain where as many as practicable of the desired features can be seen. The instructor points out each feature and by questions assures himself that each man can readily identify them.

■ 91. **RELATION OF TERRAIN FEATURES TO TARGETS.**—The enemy seeks to conceal his installations and movements. Antitank guns will be concealed where they have a good field of fire. Tanks will advance under cover and halt in concealed positions to fire. The instructor when teaching terrain features as in paragraph 90, also points out possible antitank gun and other hostile positions and the routes hostile tanks might take to attack. He conducts the class, on foot, through the areas, pointing out such positions as he goes. If practicable, he has antitank guns and other weapons set up in suitable positions on the terrain. After the class has walked over the terrain they are mounted in tanks, doors are closed, and the tanks are driven through the area.

SECTION IV

TYPES OF TARGETS AND AMMUNITION TO BE USED ON EACH

■ 92. **TARGETS.**—*a.* Targets are engaged first in the order of danger to the tank itself and second their danger to supporting troops. This order is—

(1) Armored vehicles, the armament of which is effective against our own tanks.

(2) Antitank guns and field artillery.

(3) Targets, the reduction of which materially aid the maneuver of our own forces such as—

Lightly armed and armored vehicles.

Machine guns.

Personnel.

b. The switching of fire from one target to another is covered in paragraph 107.

■ 93. **AMMUNITION.**—*a.* The 37-mm armor-piercing projectile is a solid steel slug with tracer in the bore. The projectile contains no explosive charge and a direct hit must be made to be effective.

b. The 37-mm high explosive shell contains a small bursting charge. It is not effective against armor plate.

c. The 37-mm canister contains 123 $\frac{3}{8}$ -inch steel balls. The effective pattern is shown in figure 32. It is used against personnel and may be fired from either a moving or stationary tank.

d. The following table shows in general the weapon and projectile to use for different types of targets:

Target	Weapon and projectile
Personnel	Machine gun. 37-mm canister.
Machine guns, trucks, unarmored vehicles	75-mm HE shell. 37-mm HE or AP projectile.
Armored vehicles, armored AT guns, emplacements.	75-mm HE shell. 37-mm AP projectile. 75-mm AP projectile.

EFFECTIVE AIM: CENTER OF AREA DESIRED TO BE COVERED

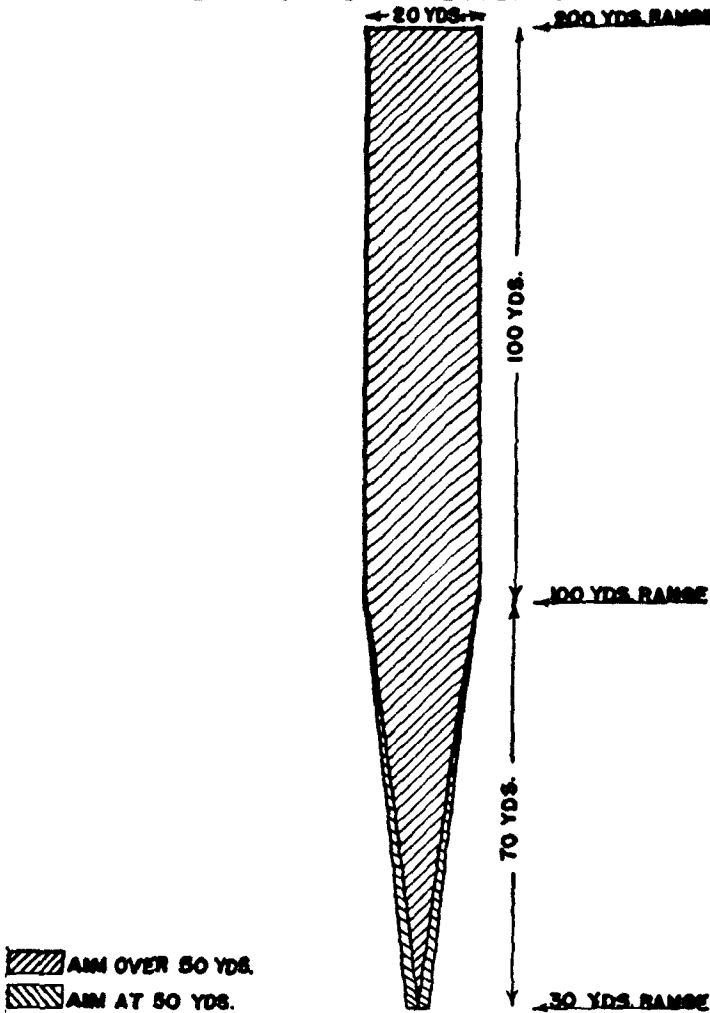

FIGURE 32.—Pattern of 37-mm canister ammunition.

SECTION V

RANGE DETERMINATION

■ 94. METHODS.—There are two methods used for range determination: estimation by eye and firing a gun. Estimation by eye is the principal one used in tank firing.

■ 95. ESTIMATION BY EYE.—*a.* The rapidity with which armored force vehicles move makes necessary some method

of fast range estimation. For this reason firing ranges are divided into short (100 to 400 yards), medium (over 400 to 700 yards), and long (over 700 to 1,000 yards). These are what we call the key ranges and must be thoroughly fixed in mind.

b. Select a varied piece of terrain and place targets at ranges of 300, 600, and 900 yards in various directions from the observation point. Assemble the men on the observation point and explain that—

(1) Objects appear nearer—

(a) When the object is in a bright light.

(b) When the color of the object contrasts sharply with the color of the background.

(c) When looking over water, snow, or a uniform surface such as a wheatfield.

(d) When looking downward from a height.

(e) In the clear atmosphere of high altitudes.

(f) When looking over a depression most of which is hidden.

(2) Objects seem distant—

(a) When looking over a depression most of which is visible.

(b) When there is poor light or fog.

(c) When only a small part of the object can be seen.

(d) When looking from low ground upward toward higher ground.

Cause the men to view the targets under as many of the above listed conditions as can be obtained. After they have firmly fixed in their minds the ranges of 300, 600, and 900 yards, have them mount tanks and view these targets through the sights and vision devices.

■ 96. FIRING THE GUN.—In this method of range estimation the gunner fires on the target with a machine gun and by observation of the tracers and the strike adjusts his fire until it is on the target. He then reads his range from the sight.

SECTION VI

TARGET SPEEDS

■ 97. GENERAL.—Range and speed determine the initial lead to be taken for firing at moving targets. (See par. 62.)

■ 98. **ESTIMATION OF SPEEDS.**—*a.* Select a varying piece of terrain as in section V. From an observation point measure on a line, ranges of 300, 600, and 900 yards and place markers at these points. Assemble the class at the observation point. Explain *leads* as described in paragraph 61 and the importance of accurate determination of the initial lead. The apparent speed of a target increases as it nears the observer. Cause a tank or other vehicle to be driven across the terrain, roughly at right angles to the line of markers, at a range of 300 yards and a speed of 5 miles per hour. Cause the class to note this speed. Next, have a tank driven in same manner at the same speed at 600 and 900 yards and note the apparent difference in speed. Now repeat this procedure having tanks move at 10, 15, and 20 miles per hour. Mount the class in tanks, repeat the above procedure, and have the class view the moving vehicles through the sights and vision devices of the tank.

b. When the men have thoroughly fixed in their minds the key speeds at the key ranges, cause vehicles to be moved at unannounced ranges and speeds. Require each member of the class to estimate the range, speed, and lead.

SECTION VII

TARGET DESIGNATION

■ 99. **GENERAL.**—Two methods are used to designate targets: oral designation and firing a gun.

■ 100. **ORAL DESIGNATION.**—In this method the target is designated by word of mouth with or without mechanical aids such as interphones and radio. Such designation is assisted where practicable by pointing. The three elements of oral target designation are range, direction, and description.

a. Range is announced by the word "Range" followed by a statement of yardage such as "six hundred." The inclusion of the word "yards" is unnecessary and is omitted.

b. (1) Direction is indicated orally and is supplemented by pointing if practicable. Figure 33 shows a method for orally designating direction. For instance direction to target No. 3 should be designated as **RIGHT FLANK**.

(2) When the target is indistinct and there is a distinct terrain feature nearby, direction may be indicated by using the terrain feature as a reference point. Example: Target No. 10 (fig. 33) may be designated by—

RANGE 800, FRONT, SMALL BUSH, LEFT, TEN MILLS (or so many yards), MACHINE GUN.

c. Description consists of a word or two to describe the target such as machine gun, troops, AT gun, tank. When the target is distinct, description may be omitted.

d. The following are examples of target designation (see fig. 33):

(1) *Target No. 8:*

RANGE 900, LEFT FRONT. SMALL HILL AT GUN, ON CREST.

(2) *Target No. 6:*

RANGE 600, LEFT REAR. FENCE CORNER, MACHINE GUN.

(3) *Target No. 2:*

RANGE 700, RIGHT FRONT, TANK.

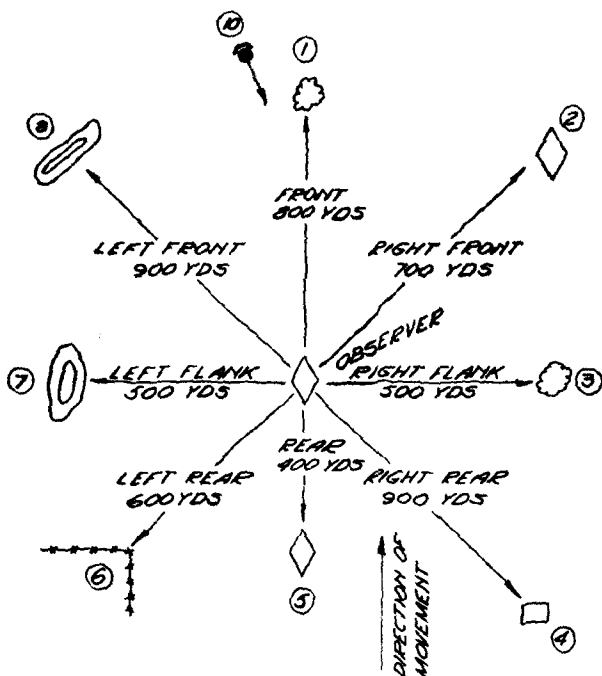

FIGURE 33.—Direction for oral target designation. ("Front" is direction in which observer's tank is moving or is pointed.)

■ 101. **FIRING THE PIECE.**—*a.* In this method the person designating the target says: **RANGE 800** (or as estimated), **FRONT** (or other direction), **WATCH MY BURST**. He then lays on the target with the machine gun, fires and rolls the strike into the target.

b. This method is particularly applicable for the platoon leader to designate targets to other tanks of his platoon using radio. The tank driver may also use the sponson or bow guns as the case may be, to designate targets he has observed. However, as these guns are fixed as to direction and the sponson guns on light tanks fixed as to elevation, he must maneuver the tank to bring fire on the target.

■ 102. **SIGNALS.**—The following signals may be used in target designation:

Attention..... Grasp a portion of the gunner's clothing and jerk him.

Range:

100 to 400 yards.... Expose one finger to the gunner for each 100 yards of range including 400 yards.

500 yards..... Expose fist.

Above 500 yards..... Expose fist for each multiple of 500 yards and one finger for each 100 yards above this range.

Example: 700 yards: exposed closed fist and follow exposure of two fingers.

■ 103. **USE OF RADIO.**—Voice radio is used by the platoon leader to designate targets for individual tanks of his platoon. No complicated code should be used, the platoon leader may merely say watch my burst and fire the caliber .30 machine gun at the target to be designated. *Example:* Tank No. 5—Range 700, watch my burst.

■ 104. **TRAINING.**—Select a varied piece of terrain. Set up various targets, antitank guns, machine guns, and others, in suitable positions. Walk the class through the area and point out the target. Next assemble the class at the observa-

tion point and have them designate the various targets. The men are then mounted in tanks, driven through the area, and designate targets while the tank is moving. The use of tanks and other vehicles moving at various ranges and speeds should be included in this instruction. Men will be required to designate such targets and to announce the lead.

SECTION VIII

FIRE DISTRIBUTION, ADJUSTMENT, CONTROL AND ORDERS

■ 105. FIRE DISTRIBUTION.—*a.* Fire distribution as it applies to the 37-mm tank gun implies the engagement of targets in their order of importance and the use of all guns of the platoon or section to effectively and simultaneously engage several targets. Distribution of fire of the caliber .30 machine guns mounted in tanks is covered in FM 23-50.

b. A single tank engages targets most dangerous to itself. The section or platoon distributes its fire so as to engage targets most dangerous to the section or platoon. In platoon or section formation each tank commander is responsible for targets immediately to his front. In addition commanders of flank tanks are responsible for targets on their flank. Each tank commander observes to his right and left and immediately brings fire to bear on targets in front of other tanks when he is not engaged on his own front. The tank commander must not hesitate to switch fire to a more dangerous target. Figures 34 and 35 show schematically the application of fire under certain assumed conditions.

(1) In figure 34, the platoon is advancing in line. Each tank is responsible for the area to its immediate front. However, gunners do not hesitate to fire on targets in front of other tanks when they are not themselves engaged with more important targets. In the situation in figure 34 an antitank gun at (1) opens fire. Both tanks Nos. (1) and (2) open fire on it. Tank No. 3 opens fire on machine gun at No. (4). Tank No. (3) immediately shifts fire to antitank gun at (3), a more dangerous target than the machine guns. An antitank gun at (2) opens fire and tank No. (1) switches fire to that target. The platoon leader, tank No. (5), controls the

fire of the other tanks and causes his gunner to fire as necessary.

(2) Figure 35 shows tanks attacking with one section covering the target while the other moves to attack.

c. (1) In tank versus tank combat, the tank commander, when practicable, places one section in concealment or defilade to fire on the enemy tanks while with the remainder of the platoon he maneuvers to place himself in the flank of the

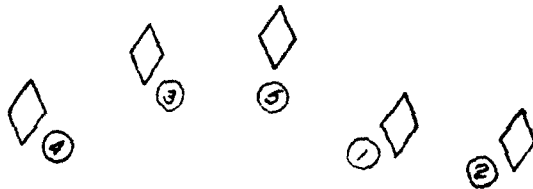
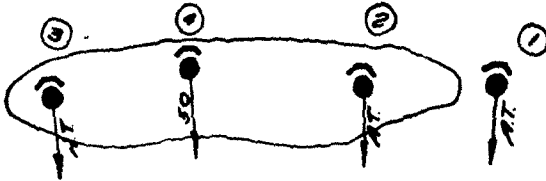

FIGURE 34.—Fire application, tank platoon.

enemy. Figure 36 shows diagrammatically methods of fire distribution when hostile tanks are engaged.

(2) The hostile tank most dangerous to the platoon, section, or individual tank must be engaged first. This does not necessarily mean the closest target as a stationary tank within range is more dangerous than a moving tank. In figure 37 three hostile tanks are approaching. One of these tanks stops, the others continue on toward your tank. Halt

and fire on the halted tank. It is more dangerous as its fire will be more accurate than the fire of the moving tanks. Furthermore fire will be more accurate against the stationary tank than against the moving tanks.

d. The following points should be emphasized:

(1) Fire on the target most dangerous to you or your unit.

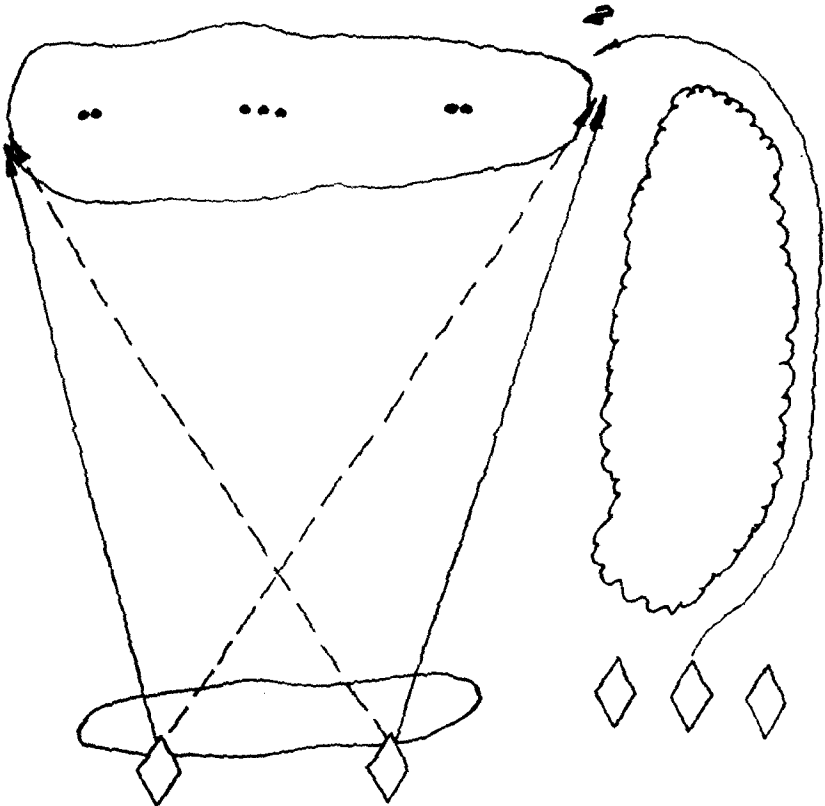

FIGURE 35.—Fire distribution tank platoon in attack showing maneuver.

(2) Do not hesitate to switch your fire to a more dangerous target.

(3) Seek cover or concealment from which you may fire halted. If such cover is not available halt for a few seconds, fire, and then advance.

(4) When under fire advance by zigzagging.

(5) Use fire and movement.

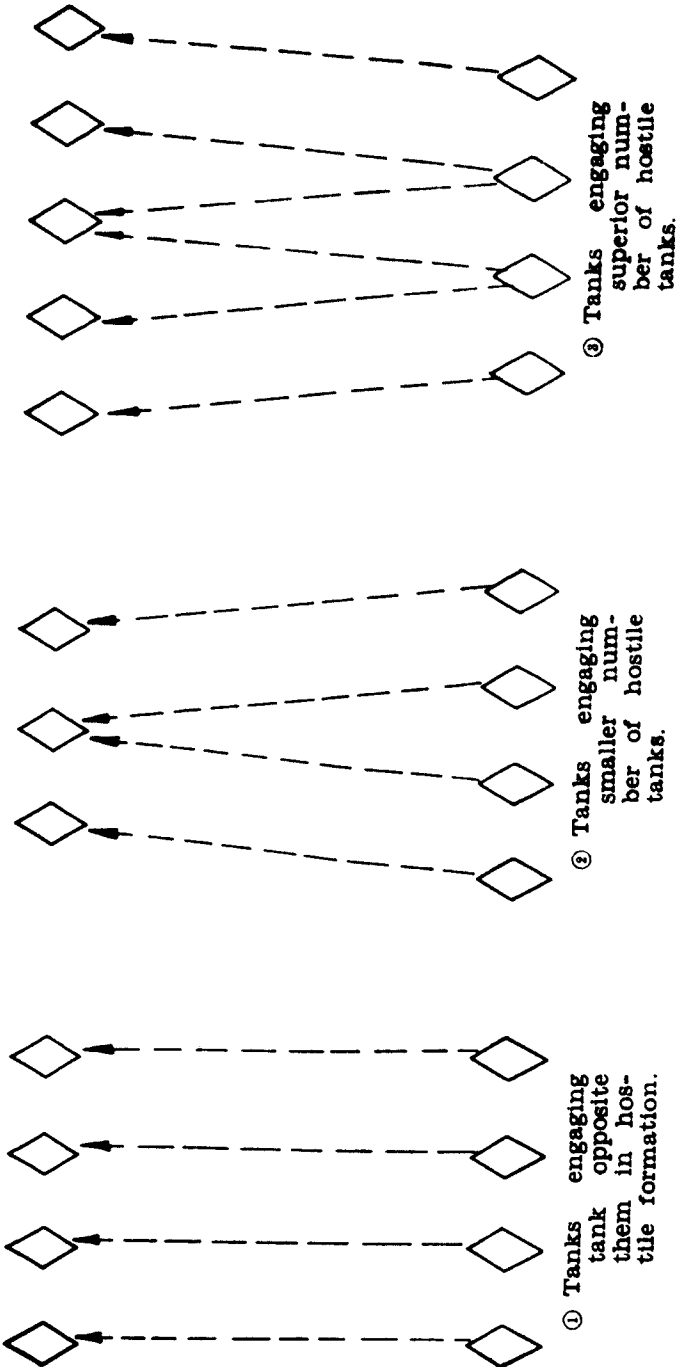

FIGURE 36.—Fire distribution tank versus tank combat.



TANK HALTED



HALT YOUR TANK AND
FIRE IN THE STATIONARY
TANK.

FIGURE 37.—Engaging enemy tanks.

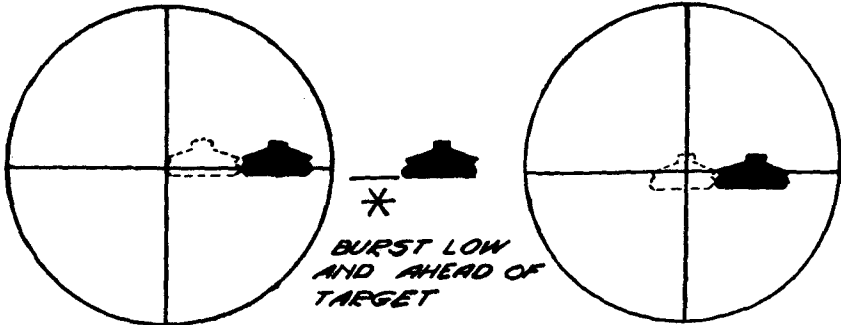

INITIAL AIM

① Cross hair sight.

ADJUSTED AIM
(LESS LEAD AND
GREATER RANGE)

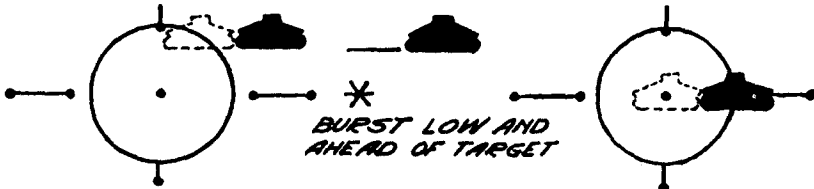

INITIAL AIM

② Dot reticle.

ADJUSTED AIM
(LESS LEAD AND
GREATER RANGE)

FIGURE 38.—Adjustment of fire on moving target.

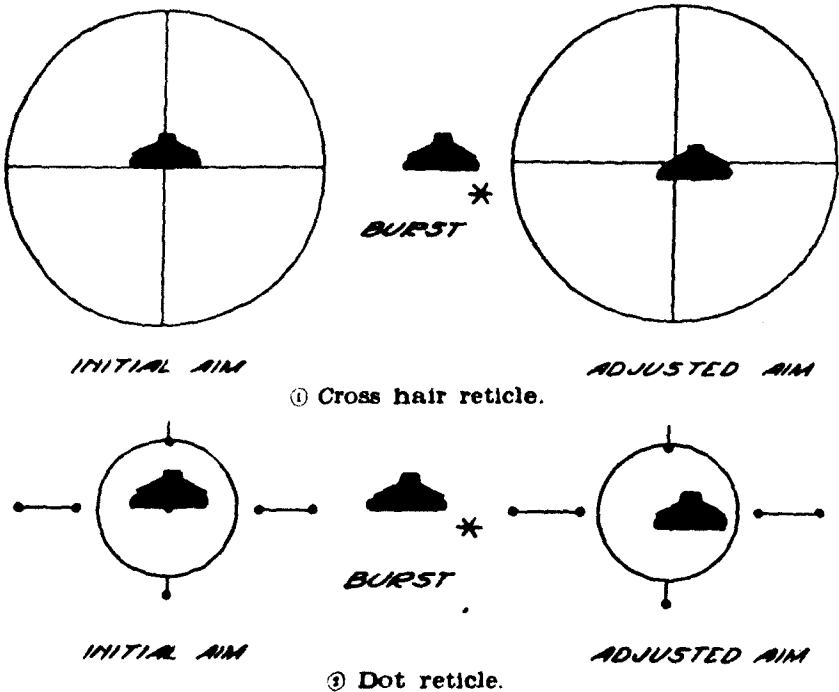

FIGURE 39.—Adjustment of fire on large stationary targets.

■ 106. FIRE ADJUSTMENT.—*a. Moving targets.*—The gunner fires on the target with an estimated range and lead. By observation of his tracer or strike he corrects his aim to make his fire effective. Figure 38 shows a method of fire adjustment on moving targets.

b. Large stationary targets.—The adjustment of fire on large stationary targets is similar to adjustment described in *a* above. (See fig. 39.)

c. Adjustment of fire on small stationary targets.—These targets, being indistinct, are difficult to see clearly in the sight. The relatively large size of the range markings in the dot reticle sight as compared to the apparent small size of the target when looking through sights at long ranges makes aiming at exact points on the target difficult. For the initial round use a range that will insure a burst in front of the target. Then increase the range gradually until the strike is on the target.

d. Observers.—Observers in the tank assist in fire adjustment. The following table shows how they transmit their adjusting data to the gunner:

Sensing	Command	
	Voice	Signal
Over.....	Down, -- yards	Jerk down on clothing once for change of each 100 yards of range desired.
Short.....	Up, -- yards	Jerk up on clothing once for each 100 yards of change of range desired.
Left.....	Right, -- leads	Jerk right on clothing number of leads of change desired.
Right.....	Left, -- leads	Jerk left on clothing number of leads of change desired.
Ahead (moving target).....	Decrease, -- leads	Jerk right (left) on clothing number of leads of change desired.
Behind (moving target).....	Increase, -- leads	Jerk right (left) on clothing number of leads of change desired.

■ 107. FIRE CONTROL.—*a. General.*—Fire control implies the ability of the leader to open fire at the instant he desires, adjust the fire of his guns upon the target, switch fire to other targets, and cease firing at will. Fire control is more by individual tank than by platoon after the assault begins.

b. Initial attacks.—When practicable, the platoon leader points out targets on the ground or designates primary areas of responsibility for each tank commander. Such designation may be, for example: Tank No. 2, watch for targets in the edge of the woods on the right; Tank No. 3, watch that clump of bushes to the front; and so on for each tank. The platoon leader may give instructions for tanks to open fire when they have reached a certain point or when fired upon. If part of the platoon is used on an enveloping movement and part for covering fire, he tells the commanders of the tanks covering the approach, when to open fire.

c. During attack.—During the attack the platoon leader controls the fire by voice radio and by signals. Radio messages must be short and distinct. During the attack the time of opening fire is left primarily to the tank commander and gunner. Fire is opened as soon as a suitable target is lo-

cated except when specific orders have been given to withhold fire in order to keep from disclosing positions or movements.

■ 108. FIRE ORDERS.—*a. General.*—Fire orders for tanks must be brief and simple. They usually consist of—

Range.

Direction.

Description.

Lead (moving targets only).

Time of opening fire.

b. Examples.—(1) RANGE 500, RIGHT FRONT, TANK, TWO LEADS, COMMENCE FIRING.

(2) RANGE 800, FRONT, MACHINE GUN NEAR DEAD TREE, COMMENCE FIRING.

(3) RANGE 600, FRONT, DEAD TREE, RIGHT 50 YARDS, AT GUN, COMMENCE FIRING.

c. Cease firing.—On command of the leader or, when the target has been destroyed, passes from view, or out of range, the gunner ceases firing.

CHAPTER 5

COMBAT FIRING PRACTICE

■ 109. **GENERAL.**—*a.* Combat firing is that firing which finally prepares the tank gunner to engage battlefield targets. It is held on field ranges and simulates as far as safety regulations and ranges will permit, the actual engagement of an enemy.

b. Caliber .30 tracer ammunition is used for most of the exercises but 37-mm target practice ammunition should be used to finish the training.

c. Exercises are held for individual tanks, tank sections, and tank platoons.

d. Before engaging in combat firing practice the gunner should have completed the marksmanship course and have been thoroughly instructed in the technique of fire as given in chapter 4.

e. For ranges and their construction see paragraph 112.

f. Paragraphs 110 and 111 outline exercises that may be given for combat practice firing. There are no prescribed exercises. Each unit must fit the training to the ammunition and ranges available.

g. All firing is conducted with drivers doors closed.

h. Each exercise must be presented in the form of a problem with a combat situation stated. A critique will be held after each exercise.

■ 110. **SINGLE TANK EXERCISES.**—*a. Adjustment of fire.*—(1) *General.*—For these exercises caliber .30 tracer ammunition is used.

(2) *Stationary targets.*—(a) Place 3- by 5-foot screen targets at various ranges up to 900 yards from the gun and number each. Explain and demonstrate the methods of fire adjustment on large and small stationary targets as explained in chapter 4.

(b) Require each gunner to estimate the range and adjust on at least three of the targets. Not more than five rounds should be used for each target.

(3) *Moving targets.*—Use a moving target range similar to that in figure 30. Explain and demonstrate to the class the method of adjusting fire on moving targets, as described in chapter 4. Gunners then take their position and adjust on a moving target.

b. Firing at fixed targets.—(1) Several fixed targets are placed on the range at varying ranges. These should be partially concealed. If practicable, disappearing targets are used. The silhouette target *E* single or double may be used. For the longer ranges an 8 by 8 frame covered with target cloth and painted an olive-drab color should be used. The gunner takes his position at the gun. The tank commander using oral means designates a target to the gunner. The gunner immediately lays on the target and fires not more than five rounds. The tank commander then designates another target and the procedure is repeated. The disappearing targets are raised unexpectedly and the tank commander, if the gunner does not see such target, designates it to him. Caliber .30 tracer ammunition is used in this exercise.

(2) Using a set-up similar to (1) above, have the tank move down the range. As a target is designated or as he picks up the target, the gunner calls for the driver to stop. He then fires on the target. After firing five rounds he signals the driver to proceed.

c. Firing at moving targets.—Use either caliber .30 or 37-mm TP ammunition. Start the tank down the range and after it has gone about 100 yards give signal for starting the moving targets. The gunner signals the driver to stop the tank. He then fires at the target.

■ 111. PLATOON AND SECTION FIRING.—*a. General.*—These exercises should be conducted both with caliber .30 tracer and 37-mm target practice ammunition. Within the ammunition available and suitability of available ranges, exercises should be conducted to train the section or platoon in—

Control for the initial attack.

Control during attack.

b. Control for initial attack.—(1) *Purpose.*—To teach initial designation of targets by the platoon or section leader to his tank commanders. To teach the proper method of

using covered approaches and of firing from defiladed or concealed positions.

(2) *Method*.—Place fixed targets on the range at varying distances from the rear of the range. Assemble the platoon under cover in rear of the range at such distance that an approach of at least $\frac{1}{2}$ mile must be made before initial firing positions can be occupied. From an observation point, give the situation to the platoon leader and point out the targets. The platoon leader is then permitted to bring his tank commanders forward to select routes of approach and to receive information on the situation. The platoon leader conducts his platoon forward, occupies initial firing positions and engages the targets. He is not permitted to move forward from the initial firing positions.

c. Control during attack.—(1) *Purpose*.—To teach control during the attack. To teach fire distribution and the prompt engagement of the most dangerous targets.

(2) *Method*.—Place fixed targets as in *b* above, and some disappearing targets. Have some moving targets installed. Proceed as in *b* above. The platoon will be permitted to move forward at any time after reaching the initial firing positions. As it moves down the range have the various disappearing targets appear and disappear. As the platoon reaches a certain designated point on the range, give a signal for starting and moving targets. Have the platoon halt after reaching a designated line marked with flags.

d. Simulated guns.—These exercises can be made more interesting and instructive by using simulated guns, that is, logs or other material for antitank guns and by use of smoke to indicated a hostile gun firing.

e. Check.—Check on the initial fire orders, fire distribution, use of fire and movement, use of concealed or defiladed positions, and prompt engagement of disappearing and moving targets. The officer conducting the firing should listen over another radio set to the orders given by the platoon leader.

■ 112. CONSTRUCTION OF TARGETS, RANGES, AND EQUIPMENT.—

a. Arrangement.—The range shown in figure 40 may be modified to suit limiting conditions such as available terrain and equipment.

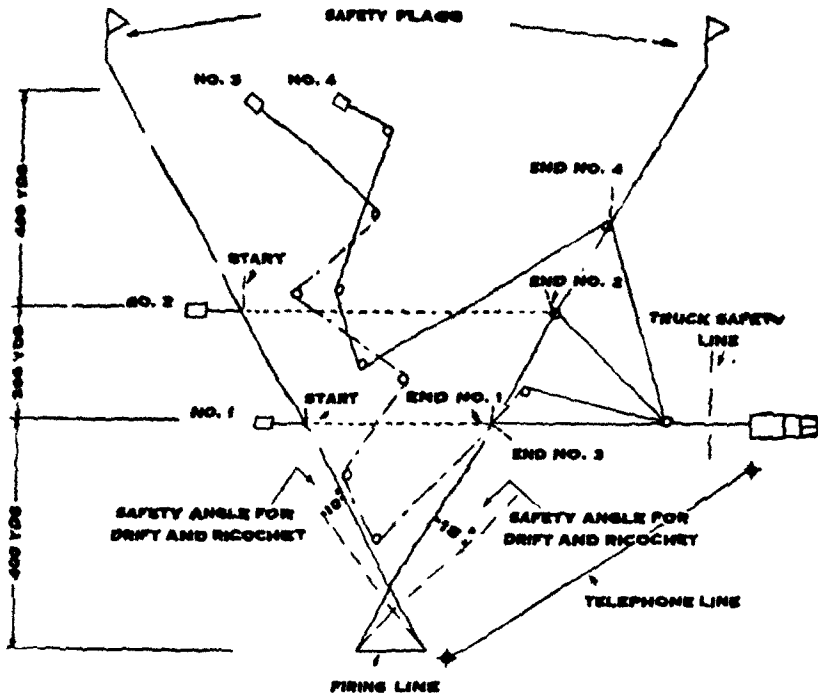

FIGURE 40.—Range for firing 37-mm ammunition at stationary or towed targets.

b. Terrain.—The terrain selected should permit changes in elevation as well as direction. The course may be extended to obtain ranges up to 1,200 yards.

c. Towrope and accessories.—(1) A $\frac{1}{4}$ -inch wire cable may be used for towing, but is difficult to splice; unless the ground is rocky, a $\frac{3}{4}$ -inch manila hemp rope is better.

(2) Figure 41 shows the pulley lay-out to create changes in direction of the target. In the absence of pulleys, a piece of 4-inch pipe, driven into the ground until 5 or 6 inches protrude, will serve. With the pulley arrangement, the towrope is attached to the top edge of the target sled and a large knot about 8 inches in diameter, or preferably a wooden ball, is placed in the rope approximately 15 feet ahead of the target to cause the rope to jump the pulley. If the pipe is used, the towrope is attached to the target on a special bracket about 18 inches from the ground.

(3) A drum similar to the one shown in figure 42 is installed at each curve in the road traveled by the towing vehicle.

(4) Details of construction of the sled target are shown in figure 31. A larger target, more nearly corresponding to the size of a tank, may be used; however, its increased weight will reduce smoothness of operation.

■ 113. SAFETY PRECAUTIONS.—*a.* Range areas and safety precautions for 37-mm tank guns firing must conform with instructions set forth in AR 750-10.

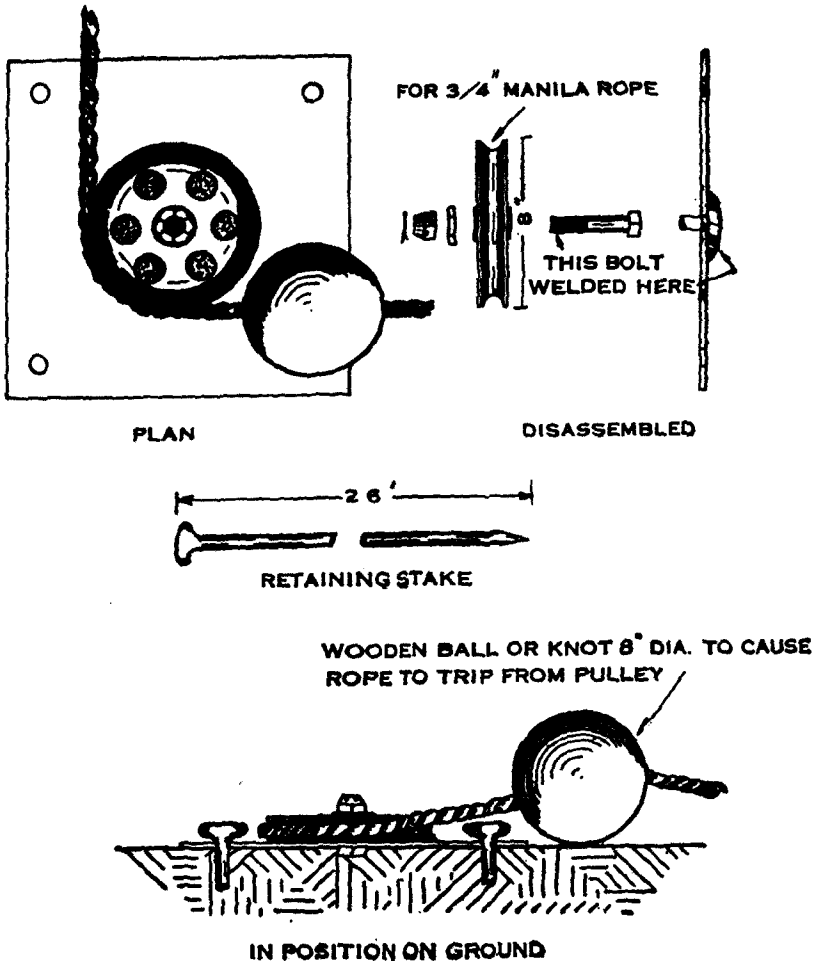

FIGURE 41.—Pulley lay-out for towed-target range shown in figure 40.

b. Additional safety precautions.—(1) *Misfires.*—The procedure in handling misfires during training and target practice is explained in chapter 1.

(2) *Precautions when firing high-explosive shell.*—The fuze of the high-explosive shell used in the 37-mm tank gun is not bore safe. Therefore, during training and target practice, it is necessary to provide positive protection against premature bursts in or out of the bore for persons in vicinity of the firing point. The form of protection required is specified in AR 750-10. To comply with these instructions, the

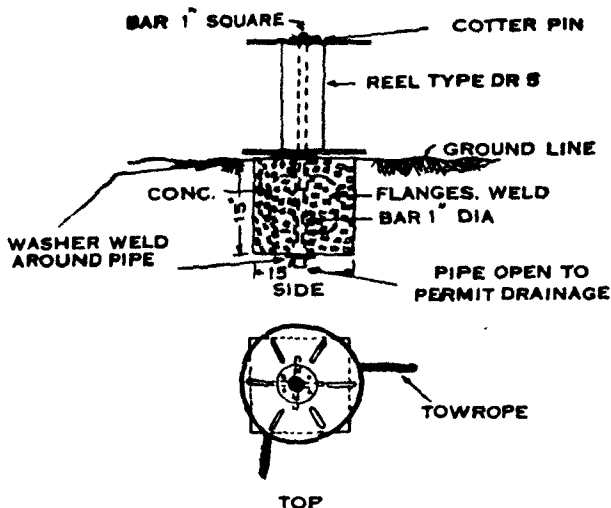

FIGURE 42.—Roadway drum for towed-target range shown in figure 40.

gun crew and all other persons within an area of 200 yards from the firing gun must be protected by one of the methods specified.

(3) *Additional range precautions.*—(a) Markers will be placed so as to define clearly the right and left limits of fire.

(b) The starting point of the towing vehicle will be a safe distance on the flank opposite to that on which the target appears.

(c) Vehicles and personnel working on the course will be equipped with red flags and must be directed by definite signals or commands.

(d) There will be a safety officer or noncommissioned officer for each firing gun who will see that the gunner—

1. Never endangers the target detail.
2. Never fires outside the prescribed safety limits.
3. Ceases firing upon command.
4. Clears his gun and stands away from it before the target detail moves onto the range.
5. Does not load until the range is clear.

CHAPTER 6

ADVICE TO INSTRUCTORS

	Paragraphs
Section I. General.....	114-117
II. Mechanical training.....	118-124
III. Training for placing gun in action.....	125-128
IV. Marksmanship.....	129-131
V. Combat firing practice.....	132-133

SECTION I

GENERAL

■ 114. **PURPOSE.**—The provisions of this chapter are to be accepted as a guide and will not be considered as having the force of regulations. They are particularly applicable to emergency conditions when large bodies of troops are being trained under officers and noncommissioned officers who are not thoroughly familiar with approved training methods.

■ 115. **ASSISTANT INSTRUCTIONS.**—When practicable a number of noncommissioned officers and selected privates are given prior instruction in order to act as assistant instructors for the remainder of the organization.

■ 116. **METHOD OF INSTRUCTION.**—The applicatory system of instruction as given in FM 21-5 is used.

■ 117. **ALLOTMENT OF TIME IN TRAINING PROGRAM.**—*a.* A total allotment of approximately 218 hours is considered suitable for training a tank unit in the matter contained in this manual. Training in combat fundamentals of the various tank units, squad, platoon, etc., should proceed concurrently with technical instructions. The following apportionment of time is suggested:

	<i>Time allotted (hours)</i>
Subject:	
Mechanical training.....	40
Training for placing gun in action.....	16
Marksmanship.....	74
Technique of fire.....	20
Combat practice firing.....	68

b. The above hours may be changed to meet local conditions and the state of training of the men undergoing instruction.

SECTION II

MECHANICAL TRAINING

■ 118. GENERAL.—*a.* Instruction in mechanical training lends itself readily to the use of the applicatory method of instruction.

b. The unit under instruction is divided into groups of four to eight men each. Each group is assembled at the place of instruction with its own gun or set of equipment under the direct supervision of an assistant instructor.

c. Instruction is centralized under the unit instructor. The assistant demonstrates each step of the particular phase of instruction as explained by the instructor. For short periods of practical work instruction is decentralized under the assistant instructors.

■ 119. DISASSEMBLING AND ASSEMBLING.—*a.* Men are instructed in the disassembly and assembly of the gun to include only those groups described in chapter 1.

b. Each man is required to disassemble and assemble each group and give the nomenclature of each part of the group as he handles it.

■ 120. CARE AND CLEANING.—*a.* The various elements of preventive maintenance are explained.

b. The various materials which are authorized for cleaning, lubricating, and preserving the different parts of the gun are exhibited and their use explained.

c. Various parts to be lubricated, kind of lubricant, and schedule for lubrication are discussed. Necessary modifications in this schedule to meet the different conditions under which the equipment is being used should be discussed.

d. The method of filling the recoil cylinder as described in paragraph 26 is demonstrated by the instructor.

■ 121. FUNCTIONING.—The use of charts or models to illustrate the functioning of the various groups will facilitate instruction in this subject. The men should be taught to visualize the functioning of the parts rather than to memorize it. To accomplish this, the instructor describes the action of one part upon another in its proper sequence as a chain of events proceeding logically from cause to effect.

■ 122. STOPPAGES AND IMMEDIATE ACTION.—It is not practicable to prepare actual stoppages without damage to the gun. The instructor should, however, thoroughly explain the causes of different stoppages and how to detect them. The action to be taken for each type of stoppage is explained and the men are required by their group instructor to give similar explanation in their own words calling upon other members of the group for corrections until each has a practical working knowledge of the subject.

■ 123. MOUNTING THE SIGHT IN VEHICLE.—See paragraph 35.

■ 124. ACCESSORIES.—Instruction in the use of accessories is accomplished concurrently with other mechanical instruction.

SECTION III

TRAINING FOR PLACING GUN IN ACTION

■ 125. GENERAL.—The 37-mm gun is mounted in and dismounted from tanks by Ordnance Department personnel.

■ 126. REPEATED CHANGING OF TELESCOPE DURING TRAINING.—Since it has a tendency to wear down the bearing surfaces on the telescope and mount, repeated installing and removal of the telescope from the telescope holder should be avoided during elementary drill.

■ 127. MANIPULATION OF TRIGGER ACTUATOR.—Constant manipulation of the trigger actuator on an empty chamber in true simulation of fire during training for placing the gun in action will not cause damage to any part of the mechanism. This same fact is applicable to preparatory marksmanship and field firing exercises.

■ 128. POWER TURRET.—When the power turret is to be used extensively on the range, arrangements must be made for changing the battery in the light tank. The medium tank has an auxiliary battery charger.

SECTION IV

MARKSMANSHIP

■ 129. GENERAL.—*a.* Marksmanship is the basic step in training the gunner to employ his weapon successfully in combat. A gunner will subconsciously apply in combat the funda-

mentals he has been taught in marksmanship, hence these fundamentals must be sound. This fact should be kept uppermost in the mind of the instructor and constant effort made to eliminate artificialities which tend to creep in for the purpose of obtaining high scores.

b. The procedure used in conducting marksmanship instruction parallels closely that used for mechanical training except that it is of necessity more decentralized. During instruction in the preparatory exercises, the entire unit is initially assembled and attention focused on the instructor and a single demonstration unit. Following the demonstration, the groups move to their individual sets of equipment for practical work under the direct supervision of assistant instructors.

c. Firing exercises on the 1,000-inch range, except for tanks firing on a stationary target, are best conducted under centralized control.

■ 130. PREPARATORY RANGE TRAINING.—a. When the range is not available or for short periods in the daily schedule in advance of the regular marksmanship season, many of the preparatory exercises can be conducted on the drill field in the vicinity of barracks. This advance training will expedite the conduct of marksmanship training during the regular season.

b. In the event any of the tracking exercises described in paragraph 62 are conducted, an arrangement of the tanks similar to that described in paragraph 60 should be employed. A sled similar in design to the one used on the 1,000-inch moving target range may be adapted for towing between the line of guns by fastening ropes to both ends. Some of the exercises may have to be modified to meet the lack of facilities normally found on the 1,000-inch range. Hills of dirt similar to those found on the 1,000-inch range may be easily improvised.

■ 131. ORGANIZATION OF WORK.—a. Careful thought must be given to allotment of personnel and use of time during marksmanship training.

b. A schedule should be prepared making specific allotment of time for each step in the training. The progress of the

individual man should be watched carefully and recorded to insure that the instruction is progressing satisfactorily and that all men understand the instruction being given. Frequent rotation of duties within each group, with each man performing each phase of an exercise several times, is preferable to keeping one man at one position a long time.

c. When firing on the 1,000-inch range is contemplated, a sufficient number of targets should be prepared well in advance and the necessity for other equipment and spare parts foreseen so that firing need not be stopped because of failure to anticipate needs.

(1) The following is a check list of equipment necessary for training on the 1,000-inch range:

Target frames and different type targets.

Target paste and paste brush.

Pasters (black and white).

Ammunition, caliber .22.

Stop watch.

Pencils.

Record of progress.

Repair tools for guns and range.

(2) *Prior to day of firing—*

(a) Repair and have in working order all range equipment and apparatus.

(b) Bore sight each gun to be fired.

(c) Have orders ready for firing.

(d) Have a chart for recording all scores fired.

(e) Check with range officer on availability of range and mark range with safety flags.

d. The prompt publication on a bulletin board of the score made during instruction and record practice will be of great value in stimulating interest and arousing a spirit of competition.

SECTION V

COMBAT FIRING PRACTICE

■ 132. CONDUCT OF FIRING EXERCISES.—*a.* The instructor acts as umpire in all exercises combining the various elements of training to place the gun in action and firing at a towed target. He presents the situations, observes execution of the exercise, and conducts the critique.

b. In the early stages of training, value of the instruction may be increased by suspending the exercise and commenting upon errors at the time they are made. As training progresses, an exercise should be permitted to continue regardless of errors. As a general rule, the instructor should interfere as little as possible during the progress of an exercise and allow the tank, section, or platoon commander to solve the requirements in his own way.

c. In all exercises, the time of starting the target on its course is artificial insofar as simulating actual combat conditions are concerned. However, this feature cannot be avoided due mainly to the fact that on most ranges the time required for the target to traverse its course is so short that, if it is released at the start of an exercise, time will not be sufficient to engage it. Consequently, the time for releasing the target is specified in each exercise. If desired, this time may be varied to meet local range conditions. It is necessary, however, to coordinate the time of release with the operation at the gun(s).

■ 133. CRITIQUE.—a. The basis of good instructions in these exercises is intelligent, tactful, and constructive criticism. The critique should constitute a discussion of each step in the solution of the requirements. It should be given on the ground used for the exercise immediately after the conclusion of the exercise.

b. The officer conducting the critique should commend that which was well done and call attention to that which was poorly or incorrectly done. Where errors have been committed, a correct solution should be indicated. In making corrections, the instructor should avoid ridicule, sarcasm, or any remarks which might be harmful to moral or initiative or which might lead to a dread of assuming responsibility.

c. He must be careful not to base his judgment of execution of the exercise too much on effect of the firing. The proper fire orders and fire control must be given due consideration.

INDEX

	Paragraph	Page
Barrel assembly.....	1	1
Breechblock assembly:		
Assembly and disassembly.....	6	15
Care and cleaning.....	24	26
Description.....	1	1
Opening.....	11, 16	19, 21
Breech operating mechanism:		
Description.....	1	1
Functioning.....	15, 16	20, 21
Breech ring:		
Description.....	1	1
Firing and extracting mechanism.....	8	17
Care and cleaning:		
After firing.....	22, 31	23, 32
Ammunition.....	46	50
Before drill or firing.....	22, 31	23, 32
Bore, chamber, breech ring.....	24	25
Breechblock.....	24	25
Cleaning material.....	22	23
Cold weather.....	29	32
During firing.....	22, 31	23, 32
Filling recoil cylinder.....	26, 31	28, 32
Garrison.....	24	25
General.....	22	23
Lubrication.....	25, 31	27, 32
Material affected by gas.....	27, 28	31
Outer surfaces of gun.....	24	25
Special precautions.....	23	24
Storage.....	30	32
Trigger actuator mechanism.....	24	25
Characteristics of fire.....	88	89
Classes of fire.....	89	90
Classification, marksmanship.....	80	82
Closing spring and housing:		
Description.....	1	1
Disassembly and assembly.....	7	16
Functioning.....	15, 19	20, 22
Combat firing practice:		
Construction of ranges.....	112	107
Equipment.....	112	107
General.....	109	105
Platoon and section firing.....	111	106
Safety precautions.....	113	109
Single tank exercises.....	110	105
Description of gun.....	1	1
Designation of targets:		
Firing gun.....	101	96
General.....	99	94
Oral.....	100	94
Signals.....	102	96
Training.....	104	96
Use of radio.....	103	96

INDEX

	Paragraph	Page
Disassembly:		
Breechblock	6	15
Closing spring and housing	7	16
Firing and extracting mechanism group of breech ring	8	17
Firing pin and guide assembly	5	14
Trigger actuator mechanism	9	18
Elevating mechanism	1	1
Extractors:		
Description	1	1
Disassembly and assembly	8	17
Functioning	11, 17	19, 21
Fire—		
Adjustment	106	102
Control	107	103
Distribution	105	97
Orders	108	104
Firing and extracting mechanism of breech ring:		
Description	1	1
Disassembly and assembly	8	17
Functioning	10-21	18
Firing pin and guide assembly:		
Description	1	1
Disassembly and assembly	5	14
Functioning	14	20
Functioning:		
Automatic opening of breech	16	21
Backward movement of barrel assembly	15	20
Cocking action	18	21
Extractors	17	21
Firing pin and guide assembly	14	20
Forward movement of recoiling parts	19	22
General	10	18
Loading	11	19
Recocking	20	22
Safety features	21	22
Trigger	13	19
Trigger actuator	12	19
General data:		
Capacity of recoil cylinder	2	13
Elevation	2	13
Length of barrel	2	13
Length of recoil	2	13
Total weight of gun	2	13
Traverse	2	13
Immediate action	33	33
Individual safety precautions:		
Before firing	50	52
During practice firing	48	51
General	47	51
Inspection during firing	48, 49	51
Marksmanship	71	74
Misfires	51	52
Interchanging of tubes	1	1

INDEX

	Paragraph	Page
Lead exercises.....	61	58
Lubrication.....	25	27
Marksmanship:		
Advice to instructors.....	129-131	114
Aiming exercises.....	61	58
Ammunition.....	74	76
Area of instruction.....	60	58
Coaches.....	70, 81	70, 82
Computation of scores.....	79	80
Construction of ranges.....	83, 85	84, 86
Course A.....	66	68
Course B.....	67	69
Course C.....	68	70
Duties of personnel.....	70	70
Equipment.....	59	58
Guns, mounts, telescopes.....	72	75
Individual classification and qualification.....	80	82
Lead table.....	61	58
Method of instruction.....	57	57
Phases of training.....	55, 58	57, 58
Preliminary gunner's examination.....	64	66
Prior training.....	56	57
Procedure for firing.....	76	76
Range practice, general.....	65	67
Record of progress.....	83	65
Record practice.....	77	78
Safety precautions.....	71	74
Score cards.....	79	80
Scoring.....	79	80
Scoring officers.....	70	70
Stoppages.....	78	80
Target sled.....	84	85
Target speeds.....	62	62
Targeting.....	73	76
Targets.....	75, 82	76, 82
Tracking exercises.....	62	62
Periscope sights.....	35	36
Points to be observed before, during, and after firing.....	31	32
Power traverse:		
Description.....	37	43
Operation.....	38	43
Precautions:		
Care and cleaning.....	24	25
Combat range.....	113	109
Individual.....	47-51	51
Marksmanship.....	71	74
Qualification, individual.....	80	82
Ranges:		
Construction.....	83, 95, 112	84, 92, 107
Determination.....	94, 95, 96	92, 93
Recoil mechanism:		
Description.....	1	1
Filling cylinders.....	26	28
Functioning.....	15, 19	20, 22

INDEX

	Paragraph	Page
Score:		
Cards.....	79	80
Computation.....	79	80
Service of the piece.....	52-54	53
Sights:		
Bore sights.....	36	39
How to zero.....	36	39
Periscope.....	35	36
Quick field adjustment.....	36	39
Telescope M5A1.....	35	36
Testing targets.....	36	39
Signals—		
For fire adjustment.....	106	102
For target designation.....	102	96
Spare parts.....	40	44
Speed:		
Estimation.....	97, 98	93, 94
Targets.....	62, 67, 98	62, 69, 94
Spent case deflector.....	1	1
Stoppages.....	32, 33, 78	33, 80
Targets:		
Ammunition.....	93	91
Construction 1,000-inch moving target range.....	84	85
Construction of caliber .30 or 37-mm field target range.....	85	86
Description.....	100	94
Designation.....	99, 100, 101, 102	94, 96
Marksmanship.....	75, 82	76, 82
Relation to terrain features.....	91	90
Signals for designation.....	102	96
Sled.....	84	85
Speeds.....	62, 97, 98	62, 94
Types, in combat.....	92	90
Technique of fire:		
Definition.....	86	89
Scope.....	87	89
Telescopic sight.....	35	36
Terrain features.....	90	90
Tracking exercises.....	62	62
Training for putting gun in action:		
General.....	52	53
Position of gun crew.....	53	53
Service of the piece.....	54	54
Cease firing.....	54	54
Clear gun.....	54	54
Fire gun.....	54	54
Go out of action.....	54	54
Suspend firing.....	54	54
Unload.....	54	54
Traversing mechanism.....	1, 37, 38	1, 43
Trigger actuator mechanism:		
Care and cleaning.....	24	25
Description.....	1	1
Disassembly and assembly.....	9	18
Functioning.....	24	25
Zeroing sights.....	36	39