

No. 1920

DESCRIPTION

AND RULES FOR THE MANAGEMENT OF THE

U. S. MAGAZINE RIFLE

MODEL OF 1898

AND

MAGAZINE CARBINE

MODEL OF 1899

CALIBER .30



WASHINGTON
GOVERNMENT PRINTING OFFICE
1917

Fig. 1.



Fig. 2.



THE U. S. MAGAZINE RIFLE AND CARBINE.

Since the adoption of this arm the following changes have been made by the authority of the Chief of Ordnance:

BARREL.—Muzzle rounded in Model 1896.

Rear end rounded in July, 1899.

BAYONET BLADE.—Bluing stopped, April 1, 1895.

BAYONET GRIP.—Sanding stopped, April 12, 1899.

BAYONET GRIP RIVETS.—Ends rounded, November 9, 1899.

BAYONET SCABBARD HOOK.—Oscillation limited to 100 degrees, April 17, 1897.

New pattern adopted, July 22, 1899.

BAYONET SCABBARD MOUTHPIECE.—Aperture for blade made rectangular, July 15, 1895.

BOLT.—About one-fourth of left side of guide rib removed, June 17, 1895.

Slot for securing stud omitted, June 29, 1895.

Length of flat surface on under side of handle increased in Model 1898.

BUTT PLATE.—Thickness increased 0.04 inch, toe curved, cap hole and spring lug added in Model 1896.

BUTT PLATE CAP, CAP PIN, CAP SPRING, AND CAP SPRING SCREW.—Added in Model 1896.

BUTT PLATE SCREW, LARGE.—Head made flat in Model 1896.

CARRIER.—Magazine spring lug shortened, March 4, 1895.

Arbor made perpendicular to top and shortened 0.02 inch and distance between lug and bottom side of body decreased 0.02 inch in Model 1898.

Modified to hold up point of first cartridge, November 20, 1899.

CLEANING ROD.—Made jointed and inserted in butt of stock in Model 1896.

COCKING PIECE.—Made of high instead of low steel, August 1, 1895.

Rear part of lug beveled and locking notch added in Model 1896.

CUT-OFF.—Blued instead of spring tempered, July 15, 1895.

Thickness of thumb-piece increased 0.015 inch, and slot for flat spring replaced by spring spindle hole, April 30, 1895.

Flattening of spindle reversed, length of spindle decreased 0.5 inch, rear upper edge of thumb-piece beveled and fillet added at junction of spindle and thumb-piece in Model 1898.

Thumb-piece left bright, December 5, 1898.

Only one side of thumb-piece polished, January, 1900.

CUT-OFF SPRING.—Flat replaced by spiral pattern, April 30, 1895.

CUT-OFF SPRING SPINDLE.—Added April 30, 1895.

Length increased 0.013 inch, August 6, 1895.

EJECTOR PIN.—Head rounded and length increased, January 28, 1895.

EXTRACTOR.—Depth of extractor spring pivot hole increased 0.028 inch, September 3, 1895.

Extractor pin lug added in Model 1896.

Fillet added at junction of under side of body and heel, January 25, 1896.

EXTRACTOR PIN.—Added in Model 1896.

EXTRACTOR SCREW.—Replaced by extractor rivet in Model 1896.

FRONT SIGHT STUD.—Width of slot reduced to 0.05 inch in Model 1896.

FRONT SIGHT.—Height of top above axis of bore increased from 0.82 inch to 0.85 inch, June 20, 1894.

Thickness made 0.05 inch throughout and shape of top changed in Model 1896.

Height of top above axis of bore increased from 0.85 inch to 0.975 inch for use with Model 1901 rear sight.

FRONT SIGHT PIN.—Length increased and taper changed in Model 1896.

GATE.—Length of lug reduced 0.0065 inch, April 1, 1895.

Fillet added at junction of lug and hinge, October 8, 1895.

Shape of exterior and interior of front end changed, October 8, 1895.

Curvature of exterior and shape of interior at rear end changed, and bevel on the front part of the interior of the top omitted in the Model 1898.

GUIDE LIP.—Tenon to enter groove in receiver omitted, September 8, 1894.

Thickness increased in Model 1896.

HAND GUARD BODY.—Extended rearward over tenon of receiver and heads of rivets countersunk deeper in Model 1896.

HAND GUARD RIVETS, FRONT AND REAR.—Shortened in 1895.

HAND GUARD SPRINGS.—Crimp omitted in Model 1896.

HINGE BAR HEAD.—Rear right edge rounded, May 11, 1895.

Fillet added at junction of spring and head, June 4, 1895.

Width of lug on spring reduced 0.03 inch, January 30, 1896.

HINGE BAR PIN.—Blued instead of spring tempered, July 15, 1895.

MAIN SPRING.—Length increased from 30½ to 33½ coils in Model 1896.

Weight reduced from 18 to 22 pounds to 16 to 18 pounds in Model 1896.

RAMROD.—Omitted in Model 1896.

RAMROD STOP.—Omitted in Model 1896.

RECEIVER.—Groove for guide lip tenon omitted, September 8, 1894.

Slot for ejector pin head omitted, January 28, 1895.

Walls of trigger heel slot omitted, May 27, 1895.

Depth of cut-off spring spindle recesses increased, October 15, 1895.

Extractor pin notch added in Model 1896.

The following changes were embodied in the Model 1898,
viz:

Cut-off hole reduced 0.5 inch in depth, and position slightly changed.

Width of mortise for side plate tenon increased 0.02 inch.

That part of the bolt handle seat projecting beyond tang omitted.

Outside of right wall over gate beveled.

Bearing for top side of carrier, in carrier arbor cavity, lowered 0.02 inch.

That part of the left wall of the magazine spring channel projecting beyond the bottom wall omitted.

Mark on side of tenon for position of barrel omitted.

Top of carrier arbor ear lowered to project only slightly above top of gate.

Bottom of magazine spring channel made parallel to bottom of magazine.

Fillet in tenon added, July, 1899.

SAFETY LOCK.—Thickness of thumb-piece increased; thumb-piece and spindle made separate, and spring and spring spindle added in Model 1896.

SAFETY LOCK SPINDLE.—Depth of safety lock pin groove in Model 1892 reduced (see sleeve). The spindle with deep groove is known as Model 1892, second pattern, and with the shallow groove as Model 1892, third pattern.

SAFETY LOCK PIN.—Omitted in Model 1896.

SEAR.—Made of low instead of high steel, October 25, 1895.

Nose shortened 0.005 inch, November 26, 1895.

SEAR SPRING.—Size of wire changed from 0.041 inch to 0.047 inch, November 21, 1898.

SIDE PLATE.—Hole for ejector pin head added, January 28, 1895.

Thickness of upper half increased and cartridge rib lengthened in Model 1896.

Thickness of tenon increased 0.02 inch in Model 1898.

Polishing inside stopped, November 28, 1898.

Rear upper corner rounded, May 5, 1899.

SIDE PLATE SCREW.—Shortened in length one thread, June 1, 1894.

SLEEVE.—Safety lock pin hole raised 0.03 inch, October 22, 1894.
The sleeve with low safety lock pin hole is known as Model 1892, first pattern, and with high hole as Model 1892, second pattern.

Securing stud and rivet omitted, June 29, 1895.

Knurling omitted, June 15, 1895.

The following changes were embodied in the Model 1896,
viz:

Safety lock pin hole omitted.

Front end of barrel shortened 0.0345 inch.

Thickness of extractor arm reduced 0.035 inch.

Countersink for screw head omitted, and lower part of rivet hole countersunk for rivet head.

Groove with a recess at each end added for safety lock spring spindle.

STOCK.—Changes embodied in model 1896:

Small enlarged.

Toe rounded.

Two holes, 1 inch in diameter, to decrease the weight, and three small holes for cleaning rod drilled in butt.

Oiler seat cut between large holes.

Channels cut under barrel to decrease the weight.

Ramrod groove and stop slot omitted.

Bolt handle seat changed in Model 1898.

Size of cleaning rod holes changed from 0.22 inch to 0.24 inch, November 21, 1898.

STRIKER.—Point rounded, December 2, 1895.

TRIGGER.—Case-hardened in water instead of oil, April 2, 1894.

Case-hardened in oil instead of water, November 21, 1898.

Width of sear slot changed from 0.24 inch to 0.25 inch,
November 21, 1898.

TRIGGER PIN.—Length reduced 0.045 inch, November 15, 1895.

UPPER BAND.—Middle portion over barrel removed, August 16, 1894.

Bushing for ramrod omitted in Model 1896.

NOTE.—All guns of Models of 1892 have been or are being converted to Model of 1896. In the Model 1898, and all rifles and carbines since made, that part of the bolt handle seat projecting beyond the exterior wall of the receiver has been omitted, and the seat for the bolt handle in the stock correspondingly reduced in size.

THE RIFLE.

COMPONENT PARTS, EXCLUSIVE OF REAR SIGHT.

(Eighty-seven in number.)

Barrel:	Front Sight.
Barrel.	Front Sight Pin.
Front Sight Stud.	Gate.
Bolt.	Guard.
Butt Plate.	Guard Screw, front.
Butt Plate Cap.	Guard Screw, rear.
Butt Plate Cap Pin.	Hand Guard:
Butt Plate Cap Spring.	Hand Guard Body.
Butt Plate Cap Spring Screw.	Hand Guard Rivets, front (2)
Butt Plate Screw, large.	Hand Guard Rivets, rear (2).
Butt Plate Screw, small.	Hand Guard Spring, front.
Butt Swivel.	Hand Guard Spring, rear.
Butt Swivel Pin.	Hinge Bar:
Butt Swivel Plate.	Hinge Bar Head.
Butt Swivel Plate Screws (2).	Hinge Bar Pin.
Carrier.	Lower Band.
Cleaning Rod, 1st section.	Lower Band Pin.
Cleaning Rod, 2d and 3d sections.	Lower Band Swivel.
Cut-off.	Lower Band Swivel Screw.
Cut-off Spring.	Magazine Spring.
Cut-off Spring Spindle.	Main Spring.
Ejector.	Receiver:
Ejector Pin.	Receiver.
Extractor.	Guide Lip.
Extractor Pin.	Guide Lip Rivet.
Extractor Rivet.	Safety Lock:
Extractor Spring.	Safety Lock Spindle.
Firing Pin:	Safety Lock Spring.
Cocking piece.	Safety Lock Spring Spindle.
Firing Pin Rod.	Safety Lock Thumb Piece.
Follower.	Sear.
Follower Pin.	Sear Spring.

Side Plate.	Bayonet:
Side Plate Screw.	Bayonet Blade.
Sleeve.	Bayonet Catch.
Stacking Swivel.	Bayonet Catch Nut.
Stacking Swivel Screw.	Bayonet Catch Spring.
Stock.	Bayonet Grip Body, right.
Striker.	Bayonet Grip Body, left.
Trigger.	Bayonet Grip Rivets (2).
Trigger Pin.	Bayonet Grip Washers (4).
Upper Band.	Bayonet Guard.
Upper Band Screw.	Bayonet Pommel.

DESCRIPTION AND NOMENCLATURE OF RIFLE.

The BARREL, Fig. 3, has the *muzzle*, A, rounded to protect the rifling; *front sight stud* and *front sight pin hole*, B; *rear sight screw holes*, C; *tenon*, D, on which is a thread for securing the receiver to the barrel; and the *face*, E, which supports the rim of the cartridge case. The *chamber*, Fig. 4, is made slightly conical to facilitate the withdrawal of the cartridge case and has two contractions, the rear one, A, called the *shoulder*, and the front one, B, the *throat*; immediately in front of the throat the bore is enlarged to form the *bullet seat*, C. The rifling begins in the throat. A *slot*, D, is cut in the rear end of the barrel to receive the extractor hook. The *muzzle* and the *front sight stud* are shown in Fig. 5. The stud is brazed to the barrel in manufacture; the slot, E, is the *front sight seat*.



Fig. 5.

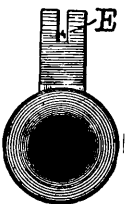
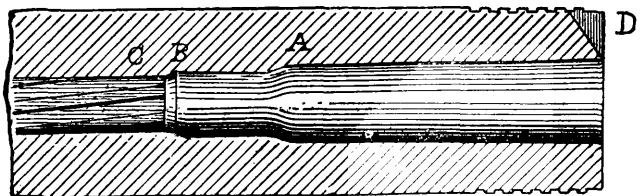

Fig. 4.



The RECEIVER is shown in Figs. 6 and 7. The hole, A, called the *well*, receives the bolt. The *magazine*, B, holds five cartridges; it is beneath the *well*, with which it is connected by the *magazine channel*, C, shaped to properly direct the passage of the

cartridge from the magazine into the chamber. The *ramp*, D, and the corresponding ramp on the side plate guide the bullet into the chamber. The *left wall*, E, is continuous and guides the bolt and extractor when moved backward and forward. Part of the right wall is cut away for the bolt lugs, to allow the ejection of the empty cartridge case, and the loading when the arm is used as a single loader. The inside of the right wall is cut away to permit the free passage of the locking lug and to receive the guide rib of the bolt when the latter is closed. The front end, F, of the rear part of the right wall is the *locking shoulder*, and the rear end, G, the *cocking shoulder*; the upper parts of these shoulders are helicoidal cams. The opening between the two walls admits the extractor, guide rib and locking lug of the bolt, and the extractor arm of the sleeve, and also prevents the latter from rotating with the bolt. The *cut-off recess*, H, has two small grooves in which the cut-off spring spindle works; the *cut-off hole*, I, extends from the front end of the recess forward, over the magazine channel. Other parts are the *bolt handle seat*, J; the *locking lug recess*, K, with its shoulder and cam; the *ejector seat*, L; the *cocking piece groove*, M; the *sear nose slot*, N; the *side plate tenon mortise*, O; the *guide lip*, P, riveted to the receiver in manufacture by the *guide lip rivet*; the *extractor spring lip*, Q; the *hinge bar holes*, R; the *magazine spring channel*, S; the *carrier*

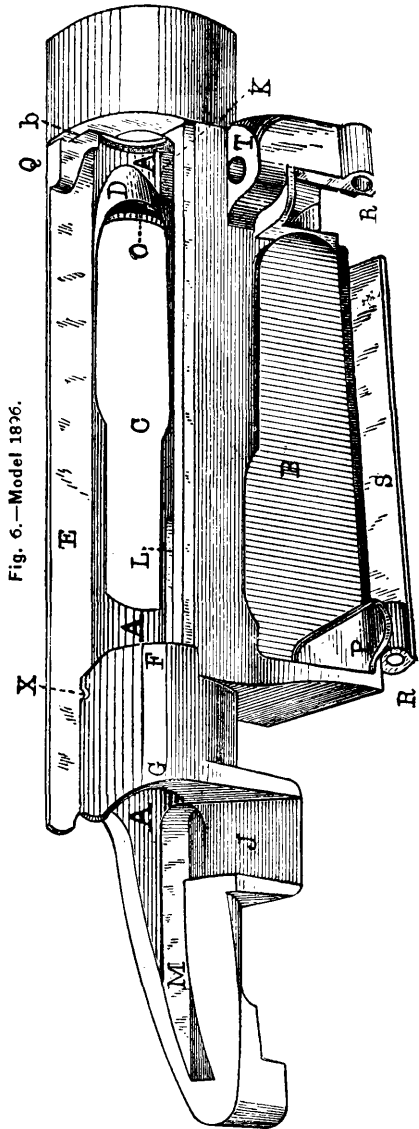

Fig. 6.—Model 1896.

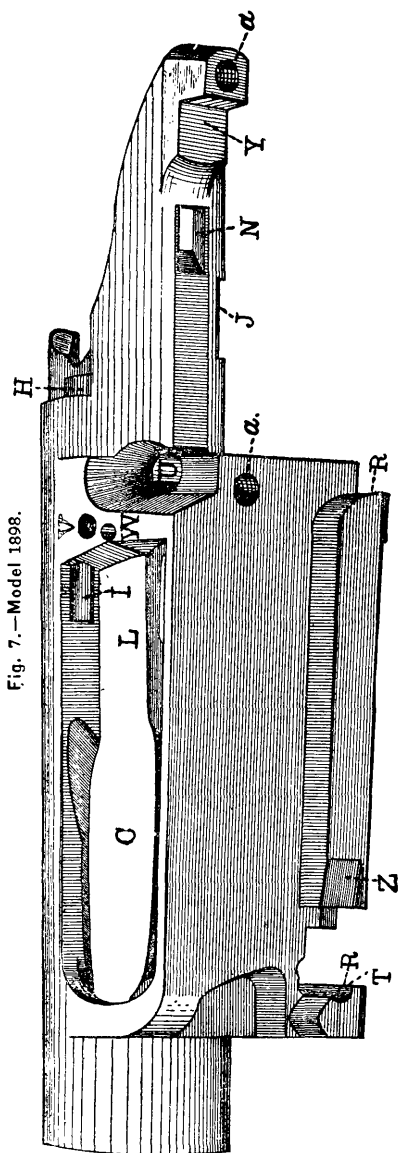

Fig. 7.—Model 1898.

arbor hole, T; the sear seat hole, U; the side plate screw hole, V; the ejector pin hole, W; the extractor pin notch, X; the trigger heel bearing, Y; the hinge bar spring seat, Z; the guard screw holes, a; and the extractor hook slot, b, which with the corresponding slot in the barrel, receives the extractor hook. The prolongation of the well in front of the locking lug recess is enlarged and tapped to receive the tenon of the barrel. When the receiver is properly assembled on the barrel, the radial mark on the front end of the receiver should be in juxtaposition with the corresponding mark on the right side of the barrel. The model, place of manufacture, and number of the arm are stamped on the left wall.

Fig. 8 shows the receiver with the projecting part of the bolt handle seat omitted. This receiver is peculiar to the 1898 and later models, and can not be used with Stock of previous models.

The BOLT is represented in Fig. 9, side view; Fig. 10, rear view; and Fig. 11, front view. It consists of the handle, A, the outer end of which is a ball; the collar, B, the front end of which is undercut to fit the sleeve (see Fig. 12); the guide rib, C, which directs the longitudinal motion of the bolt and extractor; the locking lug, D, which sustains the shock of discharge; the ejector groove, E, extending along and partly around the bolt; the cocking cam, F, the cocking nose notch, G; and the safety lock spindle notch, H.

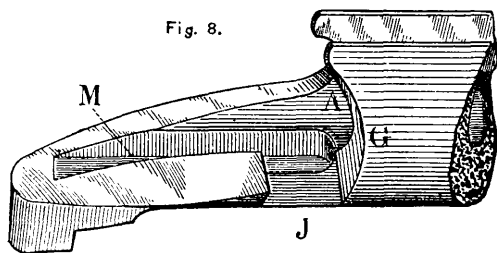

Fig. 8.

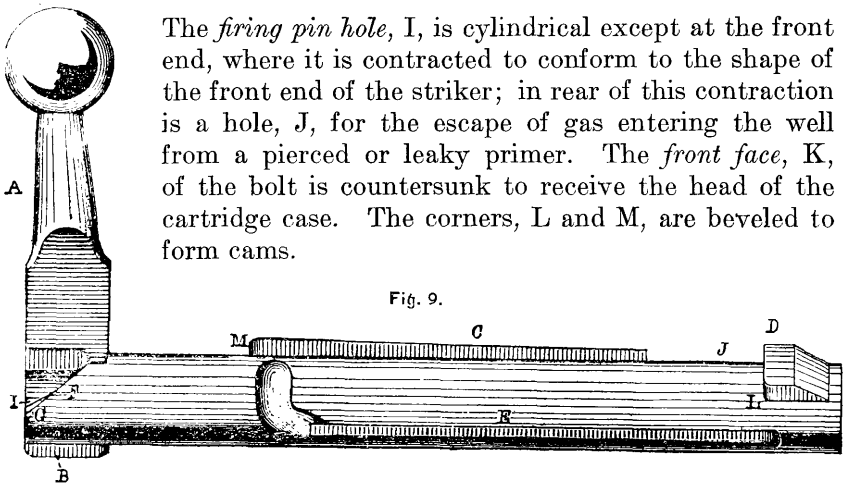

Fig. 9.

The *firing pin hole*, I, is cylindrical except at the front end, where it is contracted to conform to the shape of the front end of the striker; in rear of this contraction is a hole, J, for the escape of gas entering the well from a pierced or leaky primer. The *front face*, K, of the bolt is countersunk to receive the head of the cartridge case. The corners, L and M, are beveled to form cams.

Fig. 10.

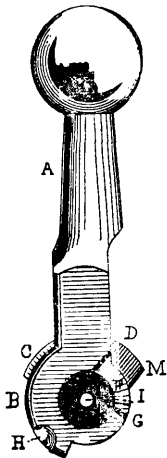
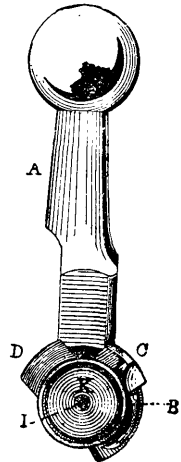
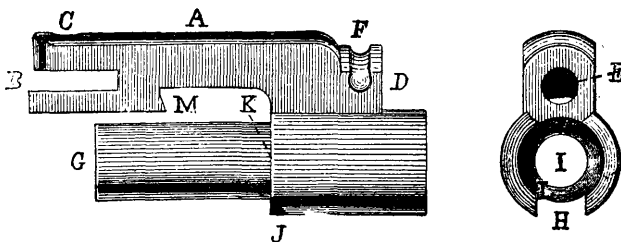

Fig. 11.



The SLEEVE, Fig. 12, has the *extractor arm*, A; the *extractor slot*, B; the *extractor rivet hole*, C, that part below the slot being enlarged to receive the head of the extractor rivet; the *safety lock seat*, D; the *safety lock spindle hole*, E; the *safety lock spring spindle groove*, F, the ends of which are deepened to retain the safety lock when turned to the right or left; the *barrel*, G, which enters the firing pin hole in the bolt and of which the front end forms the rear bearing for the main spring; the *cocking piece lug slot*, H; the *hole*, I, through which the firing pin passes, and the *dust space*, J, which permits the escape of dust from the cocking cam recess of the bolt. The exterior shoulder, K, at the rear end of the *barrel*, bears against the rear end of

Fig. 12.



the rear end of the bolt.

the bolt and the interior shoulder, L, limits the forward movement of the cocking piece. The bevel on the front end of the *bolt collar*

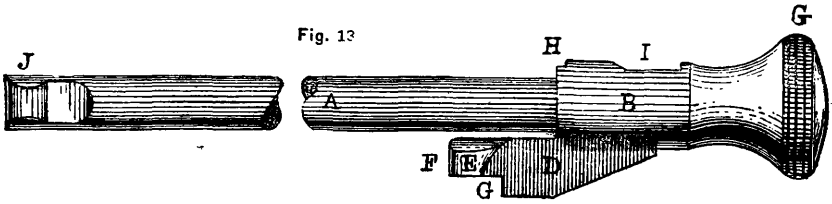

Fig. 14.

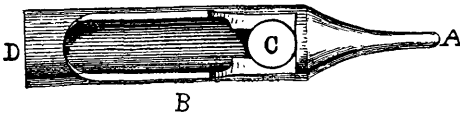
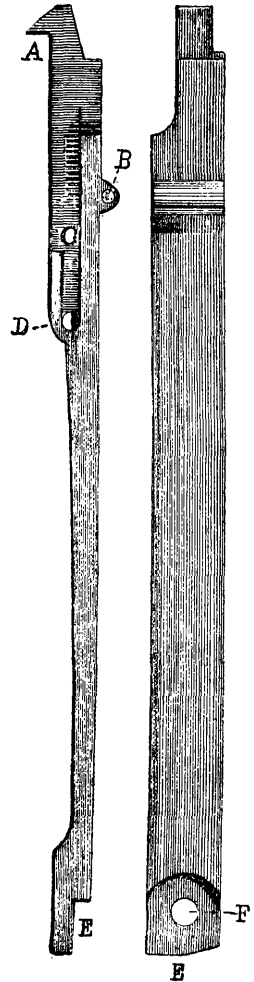

Fig. 16.



recess, M, fits the undercut on the front end of the bolt collar and holds the sleeve on the bolt, allowing the latter to rotate without the former.

Fig. 15.



The FIRING PIN, Fig. 13, consists of the *firing pin rod*, A, and of the *cocking piece*, B, which are made separately and the former screwed into the latter and riveted in assembling; the length of the rod being so adjusted that, when the front end of the cocking piece bears against the interior shoulder, L, of the sleeve, the striker point will project the proper distance beyond the face of the bolt; other parts are *comb*, C; *lug*, D; *cocking cam*, E; *nose*, F; *sear notch*, G; *safety lock cam*, H; *locking notch*, I; and *striker point*, J.

The parts of the STRIKER, Fig. 14, are the *point*, A; the *body*, B, partly cut away to permit the assembling of the firing pin; and the *joint hole*, C, by which the striker is secured to the firing pin; its rear end, D, forms the front bearing for the main spring.

The MAIN SPRING is shown in Fig. 15.

The EXTRACTOR, Fig. 16, has the *hook*, A; the *extractor pin*

hole, B, the seat, C, and the stud hole, D, for the extractor spring the heel, E; and the extractor rivet hole, F.

The EXTRACTOR PIN, Fig. 17, is tapering and is driven into its hole in the extractor from the right, and its small end then upset.

The EXTRACTOR SPRING, Fig. 18, has the stud, S, and the point, P.

The EXTRACTOR RIVET, Fig. 19, holds the extractor in the sleeve.

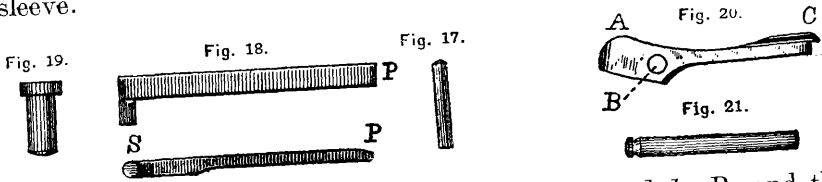

The EJECTOR, Fig. 20, has the heel, A; the pin hole, B; and the point, C, which, resting on a shoulder in the ejector slot in the receiver, prevents the front end of the ejector from dropping into the magazine.

The EJECTOR PIN, Fig. 21, on which the ejector is pivoted, has a knob on its left end by which it can easily be withdrawn from the receiver.

The SAFETY LOCK, Fig. 22, consists of the thumb-piece, A; spindle, B; spring, C; and spring spindle, D, assembled in manufacture.

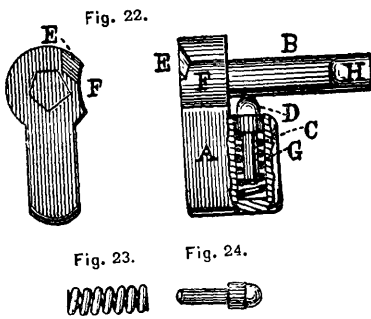

It has the cam, E; cocking piece groove, F; spring spindle hole, G; and bolt collar notch, H. The spring is shown in Fig. 23, and the spring spindle in Fig. 24; the latter, projecting into its groove in the sleeve, under the action of the spring, holds the safety lock in its seat and turned either to the right or left.

The SIDE PLATE, Fig. 25, has the rib, A; the tenon, B; the ejector pin recess, C; the side plate screw hole, D; and the ramp, E. The side plate forms the left wall of the magazine and is held

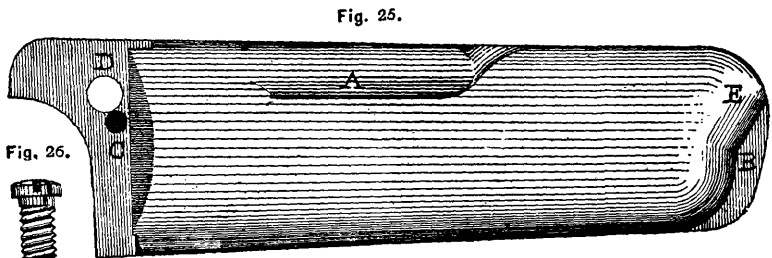

in its seat in the receiver by the tenon and the SIDE PLATE SCREW, Fig. 26.

The parts of the GATE, Fig. 27, are the *thumb-piece*, A; *hinge hole*, B; *bearing* for magazine spring, C; the *recess*, D, which receives the carrier and follower; and the *lug*, E, on which is a cam for with drawing the carrier into the recess.

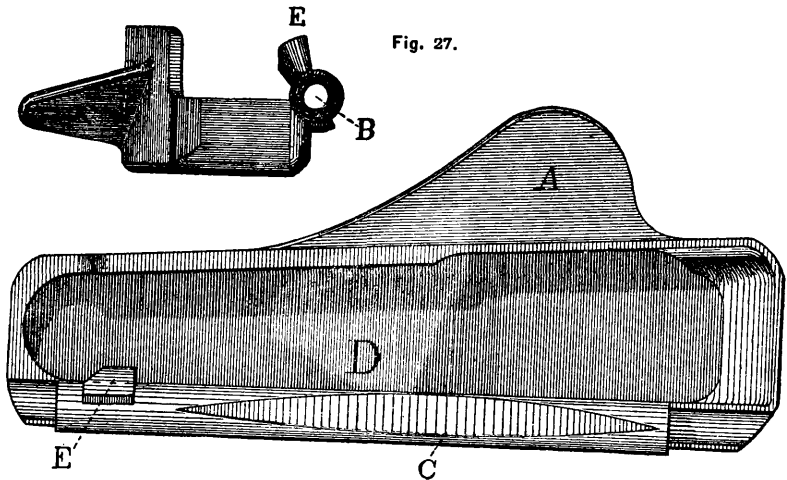

Fig. 27.

The HINGE BAR, Fig. 28, consists of the *pin*, A, and the *head*, B, assembled in manufacture. The *pin* holds the gate in its seat

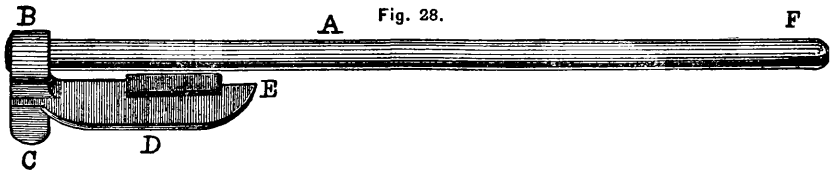

Fig. 28.

in the receiver and forms the hinge on which the gate turns. The *head* retains the pin in place and prevents its rotation with the gate.

The *lug*, C, forms a handle for turning the *point*, E, of the *spring*, D, out of its seat in the receiver and for withdrawing the hinge bar in dismantling the magazine mechanism. The *spring*, D, protects the bottom end of the carrier arbor.

Fig. 29.



Fig. 30.

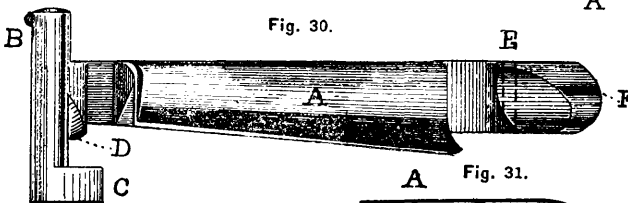

Fig. 31.

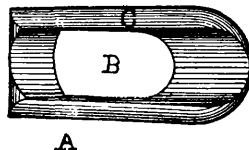

Fig. 32.



The MAGAZINE SPRING, Fig. 29, has a *lip*, A, on its front end, which bears in the notch on the heel of the carrier.

The CARRIER, Fig. 30, has the *curved face*, A; the *arbor*, B; the *heel*, C; the *cam*, D; the *follower pin hole*, E; and the *point*, F, which is shaped to raise the cartridges into the magazine channel.

The FOLLOWER, Fig. 31, has the *pin holes*, A; the opening, B, through which the point of the carrier operates; and the *top*, C; it is assembled to the carrier by the FOLLOWER PIN, Fig. 32, on which it swings. This pin is tapering, its small end is inserted from the top of the follower and, when driven into place, both ends are upset and the upper filed until all projection above the top of the follower is removed.

Fig. 33.

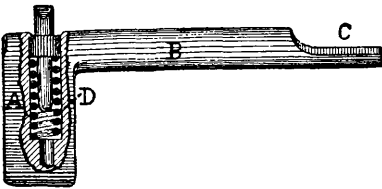

Fig. 35.



Fig. 34.



The CUT-OFF, Fig. 33, includes the *spring* and *spring spindle* assembled. The parts are *thumb-piece*, A; *spindle*, B; *point*, C; and *spring spindle hole*, D.

The CUT-OFF SPRING, Fig. 34, and its SPINDLE, Fig. 35, retain the cut-off in its seat in the receiver and hold the thumb-piece turned either up or down.

The TRIGGER, Fig. 36, has the *finger-piece*, A; *sear recess*, B; *bearings*, C; *heel*, D; and *trigger pin holes*, E.

The sear is hinged in its seat in the trigger by the TRIGGER PIN, Fig. 37, which is tapering, and in assembling its small end must be driven into the trigger holes from the right and upset on the left.

Fig. 36.

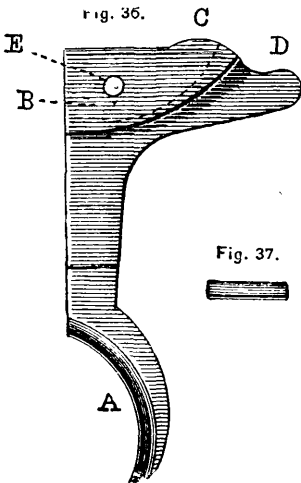

Fig. 37.



The SEAR, Fig. 38, has the *nose*, A; *hinge*, B; *spring hole*, C; and *trigger pin hole*, D. The hole in the hinge,

Fig. 38.

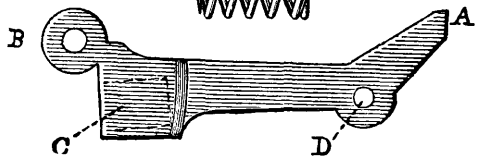

Fig. 39.



made for convenience in manufacture, performs no part in the working of the sear.

The SEAR SPRING, Fig. 39, occupies the hole, C, in the sear, and its front end bears against the receiver.

The FRONT SIGHT, Fig. 40, is secured in its slot in the stud by the FRONT SIGHT PIN, Fig. 41. This pin is tapering, and its small end is driven in from the right, and upset on the left, to prevent accidental removal.

Fig. 40.

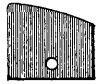
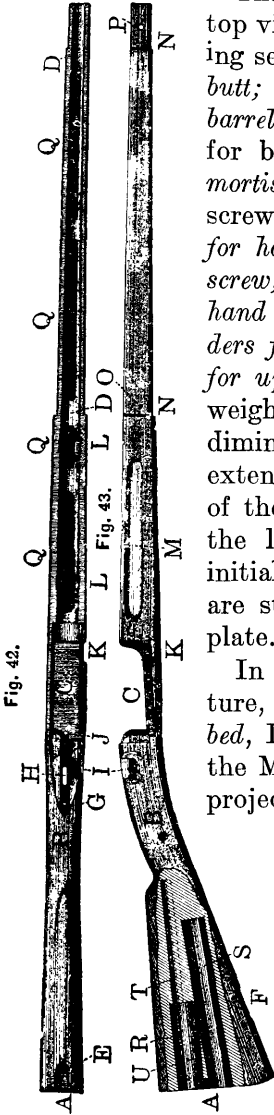

Fig. 41.



The STOCK is represented in Fig. 42, top view; and Fig. 43, right side, showing section of butt. The parts are, A, butt; B, small; C, receiver bed; D, barrel bed; E, small butt plate screw hole and seat for butt plate tang; F, butt swivel plate seat; G, mortise for receiver tang lug and hole, for rear guard screw; H, mortise for sear and slot for trigger; I, cut for handle seat on receiver; J, hole for front guard screw; K, cut for hinge bar head; L, recesses for hand guard springs; M, finger grooves; N, shoulders for bands; O, hole for lower band pin; P, hole for upper band screw; Q, channels, to decrease the weight. Two large holes, R and S, in the butt diminish the weight; three small holes, T, which extend from the large hole, R, receive the sections of the cleaning rod. Part of the wall, U, between the large holes is cut away for the oiler. The initials of the inspector and the year of fabrication are stamped on the left side, in rear of the side plate.

In the Model 1898, and stocks of later manufacture, the section of STOCK, shown in Fig. 44, has the bed, I, for the bolt handle, which is changed from the Model 1896, to conform to the omission of the projecting part of the handle seat from the receiver.

Fig. 44.

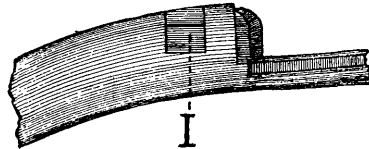

The Model 1898 stock is peculiar to the Model 1898 arms, and is not interchangeable with previous models.

The HAND GUARD consists of the *body, springs, and rivets*, assembled.

The HAND GUARD BODY, Fig. 45, extends over the barrel from the front end of the well of the receiver to the lower band, and forms a protection from the heat developed in firing. The parts are *mortise, A*, for rear sight; *grooves, B*, for the hand guard springs; *holes, C*, for the hand guard rivets, countersunk on the

top side to protect the hand from the rivets when heated by firing; and *mortise*, D, for tenon of receiver. The hand guards used with

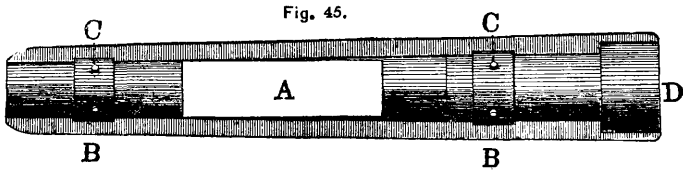

the different models of rear sights differ only in size and position of mortise.

Fig. 46.

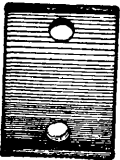

Fig. 47.



The front **HAND GUARD SPRING** is shown in Fig. 46; the rear spring is similar to but larger than the front. Each spring is fastened to the body by two rivets, and the hand guard is held in place by the springs embracing the barrel.

One of the front **HAND GUARD RIVETS** is shown in Fig. 47. The rear rivets differ from the front only in their length.

The **GUARD** is represented in Fig. 48. The parts are *trigger slot*, A; *bow*, B; and *guard screw holes*, C.

The front and rear **GUARD SCREWS**, Figs. 49 and 50, secure the receiver and guard to the stock.

Fig. 48.

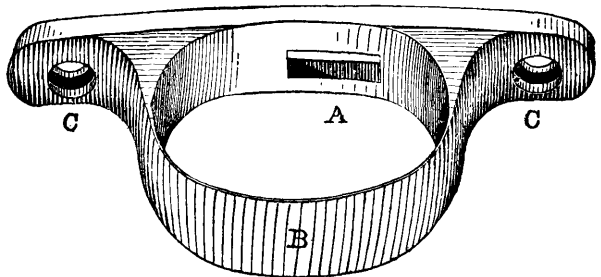

Fig. 49.



Fig. 50.



The **BUTT PLATE** is represented in Fig. 51. The parts are *toe*, A; *tang*, B; *cap hole*, C; *cap ears*, D, through which are the *cap pin holes*; *spring lug*, E; large *butt plate screw hole*, F, and small *butt plate screw hole*, G.

Fig. 52.



Fig. 53.



A notch is cut into the edge of the cap hole to facilitate the opening of the cap. The large and small **BUTT PLATE SCREWS**, Figs. 52 and 53, secure the butt plate to the stock.

The **BUTT PLATE CAP**, Fig. 54, has the *cap pin hole*, A, and the *thumb notch*, B. The cap is hinged between the ears of the butt

Fig. 51.

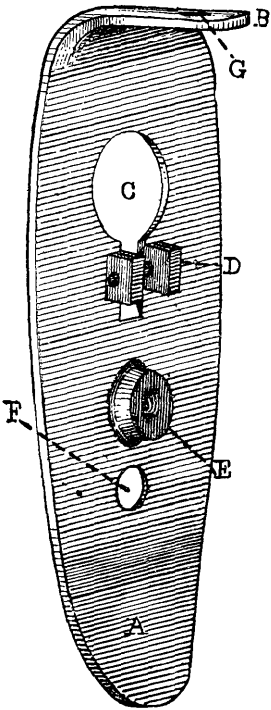

plate on the cap pin and is retained either closed or opened by the free end of the CAP SPRING, Fig. 55, which bears on the *heel*, C.

Fig. 55.

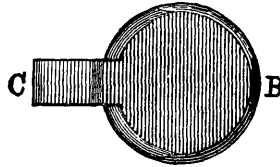
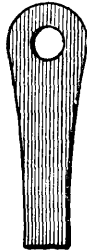

Fig. 54.



Fig. 57.



Fig. 56.



The BUTT PLATE CAP PIN, Fig. 56, after being driven into the holes in the ears of the butt plate and cap, has its ends slightly upset.

The BUTT PLATE CAP SPRING SCREW, Fig. 57, secures the cap spring to the lug on the butt plate and is firmly screwed against the spring.

The CLEANING ROD consists of three sections. The FIRST SECTION, Fig. 58, has the *slot*, A, for a cleaning rag; and the *tenon*, B, which is threaded to fit the hole in another section; the SECOND and THIRD SECTIONS, Fig. 59, are identical; the parts are *hole*, C, tapped to receive the tenon of another section; and the *tenon*, B.

Fig. 59.

Fig. 58.



Fig. 60.

Fig. 61.

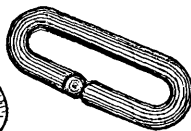
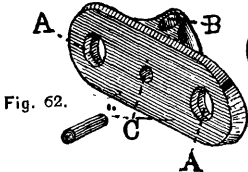

Fig. 62.



The BUTT SWIVEL includes the *plate*, *swivel*, and *pin* assembled.

The BUTT SWIVEL PLATE, Fig. 60, has the *holes*, A, for the swivel plate screws; B, for the *swivel*; and C, for the swivel pin.

The SWIVEL, Fig. 61, is retained in the plate by the BUTT SWIVEL PIN, Fig. 62.

The BUTT SWIVEL SCREWS are the same as the small butt plate screw (see Fig. 53).

The parts of the UPPER BAND, Fig. 63, are the *bayonet stud*, A; the *stacking swivel ears*, B, which contain the *stacking swivel screw holes*; and the *band screw holes*, C.

The UPPER BAND SCREW, Fig. 64, secures the band to the stock, the thread under the head engaging in the hole on the right side of the band.

The STACKING SWIVEL, Fig. 65, is hinged by the *lug*, A, between the *ears*, B, of the upper band, on the STACKING SWIVEL SCREW, Fig. 66, which, after assembling, has its threaded end upset.

The *lug*, A, of the LOWER BAND SWIVEL, Fig. 67, is inserted between the *ears*, A, of the lower band and the swivel is held in place by the SWIVEL SCREW, Fig. 68, the left or threaded end of which is upset when in place.

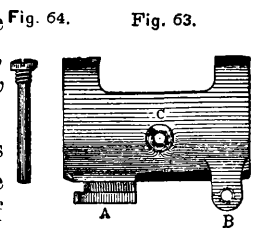

Fig. 67.

Fig. 65.

Fig. 66.

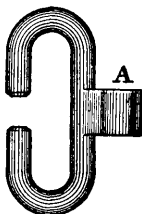
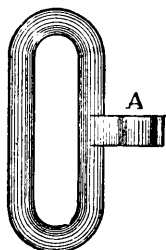

Fig. 68.



The LOWER BAND, Fig. 69, has the *swivel ears*, A; and *swivel screw holes*, B; it is slotted between the ears so that when the swivel screw is fully inserted, the barrel and stock are brought into close contact. The front or upper end of the band is indicated by the letter U.

The ends of the LOWER BAND PIN, Fig. 70, project slightly beyond the stock to prevent the band from slipping forward.

The BAYONET consists of the *blade*, *guard*, *pommel*, *catch*, *catch nut*, *catch spring*, *grip bodies*, *rivets* and *washers*, assembled; it is shown on the rifle in Figs. 1 and 2, and is of the knife pattern.

Fig. 69.

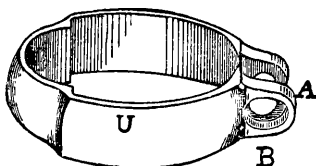
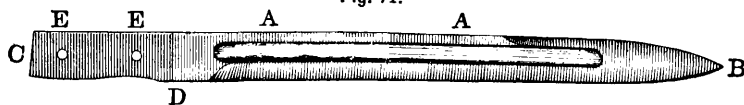

Fig. 70.



Fig. 71.



The BLADE is represented in Fig. 71. The parts are *body*, A; *point*, B; *tang*, C; *shoulder*, D, for the guard; and *rivet holes*, E.

The GUARD, Fig. 72, has the *barrel hole*, A; the *mortise*, B, and *flanges* C, for the blade tang.

The parts of the POMMEL, Fig. 73, are the *slot*, A, into which the blade tang is brazed in manufacture; the *undercut groove*, B, which receives the stud on the upper band when the bayonet is fixed; and the *hole*, C, for the catch and its spring.

The parts of the CATCH, Fig. 74, are the *thread*, A, for the nut; the *lug*, B; and the *cam*, C.

The CATCH SPRING, Fig. 75, surrounds the spindle of the catch; one end bears on a shoulder in the hole C, of the pommel and the other against the catch nut.

The CATCH NUT, Fig. 76, retains the catch in the pommel and serves as a thumb-piece for its manipulation.

The edge of the catch lug, under the action of the spring, projects into the undercut groove of the pommel. As the bayonet is fixed, the upper end of the bayonet stud on the upper band, in entering this groove, comes in contact with the cam, C,

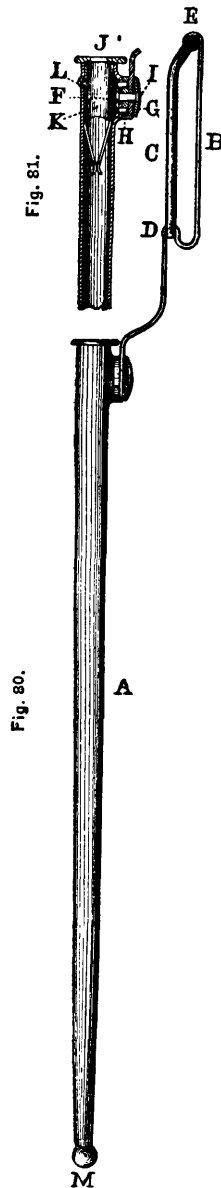

Fig. 81.

Fig. 80.

Fig. 72.

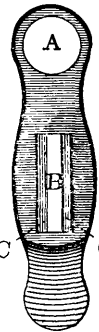

Fig. 77.

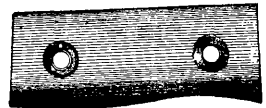

Fig. 78. Fig. 79.



Fig. 76.



Fig. 75.



Fig. 74.

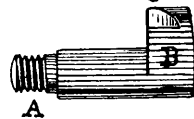

and forces the lug out of the groove until the stud has passed, when the catch spring returns the lug into the groove below the bayonet stud, thereby securing the bayonet to the rifle. Pressure upon the catch nut withdraws the lug from the groove and allows the bayonet to be removed.

The right bayonet grip body is shown in Fig. 77; the left is the reverse of

Fig. 73.

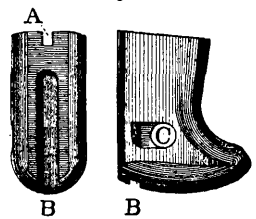

the right. They cover the tang between the guard and pommel and are secured to it by two RIVETS, Fig. 78, with WASHERS, Fig. 79, at either end.

The BAYONET SCABBARD is shown in Fig. 80, and a cross section of its upper end in Fig. 81. The parts are *body*, A; *hook*, B; *hook fastener*, C, which hinges at D, and locks at E. The *inside washer*, F; the *outside washer*, G; and the *stop washer*, H; the *hook rivet*, I, which holds the hook to the body, passing through the inside, outside, and stop washers. The inside and stop washers are riveted together by two small rivets. Other parts are the *mouth-piece plate*, J, and *mouth-piece spring*, K, brazed together in manufacture; the *mouth-piece rivet*, L; and *knob*, M, which protects the small end of the body, and through which is a hole to permit the escape of water entering the body. On the lower end of the hook, and at right angles with it, is a tongue which, moving in a clearance in the stop washer, limits the oscillation of the hook to 50 degrees on each side of the vertical.

NOTE.—All parts of the Model 1896 Rifle are interchangeable with the Model 1898, except the Receiver, Stock, Cut-off, and Side Plate. The receiver and stock are the same as the Model 1898, with the exception of the bolt handle seat. The spindle of the cut-off is 0.5 inch longer, and the tenon of the side plate is 0.02 inch thinner than in the Model 1898.

FRONT SIGHT.—The height of Front Sight above axis of bore is as follows:

Rifle.—For Model 1896 rear sight, 0.85 inch.

For Model 1901 rear sight, 0.975 inch.

Carbine.—For Model 1896 rear sight, 0.83 inch.

For Model 1901 rear sight, 0.919 inch.

Fig. 82.—Model 1896.

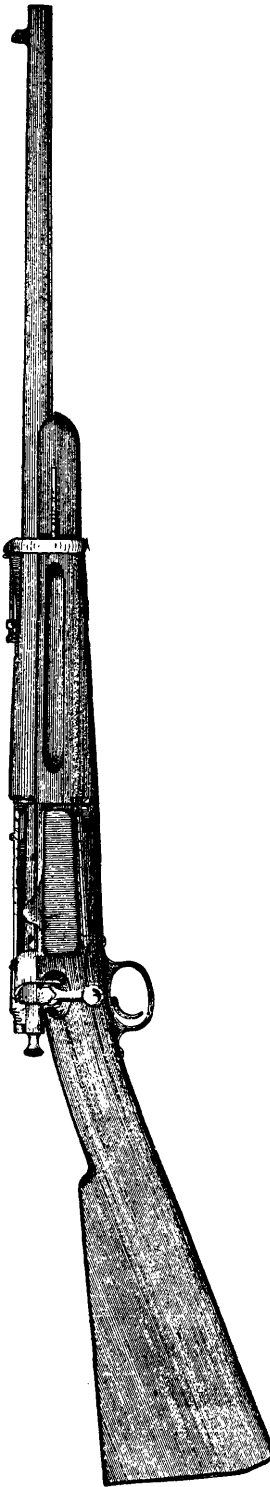
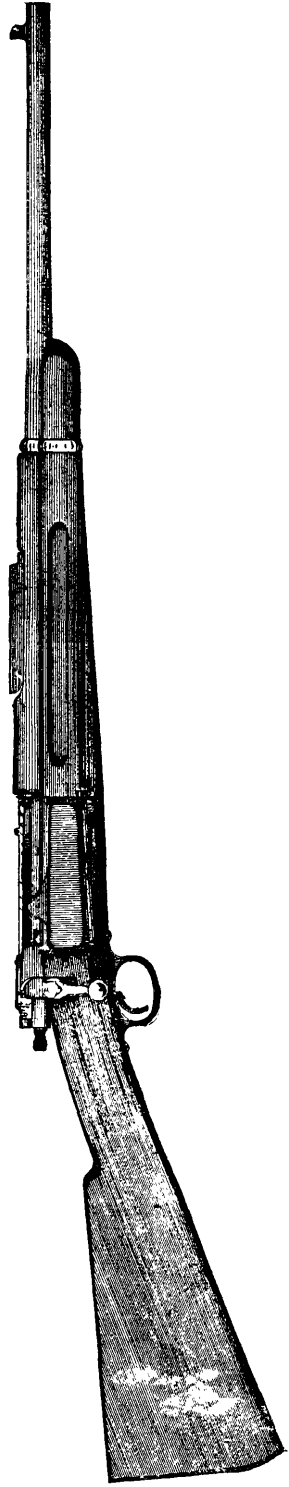

Fig. 83.—Model 1899.



CARBINE, MODEL 1899.

DESCRIPTION AND NOMENCLATURE.

The component parts, 61 in number (exclusive of rear sight), are the same as in the rifle with the exception of the Band, Band Spring, Barrel, and Stock.

Fig. 86.

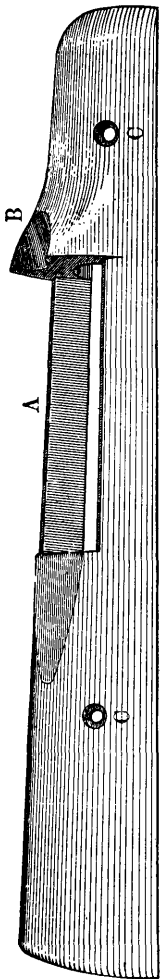

The CARBINE, Model 1896, with protector band is shown in Fig. 82, and the Model 1899 in Fig. 83.

Fig. 84 shows the band; the letter U denotes the upper side.

The BAND SPRING, Fig. 85, has the *notch*, A, which holds the band in place; and the *spindle*, B, to retain the spring in the stock.

Fig. 84.

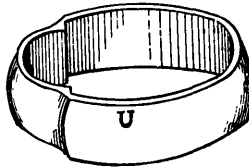

The BARREL is the same as the rear 22 inches of the rifle barrel.

Fig. 86 shows the HAND GUARD (about two-thirds size), used on the Model 1899 Carbines that are equipped with the Model 1896 rear sight. It

Fig. 85.

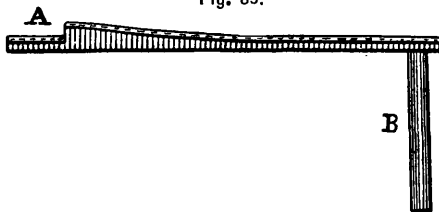

is not interchangeable with other models. The *swell*, B, is for the protection of the rear sight, and takes the place of the sight protector band in use on previous models.

The parts of the stock, shown in Fig. 87, top view, and in Fig. 88, side view with section of butt, are the same

as in the corresponding portion of the rifle stock, except as follows: The shape of the front end or *nose*, V; the omission of the

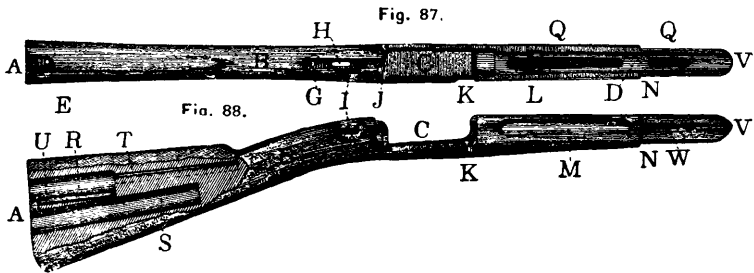

butt swivel plate seat, the butt swivel plate screw holes, and the lower band pin hole, and the addition of the *band spring seat* and *hole*, W.

THE CADET RIFLE.

The CADET RIFLE is the same as the service rifle

THE REAR SIGHT, MODEL 1896.

The Rear Sight, Model 1896, consists of the following parts:

Base.	Slide.
Base Screw, front.	Slide Cap.
Base Screw, rear.	Slide Cap Screw.
Base Spring.	Slide Spring.
Leaf.	Slide Screw.
Joint Screw.	Slide Pin.

The REAR SIGHT BASE is represented in Fig. 89. The parts are the *screw holes*, A; the *ears*, B, which contain the *joint screw holes*, that in the right ear being threaded; the *sides*, C, the upper surface of which are curved to give an elevation from 275 to 650 yards, inclusive; and the *rails*, D, upon which the leaf rests when the sight is adjusted for ranges less than 275 yards.

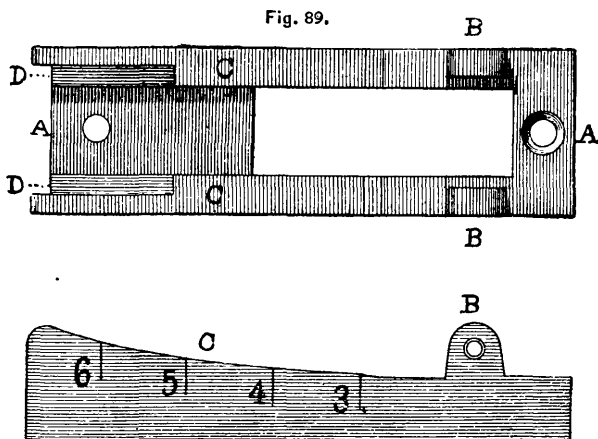

The space between the rails forms the seat for the base spring, and the undercuts beneath them receive its bevels. The elevations for 300, 400, 500, and 600 yards are marked on the left side; the elevations for every 25 yards, from 275 to 650, inclusive, are marked on the right side. The bottom of the base is conical, to conform to the shape of the barrel.

The REAR SIGHT BASE SPRING, Fig. 90, has the *free end*, A; the *bevels*, B; and the *screw hole*, C; it is held in its seat by the front base screw and its bevels. The REAR SIGHT BASE SCREWS, *front* and *rear*, are shown in Figs. 91 and 92, respectively.

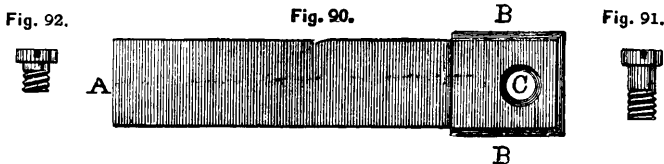

The parts of the REAR SIGHT LEAF, Fig. 93, are the *slide slot*, A; *joint screw hole*, B; the *arms*, C; and the *sighting notch*, D. The rear or bottom end is so shaped that the base spring will retain it in position when adjusted for elevation. The leaf is graduated alternately on the two arms from 700 to 1,800 yards, inclusive, and is held in its seat between the ears of the base by the REAR SIGHT JOINT SCREW, Fig. 94, on which it turns.

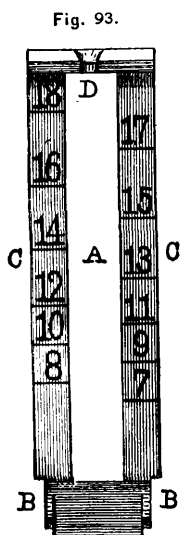

The REAR SIGHT SLIDE, Fig. 95, has the *cap screw hole*, A, and *slide screw hole*, B, both threaded; *slide pin hole*, C; *sighting notch clearance*, D; *leaf slots*, E; *spring slot*, F; *cap tenon slot*, G; and the *undercuts*, H.

The parts of the REAR SIGHT SLIDE CAP, Fig. 96, are *cap screw hole*, A; *tenon*, B; *bevels*, C; and the *sighting notch*, D. The cap is secured to the slide, at the right end, by its bevels engaging the undercuts on the slide and, at the left end, by the REAR SIGHT SLIDE CAP SCREW, Fig. 97.

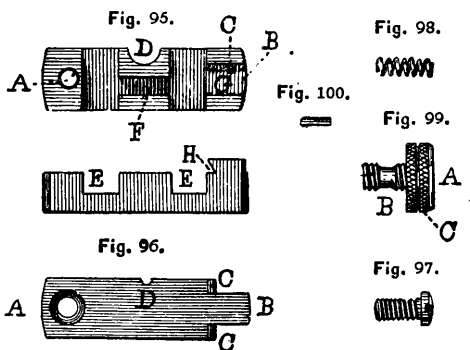

The REAR SIGHT SLIDE SPRING, Fig. 98, occupies the *slot*, F, in the slide, and its ends bear against the arms of the leaf; it assists in adjusting the slide for elevation.

The REAR SIGHT SLIDE SCREW, Fig. 99, has the *head*, A; the *pin groove*, B; and the *knurling*, C, which enables the screw to be turned firmly against the leaf.

The REAR SIGHT SLIDE PIN, Fig. 100, is inserted in the *pin hole*, C, of the slide and, projecting into the groove, B, of the slide screw, prevents the removal of the latter.

THE REAR SIGHT, MODEL 1901.

The Rear Sight, Model 1901, consists of the following parts:

Fixed Base.	Leaf Slide Cap.
Movable Base.	Leaf Slide Cap Screw.
Base Screw, front.	Leaf Slide Binding Screw.
Base Screw, rear.	Leaf Slide Binding Screw Pin.
Base Screw, Washer.	Drift Slide.
Base Spring.	Drift Slide Pin.
Base Spring Screw.	Joint Pin.
Leaf.	Binder.
Leaf Slide Body.	Binder Screw.

The principal parts are shown in Figs. 101, 102, 103, and 104.

The **FIXED BASE, A**, is shown in side view of Fig. 101. It has screw holes for front and rear base screws by which the sight is secured to the barrel, with which its under surface accurately coincides, a threaded hole at front for the movable base binder screw, and at its upper rear surface an undercut recess for the *tenon*, P, at rear of the movable base. The front base screw hole is countersunk on its upper surface for a washer about which the movable base rotates, thus bringing no strain or wear on the front base screw.

The **MOVABLE BASE, E**, is shown in Figs. 101, 102, and 103.

It is graduated on its left side for ranges of 100 to 400 yards. K is the *front base screw hole*, countersunk on its lower surface for the base

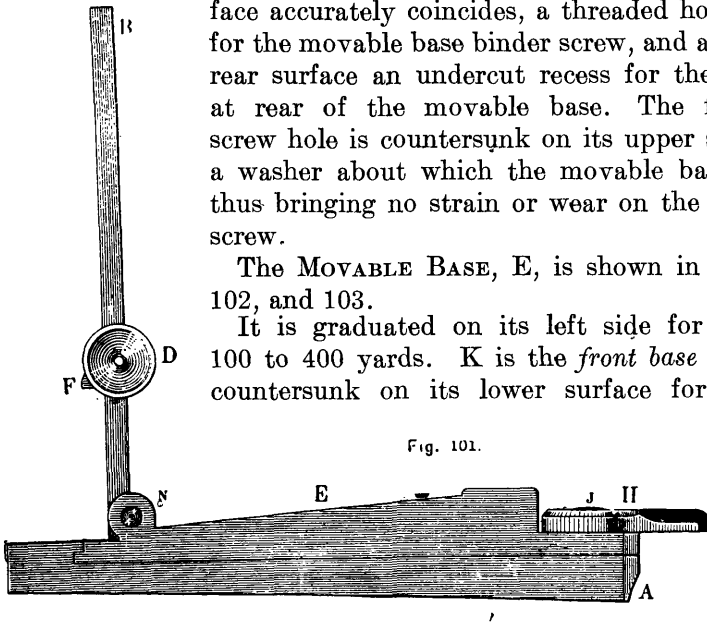

Fig. 101.

screw washer; L, the *binder screw slot*; I, *base spring screw hole*; M, *base spring slot*; N, the *ears*; and O, the *joint pin hole*. This base is held in contact with the fixed base, not by the base screws which secure the latter to the barrel, but by the *tenon*, P, at its

rear entering the undercut recess of the rear of the fixed base and by the *binder*, H, at its front. It turns freely about the front base screw washer, its lateral movement being limited by the binder screw in the *slot*, L, which prevents the *tenon*, P, from leaving its undercut slot. The upper rear surface of this base is graduated in spaces, or technically windage points, of 0.04 inch each, the outer divisions being marked zero. Two similar zero lines are marked on the rear overhang of the fixed base. By the rotation of the upper base a correction may be made for any observed deviation of the projectile.

Fig. 102.

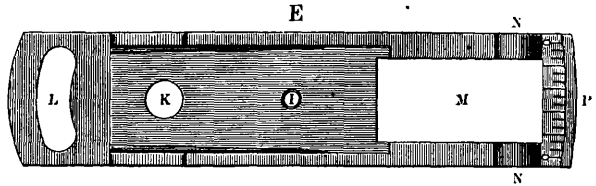
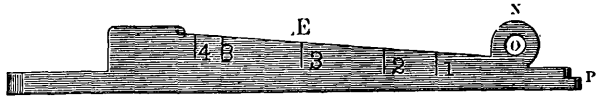

Fig. 103.



If *a* denote the observed deviation, *d* the distance between front and rear sights, *r* the range, and *x* the windage necessary to correct for the observed deviation, all being expressed in inches, we shall have:

$$x = \frac{ad}{r}$$

If it be desired to find the amount of deviation that may be corrected for by one point of windage, say at 1,000 yards, 36,000 inches, *d* being 24.54 inches, we have:

$$\frac{0.04 \text{ inch} \times 36,000}{24.54} = 58.8 \text{ inches.}$$

The binder screw is screwed into the lower base, the screw hole in the latter being countersunk to receive the binder screw head, which is curved to fit the barrel, with which it comes into close contact. When assembled, the lever being to the left, a quarter turn of the binder to the right will firmly clamp the two bases together.

The LEAF, with its slide assembled to it, is shown in Fig. 104. It is graduated from 100 to 2,000 yards. With the open sight notches, leaf up, ranges from 500 to 2,000 yards can be obtained, the 2,000 yards range being

Fig. 104.

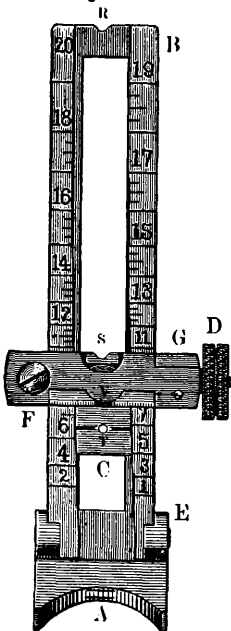

obtained with open notch at top of leaf similar to those on the slide, while the ranges from 100 to 400 yards must be obtained with the leaf down, the corresponding graduations being on the left side of the upper base. With the leaf up, using the peep sight, ranges from 100 to slightly less than 1,800 yards can be obtained. The base spring, by its bearing on the squares at lower end of leaf, maintains the leaf in its vertical or horizontal position.

The LEAF SLIDE is composed of the *body*, G; its *cap*, *cap screw*, F; *slide binding screw*, D; *binding screw pin* and *drift slide*, C. Two grooves cut in the body of the slide receive the branches of the leaf along which the slide may be moved. The cap which secures the slide to the leaf is attached to the body of the slide by entering a dovetailed groove at the right and by the cap screw at the left. A curved offset, for drift correction, is cut on the inner rear face of the two branches of the leaf to receive the drift slide, C. A small pin riveted to the drift slide enters a longitudinal groove on the inner face of the slide cap. As the slide is moved up or down the leaf, the drift slide, which carries the sighting notches, moves with it and at the same time has a lateral movement in the drift curve, due to the free lateral movement of the pin in the longitudinal groove on the inner surface of cap, thus automatically correcting for drift.¹ The slide binding screw is used to secure the slide to the leaf in any desired position. A small pin at right angles to the slide binding screw enters for about half its thickness a groove cut on the binding screw and thus prevents the removal or loss of the latter.

To assemble the two bases, they must be placed together with the binder in position, the lever to the left, the binder screw having been previously screwed into the lower base until its point is even with or slightly below the upper surface of the movable base. This screw should then be screwed firmly home.

Experimental firing and laboratory experiments show that, all other conditions being identical, the muzzle velocity of ammunition loaded with smokeless powder will be increased by exposure to a higher atmospheric temperature, and decreased by a lower. Consequently the elevation for any range will vary slightly with the atmospheric temperature. Moreover, the velocity at 53 feet stamped upon the paper packages may vary, in different issues of ammunition, 15 feet on either side of the standard. The muzzle velocity obtained in different rifles also varies with the same ammunition.

¹ Extract from Report of Chief of Ordnance for 1884, page 110, relating to rear sight for the Springfield rifle, model 1884: "Lieut. W. C. Brown, First United States Cavalry, proposed that drift lines or curves be marked on the leaf of the rear sight, model '79, so that adjustment could be made for drift; on this basis, for which credit is due to him, the automatic arrangement was devised."

In adjusting the sight for elevation at any range it must be borne in mind that, in addition to the allowance made for variations in the muzzle velocity of the ammunition, allowance must also be made for the effect of differences in light, the amount of front sight seen, the effect of mirage on the target, the effect of heat developed in firing, the personal equation of the firer, the peculiarities of individual guns, et cetera.

The graduations of the rear sight are correct only for the particular conditions existing when they were experimentally determined, consequently, in adjusting the sight for elevation at any range, allowance must be made for whatever change in the elevation the difference between the former and the present conditions produces.

All component parts of rear sights will be issued for repairs in the hands of troops.

THE REAR SIGHT, MODEL 1902,

FOR MAGAZINE RIFLE, CAL. 30,

[2,000 feet velocity cartridge.]

Consists of the following parts:

Base.	Peep Plate.
Base Screws (2).	Peep Plate Screw.
Base Spring.	Slide.
Eye Piece.	Slide Pin.
Eye Piece Knob.	Slide Screw.
Eye Piece Knob Pin.	Slide Spring.
Eye Piece Screw.	Slide Spring Plunger.
Joint Pin.	Slide Shoe.
Leaf.	

The REAR SIGHT is shown assembled in Fig. 1*a*, top view. It is graduated for every 100 yards from 100 to 2000 yards, but its construction permits adjustment for any elevation between these limits.

The BASE is shown in Fig. 2*a*, top view, and in Fig. 3*a*, right side view. The parts are, *base screw holes*,

Fig. 1 a.

Fig. 2 a

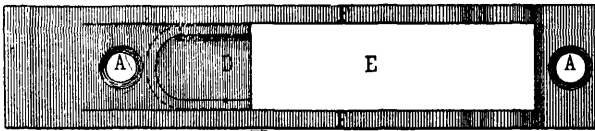

A; ears, B, in which are the *joint pin holes*, C; the *base spring seat*, D; the *base spring slot*, E; the *sides*,

Fig. 3 a.

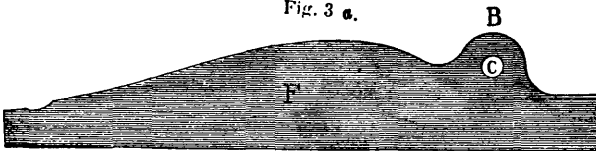

F, the upper surfaces of which are curved to give any elevation from 100 to 2000 yards inclusive. The opening between the sides forms a seat for the leaf.

Fig. 4a.



The base is secured to the barrel by two BASE SCREWS, Fig. 4*a*, which are interchangeable.

The BASE SPRING is represented in Fig. 5*a*, top view, and in Fig. 6*a*, side view. The parts are, the *tenon*, A, by which the spring is

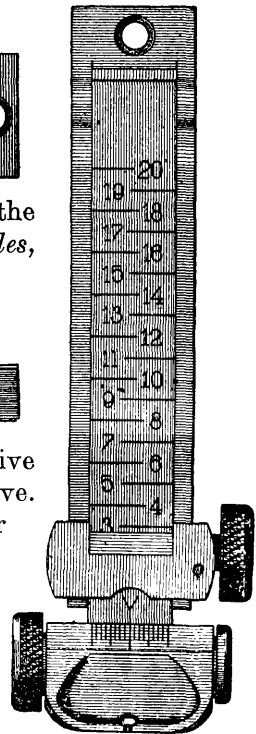

secured in its seat in the base; the *point*, B, which bears against the front end of the leaf, and holds the front lower edge of the slide in contact with the curves on the base.

The EYE PIECE, shown in Fig. 7a, top view, and in Fig. 8a, right end and rear views, has the *hole*, A, and *slot*, B, by which it is assembled on the rear end of the leaf; the *ears*, C, which project into the undercuts in the eye-piece knob and in the head of the eye-piece screw; the *open notch*, D; the *clearance*, E, and the *wind gauge graduations*, F, by which the eye-piece is adjusted to correct for any lateral deviation of the bullet; the *peep plate*, G, secured by the *screw*, H. To use peep sight, push

Fig 5i.

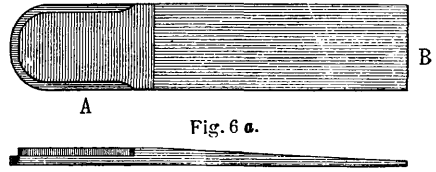

up peep plate as shown in outline on Fig. 8a. The vertical line of white metal on rear face of

Fig. 7 a.

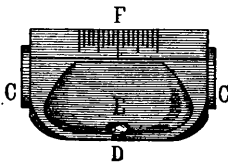
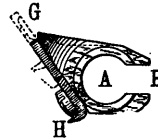
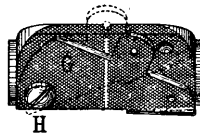

Fig. 8 a.



eye-piece and peep plate (shown in Fig. 8a) extending downward from near the open notch, assists the eye in aiming and in holding the gun so the front sight will be vertical when using the open sight.

The EYE-PIECE KNOB, Fig. 9a, has the *undercut*, A, which receives the left ear on the eye-piece; the *eye-piece screw hole*, B; the *eye-piece knob pin hole*, C, and the *knurling*, D. The knob is assembled on the tenon of the eye-piece screw, and is secured to it by the knob pin. The eye-piece is moved to the left by turning the knob toward the muzzle, and vice versa.

Fig. 9 a.



Fig. 10a.



The EYE-PIECE KNOB PIN, Fig. 10a, is cylindrical, and its ends, when inserted in its holes in the knob and eye-piece screw, should be slightly upset to prevent accidental removal.

The EYE-PIECE SCREW, Fig. 11a, has the *head*, A, which is undercut to receive the right ear on the eye-piece; the *thread*, B, which engages that in the eye-piece screw hole in the leaf; the *tenon*, C, which receives the eye-piece knob; and the *knob pin hole*, D. The eye-piece screw is assembled in its threaded hole through the rear end of the leaf on which the eye-piece is seated; the latter is held between the eye-piece screw head and knob, so that any revolution of the knob and screw will move the eye-piece laterally across the leaf. The ears on the ends of the eye-

Fig. 11 a.

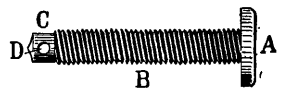

piece project into the undercuts in the eye-piece screw head and knob, so that any blow received by the screw head or knob will be taken up by the eye-piece, instead of by the eye-piece screw.

The LEAF is shown in Fig. 12a, left side view; in Fig. 13a, top view, and in Fig. 14a, wind section. The parts are, the *joint pin hole*, A; the *eye-piece screw hole*, B, which is tapped; the *eye-piece knob*, C,

Fig. 12a.

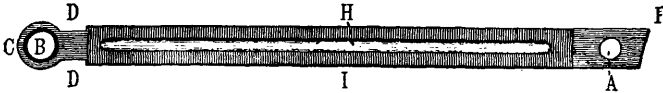
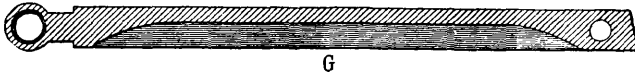

Fig. 13a.



Fig. 14a



and the *grooves*, D, on which the eye-piece is assembled; the *index mark*, E, with reference to which the eye-piece is adjusted; the *spring bearing*, F; the *lightening cut*, G; the *slide spring plunger groove*, H; and the *serrature*, I, which insures the slide from being jarred from its position by firing. The top side of the leaf is graduated from 200 to 2,000 yards, inclusive. The graduation marks are the same distance apart, which assists in adjusting the sight for elevations other than for even 100 yards.

The JOINT PIN, on which the leaf is hinged in the base, is shown in Fig. 15a. It is cylindrical with rounded ends, and fits tightly in the ears of the base.

Fig. 15a.



Fig. 16a.

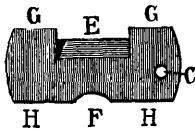

The SLIDE is represented in Fig. 16a, top view, and Fig. 17a, by a section through the slide screw hole. It has the *leaf slot*, A, by which the slide is assembled on the leaf; the *slide screw hole*, B, which is tapped; the *slide pin hole*, C; the *slide shoe seat*, D; the *adjusting edge*, E, which in adjusting the sight for elevation, should be placed

even with the proper graduation mark on the leaf, and the *groove* F, made to uncover the index line for wind gauge graduations. The distance from the adjusting edge, E, to the rear edge, H, is equal to the space between three graduation marks on the leaf, and that from the rear edge, H, to the front edge, G, is equal] to three and one-half spaces.

Fig. 17a

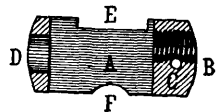

THE REAR SIGHT, MODEL 1902.

The SLIDE PIN, Fig. 18a, is straight. It retains the slide screw in the slide, and when inserted in its hole, the ends should be slightly upset.

The SLIDE SCREW, Fig. 19a, has the *head*, A, knurled to enable the screw to be firmly grasped in clamping the slide; the *thread*, B, which engages the thread in the screw hole in the slide; and the *pin groove*, C. The screw head should be turned toward the muzzle to clamp the slide, and in the opposite direction to release it.

Fig. 18a.



Fig. 19a.

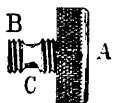

The SLIDE SPRING, Fig. 20a, is seated in its hole in the slide shoe, and its inner end bears against the flange of the plunger.

Fig. 20a.



Fig. 21a.



The SLIDE SPRING PLUNGER, Fig. 21a, has the *head*, A, which sliding in its groove in the leaf, prevents the serrature on the slide shoe from coming in contact with that on the leaf while the slide is being adjusted; the *flange*, B, against which the slide spring operates, and the *spindle*, C, which occupies the core of the spring.

Fig. 22a.



The SLIDE SHOE, Fig. 22a, face view, and Fig. 23a, sectional view, has the *slide spring seat*, A; the *slide spring plunger hole*, B; and

Fig. 23a.



the *serrature*, C, which engages the serrature on the leaf when the slide is clamped in position.

The Model 1902 Rear Sight differs from the Model 1898 in the following particulars:

The elevation curve on the base is changed to allow the use of 2000' velocity ammunition.

The base spring is changed in shape, and a corresponding change is made in its seat in the base.

The plunger groove and the serrature are added to the leaf.

The slide is changed to allow the admission of the slide shoe.

The slide spring plunger is changed in size and shape.

The slide shoe is added.

APPENDAGES.

The BARRACK CLEANING ROD, Fig. 105, has the *ring handle*, A, and the *knob*, B; it is made of brass wire; that for the carbine is 8 inches shorter than the one for the rifle, the length of each being such that the ejector will not be struck in cleaning the bore from the muzzle.

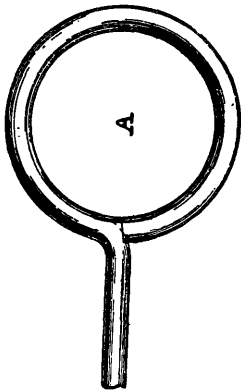

Fig. 105.

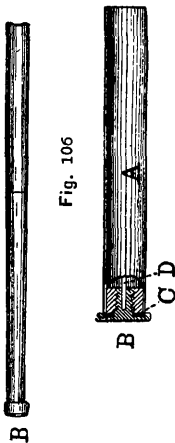

Fig. 106

The SMALL ARM OILER, Fig. 106, consists of the *can*, A; *top*, B; *washer*, C; and *wire*, D. The washer is to prevent leaking of the oil. The wire, the point of which is flattened, is to apply oil, a drop or more at a time. The oiler is carried either in the butt of the stock or in a loop of the cartridge belt. The oil is only for lubrication of the working parts.

The SCREW DRIVER, Fig. 107, has the *large blade*, A; the *small blade*, B; and the *pin*, C. The large blade should be

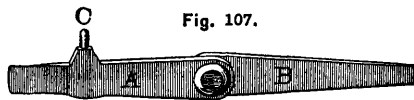

Fig. 107.

used for the large butt plate screw, and for the screws in the upper band, guard, and butt plate cap spring; the small blade for all other screws, except the rear sight joint screw, which requires a narrower blade. The pin serves as a drift in remov-

ing the butt plate cap, trigger, and lower band pins.

The SMALL ARM POCKET OILER is shown in Fig. 108. This oiler, having a capacity of two ounces, is as large as can be conveniently carried in the pocket. It is intended for the use of troops serving in the tropics, to provide each man with an

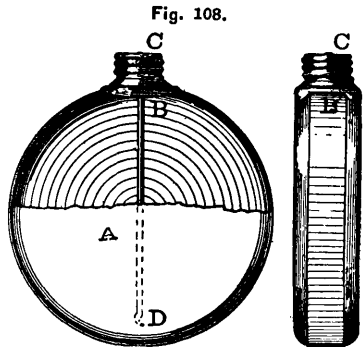

Fig. 108.

additional supply of oil to that contained in the small oiler carried in the butt of the arm. It is made of sheet brass, nickel-plated, with a screw top, to which is attached a wire with spoon end, for removing the oil in drops. The general dimensions are, diameter, 2.75 inches; thickness, 0.6875 inch.

The parts comprise the *body*, A; *neck*, B; *cap*, C; *cap washers*, and *spoon*, D; the body, neck, and cap are made of sheet brass 0.02 inch thick. The body is punched and drawn in two cup-shaped parts that overlap when fitted together, and are then soldered. The neck is punched, drawn, rolled for threading, and soldered on the body. The cap is punched, drawn, rolled for threading, and knurled; within the cap are two washers; one of felt to prevent leakage; and one of steel of smaller diameter, which serves to reinforce the top of the cap for riveting the spoon.

The FRONT SIGHT AND MUZZLE COVER, Fig. 109, has the *front*

Fig. 109

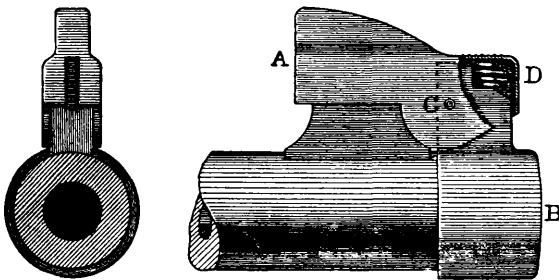

sight cover, A; the *muzzle cover*, B; the *pin*, C, which acts as a hinge; and the *spring*, D. To detach from gun, raise the sight cover by pressing on front end with thumb, and draw forward.

Fig. 110 shows the CARBINE FRONT SIGHT COVER.

Fig. 110

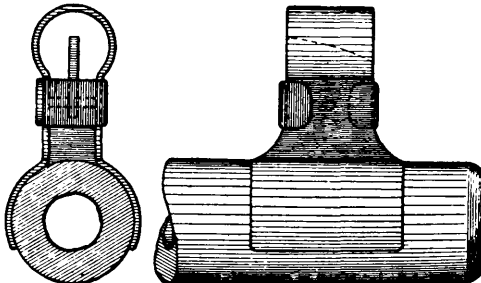

THE ASSEMBLED PARTS AND THEIR OPERATIONS.

Most of the operating parts may be included under the BOLT MECHANISM and the MAGAZINE MECHANISM.

The BOLT MECHANISM consists of the bolt, sleeve, extractor, extractor rivet, safety lock, firing pin, striker, and main spring.

The bolt moves backward and forward and rotates in the well hole of the receiver; it carries a cartridge, either from the magazine or one placed by hand in front of it, into the chamber and supports its head when fired. The locking lug will sustain any powder pressure liable to occur, but if worn by usage or upset by excessive pressures the rear end of the guide rib will bear on the locking shoulder of the receiver, permitting the continued use of the arm with safety.

The sleeve unites the parts of the bolt mechanism; its rotation with the bolt is prevented by its arm occupying the opening between the walls of the receiver.

The hook of the extractor engages the rim of the cartridge case and retains the head of the latter in the countersink of the bolt until the case is ejected. The extractor spring, engaging its lip on the receiver, prevents the hook from releasing the rim of the cartridge case, when the latter is being started from the chamber. The extractor pin holds the bolt open for convenience in loading when using single-loader fire.

The safety lock, when turned to the left, is inoperative; when turned to the right, the point of its spindle enters the notch in the bolt collar and locks the bolt. If turned to the right when the piece is cocked, its cam forces the firing pin slightly to the rear, out of contact with the sear, so that, if the trigger be pulled, the sear, when the trigger is released, can rise to catch the firing pin, when the safety lock is turned to the left, thereby preventing accidental discharge. If turned to the right, when the piece is not cocked, it locks the firing pin as well as the bolt.

The gun having been discharged, to remove the empty cartridge case, reload and fire; the bolt mechanism operates as follows:

To open the bolt, raise the handle until it comes into contact with the sleeve, then pull it directly to the rear until the locking lug strikes the locking shoulder of the receiver.

Raising the handle rotates the bolt. This separates the locking lug from the shoulder of its recess in the receiver, with which it is brought into close contact by the powder pressure. This separation is made easy by the slight inclination to the axis of the receiver of the vertical planes containing the rear surface of the locking lug and the shoulder of its recess.

The rotation also causes the cocking cam of the bolt to force the firing pin to the rear, withdrawing the point of the striker into the bolt. The rotation of the firing pin is prevented by the lug on the cocking piece projecting through the slot in the sleeve into its groove in the receiver. As the sleeve remains longitudinally stationary with reference to the bolt, this rearward motion of the firing pin, and consequently of the striker, will begin the compression of the main spring, since the rear end of the latter bears against the front end of the barrel of the sleeve, and the front end against the rear end of the striker.

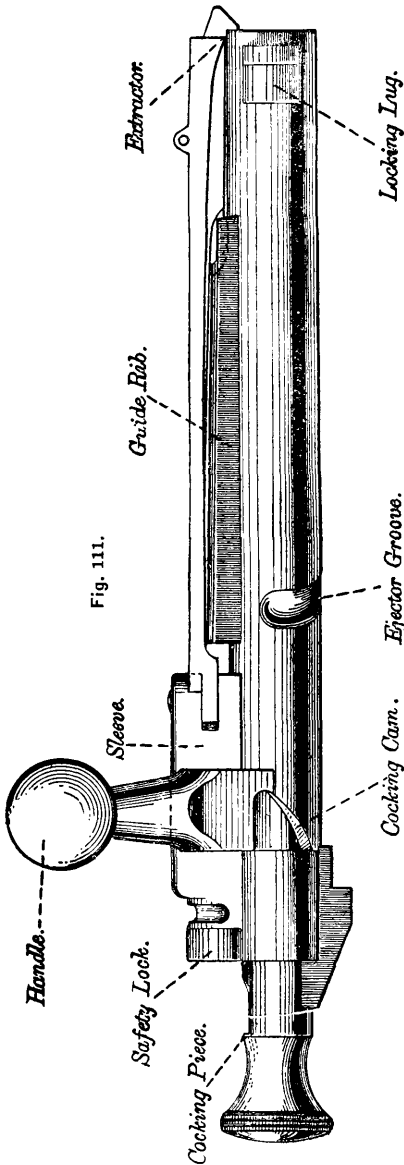

Fig. 111.

When the bolt handle strikes the sleeve, rotation ceases, during which the firing pin has been forced to the rear by the cocking cam on the bolt until the sear notch of the cocking piece has passed the point of the sear, the cocking-piece nose entered the notch in the rear end of the bolt, and the main spring partly compressed; the locking lug will then be out of its recess and the guide rib under the extractor.

When the bolt handle is raised into contact with the cam on the cocking shoulder of the receiver, a direct motion to the rear will be combined with the rotation, so that the cartridge case will be started from the chamber by the action of this cam.

The bolt is then drawn directly to the rear, the extractor and guide rib move along the left wall and through the opening between the two walls of the receiver. The parts are retained in position by the cocking-piece nose remaining in the notch in the rear end of the bolt, and the main spring is partly compressed.

The relative position of the parts of the bolt mechanism is then shown in Fig. 111.

To close the bolt, push the handle forward until it strikes the cocking shoulder, then turn it down until it comes into contact with its seat in the receiver. As the handle is turned down, the rear end of the guide rib, traveling along the cam of the locking shoulder of the receiver, will move the bolt forward until the locking lug comes into contact with the cam of its recess in the receiver, which moves the bolt slightly forward into its closed position. As all movement of the firing pin is prevented by the point of the sear engaging the sear notch of the cocking piece, the forward movement of the bolt, produced by these cams, completes the compression of the main spring, the seating of the cartridge in the chamber, and forces the extractor hook over the rim of the cartridge case.

In closing the bolt, a cartridge from the magazine, if using magazine fire, or one placed by hand in the well of the receiver in front of the bolt, will be carried forward into the chamber. The gun is then ready to be fired.

The position then occupied by the parts is shown in Fig. 112.

When the bolt is rotated so the guide rib is under the extractor, the front end of the guide rib engages a lug on the underside of the extractor and holds the latter against the left wall of the receiver so the hook, as the bolt is closed, will enter its notch in the receiver and barrel.

To pull the trigger, the finger-piece must be drawn to the rear until contact with the receiver is transferred from its bearings to the heel, which gives a creep to the trigger, and then until the point of the sear is withdrawn from in front of the cocking piece.

The heel of the ejector rises into its groove in the bolt, but just before the bolt is drawn fully to the rear, the end of the groove suddenly forces the heel down, causing the point to rise in front of the bolt and strike the cartridge case. As the bolt is closed, the heel rises again into its groove, the curved portion of which permits the bolt to rotate without operating the ejector. The upper surface of the front end of the ejector is shaped so as to throw the cartridge case out of the receiver, upward and to the right.

It is to be noted that, in this system of bolt mechanism, the compression of the main spring, the seating of the cartridge in and the starting of the empty case from the chamber, are entirely done by the action of cams.

The piece may be cocked either by raising the bolt handle until it strikes the sleeve and then immediately turning it down, or by pulling the cocking piece directly to the rear.

In firing, unless the bolt handle is turned fully down against its seat in the receiver, the cam on the cocking piece will strike that in the rear end of the bolt and the energy of the main spring will be

expended in closing the bolt instead of on the primer; this prevents the possibility of a cartridge being fired until the bolt is fully closed.

The opening and the closing of the bolt should each be done by one continuous motion.

Fig. 112.

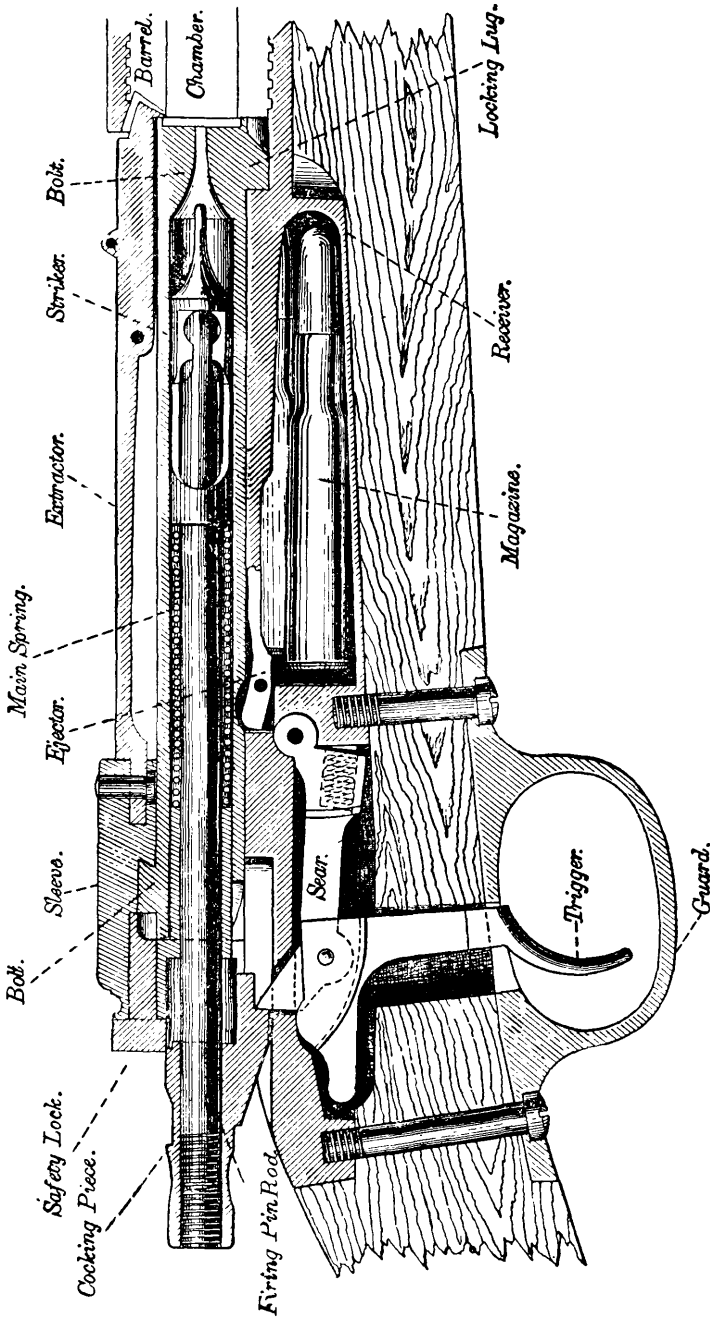

The MAGAZINE MECHANISM includes the gate, carrier, follower, magazine spring, hinge bar and cut-off.

Fig. 113.

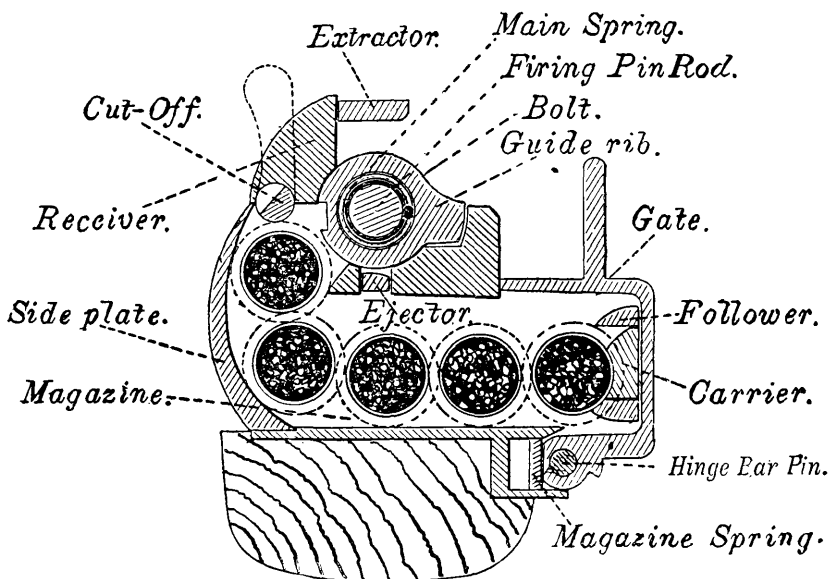
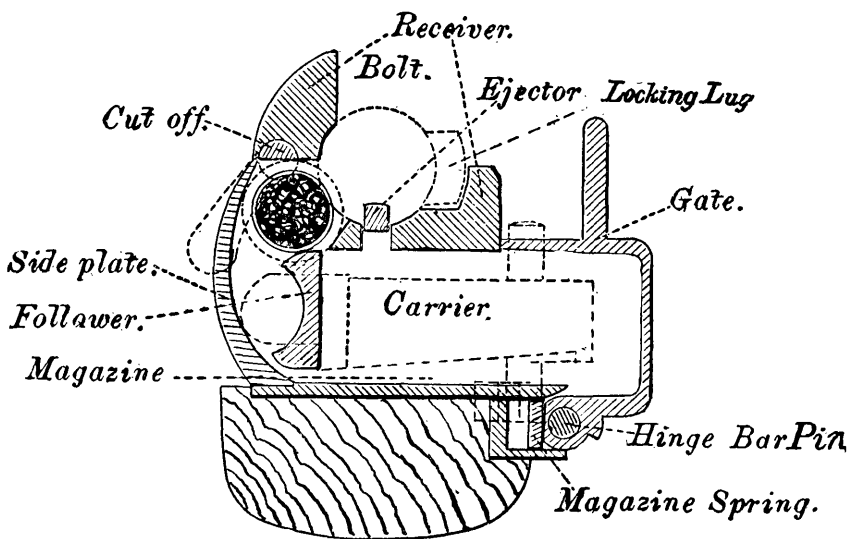

Fig. 113 represents a cross section of the Model 1896 gun, through the point of the ejector; the bolt is closed, the magazine contains five cartridges and is "off."

Fig. 114 shows the same cross section when all but the last cartridge has been fired; the magazine is "on" and the bolt opened.

Fig. 114.



To charge the magazine, open the gate, insert the cartridges from a clip, or from the hand, then close the gate.

As the gate is opened, its lug, acting on the cam of the carrier, Fig. 115, retracts the latter within the recess of the gate, leaving

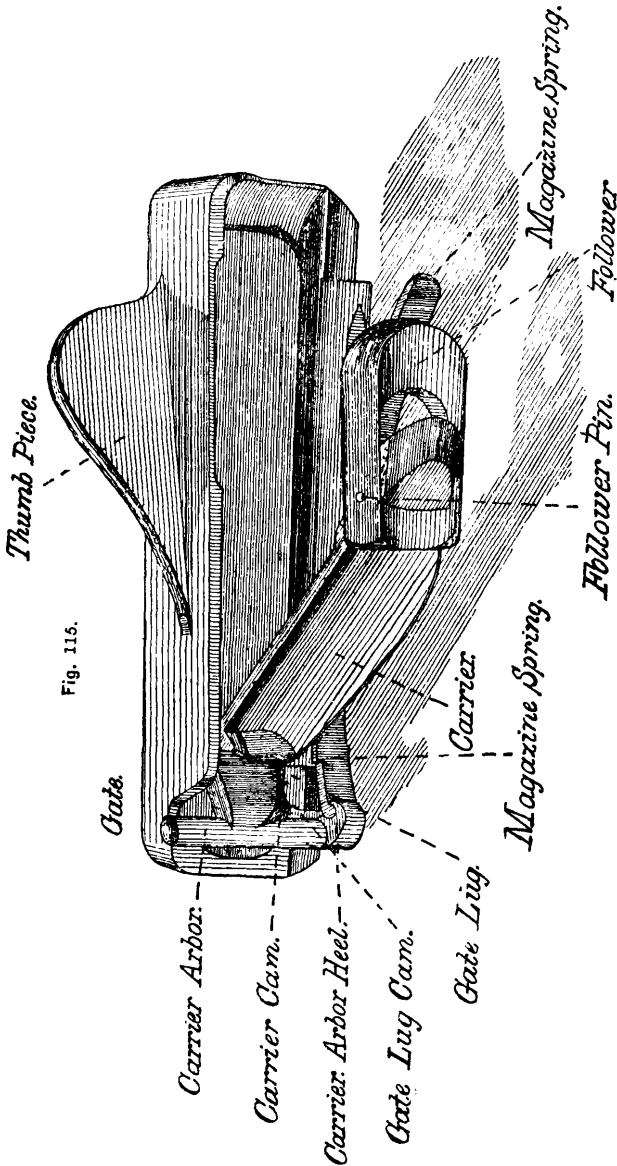

an unobstructed opening for the insertion of the cartridges. As the gate is closed, the magazine spring, the front end of which bears on the lug of the arbor of the carrier, Fig. 115, swings the carrier

into the magazine, against the last cartridge inserted. The point of the carrier forces the cartridges, in succession, against and up the curved surface of the side plate, into the magazine channel. When there is only one cartridge in the magazine, the point of the carrier forces it up on the top of the follower, which holds it high enough in the channel to be caught by the bolt. The point of the carrier then rests against the inner surface of the side plate.

When the thumb-piece of the cut-off in the Model 1896 arms is turned up, Fig. 113, the magazine is "off." The point of the spindle then bears on the rim of the upper cartridge and holds it down in the magazine channel below the action of the bolt. The magazine mechanism then remains inoperative, and the arm can

Fig. 116.

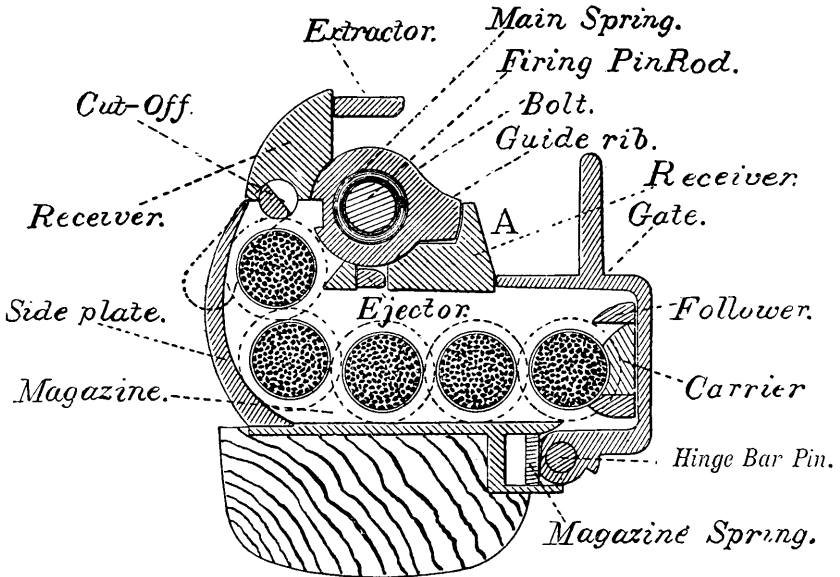

be used as a single loader, the cartridges in the magazine being held in reserve.

When the thumb-piece of the cut-off, in the Model 1896 arms, is turned down, Fig. 114, the magazine is "on." The point of the spindle then occupies its hole in the upper wall of the magazine channel, and permits the top cartridge to rise high enough to be caught by the bolt in its forward movement. As the bolt is closed, this cartridge is pushed forward, through the magazine channel and well of the receiver, into the chamber, the point of the bullet being directed by the ramps on the side plate and receiver. During this passage the cartridge is held up in the magazine channel by the pressure of those below. The last one in the magazine is held up first, by the top of the follower, and after passing the

latter, by the rib of the side plate and left edge of the roof of the magazine.

Note.—These “cut-offs” are being replaced by those shown in Fig. 116 for all Model 1896 guns.

In the Model 1898 arms, when the thumb-piece of the cut-off is turned down, Fig. 116, the magazine is “off,” and when turned up, is “on;” or the reverse of what it is in the Model 1896. As the arm is habitually used with the magazine “off,” the thumb-piece of the cut-off is better protected when turned down.

The magazine can be charged with the bolt closed or open, with the cut-off turned for magazine or single-loader fire, and, if one or more cartridges have been fired, can be filled.

The magazine spring actuates the carrier, holds the gate open, assists in closing it, and holds it closed.

The guide lip prevents the heads of the cartridges from falling into the well of the gate when charging the magazine.

To open the butt plate cap, insert the rim of an empty cartridge case in the notch in the cap and draw it open. The joints of the cleaning rod should be removed before the oiler. In replacing the oiler and rods, insert the former so its bottom will be next the butt plate, and, with one joint of the rod, push the oiler into its seat, then insert the rods.

PRECAUTIONS.

If it is desired to carry the piece cocked, with a cartridge in the chamber, the bolt mechanism should be secured by turning the safety lock to the right.

To obtain positive ejection, and to insure the bolt catching the top cartridge in the magazine, when using magazine fire, the bolt must be drawn fully to the rear in opening it.

If a cartridge is pushed from the magazine partly into the chamber, and then the bolt fully drawn to the rear, that cartridge will remain in the well and chamber, and a second will rise from the magazine in front of the bolt. If the bolt is again pushed forward, the second cartridge will strike the first and produce a *jam*. To avoid this, always close the bolt on a cartridge in front of it to insure the action of the extractor and ejector on that cartridge, when the bolt is opened.

If a jam occurs, draw the bolt fully to the rear and, with the right hand, remove the first cartridge and close the bolt; if the first cartridge has been pushed into the chamber, draw the bolt to the rear, with the thumb of the right hand push the second cartridge back into the magazine and cut it off; then close the bolt on the first cartridge.

Unless the bolt handle is fully turned down into contact with its seat in the receiver, when the trigger is pulled the nose of the cocking piece will strike against the cocking cam of the bolt, and the energy of the mainspring will be expended in closing the bolt instead of igniting the primer, causing a miss-fire. Care should be taken *not* to raise the bolt handle with the forefinger if the trigger is pulled with the middle one.

It is essential for the proper working and preservation of all cams that they be kept lubricated.

DISMOUNTING AND ASSEMBLING BY SOLDIER.

The bolt and magazine mechanism can be dismantled without removing the stock. The latter should never be done except for making repairs, and then only by some selected and instructed man.

TO DISMOUNT BOLT MECHANISM.

1. Draw the bolt fully to the rear, then place the piece across hollow of left arm.
2. Lift the front end of hook of extractor off bolt with left thumb, and at the same time turn bolt handle to left with right hand (see Fig. 117). The bolt can then be drawn from the receiver.

Fig. 117

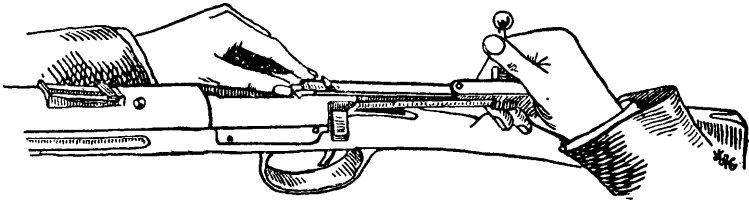

3. Take bolt handle in left hand, back of hand down, bolt upside down. Grasp cocking piece with right hand (Fig. 118).

Fig. 118.

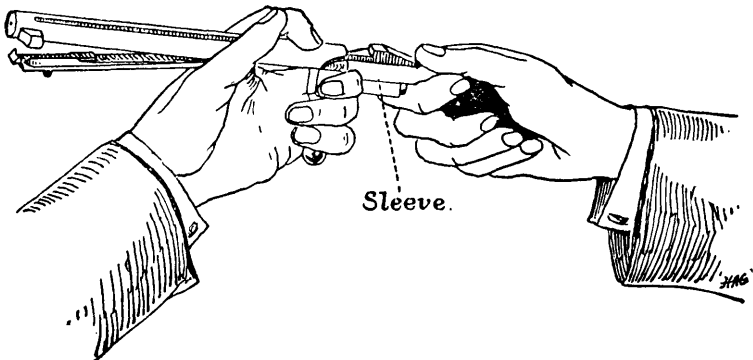

4. Slightly draw back cocking piece and turn it toward the operator until the firing pin can be removed from the bolt.

5. Take firing pin in left hand and bear down on point of striker with right thumb until it leaves the firing pin; remove mainspring from firing pin and the latter from sleeve.

TO ASSEMBLE BOLT MECHANISM.

1. Observe that the safety lock is turned to the left. Reverse the order of the steps of fifth operation in dismounting.

2. Grasp the bolt handle in left hand as in third operation in dismounting, and the firing pin in right hand, extractor uppermost. Insert firing pin in bolt.

3. Grasp handle of bolt with fingers of both hands, bolt directed downward, and with both thumbs on the rear of safety lock (Fig.

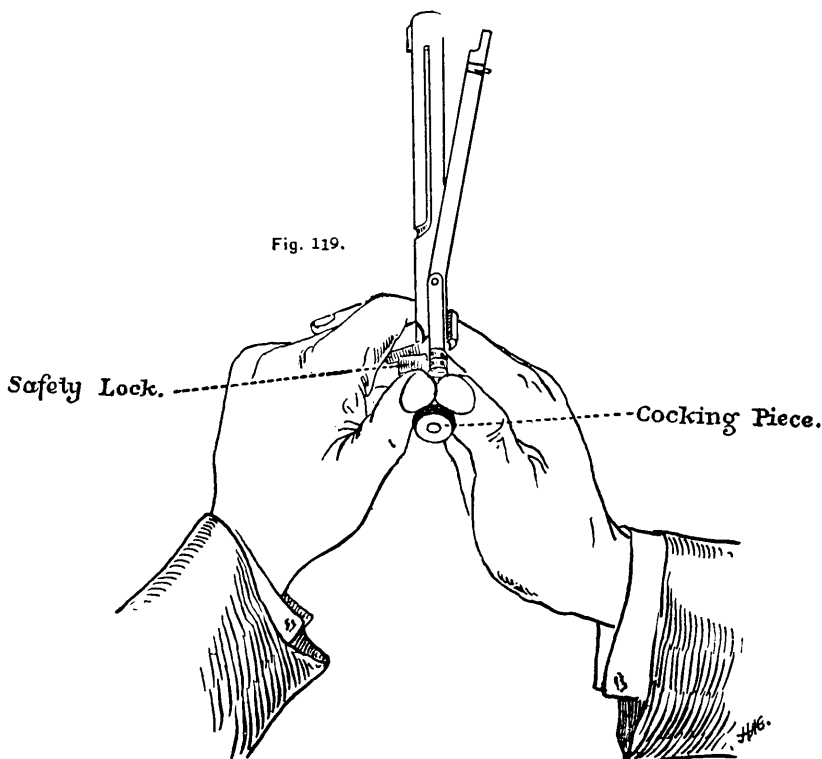

119), push strongly forward and turn to right with thumbs until the arm of the sleeve engages the collar of the bolt.

4. Grasp bolt and cocking piece as in third operation for dismounting. Draw back and turn cocking piece from the operator until its nose enters the notch on the rear end of the bolt (see Fig. 118).

5. Take bolt in right hand and introduce it into the receiver, keeping the extractor lifted with the right thumb (Fig. 120).

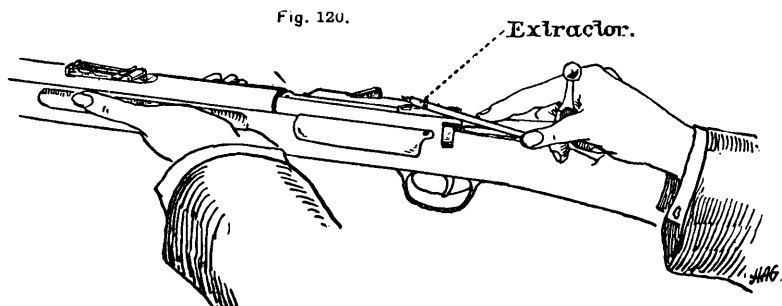

Turn bolt to right and at the same time press strongly with first finger against right side of extractor.

TO DISMOUNT MAGAZINE MECHANISM.

1. The gate being closed, engage the flanged head of a cartridge case under the lug on the front end of the hinge bar head and turn the latter toward the gate, out of its seat; then bear heavily on the gate with the palm of the right hand, to overcome the pressure of the magazine spring, and, with the left, press forward against the lug, drawing the hinge bar pin from the receiver.

2. Remove the gate, magazine spring, carrier and follower.

TO ASSEMBLE MAGAZINE MECHANISM.

1. Hold the piece with right side uppermost. Insert arbor of carrier into its hole in receiver and place end of left thumb across magazine to prevent carrier swinging into the latter.

2. Place magazine spring in its channel, convex side up, rounded end to the rear, particularly observing that the lip at its front end rests in the notch on heel of carrier.

3. Place gate in its seat, lug entering between carrier and magazine spring. Remove left thumb and at the same time press gate against magazine spring with right hand.

4. Insert hinge bar pin in front hinge hole in receiver with left hand, and press gate down strongly until the pin can be pushed through gate into rear hinge hole.

5. After the hinge bar pin is fully home, turn the head into its seat by opening the gate.

TO COMPLETE DISMOUNTING.

(NOT TO BE DONE BY SOLDIER.)

The bolt and magazine mechanism having been dismantled, proceed as follows:

1. Remove front sight by driving the front sight pin out of its hole from the left.

2. Remove upper band screw and slip band forward off barrel.
 3. Loosen lower band screw, remove band.
 4. To remove the hand guard: remove the rear sight and force hand guard springs off barrel by screw-driver blades inserted between guard and stock.
 5. Remove guard screws and guard.
 6. Remove receiver and barrel from stock.
 7. Remove side plate screw, then side plate by pushing out the rear end, until free from the receiver, and drawing it to the rear.
 8. Remove ejector pin by means of its knob, then ejector.
 9. Press trigger forward until nose of sear is withdrawn from its slot in receiver; then bearing against right side of sear push it out of its seat.
 10. Turn cut-off down, and with tool No. 5 in armorer's kit, or with the blade of a narrow screw-driver, force the spring into the thumb-piece and draw out.
 11. To remove safety lock, turn it vertical and strike the front face of its thumb-piece a light blow.
- The rear sight leaf should never be removed from the base nor the base from the barrel except for making repairs.
- The barrel should never be unscrewed from the receiver.

TO ASSEMBLE AFTER DISMOUNTING.

1. SAFETY LOCK.—Introduce the point of the tang of a small file, or any tool of similar size and shape, between the thumb-piece and the spring spindle, thus compressing the spring and forcing the spring spindle into the thumb-piece; insert the safety lock spindle in its hole in the sleeve, the thumb-piece being held vertical, push the safety lock forward, gradually withdrawing the tool.
2. CUT-OFF.—Insert its spindle, the thumb-piece turned down into the cut-off hole in the receiver, until the spring spindle strikes the receiver; then with the blade of a screw-driver, force the spring spindle into its hole in the thumb-piece and push the cut-off into place. Care must be taken that the flattened and not the straight sides of the spring spindle bear on the curved surface of the recesses in the receiver.
3. SEAR AND TRIGGER.—Insert the spring in its hole in the sear, start the hinge of the sear into its seat in the receiver, and with a blade of the screw-driver, compress the spring in its hole until the sear can be pushed into place.

Reverse and follow in inverse order the other operations of dismounting.

CLEANING AND CARE OF THE ARM.

As the residuum of smokeless powder, if not completely removed, corrodes the bore in a short time, care is required in cleaning the arm after firing.

To clean the barrel, insert in the chamber a cartridge shell, the front end of which has been filled with a wooden plug, and close the bolt; clean the bore with rags saturated with soda water, or, if that is not obtainable, with hot water; wipe thoroughly dry with clean rags; remove the bolt and cartridge shell; clean and dry the chamber, from the rear, in the same manner; oil both chamber and bore with cosmoline oil, leaving a light coating. Twenty-four hours after this first cleaning, the bore should again be cleaned as described above, as it has been found that the powder gases are probably forced into the texture of the steel and will, if a second cleaning is not resorted to, cause rusting, no matter how thoroughly the bore may have been cleaned at first. When the jointed rod is used, remove the bolt, clean half of the bore from the muzzle and the remainder through the receiver, as above prescribed.

CLEANING THE RIFLE.

The proper care of the bore requires conscientious, careful work, but it pays well in reduced labor of cleaning and in prolonged accuracy-life of the barrel, and better results in target practice. Briefly stated, the care of the bore consists in removing the fouling resulting from firing to obtain a chemically clean surface and coating this surface with a film of oil to prevent rusting. The fouling which results from firing is of two kinds—one, the products of combustion of the powder; the other, cupro-nickel scraped off (under the abrading action of irregularities or grit in the bore). Powder fouling, because of its acid reaction, is highly corrosive; that is, it will induce rust and must be removed. Metal fouling of itself is inactive, but may cover powder fouling and prevent the action of cleaning agents until removed, and when accumulated in noticeable quantities it reduces the accuracy of the rifle.

Powder fouling may be readily removed by scrubbing with hot soda solution, but this solution has no effect on the metal fouling of cupro-nickel. It is therefore necessary to remove all metal fouling before assurance can be had that all powder fouling has been removed and that the bore may be safely oiled. Normally, after firing a barrel in good condition, the metal fouling is so slight as to be hardly perceptible. It is merely a smear of infinitesimal thickness, easily removed by solvents of cupro-nickel. However, due to pitting, the presence of dust, other abrasives, or to accumulation, metal fouling may occur in clearly visible flakes or patches of much greater thickness, much more difficult to remove.

In cleaning the bore after firing, it is well to proceed as follows: Swab out the bore with soda solution (see below) to remove powder fouling. A convenient method is to insert the muzzle of the rifle

into the can containing the soda solution and, with the cleaning rod inserted from the breech, pump the barrel full a few times. Remove and dry with a couple of patches. Examine the bore to see that there are in evidence no patches of metal fouling which, if present, can be readily detected by the naked eye, then swab out with the swabbing solution—a dilute metal-fouling solution. (See below.) The amount of swabbing required with the swabbing solution can be determined only by experience, assisted by the color of the patches. Swabbing should be continued, however, as long as the wiping patch is discolored by a bluish-green stain. Normally a couple of minutes' work is sufficient. Dry thoroughly and oil.

The proper method of oiling a barrel is as follows: Wipe the cleaning rod dry; select a clean patch and thoroughly saturate it with sperm oil or warmed cosmic, being sure that the cosmic has penetrated the patch; scrub the bore with the patch, finally drawing the patch smoothly from the muzzle to the breech, allowing the cleaning rod to turn with the rifling. The bore will be found now to be smooth and bright, so that any subsequent rust and sweating can be easily detected by inspection.

If patches of metal fouling are seen upon visual inspection of the bore, the standard metal-fouling solution prepared as hereinafter prescribed must be used. After scrubbing out with the soda solution, plug the bore from the breech with a cork at the front end of the chamber, or where the rifling begins. Slip a 2-inch section of rubber hose over the muzzle down to the sight and fill with the standard solution to at least one-half inch above the muzzle of the barrel. Let it stand for 30 minutes, pour out the standard solution, remove hose and breech plug, and swab out thoroughly with soda solution to neutralize and remove all trace of ammonia and powder fouling. Wipe the barrel clean, dry, and oil. With few exceptions, one application is sufficient, but if all fouling is not removed, as determined by careful visual inspection of the bore and of the wiping patches, repeat as described above.

After properly cleaning with either the swabbing solution or the standard solution, as has just been described, the bore should be clean and safe to oil and put away, but as a measure of safety a patch should *always* be run through the bore on the next day and the bore and wiping patch examined to insure that cleaning has been properly accomplished. The bore should then be oiled, as described above.

If the swabbing solution or the standard metal-fouling solution is not available, the barrel should be scrubbed, as already described, with the soda solution, dried, and oiled with a light oil. At the end of 24 hours it should again be cleaned, when it will usually be found to have "sweated"; that is, rust having formed under the smear of

metal fouling where powder fouling was present, the surface is puffed up. Usually a second cleaning is sufficient, but to insure safety it should be again examined at the end of a few days before final oiling. The swabbing solution should always be used, if available, for it must be remembered that each puff when the bore "sweats" is an incipient rust pit.

A clean dry surface having been obtained, to prevent rust, it is necessary to coat every portion of this surface with a film of neutral oil. If the protection required is but temporary and the arm is to be cleaned or fired in a few days, a sperm oil may be used. This is easily applied and easily removed but has not sufficient body to hold its surface for more than a few days. If rifles are to be prepared for storage or shipment, a heavier oil, such as cosmic, must be used.

In preparing arms for storage or shipment they should be cleaned with particular care, using the metal-fouling solution as described above. Care should be taken, insured by careful inspection on succeeding day or days, that the cleaning is properly done and all traces of ammonia solution removed. The bore is then ready to be coated with cosmic. At ordinary temperatures cosmic is not fluid. In order, therefore, to insure that every part of the surface is coated with a film of oil, the cosmic should be warmed. Apply the cosmic first with a brush; then, with the breech plugged, fill the barrel to the muzzle, pour out the surplus, remove the plug, and allow to drain. It is believed that more rifles are ruined by improper preparation for storage than from any other cause. If the bore is not clean when oiled—that is, if powder fouling is present or rust has started—a half inch of cosmic on the outside will not stop its action, and the barrel will be ruined. Remember that the surface must be perfectly cleaned before the heavy oil is applied. If the instructions as given above are carefully followed, arms may be stored for years without harm.

PREPARATION OF SOLUTIONS.

Soda solution.—This should be a saturated solution of sal soda (bicarbonate of soda). A strength of at least 20 per cent is necessary. The spoon referred to in the following directions is the model of 1910 spoon issued in the mess outfit.

Sal soda—one-fourth pound, or 4 (four) heaping spoonfuls.

Water—1 pint or cup, model of 1910, to upper rivets.

The sal soda will dissolve more readily in hot water.

Swabbing solution.—Ammonium persulphate—60 grains, one-half spoonful smoothed off.

Ammonia, 28 per cent—6 ounces, or three-eighths of a pint, or 12 spoonfuls.

Water—4 ounces, or one-fourth pint, or 8 spoonfuls.

Dissolve the ammonium persulphate in the water and add the ammonia. Keep in tightly corked bottle; pour out only what is necessary at the time, and keep the bottle corked.

Standard metal-fouling solution.—Ammonium persulphate—1 ounce, or 2 medium heaping spoonfuls.

Ammonium carbonate—200 grains.

Ammonia, 28 per cent—6 ounces, or three-eighths pint, or 12 spoonfuls.

Water—4 ounces, or one-fourth pint, or 8 spoonfuls.

Powder the persulphate and carbonate together, dissolve in the water and add the ammonia; mix thoroughly and allow to stand for one hour before using. It should be kept in a strong bottle, tightly corked. The solution should not be used more than twice, and used solution should not be mixed with unused solution, but should be bottled separately. The solution, when mixed, should be used within 30 days. Care should be used in mixing and using this solution to prevent injury to the rifle. The ammonia solution should not be used in a warm barrel. An experienced noncommissioned officer should mix the solution and superintend its use.

Neither of these ammonia solutions has any appreciable action on steel when not exposed to the air, but if allowed to evaporate on steel they attack it rapidly. Care should, therefore, be taken that none spills on the mechanism and that the barrel is washed out promptly with soda solution. The first application of soda solution removes the greater portion of the powder fouling and permits a more effective and economical use of the ammonia solution. These ammonia solutions are expensive and should be used economically.

It is a fact recognized by all that a highly polished steel surface rusts much less easily than one which is roughened; also, that a barrel which is pitted fouls much more rapidly than one which is smooth. Every effort, therefore, should be made to prevent the formation of pits, which are merely enlarged rust spots, and which not only affect the accuracy of the arm but increase the labor of cleaning.

The chambers of rifles are frequently neglected because they are not readily inspected. Care should be taken to see that they are cleaned as thoroughly as the bore. A roughened chamber delays greatly the rapidity of fire and not infrequently causes shells to stick.

A cleaning rack should be provided for every barracks. Rifles should always be cleaned from the breech, thus avoiding possible injury to the rifling at the muzzle which would affect the shooting adversely. If the bore for a length of 6 inches at the muzzle is perfect, a minor injury near the chamber will have little effect on the accuracy of the rifle. The rifle should be cleaned as soon as the

firing for the day is completed. The fouling is easier to remove then, and if left longer it will corrode the barrel.

If gas escapes at the base of the cartridge, it will probably enter the well of the bolt through the striker hole. In this case the bolt mechanism must be dismantled and the parts and well of the bolt thoroughly cleaned.

Before assembling the bolt mechanism, the firing pin, the barrel of the sleeve, the body of striker, the well of bolt, and all cams should be lightly oiled.

Many of the parts can generally be cleaned with dry rags. All parts after cleaning should be wiped with an oiled rag.

The best method of applying oil is to rub with a piece of cotton cloth upon which a few drops of oil have been placed, thereby avoid in the use of an unnecessary amount of oil; this method will, even in the absence of the oiler, serve for the cams and bearings, which should be kept continually oiled.

Any part that may appear to move hard can generally be freed by the use of a little oil.

The stock and hand guard may be coated with raw linseed oil and polished by rubbing with the hand.

Sperm oil should only be used for lubricating metallic bearing and contact surfaces.

For the chamber and bore, only cosmoline or cosmic should be used. This should also be applied to all metallic surfaces, to prevent rusting when arms are stored or when not used for an appreciable length of time.

INSTRUCTIONS FOR REPAIRING U. S. MAGAZINE ARMS IN THE HANDS OF TROOPS.

The following component parts only of the Models 1896 and 1898 arms will be issued for repairs in the hands of troops:

RIFLE.

Bayonet.	Butt Swivel Screw.
Bolt.	Carrier.
Butt Plate.	Cleaning Rod, 1st section.
Butt Plate Cap.	Cleaning Rod, 2d and 3d sections.
Butt Plate Cap Pin	Cut-off.
Butt Plate Cap Spring.	Ejector.
Butt Plate Cap Spring Screw.	Ejector Pin.
Butt Plate Screw, large.	Extractor.
Butt Plate Screw, small.	Extractor Pin.
Butt Swivel.	Extractor Rivet.

Extractor Spring.	Magazine Spring.
Firing Pin.	Main Spring.
Follower.	Safety Lock.
Follower Pin.	Sear.
Front Sight.	Sear Spring.
Front Sight Pin.	Side Plate.
Gate.	Side Plate Screw.
Guard.	Sleeve.
Guard Screw, front.	Stacking Swivel.
Guard Screw, rear.	Stacking Swivel Screw.
Hand Guard.	Stock.
Hinge Bar.	Striker.
Lower Band.	Trigger.
Lower Band Pin.	Trigger Pin.
Lower Band Swivel.	Upper Band.
Lower Band Swivel Screw.	Upper Band Screw.

CARBINE.

PARTS SAME AS IN RIFLE.

Bolt.	Follower Pin.
Butt Plate.	Front Sight Pin.
Butt Plate Cap.	Gate.
Butt Plate Cap Pin.	Guard.
Butt Plate Cap Spring.	Guard Screw, front.
Butt Plate Cap Spring Screw.	Guard Screw, rear.
Butt Plate Screw, large.	Hinge Bar.
Butt Plate Screw, small.	Magazine Spring.
Carrier.	Main Spring.
Cleaning Rod, 1st section.	Safety Lock.
Cleaning Rod, 2d section.	Sear.
Cut-off.	Sear Spring.
Ejector.	Side Plate.
Ejector Pin.	Side Plate Screw.
Extractor.	Sleeve.
Extractor Pin.	Striker.
Extractor Rivet.	Swivel Screw, rear.
Extractor Spring.	Trigger.
Firing Pin.	Trigger Pin.
Follower.	

PARTS PECULIAR TO THE CARBINE.

Band.	Rear Sight Slide, Model 1896. ¹
Band Spring.	Rear Sight Slide Cap, Model 1896.
Front Sight.	Rear Sight Movable Base, Model 1901.
Hand Guard.	
Rear Sight Base, Model 1896.	Rear Sight Leaf, Model 1901.
Rear Sight Leaf, Model 1896.	Stock.

¹ Includes screw and pin.

PARTS WHICH ARE MOST LIABLE TO REQUIRE REPAIR.

BAYONET CATCH NUT.—Works loose and is lost, if the end of the catch has not been well riveted over the nut.

COCKING PIECE.—Nose worn from neglect to keep it lubricated.

CUT-OFF.—Thumb-piece knocked off by blow, due to form.

GATE.—Lug broken off by escape of gas into the magazine, due to defective cartridges.

HINGE BAR.—Head broken off from blow, or attempt to withdraw it improperly.

LOWER BAND SWIVEL AND SCREW.—Screw, if not riveted in place, works loose and with swivel is lost.

STACKING SWIVEL AND SCREW.—Screw, if not riveted in place, works loose and with swivel is lost.

STOCK.—Bruises, cuts, pieces chipped from different points. Broken at "small."

STRIKER.—Point burned by defective cartridges.

THE REPLACING OF BROKEN PARTS.

BUTT PLATE CAP PIN.—This pin has both ends upset; the burr on one end must be filed off and the pin driven out with a drift; when a new pin is put in, its ends must be upset with light blows of a hammer.

EJECTOR.—Loosen the guard screws and relieve the close binding of the receiver in the stock; then remove the side plate screw, side plate, ejector pin, and ejector. After inserting the ejector and pin, replace the side plate and screw; then screw the guard screws firmly into place, care being taken not to injure their heads.

EXTRACTOR.—Place the sleeve on a wooden block with the extractor rivet over a hole in the block, drive the rivet out with a punch, smaller in diameter than the rivet; remove the old, and enter a new extractor to the proper distance in its slot in the sleeve; then insert the rivet in its hole, and drive it into place by light blows of a hammer.

EXTRACTOR PIN.—The small end is inserted from the right, and, when in place, is upset.

FOLLOWER PIN.—The small end must be inserted in the hole in the top of the follower, and when driven into place both ends should be upset and all projection of the pin carefully removed.

FRONT SIGHT.—As the left end of the sight pin is upset, this burr must be removed with a file, and the pin then driven out from the left side with a small drift. The new sight having been put in the slot, a new pin must be used; its small end is inserted from the right side, and, when in place, the left end should be upset with blows of a light hammer.

LOWER BAND SWIVEL SCREW.—This screw, when in place, has its end upset and riveted over the band ear. It should never work loose, if properly assembled, and when it has to be removed to replace an injured swivel, the burr on the end should be filed off and the screw taken out, the end being again upset when the screw has been returned to its place.

REAR SIGHT BASE.—When it may be necessary to remove the rear sight for repairs, it must be done by one thoroughly familiar with the use of the screw-driver, to prevent injury to the head or point of the base screws.

Before replacing the base, the barrel, bottom of the base, and screw holes in the barrel should be carefully cleaned; the screws should be started so as to enter freely the holes in the barrel, and they must be screwed in firmly against the base, but not with sufficient force to strip the threads or break the head.

STACKING SWIVEL SCREW.—This must be treated in exactly the same manner as the lower band swivel screw.

TRIGGER PIN.—The small end must be entered from the right side of trigger, and when in place, upset on left side.

INJURIES WHICH DO NOT RENDER PARTS UNSERVICEABLE.

BOLT.—The entire flange at the front end may be broken off, except a small portion on the opposite side from the guide rib which is required to support the head of the empty case and cause the case to be drawn to the rear sufficiently far to be acted upon by the ejector.

If automatic ejection be not considered, the entire flange may be dispensed with.

BUTT PLATE.—Bruises, cuts, or wearing.

BUTT SWIVEL.—Bent.

COCKING PIECE.—Moderate wearing of nose. The nose can wear until raising and lowering the bolt handle fails to cock the piece.

EXTRACTOR.—Moderate wear or break of edge of hook. Loss of spring.

GUARD.—Bent, bruised, or cut.

RECEIVER.—Guide lip lost, bent, or loose.

SIDE PLATE.—Edges broken, cut through thin part at shoulder near screw hole.

BAR AND RING OF CARBINE SWIVEL.—Bent.

USING THE ARM WHEN CERTAIN PARTS OF THE BOLT AND MAGAZINE MECHANISM ARE WANTING.

The parts not essential, or only so to a degree, are the ejector, the extractor spring, extractor pin, safety lock, cut-off, guide lip, gate, carrier, follower, side plate,

The empty cases drawn to the rear by the extractor can be removed from the receiver by the finger.

The safety lock being merely a precautionary device, its absence does not affect the usefulness of the firearm. The absence of the cut-off does not affect the use of the arm as a single loader, if the magazine be kept empty, or the feeding can be done entirely through the magazine, which only prevents the latter from being held full in reserve.

The want of one or more of the last four parts enumerated above only prevents the use of the magazine, but in no way affects the use of the arm as a single loader.

The soldier should be taught to appreciate these facts.

REMARKS.

1. Complaints have not infrequently been made that a main spring is too weak to perform its office, when the fault rests with the soldier, who in sighting inadvertently raised the bolt handle with his hand before pulling the trigger, and thus caused the force of the spring to be expended in closing the bolt, instead of in exploding the cartridge.

2. The cocking piece and gate lug, to prevent wear, must be **kept** slightly oiled.

3. In assembling the gate, observe that the magazine spring has its lip on top of the heel of the carrier, and not beneath it.

4. The side plate, when removed, must be returned firmly to its bearings, or the width of the cartridge way will be too great to cause the proper feeding of the cartridges.

5. When firing many successive rounds, note must be taken that unburned grains of powder do not collect and pack in the locking lug recess in the receiver, as this will interfere with the perfect closing of the bolt. Such accumulations can be blown out from time to time, or, when packed, removed by a knife or the screw-driver.

6. Except when repairs are needed, the following parts will constantly be injured if allowed to be dismantled by the soldier for cleaning; and when repairs are necessary, they should be removed only by a company artificer, or one familiar with the handling of tools and delicate mechanisms, viz: Cut-off, Extractor, Front Sight, Lower Band Swivel Screw, Rear Sight, Safety Lock.

The rear sight is accurately constructed and fitted carefully to the barrel, and the adjustment of its parts must be preserved to insure correct aiming. If the soldier be permitted to remove these parts, they will become worn and injured, and the closeness of their fit be destroyed.

7. Unless the screw-driver be handled carefully, and with some skill, the screws are sure to be injured either at the head or thread.

AMMUNITION FOR CALIBER .30 ARMS.

BALL CARTRIDGE.

The Caliber .30 Ball Cartridge, Fig. 121, consists of the *case*, A; *bullet*, B; *primer*, C; and *charge of smokeless powder*, D.

The case has the *flanged head*, E; the *primer seat*, F; the *hole*, G, through which the flame from the primer composition ignites the powder charge; the *body*, H, which is conical to facilitate the

Fig. 121.

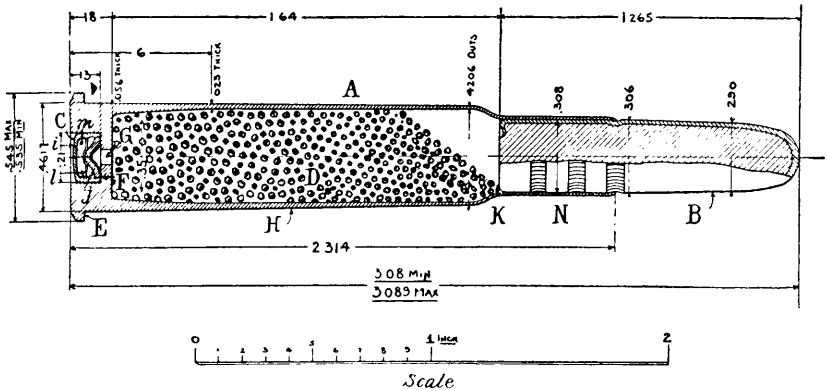

extraction of the empty case; the *shoulder*, K, and the *neck*, N, which is cylindrical: it is made of brass.

The initials of the Arsenal where the ammunition is made, the number of the month and of the year of its fabrication, are stamped on the head of each case.

The bullet is lubricated, and has a core of lead and tin composition, jacketed with cupro-nickel; it has three grooves, and the mouth of the case is crimped into the front groove to secure the bullet in place. The core is composed of 1 part of tin and 25 parts of lead by weight; this proportion is varied slightly in order to keep the weight of the finished bullet constantly at 220 grains.

The primer is composed of three parts, viz: The *cup*, *i*; the brass *anvil*, *j*; and the waterproofed paper *disc*, *l*. The cup is made of cartridge copper and contains the *composition*, *m*; this is covered and waterproofed by the disc, *l*. In plan, the anvil is a circle with two small semicircular portions removed from opposite sides; these two openings form vents for the passage of the flame from the composition to the powder.

The powder is of the nitroglycerine type; up to the present time three different American powders have been used, viz: Peyton, Du Pont, and Laflin & Rand W. A. The charge varies with the powder used from 35 to 42 grains.

The primer composition is known as H-48, and consists of—

Sulphur.....	8.63 per cent.
Antimony sulphide.....	25.12 per cent.
Potassium chlorate.....	49.61 per cent.
Glass crystals.....	16.64 per cent.

The weight of the cartridge complete varies from 435 to 442 grains, depending upon the weight of the powder charge. Twenty cartridges are packed in a pasteboard box, on the wrapper of which are printed the kind of cartridge, directions for opening and for treatment of the fired shells, the rifle velocity at 53 feet, date of loading, etc. The box and cartridges weigh about 21.5 ounces; 1,000 cartridges, packed in 50 pasteboard boxes and encased in wood with air-tight zinc lining, weigh 78 to 79 pounds.

The standard instrumental velocity, at 53 feet from the muzzle, of this ammunition in the rifle is 1,960 feet per second, with an allowed variation of but 15 feet per second on either side of the standard. This instrumental velocity at 53 feet corresponds to a muzzle velocity in the rifle of about 2,000 feet per second.

The velocity in the carbine is 80 feet per second less than in the rifle.

DUMMY CARTRIDGE.

This consists of a shell containing no powder, a primer with the anvil, but without disc or composition, and a service bullet without lubricant.

The shell is cannellured at the seat of the bullet, and has six longitudinal corrugations and a round hole drilled in front of the head.

BLANK CARTRIDGE.

The Blank Cartridge, Fig. 122, consists of the regular service case, A; hollow paper bullet, B; and primer, C, which is the same as that for the caliber .45 cartridge.

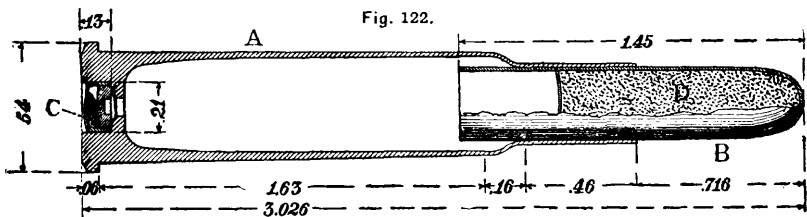

The case is loaded with 5 grains of E. C. smokeless blank fire powder to drive the paper bullet out of the bore, to ignite the

powder in the bullet, and to produce a sufficiently loud report in firing.

Five grains of the same smokeless powder, D, are compressed into the interior of the bullet to give the latter the necessary stiffness, and to insure its being broken into fragments when fired.

To prevent the paper bullet from being too susceptible to moisture, the bullet end of the cartridge, after loading, is coated with paraffine.

The blank cartridge weighs about 202 grains, between 34 and 35 weigning 1 pound. One paper box containing 20 blank cartridges weighs about 11 ounces. One wooden box containing 50 paper boxes or 1,000 blank cartridges, weighs 42 pounds.

GALLERY PRACTICE CARTRIDGE.

This cartridge, Fig. 123, consists of the regular service *case*, A; the *ball*, B; and the *primer*, C, the same as that for the caliber .45 ammunition.

The cartridge is loaded with 5 grains of black or smokeless powder. When smokeless powder is used, a cardboard wad is inserted in the

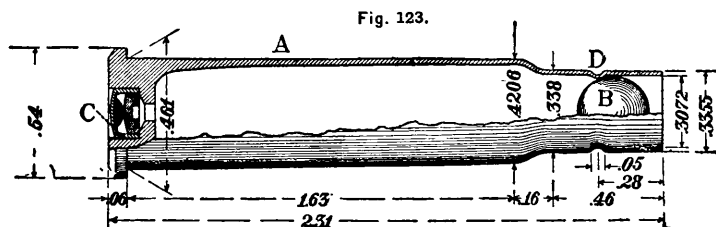

shell as far as the cannellure in the neck, and the ball placed on the wad, keeping the irregularity in surface of ball, due to gate of mould, up or down; and a nonfulminate H-48 primer is used.

The *cannellure*, D, forms a seat for the ball and prevents it from falling or being forced into the powder chamber of the case.

The ball is made of an alloy of 16 parts of lead to 1 of tin; it is lubricated with Japan wax and weighs 43 grains.

The gallery practice cartridge weighs about 232 grains, or about 30 to the pound. One paper box containing 20 cartridges weighs about 12 ounces. One wooden box, holding 50 paper boxes or 1,000 cartridges, weighs 45 pounds and 4 ounces.

The components of the gallery practice cartridge are usually issued to the service separately, to be assembled and reassembled with the aid of tools and appliances provided for the purpose. When specially ordered, assembled cartridges are prepared for issue, in which case the mouth of the shell is slightly curved inward to retain the ball in place in transportation and handling. This feature is not shown in Fig. 123.

MEMORANDA OF TRAJECTORIES.

RIFLE AND CARBINE.

1. RAPIDITY OF FIRE.

Forty-two aimed shots have been fired in two minutes with this arm, used as a single loader, and 43 shots in the same time, using magazine fire.

Firing from the hip without aim, 36 shots have been fired in one minute, using single loader fire, and 35 shots in one minute, using magazine fire.

2. MAXIMUM RANGE.

(COMPUTED.)

	Maximum range.	Elevation.	Time of flight.
	<i>Yards.</i>	<i>Degrees.</i>	<i>Seconds.</i>
Rifle.....	4, 066	44	34. 6
Carbine.....	4, 016	44	34. 3

3. PRESSURE.

The maximum powder pressure in the chamber of the Rifle and Carbine is about 38,000 pounds per square inch.

4. RECOIL.

(COMPUTED.)

The maximum energy of free recoil of the Rifle is 6.73 foot-pounds, and that of the Carbine 7.01 foot-pounds.

5. ACCURACY.

(DETERMINED BY EXPERIMENTAL FIRING.)

Radius of circle of shots.

Range.	Rifle.	Range.	Rifle.	Range.	Rifle.
<i>Yards.</i>	<i>Inches.</i>	<i>Yards.</i>	<i>Inches.</i>	<i>Yards.</i>	<i>Inches.</i>
100.....	1. 2	700.....	9. 3	1,300.....	21. 8
200.....	2. 1	800.....	11. 1	1,400.....	25. 0
300.....	3. 3	900.....	13. 0	1,500.....	28. 7
400.....	4. 7	1,000.....	14. 9	1,600.....	33. 0
500.....	6. 2	1,100.....	16. 8	1,700.....	38. 0
600.....	7. 7	1,200.....	19. 1	1,800.....	44. 0

6. DRIFT.

The drift proper of the rifle, it having a right-hand twist, should be to the right, but deductions from experimental firing in connection with two standard signal service anemometers and two wind vanes with graduated dials indicate that the bullet deviates to the left of the line of sight up to about 1,100 yards, when it crosses to the right of this line. One anemometer and one wind vane were placed at one-third and the other anemometer and wind vane at two-thirds the range from the target (as at 500 and 1,000 yards in a 1,500-yard range), and just off the line of fire.

Range.	Left.	Right.	Range.	Left.	Right.
<i>Yards.</i>	<i>Inches.</i>	<i>Inches.</i>	<i>Yards.</i>	<i>Inches.</i>	<i>Inches.</i>
100.....	2.5		1,100.....	0.3	
200.....	4.3		1,200.....		3.5
300.....	5.9		1,300.....		7.9
400.....	7.2		1,400.....		12.9
500.....	8.1		1,500.....		18.5
600.....	8.5		1,600.....		24.6
700.....	8.3		1,700.....		31.2
800.....	7.4		1,800.....		38.1
900.....	5.8		1,900.....		45.1
1,000.....	3.4		2,000.....		52.1

With the Carbine, the drift is always to the right.

7. DEVIATION OF THE BULLET PRODUCED BY A ONE-MILE WIND NORMAL TO THE PLANE OF FIRE.

(DETERMINED BY EXPERIMENTAL FIRING.)

Range.	Deviation.	Range.	Deviation.	Range.	Deviation.
	Rifle.		Rifle.		Rifle.
<i>Yards.</i>	<i>Inches.</i>	<i>Yards.</i>	<i>Inches.</i>	<i>Yards.</i>	<i>Inches.</i>
100.....	0.6	700.....	8.7	1,300.....	28.8
200.....	1.3	800.....	11.1	1,400.....	33.7
300.....	2.3	900.....	13.9	1,500.....	39.1
400.....	3.5	1,000.....	17.0	1,600.....	45.0
500.....	4.9	1,100.....	20.5	1,700.....	51.6
600.....	6.6	1,200.....	24.4	1,800.....	58.9

8. CORRECTIONS CORRESPONDING TO ONE POINT OF WINDAGE ON THE DEFLECTION SCALE.

The amount of deviation that may be corrected by one point of windage is approximately six inches for each one hundred yards for the model of 1902 sight.

8. ELEVATION.

Range.	Rifle.			Carbine.		
	Computed angle of departure.	Angle of elevation found by firing with service sight.		Computed angle of departure.		
<i>Yards.</i>	°	'	"	°	'	"
100.....	0	04	29
200.....	0	09	43
300.....	0	15	51	0	09	0
400.....	0	23	02	0	16	0
500.....	0	31	35	0	24	0
600.....	0	41	27	0	34	0
700.....	0	52	53	0	45	0
800.....	1	05	47	0	57	0
900.....	1	20	09	1	11	0
1,000.....	1	36	01	1	26	0
1,100.....	1	53	22	1	42	0
1,200.....	2	12	17	1	59	0
1,300.....	2	32	47	2	17	0
1,400.....	2	55	00	2	36	0
1,500.....	3	19	00	2	56	0
1,600.....	3	44	24	3	18	0
1,700.....	4	12	10	3	42	0
1,800.....	4	41	43	4	09	0
1,900.....	5	14	08
2,000.....	5	49	04

9. VELOCITY.

The muzzle velocity of the Rifle bullet is 2,000, and that of the Carbine 1,920 feet per second.

Remaining velocity. (Computed.)

Range.	Rifle.	Carbine.	Range.	Rifle.	Carbine.
	<i>Feet per second.</i>	<i>Feet per second.</i>		<i>Feet per second.</i>	<i>Feet per second.</i>
<i>Yards.</i>			<i>Yards.</i>		
100.....	1,783	1,712	1,100.....	792	778
200.....	1,590	1,527	1,200.....	755	743
300.....	1,418	1,361	1,300.....	721	709
400.....	1,265	1,217	1,400.....	688	676
500.....	1,138	1,100	1,500.....	657	646
600.....	1,044	1,018	1,600.....	628	618
700.....	978	958	1,700.....	600	591
800.....	923	905	1,800.....	575	565
900.....	874	859	1,900.....	550	541
1,000.....	831	816	2,000.....	527	519

10. FORCE OF IMPACT.

Remaining energy. (Computed.)

Range.	Rifle.	Carbine.	Range.	Rifle.	Carbine.
<i>Yards.</i>	<i>Foot-pounds.</i>	<i>Foot-pounds.</i>	<i>Yards.</i>	<i>Foot-pounds.</i>	<i>Foot-pounds.</i>
100.....	1, 553. 4	1, 432. 1	1, 100.....	306. 4	296. 1
200.....	1, 235. 3	1, 139. 5	1, 200.....	278. 5	269. 6
300.....	985. 2	905. 4	1, 300.....	253. 7	245. 4
400.....	781. 9	723. 5	1, 400.....	231. 4	223. 6
500.....	632. 8	591. 5	1, 500.....	210. 8	203. 8
600.....	532. 6	506. 6	1, 600.....	192. 9	186. 6
700.....	467. 4	448. 4	1, 700.....	175. 9	170. 6
800.....	416. 3	400. 4	1, 800.....	161. 6	156. 1
900.....	373. 3	360. 1	1, 900.....	147. 8	143. 1
1, 000.....	337. 4	325. 6	2, 000.....	135. 6	131. 4

11. PENETRATION IN WHITE PINE.

The penetration was found by firing into pine butts constructed so that the bullet passed through alternate sections of pine and air, each 1 inch thick.

	Penetration.		
	53 feet from the muzzle.	500 yards.	1,000 yards.
	<i>Inches.</i>	<i>Inches.</i>	<i>Inches.</i>
Rifle.....	45. 8	19. 85	11. 44
Carbine.....		17. 96	11. 02

Penetration with rifle in sand, loam, and steel.

Material.	Range.					
	50 feet.	100 feet.	100 yards.	200 yards.	500 yards.	1,000 yards.
Moist sand in pine box. Box made of $\frac{7}{8}$ -inch white pine.....	<i>Inches.</i> 15. 5				12. 8	17. 1
Dry sand in bags.....	15				6	7
Loam nearly free from sand, cast up in form of a parapet.....	16				13. 5	16. 5
Boiler-plate steel, 0.5 inch thick.....	0. 13					
Low steel plate, 0.375 inch thick.....	0. 26	0. 24				
Low steel plate, 0.287 inch thick.....		(²)	0. 10			
High steel plate (as rolled), 0.153 inch thick..	(²)		(²)	(²)		

¹ Penetration in sand at 50 feet is always less than at long ranges. Owing to high velocity of bullet at short range, the particles of sand struck do not have time to admit of motion among themselves before the bullets are completely destroyed.

² Through.

12. TIME OF FLIGHT.

(COMPUTED.)

Range.	Rifle.	Carbine.	Range.	Rifle.	Carbine.
Yards.	Seconds.	Seconds.	Yards.	Seconds.	Seconds.
100.....	.159	.165	1,100.....	2.957	3.041
200.....	.337	.351	1,200.....	3.349	3.436
300.....	.537	.560	1,300.....	3.758	3.853
400.....	.761	.793	1,400.....	4.186	4.289
500.....	1.012	1.053	1,500.....	4.634	4.747
600.....	1.288	1.337	1,600.....	5.102	5.221
700.....	1.585	1.641	1,700.....	5.603	5.724
800.....	1.901	1.963	1,800.....	6.112	6.251
900.....	2.235	2.303	1,900.....	6.626	6.807
1,000.....	2.587	2.662	2,000.....	7.231	7.388

13. ANGLE OF FALL.

(COMPUTED.)

Range.	Rifle.	Carbine.	Range.	Rifle.	Carbine.
Yards.	° ' "	° ' "	Yards.	° ' "	° ' "
100.....	0 04 50	0 05 15	1,100.....	3 18 55	3 27 46
200.....	0 11 19	0 12 17	1,200.....	3 55 38	4 05 33
300.....	0 19 55	0 21 38	1,300.....	4 36 21	4 47 35
400.....	0 31 12	0 33 55	1,400.....	5 21 28	5 34 09
500.....	0 45 55	0 49 37	1,500.....	6 11 29	6 25 33
600.....	1 04 01	1 08 41	1,600.....	7 05 38	7 21 34
700.....	1 25 10	1 30 33	1,700.....	8 06 10	8 24 24
800.....	1 49 04	1 55 12	1,800.....	9 13 05	9 33 43
900.....	2 15 46	2 22 48	1,900.....	10 27 20	10 50 31
1,000.....	2 45 38	2 53 39	2,000.....	11 49 38	12 14 47

14. ORDINATES OF TRAJECTORY ABOVE LINE OF SIGHT.

(COMPUTED.)

The ordinates of the 500 and 1,000 yard trajectories were found experimentally and were practically identical with those computed.

Rifle.

Horizontal distance.	100 yards.	200 yards.	300 yards.	400 yards.	500 yards.	600 yards.	700 yards.	800 yards.	900 yards.	1,000 yards.
<i>Yards.</i>	<i>Feet.</i>	<i>Feet.</i>	<i>Feet.</i>	<i>Feet.</i>	<i>Feet.</i>	<i>Feet.</i>	<i>Feet.</i>	<i>Feet.</i>	<i>Feet.</i>	<i>Feet.</i>
100.....	0									
200.....	0.46	0								
300.....	0.99	1.07	0							
400.....	1.62	2.32	1.88	0						
500.....	2.36	3.82	4.12	2.98	0					
600.....	3.23	5.54	6.70	6.43	4.31	0				
700.....	4.22	7.53	9.69	10.42	9.30	5.99	0			
800.....	5.35	9.79	13.07	14.92	14.92	12.74	7.88	0		
900.....	6.60	12.29	16.83	19.94	21.19	20.26	16.65	10.03	0	
1,000.....	7.99	15.06	20.99	25.48	28.12	28.57	26.34	21.10	12.46	0
1,100.....	9.51	18.10	25.54	31.54	35.69	37.66	36.94	33.21	26.08	15.14
1,200.....	11.16	21.40	30.49	38.15	43.95	47.56	48.50	46.41	40.93	31.62
1,300.....	12.95	24.98	35.87	45.31	52.90	58.31	61.03	60.73	57.03	49.51
1,400.....	14.89	28.87	41.69	53.08	62.61	69.95	74.61	76.25	74.48	68.89
1,500.....	16.98	33.05	47.96	61.43	73.05	82.47	89.21	92.92	93.23	89.71
1,600.....	19.27	37.62	54.82	70.57	84.47	96.17	105.19	111.18	113.76	112.51
1,700.....	21.73	42.54	62.20	80.42	96.77	110.93	122.40	130.84	135.86	137.05
1,800.....	24.37	47.82	70.11	90.96	109.95	126.74	140.83	151.89	159.52	163.32
1,900.....	27.23	53.55	78.70	102.41	124.25	143.89	160.83	174.73	185.20	191.83
2,000.....	30.17	59.42	87.51	114.16	138.95	161.54	181.45	198.30	211.75	221.33

14. ORDINATES OF TRAJECTORY ABOVE LINE OF SIGHT—Continued.

Rifle—Continued.

Horizontal distance.	1,100 yards.	1,200 yards.	1,300 yards.	1,400 yards.	1,500 yards.	1,600 yards.	1,700 yards.	1,800 yards.	1,900 yards.	2,000 yards.
<i>Yards.</i>	<i>Feet.</i>	<i>Feet.</i>	<i>Feet.</i>	<i>Feet.</i>	<i>Feet.</i>	<i>Feet.</i>	<i>Feet.</i>	<i>Feet.</i>	<i>Feet.</i>	<i>Feet.</i>
100.....										
200.....										
300.....										
400.....										
500.....										
600.....										
700.....										
800.....										
900.....										
1,000.....										
1,100.....	0									
1,200.....	18. 13	0								
1,300.....	37. 79	21. 45	0							
1,400.....	59. 10	44. 68	25. 15	0						
1,500.....	82. 12	69. 52	52. 05	29. 45	0					
1,600.....	107. 06	96. 96	81. 75	60. 90	33. 83	0				
1,700.....	134. 03	126. 37	113. 58	95. 16	70. 55	39. 07	0			
1,800.....	162. 91	157. 85	147. 65	131. 81	109. 78	80. 86	44. 34	0		
1,900.....	194. 24	191. 99	184. 60	171. 57	152. 32	126. 18	92. 43	50. 84	0	
2,000.....	226. 80	227. 58	223. 22	212. 77	197. 11	172. 54	143. 76	105. 16	57. 51	0

4. ORDINATES OF TRAJECTORY ABOVE LINE OF SIGHT—Continued.
(COMPUTED.)

The ordinates of the 500 and 1,000 yard trajectories were found experimentally and were practically identical with those computed.

Carbine.

Horizontal distance.	100 yards.	200 yards.	300 yards.	400 yards.	500 yards.	600 yards.	700 yards.	800 yards.	900 yards.	1,000 yards.
<i>Yards.</i>	<i>Feet.</i>	<i>Feet.</i>	<i>Feet.</i>	<i>Feet.</i>	<i>Feet.</i>	<i>Feet.</i>	<i>Feet.</i>	<i>Feet.</i>	<i>Feet.</i>	<i>Feet.</i>
100	0									
200	0. 50	0								
300	1. 08	1. 16	0							
400	1. 76	2. 53	2. 05	0						
500	2. 56	4. 13	4. 46	3. 21	0					
600	3. 50	6. 00	7. 25	6. 94	4. 66	0				
700	4. 56	8. 13	10. 45	11. 20	9. 98	6. 39	0			
800	5. 75	10. 51	14. 02	15. 97	15. 94	13. 54	8. 34	0		
900	7. 08	13. 16	18. 00	21. 27	22. 57	21. 49	17. 62	10. 60	0	
1,000	8. 53	16. 06	22. 35	27. 07	29. 82	30. 19	27. 76	22. 19	13. 03	0
1,100	10. 11	19. 23	27. 09	33. 40	37. 72	39. 67	38. 82	34. 83	27. 25	15. 79
1,200	11. 84	22. 68	32. 27	40. 29	46. 34	50. 01	50. 88	48. 60	42. 74	32. 99
1,300	13. 70	26. 41	37. 87	47. 76	55. 67	61. 20	63. 93	63. 52	59. 51	51. 62
1,400	15. 72	30. 45	43. 93	55. 84	65. 77	73. 32	78. 06	79. 66	77. 66	71. 78
1,500	17. 91	34. 82	50. 48	64. 57	76. 69	86. 41	93. 33	97. 11	97. 28	93. 57
1,600	20. 21	39. 42	57. 38	73. 76	88. 15	100. 15	109. 33	115. 35	117. 76	116. 27
1,700	22. 74	44. 48	64. 96	83. 87	100. 78	115. 29	126. 98	135. 51	140. 41	141. 41
1,800	25. 46	49. 92	73. 12	94. 73	114. 35	131. 56	145. 95	157. 16	164. 75	168. 42
1,900	28. 42	55. 83	81. 98	106. 53	129. 09	149. 24	166. 55	180. 69	191. 19	197. 75
2,000	31. 58	62. 16	91. 46	119. 18	144. 89	168. 18	188. 63	205. 89	219. 49	229. 18

14. ORDINATES OF TRAJECTORY ABOVE LINE OF SIGHT—Continued.

Carbine—Continued.

Horizontal distance.	1,100 yards.	1,200 yards.	1,300 yards.	1,400 yards.	1,500 yards.	1,600 yards.	1,700 yards.	1,800 yards.	1,900 yards.	2,000 yards.
<i>Yards.</i>	<i>Feet.</i>	<i>Feet.</i>	<i>Feet.</i>	<i>Feet.</i>	<i>Feet.</i>	<i>Feet.</i>	<i>Feet.</i>	<i>Feet.</i>	<i>Feet.</i>	<i>Feet.</i>
100.....										
200.....										
300.....										
400.....										
500.....										
600.....										
700.....										
800.....										
900.....										
1,000.....										
1,100.....	0									
1,200.....	18.92	0								
1,300.....	39.40	22.34	0							
1,400.....	61.56	46.50	26.16	0						
1,500.....	85.47	72.65	54.38	30.42	0					
1,600.....	110.42	99.70	83.68	61.81	33.52	0				
1,700.....	138.04	129.79	116.23	96.81	70.95	39.86	0			
1,800.....	167.71	162.12	151.20	134.41	111.16	82.67	45.39	0		
1,900.....	199.94	197.22	189.17	175.23	154.82	129.15	94.67	52.05	0	
2,000.....	234.44	234.81	229.82	218.93	201.52	178.87	147.37	107.72	58.60	0

15. DANGEROUS SPACES.

The dangerous spaces were calculated under the assumption that the gun, when fired, is 56 inches above the ground, that the height of a man is 68 inches, that the head of a man on horseback is 8 feet above the ground, and that the gun is aimed at the middle point of the target.

Rifle against infantry and cavalry.

Distance on line of sight.	Rising branch of trajectory.		Falling branch of trajectory.				Maximum continuous dangerous space.		Total.	
			In front.		In rear.					
	Infantry.	Cavalry.	Infantry.	Cavalry.	Infantry.	Cavalry.	Infantry.	Cavalry.	Infantry.	Cavalry.
<i>Yards.</i>	<i>Yards.</i>	<i>Yards.</i>	<i>Yards.</i>	<i>Yards.</i>	<i>Yards.</i>	<i>Yards.</i>	<i>Yards.</i>	<i>Yards.</i>	<i>Yards.</i>	<i>Yards.</i>
100.....	All.	All.	All.	All.	102.49	190.15	202.49	290.15	202.49	290.15
200.....	All.	All.	All.	All.	109.78	166.27	309.78	366.27	309.78	366.27
300.....	All.	All.	All.	All.	92.45	132.45	392.45	432.45	392.45	432.45
400.....	80.39	All.	137.85	All.	72.74	102.50	210.59	502.50	290.98	502.50
500.....	44.85	176.63	79.95	154.41	56.76	79.24	136.71	233.65	181.56	410.28
600.....	31.31	108.24	54.70	87.17	43.60	61.11	98.30	148.28	129.61	256.52
700.....	23.43	79.07	39.99	60.24	34.38	48.31	74.37	108.55	97.80	187.62
800.....	18.15	61.45	30.88	45.31	27.50	38.83	58.38	84.14	76.53	145.59
900.....	14.73	49.50	24.59	35.69	22.54	31.74	47.13	67.43	61.86	116.93
1,000.....	12.20	40.85	19.92	28.72	18.76	26.49	38.68	55.21	50.88	96.06
1,100.....	10.28	34.34	16.58	23.75	15.77	22.22	32.35	45.97	42.63	80.31
1,200.....	8.78	29.28	13.84	19.79	13.49	18.99	27.33	38.78	36.11	68.06
1,300.....	7.58	25.26	11.84	16.83	11.47	16.25	23.31	33.08	30.89	58.34
1,400.....	6.60	22.00	10.11	14.43	9.94	13.97	20.05	28.40	26.65	50.40
1,500.....	5.80	19.30	8.77	12.50	8.41	12.07	17.18	24.57	22.98	43.87
1,600.....	5.13	17.09	7.67	10.88	7.38	10.58	15.05	21.46	20.18	38.55
1,700.....	4.56	15.20	6.71	9.51	6.50	9.30	13.21	18.81	17.77	34.01
1,800.....	4.08	13.59	5.90	8.34	5.75	8.19	11.65	16.53	15.73	30.12
1,900.....	3.65	12.17	5.19	7.34	5.11	7.23	10:30	14.57	13.95	26.74
2,000.....	3.28	10.94	4.58	6.47	4.56	6.39	9.14	12.86	12.42	23.80

15. DANGEROUS SPACES—Continued.

The dangerous spaces were calculated under the assumption that the gun, when fired, is 56 inches above the ground, that the height of a man is 68 inches, that the head of a man on horseback is 8 feet above the ground, and that the gun is aimed at the middle point of the target.

Carbine against infantry and cavalry.

Distance on line of sight.	Rising branch of trajectory.		Falling branch of trajectory.				Maximum continuous dangerous space.		Total.	
			In front.		In rear.					
	Infantry.	Cavalry.	Infantry.	Cavalry.	Infantry.	Cavalry.	Infantry.	Cavalry.	Infantry.	Cavalry.
<i>Yards.</i>	<i>Yards.</i>	<i>Yards.</i>	<i>Yards.</i>	<i>Yards.</i>	<i>Yards.</i>	<i>Yards.</i>	<i>Yards.</i>	<i>Yards.</i>	<i>Yards.</i>	<i>Yards.</i>
100.....	All.	All.	All.	All.	100.25	183.63	200.25	283.63	200.25	283.63
200.....	All.	All.	All.	All.	105.11	158.79	305.11	358.79	305.11	358.79
300.....	All.	All.	All.	All.	87.83	125.53	387.83	425.53	387.83	425.53
400.....	69.62	All.	121.72	All.	68.79	96.80	190.51	496.80	260.13	496.80
500.....	40.74	153.27	73.18	133.24	53.06	74.39	126.24	207.63	166.98	360.90
600.....	28.95	98.26	50.23	79.07	41.43	57.98	91.66	137.05	120.61	235.31
700.....	21.57	72.69	37.09	55.82	32.83	46.00	69.92	101.82	91.49	174.51
800.....	17.01	56.87	28.80	42.33	26.51	37.22	55.31	79.55	72.32	136.42
900.....	13.81	46.03	22.76	33.22	22.05	30.80	44.81	64.02	58.62	110.05
1,000.....	11.47	38.17	18.76	27.12	18.23	25.54	36.99	52.66	48.46	90.83
1,100.....	9.68	32.22	15.69	22.60	15.28	21.39	30.97	43.99	40.65	76.21
1,200.....	8.28	27.56	13.25	18.96	12.94	18.22	26.19	37.18	34.47	64.74
1,300.....	7.17	23.84	11.32	16.13	11.09	15.63	22.41	31.76	29.58	55.60
1,400.....	6.26	20.82	9.75	13.89	9.54	13.42	19.29	27.31	25.55	48.13
1,500.....	5.50	18.30	8.46	12.01	8.27	11.63	16.73	23.64	22.23	41.94
1,600.....	4.87	16.24	7.37	10.46	7.21	10.16	14.58	20.62	19.45	36.86
1,700.....	4.34	14.46	6.44	9.13	6.31	8.90	12.75	18.03	17.09	32.49
1,800.....	3.88	12.93	5.64	7.99	5.55	7.83	11.19	15.82	15.07	28.75
1,900.....	3.48	11.60	4.95	7.02	4.90	6.90	9.85	13.92	13.33	25.52
2,000.....	3.13	10.44	4.35	6.18	4.34	6.10	8.69	12.28	11.82	22.72

PRINCIPAL DIMENSIONS AND WEIGHTS OF THE RIFLE AND CARBINE.

Dimensions.	Rifle.	Carbine.
Barrel:	<i>Inches.</i>	<i>Inches.</i>
Diameter of bore.....	0.30	0.30
Exterior diameter at muzzle.....	0.62	0.65
Exterior diameter at breech.....	0.98	0.98
Length of bore.....	30.00	22.00
Length of travel of bullet in bore.....	28.239	20.239
Diameter of chamber, rear end.....	0.462	0.462
Diameter of chamber, front end.....	0.419	0.419
Diameter of neck of chamber, rear end.....	0.338	0.338
Diameter of neck of chamber, front end.....	0.334	0.334
Length of body of chamber.....	1.62	1.62
Length of shoulder of chamber.....	0.164	0.164
Length of neck of chamber.....	0.486	0.486
Length of chamber, including throat.....	2.33	2.33
Rifling:		
Number of grooves.....	4	4
Twist, uniform, one turn in.....	10.00	10.00
Width of grooves.....	0.166	0.166
Width of lands.....	0.0589	0.0589
Depth of grooves.....	0.004	0.004
Height of front sight above axis of bore.....	0.85	0.83
Distance from top of front sight to sighting notch, leaf turned down.....	22.295	14.295
Distance from top of front sight to sighting notch, leaf vertical.....	24.655	16.655
Bayonet, length of blade.....	11.73	
Stock:		
Length with butt plate.....	46.05	30.65
Crook, <i>i. e.</i> , distance from axis of bore to heel of butt.....	1.85	1.85
Distance from trigger to butt plate.....	13.37	13.37
Arm complete:		
Length, without bayonet.....	48.9	40.9
Length, with bayonet fixed.....	60.7	
Weights.		
	<i>Pounds.</i>	<i>Pounds.</i>
Barrel.....	3.117	2.528
Bayonet.....	0.997	
Butt plate.....	0.277	0.277
Receiver.....	1.397	1.397
Bolt mechanism.....	0.920	0.920
Magazine mechanism.....	0.393	0.393
Stock.....	1.840	1.400
Hand guard.....	0.078	0.054
Rear sight, with screws.....	0.200	0.199
Cleaning rod.....	0.217	0.144
Total weight of metal parts, including oiler.....	7.233	6.585
Total weight of arm, without bayonet.....	9.187	8.075
Total weight of arm, with bayonet.....	10.174	
Weight to compress main spring.....	18 to 22	18 to 22
Trigger pull-off.....	3 to 6½	3 to 6½
Bayonet scabbard.....	0.47	
Cartridge belt, woven.....	1.11	1.11
Cartridge belt, woven, filled with 100 cartridges.....	7.437	7.437

¹ Changed in July, 1898, to 16 to 18 pounds.

WAR DEPARTMENT,
OFFICE OF THE CHIEF OF ORDNANCE,
Washington, D. C., August 2, 1917.

Revised August 2, 1917.

FORM No. 1920.

Ed. August 2-17-5,000.



500, 1000, 1500 and 2000 yard Trajectories of the U. S. Magazine Rifle, Cal. .30.

Horizontal Scale, 1"=100 yards.

Vertical Scale, 1"=50 feet.

Showing dangerous spaces against Infantry.

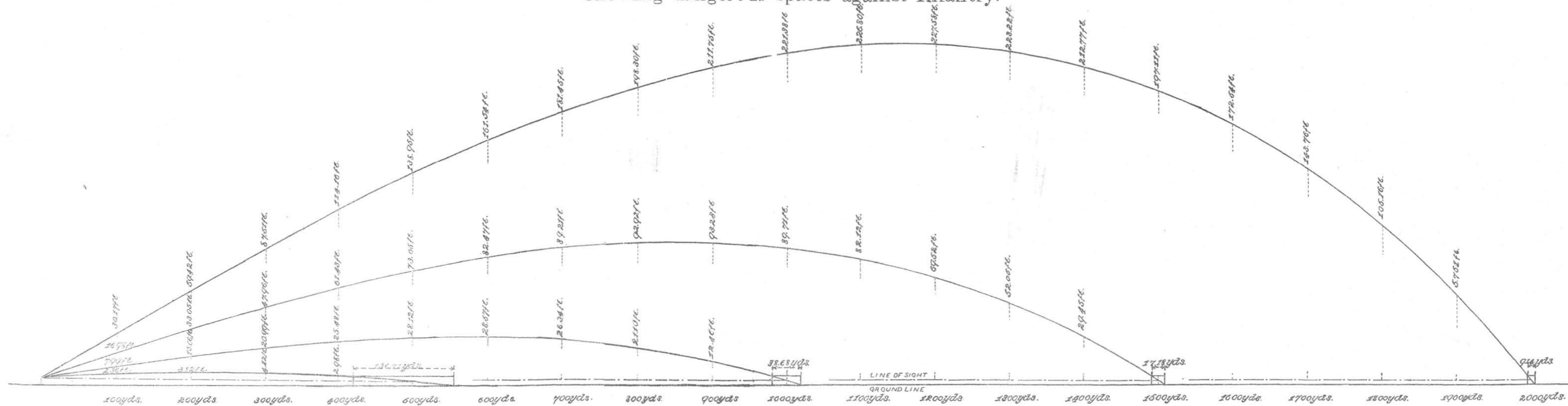

Showing dangerous spaces against Cavalry.

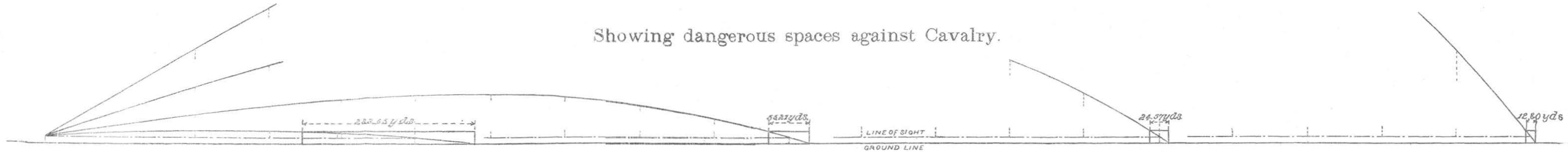

500, 1000, 1500 and 2000 yard Trajectories of the U. S. Magazine Carbine, Cal. .30.

Horizontal Scale, 1" = 100 yards.

Vertical Scale, 1" = 50 feet.

Showing dangerous spaces against Infantry.

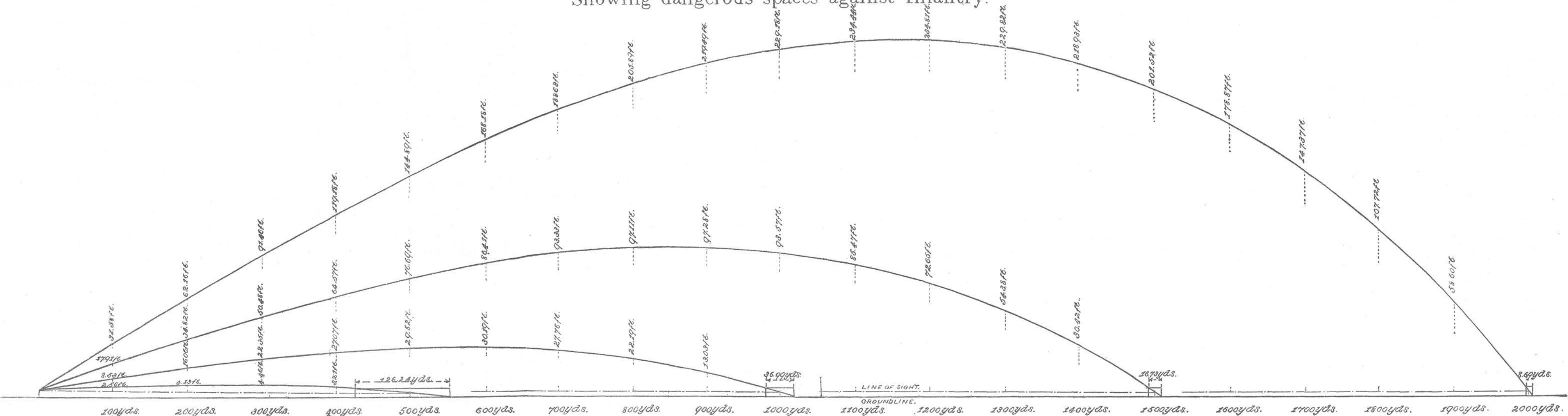

Showing dangerous spaces against Cavalry.

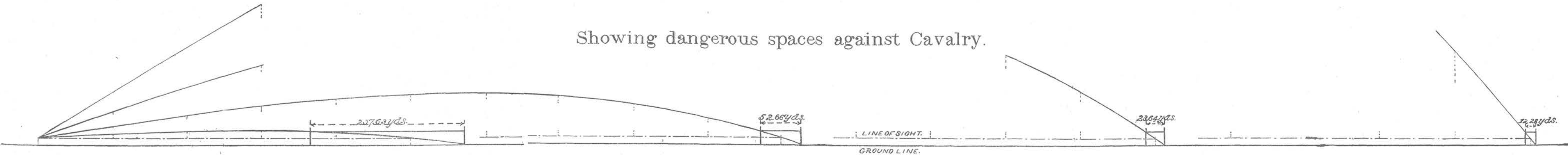

500 yard Trajectories of U. S. Magazine Rifle and Carbine, Calibre .30.

LINE OF SIGHT

Horizontal and vertical scales: 1 inch=25 yards.

500 yard Trajectory of Rifle, showing dangerous space against Infantry.

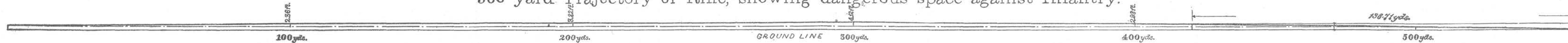

500 yard Trajectory of Rifle, showing dangerous space against Cavalry

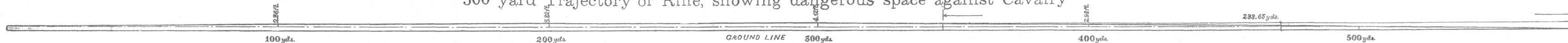

500 yard Trajectory of Carbine, showing dangerous space against Infantry.

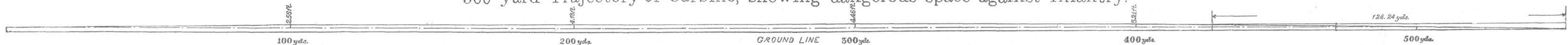

500 yard Trajectory of Carbine, showing dangerous space against Cavalry.

