

This manual supersedes chapter 3, chapter 4, section IV of chapter 8, chapter 11, and appendix of FM 5-30, 30 June 1943; TM 5-325, 19 April 1943, including Changes No. 1, 30 July 1943; and appendix of Training Circular No. 62, War Department, 1943.

LAND MINES AND BOOBY TRAPS



WAR DEPARTMENT • 1 NOVEMBER 1943

RESTRICTED DISSEMINATION OF RESTRICTED MATTER The information contained in restricted documents and the essential characteristics of restricted material may be given to any person known to be in the service of the United States and to persons of undoubted loyalty and discretion who are cooperating in Government work, but will not be communicated to the public or to the press except by authorized military public relations agencies. (See also par. 18*b*, AR 380-5, 28 Sep 1942.)

WAR DEPARTMENT,
WASHINGTON 25, D. C., 1 November 1943.

FM 5-31, Engineer Field Manual, Land Mines and Booby Traps, is published for the information and guidance of all concerned.

[A. G. 300.7 (26 Aug 43).]

BY ORDER OF THE SECRETARY OF WAR:

G. C. MARSHALL,
Chief of Staff.

OFFICIAL:

J. A. ULIO,
*Major General,
The Adjutant General.*

DISTRIBUTION:

R & H (6); Bn 1, 2, 4-6, 8, 10-19, 44, 55 (2), 3, 7, 9 (4); C1,
3, 4, 6, 8, 10-16, 19, 44, 55 (2), 2, 5, 7, 9, 17, 18 (4).

(For explanation of symbols see FM 21-6.)

FOREWORD

This manual contains in loose-leaf form the latest information on characteristics of mines and fuzes and on the tactics and techniques of their use. Monthly supplements will keep the manual up to date. Like the manual, the supplements will be *loose-leaf, decimal-indexed, and dated*, so that obsolete pages can be removed easily and the new pages inserted in their proper places. The manual is organized as follows:

a. Chapters 1 to 4 inclusive, deal with United States mine tactics, technique, and doctrine. The pages in these chapters are numbered as follows:

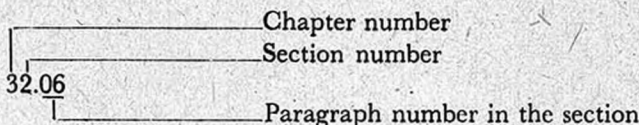

The number shown in the example is paragraph 6, section II, chapter 3. The illustrations in chapters 1 to 4, inclusive, are numbered in the same way. For example, figure 41.02b is the second illustration in paragraph 2 of section I of chapter 4.

b. Chapters 5 to 13, inclusive, discuss mine tactics, individual mines, fuzes, and booby traps of allied and enemy nations. Pages are numbered as follows:

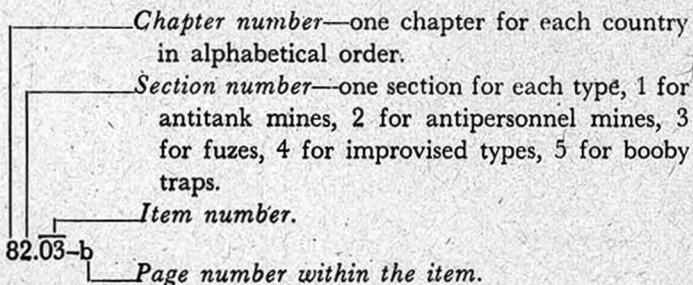

The example shown would be on page 2 of the discussion of the third in the series of German antipersonnel mines.

c. The illustrations in chapters 5 to 13, inclusive, are not numbered.

CONTENTS

Paragraphs

CHAPTER 1. GENERAL	11.01-11.05
CHAPTER 2. AMERICAN MINE POLICY	21.01-21.10
CHAPTER 3. AMERICAN MINE-FIELD LAYING	
<i>Section</i> I. Hasty mine field	31.01-31.06
II. Deliberate mine field	32.01-32.12
III. Antitank mine supply	33.01-33.05
IV. Dummy mine fields	34.01
CHAPTER 4. MINE-FIELD BREACHING AND CLEARANCE	
<i>Section</i> I. General	41.01-41.03
II. Mine-field reconnaissance	42.01-42.04
III. Mine-field breaching and marking	43.01-43.15
IV. Road and track clearance	44.01-44.15
V. Deliberate clearing of mine field	45.01-45.07
CHAPTER 5. AMERICAN MINES AND FUZES	
<i>Section</i> I. Antitank mines	51
II. Antipersonnel mines	52
III. Fuzes	53
IV. Improvised types	54
V. Booby traps	55
CHAPTER 6. BRITISH MINE TACTICS, MINES, AND FUZES	
<i>Section</i> I. Mine tactics	60
II. Antitank mines	61
III. Antipersonnel mines	62
IV. Fuzes	63
V. Improvised types	64
VI. Booby traps	65

CHAPTER 7. FRENCH MINE TACTICS, MINES, AND FUZES

<i>Section</i>	I. Mine tactics	70
	II. Antitank mines	71
	III. Antipersonnel mines	72
	IV. Fuzes	73
	V. Improvised types	74
	VI. Booby traps	75

CHAPTER 8. GERMAN MINE TACTICS, MINES, AND FUZES

<i>Section</i>	I. Mine tactics	80
	II. Antitank mines	81
	III. Antipersonnel mines	82
	IV. Fuzes	83
	V. Improvised types	84
	VI. Booby traps	85

CHAPTER 9. HUNGARIAN MINE TACTICS, MINES, AND BOOBY TRAPS

<i>Section</i>	I. Mine tactics	90
	II. Antitank mines	91
	III. Antipersonnel mines	92
	IV. Fuzes	93
	V. Improvised types	94
	VI. Booby traps	95

CHAPTER 10. ITALIAN MINE POLICY, MINES, AND FUZES

<i>Section</i>	I. Mine policy	100
	II. Antitank mines	101
	III. Antipersonnel mines	102
	IV. Fuzes	103
	V. Improvised types	104
	VI. Booby traps	105

CHAPTER 11. JAPANESE MINE POLICY, MINES, AND FUZES

<i>Section</i>	I. Mine policy	110
	II. Antitank mines	111
	III. Antipersonnel mines	112
	IV. Fuzes	113
	V. Improvised types	114
	VI. Booby traps	115

CHAPTER 12. RUSSIAN MINE TACTICS, MINES, AND FUZES

<i>Section</i> I.	Mine policy	120
II.	Antitank mines	121
III.	Antipersonnel mines	122
IV.	Fuzes	123
V.	Improvised types	124
VI.	Booby traps	125

CHAPTER 13. MISCELLANEOUS MINES AND FUZES

<i>Section</i> I.	Antitank mines	131
II.	Antipersonnel mines	132
III.	Fuzes	133
IV.	Improvised types	134
V.	Booby traps	135

APPENDIX I. ELECTRICAL MINE DETECTORS

APPENDIX II. NOTES ON HOUSE BOOBY TRAPS FOR ARMS OTHER THAN ENGINEERS

APPENDIX III. MINE WARFARE TRAINING

CHAPTER 1

GENERAL

SECTION I

11.01. SCOPE This manual covers the employment, types, and characteristics of land mines and booby traps of various nations. It includes methods to locate, disarm, defuze, and remove these obstacles.

11.02. LAND MINES

a. A land mine is an encased charge of explosive fitted with detonating device or devices designed to be actuated by vehicles or personnel.

b. There are two common types

(1) Antitank mines designed to immobilize track or wheeled vehicles, and normally employed in mine fields. Antitank mines vary greatly in the amount of explosive they contain. The normal charge is 6 to 12 pounds. Usually they are not dangerous to personnel passing over them, since heavy pressure is necessary to detonate them. The impact of a running man may set off an antitank mine.

(2) Antipersonnel mines are used primarily to produce casualties to personnel on foot. They may be placed for specific tactical purposes, such as the protection of mine fields or other obstacles, or to give local security; or they may be placed as nuisance mines to harass and delay. They are not effective against armored vehicles. Explosive charges usually vary from $\frac{1}{4}$ to 4 pounds.

c. Improvised land mines frequently are used when issue mines are either unsuitable or unavailable for a particular antitank or anti-personnel mission. They may contain any of the standard explosives, and may be set off by either standard or improvised fuzes. Improvised mines are particularly dangerous to remove, and time-consuming to install.

d. Types infrequently used for railway and bridge mining are large and complex special mines, containing a heavy charge. Their use is restricted by transportation and supply problems, and the time necessary for their installation.

e. Frequently dummy mines are used in place of real mines. They may consist of any scrap material available. They are laid in false mine fields, and may be used to supplement the real mines in a real mine field. Their main purpose is to delay the enemy by causing him to use time to investigate and remove them.

f. Practice mines are used for training purposes. They contain no explosive charge, but are similar in construction to real mines. They may be equipped to produce a puff of smoke when run over by a vehicle.

11.03. MINE FIRING DEVICES

a. **Fuze** The term "fuze" as used in this manual covers igniters, switches, and firing devices, and applies to the device which produces the flame or concussion to set off the charge. Fuzes operate by applying or releasing of pressure, by pull on a trip mechanism, by the release of a tension wire, or by a delay-action mechanism. Definitions of fuze types are—

(1) **PERCUSSION FUZE** A percussion fuze is one in which the percussion cap is set off by a blow from a spring or pressure-actuated striker.

(2) **FRICITION FUZE** A friction fuze is one composed of substances which are set aflame by applied friction.

(3) **CHEMICAL FUZE** A chemical fuze is one which utilizes the chemical reaction between selected substances to produce a high-intensity flame or a closed circuit.

(4) **TIME FUZE AND DELAY-ACTION FUZE** The time fuze and delay-action fuze are mechanically or chemically controlled detonating devices which function at a specified time interval after actuation. The controlling timing element in the fuze differentiates it from other fuzes.

b. **Trip cord or wire** A trip cord or wire is a low cord or wire attached to the main or secondary fuze of a mine or other explosive charge for the purpose of actuating the fuze.

c. **Sympathetic detonation** Sympathetic detonation is detonation induced by an explosion of another charge nearby.

11.04. MINE EMPLOYMENT AND MINE-FIELD TERMINOLOGY

a. **Fuzing a mine** Fuzing a mine is the process of inserting the detonator and fuze assemblies. The mine is safe to handle but not to transport or store.

b. **Defuzing a mine** Defuzing is the reverse of fuzing. The

mine, detonator, and fuze assemblies must be so packed that mines are safe for transport and storage.

c. Arming a mine Arming a mine is removing all safety devices so the mine is ready to function.

d. Disarming a mine Disarming a mine is replacing pins, clips, or other safety devices so the mine cannot be exploded accidentally by vehicles or personnel. A disarmed mine is not necessarily safe for transport and storage.

e. Mine belt A mine belt is a strip of ground which contains mines laid to a standard pattern.

f. Mine section A mine section is one of the areas into which a mine belt is divided to facilitate laying and recording mines, and to allow for changes in direction.

g. Mine density Mine density is the number of mines per yard of front. The normal mine density of mine belts is $1\frac{1}{2}$ mines per yard of front.

h. Mine-belt pattern Mine-belt pattern is the arrangement of mines in a mine belt. The arrangement may include antitank, antipersonnel, and booby-trapped antitank mines.

(1) **UNIFORM-PATTERN BELT** Uniform-pattern belts employ uniform spacing of mines throughout the field.

(2) **EXTENDED-PATTERN BELT** The mines are laid in considerable depth, and the rows of mines nearest the enemy are spaced more widely. Extended-pattern belts are those normally employed.

(3) **HASTY-MINE BELT** A hasty mine belt is one in which the mines are laid in a shallow regular pattern and are located by pacing.

(4) **DELIBERATE MINE BELT** This is one in which the mines are laid in greater depth than in a hasty mine belt and are located by accurate measurements. Either the uniform or extended pattern belts may be used.

i. Mine field A mine field includes the entire extent of a mined area. It may have one or more belts, and may contain scattered mines located between and in front of mine belts.

(1) **HASTY MINE FIELD** This consists of one or more hasty mine belts.

(2) **DELIBERATE MINE FIELD** This consists of one or more deliberate mine belts.

(3) **PROTECTIVE MINE FIELD** A protective mine field is one which provides local security for a defense area.

(4) **TACTICAL MINE FIELD** A tactical mine field is one placed to break up and canalize the enemy's attack formations and to hold him in areas covered by intense defensive fires, particularly those of antitank and automatic weapons.

(5) **NUISANCE MINE FIELD** A nuisance mine field is one placed to delay enemy approach to a position. Usually such fields are sited along roadsides, and in turn-offs, favorable assembly areas, and bivouac locations. Normally they employ a high percentage of antipersonnel mines.

(6) **DUMMY MINE FIELD** A dummy mine field is an area having the appearance of a real mine field.

j. Suspect area A suspect area is one thought to contain mines.

k. Mine road block A mine road block is used to cover a narrow front where a deep pattern cannot be employed. Its normal density is three mines per yard of front.

l. Clearing Clearing a mine field is removing all mines from it.

m. Mine-field lane A mine-field lane is a passage cleared of mines and marked so vehicles and personnel may travel safely through the mine field.

n. Breaching Breaching a mine field is clearing one or more lanes through it.

o. Booby-trapped mine A booby-trapped mine is one having a device which will cause detonation when the mine is moved. The device may be attached either to the mine itself or to a second mine or auxiliary charge laid underneath.

11.05. BOOBY TRAPS

a. A booby trap is a device so arranged in connection with an explosive charge that any disturbance of the device detonates the charge.

b. They are used against personnel. Their principal mission is to delay, demoralize, and cause casualties. Booby traps may be installed in conjunction with raids on positions, along routes of enemy advance, or with antitank mines to prevent their removal.

c. They may be encountered under any circumstances, but usually are found in mine fields, in abandoned buildings and vehicles, or attached to articles of equipment. Ingenuity of installation largely determines their effectiveness. Occasionally a second trap is placed near the first one to prevent its removal.

d. Booby traps are operated by any of the following methods:

- (1) Direct pressure on a concealed mechanism.
- (2) Lifting some apparently harmless object off a concealed mechanism.
- (3) Moving some concealed object, such as a thin trip wire, connected to a concealed mechanism.

e. Troops must be trained to detect and disarm booby traps. As booby traps rely for their success entirely on surprise, the charge and the operating mechanism always will be either concealed or made to resemble some common, harmless object. Wires generally are employed in booby-trap installations, and usually are the primary evidence of booby-trapping. The detection of booby traps requires knowledge of enemy booby-trap equipment, its normal employment, and how to disarm it. Thorough training is necessary to develop ability in visual and manual investigation. All personnel must be trained to—

(1) Exercise extreme caution wherever booby traps may be encountered.

(2) Watch closely for unnatural objects or conditions.

f. Disarming booby traps always is dangerous, but casualties can be avoided if the proper precautions are taken. Normally one person examines and disarms a booby trap, while the others remain at a distance.

(1) A locality to be investigated is divided into zones. Traps are cleared systematically from each zone before proceeding to the next. When a trap is found, the method of disarming is determined before the trap is disturbed in any way. No attempt is made to disarm it until its method of firing is understood.

(2) Most of the standard booby traps are fitted with one or more safety devices, usually a pin. First the hole from which the pin has been withdrawn is located. Then a nail or piece of wire is inserted in this hole. Normally this makes the mechanism safe.

(3) The entire length of trip wires and lead wires is carefully examined to make certain there is no trap at the opposite end which might explode if the wire were cut. This examination also includes a search for pressure operated devices. It must be ascertained that the wire is not an electric lead wire. This prevents completing a firing circuit by cutting a double electric lead wire with pliers, or closing an electric relay by breaking a circuit. Finally, the wires are cut.

(4) Delayed-action traps usually are difficult to locate because they have no external firing agency and can well be concealed. They are safe until the time set for their explosion. On discovery of delayed-action traps the fuze mechanism must be located and disarmed.

(5) Each booby trap must be viewed with caution and respect. Its disarming and removal must be considered a new problem in which nothing is taken for granted.

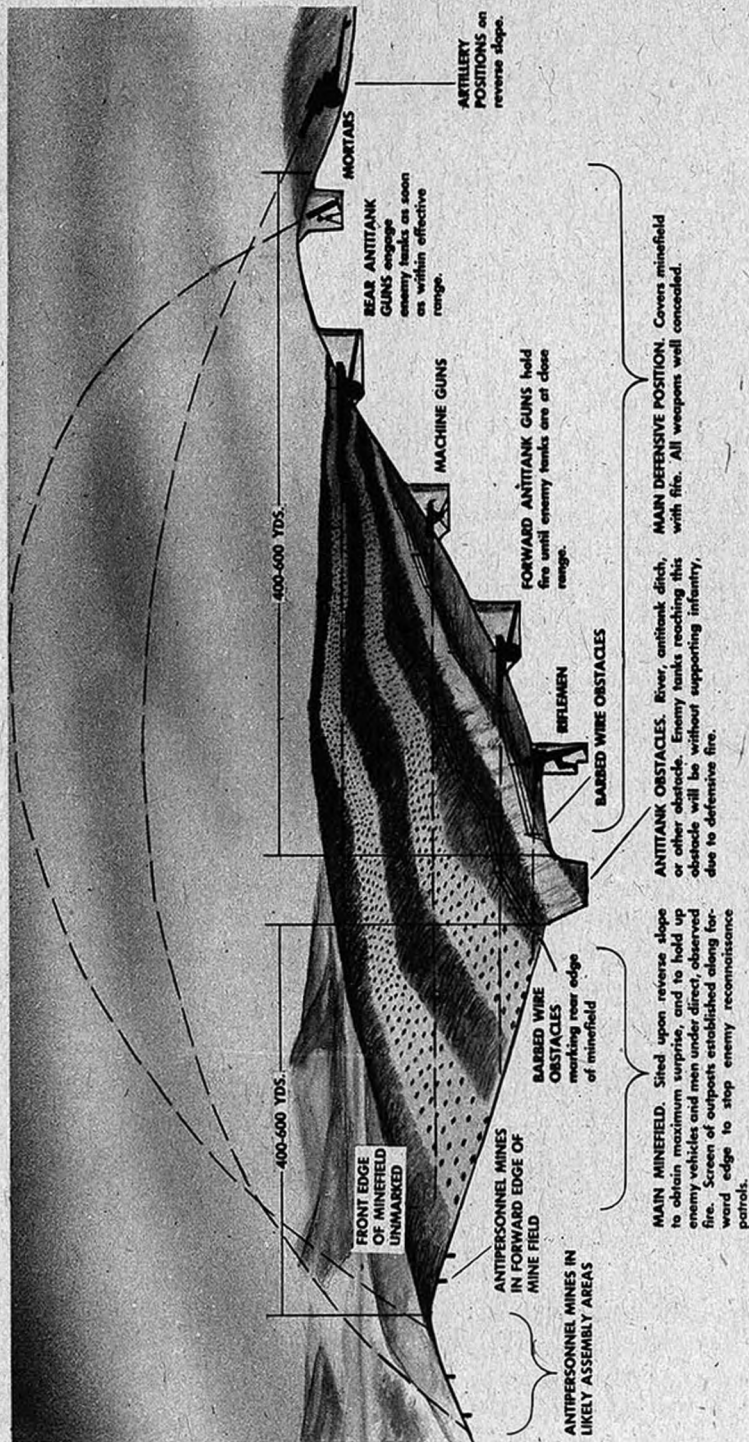

Figure 21.02. Ideal lay-out of antimechanized defensive position (schematic).

CHAPTER 2

AMERICAN MINE POLICY

21.01. EMPLOYMENT.

a. The mine field provides an antitank obstacle which can be established rapidly and which, properly sited and concealed, also may have considerable surprise value. It can be removed readily when no longer required.

b. In the defense, mine fields supplement the antitank-gun screen, which is of first importance in antimechanized defense.

c. Mine-field frontage is reduced to the minimum by making the maximum use of natural obstacles and by restricting mine fields to terrain which cannot be covered effectively by defense fire power alone.

d. To prevent enemy removal and penetration, both protective and tactical mine fields must have maximum coverage by small-arms and antitank-gun fire.

e. Nuisance mine fields usually are not covered by fire. They must be well concealed to be effective, normally are laid at wide spacing, and should contain a high percentage of antipersonnel mines.

f. Concealing the mine fields and placing antipersonnel and booby-trapped mines in it make it more difficult for the enemy to breach.

g. The extent of a mine field usually is limited by the available time, personnel, and supply and transport of mines and marking materials.

21.02. TACTICAL SITING OF MINE FIELDS

a. The selection of a site for a mine field is of vital importance. Once laid, the mine field fixes the location of supporting weapons and determines to a large degree future operations.

b. All arms, in siting, laying, and defending mine fields, must

understand clearly the basic principles of mine field siting. Those principles are:

(1) Coordination must be obtained between the organization selecting the sites and those responsible for guarding and protecting them. The mine field must be laid on terrain which can be covered effectively by protective small-arms and antitank-gun fire.

(2) The surprise value of a mine field is increased by laying it on terrain which the enemy cannot observe or has difficulty in observing.

(3) Mine-field depth is important. Mine fields disposed in depth and properly protected restrict enemy reconnaissance information to the most forward belts of the field, leaving the rear belts as surprise obstacles to check any quick enemy thrust.

c. The main tactical mine field is sited in the forward defenses so the maximum defensive fire is developed as the enemy attack reaches the mine field, with the object of separating the attacking infantry from its supporting tanks. To accomplish this it may be necessary to locate certain defensive positions in front of the main tactical mine fields. Such forward defensive areas normally will be covered by protective mine fields.

d. If the main antitank obstacle is regarded merely as protection for the forward defenses, the enemy is free to reconnoiter directly to it and its effectiveness is lessened.

e. The forward defenses normally are protected by mine belts laid at fairly wide spacing and containing a high percentage of booby-trapped and antipersonnel mines.

f. The rougher and more uneven the terrain, and the more dense the vegetation in which mines are laid, the more difficult it is to detect them. Mines laid in scrub growth which preserves little or no evidence of tracks are difficult to discover and lift. Mine fields laid in crop areas, such as corn and wheat, are difficult to clear, since in such areas the electrical mine detectors cannot be swung efficiently.

g. An ideal mine-field site is illustrated in figure 21.02. This location insures the maximum surprise effect on the enemy. It offers good weapon sites from which to fire upon him while he is delayed by the mine field.

21.03. CONTROL AND COORDINATION OF MINE FIELDS

a. Tactical mine fields are controlled by division or corps headquarters, which establish a mine-field policy at the earliest possible time. The division or corps commander orders the laying of mine fields and prescribes the plan defining their general alignment.

He also defines the policy relative to antipersonnel and booby-trapped mines.

b. Direct cooperation on the ground between all arms in siting, laying, and protecting mine fields is of great importance. Siting mine field in detail from a map alone is dangerous procedure and must be avoided. The ground must be reconnoitered by those charged with mine-field siting, laying, and protection.

c. All mine fields must be clearly marked, accurately recorded, and promptly reported.

21.04. FORWARD MINE FIELDS IN DEFENDED LOCALITIES

A plan for the battalion in a forward defensive position protected by mine fields is shown in figure 21.04. Such an installation provides defense in depth. The subsidiary tactical mine fields, running from front to rear, guard against rapid lateral exploitation if the enemy attacks and breaks through. The "cellular" or "honeycomb" nature of the mine-field installations tends to lead enemy attacks into pockets surrounded by mine fields. Thus the enemy is delayed and can be destroyed by heavy concentrations of artillery and mortar fire, followed by properly equipped counterattack launched through concealed lanes in the mine fields or over dummy mine belts.

21.05. RESPONSIBILITY FOR LAYING MINE FIELDS

a. The reconnaissance and detailed layout on the ground of a tactical mine field are the responsibility of the division engineer, in close cooperation with the antitank officer and artillery and infantry commanders.

b. Engineers and other specially trained troops, are responsible for laying, marking, recording, and reporting tactical mine fields. They may require assistance from other units. Unit commanders are responsible for strengthening their local defenses with protective mine fields. These fields must be marked, recorded, and reported immediately.

c. All combat units which are to lay protective mine fields must be trained in hasty mine-field laying and must be able to lay, mark, and record mine fields by the pacing method. Protective mine fields laid by local units must be properly sited and coordinated with the fire of antitank weapons. The unit commander is responsible for informing the division commander at once of any protective mine field laid by his unit, since it may be necessary to restrict mine laying in certain areas in order to—

(1) Prevent laying mine fields on terrain over which a counter-attack is to be launched.

ENEMY

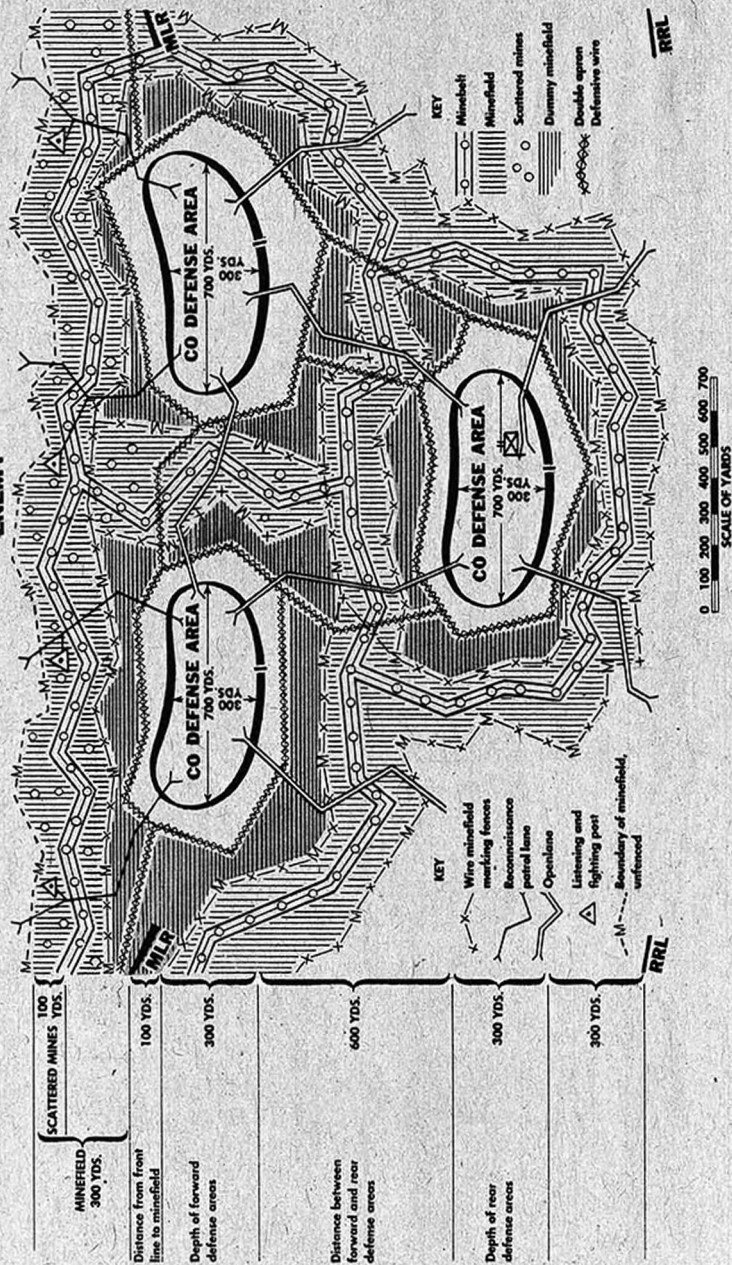

Figure 21.04. Battalion protected by mine field.

1 NOV 1943

FM 5-31

RESTRICTED

- (2) Provide lanes for passage of reconnaissance vehicles and patrols.
- (3) Regulate supply of mines to insure that all mine belts are laid in accordance with the mine-field plan of division and corps headquarters.

21.06. DEFENSE OF MINE FIELDS

a. All except nuisance mine fields must be covered by small-arms and antitank-gun fire to fulfill their mission. Mine fields not covered by fire usually do not delay the enemy sufficiently to warrant the labor and materials expended on them.

b. Defense posts are sited in the mine field itself, and whenever possible in front of it, to prevent enemy patrols from discovering the location of its forward edges, determining the direction and extent of mine belts, and lifting portions of the field. These posts serve as listening and defense positions. At night, light machine guns should be set up at them, to give fixed bands of protective fire. When the distance between defense posts is so great that machine guns cannot cover the mine field, intermediate positions must be selected and prepared for occupation to give complete coverage. These positions must be patrolled at night.

c. When it is difficult to insure effective fire coverage for a mine field, it is important to increase the percentage of antipersonnel and booby-trapped mines and visual warning devices. These impede the enemy's efforts to breach the mine field, and give warning of his efforts to lift the mines.

21.07. LANES AND PATHS THROUGH MINE FIELDS

a. Lanes and paths through mine fields must be provided to permit passage of vehicles and personnel.

b. In forward mine fields the paths are used principally by patrols. These paths must be concealed from enemy direct ground observation, and strict track discipline must be enforced. Clearly defined paths show in aerial photographs, and must be avoided. Where possible, paths are sited along stream beds, rock outdrops, or hedges. Patrol paths are changed periodically to mislead the enemy and to prevent well-defined tracks.

c. Paths for friendly patrols may be marked through forward mine fields by cords or luminous buttons. Markers must be placed carefully to prevent the enemy from detecting the lane.

d. The heavy traffic on lanes through rearward mine fields usually prevents hiding the lanes. The main objective is to conceal the fact that the lane goes through a mine field. This is done by keeping the lane straight, without obvious curves or deviations

which would indicate some obstacle, and by avoiding a network of tracks converging at the entrance to the lane.

e. Lanes are the weakest places in both forward and rear mine fields. Preparations must be made to block them quickly and so effectively that they become harder for the enemy to breach than the other portions of the field. Sufficient mines and wire to close lanes quickly must be stored near the lane, ready for instant use. The defense plan for the lane must be clearly defined and understood by the unit responsible for lane protection. Advance arrangements are made for additional covering fire to supplement local fire power available in the vicinity of lanes.

21.08. MINE FIELD SAFEGUARDS

a. Frequently units will be required to operate in sectors which have been mined and booby-trapped by friendly troops. It is imperative that a standard method of marking mine fields be used and that units mark mine fields as they are laid. In addition, advancing troops must mark all enemy mine fields and booby traps which have been discovered and not removed in order to warn friendly troops following behind. For the latter, coordination between division and corps engineers is required to fix definite responsibilities for this work.

b. The standard mine-field marker adopted by allied armies is a red triangle suspended at the apex from a fence at 25-yard intervals. Figure 21.08a illustrates the marking of friendly mine fields. With the exception that isolated, inconspicuous markers such as piles of stones, cans, etc., may be used to warn friendly patrols, the side of the forward mine fields nearest the enemy is unmarked (fig. 21.08b). The rear boundary of the forward mine field will be

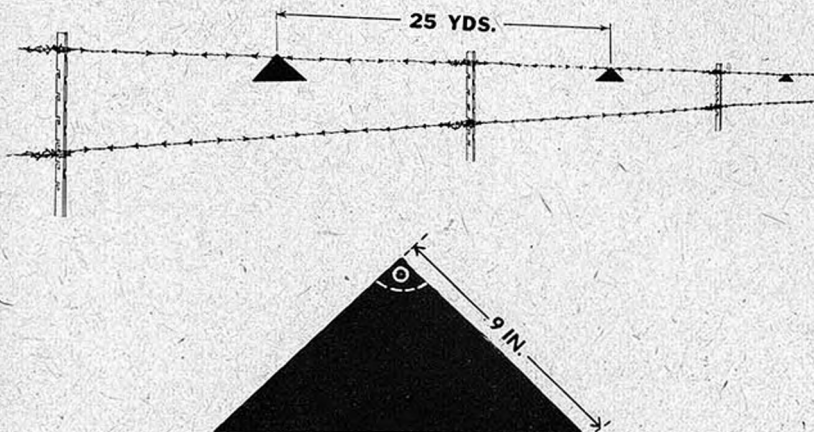

Figure 21.08a. Mine-field fence marker signs.

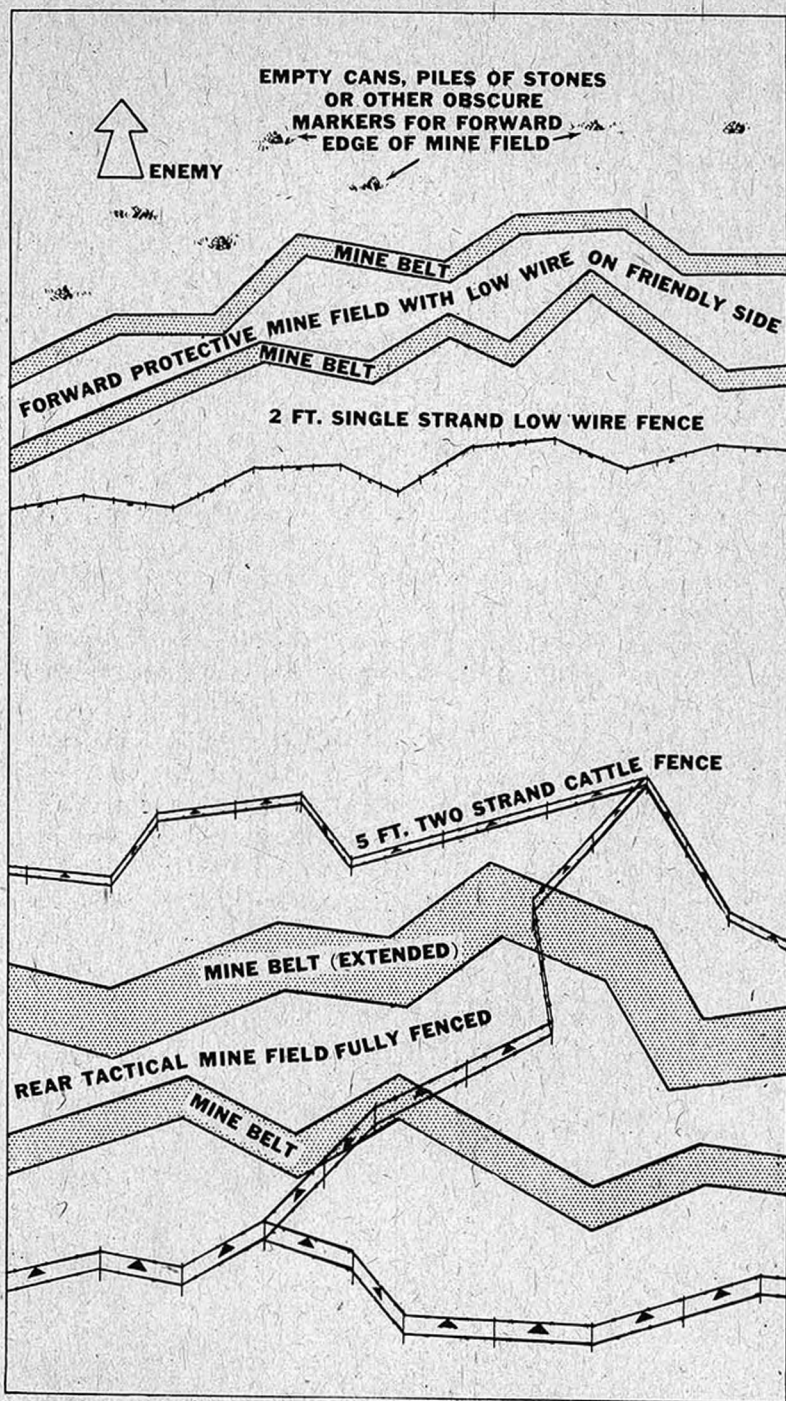

Figure 21.08b. Mine-field marking fences.

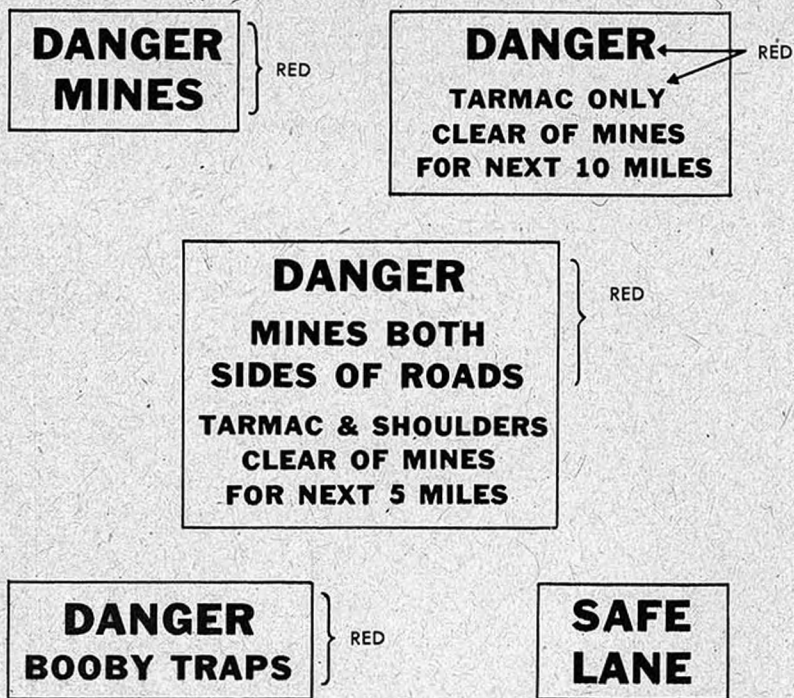

Figure 21.08c. Standard types of mine danger signs.

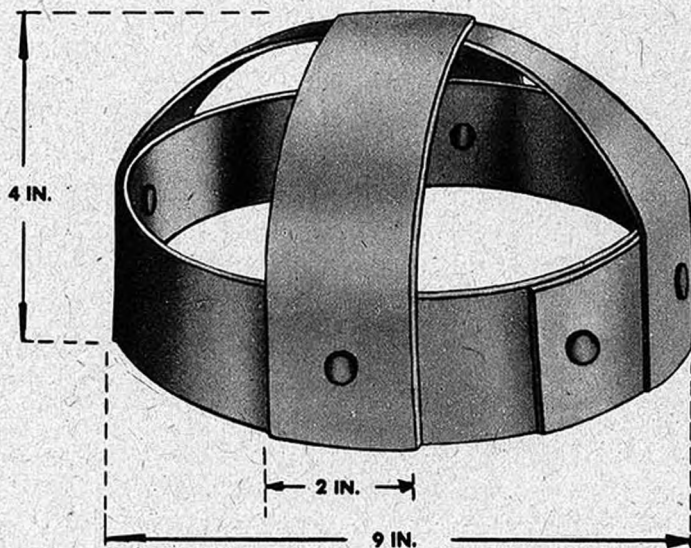

Figure 21.08d. Individual mine marker.

marked at 25-yard intervals with the red triangular signs hung onto existing fences or tactical obstacles as the double apron fence and concertina, or on single strand barbed wire fence erected for this purpose.

c. All mine fields to the rear of the forward mine field will be completely inclosed by a two-strand barbed-wire cattle fence, 5 feet high, with red triangular signs suspended at 25-yard intervals. These fences must be sturdy to prevent cattle from wandering into the mine field and to minimize accidents to friendly troops.

d. It is obvious that the direction of fences should not parallel the mine fields. Care must be exercised to follow lines which blend into the terrain. Fences should be concealed from enemy direct observation. Cross fences may be erected to confuse the enemy.

e. Figure 21.08c shows other authorized signs. These signs are used to supplement the red triangular marker. They are particularly useful in the advance where conditions do not permit the fencing in of mined areas by troops discovering them. The individual mine marker (fig. 21.08d) is used to indicate the exact location of a mine. For information concerning the marking of lanes through mine fields, see paragraph 43.09.

21.09. WITHDRAWALS. Before a withdrawal all lanes are closed and all mine-field-marking fences and markers removed.

21.10. MINE-FIELD RECORD AND REPORTS

a. All mine fields are recorded by the unit laying them and are reported when laid.

(1) **TOPOGRAPHIC MARKER** This is a terrain feature that is easily identified and appears on a topographic map. It is used as a reference point in recording the location of each mine belt in a field. Its coordinates, with a complete reference to the map upon which it is shown, must be placed on the master mine-field sketch.

(2) **AUXILIARY MARKER** This is a marker used as a reference point if the topographic marker is over 200 yards from the corner of the mine field. The topographic marker and the auxiliary marker must be on the same side of the mine belt. Markers such as rock piles or buried cans which will not be destroyed easily will be used as auxiliary markers. It is placed where it can be located from the topographic marker by azimuth and pacing without danger of entering the mine field as a result of normal errors in distance or direction. The auxiliary marker should not be closer to the mine

belt than 75 yards nor farther than 200 yards. The 200 yard distance should be used where the topographic feature is as much as 300 yards away, or is not defined definitely. From this auxiliary marker a corner or rear boundary stake is located accurately by tape measurement and azimuth.

(3) **MINE-BELT SECTION** A mine-belt section may be either a standard section (hasty, fig. 31.02) (deliberate, fig. 32.02a) or a turning section (hasty, fig. 31.05a) (deliberate, fig. 32.02c).

(a) *Standard section* A standard section is rectangular and contains mines laid in a regular pattern.

(b) *Turning section* The turning section is an irregularly shaped section between two standard sections at the point where a mine belt changes direction. It employs the same mine spacing as the adjacent standard section.

b. There are two types of mine-field records.

(1) **OPERATIONAL MINE-FIELD RECORD** (fig. 21.10) which reports the type, location, and boundaries of a mine field so it can be plotted accurately in green color on the tactical map covering the area in which the field is laid. The locations of individual mines are not shown on this record (see FM 21-30).

(2) **DETAILED MINE-FIELD RECORDS** (figs. 31.05c and 32.09) These serve primarily to facilitate the later clearing of the mine field. Detailed record of the hasty mine field includes accurate location of the base lines of the belts and an indication of the pattern used. Detailed record of the deliberate mine field includes the accurate locations of all the boundary lines of the sections and section sketches showing the exact location of all antitank, antipersonnel, and booby-trapped mines.

c. Operational mine-field records must be submitted without delay by the unit laying the field.

d. All units laying mine fields normally prepare detailed mine-field records. The unit laying the field prepares the original record and transmits it to the division engineer section at division headquarters, or to the corps engineer section if corps units are involved. When the division engineer receives it he reproduces the original record and sends an operational report of the field to the division G-2 and G-3 sections. In addition, he sends to the corps engineer two copies each of both the operational and detailed records. If the mine fields be laid by troops under corps control the corps engineer receives the original record. He reproduces it and sends an operational report of the field to the corps G-2 and G-3 sections.

e. The original detailed mine-field record is valuable in case the field has to be cleared later or if additional lanes are required.

REPORT LOCATION OF HASTY MINE FIELD

- 1 ORGANIZATION _____
- 2 DATE _____
- 3 REFERENCE MAP _____
- 4 NUMBER OF MINES LAID $\frac{AT}{AP}$ _____
- 5 SKETCH

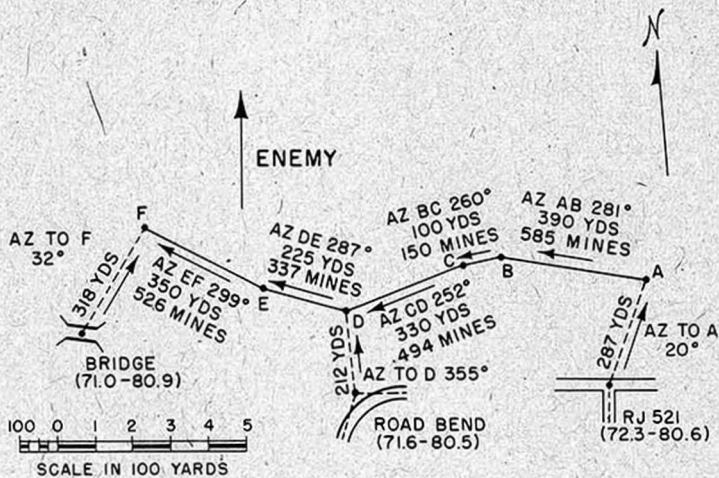

NOTE: MAGNETIC AZIMUTH
USED THROUGHOUT
A.L. DISTANCES
GIVEN IN YARDS

Show trace of base line, giving length and magnetic azimuth of each straight line section and number of mines in section.

Signature of
Officer _____

Rank and
Organization _____

Place _____

Figure 21.10. Operational mine-field sketch.

f. The corps records of the mine field are necessary for tactical purposes, and in case the field must be cleared by a different unit than the one which laid it.

g. Commanders of units entering a sector are responsible for obtaining all mine-field data of the area to be occupied by their respective commands, and for prompt and complete distribution of the information to lower command groups. For division movements these records normally are supplied by corps headquarters. On entering a new area the division engineer or his representative must be alerted early enough to reconnoiter the mined areas in advance and obtain complete data on the ground from the units being relieved.

h. General characteristics of all mine-field records are:

- (1) They include sketches to scale, showing both the general layout of the mine field and the accurate location of the mine belts. The total number and types of mines laid always must be reported.
- (2) All azimuths are magnetic. If possible, the same compass is used throughout the laying and recording of any one mine belt. Thus, any compass error is constant.
- (3) The edges of mine fields forming a ring around a defended locality are referred to as "inner" and "outer."
- (4) The edges of linear mine fields are described with reference to the points of the compass; such as "NW edge." The terms "home side" and "enemy side" are not used in mine-field records.
- (5) Mine-field records are *secret* documents, and except for location and removal of the mine field, copies must not be taken forward of division headquarters.
- (6) Changes in existing mine fields must be reported promptly through the channels outlined above.
- (7) All distances reported in the mine-field record are measured in yards, and are accurately determined by tape except where the distance is so short that error in measurement by pacing is negligible. In general, only distances under 50 yards may be paced.

CHAPTER 3

AMERICAN MINE-FIELD LAYING

SECTION I

HASTY MINE FIELD

31.01. GENERAL A hasty mine field consists of one or more hasty mine belts, in each of which the mines are laid in a shallow, regular pattern and located by pacing. The primary objective is local protection. They are laid in expectation of immediate attack. The mines are buried. Ordinarily the mines are not booby trapped, and antipersonnel mines are not installed. A hasty mine field is suitable only for limited local protection. If it is to remain in place it must be converted into a deliberate mine field at the earliest opportunity. It is generally laid in sections of varying length; a section consisting of any straight length of the field. A section is laid by parts starting at the right.

31.02. PATTERN A mine pattern that can be laid, marked, and recorded quickly by a small working party is shown in figure 31.02. Its density is that of the deliberate section— $1\frac{1}{2}$ mines per yard of front. The hasty mine pattern can be changed to a deliberate one by rearranging the mines.

31.03. SUPPLIES AND VEHICLES The personnel and supplies for the hasty mine field are transported as close to its location as the tactical situation permits. If vehicles cannot approach the mine field they are parked in the best available cover and supplies are carried forward by hand. Camouflage discipline must be enforced.

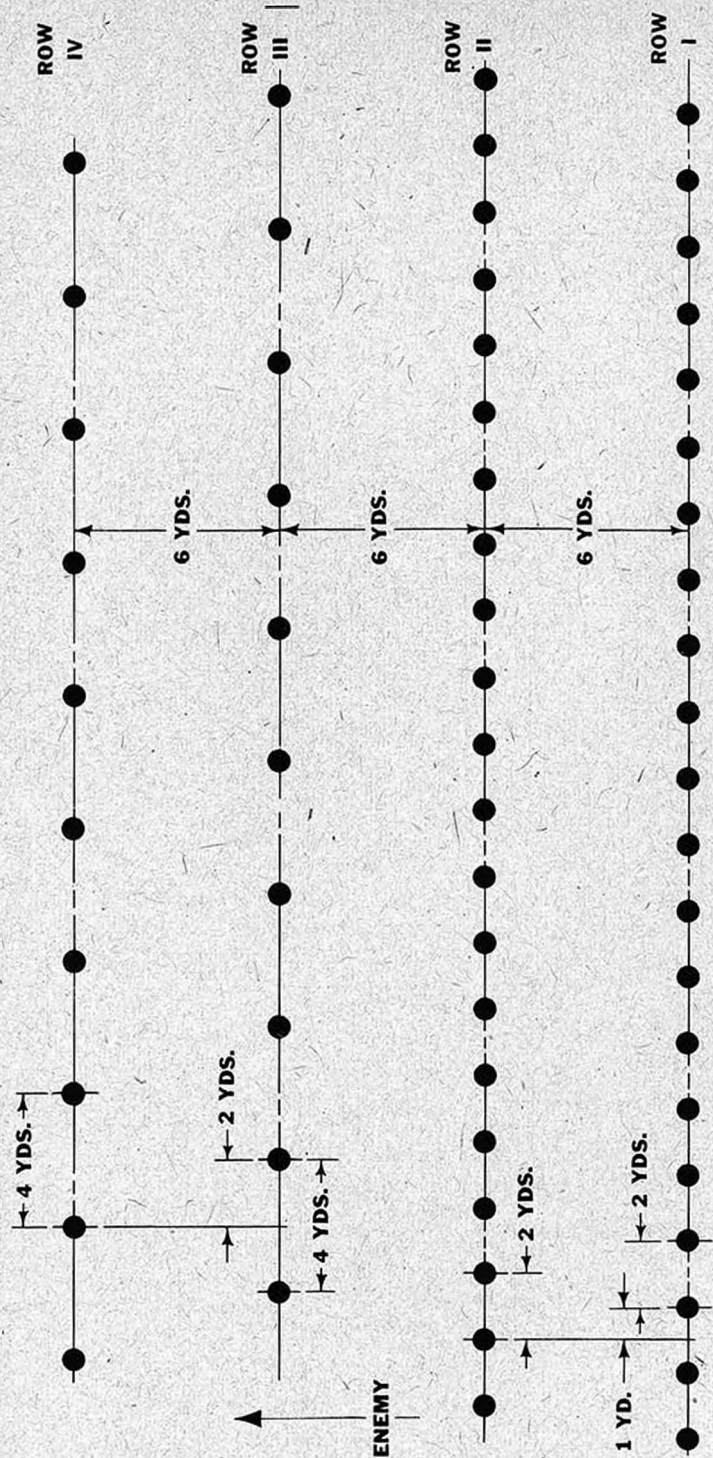

Figure 31.02. Hasty mine-belt pattern.

1 NOV 1943

FM 5-31

RESTRICTED

31.04. ORGANIZATION FOR LAYING HASTY MINE BELT

Each section of a hasty mine belt normally is laid by a platoon. The organization of the working parties is as follows:

	Officers	Noncommissioned Officers	Men
Officer in charge	1
Siting party	1	2
Laying party	1	12
Burying party	1	18
Marking party	1	4
Recording party	1	2
Total	1	5	38

31.05. PROCEDURE FOR LAYING HASTY MINE BELT

Personnel	Equipment	Duties
Officer in charge	Map, lensatic compass.	Designates location of base line. Designates topographical references and locations of auxiliary markers. Verifies lengths and azimuths of all reference lines. Collects all safety forks and safety pins and has them buried beside right rear corner stake of each section. Establishes mine-field safeguards. Collects and inspects all mine-field records. Turns in records, and reports completion of task to next higher commander.
Siting party: 1 noncommissioned officer 2 men	Tracing, tape, lensatic compass.	As indicated by officer in charge, locates and marks with tape: Rear base line. Right boundary line. Left boundary line is laid only if next adjacent section angles to rear (fig. 31.05a). Boundary tapes are at right angles to their base line and are 18 yards long.

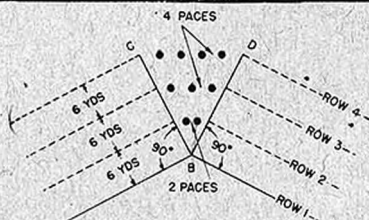

Figure 31.05a. Change of direction, hasty mine belt.

Personnel	Equipment	Duties
Laying party: 1 noncommissioned officer 12 men	Mines and mine covers as required for the section.	<p>(1) <i>Laying first part of section (36 mines).</i></p> <p>With assistance of burying party, carries mines from concealed vehicles to stock piles in rear of section. Places 36 mines alternately single and double along base-line tape at 1-yard intervals paced by noncommissioned officer in charge.</p> <p>Lines up on base line with one man at each pair of mines and noncommissioned officer at right corner of section (fig. 31.05b). On signal of noncommissioned officer, each man picks up two mines, moves forward 6 yards (paced by noncommissioned officer), halts, and places one mine.</p> <p>On signal, moves forward 6 yards farther, halts, and <i>even-numbered</i> men place their remaining mine $\frac{1}{2}$ yard to their left.</p> <p>On signal, moves forward 6 yards farther, halts, and <i>odd-numbered</i> men place their remaining mine $\frac{1}{2}$ yard to their left.</p> <p>Returns to base line along boundary tape or through un-laid portion of section.</p> <p>(2) <i>Laying second and succeeding parts of section (36 mines each).</i></p> <p>Brings up mines for next part of section and places them alternately single and double along base line so first mine is 2 yards to left of last mine on base line in finished part of section.</p> <p>Completes second and succeeding parts, using same procedure as in first part.</p> <p>(3) <i>Laying turning sections.</i></p> <p>When change of direction is to <i>front</i>, mines are laid until left boundary tape is reached.</p> <p>When change of direction is to <i>rear</i>, mines are laid in rows extending between left boundary tape BD of completed section and right boundary tape BC (fig. 31.05a) of next section, with four paces between mines in rows 4 and 3, two paces between mines in row 2.</p>

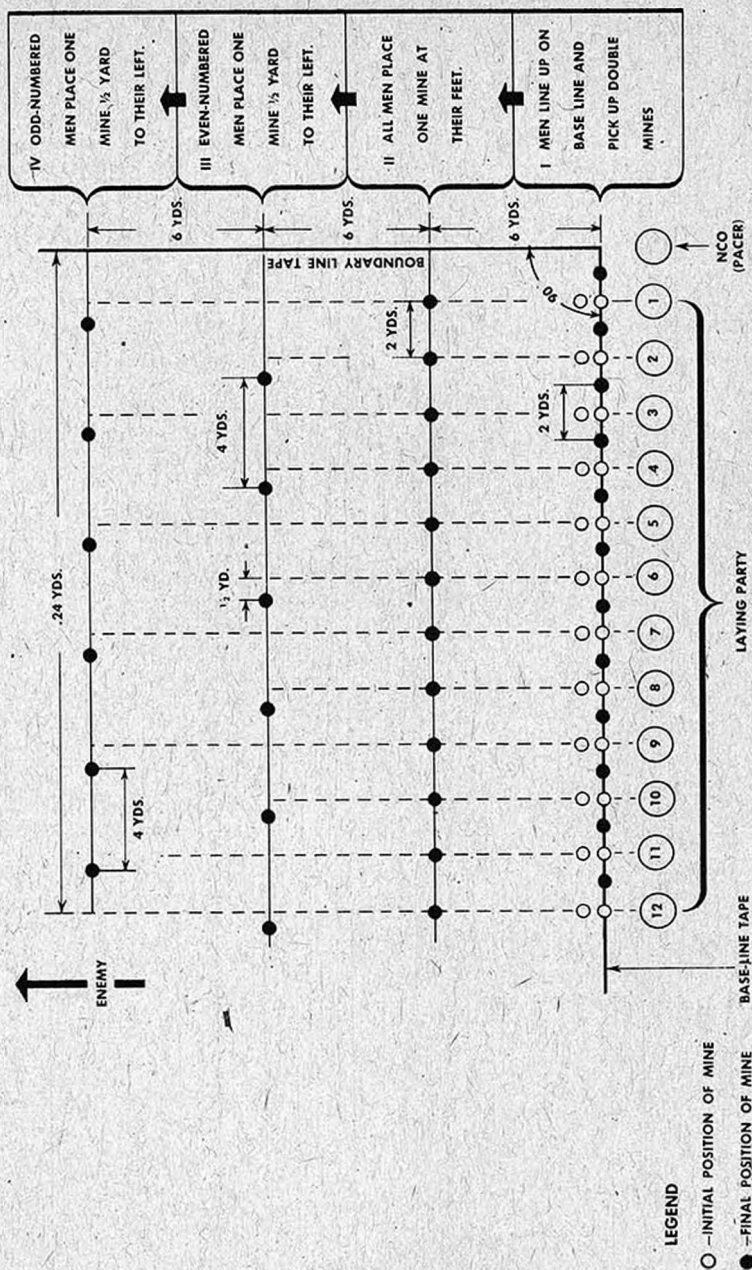
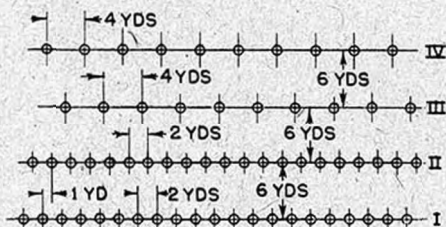
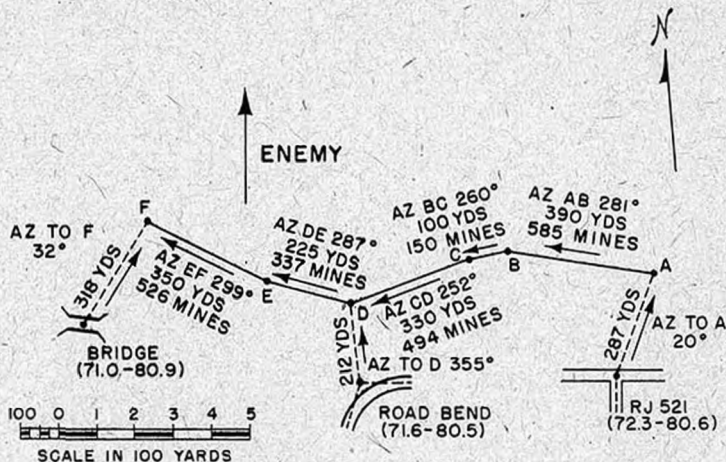

Figure 31.05b. Laying party, hasty mine belt.

REPORT LOCATION OF HASTY MINE FIELD

- 1 ORGANIZATION _____
- 2 DATE _____
- 3 REFERENCE MAP _____
- 4 NUMBER OF MINES LAID AT AP _____
- 5 SKETCH _____



NOTE: MAGNETIC AZIMUTH
USED THROUGHOUT
ALL DISTANCES
GIVEN IN YARDS

Show trace of base line, giving length and magnetic azimuth of each straight line section and number of mines in section. Tie in initial and final stakes and change of direction stake at every 1,500-3,000 feet by at least one tie line and preferably two. Draw insert sketch of standard, hasty pattern.

Signature of Officer _____

Rank and Organization _____

Place _____

Figure 31.05c. Report of location, hasty mine field (consisting of one belt).

Personnel	Equipment	Duties
<p>Burying party: 1 noncommissioned officer 18 men (9 two-man details)</p>	<p>9 picks, 9 shovels, sandbags for spoil (pick and shovel per two-man detail).</p>	<p>Helps laying party carry mines from vehicles to base line.</p> <p>Buries, arms, and conceals individual mines of each row, starting at right-boundary tape and working along rows. Two-man details are assigned as follows:</p> <p>First row—3 details. Second row—3 details. Third and fourth rows—3 details.</p> <p>As each section is completed, noncommissioned officer turns over all safety forks to officer in charge, who directs burying beside stake marking right rear corner of section base line.</p>
<p>Marking party: 1 noncommissioned officer 4 men</p>	<p>Sledges, stakes, wire-marking signs, side-cutting pliers.</p>	<p>Carries stakes, wire, and standard marking signs from vehicles.</p> <p>Erects marking fence with signs as directed by officer in charge.</p>
<p>Recording party: 1 noncommissioned officer (instrument man and recorder) 2 men (pacers)</p>	<p>Compass, sketching pad, pencils.</p>	<p>Makes large-scale sketch (see suggested form in fig. 31.05c) of mine pattern, recording: Trace of base line. Sketch of pattern. Number of mines laid. Position of marker fences.</p> <p>Removes marking tapes as each section is completed.</p> <p><i>Note.</i> Plotting procedure is as follows:</p> <p>Locate first stake at end of base line by azimuth and distance from one or more terrain features which appear on map. A suitable terrain feature is the center of a crossroad or road junction, bridge, high tower, or other sharply defined object. Identify each reference point on sketch by map coordinates.</p> <p>Plot section base lines from change-of-direction stake to change-of-direction stake, and indicate azimuth and length of each.</p> <p>Every 500 to 1,000 yards, at any intermediate stake, again tie in traverse to a terrain feature.</p> <p>Check magnetic azimuths by taking back azimuths. Record all distances in yards.</p>

31.06. ALTERNATIVE PROCEDURE FOR LAYING HASTY MINE BELT

The following procedure for laying a hasty mine belt is faster than the one just given, but the laying party is not so well controlled and therefore the method is less suitable for night use. The number of parties and their organization are the same as described in paragraph 31.04.

Personnel	Equipment	Duties
Officer in charge	Same	Same
Siting party	Same	Same
Laying party: 1 noncommissioned officer 12 men	Mines as required for the section.	<p>(1) <i>Carrying mines</i> (8 men). Carries mines from vehicles to vicinity of section base line.</p> <p>(2) <i>Laying mines</i> (4 men). Four men (pacers) take positions at row starting points on right boundary tape (fig. 31.06). Remainder of laying party supply pacers with mines. On signal of noncommissioned officer, all pacers move forward parallel to base-line tape. To guide pacers, stakes are placed along boundary tapes to mark positions of rows in each section. Pacers, numbered by rows, lay mines as follows: <i>Pacer No. 1</i> moves 1 pace forward, places mine, and then places a mine every 2 paces until he reaches starting stake of row 1 of next section. <i>Pacer No. 2</i> places mine just inside of boundary tape, and a mine every 2 paces until he reaches starting stake of row 2 of next section. <i>Pacer No. 3</i> moves $\frac{1}{2}$ pace forward, places mine, and then places a mine every 4 paces until he reaches starting stake of row 3 of next section. <i>Pacer No. 4</i> moves $2\frac{1}{2}$ paces forward, places mine, and then places a mine every 4 paces until he reaches starting stake of row 4 of next section. <i>Noncommissioned officer in charge</i> checks that pacers do not leave gaps in mine belt by placing mines in line.</p>
Burying party	Same	Same
Marking party	Same	Same
Recording party	Same	Same

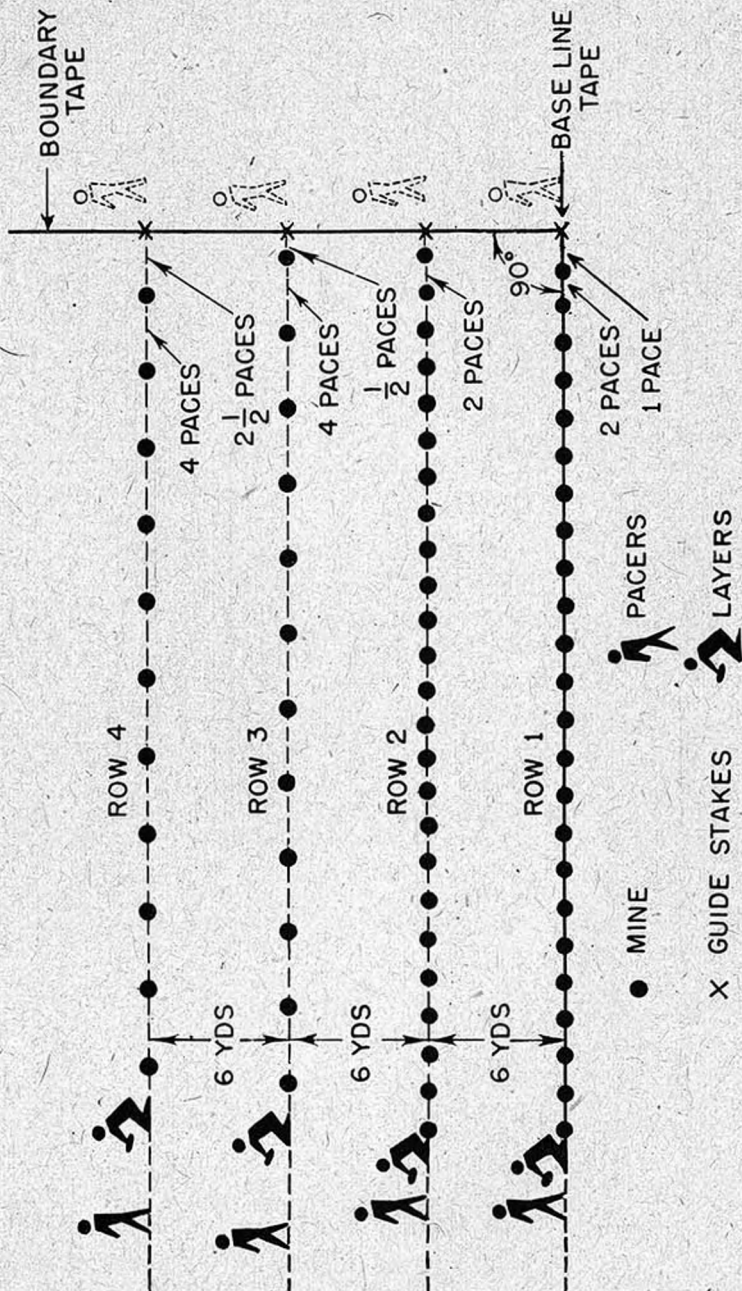
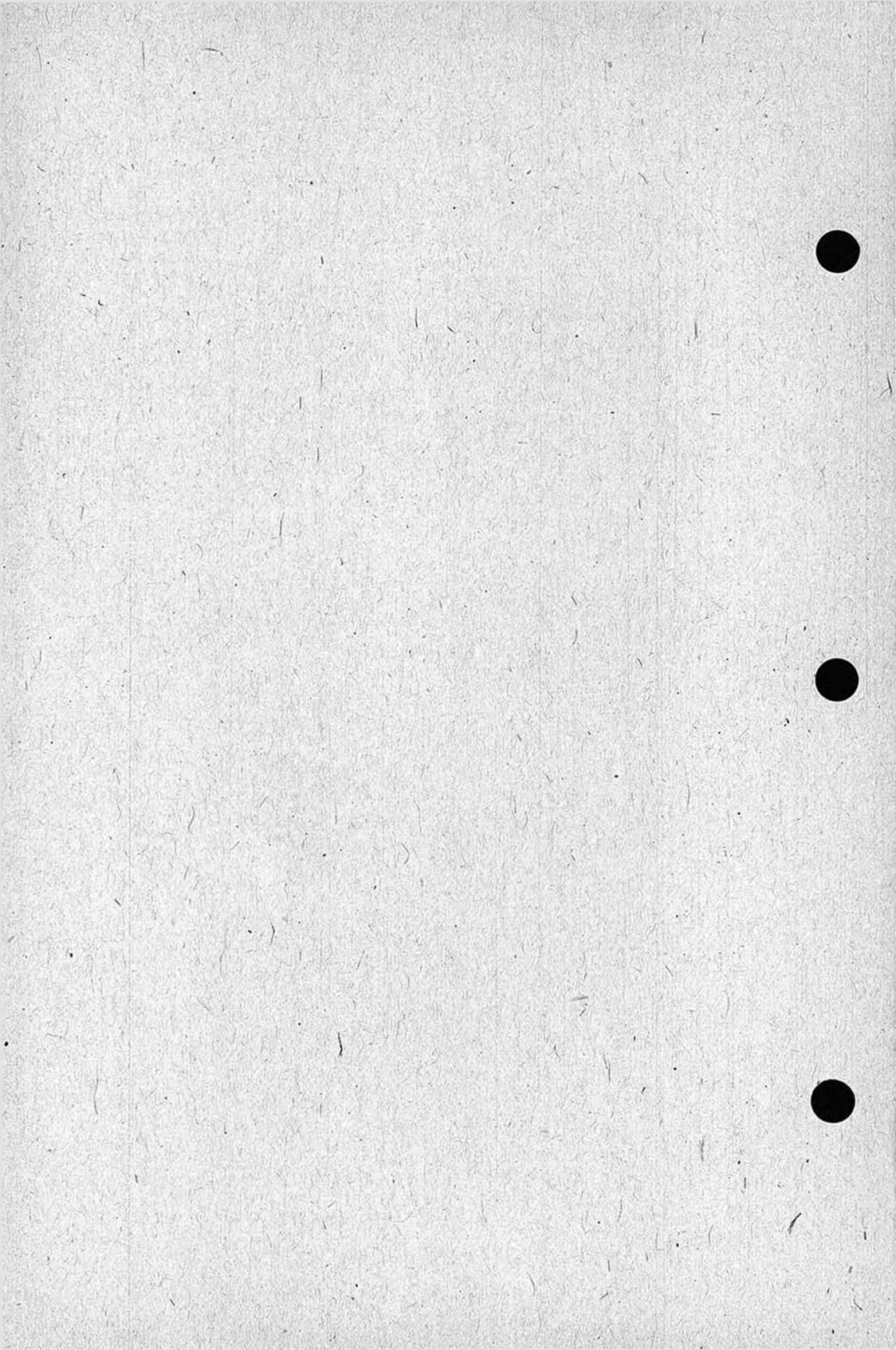

Figure 31.06. Alternate procedure for laying hasty mine belt.



b. Standard section A standard section (fig. 32.02a) is rectangular, its base is 48 yards wide, and it contains mines laid in rows parallel to the base line. Its density is one and one-half mines per yard of front. It is easy to record the mine belt, since forms for the standard sections may be duplicated in advance for use by the recorders. The location of antipersonnel and booby-trapped mines varies in each section, and is recorded as shown in figure 32.02b.

c. Turning section The turning section (fig. 32.02c) is a segment of a standard section. The turning section is recorded easily and quickly on the duplicated form of the standard section, shown in figure 32.02a. The section shown represents section 4 of the belt in figure 32.01.

d. Uniform pattern The uniform pattern is a continuous nine-row pattern with 6 yards between rows. When this pattern is used, the standard section is 48 yards deep (fig. 32.02a).

e. Extended pattern The extended pattern (fig. 32.02d) has a rear fixed part of seven rows, similar to the rear seven rows of the uniform pattern. It has a forward variable part with mines spaced at 12-yard intervals and with four rows parallel to the uniform portion and spaced at distances of 6 to 50 yards. A typical mine belt laid with extended pattern is shown in figure 32.02e. Each section is recorded on a form similar to that used for the standard section (fig. 32.02b).

**ANTITANK MINE FIELD
(Deliberate)**

Report Number _____ Section _____

Date _____

Number booby trapped
mines _____

Number AP mines _____

Total number AT
mines _____

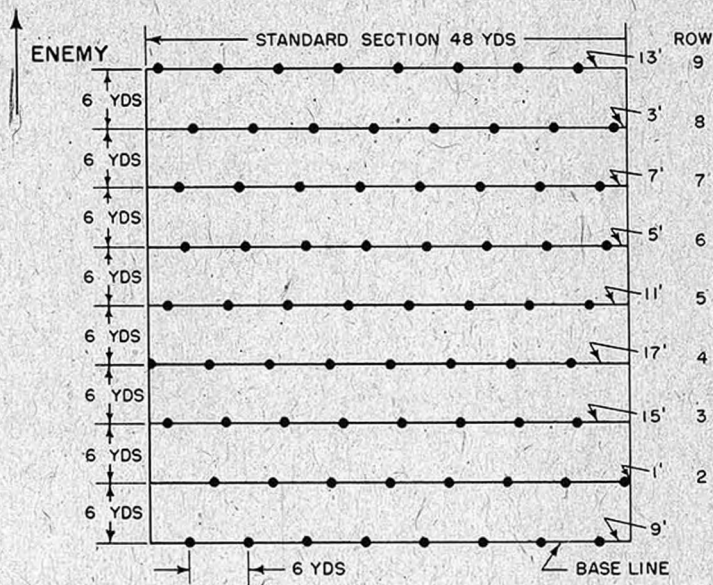

Symbols:

★ booby trapped mines

Signature of
Officer _____

⊙ antipersonnel mines

Rank and
Organization _____

⊢ trip wire

Place _____

□ stake

Figure 32.02a. Standard section, deliberate mine belt.

**ANTITANK MINE FIELD
(Deliberate)**

Report Number _____ Section _____

Date _____

Number booby trapped
mines _____

Number AP mines _____

Total number AT
mines _____

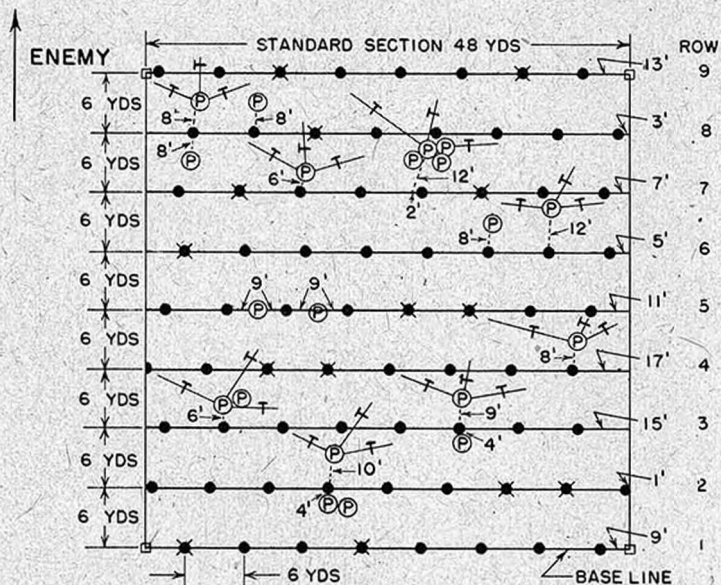

Symbols:

- booby trapped mines
- Ⓟ antipersonnel mines
- ⊥ trip-wire
- stake

Signature of
Officer _____

Rank and
Organization _____

Place _____

Figure 32.02b. Standard section complete, deliberate mine belt.

1 NOV 1943

FM 5-31

RESTRICTED

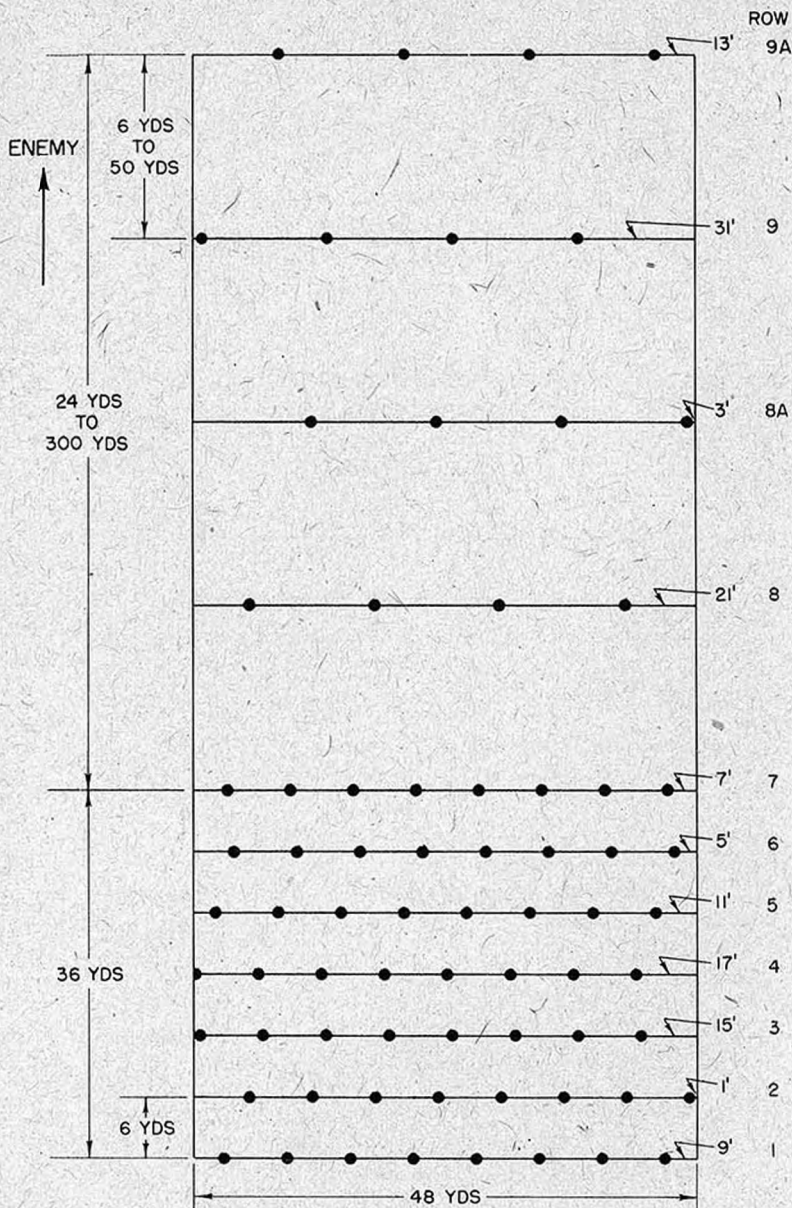

Figure 32.02d. Extended section, deliberate mine belt.

1 NOV 1943

FM 5-31

RESTRICTED

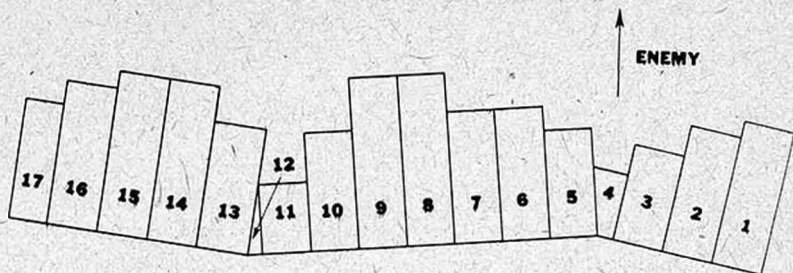

Figure 32.02e. Mine belt laid with extended pattern sections.

32.03. MINE-SPACING WIRE A spacing wire is used to simplify and speed up the placing of mines in both standard and uniform patterns. It is 161 feet long, made up as shown in figure 32.03 with eight main knots spaced 18 feet apart to indicate the placing of mines within rows, and nine offset knots in the offset portion to give the offsets for each row. Offset No. 1 is used for row No. 1, offset No. 2 for row No. 2, and so on. The offset knots are identified by numbered tags—8, 2, 6, and so on—tied to the knots. For easy identification an extra-large knot should be tied where the offset part joins the main part of the wire. A knotted wire of telephone cable is preferred to rope, because wet rope shrinks and gives false readings.

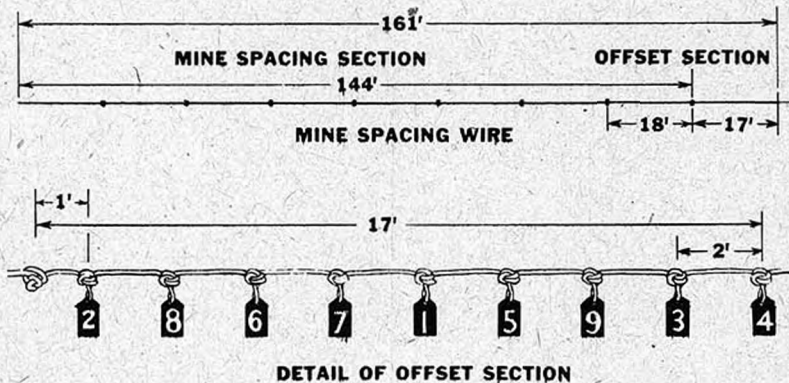

Figure 32.03. Mine-spacing wire.

32.04. INCREASED CHARGES It may be desirable to increase the explosive charge of a few mines in a field. Ten pounds of TNT or an additional mine placed beneath a standard mine will increase the damage to a tank. When TNT is used it is placed in close contact with the mine.

32.05. USE OF BOOBY-TRAPPED AND ANTIPERSONNEL MINES

a. Booby-trapped and antipersonnel mines placed at irregular intervals throughout a deliberate mine field greatly increase the difficulty of enemy clearing operations. To lessen the danger to our own troops in removal operations the mine-field report must contain complete and correct information concerning the location of such mines.

b. A "line" of antipersonnel mines is a number of mines arranged irregularly in depth, but with trip wires so placed that an enemy crossing a line perpendicular to the rear boundary of the mine field is certain to encounter at least one trip wire. Figure 32.02b shows a typical arrangement of antipersonnel and booby-trapped mines in a standard section.

32.06. ORDERS FOR LAYING Orders for laying deliberate mine fields originate at corps or division headquarters, and must specify—

- a. Location and extent of field.
- b. Density of field.
- c. Whether or not booby-trapped and antipersonnel mines are to be laid.
- d. Provisions for protecting field.
- e. Lanes desired.

32.07. ORGANIZATION FOR LAYING DELIBERATE MINE BELT Each section of a deliberate mine belt normally is laid by a platoon. The organization is as follows:

	Officers	Noncommissioned Officers	Men
Officer in charge	1
Senior noncommissioned officer	1
Surveying party	1	6
Placing party	1	6
Burying party	1	12
Antipersonnel party	1	6
Marking party	1	6
Total	1	6	36

32.08. PROCEDURE FOR LAYING DELIBERATE MINE BELT

Personnel	Equipment	Duties
Officer in charge	Map, notebook, lensatic compass, flashlight (night).	Designates location of base line. Prescribes number and location of booby-trapped and antipersonnel mines. Designates topographical references and locations of auxiliary markers. Verifies lengths and azimuths of all reference lines. Collects all safety forks and safety pins and has them buried beside right rear corner stake of each section. Establishes mine-field safeguards. Collects and inspects all mine-field records. Turns in records, and reports completion of task to next higher commander.
Senior noncommissioned officer	Notebook, lensatic compass, flashlight (night).	Supervises and coordinates parties handling booby-trapped and antipersonnel mines. Supervises burial of mine forks and pins. Indicates on section sketches number and locations of mines to be booby-trapped and of antipersonnel mines, giving type of firing mechanism and position, length, and direction of trip wires. Personally checks correctness of section sketches before burying booby-trapped antitank mines, or arming antipersonnel mines. Submits section sketches to officer in charge, who makes final check.

Personnel	Equipment	Duties
<p>Surveying party: 1 noncommissioned officer 6 men</p>	<p>Lensatic compass, sketching set, 1 ax, 1 maul or sledge, 1 metallic tape, 50-foot, tracing tape, stakes.</p>	<p>Working from right to left, drives stakes at points where base line of mine belt changes direction, as indicated by officer in charge. Stretches tape between these stakes.</p> <p>Locates rear corners of mine-belt sections by driving stakes at 48-yard intervals along base line of belt. Obtains azimuths and lengths of base line.</p> <p>Locates forward corners of mine-belt sections by driving stakes in front of base line on lines perpendicular to it. Exception — left-hand stake on forward boundary of turning section is located by intersection of lines as shown in figure 32.02c.</p> <p>Stretches tape from forward-corner to rear-corner stakes, to outline boundaries between sections. This tape is knotted at 6-yard intervals from base-line tape to show mine-row positions.</p> <p>Locates and buries auxiliary markers as designated by officer in charge.</p> <p>Prepares mine-field record by drawing sketch showing location of each belt in the field, including references to topographic and auxiliary markers. Records all distances in yards. Completes record after placing, burying, antipersonnel, and marking parties have finished work, and section sketches have been completed.</p>
<p>Placing party: 1 noncommissioned officer 6 men</p>	<p>1 mine-spacing wire, necessary mines, and mine covers.</p>	<p>Removes mines from truck and from boxes, fuzes them, and places them in groups of 72 in rear of each section.</p> <p>Noncommissioned officer supervises party and checks that mine row offsets are correctly measured.</p> <p>Two spacing wire men one at each end of mine-spacing wire, lay it on row No. 1 (base line of section), using correct offset for the row as measured from right boundary tape of section.</p> <p>Two placers, each carrying four mines, immediately place the eight mines of the row, one at each knot on the spacing wire.</p> <p>Two spacing wire men then pace 6 yards to knot in boundary tape marking row No. 2, and lay wire with correct offset to guide next two placers in placing mines for that row.</p>

Personnel	Equipment	Duties
		<p>Party repeats operation until mines are placed in all nine rows.</p> <p>NOTE: When the extended pattern is laid, the first seven rows are similar to the uniform pattern and in addition, a forward variable portion of four rows is laid (see fig. 32.02d). In rugged terrain or dense vegetation, interval between mines in each row is paced off to supplement use of mine-spacing wire, or as substitute.</p>
<p>Burying party: 1 noncommissioned officer 12 men</p>	<p>6 shovels, 6 picks, sandbags for spoil.</p>	<p>Arms, buries, and camouflages all mines <i>except</i> those to be booby trapped. Places all spoil in sacks, and removes it. Collects all forks from armed mines and, on completion of a section, turns them in to senior noncommissioned officer. He checks their total against mines laid in the section and, on order of officer in charge, has them buried in container at stake marking right-hand baseline corner of each section.</p> <p>Places mines to be booby trapped upside down, and digs holes for them. Noncommissioned officer notes locations from section sketch of senior noncommissioned officer.</p> <p>Noncommissioned officer places markers beside antitank mines, from which locations of antipersonnel mines are referenced before the antitank mines are buried.</p> <p>Upon completion of work, noncommissioned officer gives section sketch to noncommissioned officer of antipersonnel party.</p>
<p>Antipersonnel party: 1 noncommissioned officer 6 men</p>	<p>12 booby-trapping mechanisms, antipersonnel mines, fuzes, trip wires, pliers, hatchets, knives, 2 shovels.</p>	<p>Enters section <i>after</i> burying party has completed its work, and booby traps designated mines. (Note: Booby trapping is hazardous; while it is being done only members of antipersonnel party are permitted in section.)</p> <p>After booby trapping is completed, installs antipersonnel mines as indicated on section sketch by officer in charge. Works each section from front to rear.</p> <p>Does not arm booby-trapped mines until senior noncommissioned officer makes final check, directs arming, and collects safety pins and clips.</p>

Personnel	Equipment	Duties
		Drives boundary stakes into ground, removes tracing tape from right and rear boundaries of section, and reports that section is complete.
Marking party: 1 noncommissioned officer 6 men	2 sledges, wire, stakes, signs, pliers.	Carries stakes, wire, and standard marking signs from truck. Erects marking fence with signs as directed by officer in charge.

32.09. MINE-BELT RECORD The completed mine-belt record includes—

- a. Diagram of mine belts, indicating locations of various sections (fig. 32.09).
- b. Azimuths and lengths of section base lines.
- c. Number of mines laid in each section and total number of mines in each belt.
- d. References from stakes on rear boundary to auxiliary markers by taped distances and magnetic azimuths taken to $\frac{1}{2}^\circ$; or, if auxiliary markers are not used, references direct to topographic markers.
- e. References of auxiliary markers to topographic markers by paced distances and magnetic azimuths.
- f. Map coordinates of topographic markers, with a reference to topographic map from which they were obtained.
- g. Location of buried safety forks.
- h. Trace of all mine-belt fences.

32.10. SPEED OF INSTALLATION It is estimated that in the first hour an engineer platoon can complete two sections, or approximately 100 yards of front, and two and one-half sections each hour thereafter.

32.11. MINE-FIELD CAMOUFLAGE Antitank and booby-trapped mines should be buried and camouflaged. Evidences of activity such as tracks, paths, packing cases, or paper, in or near the field, must be removed. Under no circumstances must traffic make conspicuous detours around a mine field. If lane traffic is necessary, it must be controlled carefully to avoid convergence of tracks at the entrance and exit of the lane. Antipersonnel mines, firing mechanisms, and trip wires are concealed. Trip wires are not stretched taut, but are placed loosely in grass or brush, or against a background with which they blend.

REPORT: ANTITANK MINE FIELDS (Deliberate)

Report No. _____

1. ORGANIZATION _____
2. DATE _____
3. MAP REFERENCE _____
4. NUMBER OF MINES ACTUALLY LAID $\frac{AT}{AP}$ _____
5. SKETCH

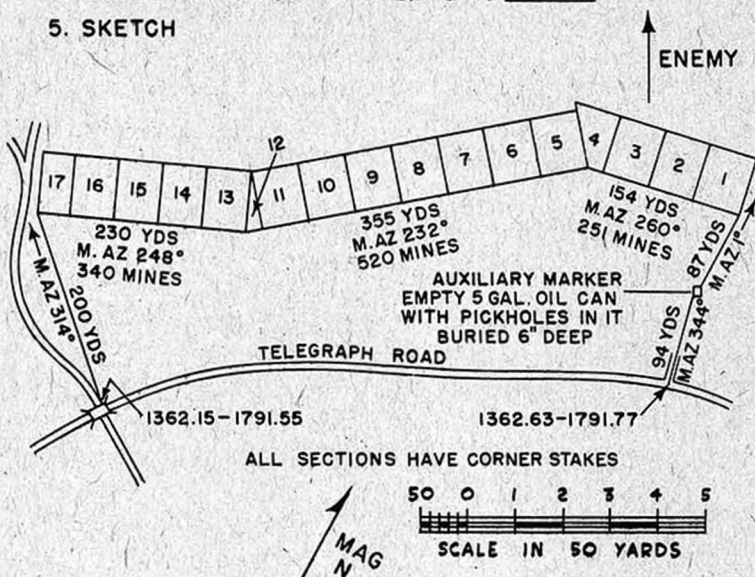

DANGER!

This field contains booby trapped AT mines. See attached individual section sketches for details.

Show pattern of mine field, locations of auxiliary markers and topographic markers including the distances and magnetic azimuths. Indicate map coordinates of topographic markers. Where possible, reference corners by two tie lines. Show magnetic azimuth and length of mine-field boundaries

Signature of Officer _____

Rank and Organization _____

Place _____

Figure 32.09. Report of location, deliberate mine field (consisting of one belt).

32.12. VARYING DENSITIES OF MINE FIELDS Frequently it is desirable to lay mine fields of greater density than $1\frac{1}{2}$ mines per yard of front. Usually this is done by laying a zone of several uniform or extended-pattern belts. Another method is to add rows to the uniform pattern. If the scarcity of antitank mines makes it necessary to lay deliberate mine fields of less density than one and one-half mines per yard of front, the standard section easily may be adapted to a lesser density by using fewer rows and modifying the initial offsets to maintain an even distribution. For instance, a section containing six rows, with mines spaced at 6 yards within rows, gives a density of one mine per yard of front.

SECTION III

ANTITANK-MINE SUPPLY

33.01. LOGISTICAL DATA Vehicles-carrying capacities for anti-tank mines (M1A1), exclusive of personnel, are—

- a. 2½-ton truck—370 boxed or 500 unboxed mines.
- b. 1½-ton truck—220 boxed or 300 unboxed mines.
- c. 1-ton trailer—150 boxed or 200 unboxed mines.

33.02. ISSUING AGENCY The procurement, storage, and issue of antitank mines, antitank mine fuzes, and safety clips is a responsibility of the Ordnance Department. Antitank mines are supplied to the using arms and services in the same manner as other class V supplies.

33.03. DELIVERY TO MINE-FIELD SITE The using agency normally draws antitank mines from ammunition-supply points and delivers them by trucks to a covered position in rear of the mine field where they are unboxed, fuzed, and assembled.

33.04. HAND-CARRY Where it is impracticable to bring a truck close to a selected mine-field site, mines are carried by hand. Using the carrying handles, one man carries four mines, two in each hand. Four mines weigh approximately 40 pounds.

33.05. RECOVERY AND SALVAGE When an antitank mine field no longer is needed, the mines are defuzed and picked up, each mine being examined carefully and usable mines salvaged. If the safety fork cannot be replaced the mine should be destroyed in place by explosive.

SECTION IV

DUMMY MINE FIELDS

34.01. Dummy mine fields are used to supplement real mine fields and to confuse and delay the enemy. They are dangerous when incorrectly used, and the following principles governing their employment must be understood thoroughly and applied.

a. Dummy mine fields are of greatest value when unexpectedly encountered by the enemy while he is under effective fire. They should be sited well back in a defensive position so the enemy has no opportunity to reconnoiter the field sufficiently to discover its true character.

b. Laying dummy mine fields in conjunction with real mine fields greatly increases the effectiveness of both since the enemy cannot easily tell them apart and is forced to consider clearing the entire area.

c. Dummy mine fields are made to look as real as possible, including the erection of standard marking fences and mine-field markers. They must be treated as real mine fields, no troops or vehicles passing through them except by standard lanes.

d. Metallic objects, such as old pieces of metal and empty ration cans laid in dummy or real mine fields, cause a reaction on the enemy's electrical mine detectors and force him to take considerably more time in checking and clearing the field.

e. Dummy mine fields may contain a few scattered antipersonnel and antitank mines. If these are placed they must be recorded and reported in the same manner as a regular mine field.

CHAPTER 4

MINE-FIELD BREACHING AND CLEARANCE

SECTION I

GENERAL

41.01. ENEMY MINE FIELDS

a. General. The enemy lays antitank and antipersonnel mines at every opportunity. Avenues of approach usually are mined, and must be cleared. This requires rapid and accurate reconnaissance to locate the enemy mine fields, and employment of personnel thoroughly trained in mine clearance.

b. In territory which has been occupied by the enemy, personnel and vehicles must avoid movement on avenues of approach which have not been investigated and cleared of mines. Mines are found on roadway surfaces and shoulders, and in the ditches. The areas adjacent to craters will be mined to prevent bypassing. Frequently the sides of these craters are mined with antipersonnel mines. Crossroads and road junctions, turnouts, parking areas, and culverts usually are mined.

c. The enemy's prepared defense position will be covered by mine fields which may include wire obstacles and tank ditches. These mine fields will have belts of various types of antitank and antipersonnel mines. Nuisance mines are to be expected in any area favorable for troop concentrations in front of the enemy position.

41.02. MINE-FIELD DISCOVERY

a. To investigate every yard of ground with a mine detector or by probing would slow the advance too much. Risks must be taken, but losses will be lessened considerably if all personnel are alert, and are trained to search visually for mines at all times. A

visual search is effective on many types of ground. Disturbed soil, piles of stones, mine boxes or traces of mine material, and unnecessary pickets all are likely indications of mined areas. Low wires of all types must be approached with caution. Anything unusual is worth suspecting, and any investigation must be made with care.

b. The study of aerial photographs is a supplementary means of locating enemy mine fields. Large scale photographs (minimum—1:15,000, desirable—1:10,000) are necessary.

(1) The following evidences of mine fields may be noted.

(a) Fences or other markers at mine-field boundaries.

(b) Vehicle tracks ending in craters.

(c) The absence of vehicle tracks in an otherwise well-traveled area.

(d) Tracks converging for no obvious reasons may indicate a gap.

(e) Regular paths and tracks made by mine-laying party and their vehicles.

(f) Mine crates or boxes may indicate a mine field in the vicinity.

(g) Newly buried mines show a characteristic pattern of disturbed earth. Under favorable conditions, the number of rows in the field, patterns, details of the spacing, and presence or absence of gaps can be determined.

(2) Camouflage, weather, and random laying of mines partially defeat the efforts of the interpreter. Photographs offer information on enemy rear areas, but front-line terrain must also be checked on the ground as the advance progresses. Inability to identify a mine field on an aerial photograph is not proof that mines have not been laid in that area.

c. The Germans have no standard, universally used mine-field pattern or plan. Many of their mine fields have patterns so complicated as to appear haphazard. Normally they consist of successive nonparallel mine belts laid in considerable depth. Single mines or small, isolated groups of mines may be found laid forward of the main mine field. Usually they are marked with small mounds of stones or other inconspicuous material. Booby-trapped mines may be found in any type mine field or isolated mine installation. Generally fewer mines are booby trapped and fewer antipersonnel mines are laid, if the enemy is withdrawing rapidly.

d. With sufficient time to prepare his position, the enemy mines it carefully with both antitank and antipersonnel mines. Careful ground reconnaissance and a detailed plan then are required to breach it successfully.

e. Often the civilians in the area suspected of containing mine fields have observed the enemy's mining activities and can give accurate information as to the location of these mines and marking devices.

41.03. ENEMY-MINE-FIELD RECONNAISSANCE

a. Reconnaissance of enemy mine fields is started as soon as possible and completed rapidly to prevent the enemy consolidating his mine-field defense. Reconnaissance normally is made at night.

b. Engineer and specially trained reconnaissance parties are employed actively along the entire front in order to obtain quickly a clear picture of the trace and pattern of the enemy mine-field lay-out.

c. Reconnaissance objectives include—

- (1) Locating front edge of enemy field.
- (2) Obtaining deepest possible cross section of enemy field, including location, depth, pattern, and types of successive mine belts.
- (3) Obtaining details of obstacles, fences, and antitank ditches.
- (4) Checking natural obstacles or unfavorable terrain for track or wheeled vehicles.

d. The results from these mine-field reconnaissance largely determine the additional reconnaissance necessary, and provide information on which to base plans for an attack.

SECTION II

MINE-FIELD RECONNAISSANCE

42.01. ORGANIZATION OF MINE-FIELD RECONNAISSANCE PARTY

The mine-field reconnaissance party consists of one officer or noncommissioned officer and six enlisted men, two of whom are armed with carbines or submachine guns. The remainder of the party is armed only with hand grenades. All personnel are equipped as lightly as possible.

42.02. OPERATION OF MINE-FIELD RECONNAISSANCE PARTY (fig. 42.02)

Personnel	Equipment	Duties
Officer or noncommissioned officer in charge	Map, compass, nails, 200-yd. spool of strong cord, hand grenades, flashlight, pliers.	<p>Leads party to starting point, indicates direction to be followed through mine field, and checks to see proper direction is maintained.</p> <p>Follows closely behind Nos. 1 and 2 as they move through field.</p> <p>Pins No. 2's tape to ground at end and every 20 feet.</p> <p>Reels out cord and pins it to ground immediately to left of tape. (This cord is left in place after the reconnaissance is completed and serves to mark for later use the safe path through the field.)</p> <p>Investigates each mine or trip wire discovered, disarms it, and records type by knots in tape: Trip wire—1 knot Antipersonnel mine—2 knots Antitank mine—3 knots New type of mine—4 knots Each mine investigated and disarmed is replaced carefully and recamouflaged. New type of mines are not disarmed until party is returning from completed reconnaissance.</p> <p>Before returning, fastens cord firmly to ground and picks up tape laid by No. 2, and all odd pieces of tape left in path.</p> <p>Brings up rear of returning party in order to disarm new type of mines which have been found. Other personnel return along tape in same order and spacing as before, and withdraw to a distance while new type of mine is disarmed.</p>

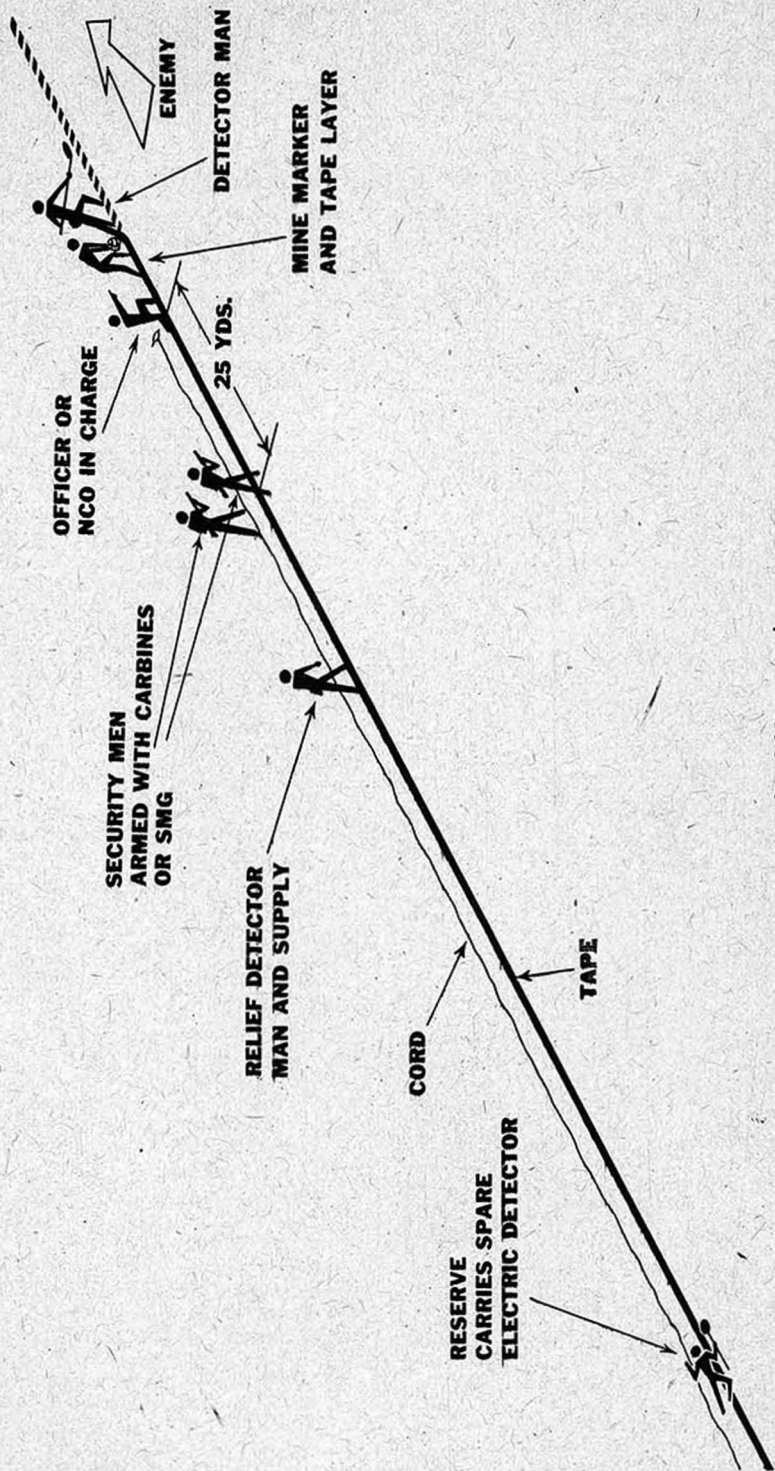

Figure 42.02. Mine-field reconnaissance party.

Personnel	Equipment	Duties
No. 1 man (detector)	Short-arm electrical mine detector.	Operates mine detector, locating mines and trip wires on a 4-foot path. Prods for mines, if detectors are not available. If taut trip wire is found, immediately calls officer or noncommissioned officer in charge and warns No. 2, who withdraws 25 yards and takes hold of cord. Officer or noncommissioned officer in charge follows trip wire to each of its ends, disarming fuzes to which it is attached, cuts trip wire, and lays ends on ground clear of patrol path on either side. No. 1 then pulls on cord to signal No. 2 to rejoin him. Uses particular caution to locate booby traps, if wire fence is encountered.
No. 2 man (marker)	Reel of white tape, mine markers.	Follows No. 1 closely and places markers on all mines No. 1 finds. Carries tape and unreels it as he moves forward. Cuts loose trip wires and fastens their ends to ground, clear of the 4-foot path, with markers to which pieces of white tape are attached.
Nos. 3 and 4 (local security)	Carbines or sub-machine guns, hand grenades.	Follows 25 yards in rear of Nos. 1 and 2, ready to open fire on enemy patrols, but does not fire unless absolutely necessary.
No. 5 (relief)	Supplies: tape, markers, nails, 6d.	Carries supplies. Relieves No. 1 at 20-minute intervals. Disarms but does not lift any mines marked by No. 2 and passed by officer or noncommissioned officer in charge. <i>NOTE: If four knots in tape indicate mine is new type of mine, marker is left intact and mine is disarmed by officer or noncommissioned officer in charge on return trip.</i>
No. 6 (reserve)	Spare electrical mine detector, hand grenades.	(1) Remains at point where party entered mine field, as reserve. (2) Carries spare mine detector.

42.03. INTERPRETATION OF RECONNAISSANCE TAPES

The knotted tapes brought in by a reconnaissance party give valuable information concerning the enemy mine field. When laid out on the ground in a rear area, it provides records of mine positions, trip wires, and mine types. When several of these records are incorporated on a sketch of the mine-field area they provide an indication of the mine-belt axis.

42.04. RESUME

- a. When detectors are not available, No. 1 man of the reconnaissance party prods for mines.
- b. Every member in a party must be trained to handle any one of the assignments.
- c. Reconnaissance normally is carried out at night to preserve secrecy and escape enemy fire.
- d. No evidence of reconnaissance except the cord is left on the path when the mission is completed.
- e. The greater the number of reconnaissance lines completed and tapes studied the more accurately the mine field can be plotted and the more effectively breaching plans can be organized.

SECTION III

MINE-FIELD BREACHING AND MARKING

43.01. MINE-FIELD BREACHING

- a. Mine-field breaching is performed by specially trained troops. To insure success the entire operation requires careful training and coordination of all arms.
- b. Breaching a mine field in preparation for an assault resembles the opposed crossing of a river and requires the establishment of an infantry bridgehead force to cover the troops clearing vehicle lanes through the mine field. Since the enemy maintains a close watch over his mine fields with observers and patrols, and frequently covers them with fire, it will seldom be possible to clear lanes without opposition, therefore full use is made of darkness, smoke, and heavy artillery concentrations and barrages.
- c. If reconnaissance shows the mine field contains large numbers of antipersonnel mines and trip wires the breaching operation

must start with clearing narrow paths to permit rapid passage of the bridgehead troops with a minimum of casualties.

d. The number of personnel paths established will depend on the size of the bridgehead force, the depth of the mine field, and the density of antipersonnel mines in the mine field belts. One foot path per assault company is a minimum.

e. The path-clearing parties normally will operate under cover of darkness usually beginning at such time as to permit the establishment of the bridgehead by daylight. When the footpaths are cleared the assault infantry parties pass through and establish the bridgehead.

f. Combat experience shows that even behind an infantry bridgehead the difficulties of mopping-up and the danger of enemy infiltration make mandatory a small infantry protective detachment for the enemy end of each mine-field vehicle lane.

g. The task of rapidly clearing and marking vehicle lanes through the mine field usually will employ fully all available engineer or other specially trained troops.

h. Specially trained personnel infantry and/or engineers are employed in clearing paths for infantry troops through mine fields. If prior reconnaissance has indicated the presence of barbed-wire obstacles these parties should use bangalore torpedoes to breach them. The parties may use scorpions or other mechanical means to explode the antitank and antipersonnel mines in the footpaths, or they may use mine detectors and remove them by hand. If mine detectors are used each party is organized in the same manner as the mine-field reconnaissance party (par. 42.02). However, the operational procedure is modified as follows:

(1) No cord is laid.

(2) White tape is laid and securely fastened to the ground on the center line of the path. It is not knotted. This tape remains in place as a guide to troops passing through the lane.

(3) All antitank and antipersonnel mines in the path are disarmed, lifted, and placed well clear of the path.

43.02. TACTICAL CONSIDERATIONS IN BREACHING

a. Breaches through the mine fields must be opened rapidly so the protecting infantry bridgehead may be reinforced with tanks, antitank guns, and other support weapons.

b. Antitank guns must get through the mine field or other obstacle rapidly. The time of attack and the time required for breaching must be planned to allow antitank guns to get to their positions in time.

c. The later passage of a complete armored force through the mine fields to exploit success is a phase separate from the initial passage of the infantry support weapons. The passage of an exploiting armored force usually necessitates clearing additional lanes, because those originally made for the infantry-bridgehead force will be full of supply traffic for the bridgehead troops.

43.03. MINE-FIELD BREACHING PHASES Mine-field breaching closely resembles an assault river crossing. Principal phases of mine-field breaching are—

- a. Reconnoitering and selecting suitable sites for the breaches.
- b. Establishing a protective infantry bridgehead to cover—
 - (1) Clearing and marking lanes through mine field.
 - (2) Controlling and assisting the passage of exploiting support vehicles. Controlling and assisting this traffic is extremely important and must be flexible to provide alternate routes for traffic since some lanes may become blocked with disabled vehicles and other lanes may fail of ultimate completion.

43.04. METHODS OF BREACHING MINE FIELDS

a. Mine-lifting methods

- (1) Locating mines by the electrical detector, followed by hand removal, is the most reliable and quickest method.
- (2) Prodding for mines, followed by hand removal, is slow. It requires the minimum of equipment. It must be used to clear non-metallic mines.

b. Mechanical methods

- (1) The "scorpion," or mechanical flail, which is mounted on a tank, can be operated under small-arms fire. It is slow and those used so far have had frequent break-downs.
- (2) Roller devices, propelled either by tanks or by special pilot vehicles, are intended mainly for mine-field reconnaissance in an assault to locate the near edge of the enemy mine field.
- (3) Tank-operated plows excavate mines in their path.

c. Explosive or blast methods

- (1) The "snake"—an enlarged, tank-pushed bangalore torpedo.
- (2) The "carrot"—an explosive charge carried in front of a tank and fired from inside when over the mine field.
- (3) The primacord net.
- (4) Charges placed on mines and exploded to destroy them when located by electric detector or by hand prodding.

43.05. PLANNING MINE-FIELD BREACHING

a. The method adopted for breaching a mine field depends upon various factors such as—

- (1) Nature of terrain and physical obstacles.
- (2) Types of mines in field — metallic or nonmetallic — and their susceptibility to blast.
- (3) Climatic conditions—amount of moonlight; chances of fog, and suitability for use of smoke.
- (4) Possibilities of deception or surprise.
- (5) Whether or not armor is to pass through lanes.
- (6) Over-all depth and number of belts in enemy system of mine fields.
- (7) Availability of mechanical and explosive means of clearing mines.
- (8) Whether or not enemy will use gas.

b. Whatever combination of methods is employed, the basic essentials are—

- (1) Accurate, detailed reconnaissance to locate near edge of mine fields and, as far as possible, to discover lay-out of whole field in depth.
- (2) A detailed all-arms plan for assaulting and reducing enemy position, based on available tactical and technical data.
- (3) Rehearsal of assault under realistic conditions on similar ground in rear, to achieve necessary coordination and timing.
- (4) Provision for adequate reserves, and a plan to deal with unexpected mine fields.
- (5) Provision for bringing forward supporting weapons of infantry, especially antitank guns, in time to be in position to repulse a counter-attack.

c. Factors bearing upon the planning of breaching operations are:

- (1) The attack generally should be launched as quickly as possible to prevent the enemy from further consolidating his defenses and strengthening his mine fields.
- (2) Reconnaissance of a mine field, containing antipersonnel mines, is slow, and usually can be made only at night or under an effective smoke screen.
- (3) An attack launched with inadequate reconnaissance and preparation usually will fail.
- (4) Rehearsal takes time; but many other essential preparations for the attack, such as establishing supplies of gasoline and ammunition, can be going on simultaneously.
- (5) Because of the scarcity of trained personnel and the danger involved in breaching operations the number of lanes for vehicles must be kept to the minimum — probably one per assaulting-battalion

front. Experience has proven that out of three lanes attempted, two may be expected to succeed. Separate lanes usually are required for an armored force.

(6) Priority of traffic through lanes and traffic control on both sides of a mine field must be organized carefully.

(7) The lanes, and the routes up to and beyond them, must be marked clearly.

(8) Adequate equipment and stores, including reserves, must be prepared and supply points established before the operation begins.

(9) Good means of communications from each mine-field lane to using units and higher headquarters must be provided in duplicate so the failure of one method will not cut communication permanently.

(10) It must be remembered that once the attack is launched, weak spots will be found where breaches can be made by the energetic action of comparatively few men. Hence it is essential that all mine-field breaching operations be flexible in application and capable of being started by the men available at the critical time and place.

43.06. ELECTRICAL-DETECTOR METHOD OF MINE-FIELD BREACHING (see app. I)

a. Objective The objective is to make an 8-yard lane through the mine field as rapidly as possible, and then to widen it to 16 yards.

b. Detachment Using electrical detectors, a mine-field-breaching detachment of an engineer platoon — 1 officer, 5 non-commissioned officers, and 39 men — provides a 16-yard lane through a mine field. If sufficient personnel is not available the number of parties may be reduced.

(1) The detachment uses nine electrical detectors and has three detectors in reserve. If the mine field is less than 250 yards deep, the forward detector party and three detectors may be eliminated. The breaching detachment is organized as follows:

	Officer	Noncommissioned Officers	Men
Advance party	1	1	3
No. 1 party—taping	1	9
No. 2 party—detection	1	9
No. 3 party—detection	1	9
No. 4 party—reserve and supply	1	9
Total	1	5	39

(2) Party personnel is interchangeable. Each numbered party is trained in detecting and taping technique and is capable of performing either task.

(3) Each numbered party consists of 10 enlisted men, including 1 noncommissioned officer, 3 detector operators, 3 assistants, 2 mine lifters, and 1 runner.

c. Party duties

(1) The advance party indicates to the taping party the location of the starting tape and lays out the direction of the center tape by magnetic azimuth. This detail also locates all cross tapes.

(2) No. 1 party, using tape, marks out two 8-yard lanes from the base tape. It becomes a detector party on completion of lane taping.

(3) No. 2 and No. 3 parties each clear a single 8-yard lane.

(4) No. 4 party is in reserve, and assembles supplies.

(5) The initial 8-yard lane is on the right, so tape laid to the right of the initial lane will remain untouched.

(6) All men work facing the enemy.

43.07. PROCEDURE FOR BREACHING MINE FIELD BY ELECTRICAL DETECTOR

Personnel	Equipment	Duties
<p>Advance party: 1 officer 1 noncommissioned officer. 3 men</p>	<p>Lensatic compass, stakes, marking lights.</p>	<p>Officer supervises work of entire breaching party. Noncommissioned officer directs advance party. Advance party selects best location for breaching; establishes starting line for No. 1 party; proceeds through mine field using borrowed detector if necessary, finds its outer limit and locates guide stakes or lights for No. 1 party; and establishes location of cross tapes on way back.</p>
<p>No. 1 party taping: 1 noncommissioned officer 9 men</p>	<p>3 electric detectors, 1000 yards white tape in rolls, mine markers, compass, nails, 6d, pliers.</p>	<p style="text-align: center;"><i>Lane Taping</i></p> <p>Tapes two 8-yard lanes forward from base tape as follows: <i>Men Nos. 1, 2, 3</i>, taped together at 8-yard spacing, run out main tapes from base line, using electrical detectors to check ground immediately to front as they move forward (fig. 43.07-a). Tapes may be run out from reels in special holders fastened to their backs, leaving their hands free. (Detectors operated within 8 yards of each other may cause interference which decreases their efficiency. In this case the two side detector men drop back in line with the noncommissioned officer who follows 10 to 15 yards behind the center detector operator. The side detector men are taped to the noncommissioned officer to maintain proper 8-yard spacing.) <i>Men Nos. 4, 5, 6</i> (assistants) follow, pin down tapes and cut them when required, place markers on mines found along tape lines, investigate, disarm, and cut trip wires located by detector men and run out cross-line tapes when ordered. Cross tapes are set at right angles to center tape, and extend 5 yards beyond lane-boundary tape. Normally they are placed at approximately 100-yard intervals, to equalize clearing tasks. Several cross tapes are required for a deep mine field. <i>Man No. 7</i> is a runner who accompanies noncommissioned officer in charge. <i>Men Nos. 8 and 9</i> are held in reserve at base line.</p>

Personnel	Equipment	Duties
		<p>Noncommissioned officer in charge commands party and establishes proper direction of tapes.</p> <p><i>Mine detection</i></p> <p>On completion of lane-taping, party returns along boundary tapes to assembly area and becomes a detector party, widening to a 16-yard lane, the 8-yard lane cleared by No. 2 party (fig. 43.07c).</p>
<p>No. 2 party— detecting: 1 noncommissioned officer 9 men</p>	<p>3 electrical detectors, mine markers, wire.</p>	<p>As soon as taping party has advanced 15 yards, No. 2 party starts detecting forward from tape line in right-hand lane (fig. 43.07b).</p> <p><i>Men Nos. 1, 2, 3</i> operate electrical detectors, sweeping 8 feet of frontage working in echelon at 15-yard intervals.</p> <p><i>Men Nos. 4, 5, 6</i> follow in rear as assistants and mark mines found. They switch places with detector operators at 20-minute intervals.</p> <p><i>Men Nos. 7 and 8</i> disarm and lift mines, either by hand lift or by pulling with a 50-yard wire. Place lifted mines outside lane boundary tapes.</p> <p><i>Man No. 9</i> is a runner who accompanies noncommissioned officer in charge.</p> <p><i>Noncommissioned officer</i> commands party.</p>
<p>No. 3 party— detecting: 1 noncommissioned officer 9 men</p>	<p>3 electrical detectors, mine markers, wire.</p>	<p>When ordered, walks up center-line tape and starts detecting forward from cross-line tape in right-hand lane, using same procedure as No. 2 party.</p> <p>On completion, returns down center-line tape to cross-line tape and starts widening to 16 yards lane it has just finished, unless No. 4 party is used to widen it. (fig. 43.07c).</p>
<p>No. 4 party— reserve and supply: 1 noncommissioned officer 9 men</p>		<p>Replaces casualties in both men and equipment.</p> <p>Unloads and distributes lane-marking supplies.</p> <p>Erects lane markers.</p> <p>Checks for mines converging approaches to lane.</p> <p>Maintains communication.</p>

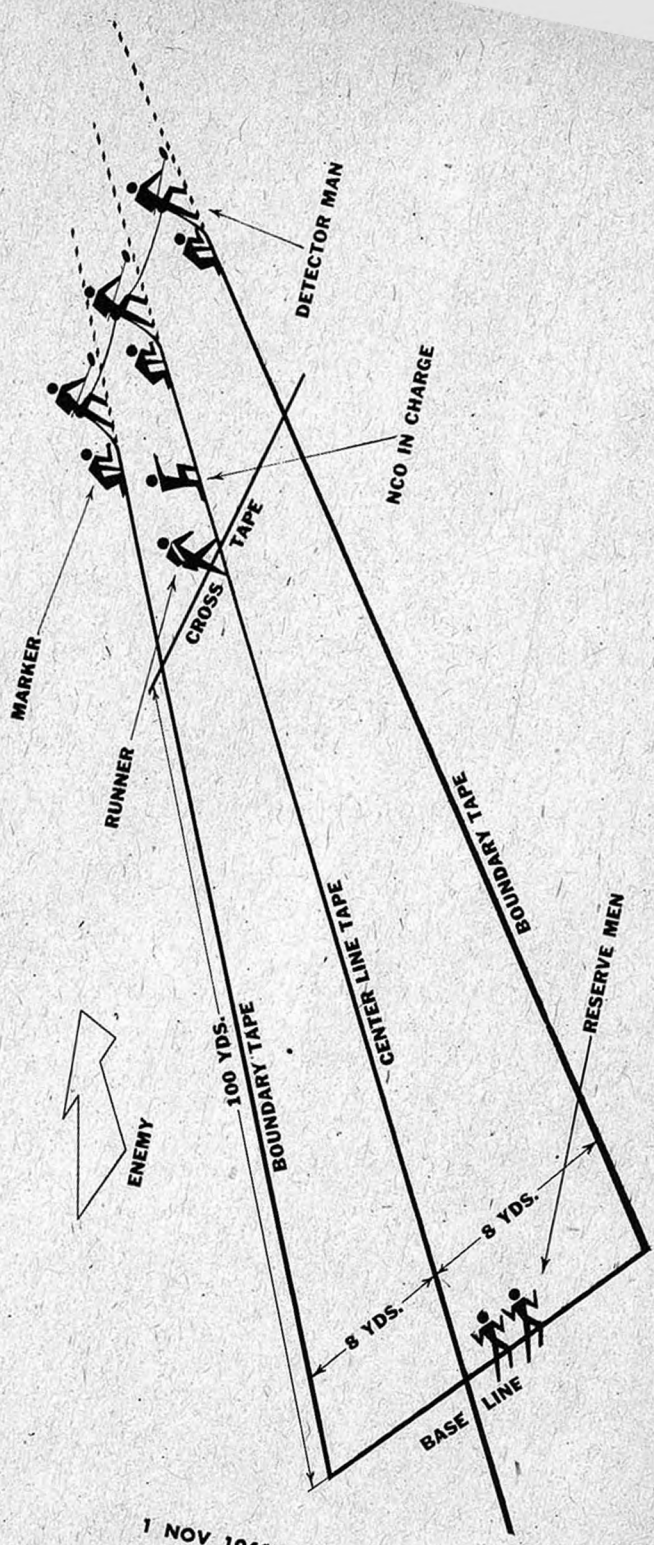

Figure 43.07a. Taping party for breaching mine-field lane.

1 NOV 1943

FM 5-31

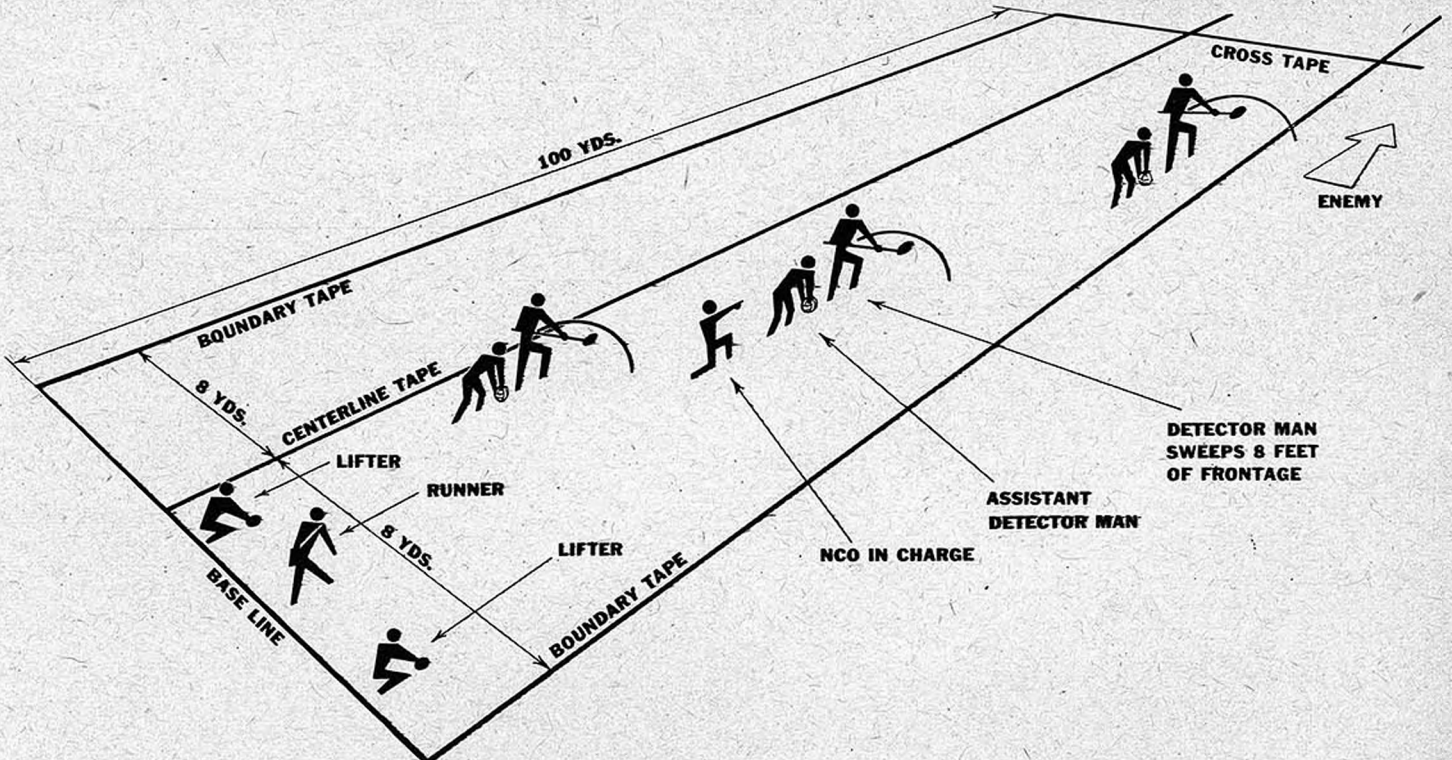

Figure 43.07b. Detector party for breaching mine-field lane.

FM 5-31

1 NOV 1943

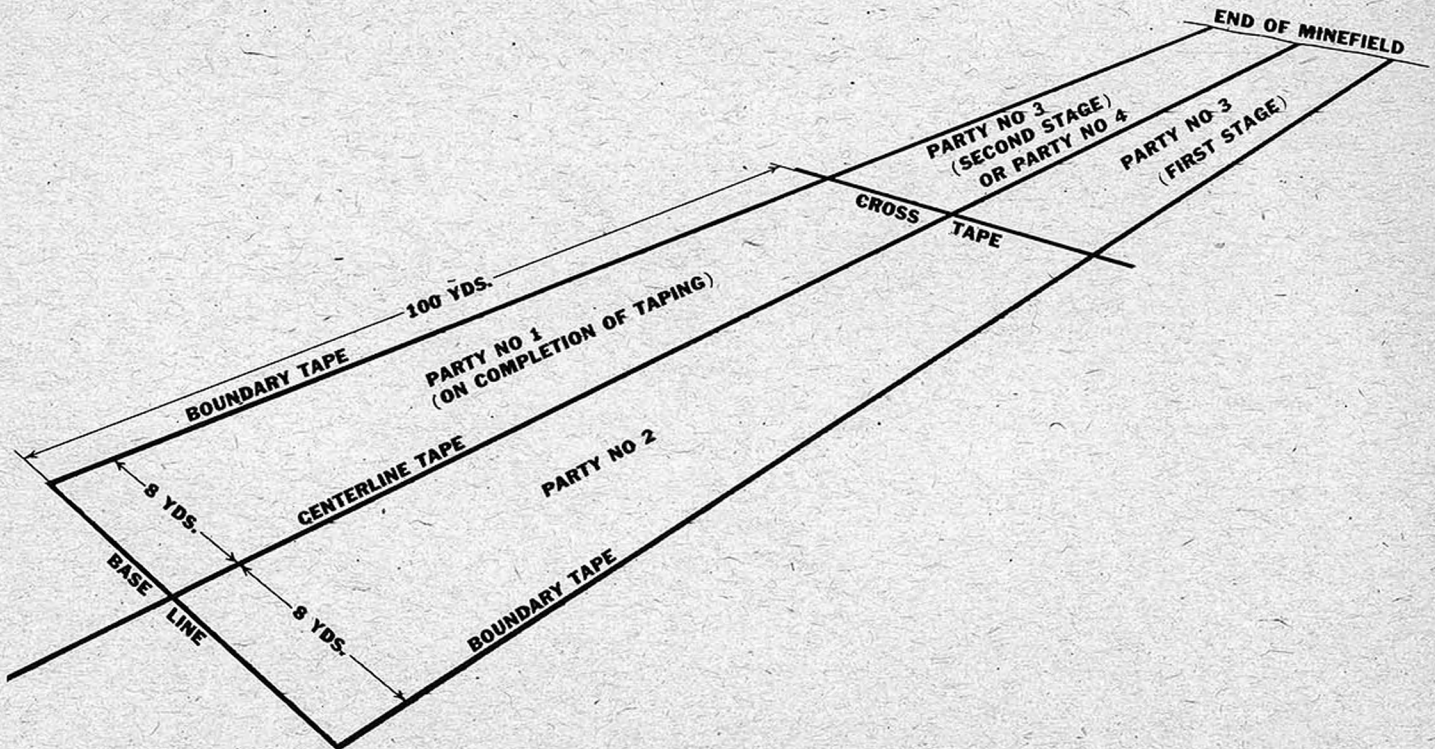

Figure 43.07c. Breaching mine field—lane widening.

43.08. SUPPLIES The following supplies are required to clear a 16-yard lane for 400 yards.

Item	Quantity	Remarks
Mine detectors	12	Minimum 12 (50 percent spares—not included—are desirable).
Tape, tracing—white ...	2,000 yards	To tape lane.
Wire pins	100	For fastening tape to ground.
Tape, tracing—white ...	2,000 yards	For marking edges of lane, on pickets, and approach lines to lane.
Barbed wire	3,000 yards	For fencing lane.
Pickets, 6 feet long (angle-iron preferred).	45	For supporting lane-marker wire and tape.
Lane markers	40	One every 25 yards on picket.
Mine markers	50	
Nails, 6d	2 pounds ...	To fasten tracing tape.
Sledge hammers	4	
Wire cutters	12 pairs	
Wire or rope	100 yards	For pulling mines.
Lights, amber	34	Lane-marker lights. If battery, a 50 percent replacement stock of batteries and bulbs is necessary.
Lights, green	48 (4 spares) .	

43.09. MARKING THE LANE

a. The original 8-yard lane is marked only by tracing tape. When it is widened to 16 yards lane markers are erected (fig. 43.09a). Standard lane marking includes erecting high pickets at 25-yard intervals along each side of the lane from entrance to exit. Double marker signs are placed on the lane entrance and exit pickets, and single marker signs on all other pickets. The signs must be placed at least 5 feet high on the picket. A two-strand barbed-wire fence is erected between pickets, and the white tapes which originally marked the boundary of the 16-yard lane are raised and placed on the top strand of the barbed-wire fence to serve as an additional warning marker. Centerline tapes are removed.

b. The standard lane-marking sign is rectangular (fig. 43.09a), pointed at one end, and painted half red and half white on both sides. The white portion points to the cleared lane; the red, to the mine field.

c. At night, colored lights are clipped to the marker signs at 25-yard intervals (fig. 43.09b). These may be issue flashlights with colored lenses, shaded by C-ration cans to restrict and direct the light beam (fig. 43.09c). A green light is clipped to the white or safe side of the marker, and an amber light to the red or danger side. On each of the double-lane markers at the entrance and exit of the lane (fig. 43.09b) an additional green light is placed below the amber and green lights. All markers are placed at least 5 feet

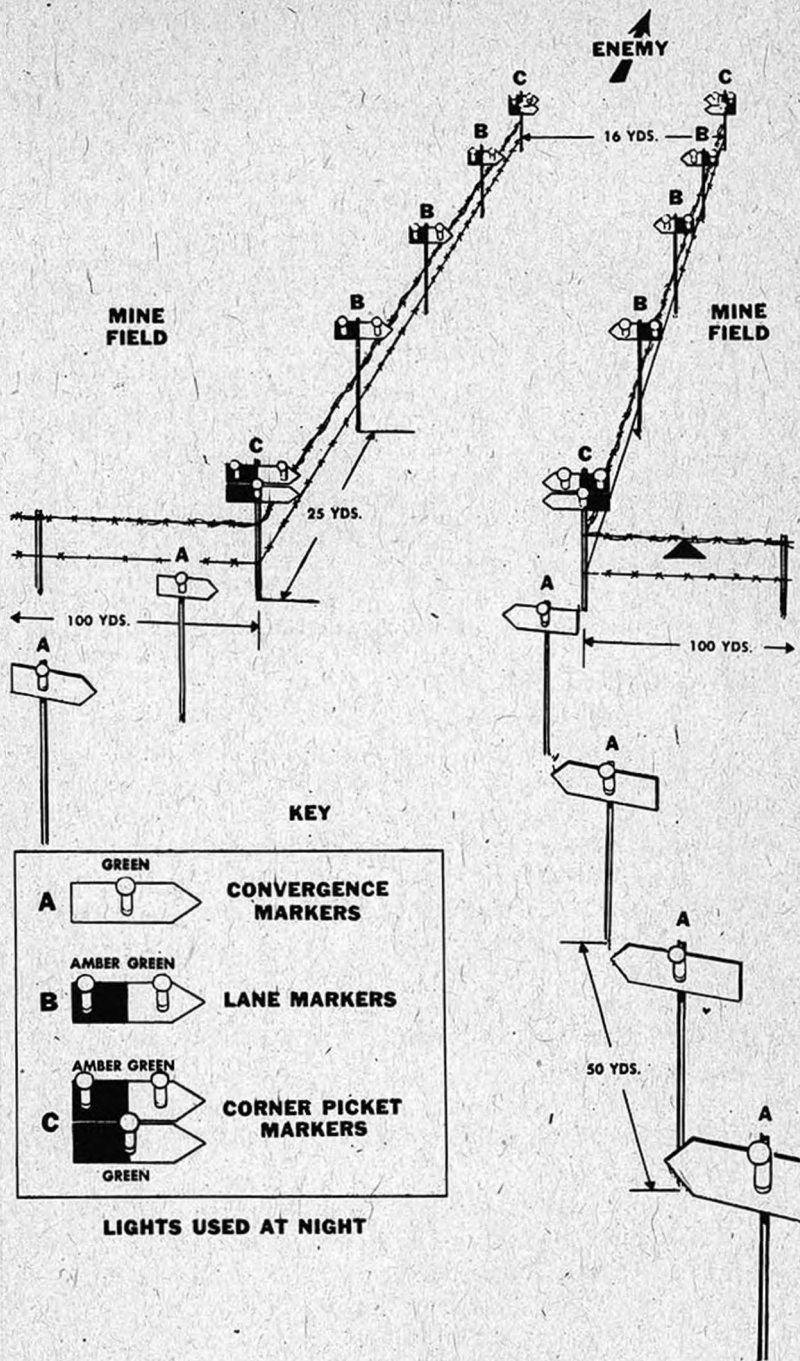

Figure 43.09a. Mine-field lane marking.

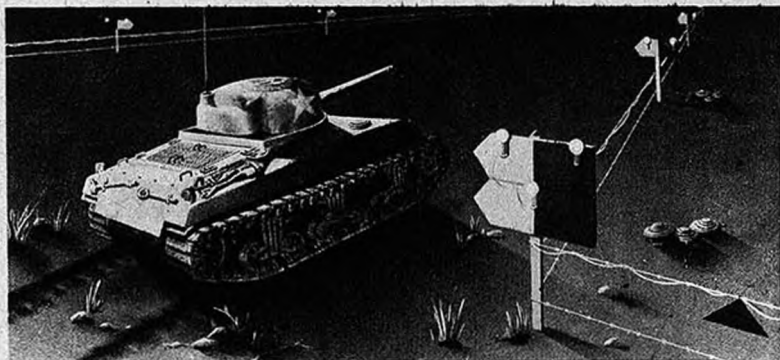

Figure 43.09b. Night view of mine-field lane marking.

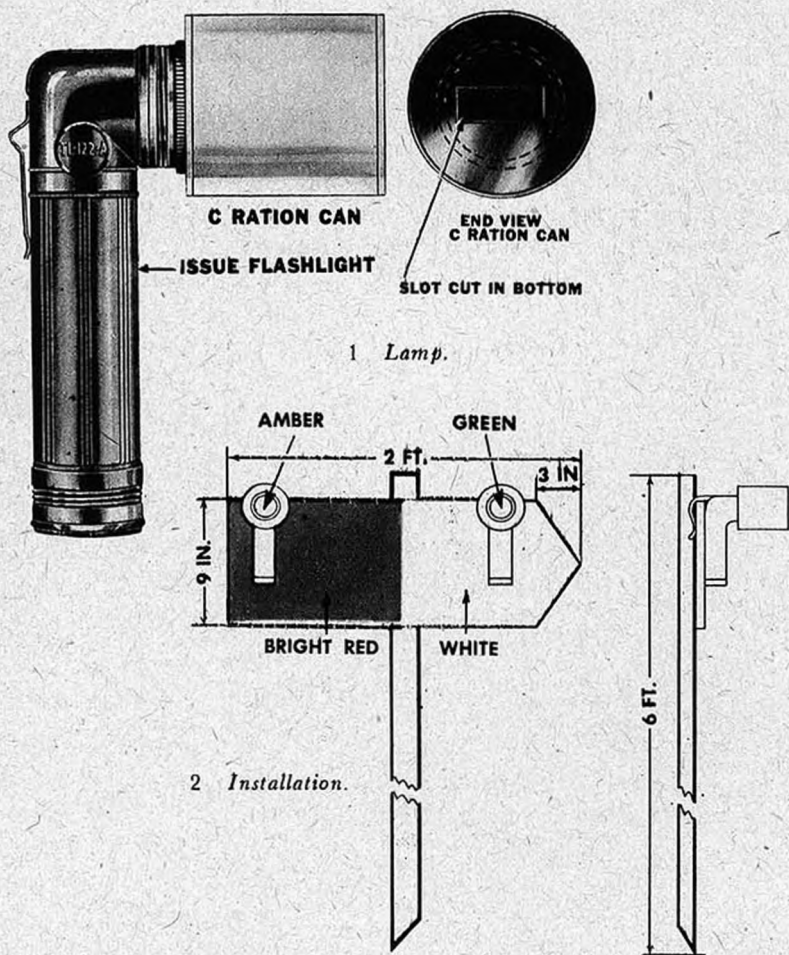

Figure 43.09c. Improvised mine-field lane-marker lamp.

1 NOV 1943

FM 5-31

RESTRICTED

above the ground so drivers, particularly tank drivers, can see markers and lights clearly.

d. Converging markers on long pickets are placed at 50-yard intervals on the friendly side of the lane. They should extend a minimum of 150 yards to the rear of the lane opening. At night green lights or luminous discs are mounted on them.

e. The rear mine-field boundaries are marked with long pickets on which barbed wire and white tape are strung for 100 yards on each side of the lane. Standard mine-field marker signs are placed on this fence.

43.10. CHECKING THE LANE When the lane has been cleared of mines and marked, and before it is opened to traffic, a pilot vehicle passes through it to test for any mines which may not have been discovered.

43.11. MAINTENANCE AND TRAFFIC CONTROL A squad from the unit which cleared the lane remains at the site to maintain markers and to improve the lane. Rigid traffic control is necessary at each lane to regulate speed of vehicles and to avoid congestion. This control is provided by the higher command.

43.12. PRODDING METHOD OF MINE-FIELD BREACHING

a. Objective The prodding method of mine-field breaching is designed to clear initially an 8-yard lane, later widened to the standard 16-yard width.

b. Method Either a bayonet or the mine probe, M1, may be used:

(1) The bayonet is inserted 2 to 4 inches in the ground at a 45° angle (fig. 43.12a).

(2) The mine probe, M1, is a 3½-foot hollow metal cylinder, jointed at the center, having a 9-inch steel point at the lower end. When the entire probe is used, the prodder stands and holds the probe in one hand (fig. 43.12b). When striking a foreign object, the hollow tube emits a distinctive sound. When the lower half is used, it is used like the bayonet (fig. 43.12c).



Figure 43.12a. Bayonet used as probe.



Figure 43.12b. Probe M1.



Figure 43.12c. Probing with lower half of probe M1.

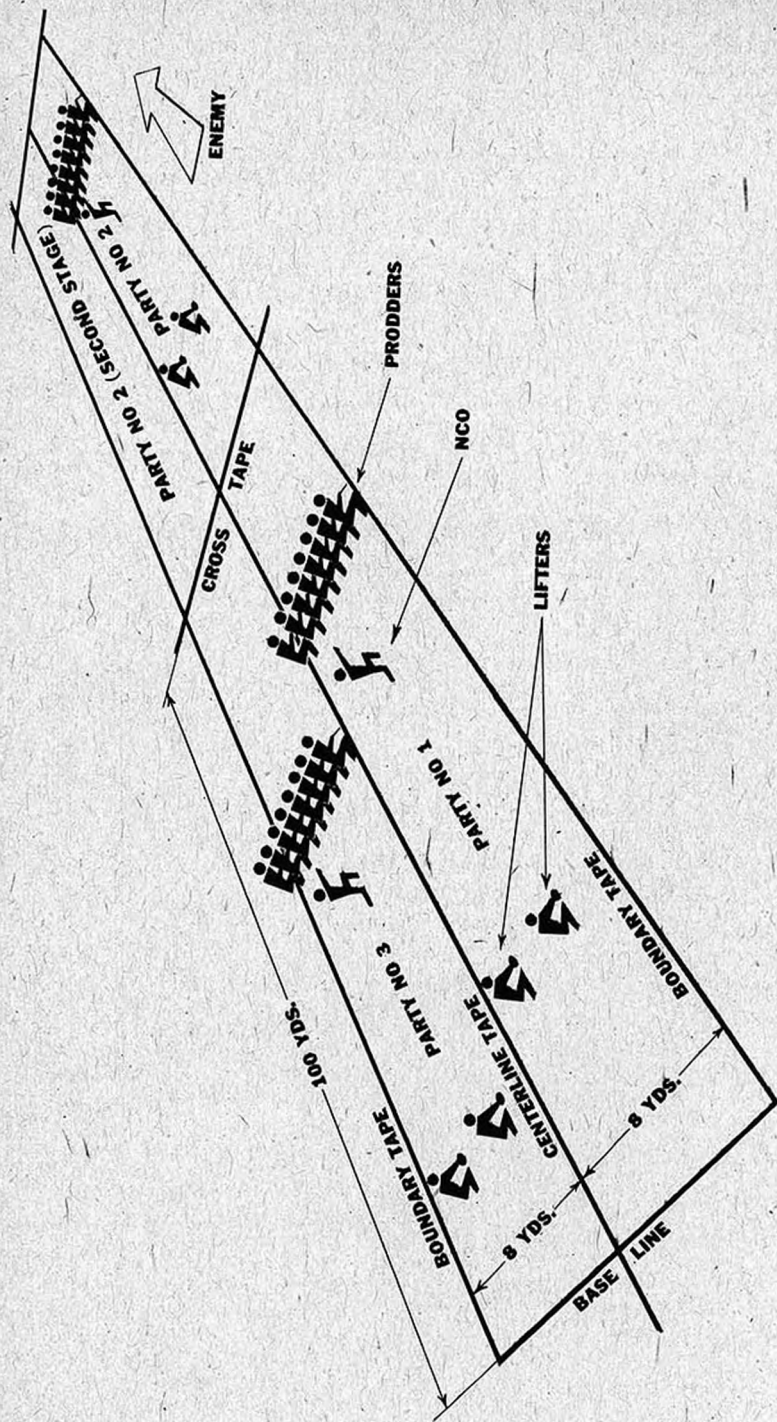

Figure 43.13. Mine-lane breaching parties—prodding method.

c. Detachment The basic prodding party consists of one noncommissioned officer, eight prodders who also mark mines found, and two lifters. Breaching a 16-yard lane is a platoon task. The platoon is divided into the following parties:

	Officer	Noncommissioned Officers	Men
Advance party	1	1	3
No. 1 prodding party.....	1	10
No. 2 prodding party.....	1	10
No. 3 prodding party.....	1	10
Supply party	1	6
Total	1	5	39

The officer in charge of the breaching controls all operations of the various parties. Usually he is stationed at the base tape.

43.13. PROCEDURE FOR BREACHING MINE FIELD BY PRODDING METHOD (fig. 43.13)

Personnel	Equipment	Duties
Advance party: 1 officer 1 noncommissioned officer 3 men	Electrical detector or probes, 1,000 yards white tape in rolls, nails, 6d, mine markers.	Determines starting and finishing points for prodding parties clearing initial 8-yard gap. By magnetic azimuth, establishes and lays out center tape between starting and finishing points. Disarms all antipersonnel mines along center line.
No. 1 prodding party: 1 noncommissioned officer (in charge) 10 men	32 mine markers, nails or wire, compass, wire cutter, flashlight, white tape.	<i>Prodders</i> (8 men), spaced at 1-yard intervals with left-flank man on center tape and right-flank man on lane boundary tape, search by prodding at a 45° angle, and mark all mines found. Each prodder carries four mine markers on his belt and several short pieces of wire in his pocket for disarming antipersonnel mines. <i>Lifters</i> (2 men) follow the prodders, lift or pull all mines, trace out trip wires, and keep tape markers in place. <i>Noncommissioned officer in charge</i> follows immediately in rear of prodders, keeps party properly spaced, maintains direction and, if necessary, assists prodders to disarm antipersonnel mines, and lifters to remove or cut trip wires. On reaching cross-line tape party becomes reserve, replacing No. 3 prodding party.

Personnel	Equipment	Duties
No. 2 prodding party: 1 noncommissioned officer 10 men	Same as No. 1 prodding party.	Walks in single file up center tape and prods in right lane, working forward from cross tape (fig. 43.13), and using same procedure as No. 1 prodding party. On completion, returns to cross tape and prods forward in left lane.
No. 3 prodding party: 1 noncommissioned officer 10 men	Same as No. 1 prodding party.	Acts as reserve at base tape until No. 1 party has finished its 8-yard lane and has returned to base tape. Then starts prodding to widen lane cleared by No. 1 party (fig. 43.13), using same procedure as No. 1 party.
Supply party: 1 noncommissioned officer 6 men	White tape, nails, 6d, probes.	Unloads and assembles lane-marking supplies. Checks for mines in converging approaches to gap. Distributes lane markers. Acts as reserve for working parties.

43.14. SUPPLIES The supplies needed to clear a 16-yard lane 400 yards long are the following:

Item	Quantity	Remarks
Tape, tracing, white (spools)	2,000 yards	For taping lane.
Wire pins	100	For fastening tape to ground.
Wire cutters	12 pairs	
Mine markers	50	
Nails, 6d	2 pounds	
Wire or rope	200 yards	For pulling mines.
Sledge hammers	4	
Lane-marker signs	40	
Lights, amber	34	Lane-marker lights.
Lights, green	48 (4 spares) ..	Lane-marker lights.
Pickets, 6 feet long (angle-iron preferred) ..	45	
Barbed wire	3,000 yards	For fencing lane.

43.15. COMPLETION The completed 16-yard lane is checked, marked, lighted, and maintained, and traffic control is established as indicated in paragraphs 43.09, 43.10, and 43.11.

SECTION IV

ROAD AND TRACK CLEARANCE

44.01. GENERAL

a. The enemy use of nuisance mines and booby traps along roads and road shoulders creates a clearing problem as serious as mine-field breaching.

b. Every route capable of carrying advancing units must be reconnoitered and cleared in the shortest possible time. Clearing routes sufficiently to get troops forward permits pursuit and attack before the enemy has consolidated his new positions. Clearing roads completely before they are opened for general traffic prevents heavy casualties, delays, and serious traffic congestions.

44.02. ORGANIZATION

a. Strict traffic control is required. It is essential that the maximum available personnel work simultaneously at clearing the road, without interference, in order to finish the task quickly. If men and vehicles crowd onto a road before it is ready for traffic, the rear portion of the road becomes congested and perhaps even the movement of essential road-clearing equipment is prevented.

b. Two sets of conditions may be met:

(1) When the ground on either side of the road is open and capable of carrying traffic, units move forward over the open country, well off the road. In this way obstacles can be bypassed rapidly, and traffic moves forward while the main roadway is being cleared.

(2) When the only means of getting forward is along the mined road itself, as is normal in rough, mountainous country, or where rivers and valleys are numerous, specially trained road-clearing detachments are deployed simultaneously along the greatest possible length of road. In this case, the first step is to get the road opened to traffic as rapidly as possible. To do this a specially organized

reconnaissance and road-surface-clearing detachment is used which reconnoiters the road rapidly and clears at least a 16-foot lane on its surfaced portion. For suggested organization and procedure see figure 44.02.

44.03. TACTICAL PROTECTION OF ROAD-CLEARING PARTIES

Local protection is given engineer road-clearing parties by troops which usually move ahead of them along bypasses. When rough terrain bordering the road prevents this, the leading road-clearing detachments move with the leading combat troops.

44.04. STAGES OF CLEARING ROADS

a. First Stage

(1) Whatever method of clearing is used, the first stage will consist of—

(a) Removing sufficient mines, derelict vehicles, and road blocks to clear a one-way route.

(b) Bypassing craters, and finding alternative routes around obstacles whenever possible.

(c) Checking crossroads and road junctions for mines and booby traps.

(d) Widespread and energetic reconnaissance for bypasses to avoid having to clear the whole road.

(e) Proper use of standard mine-warning signs to warn following units.

(2) First-stage work often must be done by leading units without engineer assistance. Hence the importance of thorough, all-arms training in mine clearance.

b. Second Stage The second stage usually handled by engineers, includes—

(1) Clearing road shoulders, improving bypasses, filling in craters, and moving derelict vehicles clear of the roadway.

(2) Completing the checking of crossroads and road junctions for mines.

(3) Clearing and marking safe turn-offs from road to unit dispersal areas.

(4) Clearing 20-foot strip, which should include the line of telephone poles, on either side of road so vehicles can halt off it in safety.

(5) Fencing and marking all mine fields alongside road from which mines have not been cleared.

44.05. CLEARING DERELICT VEHICLES, GUNS, AND OTHER IMPEDIMENTA OFF ROADS

Wrecked vehicles, guns, and miscellaneous equipment reduce the effective width of the road and

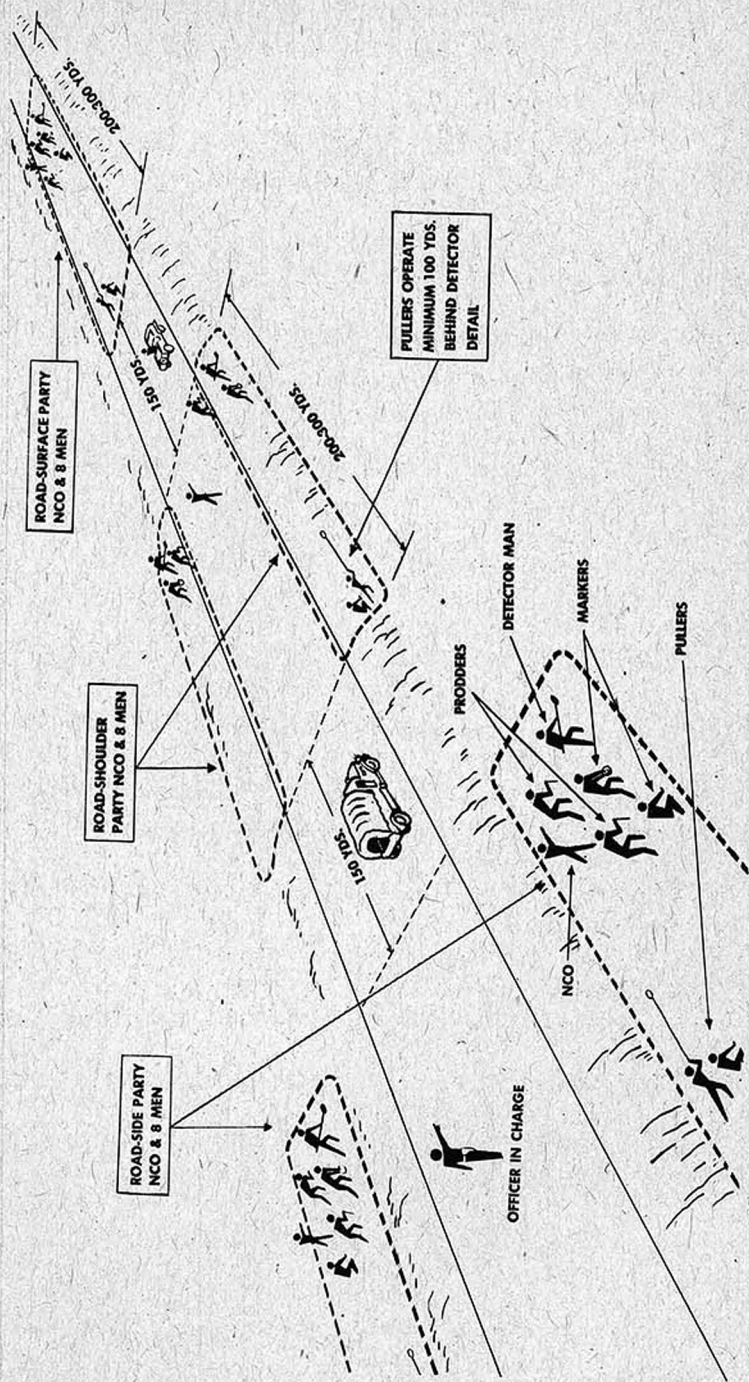

Figure 44.02. Road-mine clearing party.

slow up traffic. All units must make a point of clearing all road obstructions as quickly as possible. Precautions against booby traps must be taken.

44.06. CLEARING ROAD SURFACES OF MINES BY AN ENGINEER RECONNAISSANCE DETACHMENT

a. Speed is of primary importance. Mine detection is primarily visual, confirmed by checking with a mine detector where necessary. The party travels in $\frac{1}{4}$ -ton trucks and dismounts to work on foot when mines are numerous. The reconnaissance officer leads, followed by a mine-detection and pulling party. Mines usually are pulled out with a 50-yard length of wire or rope. With this method time is not spent looking for booby traps connected to them. If the enemy has disengaged to any appreciable distance, a succession of clearing parties, leapfrogging one another, may be used further to speed the operation.

b. Derelict vehicles, some of which will have been booby-trapped, are towed off the road with a 50-yard wire rope, operated if possible by the winch on an inclosed armored vehicle. This vehicle should accompany the leading engineer road-clearing party. It is also valuable for extra protection in case of ambush by the enemy.

c. The detachment must have long-range radio communication over the command radio net with the engineer battalion and on the division traffic-control point. This will be the normal method of reporting progress. Radio security is maintained by the use of code.

44.07. WHERE TO SEARCH FOR MINES

a. Pot holes or soft spots in the surfaced roadway are carefully checked with a mine detector, and, if nonmetallic mines have been encountered, also are probed.

b. The junction of the road surfacing and road shoulder should be given special attention because sometimes mines are inserted under the edges of the road surfacing.

c. The whole area of the shoulders is swept with mine detectors. A portable detector mounted ahead of a $\frac{1}{4}$ -ton vehicle has been used for this purpose.

d. Mines buried deeply in the road shoulders are difficult to detect, and they may explode only after the passage of numerous vehicles has compacted the earth over them. Careful detector-sweeping is necessary to locate them.

e. The 20-foot strip on each side of the road normally is searched visually; suspicious areas are thoroughly probed and checked with electrical mine detectors.

44.08. DISPOSAL OF MINES

d. The method of disposal of mines is a command function. All mines are disarmed and hand lifted when time permits. When speed is important mines are pulled at once. The resulting craters are filled in.

b. Lifted mines are defuzed and stacked in a conspicuous place, out of the way of traffic. Mines which have been disturbed by blast are destroyed by explosive charges, either in place or when pulled off the road. If possible, mines and fuzes should be kept out of the direct sunlight.

44.09. CRATERS, DEMOLISHED BRIDGES, AND BYPASSES

a. Craters and demolished bridges are favorite places for laying antipersonnel mines. These will often be encountered inside and around the edges of craters. Carefully concealed groups of mines frequently are laid where bypasses are likely to be built.

b. To avoid nuisance mines, bypasses are made well clear of craters. The places where the bypass leaves and returns to the main road are carefully checked. Previous vehicle tracks are not assumed to be safe.

c. Bypasses are clearly marked to warn traffic in time to reduce speed. A normal arrangement is to place standard warning signs to point to the entrance. Both sides of the bypass track are fenced off and clearly marked with tape.

44.10. DEALING WITH VARIOUS TYPES OF OBSTACLES

a. When wire-fence obstacles are found across roads they should be examined carefully for antipersonnel mines with trip wires laid underneath the obstacle. One method of procedure is to pull the fence clear with 50 yards of cable attached to a vehicle. Then clear away the remaining debris and search for mines underneath.

b. When tar barrels, oil drums, and similar objects are found across the road, roll them clear with ropes. Examine the road where they stood for mines and booby traps.

c. When clearing derelict vehicles from roads, first examine the shoulder of the road where the vehicle is going to be pulled off. Before releasing its brake, examine carefully for booby traps. Then pull the vehicle clear with a wire cable from the winch of an armored vehicle.

44.11. SPECIAL PRECAUTIONS IN CLEARING ROADS

a. Special care should be taken to search crossroads and road junctions for antitank, antipersonnel, and nonmetallic mines. Other likely places for nuisance mines are sharp corners and defiles, obvious turnout and parking places, and areas around houses. Often houses

are booby-trapped.

b. Be suspicious of areas near any unusual roadside markers such as stakes and boxes. Milestones and even graves sometimes are sown with antipersonnel mines.

c. Dry river beds under demolished bridges, and the approaches on either side of the bridge, are places where antipersonnel mines are found.

d. Abandoned airports usually are thickly sown with all types of mines, and must be examined carefully before use. Fresh vehicle tracks running aimlessly over the ground on an airfield may indicate mine laying.

44.12. INDICATIONS AND WARNINGS OF MINES Some signs have already been explained. Others are—

a. Disturbed ground, or hollows where earth has sunk after rain.

b. Empty mine boxes, often hidden in cellars, under culverts, and similar spots. If found, they must be reported quickly.

c. Pickets or stakes planted for no apparent reason.

d. Traces of a removed barbed-wire fence, odd lengths of wire, or pickets.

e. Small rock piles.

44.13. ROAD-REPAIR EQUIPMENT

a. Speed in repairing mined or cratered roads depends largely upon whether heavy equipment, such as bulldozers, is available, and how fast it can be moved forward. The bulldozer is invaluable for filling in craters, ramping down embankments, and for similar work, and must be moved as far forward as possible so it can start work without delay. A special traffic priority classification should be given to engineer equipment of this type. Rapid movement of equipment is obtained through close liaison between the engineers and the provost marshal. Road discipline and control of traffic are required, especially through bypasses.

b. Special care is taken to protect heavy equipment and its operators against damage from mines. Armored bulldozers are advisable. Working sites are searched carefully for mines before work begins.

c. Continuous heavy equipment operation under front-line conditions requires frequent reliefs for operators. Each bulldozer and similar machine needs at least two full crews. Operation for any considerable time at full capacity, 24 hours a day, requires three crews.

44.14. COMMUNICATION During a road-clearing operation, an efficient radio net is essential to transmit progress reports regularly to control traffic. Telephone communication between the opposite ends of bypasses around special obstacles, such as craters and demolished bridges, assists greatly in regulating traffic and preventing congestion.

44.15. PROTECTION FROM AIR ATTACK Special local air protection should be requested at important places to prevent enemy interference with the clearing of obstacles, especially demolished bridges and bypasses around craters.

SECTION V

DELIBERATE CLEARING OF MINE FIELDS

45.01. GENERAL The deliberate clearance of mine fields normally is done after the battle area has moved forward and the clearing troops are not under fire. The corps in whose area the mine fields are located designates the mine fields to be cleared and the priority of clearance.

45.02. TYPES IN MINE-FIELD CLEARING

a. Mine fields ordered cleared are divided into the following main types:

- (1) Clearance of enemy mine fields on which no records are available other than reports from troops who have passed through them.
- (2) Clearance of mine fields originally laid by our troops but which were in enemy possession or were entered by the enemy.

(3) Clearance of mine fields laid by our troops in which no records exist.

(4) Clearance of mine fields laid by our troops on which records are available and which were not entered by the enemy.

b. Mine fields subjected to artillery fire or aerial bombing have certain areas where the mines may be effected by blast. In these areas the mines invariably are destroyed in place and will be handled only when absolutely necessary.

45.03. MINE-FIELD CLEARING PRINCIPLES

a. The following principles apply to all mine-field clearing:

- (1) Everything possible must be done to clear all the mines.
- (2) Speed is a secondary consideration to the safety of personnel.
- (3) Clearance of mines normally will take place during daylight.
- (4) Reporting the clearance of a mine field is the responsibility of the unit clearing the field. Upon completion of the clearing operations, reports immediately are made to the corps ordering the clearing.

45.04. ORGANIZATION FOR DELIBERATE MINE-FIELD CLEARING

The following is the suggested platoon organization for the deliberate clearing of mine fields.

	Officer	Noncommissioned Officers	Men
Officer in charge.....	1
Advance party	1	6
Detecting party	1	6
Detecting party	1	6
Detecting party	1	6
Clearing party	1	14
Total	1	5	38

45.05. PROCEDURE FOR CLEARING First, enemy mine fields; second, friendly mine fields which have been entered by the enemy; third, friendly mine fields on which no records or inadequate records exist.

Personnel	Equipment	Duties
Officer in charge	Map, lensatic compass, all available information on field.	Designates location of field. Directs work of entire platoon. Submits report to corps headquarters which includes location, sketch of field, total number of mines cleared, and number of mines recovered.

Personnel	Equipment	Duties
Advance Party: 1 noncommissioned officer 2 detector men 2 tape men 2 supply men	Map, lensatic compass, 2 mine detectors, tracing tape.	Locate and mark safe approach to field. Locate and tape edges of each section in each belt of field. If possible, ascertain pattern of each section and pass information to detecting party.

Detecting Party No. 1: 1 noncommissioned officer 6 men	3 mine detectors, 3 shovels, mine markers, safety pins.	When a section is marked with tapes the detecting party starts locating mines. Detector operators work down the length of each section and not across as in breaching. Sweep entire section overlapping 8 yards beyond boundaries. <i>Nos. 1, 2, and 3</i> operate electrical detectors, each sweeping 8 feet of frontage and working in echelon at 30 yard intervals. <i>Nos. 4, 5, and 6</i> follow <i>Nos. 1, 2, and 3</i> , respectively, uncovering and marking all AT mines and disarming and marking all anti-personnel mines. Also lay any additional longitudinal tapes in deep sections to assist in maintaining direction. Relieve detector operators at 20-minute intervals.
---	---	--

Personnel	Equipment	Duties
Detecting Party No. 2: Same as No. 1	Same as No. 1.	Same as No. 1.
Detecting Party No. 3: Same as No. 2	Same as No. 2.	Same as No. 2.
Clearing Party: 1 noncommissioned officer 14 men	Safety pins, rope or wire, electric detector, TNT, primacord, and electric or non-electric firing equipment.	<i>Nos. 1-7</i> Disarm main fuzes in AT mines and remove all antipersonnel mines as soon as a section is swept completely by detecting party. <i>Nos. 8-14</i> Attach short ropes or wires to top of each disarmed mine. Tie these short ropes in groups of three to 100-yard ropes. When all mines are disarmed and tied, entire party moves to cover positions and pulls mines from holes. Wait 30 seconds after last mine is pulled before moving. No. 1 checks each mine hole with electric detector. <i>Nos. 2-14</i> defuze or otherwise prepare serviceable mines for transporting

Personnel	Equipment	Duties
		and stock them in small piles to be picked up later by truck. Unserviceable mines should be dragged into a pile and exploded. NOTE: Mines should be exploded in place if field has been subjected to blast.

45.06. PROCEDURE FOR CLEARING ACCURATELY RECORDED FRIENDLY FIELD WHICH HAS NOT BEEN ENTERED BY THE ENEMY

Personnel	Equipment	Duties
Officer in charge Advance party:	Same as paragraph 45.05.	Same as par. 45.05
Same as par. 45.05	Same as paragraph 45.05.	Same as par. 45.05
Detecting party No. 1:	Same as paragraph 45.05.	Noncommissioned officer indicates to detector operators the location of antipersonnel mines.
Same as par. 45.05		Coordinate detector parties operations. Nos. 1, 2, and 3 sweep down a mine row locating all AT and antipersonnel mines. Nos. 4, 5, and 6. Same as par. 45.05.
Detecting party No. 2:	Same as above.	Same as above.
Same as above.		
Detecting party No. 3:	Same as above.	Same as above.
Same as above.		
Clearing party: Same as par. 45.05	Same as par. 45.05.	Noncommissioned officer oversees party and marks all mines which are booby trapped. Entire party disarms and lifts all mines including those booby trapped. Mines are prepared for transporting and stacked.

45.07. SAFETY PRECAUTIONS IN MINE FIELD CLEARING

The following safety precautions will be observed:

- a. If available, all personnel in mine fields or suspect areas

should wear gym shoes and not boots. Gym shoes enable a man to know and take appropriate action if he has trodden on an "S" mine.

b. If a belt contains "S" mines the pattern generally will not be regular. When the rear edge of a field is marked with a low trip wire S mines may be 3 yards outside this wire and the ground should be swept.

c. It should be assumed that all AT mines are liable to be antipersonnel and there should be no walking about except in swept lanes.

d. Mines and fuzes are stacked separately and removed in separate vehicles. For best destruction mines are stacked on edge in convenient groups of not more than 20 mines. Fuzes are made as safe as possible when removed from mines.

e. Even in the presence of craters it is not safe to assume that the gaps in a regular pattern of a mine field are clear unless bits of detonated mines are definitely identified. These spots should be marked out and searched properly until it is absolutely certain they are free of mines.

f. Lanes swept during battle should be swept again even if they were used by traffic.

g. Where a track or road crosses a mine belt the bordering area will be swept for scattered mines for at least 150 yards on each side of the field.

h. Before sweeping, it is advisable to burn standing crops or long grass where S mines with trip wires are suspected to exist. S mines are unaffected by burning but antitank mines may be detonated and others made unsafe by partial melting of the shear wires. The fire must be controlled by cutting a lane around the ground to be burned or by having beaters at a safe distance (300 yards) down wind.

i. Hawkins grenades which have been in position for any length of time are particularly sensitive. They should be destroyed in place. Never attempt to lift or defuze them. Scattered grenades often are found and are dangerous in long grass.

j. Before attempting to salvage a vehicle in a mine field ascertain from the regular pattern of the belt whether there should be an unexploded mine or mines under the vehicle. In this case the detector will not function properly and it is necessary to locate the mine by prodding under the vehicle.

k. Sandbag all vehicles collecting mines from swept fields.

l. All buildings, abandoned enemy vehicles, dugouts, wells, machinery, road blocks, bridges, and the like should be checked for booby traps.

m. Assume all gullies and covered approaches to old enemy positions contain unmarked S mines and booby traps.

n. Sometimes a buried "egg" grenade is used to booby-trap wire fences marking mine fields. The cord of the grenade is attached to the wire in the fence, therefore check all wires for traps before removal.

o. Booby-trapping devices may be fitted with a $4\frac{1}{2}$ - to 7-second delay igniter. Allow 30 seconds to elapse before collecting mines after withdrawal.

p. After mines, fuzes, and detonators are lifted keep them out of the sun.

CHAPTER 5

A M E R I C A N

M I N E S A N D F U Z E S

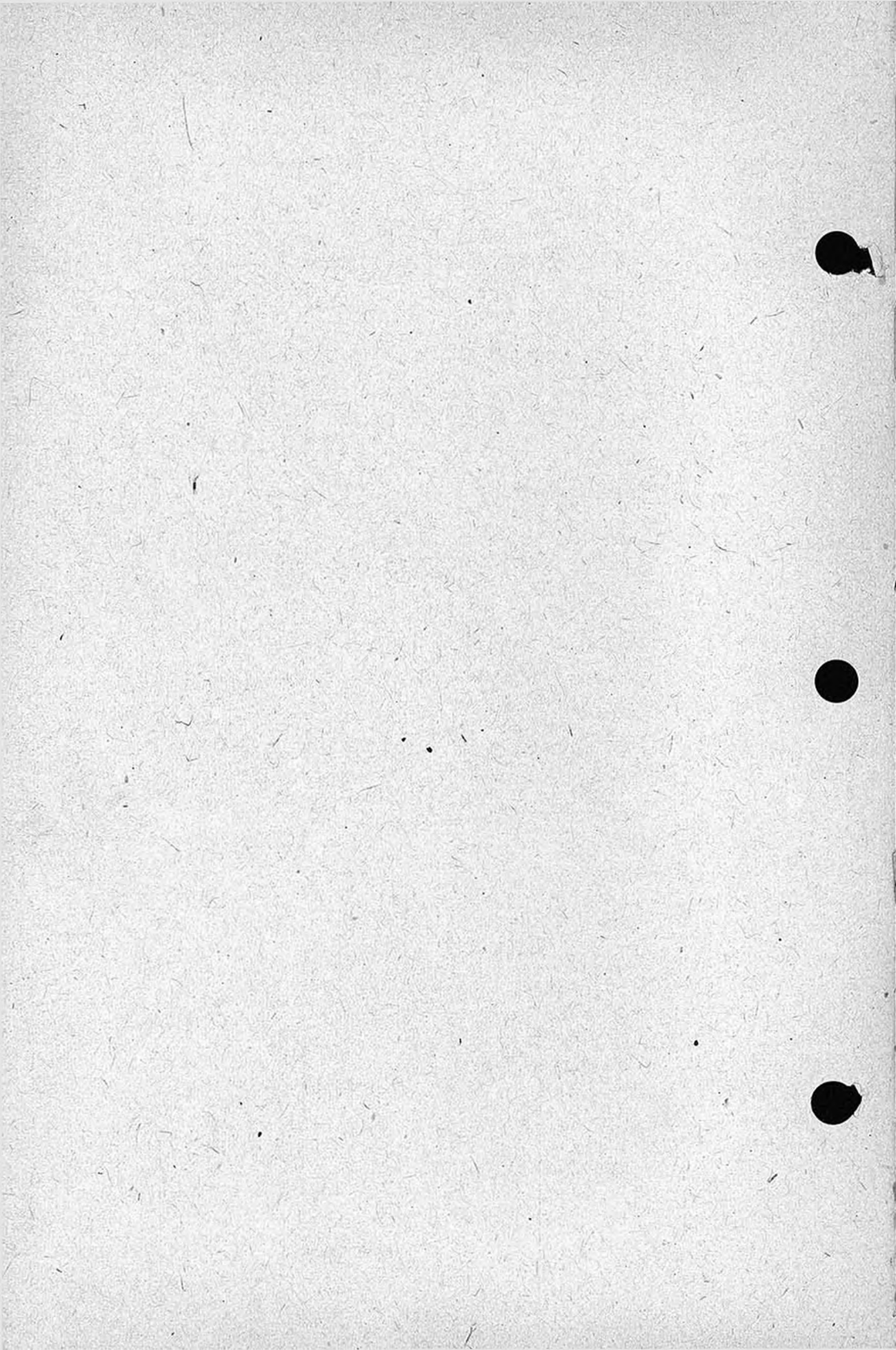

BRITISH TIME PENCIL

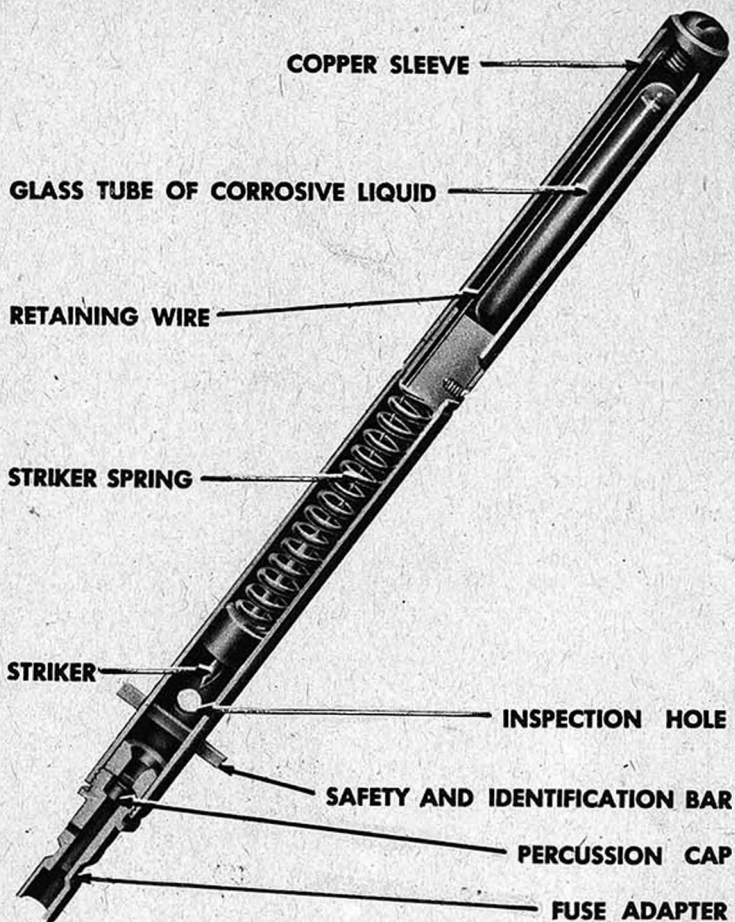

TYPE. Delay fuze

SHAPE. Pencil

MATERIALS. Aluminum and copper

FUNCTIONING

1. Action starts when copper sleeve is crushed and ampoule broken.
2. Acid attacks and eats through wire.
3. Spring drives released striker against percussion cap.

RE-USE

If you can see through inspection holes, or insert a nail through them, the striker is cocked. If sleeve has been crimped, discard. If sleeve is intact, unscrew cap and see whether capsule is intact. If so, time pencil can be re-used.

BRITISH TIME PENCIL

EMPLOYMENT

1. For delay effect, so a charge can be left to go off after a time interval.
2. To light safety fuse, which, when pared slightly, will fit into adapter.
3. To set off directly a detonator crimped over adapter.

TIMING

Approximate times of delay are shown by colors on safety strip. Following table shows variation of delay with temperature:

Temperature °C.	Red	White	Green	Yellow	Blue	Temperature °F.
-20	75 min.	19 hr.	3 $\frac{1}{4}$ days	10 days	—	-4
-10	63 min.	13 hr.	2 $\frac{1}{2}$ days	5 days	—	14
0	43 min.	5 hr.	16 hr.	28 hr.	—	32
10	31 min.	2 $\frac{3}{4}$ hr.	8 hr.	18 hr.	34 hr.	50
15	27 min.	2 hr.	5 $\frac{3}{4}$ hr.	12 hr.	24 hr.	59
20	23 min.	1 $\frac{1}{2}$ hr.	4 hr.	9 hr.	20 hr.	68
25	19 min.	1 $\frac{1}{4}$ hr.	3 hr.	6 hr.	15 hr.	77
37 $\frac{1}{2}$	12 $\frac{1}{2}$ min.	$\frac{3}{4}$ hr.	1 $\frac{1}{2}$ hr.	3 hr.	6 hr.	99 $\frac{1}{2}$
43	9 $\frac{1}{2}$ min.	34 min.	80 min.	2 hr.	5 hr.	109 $\frac{1}{2}$

Above times may vary 25 percent either way. Do not use fuze marked with blue if temperature is likely to be below freezing when explosion is due to occur. Fuze marked with black, with 10-minute delay, is issued for training only.

INSTALLING AND ARMING

1. Refer to table and select proper delay fuze.
2. Look through or pass nail through inspection holes to see striker has not fallen.
3. Connect charge.
4. Crimp copper sleeve flat. Do not bend or crush hard enough to fracture copper sleeve.
5. Withdraw safety strip.
6. Use two fuzes for each important charge.

DISARMING

Cannot be disarmed safely. If essential to disarm, insert safety strip through inspection holes, or cut fuze.

DEFUZING

After inserting safety strip remove time pencil from charge.

PACKING AND TRANSPORTING

Five per tin. 150 tins per case about 16 by 13 by 8 inches. Weight, 57 $\frac{1}{2}$ pounds.

U. S. ANTITANK MINE M1A1

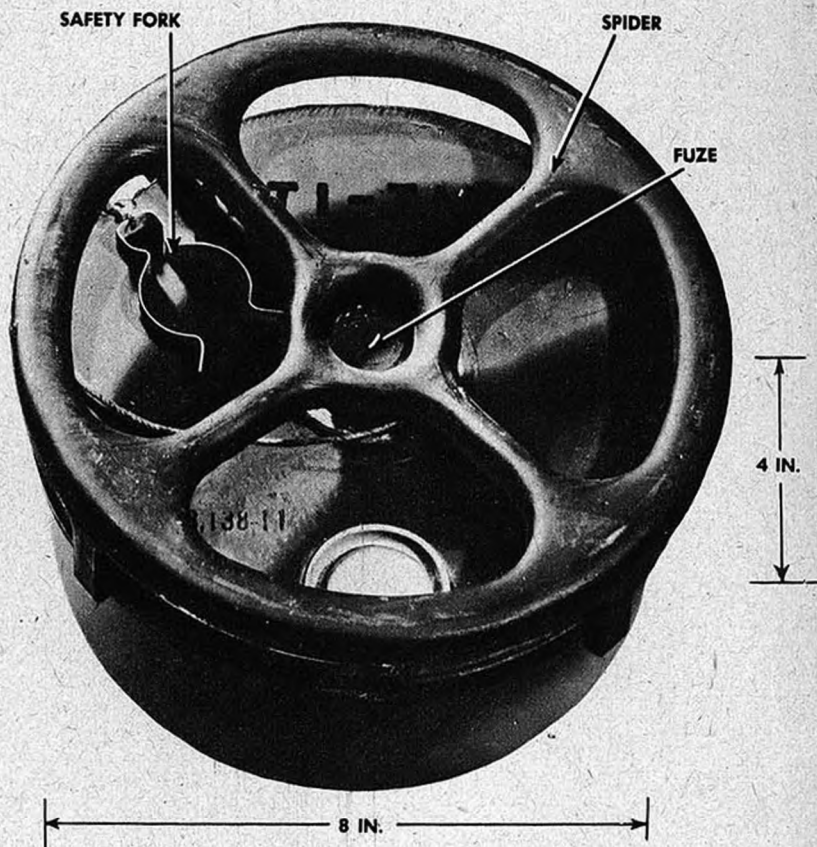

TYPE. Antitank

COLOR. Olive-drab, yellow, or olive-drab with yellow band and bottom

CASE. Steel

WEIGHT. 10 $\frac{2}{3}$ pounds

EXPLOSIVE. 6 pounds cast TNT

EFFECT. Disables tanks

U. S. ANTITANK MINE M1A1

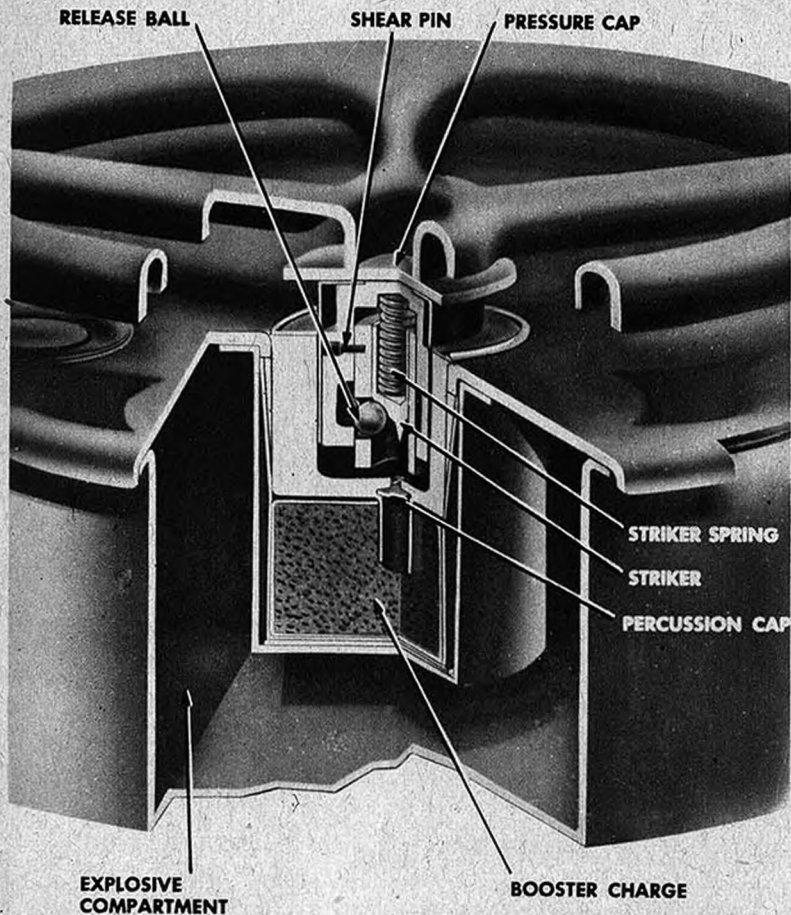

FUNCTIONING

1. Pressure of 500 pounds directly on fuze head, or 250 pounds on edge of spider, depresses outer sleeve, cutting shear pins and aligning holes in outer sleeve with steel balls lodged in inner sleeve.
2. Steel balls are forced into holes in outer sleeve releasing striker.
3. Striker thus freed, driven by striker spring, sets off percussion cap detonator—booster—main charge.

RE-USE

Examine mine and fuze carefully for signs of rusting, corrosion, or damage to mine case or fuze assembly. If there is no visual sign of damage or misuse the mine may be considered to be in satisfactory condition for re-use.

U. S. ANTITANK MINE M1A1

INSTALLING AND ARMING



To assemble mine

1. Remove spider.
2. Place fuze in cavity of mine body.
3. Hook two legs of spider under rim.
4. Pass other two legs of spider through notches and turn spider one-eighth of a turn.

To lay mine on surface of ground

1. Place mine on ground.
2. Remove safety fork.
3. Conceal mine with loose brush or other material.

TO BURY MINE WITH SPIDER UP

1. Remove thin layer of sod and place on a sandbag.
2. Dig hole, placing spoil in sandbag.
3. Remove safety fork.
4. Place mine in cover. Cover must be loose over spider.
5. Place mine in hole.
6. Fill in, with spider at least $\frac{1}{4}$ inch above original ground level, and pack earth around sides of mine.
7. Replace sod, and complete camouflage.

TO BURY MINE WITH SPIDER DOWN

1. Remove thin layer of sod and place it on a sandbag.
2. Dig hole, placing spoil in sandbag.
3. Remove safety fork from mine.
4. Place mine in cover. Cover must be loose over spider.
5. Place mine in hole, spider down, with upper surface not more than 1 inch below ground surface.
6. Replace spoil to original ground level.
7. Replace sod, and camouflage.

U. S. ANTITANK MINE M1A1

DISARMING AND REMOVING

1. Cut away cover to reveal fuze.
2. Replace safety fork, if fuze is not damaged.
3. Check for booby-trapping devices.
4. Lift mine.

CAUTION

If mine field has been in enemy's hands, treat it as enemy field. If field has been subjected to blast, or if safety fork does not go on easily, do not attempt to force on fork, or to remove mine by hand. Attach a 50-yard rope or wire, drag mine to safe place, and destroy with explosives; or, destroy in place.

DEFUZING

After disarming and lifting mine, remove spider and lift fuze from cavity.

PACKING AND TRANSPORTING

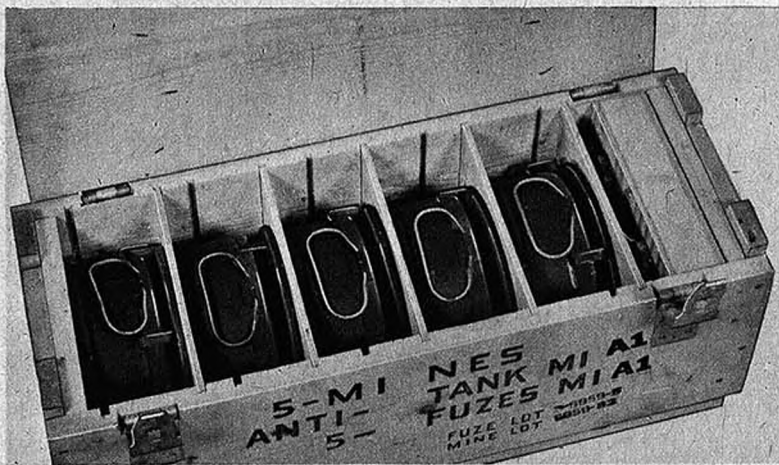

Mines are packed in a wooden case holding five mines, five fuzes, and five covers. Case is divided into six compartments by separators which can be removed and used as bases for the mines in soft soil. Fuzes are in compartment at one end of case. One mine is in each of the other compartments. Separators can be moved to other positions in case, dividing it into five equal compartments for carrying fuzed mines. Safety forks always are left on fuzes during transporting and handling. Case measures about 10 by 10½ by 26 inches. Loaded with five mines and fuzes, case weighs 71 pounds. When mines are transported without packing in wooden cases place on edge.

U. S. ANTITANK MINE M1

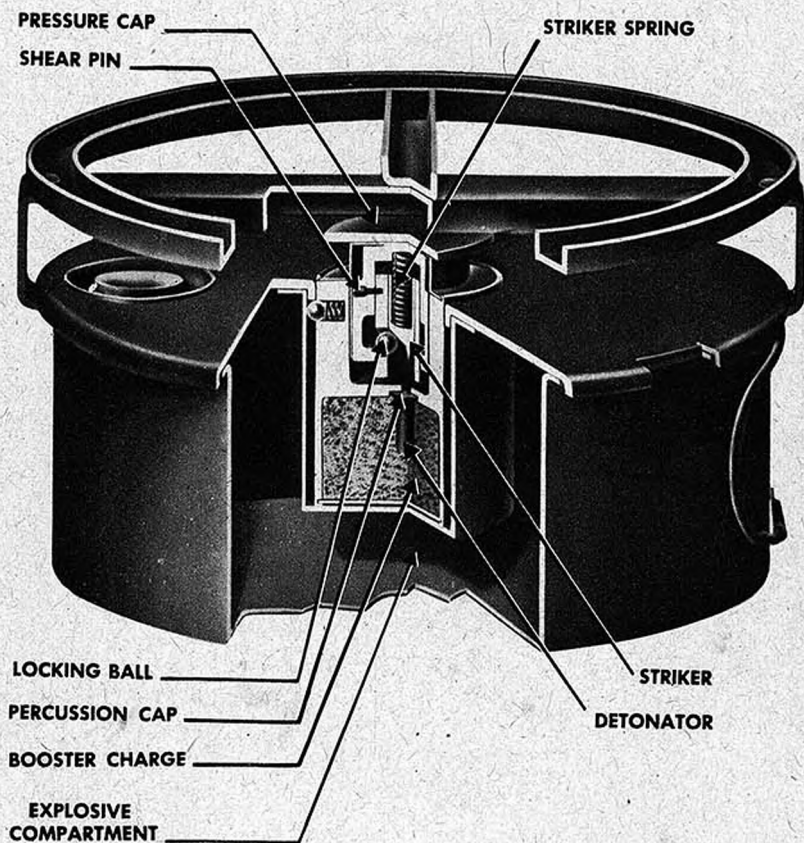

The antitank mine M1, the original model, is no longer being manufactured or issued. It is handled exactly the same as the antitank mine M1A1.

U. S. ANTITANK MINE M1

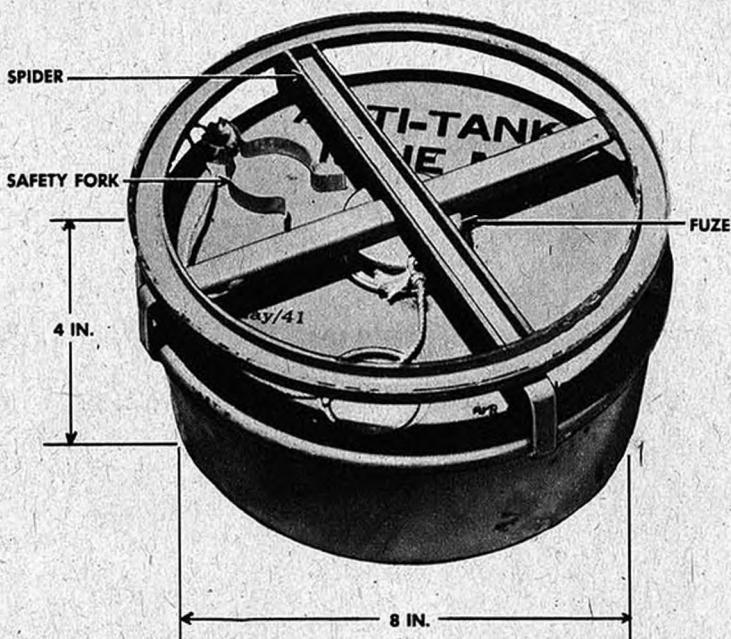

The principal difference between the two models is that in the mine M1 the booster is an integral part of the fuze; in the mine M1A1 the booster is a separate part.

PACKING AND TRANSPORTING

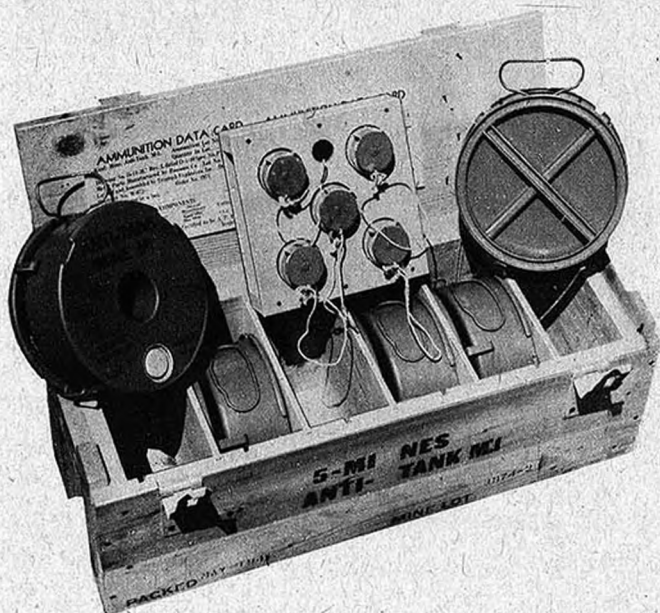

U. S. ANTITANK MINE M5

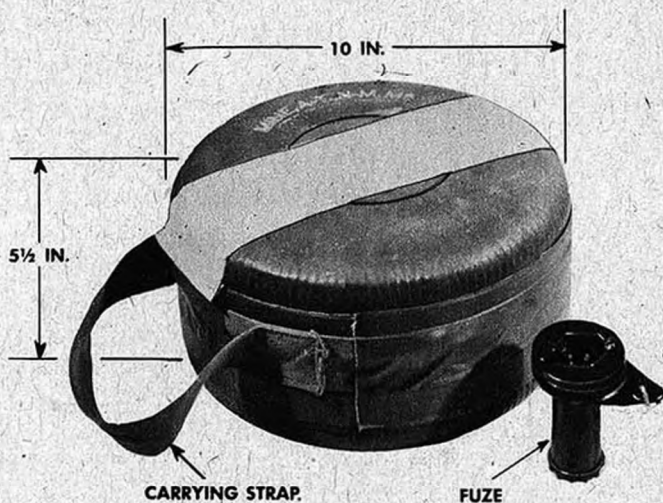

TOP VIEW

BOTTOM FUZE WELL
WITH PROTECTING PLUG

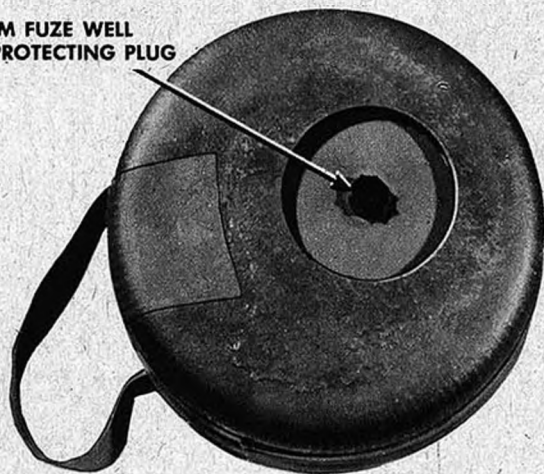

BOTTOM VIEW

TYPE. Antitank

COLOR. Olive-drab

CASE. Nonmetallic

WEIGHT. Approximately 14.5 pounds

EXPLOSIVE. 5.6 pounds, tetrytol or TNT

EFFECT. Disables tanks, destroys vehicles

U. S. ANTITANK MINE M5

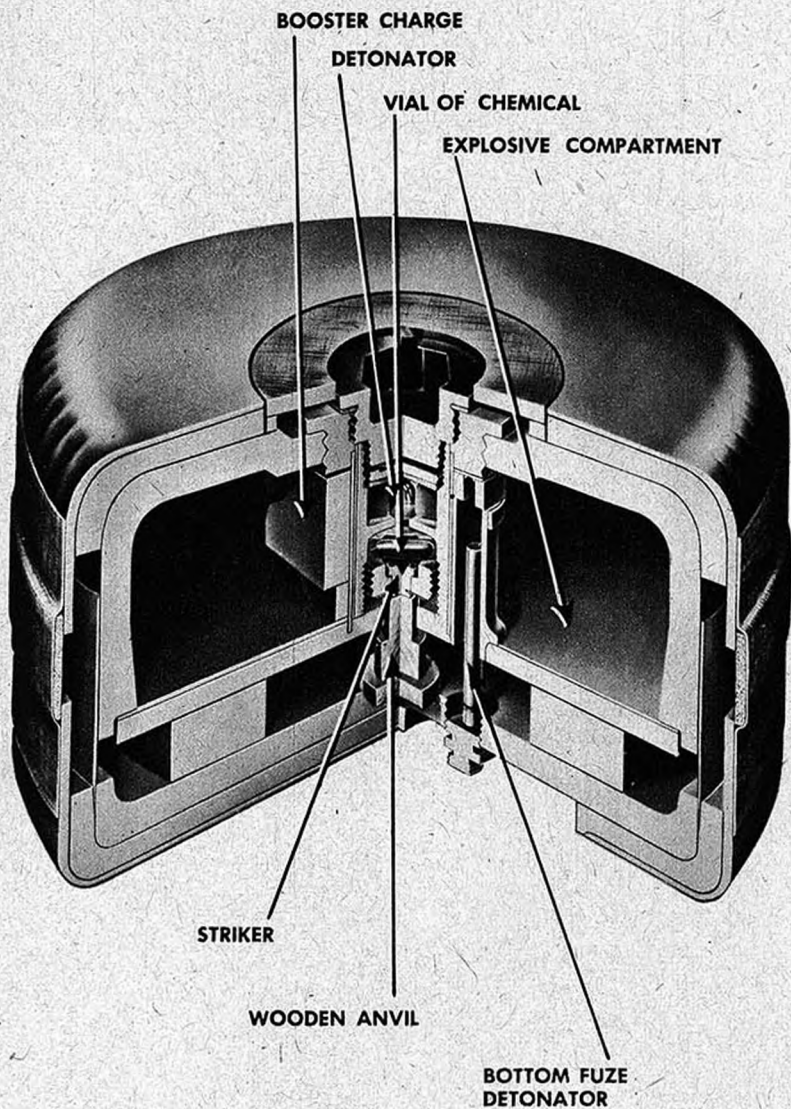

FUNCTIONING

1. A pressure of 275 to 425 pounds causes striker, bearing on wooden anvil, to break glass vial containing chemical.
2. Mixture of chemical in glass vial with chemical substance surrounding the vial causes flash.
3. Flash created by mixture of chemicals sets off detonator—booster—main charge.

U. S. ANTITANK MINE M5

INSTALLING AND ARMING



1. Unscrew safety cap from base of fuze and examine fuze to see that it is not broken or otherwise unserviceable.



2. Remove adhesive cover from fuze cavity and see cavity is free of foreign material. Insert fuze into cavity and screw tight by hand.



3. Place mine in hole with its surface not more than 1 inch below original ground surface. Remove safety ring.



4. Screw fuze tight by hand.

5. Pack earth around sides of mine, and camouflage.

U. S. ANTITANK MINE M5

DISARMING

1. Check mine for booby-trapping devices.
2. Lift mine.

DEFUZING

1. Remove fuze from mine.
2. Replace safety cap on base of fuze.

PACKING AND TRANSPORTING

Mines are packed in a wooden case holding four mines and four fuzes. Case is divided into four compartments by removable separators. One fuze, in individual container, and one mine, are packed in each of the four compartments. Loaded with four mines and fuzes, case weighs 87 pounds. It measures about 12 by 13 by 26 inches.

RE-USE

Mines may be re-used any number of times provided the fuzes and mines are not damaged, and do not show evidence of deterioration.

SPACE FOR NOTES

U. S. ANTIPERSONNEL MINE M2A1

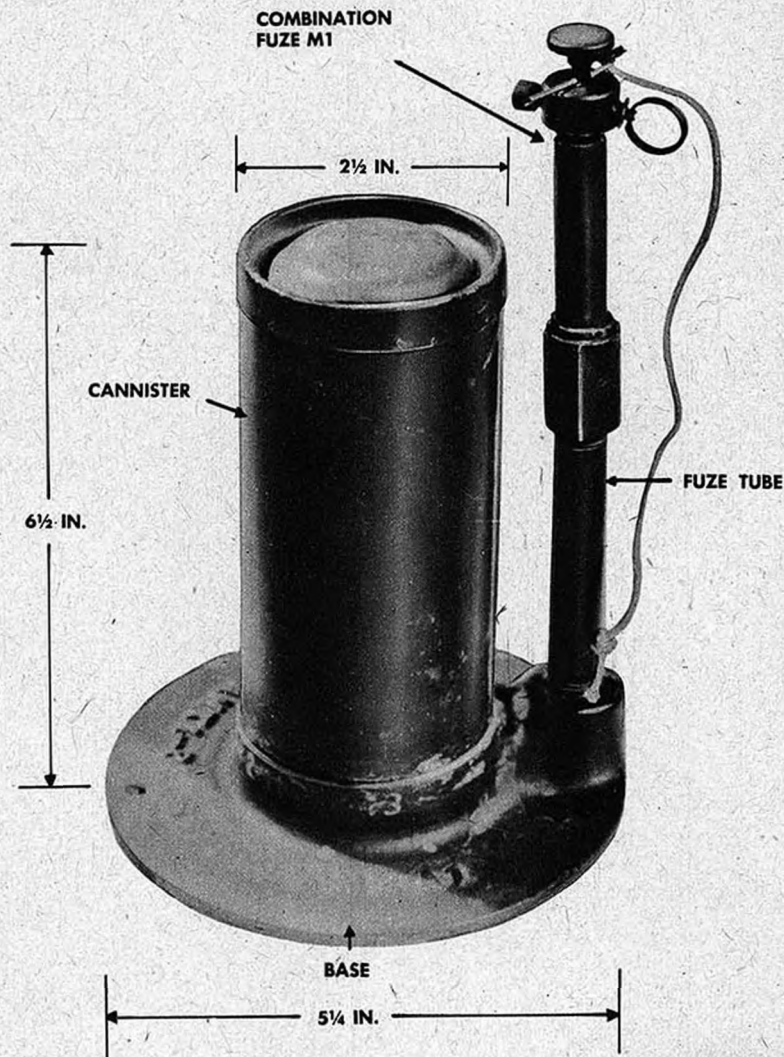

TYPE. Antipersonnel fragmentation

COLOR. Both tubes, olive-drab; base flange, black with yellow marking

CASE. Steel

WEIGHT OF SHELL. 3 pounds

EXPLOSIVE. 0.4 pound

EFFECT. Casualties to most personnel within 10 yards, dangerous to 150 yards.

U. S. ANTIPERSONNEL MINE M2A1

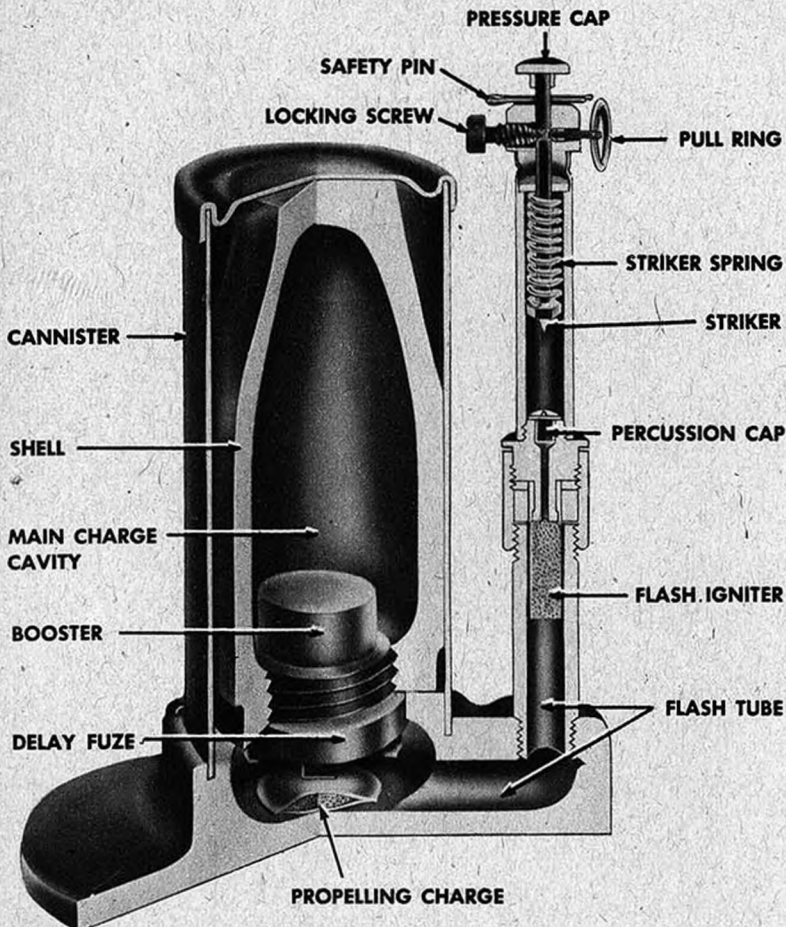

FUNCTIONING

1. Pressure of 20 pounds on pressure cap, or pull of 3 to 6 pounds on pull ring, releases striker.
2. Striker, driven by spring, sets off percussion cap, which fires igniter, which sets off propelling charge.
3. Explosion of propelling charge ejects shell from tube and, at same time, ignites delay fuze in base of shell.
4. When shell is 6 to 8 feet from tube, delay fuze detonates explosive in shell, throwing fragments in all directions.

INSTALLING AND ARMING TO ASSEMBLE

1. Test fuze by testing safety pin for free movement when locking screw is removed.

U. S. ANTIPERSONNEL MINE M2A1



2. Remove percussion-cap cover and screw fuze in place.

TO INSTALL WITH TRIP WIRES

1. Place mine in hole so release-pin ring of fuze barely projects above ground surface, and pack dirt around mine.
2. Install trip wires by attaching them first to anchor stakes and then to pull ring.
3. Remove locking screw from fuze.
4. Place cord from safety pin in position convenient for removal, and camouflage installation.

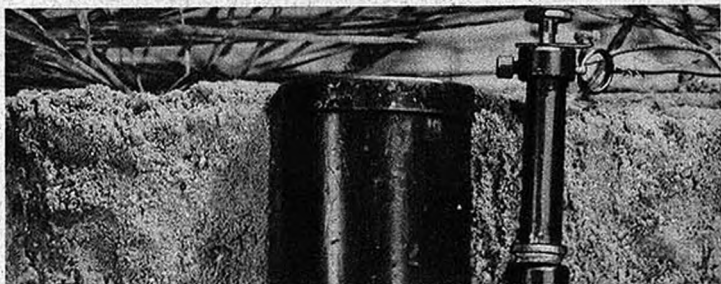

5. Remove safety pin by pulling on cord attached to it.

TO INSTALL FOR PRESSURE OPERATION



1. Place mine in hole so top of pressure cap is about $\frac{1}{4}$ inch below ground surface, and pack dirt around and above mine up to level of locking screw.
2. Place cord from safety pin in position convenient for removal, and remove locking screw.
3. Complete covering and camouflage of mine.

U. S. ANTIPERSONNEL MINE M2A1



4. Remove safety pin by pulling on cord attached to it. Effective pressure area can be increased by installing pressure board to bear on pressure cap of fuze.

DISARMING AND REMOVING

TRIP-WIRE INSTALLATION

1. Insert safety pin and locking screw.
2. Disconnect trip wires.
3. Check for booby traps and lift mine.

PRESSURE INSTALLATION

1. Remove pressure board.
2. Insert safety pin and locking screw.
3. Check for booby traps and lift mine.

DEFUZING

After disarming and lifting, remove fuze from mine and replace percussion-cap cover. Return mine and fuze to original package.

PACKING AND TRANSPORTING

Each mine is packed in corrugated paper carton also containing one combination fuze without base and one spool of four 26-foot lengths of trip wire. Ten containers are packed in wooden box about 10 by 13 by 32 inches, weight, 93 pounds.

RE-USE

Mine may be re-used any number of times if not damaged or deteriorated. Do not use mines if either firing base containing percussion cap, or cap covering tube, is loose.

CAUTION

Never rotate release ring when both safeties are not in position as even a quarter-turn may release firing pin.

U. S. ANTIPERSONNEL MINE M3

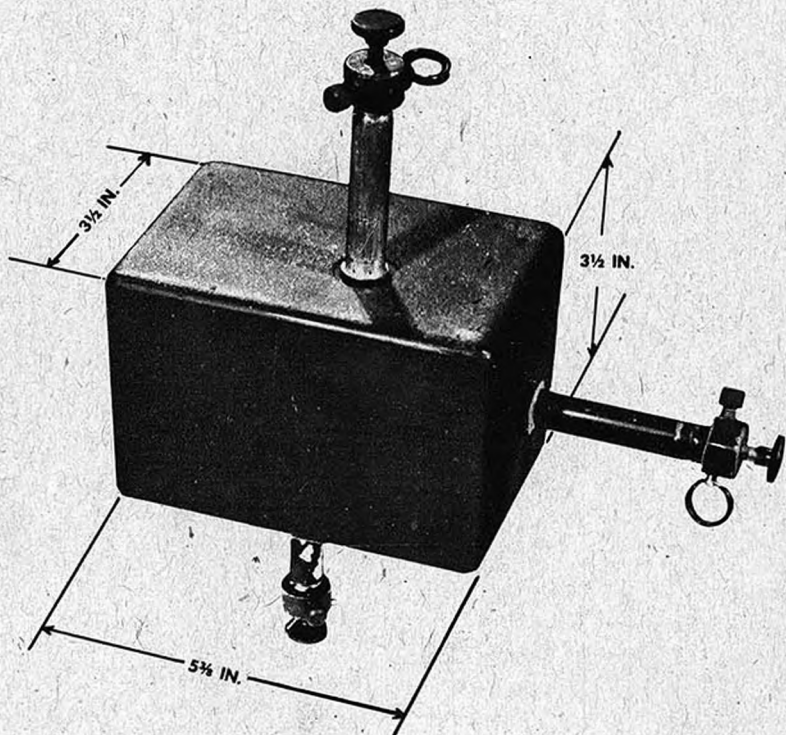

TYPE. Antipersonnel

COLOR. Olive-drab

CASE. Cast iron

WEIGHT. 9.6 pounds

EXPLOSIVE. 0.9 pound flaked TNT

EFFECT. Casualties to all personnel within 10 yards. Dangerous up to 100 yards.

U. S. ANTIPERSONNEL MINE M3

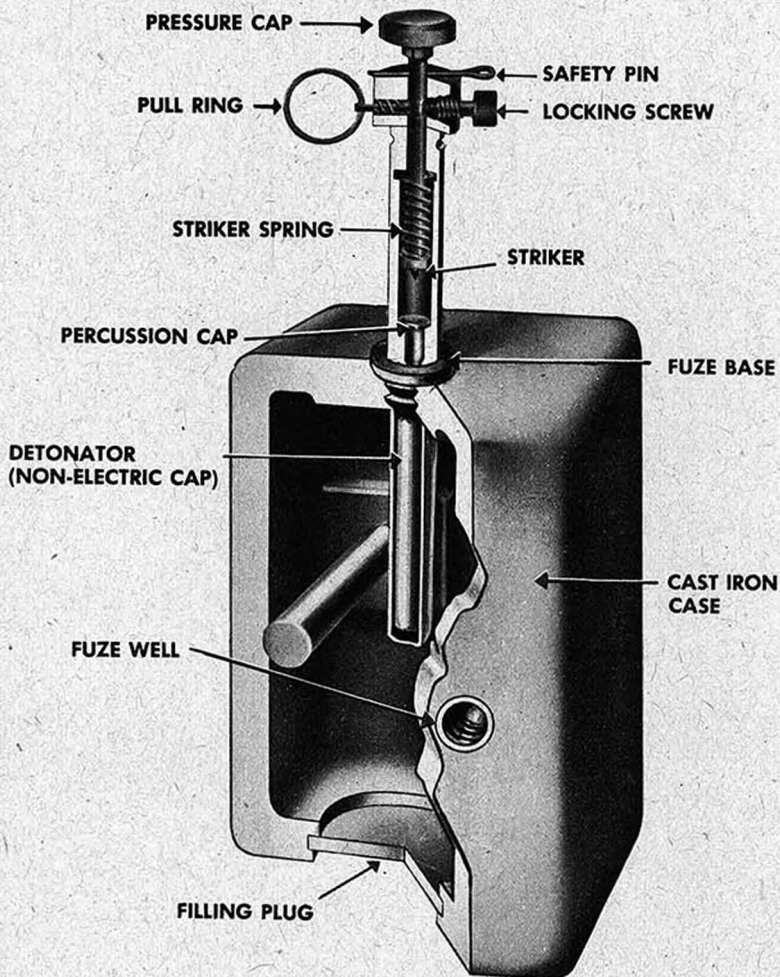

FUNCTIONING

1. Pull of 3 to 6 pounds on pull ring, or pressure of 20 pounds on pressure cap, releases striker.
2. Striker, driven by spring, fires percussion cap.
3. Flash from percussion cap detonates nonelectric cap crimped on base of fuze.
4. Detonation of nonelectric cap explodes high-explosive filler in mine, throwing fragments in all directions.

U. S. ANTIPERSONNEL MINE M3

INSTALLING AND ARMING



WITH TRIP WIRES

1. Test fuze by testing safety pin for free movement when locking screw is removed.
2. Remove plastic plug from one cap well by using wrench packed with mines and screw in fuze with nonelectric cap attached.

3. Tie mine to stake.
4. Install loose trip wires by attaching them first to anchor stakes and then to pull ring of fuze.
5. Remove locking screw from fuze.
6. Camouflage installation.
7. Remove safety pin.

FOR PRESSURE OPERATION

1. Test and attach fuze as above.

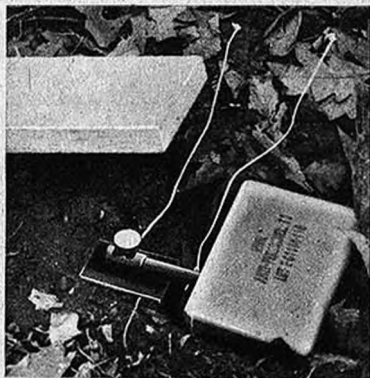

2. Place mine in hole with top of pressure cap just below ground level.
3. Place string from safety pin in place convenient for removal, and remove locking screw from fuze.
4. Place pressure board to bear on pressure cap.
5. Cover and camouflage.
6. Remove safety pin by pulling on string attached to it.

U. S. ANTIPERSONNEL MINE M3

DISARMING AND REMOVING

TRIP-WIRE INSTALLATION

1. Replace safety pin and locking screw.
2. Disconnect trip wires.
3. Lift mine.

PRESSURE-ACTUATED INSTALLATION

1. Remove pressure board.
2. Replace safety pin and locking screw.
3. Lift mine.

DEFUZING

After disarming and removing, remove fuze from mine and replace plastic plug covering cap well. Return both mine and fuze to original containers.

PACKING AND TRANSPORTING

Six mines and six combination fuzes M1 with nonelectric caps attached are packed in wooden case weighing 72 pounds when loaded and measuring about 9 by 9 by 18 inches. Fuzes are contained in individual, sealed, cylindrical, fiber containers, packed in compartments at one end of case. Case also contains wrench for removing plastic plugs in mines, and six 26-foot spools of trip wire. Cases are marked "Olive-drab" or "Sand color" to indicate color or wire packed therein.

RE-USE

Mine may be re-used any number of times if not deteriorated or damaged.

CAUTION

Never rotate pull ring when safeties are removed, for as little as a quarter-turn may release firing pin.

SPACE FOR NOTES

U. S. PRESSURE FUZE M1A1

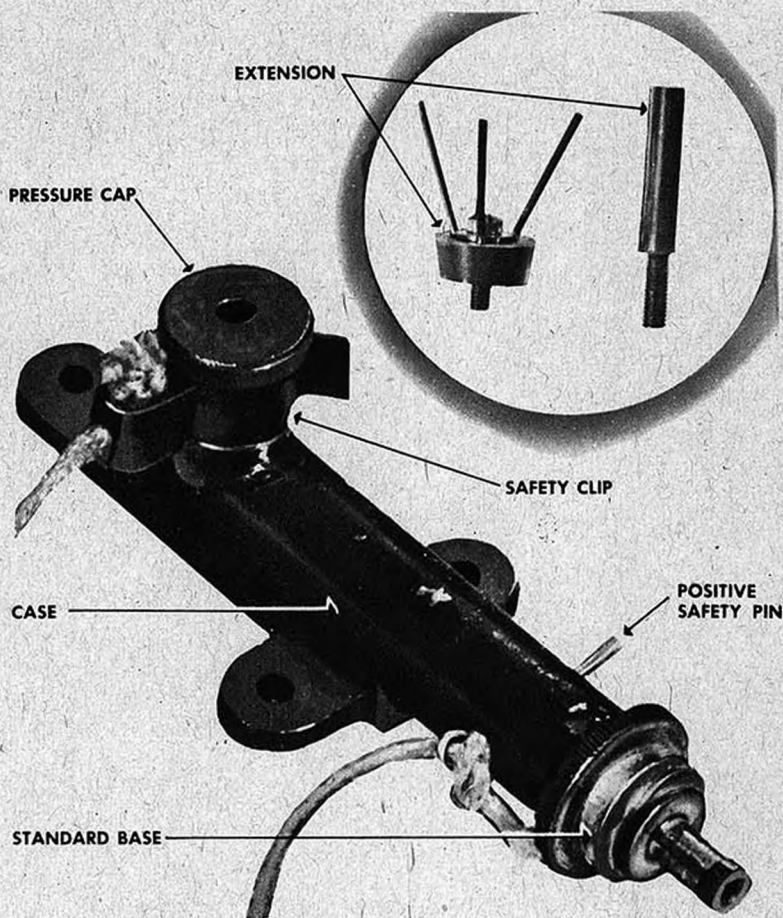

TYPE. Pressure fuze

COLOR. Olive-drab

CASE. Alloy metal

EMPLOYMENT. In antipersonnel mines and booby traps

U. S. PRESSURE FUZE M1A1

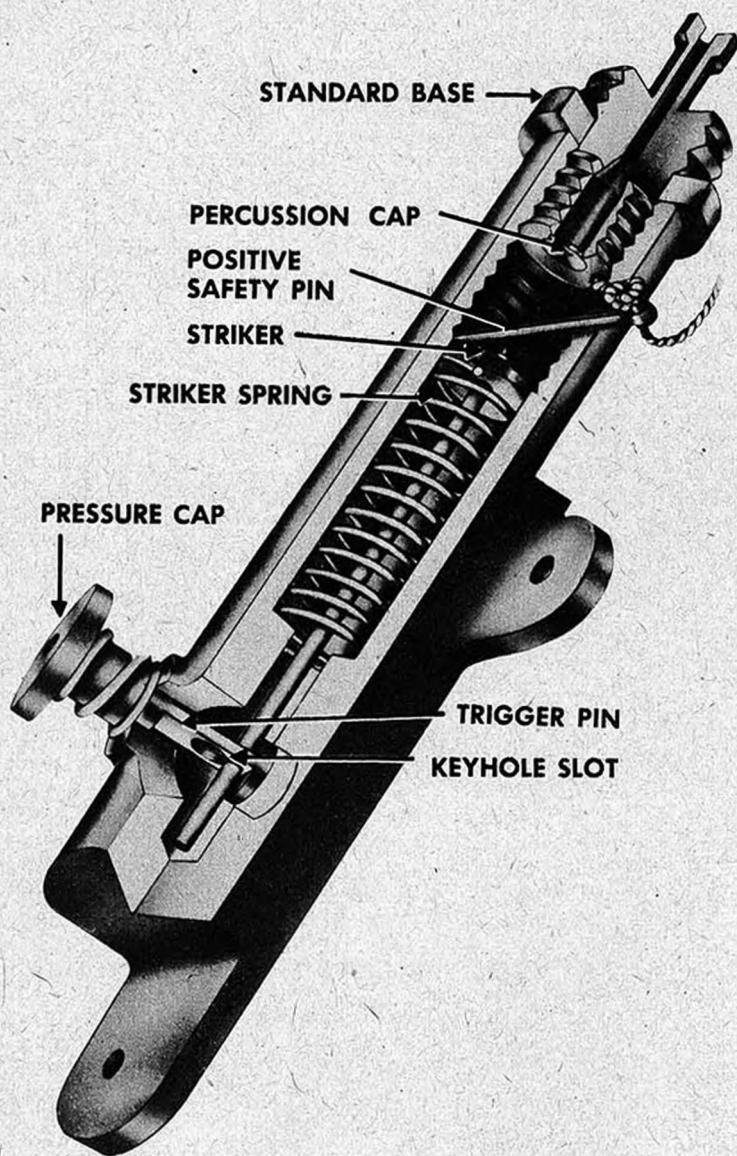

FUNCTIONING

1. Pressure of 20 or more pounds on pressure cap compresses trigger spring and pushes trigger pin into barrel.
2. When enlarged portion of keyhole slot in trigger pin is in position, striker is released.
3. Striker, driven by striker spring, fires percussion cap.

U. S. PRESSURE FUZE M1A1

TESTING

1. Remove and invert base so projection is inside case, facing striker.
2. Remove safety clip and positive safety pin.
3. Apply pressure to pressure cap. Striker should strike base sharply.
4. Recock by pushing striker with unsharpened pencil or small rod, at same time pressing on pressure cap so spindle can pass through larger part of keyhole.
5. Release pressure on pressure cap to allow smaller part of keyhole to engage reduced section of striker spindle.
6. Replace safety pin and clip.

INSTALLING AND ARMING

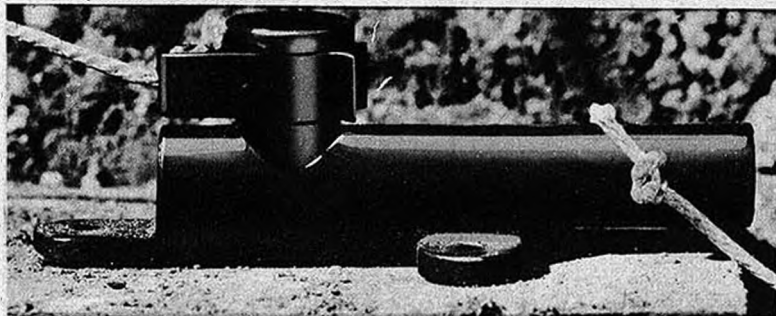

1. Remove base.
2. Place fuze on firm, flat base.
3. If adjustment rod is needed, screw it into pressure cap. Adjust by screwing up adjustment rod snugly against object, then back off one-quarter turn. If three-prong attachment is to be used, screw it into pressure cap.
4. Remove cardboard protector tube and crimp a U. S. non-electric cap onto base.

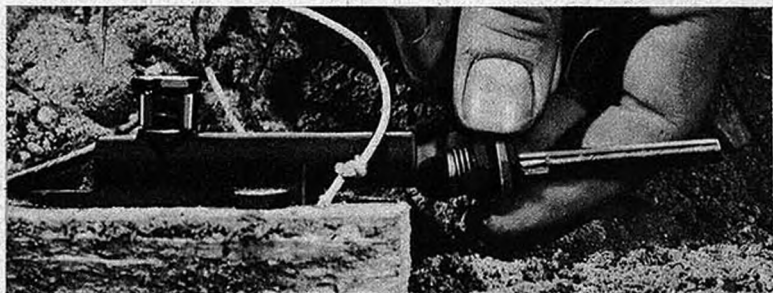

5. Screw base to fuze.
6. Insert cap in charge. When detonating cord is used, tape one end of it to cap and run other end to charge.

U. S. PRESSURE FUZE M1A1

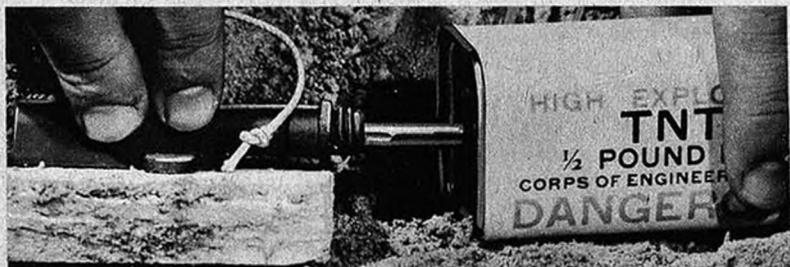

7. Remove safety clip. It should pull off easily. A sudden jerk may cause fuze to fire. If safety clip does not pull off easily, check installation to make sure there is no pressure on pressure cap.

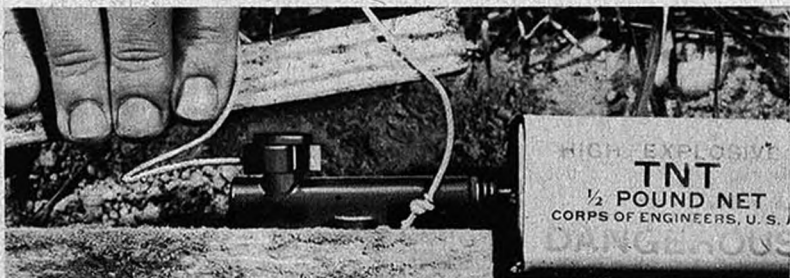

8. Remove safety pin. If pin does not come out easily, striker head probably has fallen and is pressing against it. Unscrew base and check mechanism. If defective, discard fuze and use another.

DISARMING

Replace safety pin and safety clip.

DEFUZING

1. After replacing safety pin and clip, detach fuze from charge.
2. Unscrew and destroy base or store in safe place. *Do not attempt to remove cap from base.*

PACKING AND TRANSPORTING

Five fuzes, complete with percussion caps, are packed in a box. Full box weighs 1 pound 14 ounces. Size $5\frac{1}{2}$ by $4\frac{3}{4}$ by $1\frac{5}{8}$ inches.

RE-USE

Fuzes may be re-used any number of times if tests prove them not defective. If percussion cap has been fired and device is to be used again, remove fired percussion cap and press a No. 3 cap firmly into place. Clean and lubricate fuze before re-using to insure proper functioning.

U. S. PULL FUZE M1

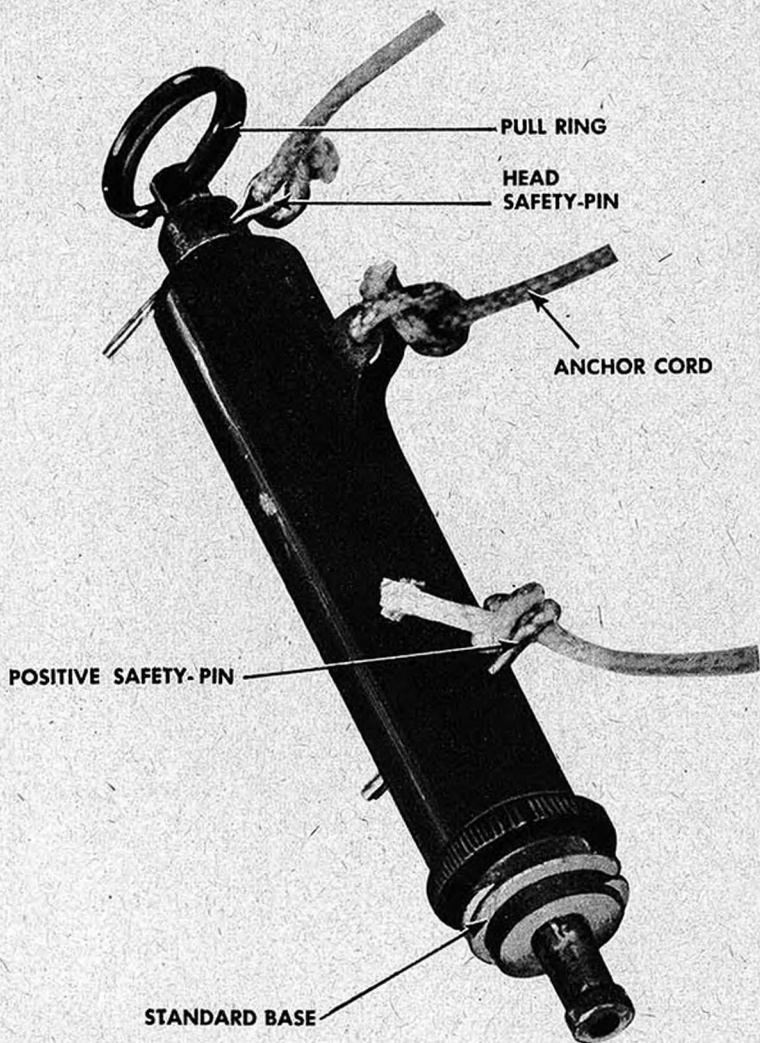

TYPE. Pull fuze

COLOR. Olive-drab

CASE. Alloy metal

EMPLOYMENT. In antipersonnel mines and booby traps

PACKING AND TRANSPORTING

Five fuzes, complete with percussion caps in their bases, and two 80-foot spools of trip wire, packed in watertight cardboard box, about 5 by 5 by 1½ inches. Loaded, weighs 1¼ pounds.

U. S. PULL FUZE M1

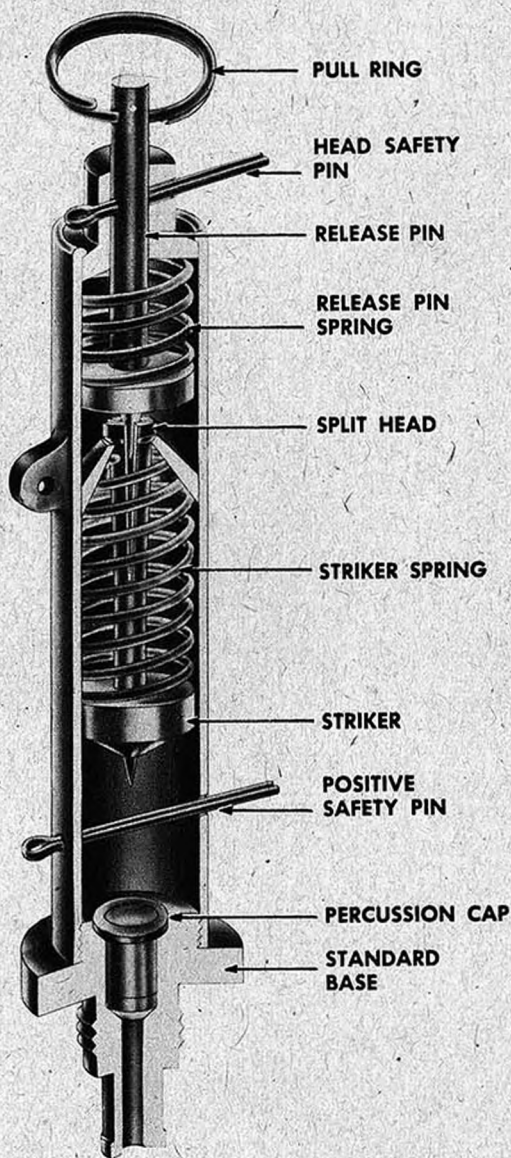

FUNCTIONING

1. Pull of 3 to 5 pounds on pull ring compresses loading spring and pulls release pin out of split head of striker.
2. This permits split head of striker to compress and slip through constriction in collar.
3. Striker thus released, driven by spring, sets off percussion cap.

U. S. PULL FUZE M1

TESTING

Test fuze before using, especially if new, since paint seal between case and release pin materially increases operating tension.

1. Remove and invert base so projection is inside case, facing firing pin.
2. Remove safety pin.
3. Pull the pull ring. Striker must strike base sharply.
4. Recock by pushing striker with unsharpened pencil or other blunt instrument until release pin slips into place.
5. Insert pins and screw in base.

INSTALLING AND ARMING

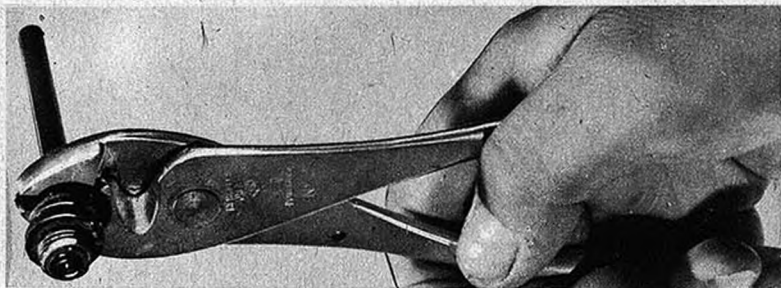

1. Remove base.
2. Remove cardboard protector from base, and crimp on a U. S. nonelectric cap.



3. Attach base to fuze.
4. Insert cap in charge or, if detonating cord is to be used, tape one end of detonating cord to cap, and run other end to charge.

U. S. PULL FUZE M1



5. Anchor charge or fuze with anchor cord.
6. Install loose trip wire, attaching anchor end first.



7. Remove head safety pin. If it does not pull out easily probably trip wire is too tight. Check. If pin still binds, remove base and check mechanism. If defective, discard fuze and use another.
8. Remove positive safety pin. It should come out easily; if not, striker head probably has fallen and is pressing on it. Unscrew base and check mechanism. If defective, discard fuze and use another.

DISARMING

1. Insert both safety pins.
2. Disconnect trip wires.

DEFUZING

1. Remove fuze and cap from charge.
2. Unscrew base and destroy it, or store in safe place. *Do not attempt to remove cap from base.*

RE-USE

Fuzes may be re-used any number of times if tests show they are not defective. If percussion cap has been fired, and fuze is to be used again, remove cap and press new No. 3 cap tightly into place. Clean and lubricate before re-use.

U. S. RELEASE FUZE M1

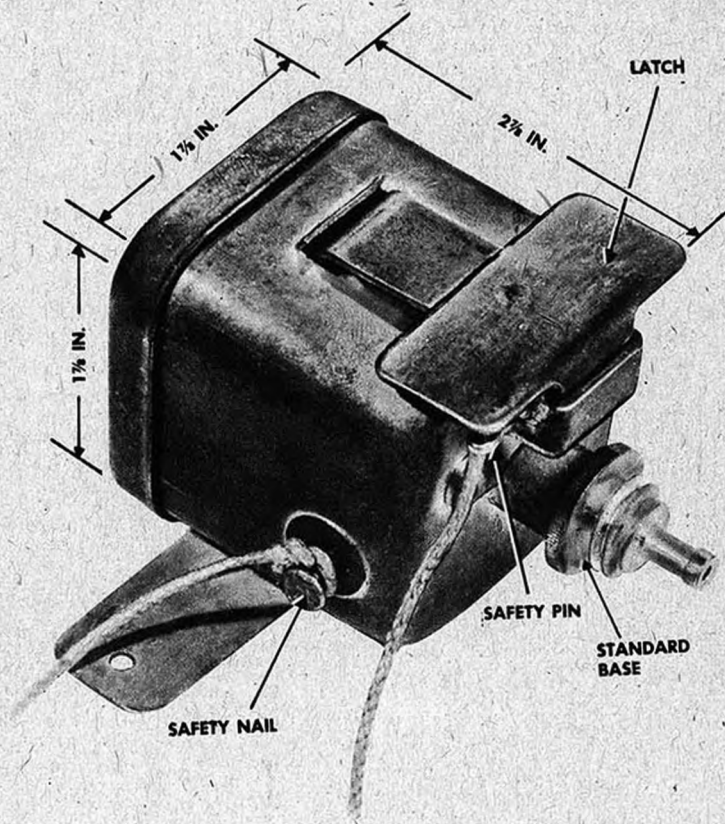

TYPE. Release fuze
COLOR. Unpainted
CASE. Alloy metal

EMPLOYMENT. In antipersonnel mines and booby traps.

U. S. RELEASE FUZE M1

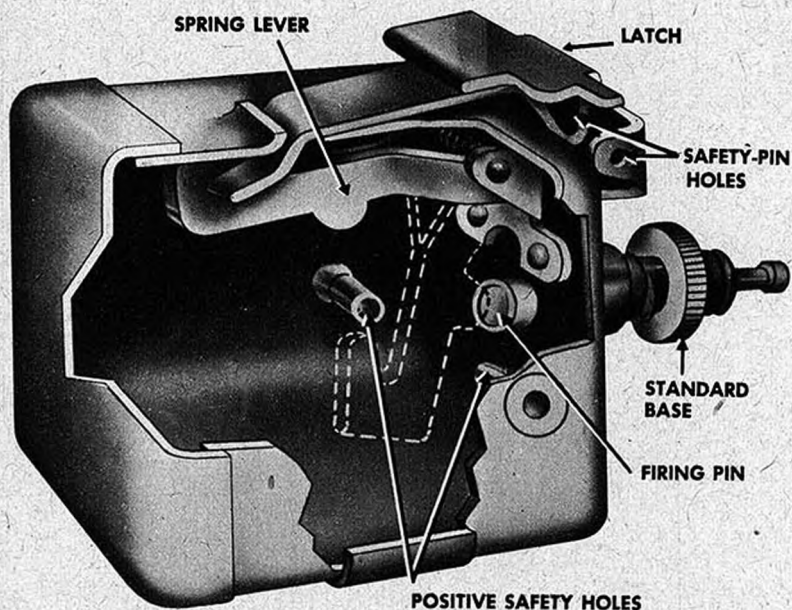

FUNCTIONING

1. When restraining load of at least 2 pounds is removed, latch releases spring lever.
2. Lever, propelled by spring, swings down and strikes firing pin.
3. Impact of firing pin fires percussion cap.

TESTING

1. Unscrew base.
2. Hold fuze in one hand, press downward on latch, remove safety pin.
3. Release pressure on latch. Spring lever should strike firing pin.
4. To recock, remove lid.
5. Pull spring lever back and catch with latch hook. At same time lower forward end of latch into bracket.
6. When hole in latch lines up with hole in bracket, insert safety pin.
7. Replace lid.
8. Screw on base.

INSTALLING AND ARMING



1. Place nail in safety holes.
2. Remove base.



3. Remove cardboard protector from base, and crimp on U. S. nonelectric cap.
4. Screw base to fuze.



5. Insert cap in charge or, if detonating cord is used, tape one end to cap and run other end to charge.

U. S. RELEASE FUZE M1

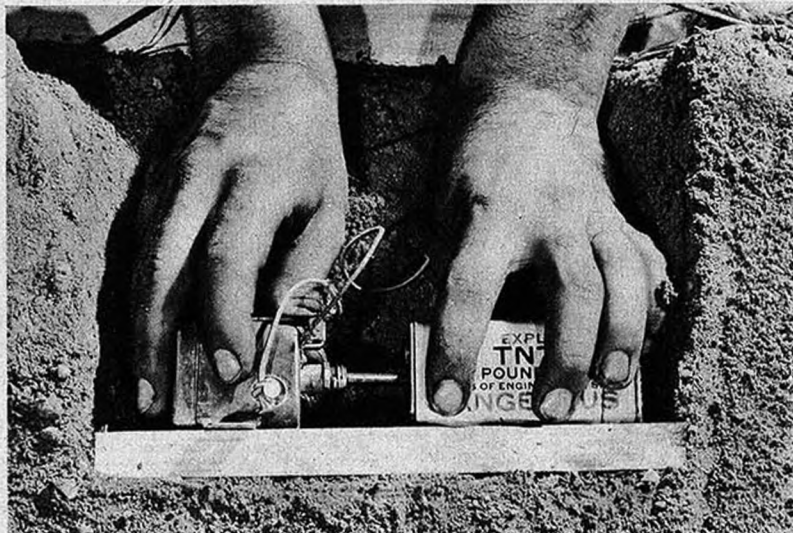

6. Provide level foundation for fuze to rest on.
7. Place restraining load on exposed surface of latch.
8. Gently remove safety pin by pulling attached string.
9. If no clicking sound is heard, pull out nail. If nail does not come out easily, spring lever probably has fallen. If so, remove charge, unscrew base, remove load, and check. If defective, discard fuze and use another.

DISARMING

1. Insert nail.
2. Insert safety pin.

DEFUZING

1. After inserting nail and safety pin, remove restraining load.
2. Remove fuze from charge.
3. Unscrew and destroy base, or store in a safe place. *Do not attempt to remove blasting cap from base.*

RE-USE

Fuzes may be re-used any number of times if tests prove them satisfactory. If percussion cap in fuze has been fired, and fuze is to be re-used, remove cap and press new No. 3 cap firmly into place.

U. S. DELAY FUZE M1

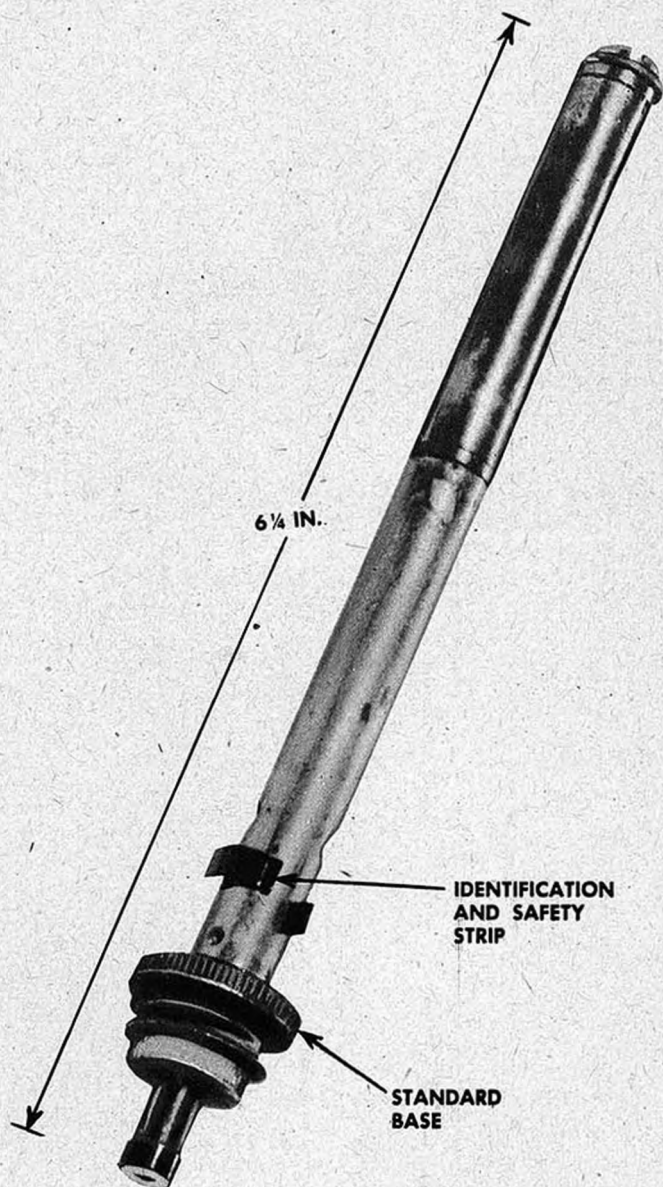

TYPE. Chemical delay fuze.

COLOR. Unpainted except for safety tab.

CASE. Upper half copper, lower half brass.

EMPLOYMENT. Delayed-action fuze for firing a delayed-action mine.

U. S. DELAY FUZE M1

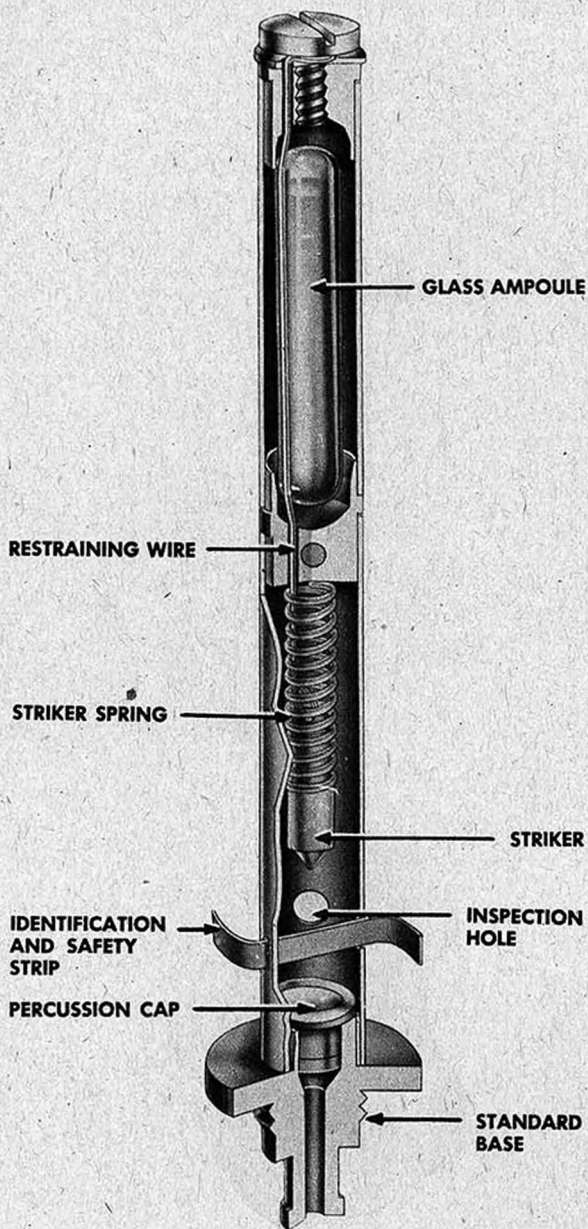

FUNCTIONING

1. When glass ampoule is crushed, corrosive liquid is released.
2. Corrosive liquid eats through restraining wire, releasing firing pin.
3. Firing pin, driven by spring, fires percussion cap.

U. S. DELAY FUZE M1

INSTALLING AND ARMING

THIS TABLE MUST NOT BE TAKEN TO THE SEA OR
FALL INTO ENEMY HANDS. DO NOT SHOW TO
PERSONNEL. DESTROY THIS TABLE AFTER IT HAS
PURPOSE.

Degrees F.	TEMPERATURE CORRECTION TABLE							
	Black	Red	White	Green	Yellow	Blue	Light Blue	Dark Blue
150	5 min.	4 min.	25 min.	1 hr.	1 hr.	2 1/2 hrs.	4 hrs.	6 hrs.
130	7 min.	6 min.	37 min.	1 1/2 hrs.	2 hrs.	4 hrs.	6 hrs.	8 hrs.
110	8 min.	7 min.	50 min.	2 hrs.	3 hrs.	6 hrs.	8 hrs.	10 hrs.
90	10 min.	10 min.	1 hr.	3 hrs.	4 hrs.	8 hrs.	10 hrs.	12 hrs.
70	12 min.	14 min.	1 1/2 hrs.	4 hrs.	5 hrs.	10 hrs.	12 hrs.	15 hrs.
50	14 min.	17 min.	2 hrs.	5 hrs.	6 hrs.	12 hrs.	15 hrs.	18 hrs.
30	1 hr.	1 hr.	3 hrs.	6 hrs.	8 hrs.	15 hrs.	18 hrs.	24 hrs.

1. Consult card found in each box for tab color that gives required delay at prevailing temperature.
2. Select a fuze with a safety strip of this color.
3. Look in or insert nail through inspection holes to make sure firing pin has not been released. Inspect portion of fuze that contains ampoule to see it has not been crushed.

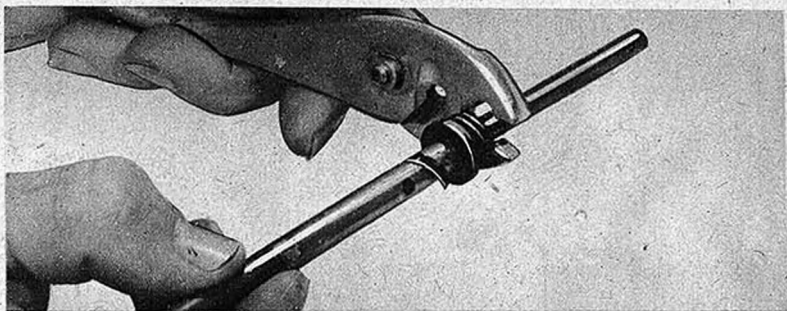

4. Crimp a U. S. nonelectric cap to base.

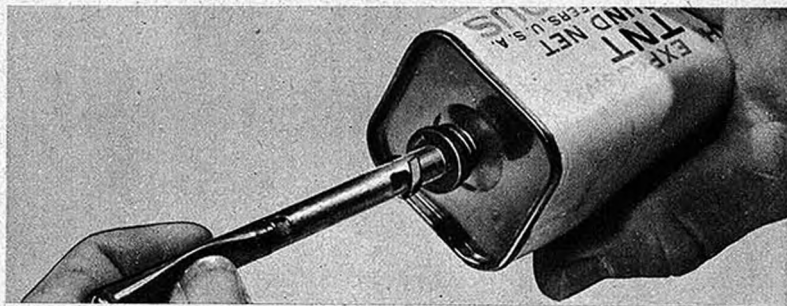

5. Insert cap in charge or, if detonating cord is used, tape one end to cap and run other end to charge.
6. Crush ampoule
7. Inspect through hole to see if striker has fallen.
8. Withdraw identification and safety strip.

U. S. DELAY FUZE M1

DISARMING

There is no safe way of disarming. If absolutely necessary to disarm, insert safety pin through inspection holes.

PACKING AND TRANSPORTING

Ten fuzes are packed in a box. Included are instructions for use and a table giving delays under various temperatures.

RE-USE

Once actuated, fuzes cannot be re-used.

CAUTION

Troops must not approach an installed charge employing this delay fuze. Areas where they have been installed should be marked. Time delay period starts when tube is squeezed, not when safety tab is withdrawn.

SPACE FOR NOTES

BOOBY-TRAPPING U. S. AT MINES, M1 AND M1A1

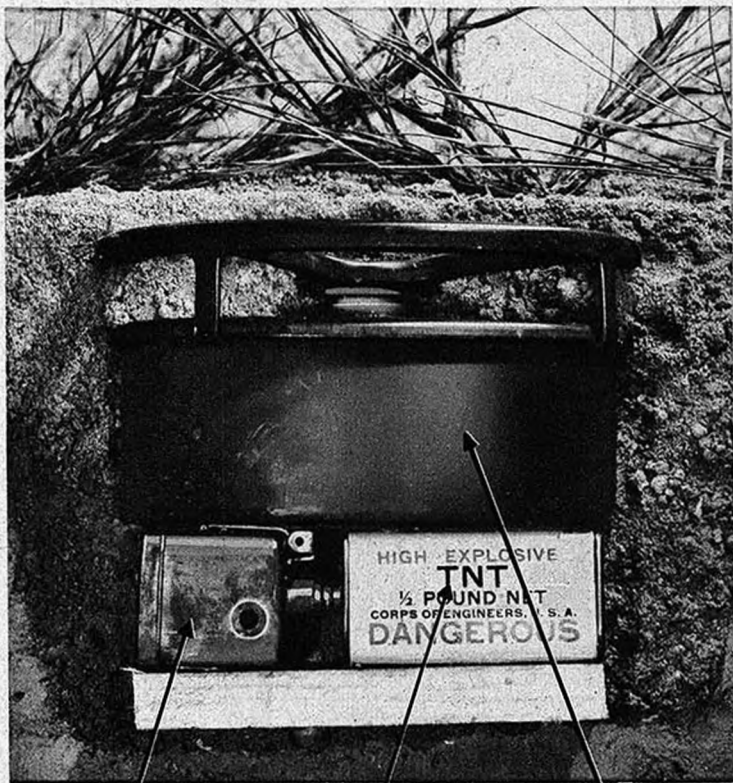

RELEASE FUZE M1

CHARGE

(AT) MINE M1 OR M1A1

NOTE: MINE COVER NOT SHOWN

DESCRIPTION

Booby-trapped antitank mine. As commonly used, it rests on release fuze M1, to which is attached a 1/2-pound of TNT.

EMPLOYMENT

To hinder removal of antitank mines.

FUNCTIONING

When antitank mine is lifted, fuze detonates TNT, sets off mine.

COMMENT

Mine may be booby-trapped by attaching pull fuze to mine or sack.

BOOBY-TRAPPING U. S. AT MINES, M1 AND M1A1

INSTALLING AND ARMING

1. Dig hole deep enough so top of spider of booby-trapped mine is at least $\frac{1}{4}$ inch above surface of ground.
2. Place nail through positive safety holes in fuze and unscrew base.
3. Remove cardboard protector from fuze base.
4. Crimp nonelectric cap to base.
5. Screw base into fuze.
6. Insert cap in TNT block.
7. Provide level, solid foundation for fuze to rest on. Separator from mine case may be used.
8. Place fuze and TNT block on foundation, and place anti-tank mine on exposed surface of latch.
9. Fill hole.
10. Remove safety fork from mine.
11. Remove safety pin from fuze by string attached to it.
12. If no clicking sound is heard, remove nail from positive safety holes by string tied to nail. If it does not come out easily, remove installation and check release fuze.

DISARMING

1. Dig under mine to get at fuze.
2. Insert nail through positive safety holes.
3. Insert safety pin through safety-pin hole.
4. Replace safety fork.

DEFUZING

1. After disarming, remove mine and defuze. (See page 51.01-d.)
2. Remove fuze from TNT block.
3. Unscrew base, with attached blasting cap, from fuze.

SPACE FOR NOTES

If soil is sandy it may be necessary to put fuze in burlap or cloth wrapping.

BOOBY-TRAPPING U.S.A.T. MINE, M5

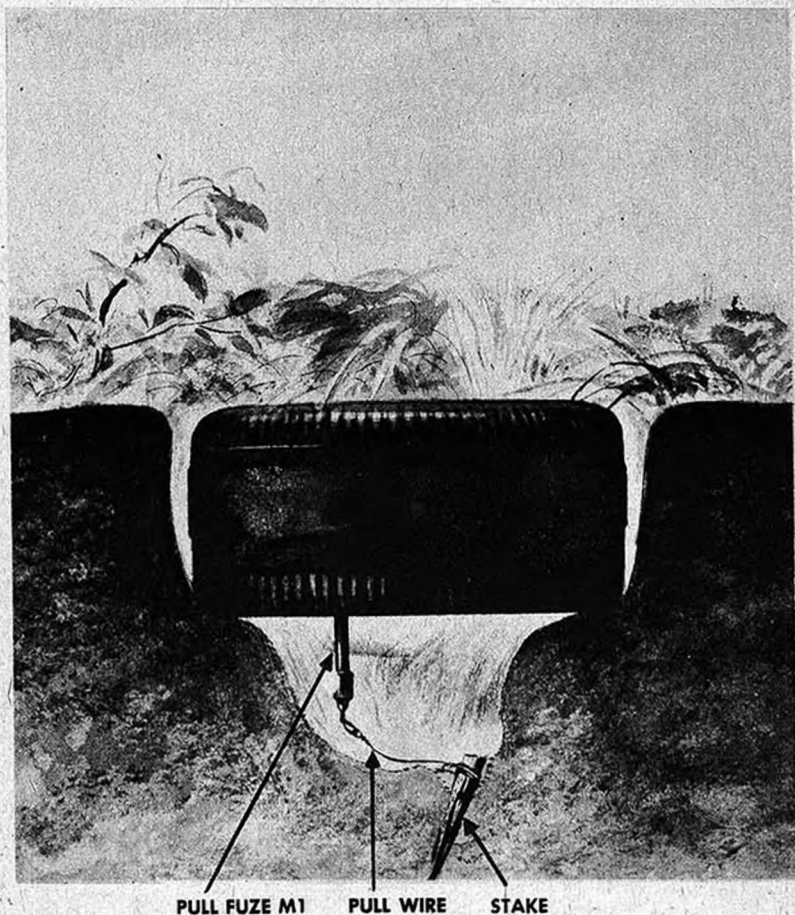

DESCRIPTION

Antitank mine, M5 ordinarily is booby trapped by pull-fuze, M1, screwed into bottom well. Pull wire is attached to pull ring of fuze, and to stake.

EMPLOYMENT

Booby trapping makes removal more hazardous and time-consuming; however, use of metallic fuze permits detection by sensitive mine detector.

FUNCTIONING

When mine is lifted, pull wire trips fuze, sets off mine.

BOOBY-TRAPPING U.S.A.T. MINE, M5

INSTALLING AND ARMING

1. Dig hole with tapered sides. Deepen and widen hole at one side to form a trench.
2. Drive stake into bottom of hole.
3. Unscrew base from fuze and remove cardboard protector from base.
4. Crimp nonelectric cap to base, and screw base back into fuze.
5. Unscrew plug from well in bottom of mine.
6. Screw fuze into well.
7. Tie short wire to stake and to fuze pull ring, and lower mine into hole.
8. Lead strings from safety pins of secondary fuze out to side of excavation.
9. Fill hole.
10. Remove safety ring from mine fuze.
11. Remove safety pin from head of fuze by pulling on string.
12. Remove positive safety pin from fuze by pulling gently on string. If pin binds, remove fuze and check.

NOTE: Other methods of anchoring and installing pull wire also are used.

DISARMING

1. Uncover top, and remove fuze.
2. Dig under mine, and disarm secondary fuze.

DEFUZING

1. After disarming cut pull wire and remove mine.
2. Unscrew secondary fuze from mine, and remove base.

SPACE FOR NOTES

U. S. RELEASE FUZE WITH RIFLE

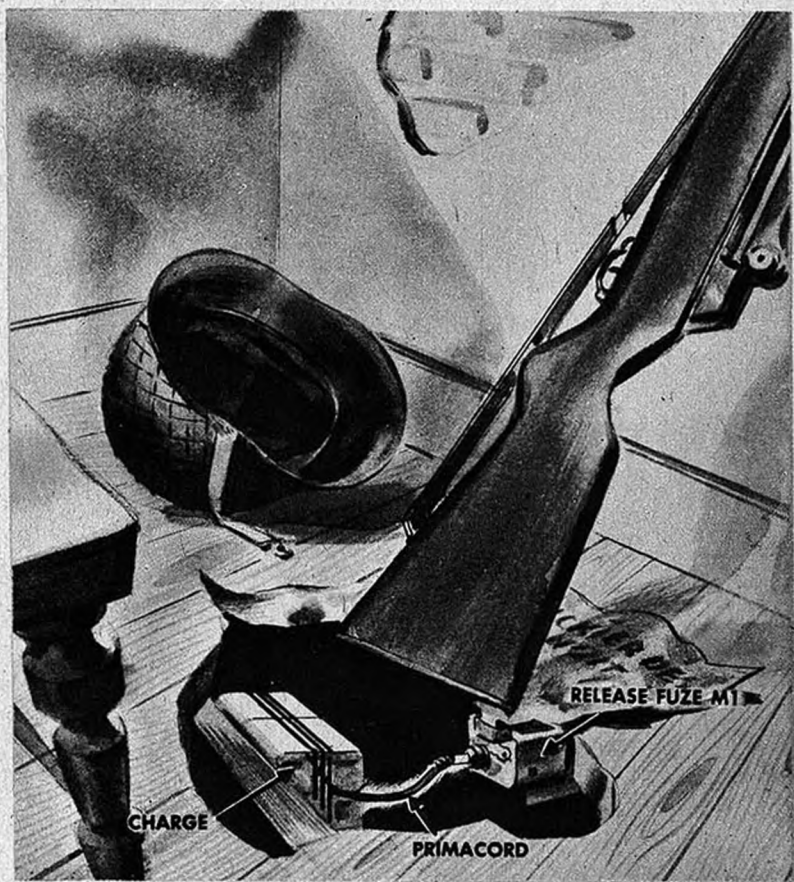

The fuze is set off when the rifle is moved.

INSTALLING

Follow directions given for installing pull fuze M1 (page 53.02-c).

DISARMING

Locate fuze. Follow directions given for disarming pull fuze M1 (page 53.02-d)

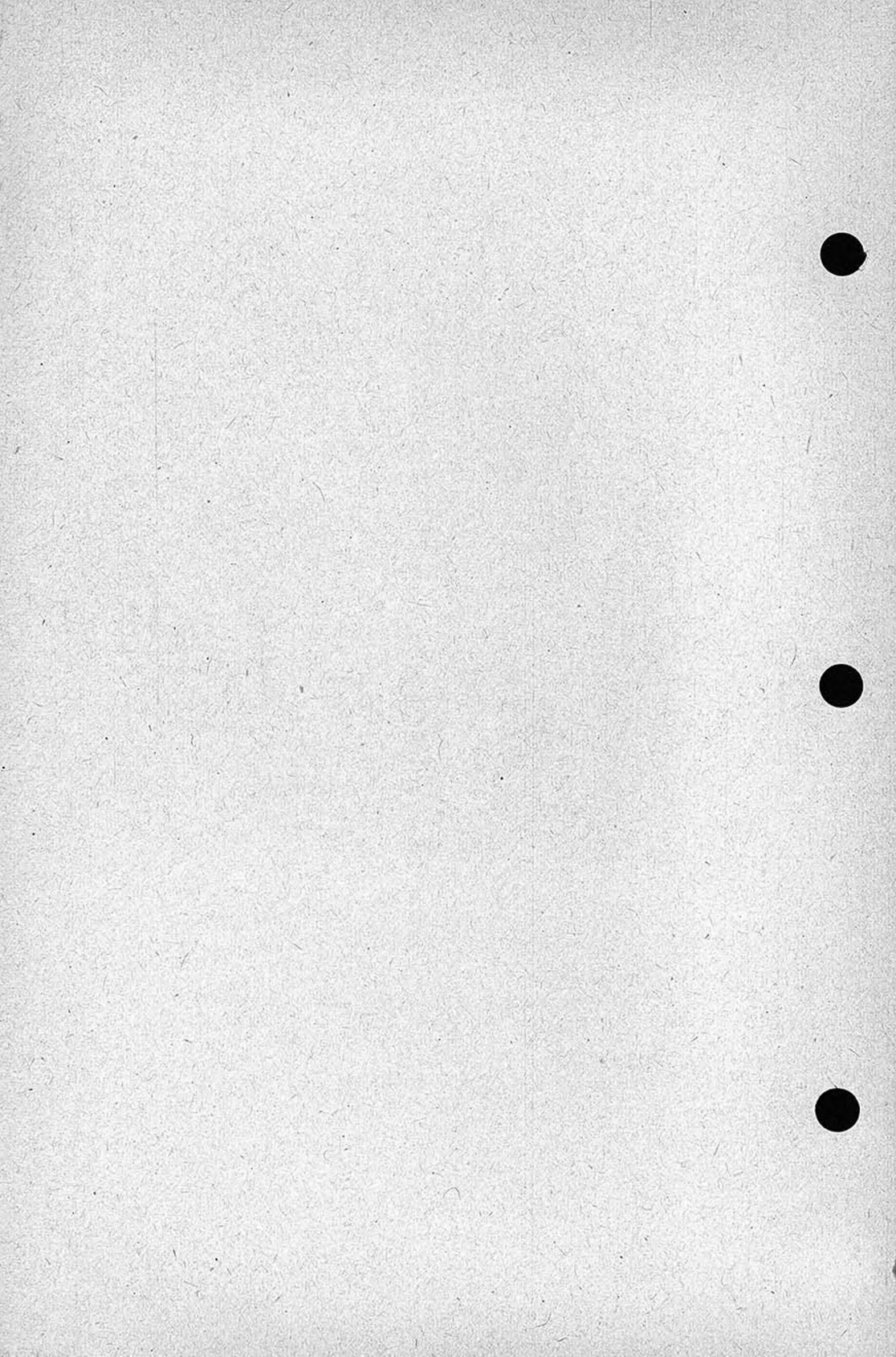

U. S. TANK TURRET BOOBY-TRAPPED

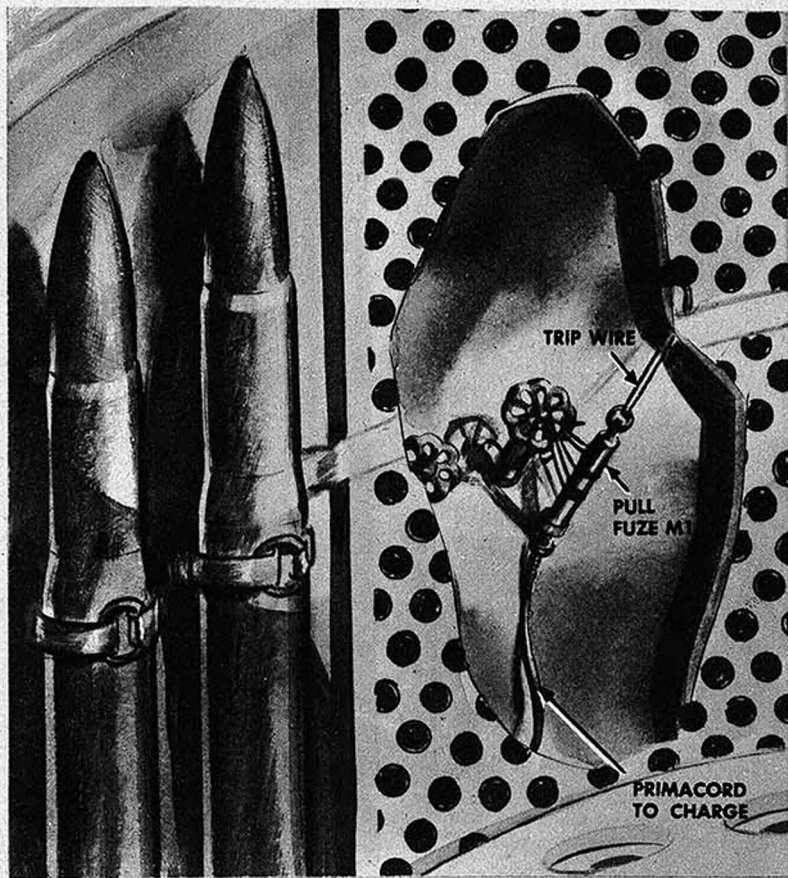

Pull fuze is placed between turret basket and hull of medium tank to detonate when turret is rotated.

INSTALLING

Follow directions given for installing U. S. pull fuze M1 (page 53.02-c).

DISARMING

Locate fuze and follow directions given for disarming U. S. pull fuze M1 (page 53.02-d).

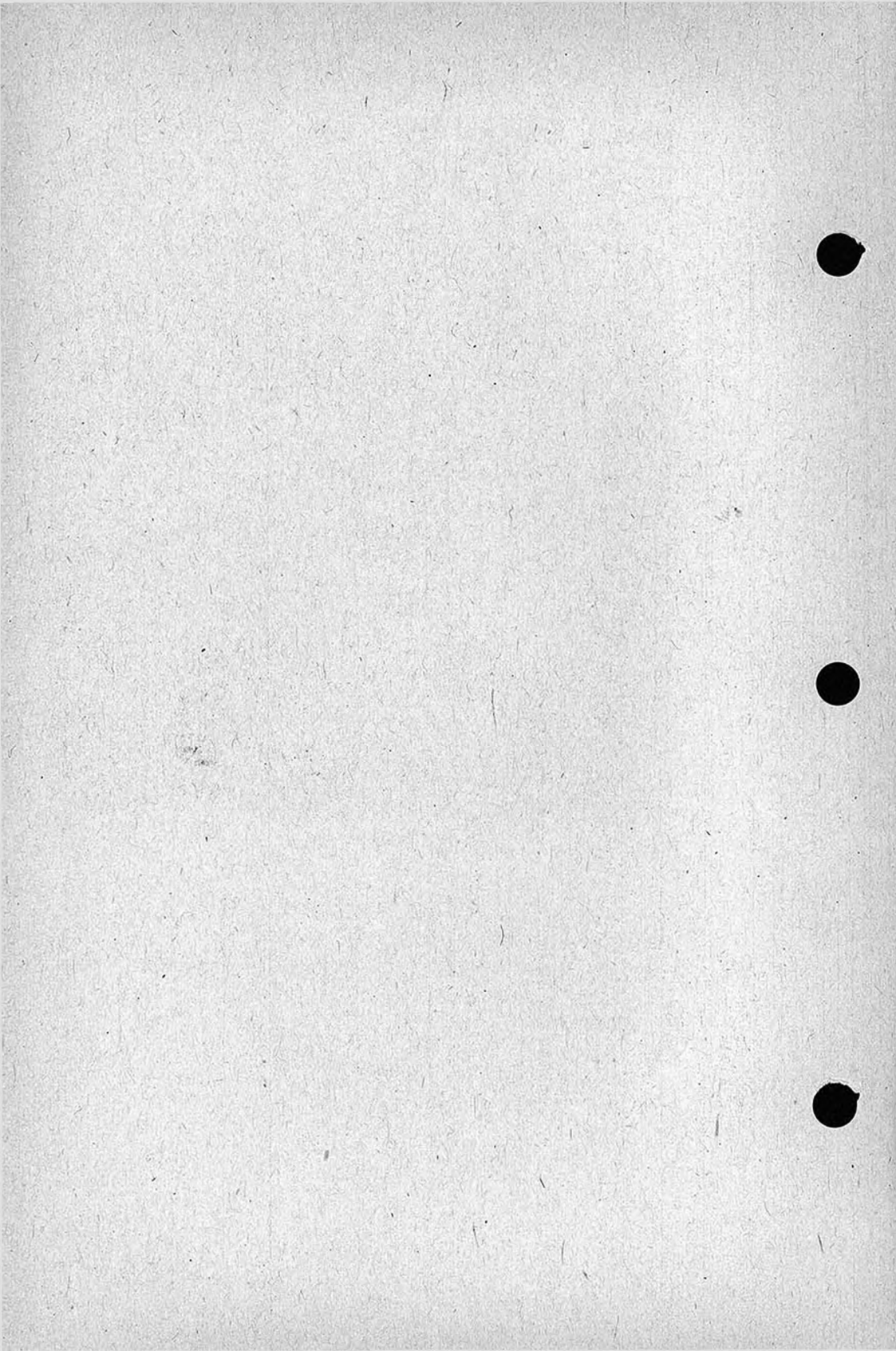

U. S. PRESSURE FUZE IN SEAT CUSHION



CHARGE

PRESSURE FUZE M1 A1

PRIMA CORD

Fuze is detonated by pressure on seat cushion.

INSTALLING

Follow directions given for installing U. S. pressure fuze M1A1 (page 53.01-c).

DISARMING

Locate fuze and follow directions given for disarming U. S. pressure fuze M1A1 (page 53.01-d).

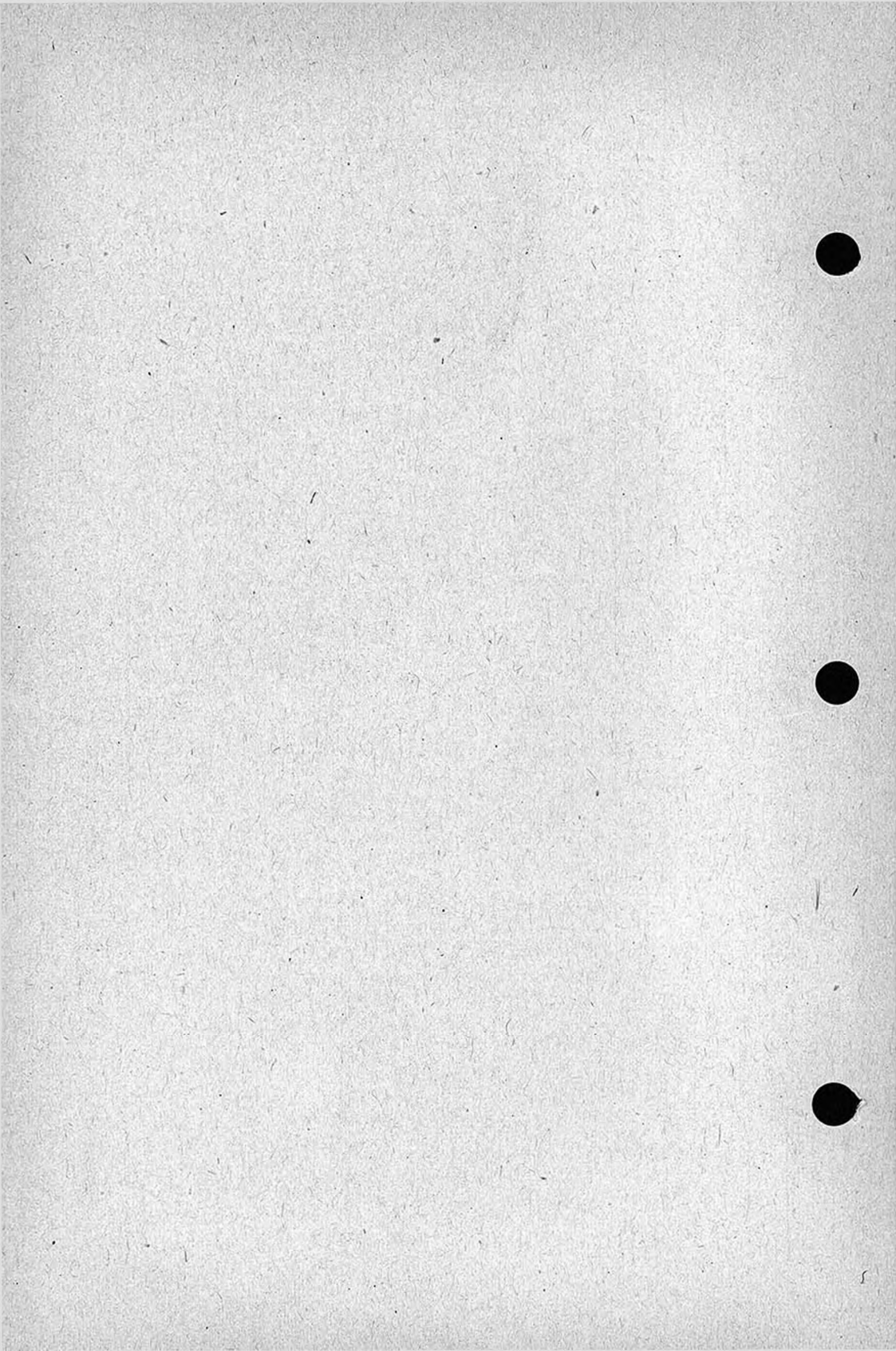

U. S. RELEASE FUZE UNDER TRUCK WHEEL

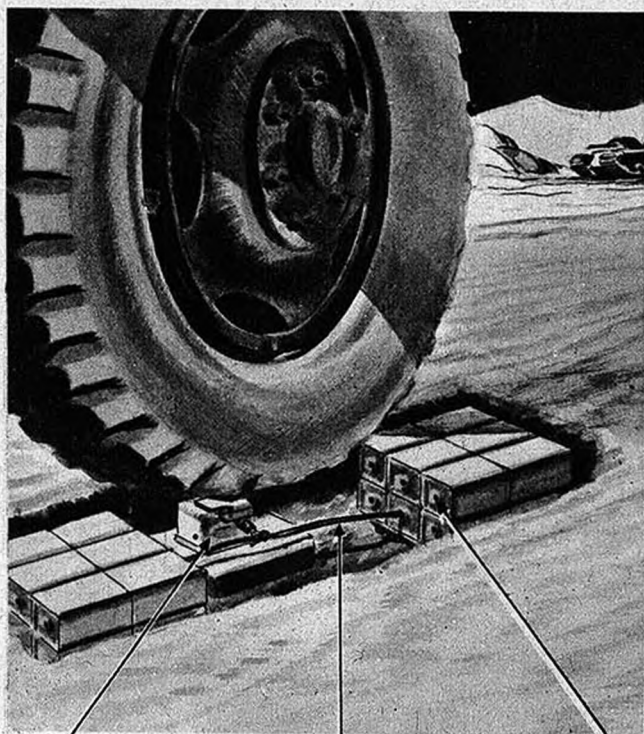

U. S. RELEASE FUZE M-1

PRIMA CORD

CHARGE

Charge is detonated when vehicle is moved.

INSTALLING

1. Dig hole under wheel, saving spoil.
2. Crimp blasting cap on end of primacord.
3. Insert crimped blasting cap in TNT block. Add rest of charge.
4. Crimp another blasting cap to base of release fuze.
5. Tape loose end of primacord to cap on fuze.
6. Place complete assembly in hole.
7. Refill hole and camouflage.
8. Push truck so wheel is over release latch.
9. Pull string, removing safety pin.
10. If no clicking sound is heard, and safety nail is easily moved, pull string removing it.
11. Best location is on a slope. Brake wheels. When brake is released, vehicle moves and sets off trap.

DISARMING

Locate fuze and follow directions given for disarming U. S. release fuze M1 (page 53.03-d).

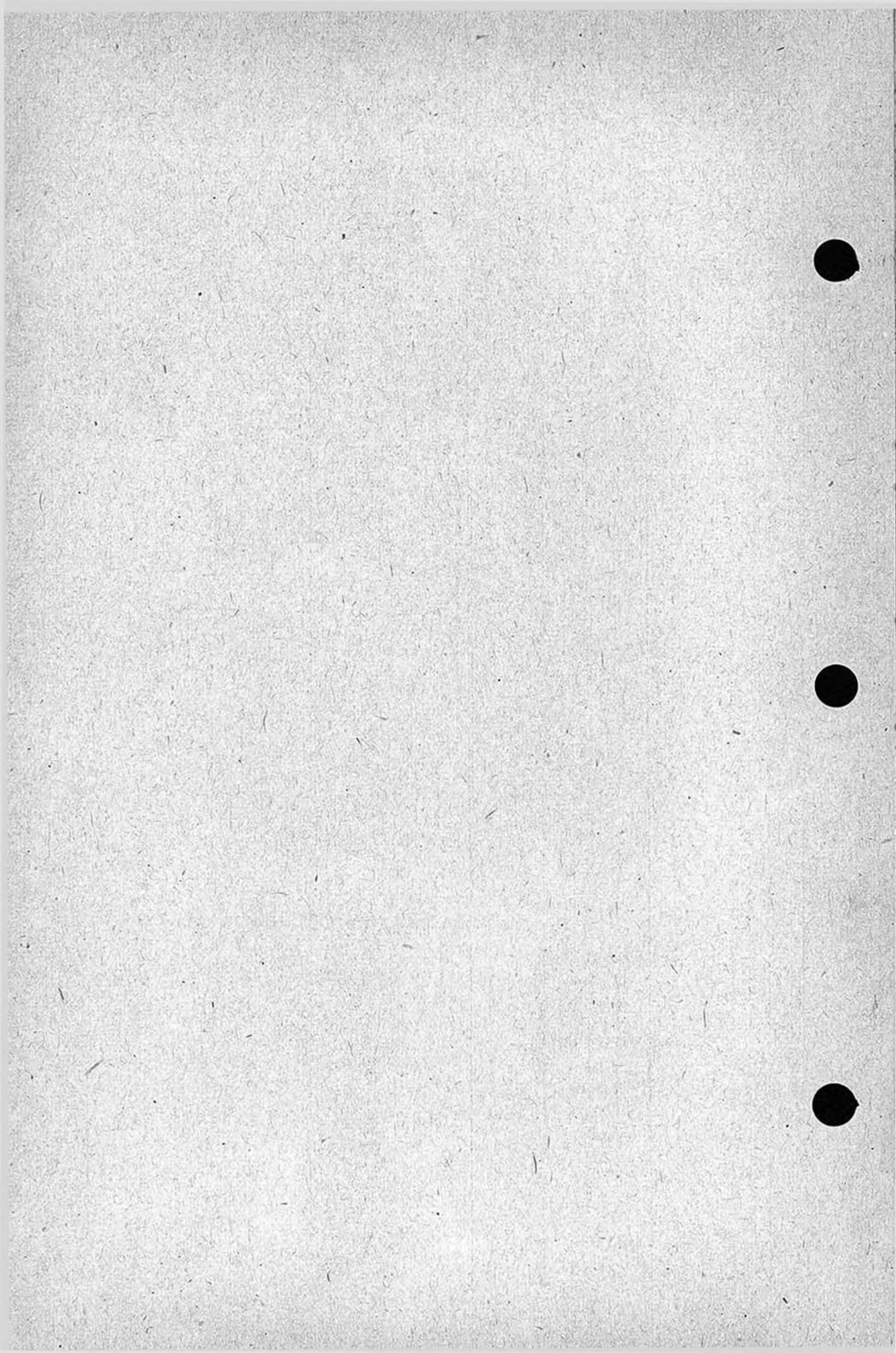

U. S. PULL FUZE IN WINDOW INSTALLATION

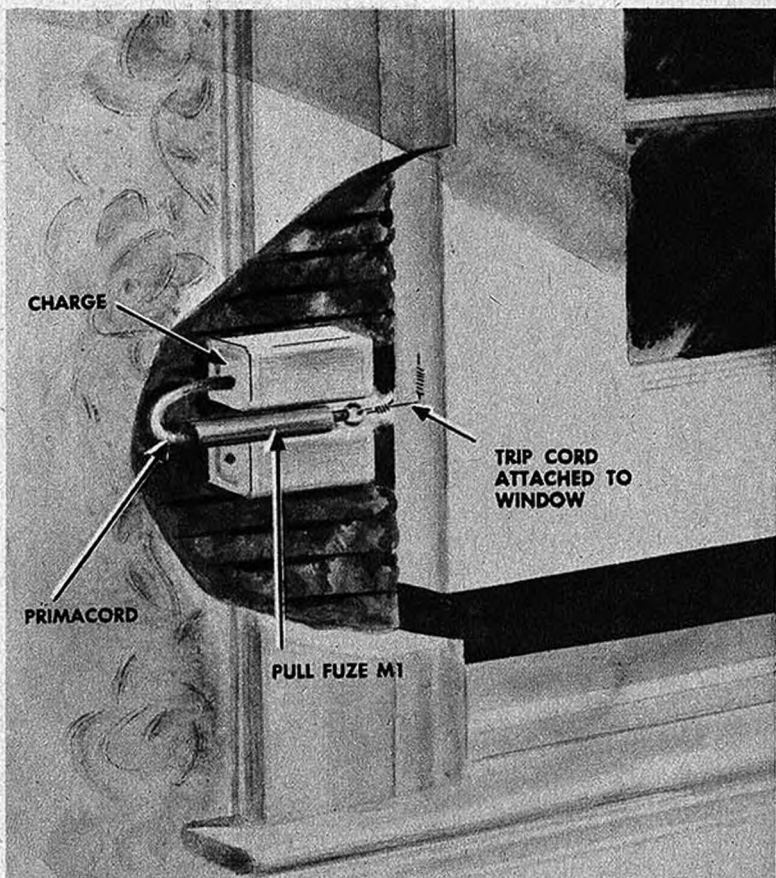

The charge is fired when the window is either raised or lowered.

INSTALLING

Follow directions given for installing and arming pull fuze M1 (page 53.02-c).

DISARMING

Locate and identify fuze. Follow directions given for disarming (page 53.02-d).

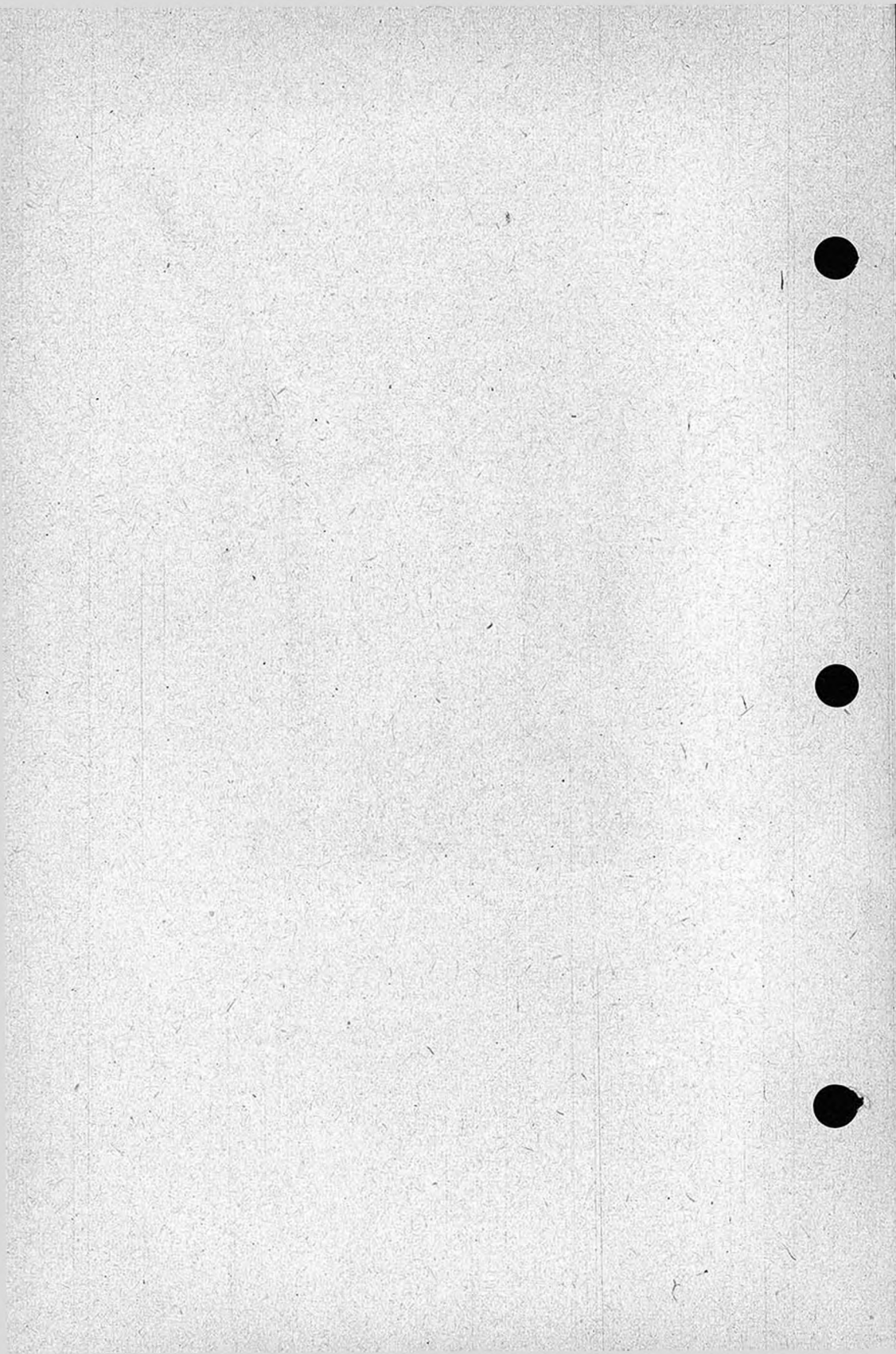

U. S. PULL FUZE UNDER CHAIR

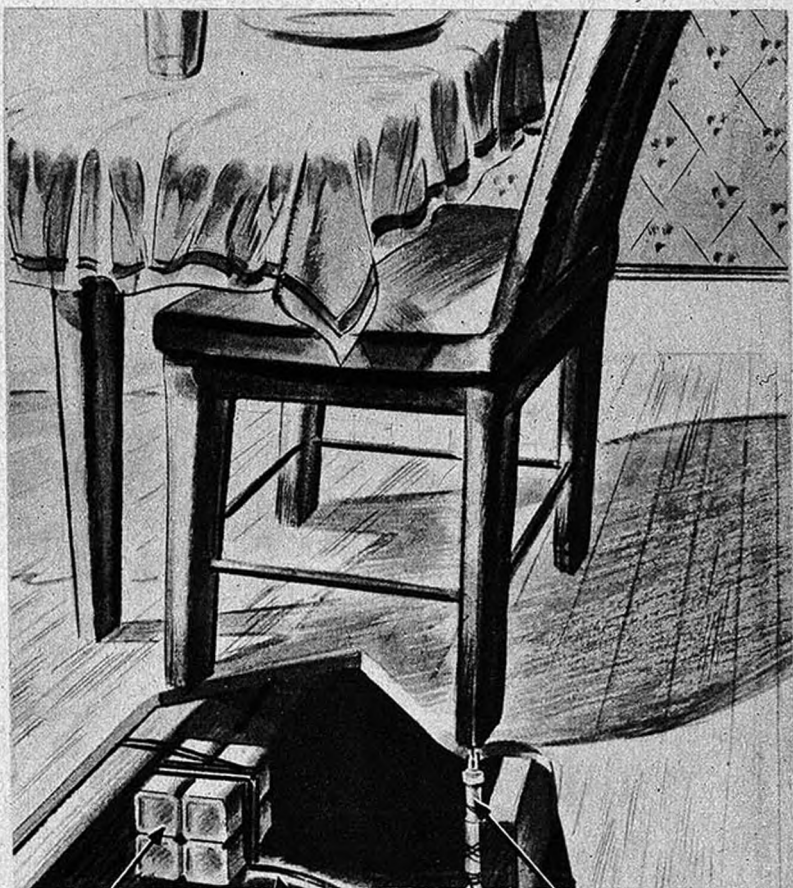

CHARGE

PRIMACORD

U.S. PULL FUZE M1

Fuze is detonated when chair is moved.

INSTALLING

Follow directions given for installing pull fuze M1 (page 53.02-c).

DISARMING

Locate fuze. Follow directions given for disarming pull fuze M1 (page 53.02-d).

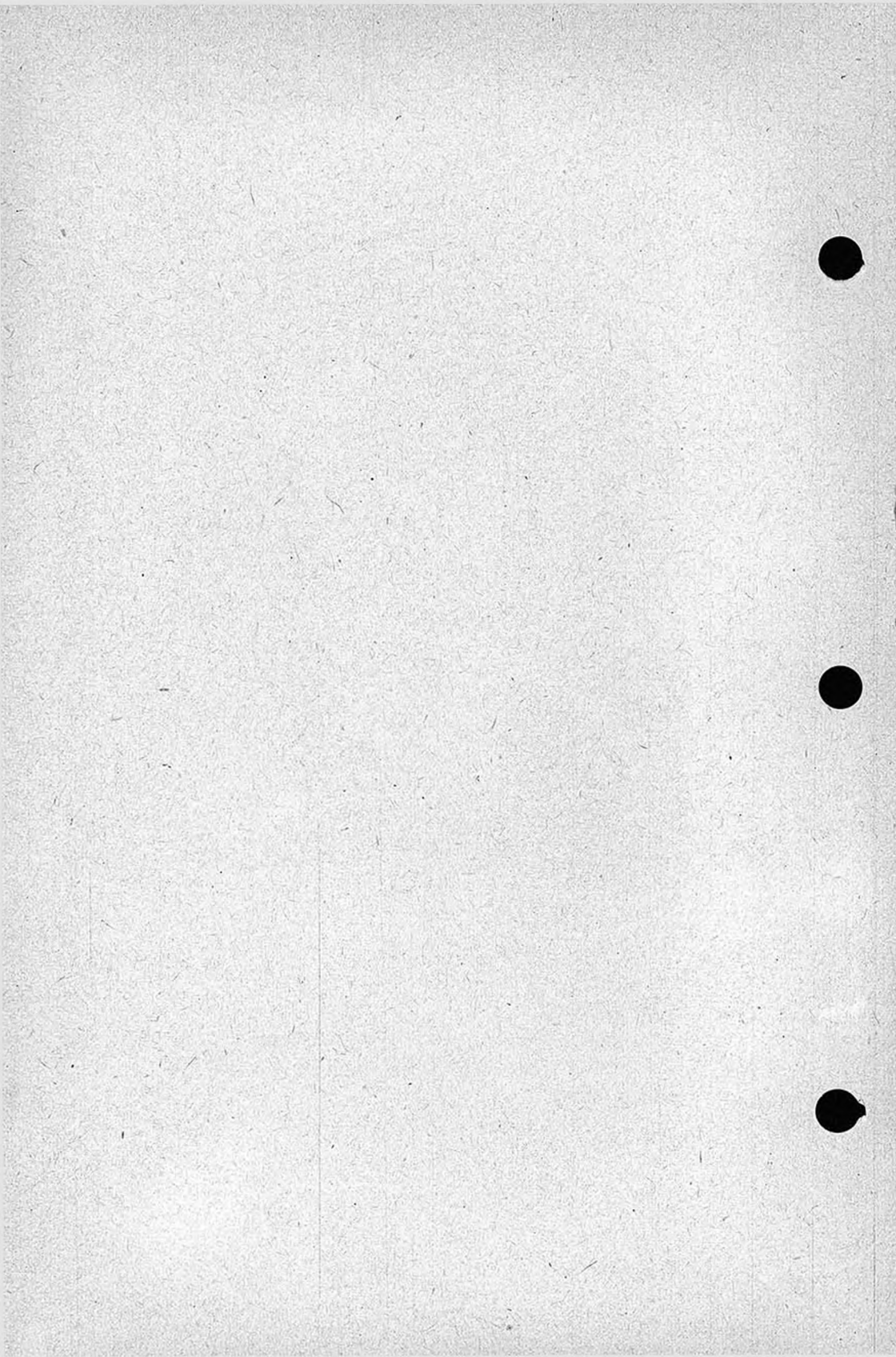

U. S. DOOR-MAT BOOBY TRAP

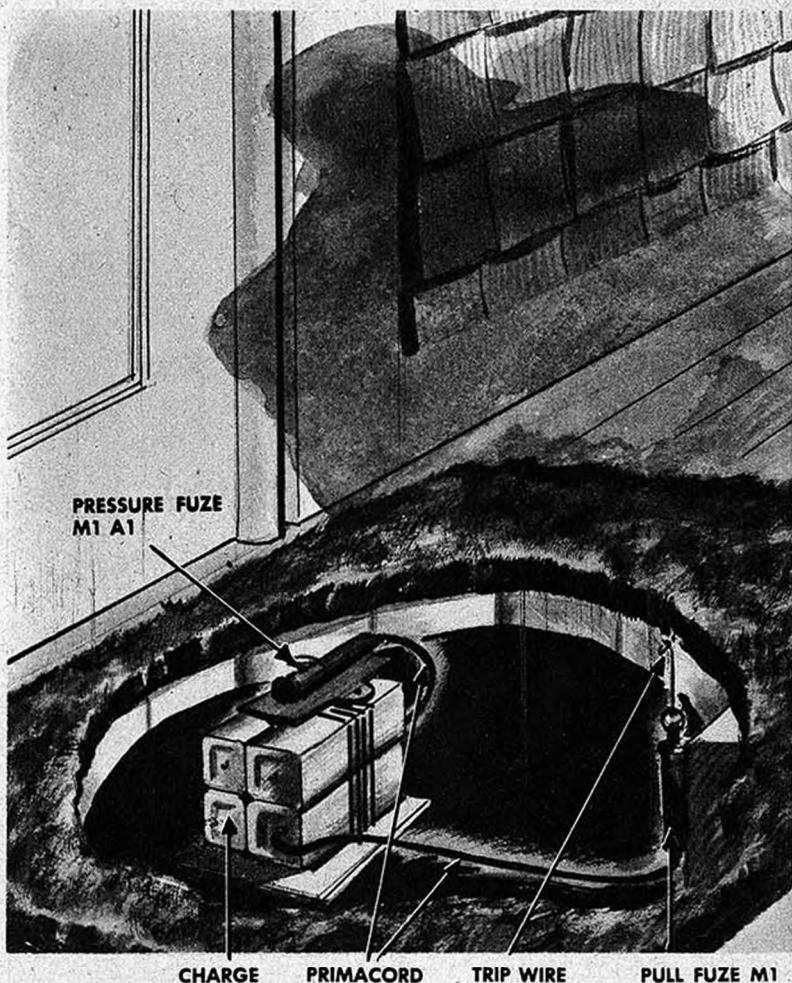

Sketch shows typical combination pull- and pressure-fuze installation.

INSTALLING

Follow directions given for installing pull fuze M1 (page 53.02-c) and pressure fuze M1A1 (page 53.01-c).

DISARMING

Locate fuzes, and follow directions given for disarming (pages 53.02-d and 53.01-d).

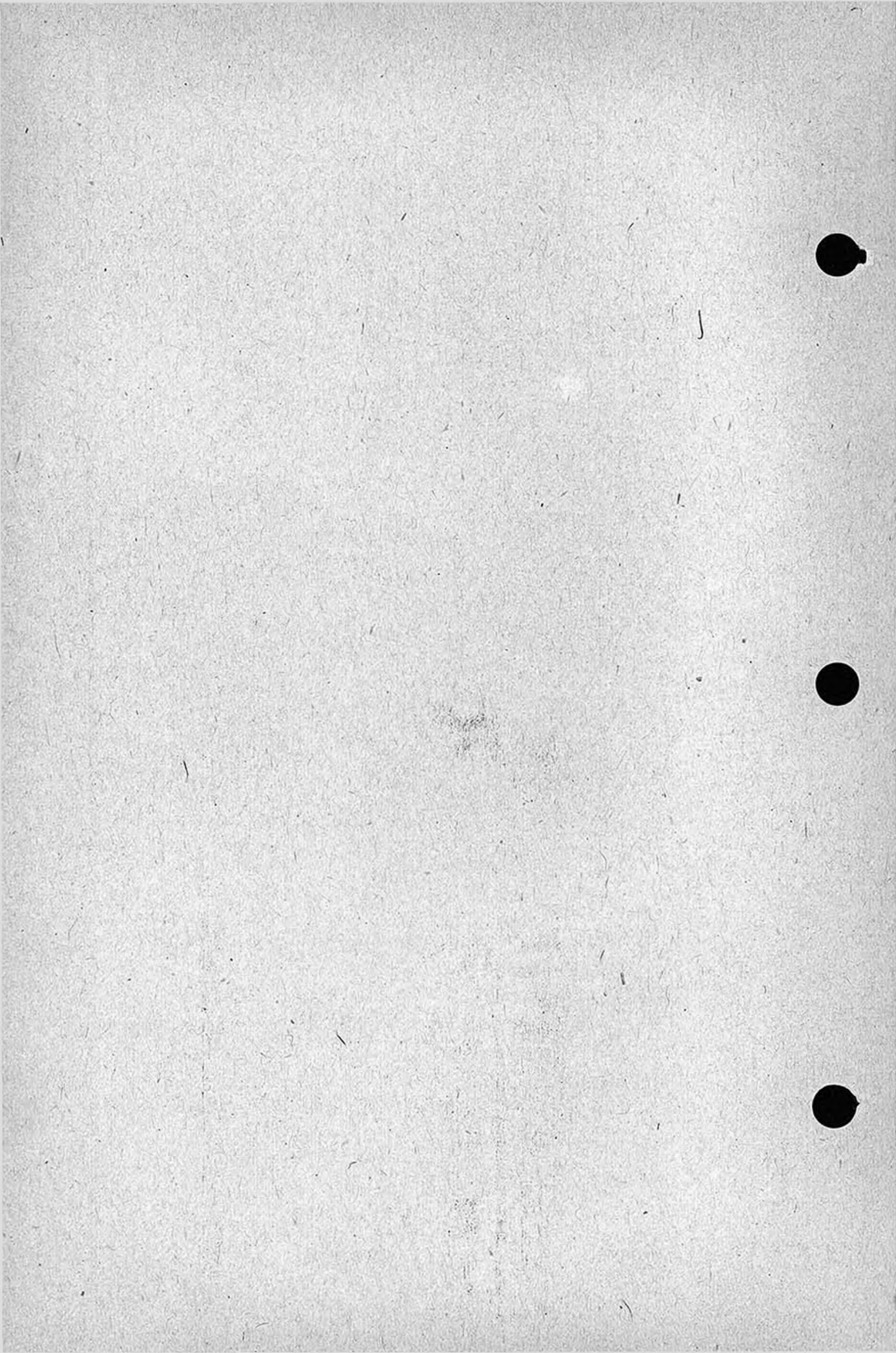

U. S. PULL FUZE WITH CEMENT BAG

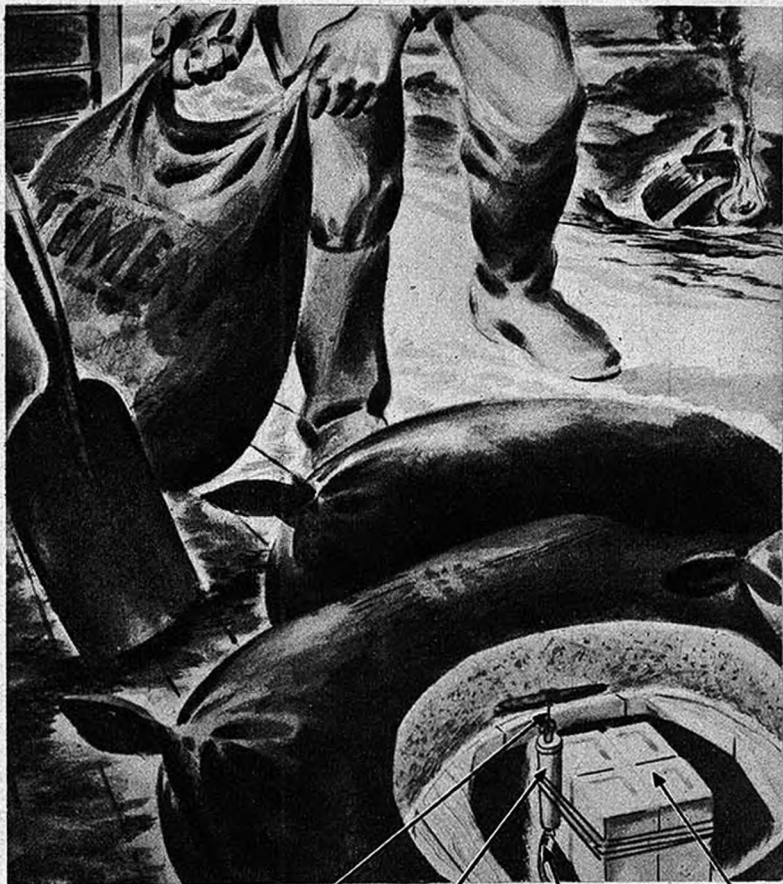

TRIP WIRE
ATTACHED TO
CEMENT BAG

PULL FUZE M1

PRIMACORD

CHARGE

Sack of cement or other material is booby trapped as shown in sketch.

INSTALLING

Follow directions given for installing U. S. pull fuze M1 (page 53.02-c).

DISARMING

Locate fuze and follow directions given for disarming (page 53.02-d).

60.01 GENERAL British and American mine-warfare policy is nearly identical in all major respects, and mine danger signs are similar.

60.02 DEFENSE

a. The British base their antitank defense on an antitank gun "screen," with which they closely coordinate their mine fields. Their defensive policy is to concentrate intense fire of all arms on an enemy attack in order to separate the attacking infantry from the tanks, thus compelling the tanks to continue the advance alone and partially blind. The enemy tanks then are held up in the mine fields and destroyed by the antitank gun screen.

b. The defenses are sited in considerable depth, each defended locality being capable of all around defense and able to continue fighting even though surrounded. These defended localities are connected by mine fields running both laterally and from front to rear, so as to canalize and delay any enemy penetration and to give time for launching a counterattack.

60.03 MINE-FIELD MARKING. Mine-field marking is of great importance, and all mine fields are surrounded by wire fences except the most advanced mine fields direct facing the enemy, the front edges of which are not fenced.

60.04 MINE-FIELD RECORDING Mine-field records are kept at corps and army headquarters, where the chief engineer is responsible for maintaining them up-to-date. Units entering a new sector usually obtain mine-field-record data from the chief engineer at corps headquarters.

BRITISH G. S. MARK II MINE

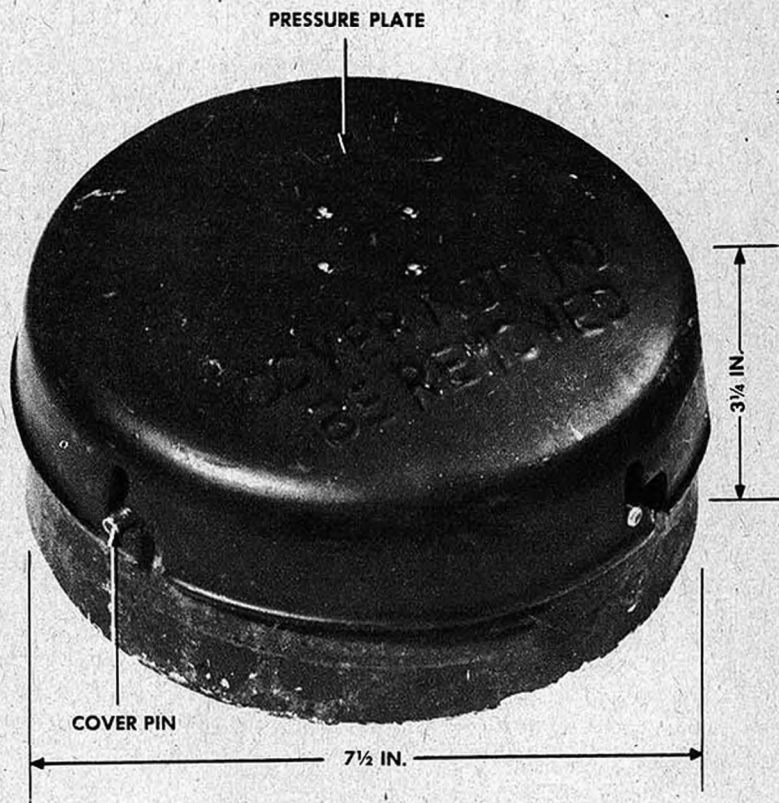

TYPE. Antitank mine

COLOR. Sides and top dark green; bottom yellow, with cross of red and green

CASE. Steel

WEIGHT. 8 $\frac{3}{4}$ pounds

EXPLOSIVE. 4 pounds TNT or baratol

EFFECT

Breaks tracks on light and medium tanks, disables vehicles

PACKING AND TRANSPORTING

Steel case contains eight mines and eight fuzes.

BRITISH G. S. MARK II MINE

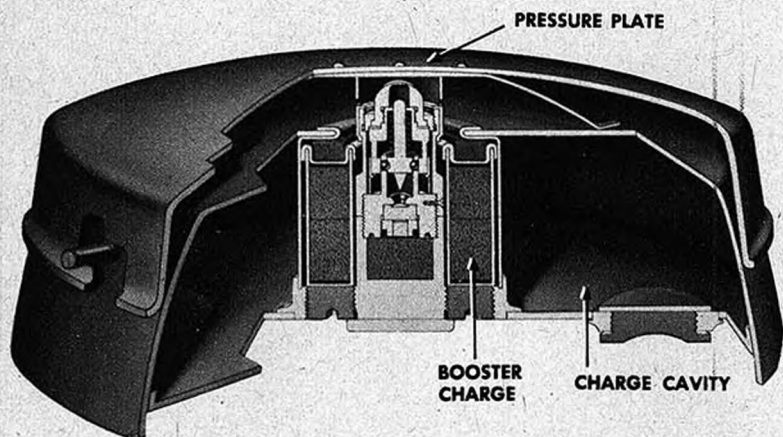

FUNCTIONING

1. Forcing down pressure plate crushes thin-walled brass sleeve.
2. Head and plunger forced downward. Four prongs on brass safety sleeve release grip. Spring compressed.
3. Released balls forced outward into recess.
4. Released striker fires percussion cap—detonator—booster—main charge.

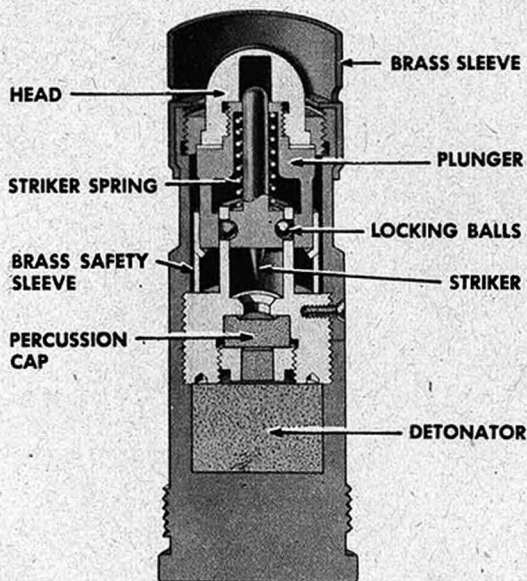

BRITISH G. S. MARK II MINE

INSTALLING AND ARMING

1. Dig hole deep enough so top of mine will be just below ground surface.
2. Lay mine on edge.

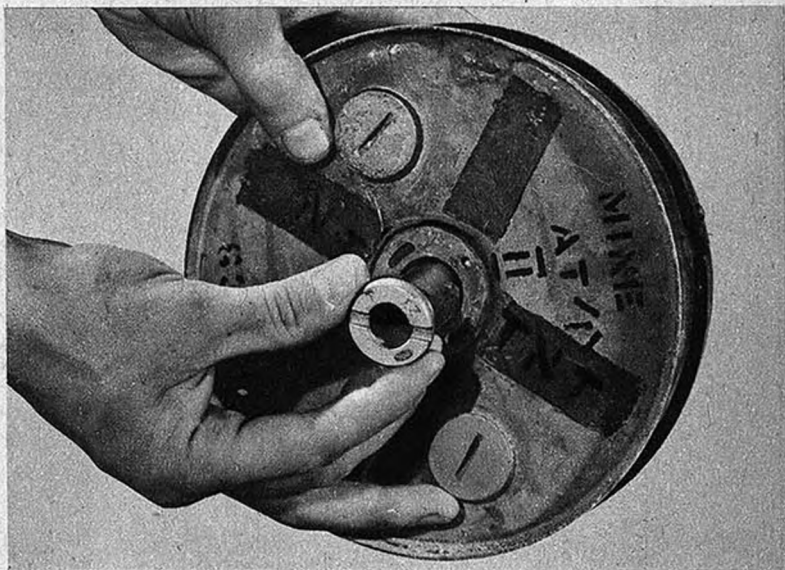

3. Unscrew removable plug in center of mine body.

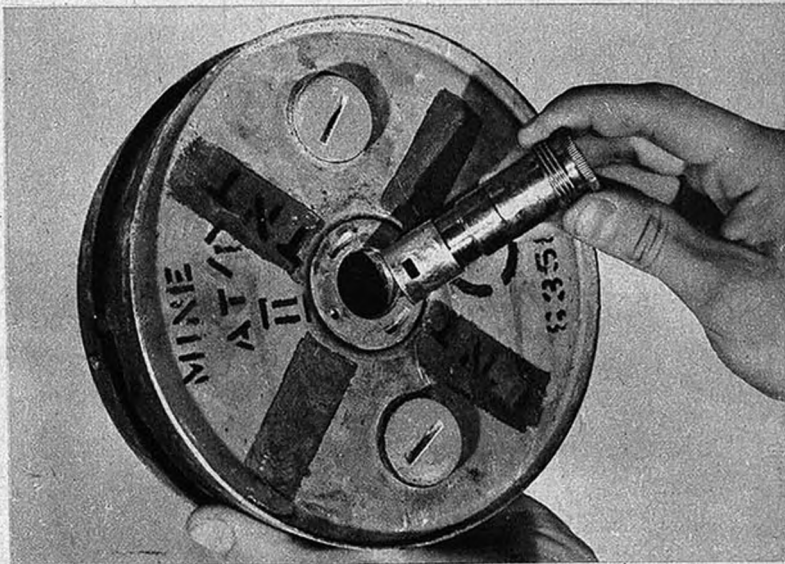

4. Insert fuze and screw it in finger tight.
5. Place mine pressure plate up.
6. Fill hole and conceal.

BRITISH C. S. MARK II MINE

DISARMING

To disarm, defuze.

DEFUZING

Unscrew fuze from bottom, and remove.

RE-USE

Inspect fuze to see thin-walled brass sleeve has not been crushed.

SPACE FOR NOTES

BRITISH C. S. MARK IV MINE

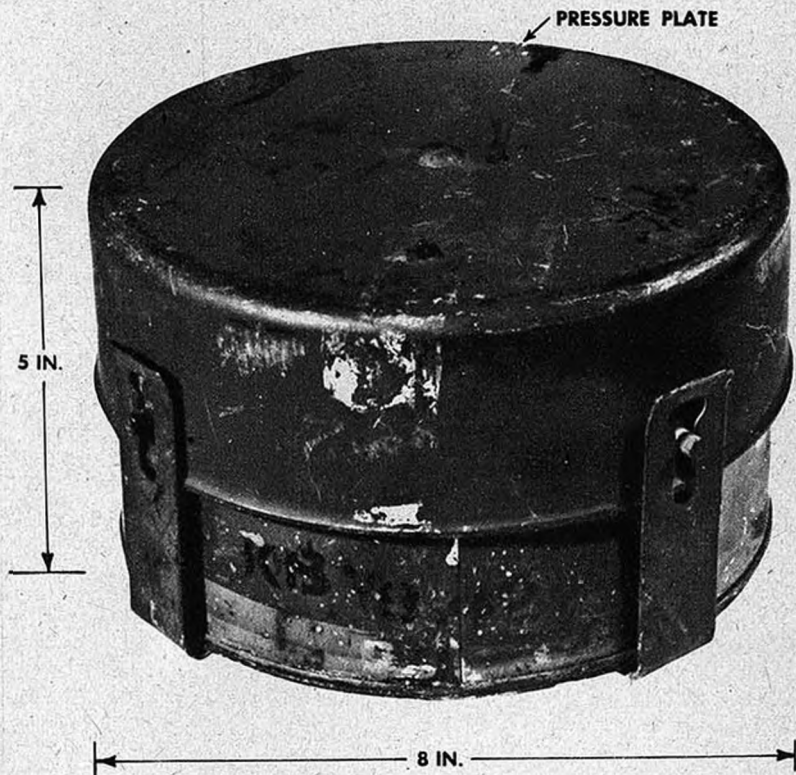

TYPE. Antitank mine.

COLOR. Khaki-green.

CASE. Steel.

WEIGHT. 12½ pounds.

EXPLOSIVE. 8¾ pounds TNT or baratol.

EFFECT. Disables tanks and vehicles.

BRITISH C. S. MARK IV MINE

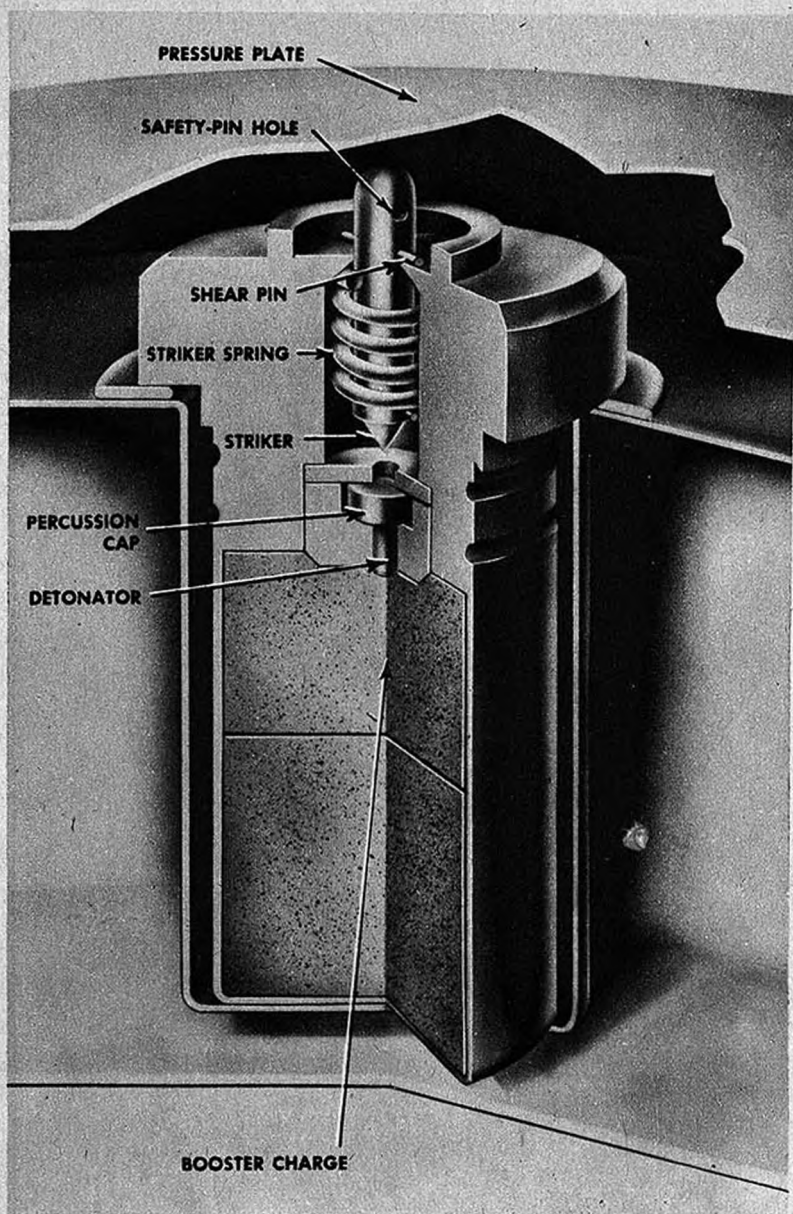

FUNCTIONING

1. Pressure forces pressure plate down onto striker.
2. Striker is pushed down, cutting shear pin.
3. Released striker fires percussion cap—detonator—booster—main charge.

BRITISH G. S. MARK IV MINE

INSTALLING AND ARMING

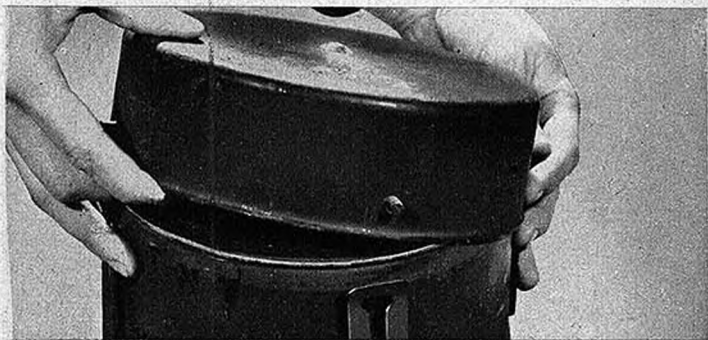

1. Dig hole deep enough so mine will protrude $\frac{1}{4}$ inch above ground.
2. Remove adhesive tape binding pressure plate to container.
3. Remove pressure plate.
4. Put mine in hole.



5. Remove paper which seals fuze well.
6. Make sure shear pin is in position, insert fuze and remove safety pin. The unit should be an easy fit; *do not use force.*



BRITISH G. S. MARK IV MINE

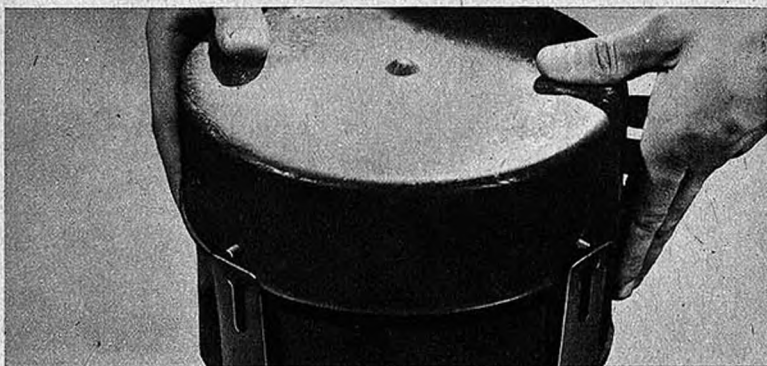

7. Replace pressure plate.
8. Cover with loose earth or sod.

DISARMING

Remove pressure plate, insert safety pin in safety-pin hole.

DEFUZING

After disarming, take fuze from well. Lift mine. Replace pressure plate. Stack mines and fuzes separately.

PACKING AND TRANSPORTING

Wooden box contains five mines. Fuzes are packed separately, 20 to a wooden box.

RE-USE

Inspect fuze to see shear pin is in position, and not cut or partially cut.

SPACE FOR NOTES

BRITISH G. S. MARK V MINE

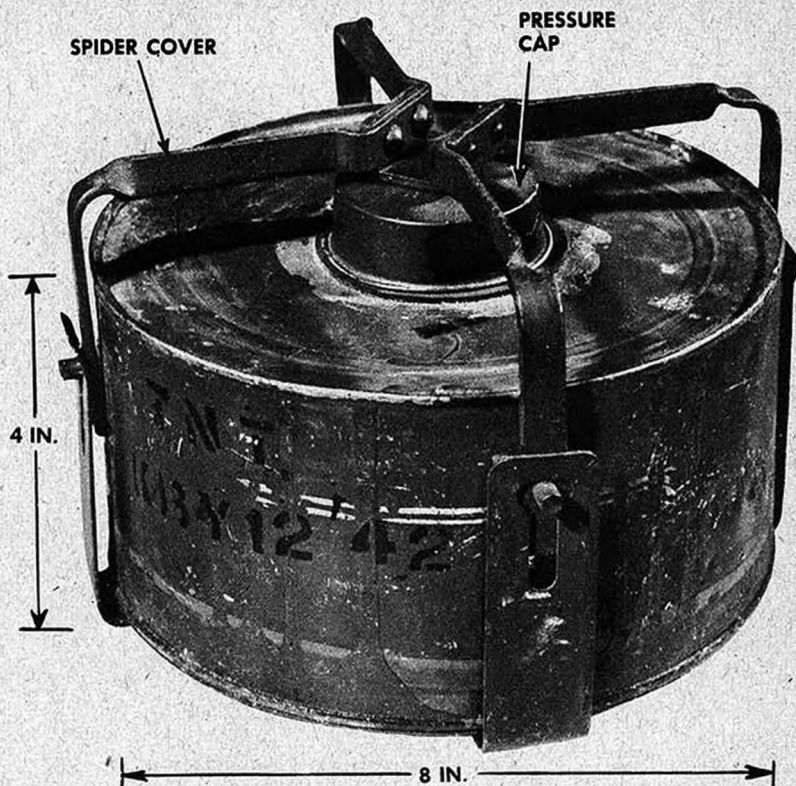

TYPE. Antitank

COLOR. Khaki-green

CASE. Steel

WEIGHT. 8 pounds

EXPLOSIVE. 4½ pounds TNT or baratol

EFFECT. Immobilizes tanks and vehicles

PACKING AND TRANSPORTING

Wooden box contains five mines. Fuzes packed separately, 20 to a wooden box.

DISARMING

1. Remove spider.
2. Lift out pressure cap.
3. Insert safety pin into striker head.

BRITISH G. S. MARK V MINE

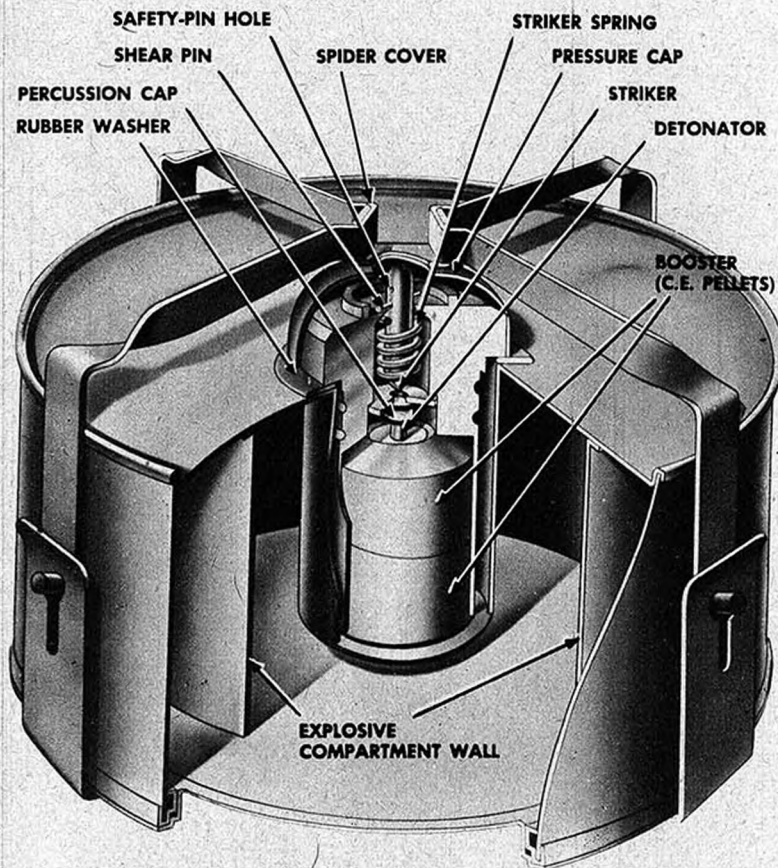

FUNCTIONING

1. Pressure forces spider onto pressure cap.
2. Striker is pushed down, cutting shear pin.
3. Released striker fires percussion cap—detonator—booster—main charge.

DEFUZING

After disarming fuze, extract it from well.

RE-USE

Inspect fuze to see shear pin has not been cut, or partially cut. Straighten straps, if bent; see that spider can be fitted on pressure cap without strain.

BRITISH C. S. MARK V MINE

INSTALLING AND ARMING

1. Dig hole so top of spider will protrude $\frac{1}{4}$ inch above ground.
2. Place mine.



3. Remove spider and pressure cap.



4. Make sure shear pin is in place.

BRITISH C. S. MARK V MINE



5. Insert fuze, using no force. Extract safety pin.
6. Place pressure cap over fuze so it rests on rubber washer.



7. Replace spider, making sure pins engage in slots in straps.
8. Cover with earth or sod.

BRITISH G. S. MARK VH. C. MINE

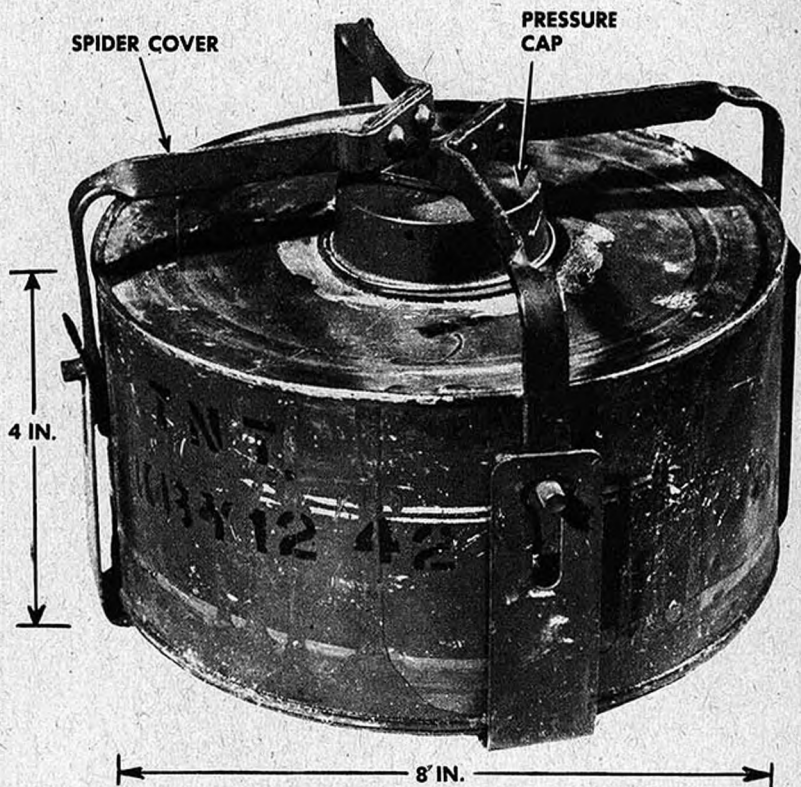

TYPE. Antitank mine

COLOR. Khaki-green

CASE. Steel

WEIGHT. 12 pounds

EXPLOSIVE. $8\frac{1}{4}$ pounds TNT

This mine has a G. S. Mark V body, with explosive filling occupying space on both sides of wall within explosive compartment. Greater amount of explosive in the Mark VH. C. causes greater damage to tank tracks and to vehicles. Functioning, installing, defuzing, method of packing, and re-use described for Mark V (see p. 61.03-a, b, c, d).

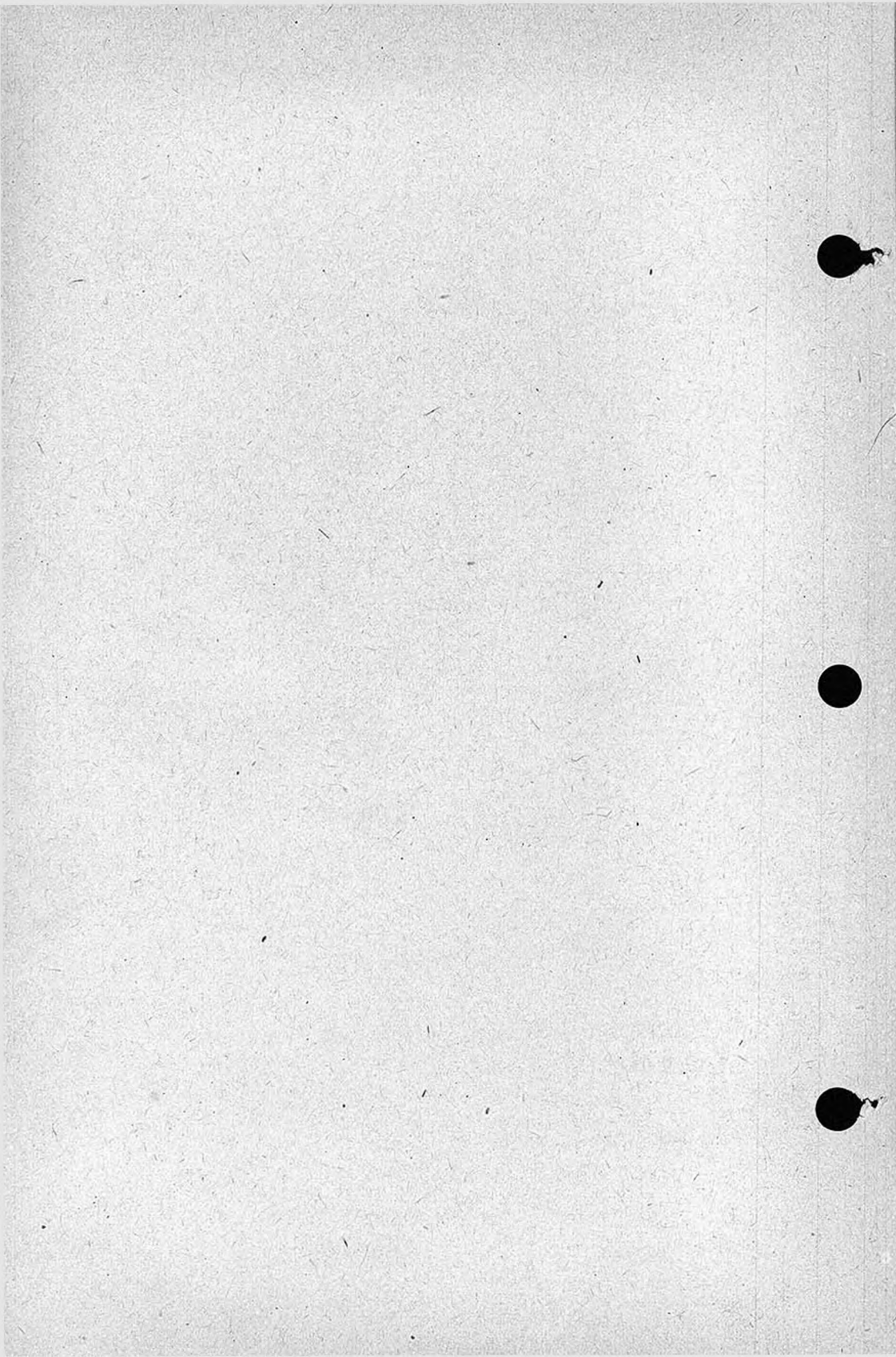

BRITISH NO. 75 HAWKINS GRENADE MINE, MARK I

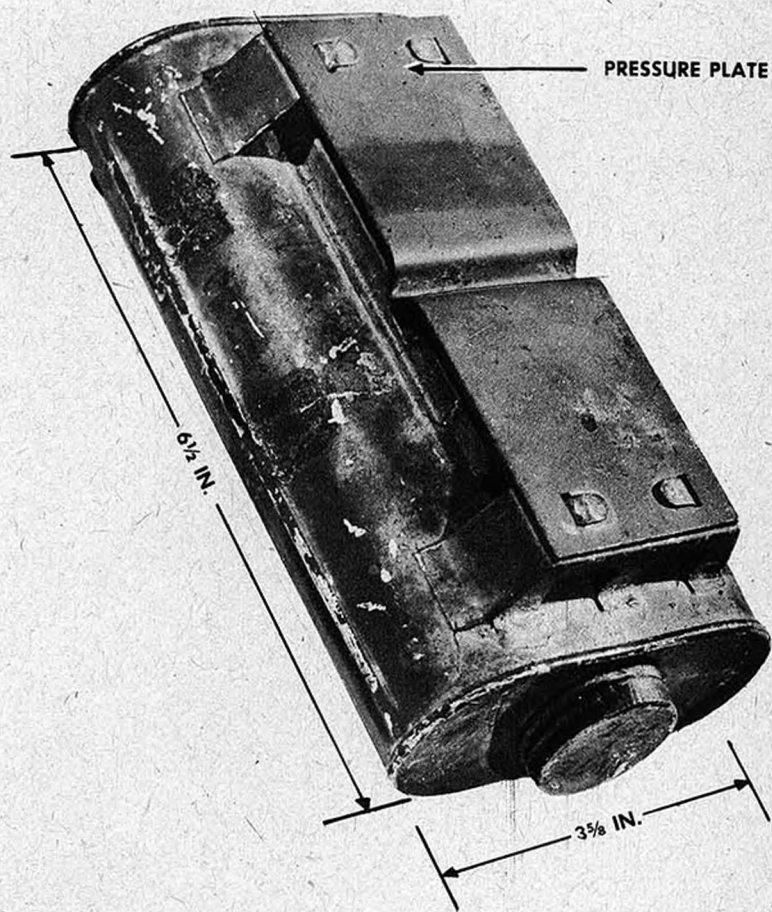

TYPE. Antitank mine

COLOR. Olive-drab

CASE. Steel

WEIGHT. 3 pounds

EXPLOSIVE. 1½ pounds Nobel's ammonal 704

EFFECT. Disables light tanks and vehicles

BRITISH NO. 75 HAWKINS GRENADE MINE, MARK I

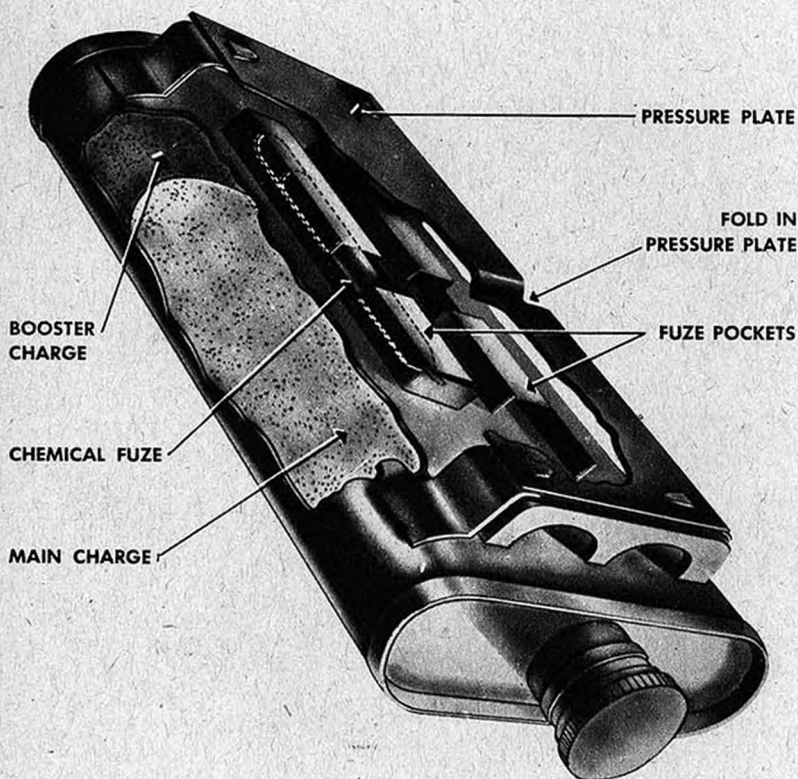

EMPLOYMENT

1. In hasty mine fields to protect forward troops.
2. Buried in deliberate mine fields.
3. In road blocks.

FUNCTIONING

1. Pressure causes pressure plate to bend.
2. Fold in pressure plate crushes vial in fuze.
3. Resulting chemical reaction of fuze ingredients produces flame which sets off detonator—booster—main charge.

BRITISH NO. 75 HAWKINS GRENADE MINE, MARK 1

INSTALLING AND ARMING

Lay with long side parallel to line of probable enemy approach.
In deliberate mine field, bury two or more mines together,
with pressure plate of upper mine or mines flush with surface.
To arm—

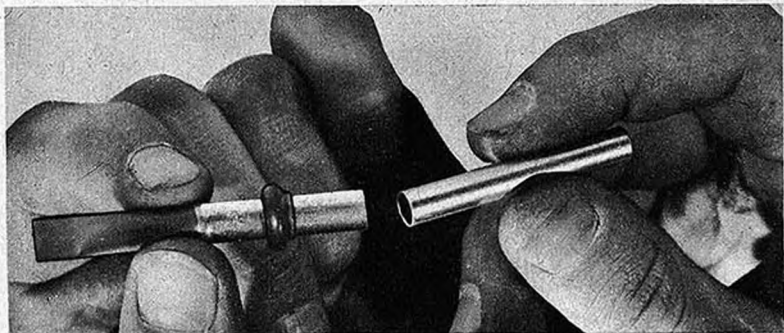

1. Insert detonator into fuze and fasten with rubber sleeve.

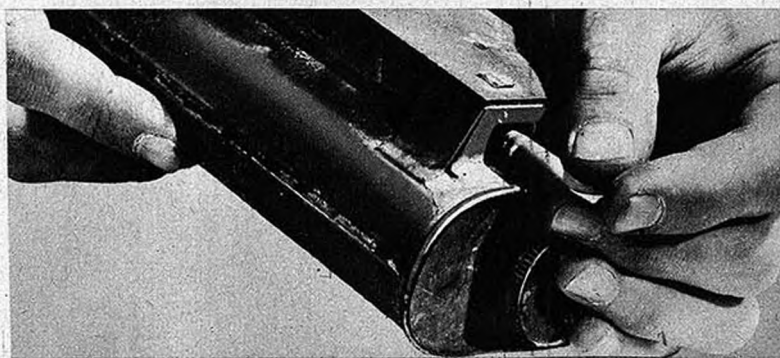

2. Insert fuzes into two pockets under pressure plate, pushing detonator end in first and insuring that red paint is visible in gap.

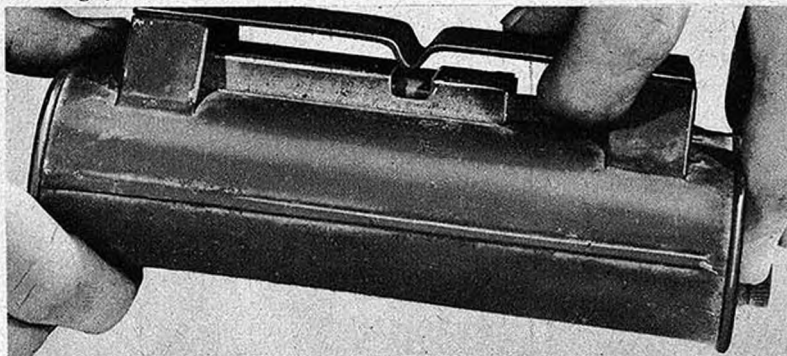

3. Close flaps at ends of pockets.

BRITISH NO. 75 HAWKINS GRENADE MINE, MARK 1

DISARMING

To disarm, defuze

DEFUZING

Open flaps of fuze pockets and remove fuzes. Take fuze assemblies apart. Store detonator and fuze separately.

PACKING AND TRANSPORTING



RE-USE

Can be re-used as often as necessary. Inspect fuze to see it has not been crushed.

SPACE FOR NOTES

BRITISH NO. 75 HAWKINS GRENADE MINE, MARK II

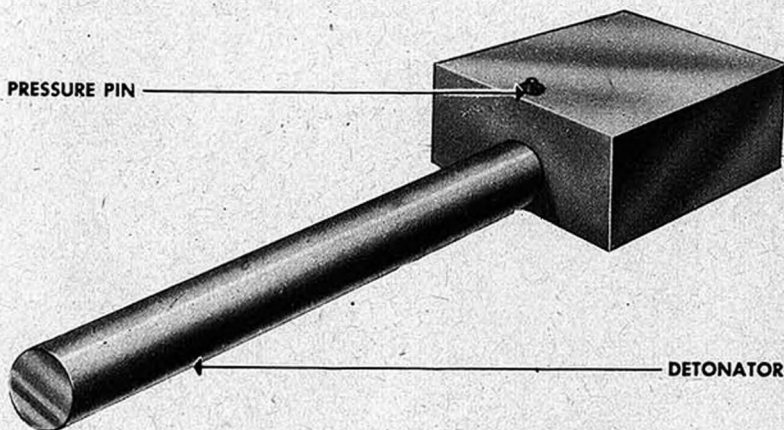

ONE-PIECE FUZE ASSEMBLY FOR
NO. 75 HAWKINS GRENADE MINE MARK II

Similar to Hawkins grenade mine, Mark I, with exception that fuze is in one piece, and is fired by pressure pin; and the fuze pockets are inclined at an angle to permit easier insertion. For description of Hawkins grenade mine, Mark I, see p. 61.05-a.

SPACE FOR NOTES

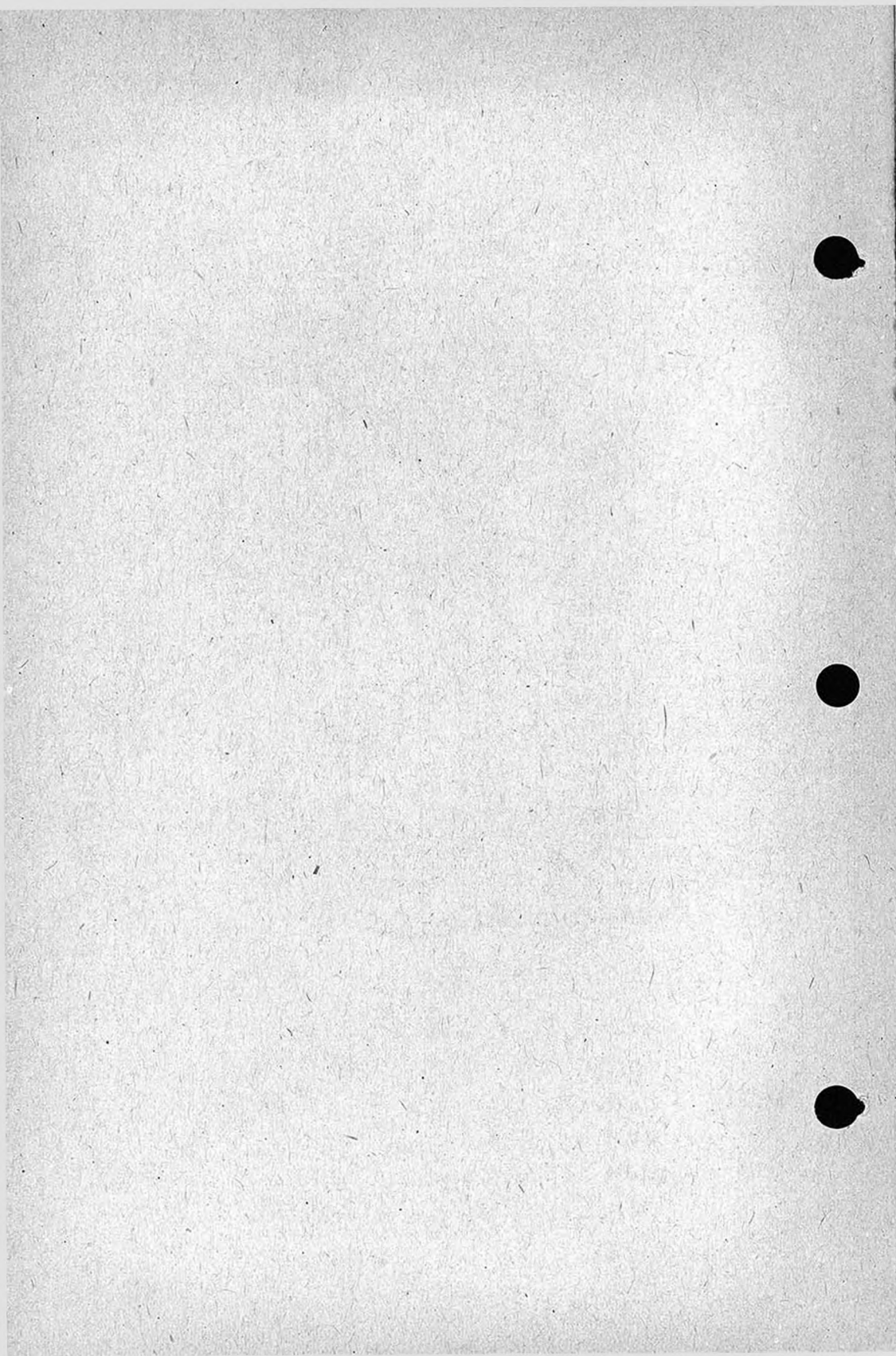

BRITISH SHRAPNEL MINE, MARK II

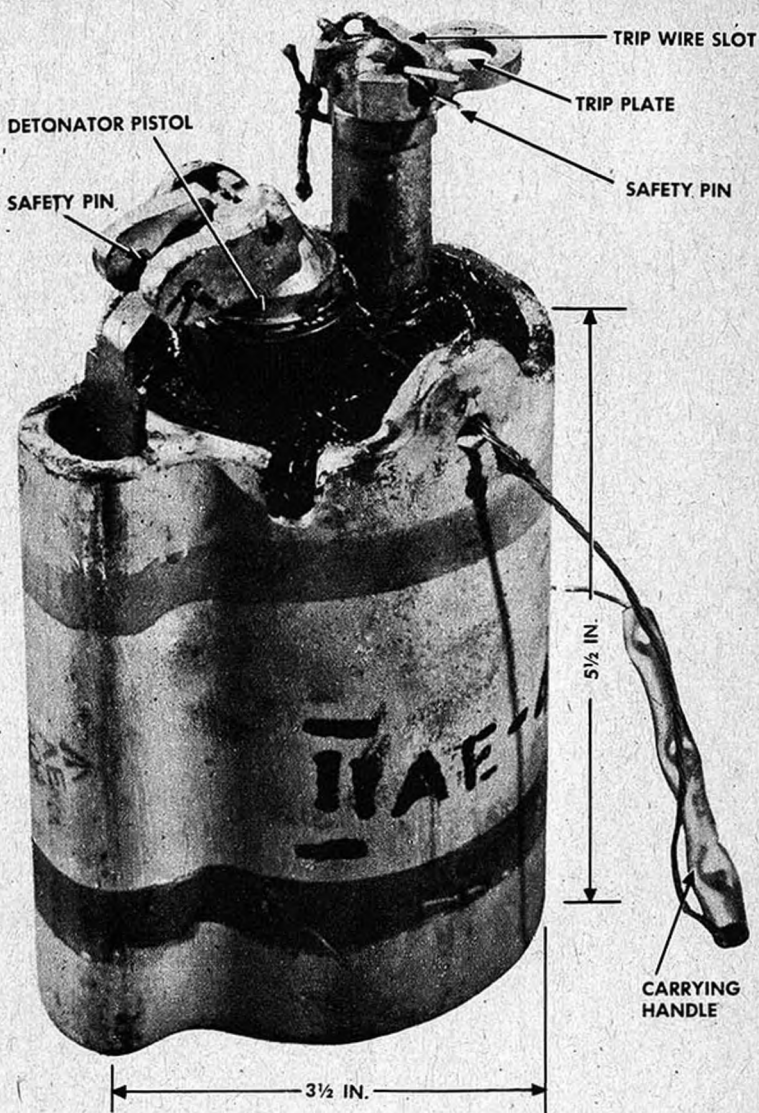

TYPE. Antipersonnel mine

COLOR. Yellow

CASE. Steel

WEIGHT. 10 pounds

EXPLOSIVE. 1 pound amatol

EFFECT. Casualties to personnel within 30 yards.

BRITISH SHRAPNEL MINE, MARK II

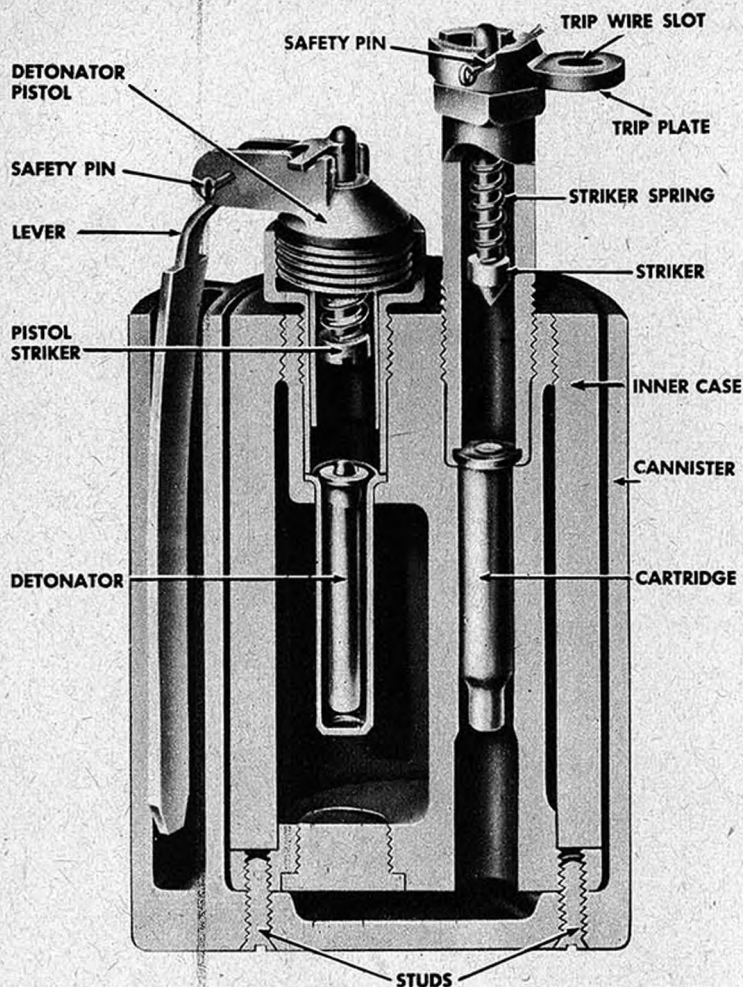

FUNCTIONING

1. Minimum pull of 4 pounds on trip wire pulls trip plate out of cartridge-pistol.
2. Striker is freed, and driven down by striker spring.
3. Striker fires cartridge.
4. Pressure from explosion shears studs and projects inner case upward.
5. As case leaves cannister, lever on detonator-pistol automatically pulls out of recess and springs outward, releasing striker.
6. Spring drives striker against detonator.
7. Detonator explodes charge when case is about 3 feet above ground.

BRITISH SHRAPNEL MINE, MARK II

INSTALLING AND ARMING

1. Dig hole so mine can be laid upright, with trip plate at ground level.
2. Unscrew cartridge-pistol with spanner tool. See that cartridge recess is clear.

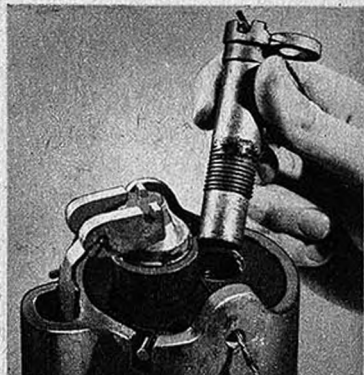

3. Insert ballistite cartridge provided with mine.

4. Replace cartridge-pistol and screw tight, making sure safety pin is pushed in.

5. Remove detonator-pistol, making certain safety pin is in place. Inspect socket to see if clear.



6. Insert detonator, small end first, so cap end rests on shoulder in socket.

7. Replace detonator-pistol so its firing lever engages in recess. Be sure safety pin is in place.

8. Put mine in hole, and pack earth around it.

9. Attach loose trip wire.

10. Remove detonator-pistol safety pin.

11. Fill hole.

12. Remove cartridge-pistol safety pin. If safety pin cannot be withdrawn easily, release tension and reset trip plate.

BRITISH SHRAPNEL MINE, MARK II

DISARMING

1. Replace detonator-pistol safety pin.
2. Replace cartridge-pistol safety pin.
3. Cut trip wire.

DEFUZING

After disarming, defuze mine by reversing fuzing procedure and removing detonator and cartridge.

PACKING AND TRANSPORTING

Mines complete with cartridge-pistols and detonator-pistols are packed four in a wooden box, with four cartridges, four detonators, a spanner tool, and two coils of trip wire. Total weight, 54 pounds.

RE-USE

Before re-use, test as follows: After disarming pistols, lift mine and examine externally. In removing cartridge and detonator, note any tendency to stick. If either cartridge or detonator cannot be removed, discard mine. Examine cartridge and detonator for corrosion. Examine empty pistol sockets, and cartridge and detonator recesses, for corrosion and wetting. Detonator socket particularly should be inspected for blue or green incrustation. If found, discard mine. Test some of removed ballistite cartridges and detonators by firing separately.

SPACE FOR NOTES

BRITISH SHRAPNEL MINE, MARK I

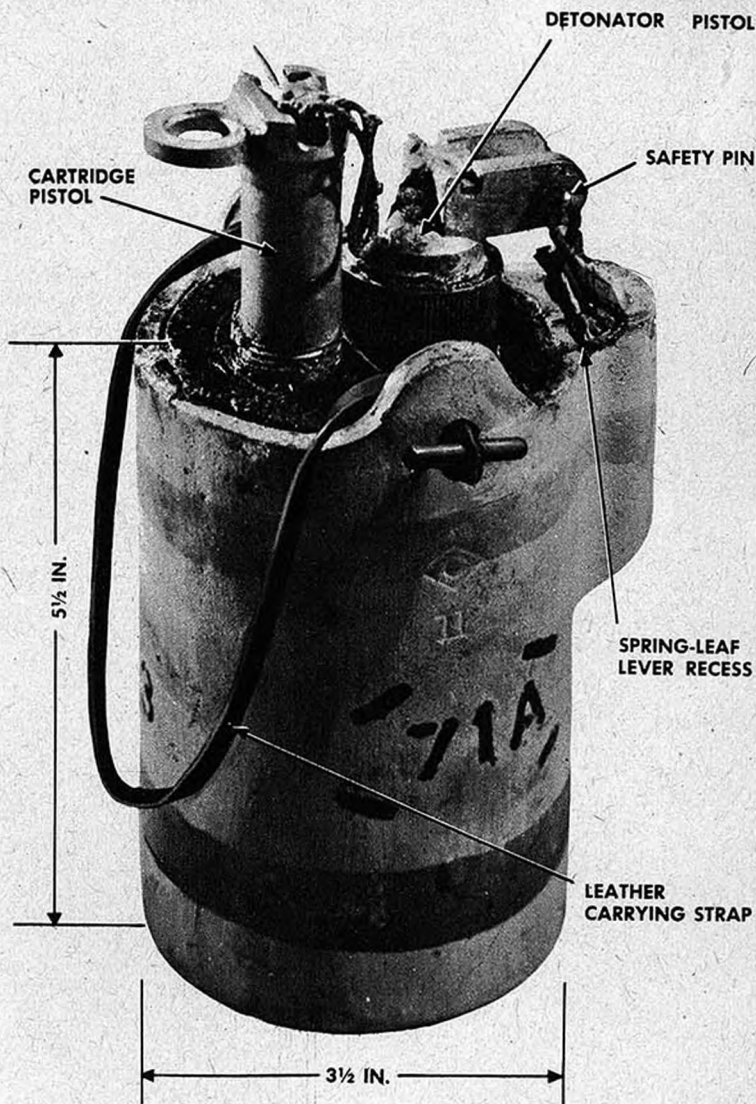

The Mark I is the earlier issue of the shrapnel mine and differs only slightly from the Mark II (page 62.01-a). These differences are as follows:

1. The Mark I spring leaf lever is shorter, and recess for it does not extend full depth of mine.
2. Mark I has a leather carrying strap.
3. Detonator of Mark I has a slight delay action; that of Mark II has none.

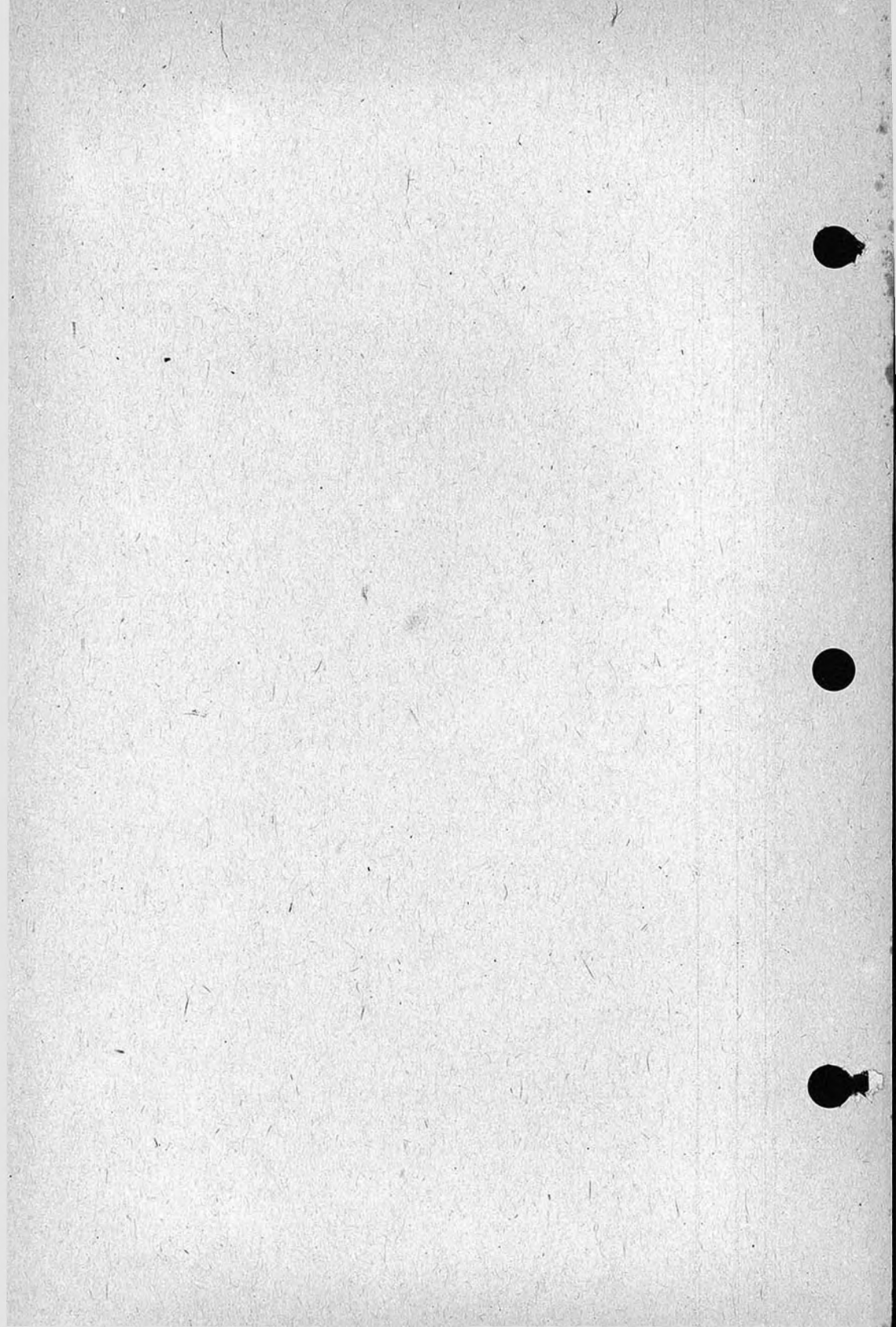

BRITISH RELEASE FUZE NO. 6

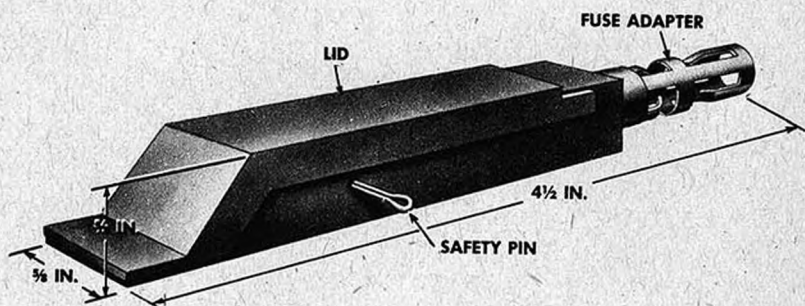

TYPE. Release fuze

COLOR. Matt khaki

CASE. Alloy metal

EMPLOYMENT

Inserted into narrow opening, as under door or behind drawer. Will withstand heavy weight, such as packing case.

INSTALLING AND ARMING

1. Connect fuze to detonator by adapter.
2. Install fuze in desired position.
3. Connect charge.
4. Withdraw safety pin, which should come out easily.

DISARMING

Insert safety pin through safety-pin hole. Disconnect cap holder

PACKING AND TRANSPORTING

Two per cardboard carton. Five cartons per tin. Twenty tins per case about 22 by 10½ by 6 inches. Weight, 60 pounds.

BRITISH RELEASE FUZE NO. 6

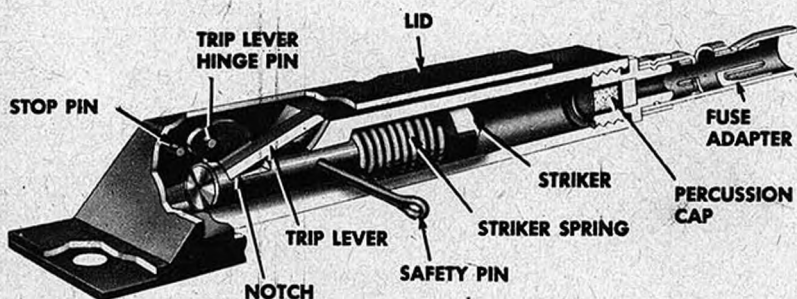

FUNCTIONING

1. When load on lid is removed, pressure of trip lever forces lid upward.
2. Pressure of cocked striker swings trip lever counterclockwise and disengages notch.
3. Pressure of compressed spring drives striker against percussion cap.

RE-USE

TO RECOCK—

1. Unscrew cap holder and fuze adapter.
2. Withdraw striker and spring.
3. Throw trip lever over until it rests on stop pin.
4. Insert spring and striker, notch uppermost.
5. Push back striker with pencil or rod, and insert safety pin.
6. Throw trip lever forward.
7. Close lid.
8. Screw in new fuze adapter with cap.

BRITISH RELEASE FUZE NO. 3

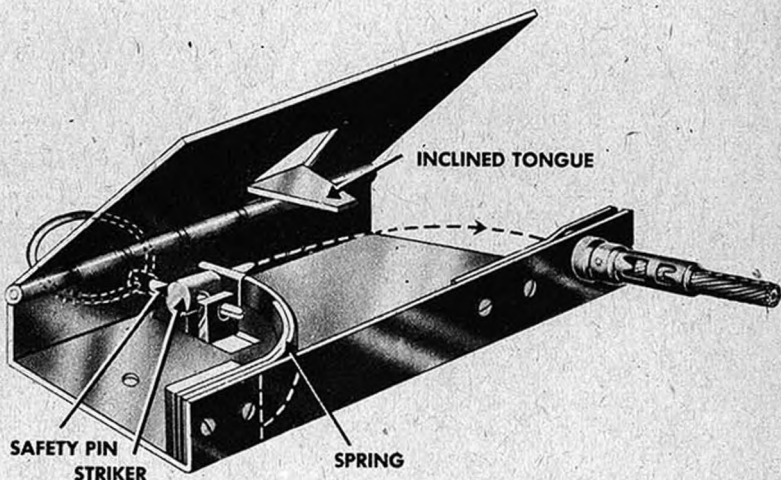

TYPE. Release fuze

COLOR. Olive-drab

CASE. Flat steel box

EMPLOYMENT

Placed under crates, packages, or other suitable objects in booby-trap installations.

FUNCTIONING

1. On removal of pressure, pressure of spring on inclined tongue forces lid upward.
2. Spring and striker released.
3. Striker driven against percussion cap.

BRITISH RELEASE FUZE NO. 3

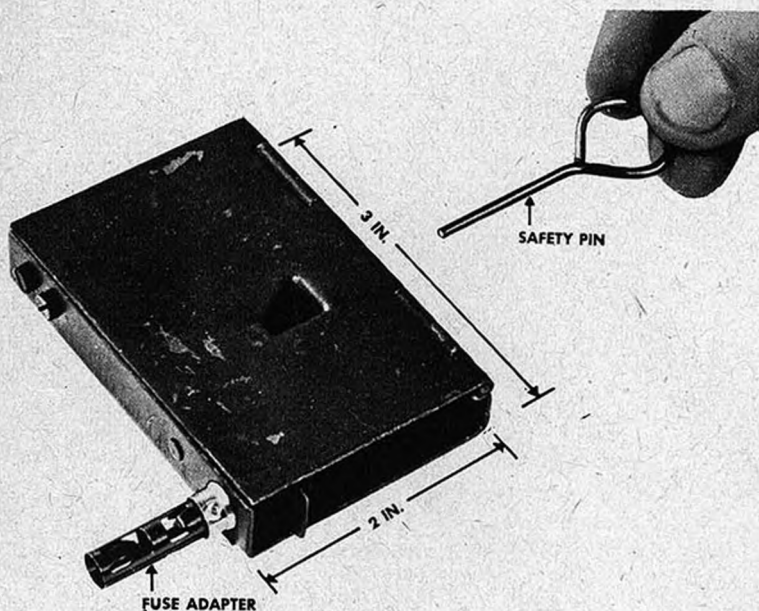

INSTALLING, FUZING AND ARMING

1. Bend leaf spring back until hole in striker comes opposite safety-pin hole.
2. Insert safety pin.
3. Insert fuse adapter in hole in side of box.
4. Close lid.
5. Place under object so lid is closed tightly.
6. Connect fuze to charge.
7. Withdraw safety pin. With sufficient weight on cover, safety pin will be loose enough to pull out easily.

DISARMING

If device is accessible, insert safety pin in safety-pin hole side of box. If inaccessible, cut fuse connecting release fuze to charge.

PACKING AND TRANSPORTING

Fuzes and percussion caps wrapped in wax paper are packed 10 per tin in flat, tin boxes sealed with adhesive tape. Twenty tins per wooden box 26 by $9\frac{1}{2}$ by $8\frac{1}{2}$ inches. Weight, 77 pounds.

RE-USE

Test by cocking device and slowly releasing pressure on lid. After testing, recock. After test firing, striker may need re-adjustment.

BRITISH PISTOL GROUND SPIKE

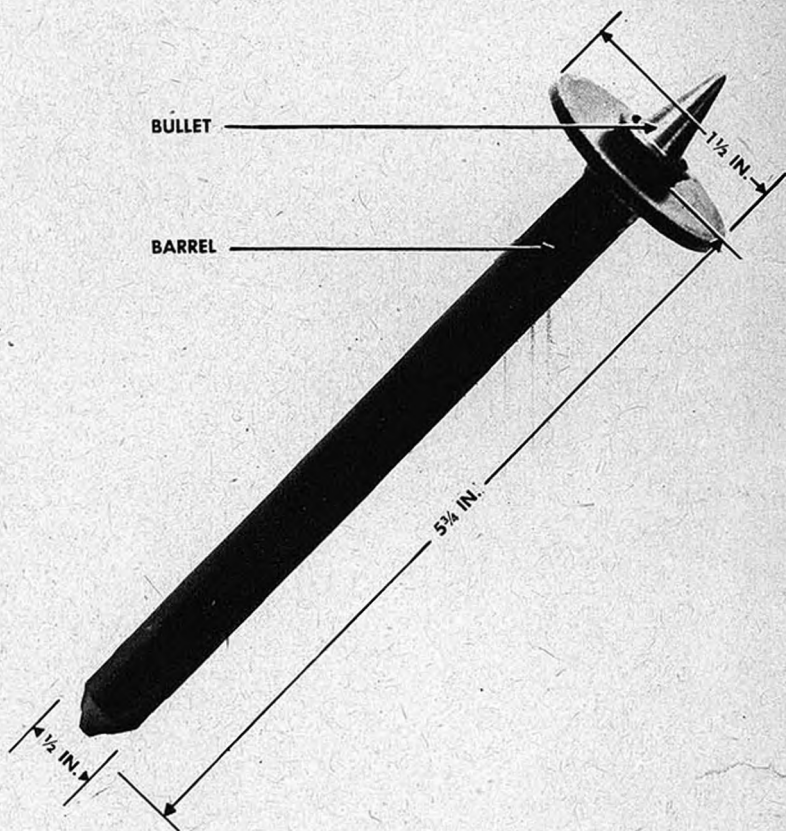

TYPE. Antipersonnel mine

COLOR. Black, olive-drab, or aluminum color

CASE. Steel

EMPLOYMENT

This self-contained unit, which discharges a bullet, is sunk into roads and pathways. It is fired by pressure. Bullet will perforate a man's foot or severely damage a pneumatic tire.

DISARMING

Remove cartridge.

PACKING AND TRANSPORTING

Devices, complete with cartridges, are wrapped in waxed paper, packed in flat tin box, and sealed with adhesive tape. Ten per tin. Twenty tins per wooden box 28 by 11 by 8 1/4 inches. Weight, 94 pounds.

BRITISH PISTOL GROUND SPIKE

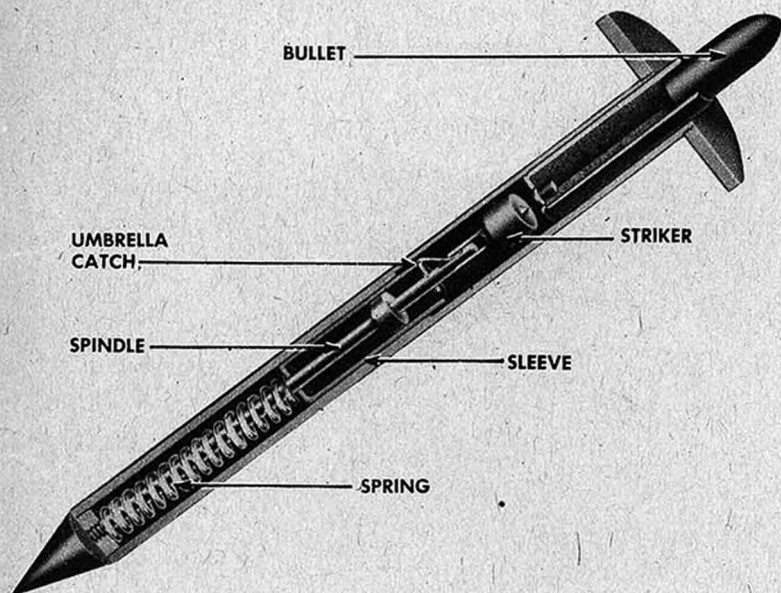

CAUTION

Never put cartridge into spike except when laid.

FUNCTIONING

1. Slight pressure on top of bullet forces hollow stem of striker over umbrella catch, releasing sleeve holding spring in compression.
2. Spring drives sleeve upward against striker head.
3. Impact drives striker against cartridge.

TESTING

Test by cocking firing sleeve and inserting striker. Depressing striker with unsharpened end of pencil will compress catch, releasing firing sleeve. Impact can be felt in pencil.

INSTALLING AND ARMING

Usually comes cocked ready for use, being kept in position in spike by a cork. If necessary to cock—

1. Push empty barrel into ground to level of flange.
2. Place firing sleeve, rounded end down, over spring, and push down until catch engages.
3. Place cocked mechanism in barrel.
4. Lower striker into barrel.
5. *At arm's length*, lower cartridge gently into barrel point upward. Hold cartridge between fingers; then in case of a premature firing a finger will not be blown off.

BRITISH PRESSURE FUZE NO. 2

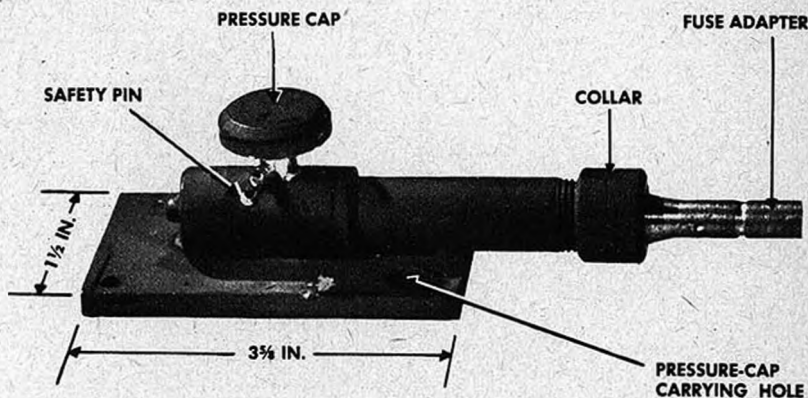

TYPE. Pressure fuze.

COLOR. Olive-drab

CASE. Brass body and base plate

EMPLOYMENT

Used under boards, door mats, and the like in booby-trap installations where actuation by pressure is desired.

PACKING AND TRANSPORTING

Fuzes, assembled with percussion caps and fuze adapters, are wrapped in waxed paper and packed in tens in flat, tin boxes sealed with adhesive tape. Twenty tins per wooden box, 26 by 9 1/2 by 8 1/2 inches. Weight, 92 pounds.

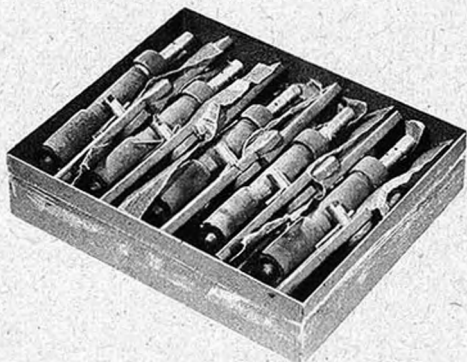

BRITISH PRESSURE FUZE NO. 2

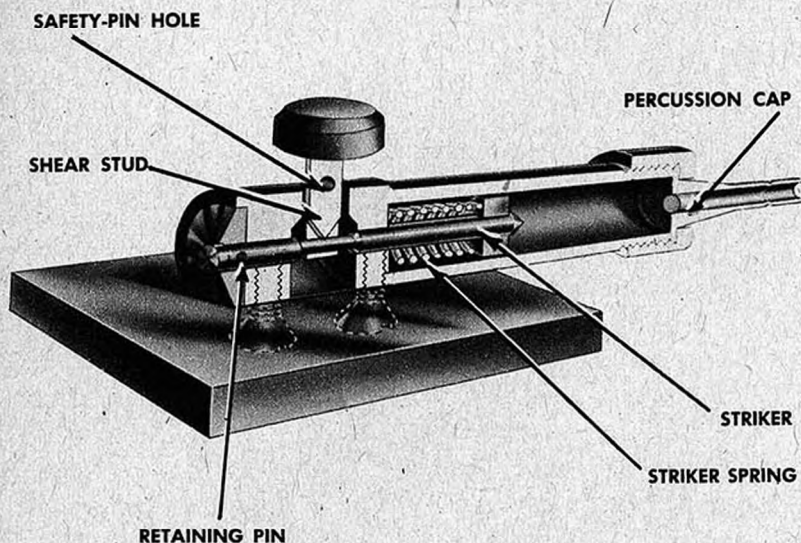

FUNCTIONING

1. Load of 30 to 40 pounds causes V-shaped cutting edge of shear stud to break striker rod.
2. Striker, driven forward by spring, fires cap.

INSTALLING AND ARMING

1. Remove pressure cap from base plate, to which it is attached during transport.
2. Insert pressure cap in hole in body, and position it to straddle striker rod. If properly placed, pressure cap cannot be rotated.
3. Unscrew collar and remove fuze adapter.
4. Place fuze in position.
5. Reattach collar and fuze adapter.
6. Remove safety pin.

DISARMING

Insert safety pin. Lift pressure cap out of casing. If this is not possible, cut fuze connecting fuze to charge.

RE-USE

Unscrew collar; remove fuze adapter, and make sure striker is in cocked position. If striker rod has been sheared, striker will fall out of barrel and fuze cannot be re-used.

BRITISH PRESSURE FUZE NO. 5

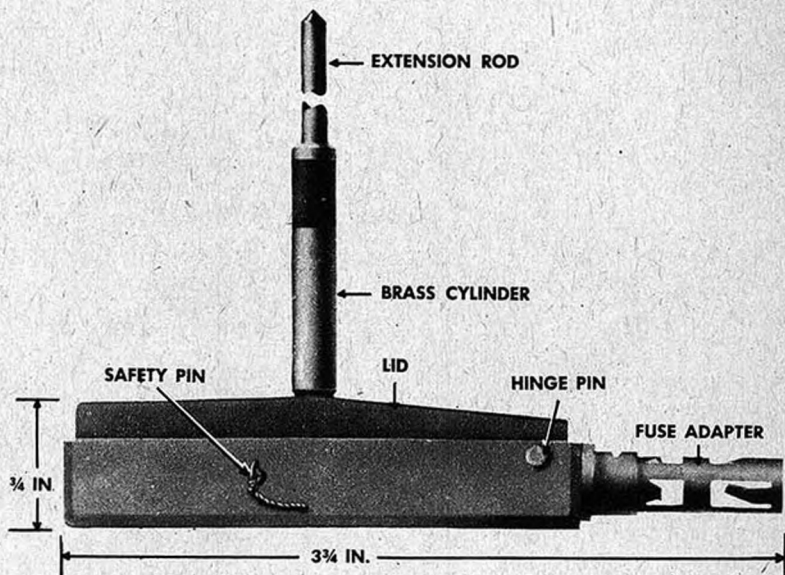

TYPE. Pressure fuze

COLOR. Dull khaki

CASE. Alloy metal

EMPLOYMENT

To explode booby-trap charge by pressure. Adjustable extension rod enables mechanism to be used under railway track.

PACKING AND TRANSPORTING

Two devices, complete with extension rods and adapters, per cardboard carton. Five cartons per tin. Twenty tins per wooden box, 22½ by 11½ by 8¼ inches. Weight, 90 pounds.

RE-USE

TO RECOCK

1. Unscrew fuze adapter.
2. Withdraw striker.
3. Reinsert striker and striker spring, notch facing downward.
4. Push back striker with wooden rod until lips of trip lever engage notch.
5. Insert safety pin.

BRITISH PRESSURE FUZE NO. 5

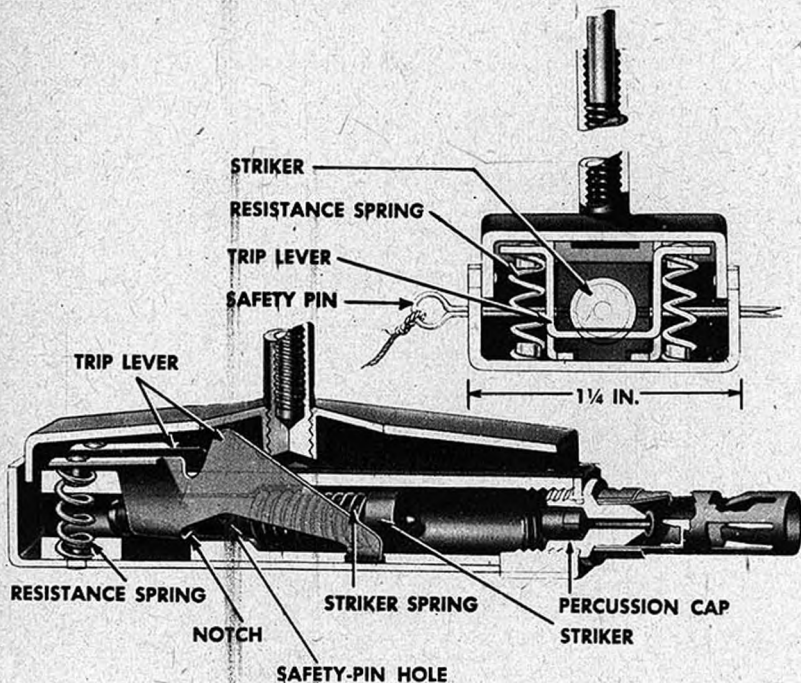

FUNCTIONING

1. Pressure required to operate varies with position on lid on which it acts. At end farthest from hinges 21 pounds, and at center of lid 50 to 60 pounds are required to force lid down.
2. Double trip lever is depressed against resistance of spring.
3. Trip lever clears notch, freeing striker.
4. Striker spring drives striker against percussion cap.

INSTALLING AND ARMING

WITHOUT EXTENSION ROD

1. Set device in desired position.
2. Connect charge.
3. Withdraw safety pin.

WITH EXTENSION ROD

1. Screw brass cylinder tightly into lid, and screw extension rod to its lowest limit in cylinder.
2. Set device in position.
3. Unscrew rod until contact is made with rail or other object.
4. Connect charge.
5. Withdraw safety pin.

DISARMING

Insert safety pin in safety-pin hole. Remove fuze adapter.

BRITISH PULL FUZE NO. 1

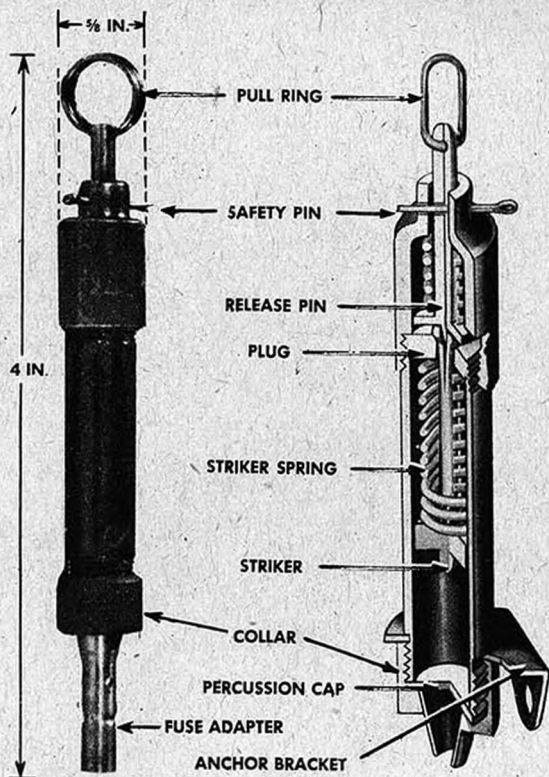

TYPE. Pull fuze

COLOR. Olive-drab

CASE. Steel

EMPLOYMENT

Primarily for use with trip wire in booby traps; also to fire mines, charges, and flares.

FUNCTIONING

1. Pull of about 2 pounds pulls release pin outwards.
2. Split tail of striker contracts and passes through opening in plug.
3. Striker spring drives striker onto percussion cap.

RE-USE

To test for re-use, unscrew collar and remove fuze adapter. Hold fuze with open end against piece of wood. Take out safety pin and gently pull release pin. Striker should descend, driving its point well into wood. To recock, push back striker with wooden rod until release pin slips into end of split tail of striker and locks it in place.

BRITISH PULL FUZE NO. 1

INSTALLING AND ARMING

1. Remove fuze adapter by unscrewing collar.
2. Anchor by means of bracket.
3. Slip barrel through outstanding leg of bracket.
4. Replace collar without fuze adapter.
5. Install loose trip wire.
6. Connect charge to fuze adapter by detonating cord.
7. Reset fuze adapter on fuze by collar.
8. Withdraw safety pin gently. With installation properly set, safety pin should be loose in its hole.

DISARMING

Insert safety pin in safety-pin hole. Cut trip wire. Remove fuze adapter.

PACKING AND TRANSPORTING

Completely assembled with percussion caps and fuze adapter, fuzes are wrapped in waxed paper and packed in flat tin boxes sealed with adhesive tape. Ten fuzes per tin. Twenty tins per wooden box 14 by 9 inches. Weight, 52 pounds.

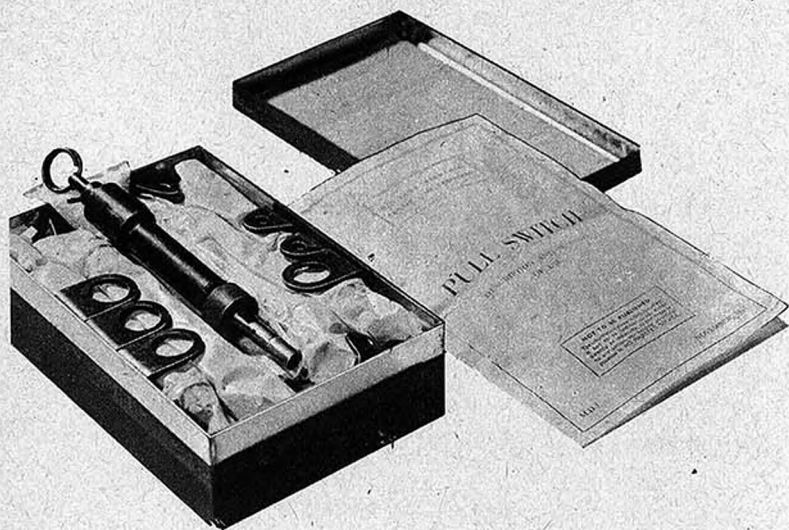

BRITISH PULL FUZE NO. 4

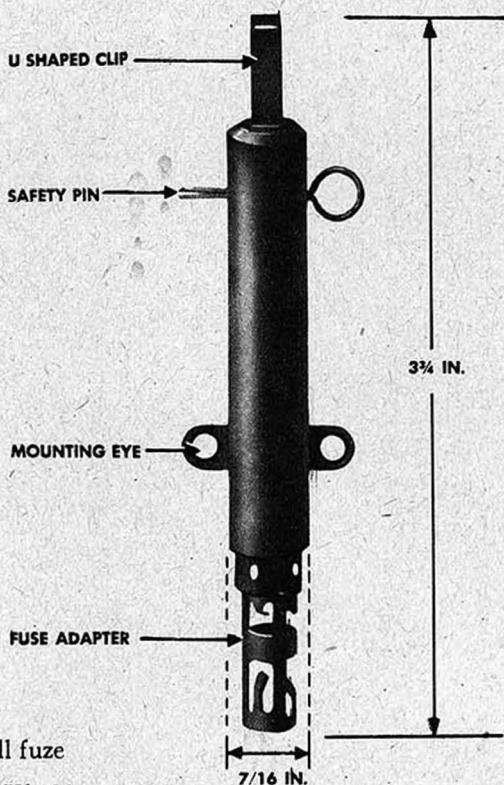

TYPE. Pull fuze

COLOR. Khaki

CASE. Brass

EMPLOYMENT

Primarily for use with trip wire in booby traps; also to fire mines, charges, and flares.

PACKING AND TRANSPORTING

Two per carton. Five cartons per tin. Twenty tins per case about 20 by 9 1/2 by 6 inches. Weight, 35 pounds.

RE-USE

TO RECOCK

1. Unscrew fuze adapter.
2. With pencil, push back striker as far as it will go.
3. Use safety pin to twist striker rod until safety-pin hole is in line with two slots in body.
4. Fit U-shaped clip over ball end of striker rod.
5. Allow striker to come forward about 1/4 inch.
6. Insert safety pin.
7. Screw in new adapter with percussion cap.

BRITISH PULL FUZE NO. 4

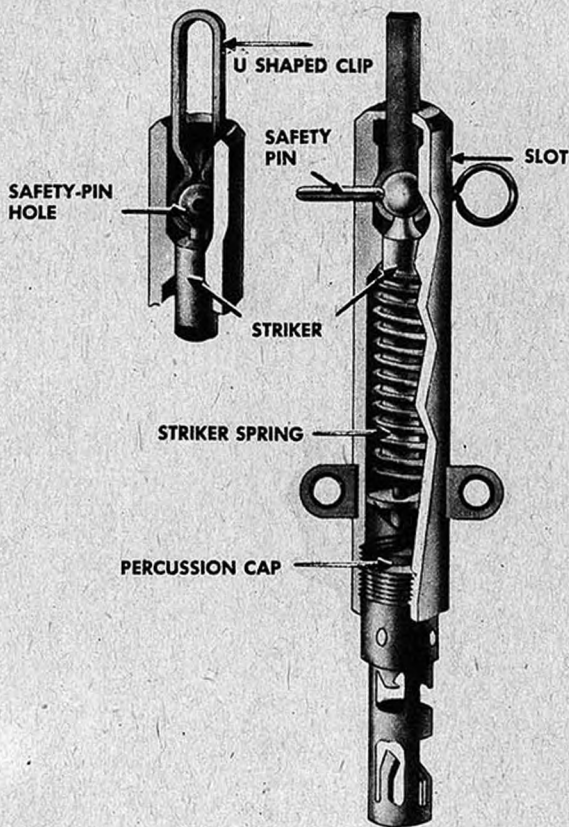

FUNCTIONING

1. Pull of 6 to 8 pounds withdraws U-shaped clip from ball end of striker.
2. Spring drives striker onto percussion cap.

INSTALLING AND ARMING

1. Unscrew fuze adapter.
2. Attach fuze to desired object.
3. Attach trip wire to U-shaped clip, adjust tension until safety pin lies about halfway along slots in body.
4. Connect charge to fuze adapter, screw adapter into end of pull fuze.
5. Withdraw safety pin. Too much tension on trip wire jams safety pin against ends of slots and prevents easy withdrawal.

DISARMING

If close inspection is possible, insert safety pin through slot in body and through safety-pin hole in ball end of striker. Check both ends of trip wire. Cut trip wire. Remove fuze adapter.

BRITISH PULL FUZE (PERCUSSION)

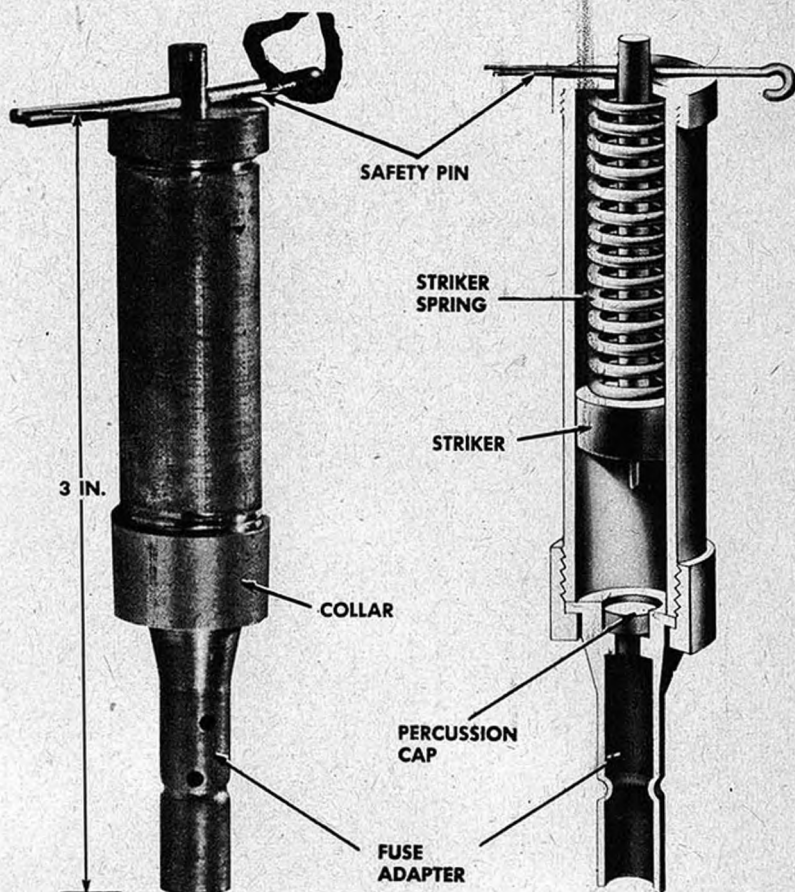

TYPE. Fuse lighter

CASE. Unpainted brass

EMPLOYMENT

As fuze lighter, manually operated, in firing charge nonelectrically. Operated by trip wire in improvised mines and booby traps. Ignites safety fuze, and fires blasting caps.

To eliminate noise and flash in igniting safety fuze, base of empty rifle cartridge case may be drilled to receive safety fuze, and open end flared so collar holds it.

FUNCTIONING

1. Pulling out safety pin releases striker.
2. Striker, driven by spring, fires percussion cap, which fires fuze in adapter.

BRITISH PULL FUZE (PERCUSSION)

INSTALLING AND ARMING

Insert fuze in open end of adapter. Attach trip wire to safety pin.

DISARMING

1. Cut trip wire.
2. Cut or detach fuze.

PACKING AND TRANSPORTATION

Ten per tin.

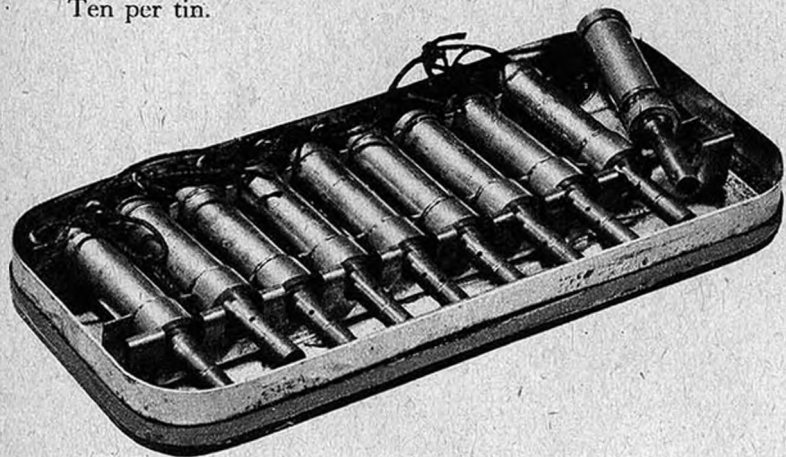

RE-USE

After firing, replace percussion cap.

SPACE FOR NOTES

BRITISH LEAD-BREAK DELAY FUZE

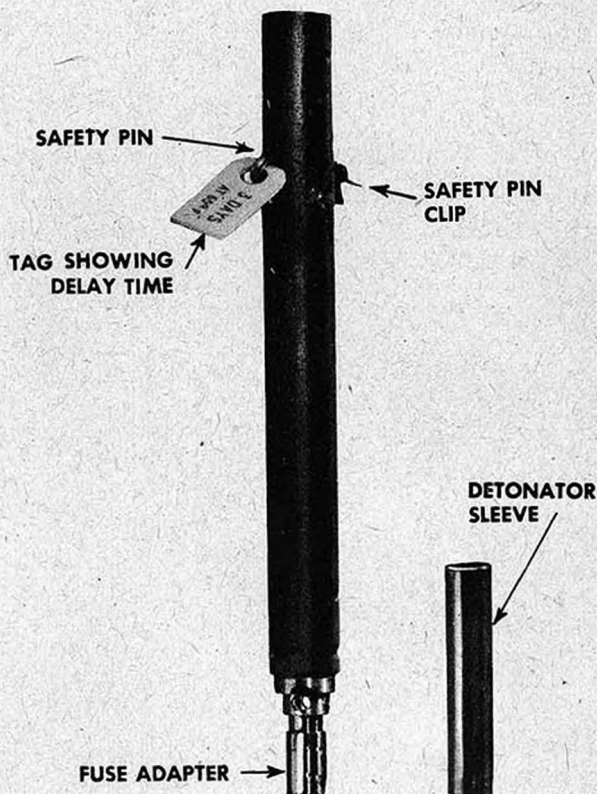

TYPE. Delay fuze

COLOR. Aluminum

CASE. Alloy metal

EMPLOYMENT

To explode charge by delayed action.

DISARMING

Impossible to disarm.

DEFUZING

Cannot be defuzed safely. If necessary to defuze, cut detonating cord or disconnect fuze from charge.

PACKING AND TRANSPORTING

Ten per tin. Fifty tins per wooden box about 26½ by 10 by 7 inches. Weight, 66 pounds.

RE-USE

Cannot be re-used.

BRITISH LEAD-BREAK DELAY FUZE

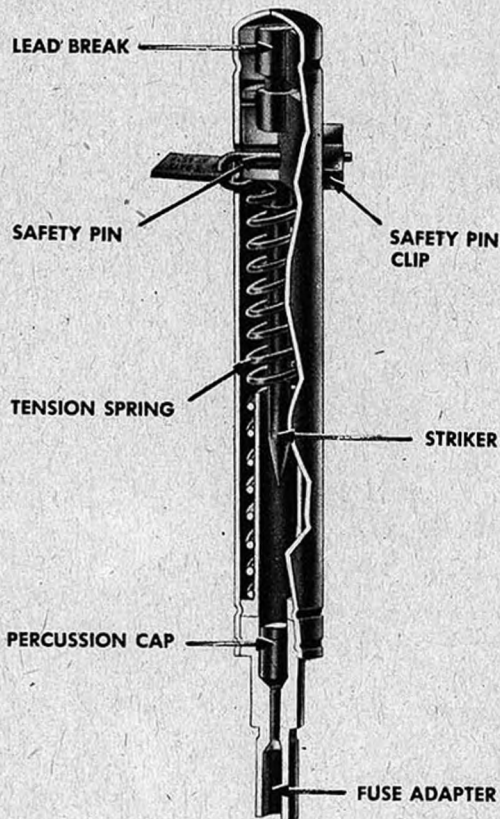

FUNCTIONING

When safety pin is removed, tension in spring is taken by lead rod. Lead stretches, breaks, allows spring to pull striker onto percussion cap.

INSTALLING AND ARMING

1. Refer to table and select proper fuze.
2. Withdraw safety pin.
3. Connect charge.

SPACE FOR NOTES

BRITISH CONTACT STRIP

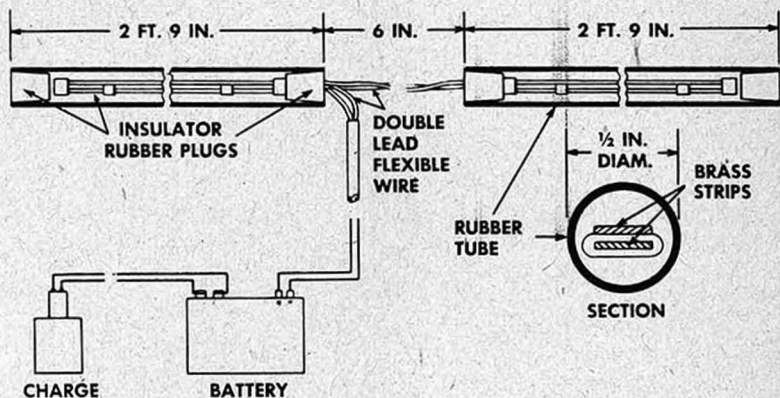

TYPE. Electric fuze

DESCRIPTION

Two red rubber tubes connected by wire, each tube containing two brass strips held apart by insulators.

EMPLOYMENT

In specialized form of trap for destroying wheeled or track vehicles. Laid across road surface probable path of traffic.

FUNCTIONING

Vehicle passing over either tube forces brass strips into contact, completing electric circuit. Nine-volt battery fires electric detonator, sets off 3- to 10-pound explosive charge.

INSTALLING AND ARMING

Before connecting battery to charge, test contact strip with electric blasting cap to see—

1. Brass strips are not in contact.
2. Pressure produces proper contact.
3. Contact is not maintained after pressure ceases.

SPACE FOR NOTES

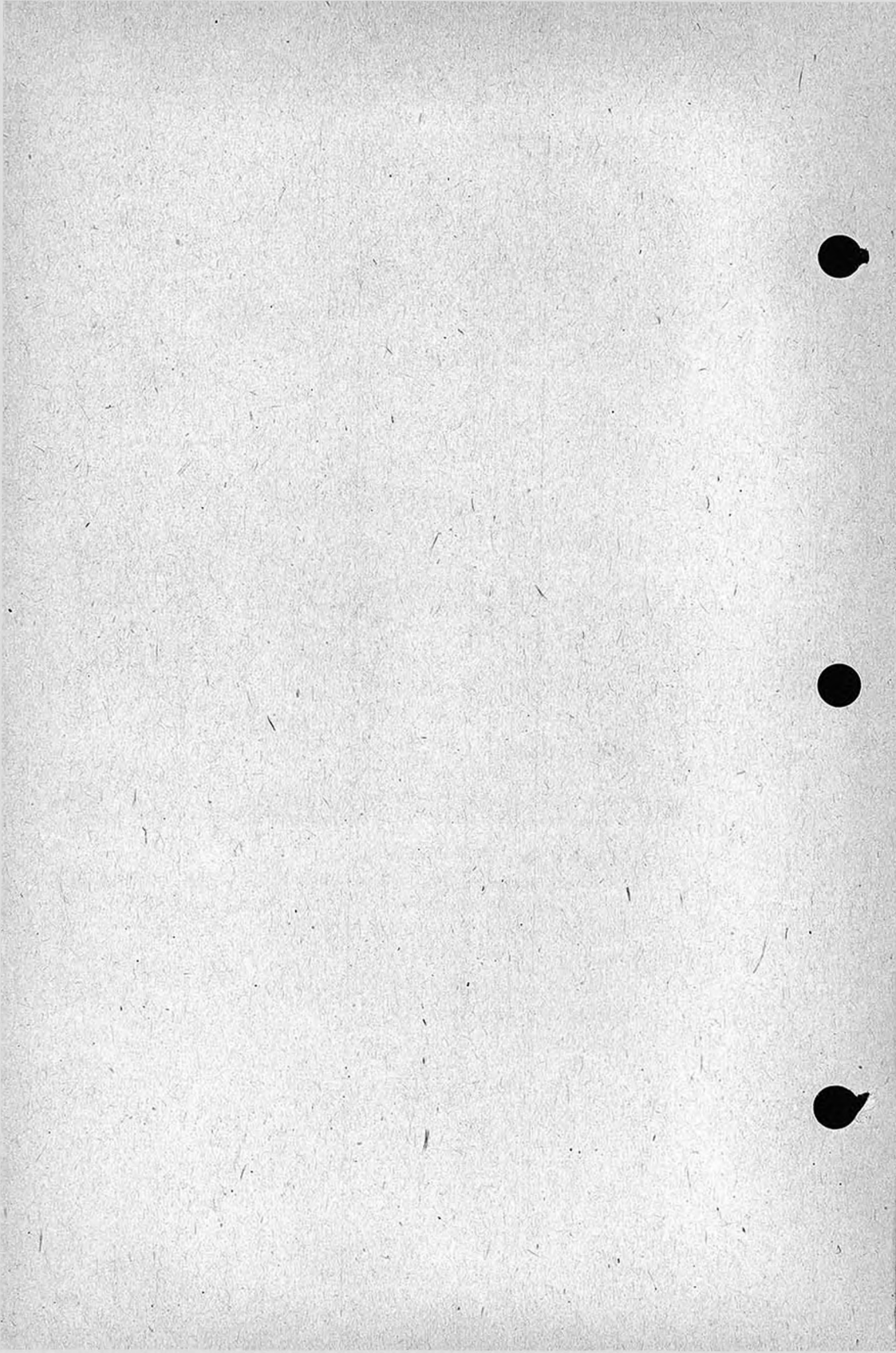

BRITISH 6-INCH SHELLS IN ROAD

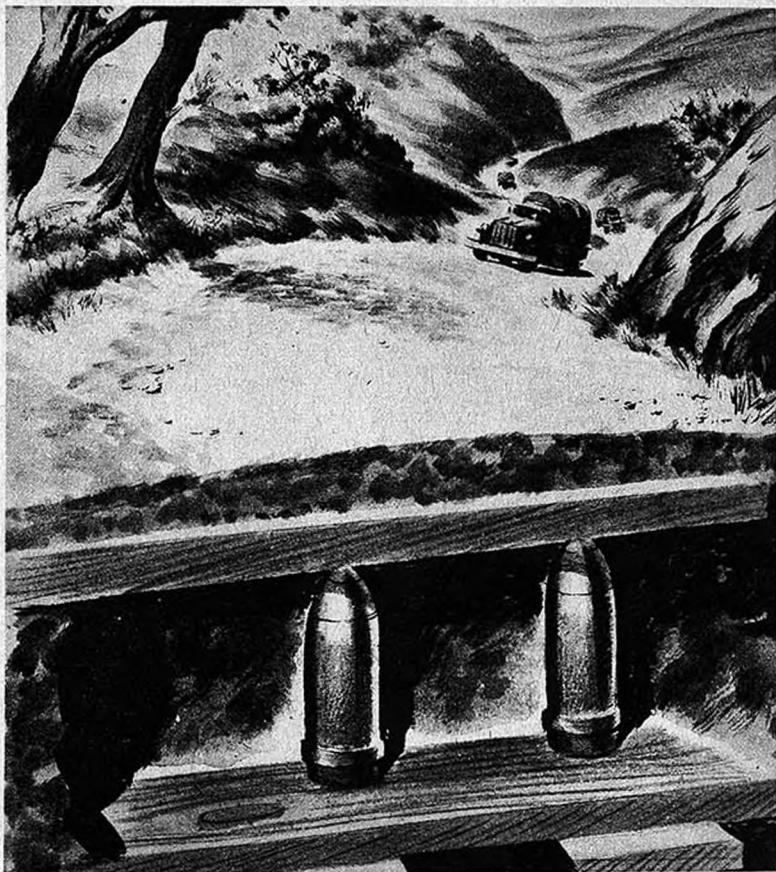

INSTALLING

For booby trapping, use shells with instantaneous percussion fuzes, safety device removed. Place board under shells for firm base, and on top of shells; cover to match road surface.

DISARMING

1. Remove covering and top board.
2. Remove fuzes from shells.
3. Lift shells.

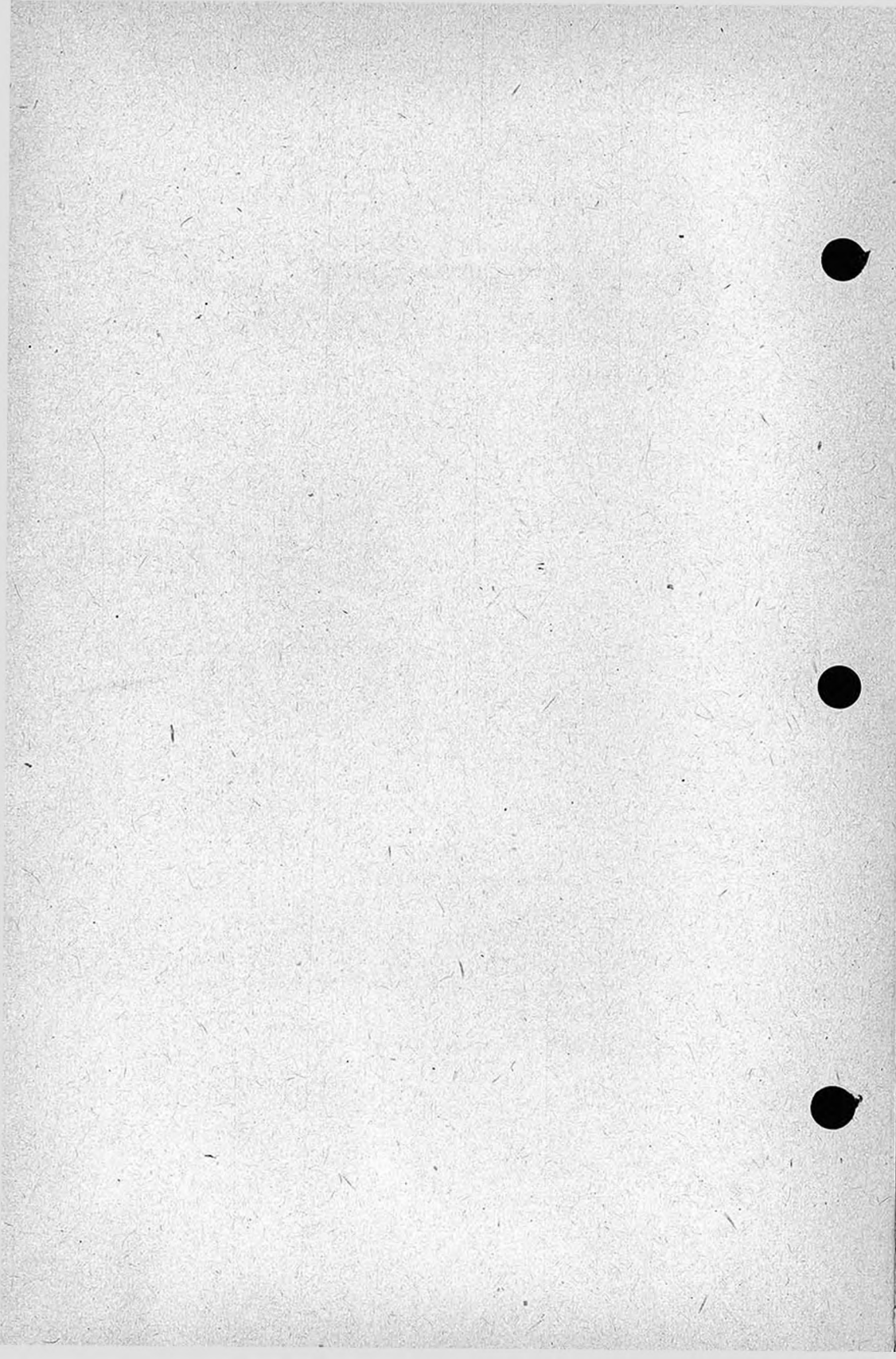

BRITISH BALL-BEARING CONTACT

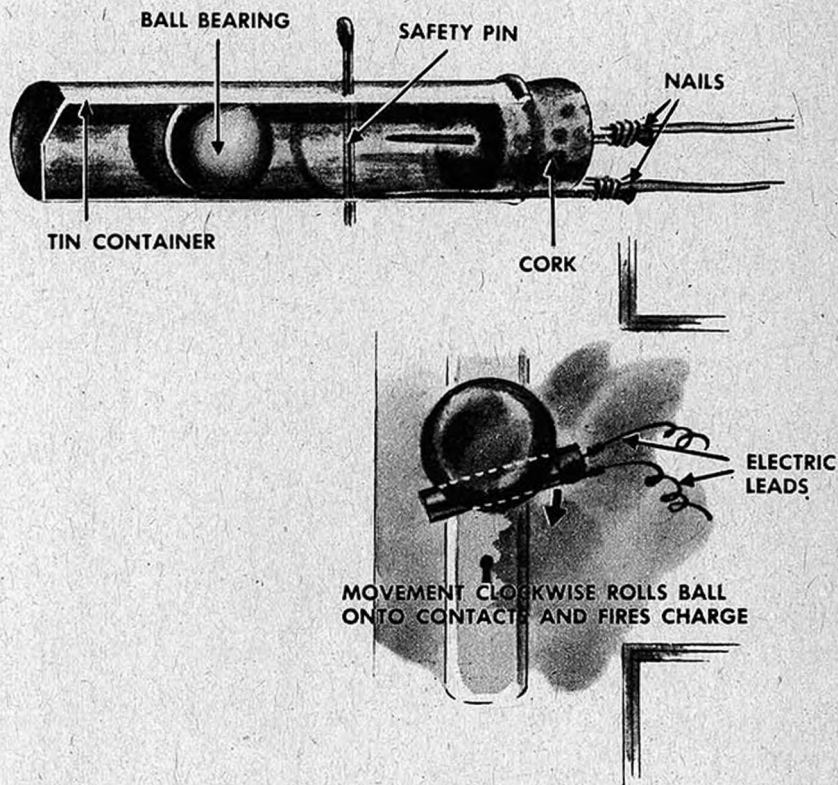

TYPE. Improvised electric contact

INSTALLATION

Make ball-bearing contact as shown in sketch, and fasten with string or adhesive tape to stem of inside door knob. Fix just above the horizontal, so turning knob will roll ball bearing against nails.

DISARMING. Disconnect battery

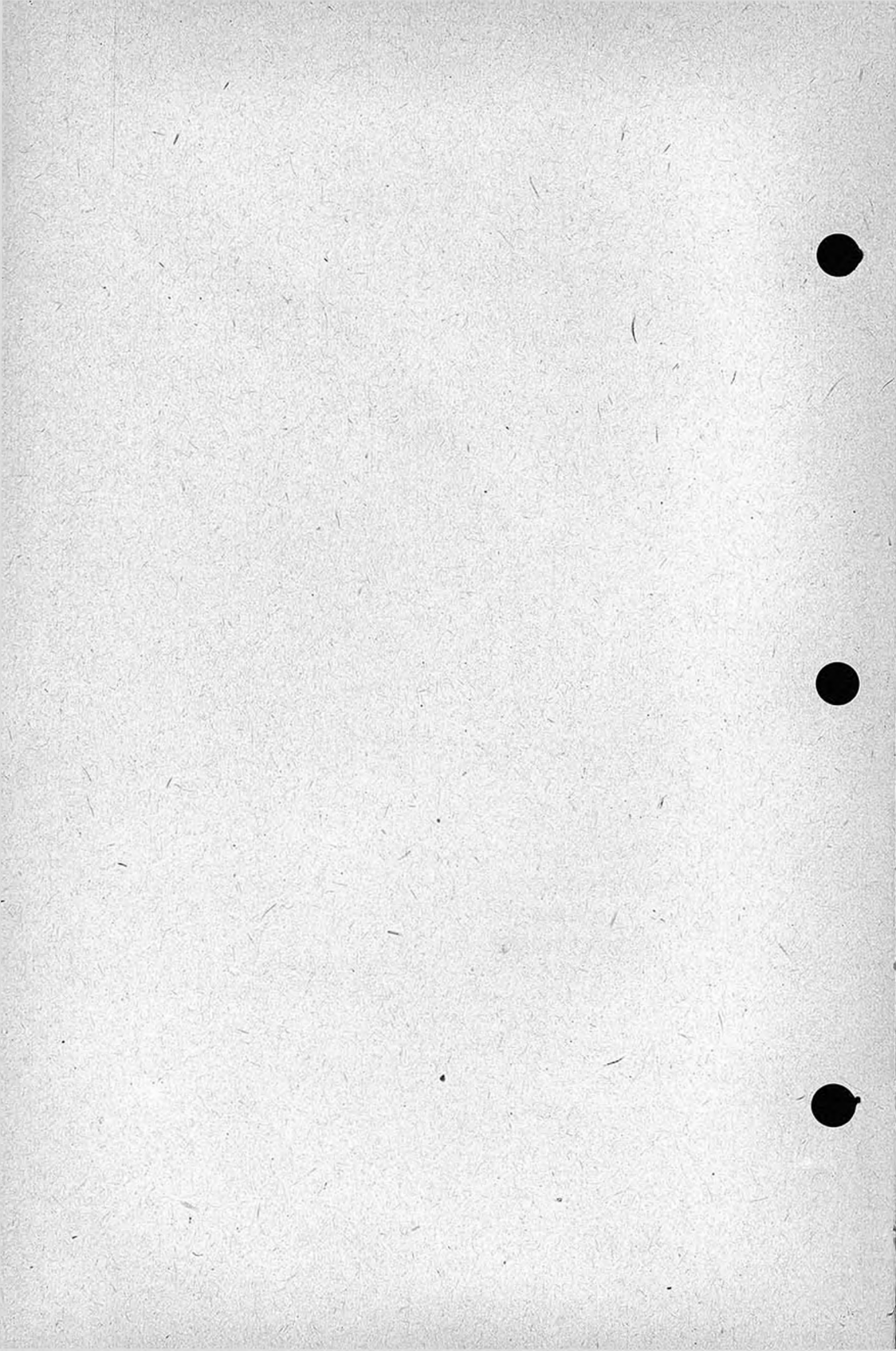

BRITISH TABLE-KNIFE SWITCH

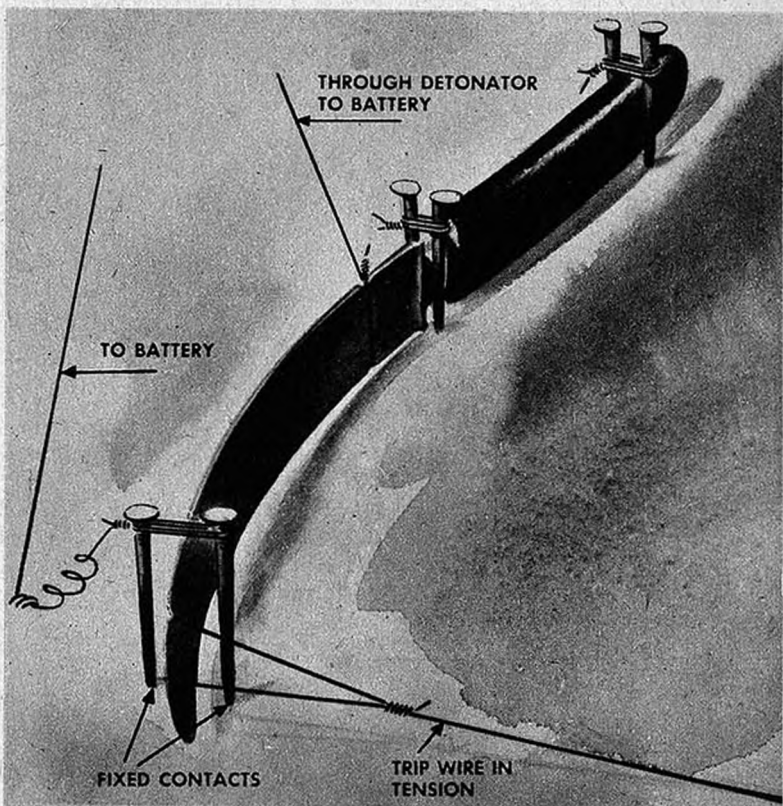

TYPE. Improved electric contact

EMPLOYMENT

As circuit closer for electrically fired booby-trap charge.

FUNCTIONING

Additional pull or release of tension in trip wire brings knife blade in contact with nail and completes circuit to fire electric cap, sets off main charge.

BRITISH TABLE-KNIFE SWITCH

INSTALLING AND ARMING

1. Attach lead wire and trip wire to knife blade.
2. Secure knife handle firmly in position.
3. Anchor trip wire in tension.
4. Drive nails for fixed contacts.
5. Install lead wire to connect nails to one terminal of battery.
6. Connect lead wire from knife blade through detonator to second terminal of battery.
7. Connect main charge.

DISARMING

Disconnect battery.

SPACE FOR NOTES

BRITISH PULL OR RELEASE ELECTRIC FUZE

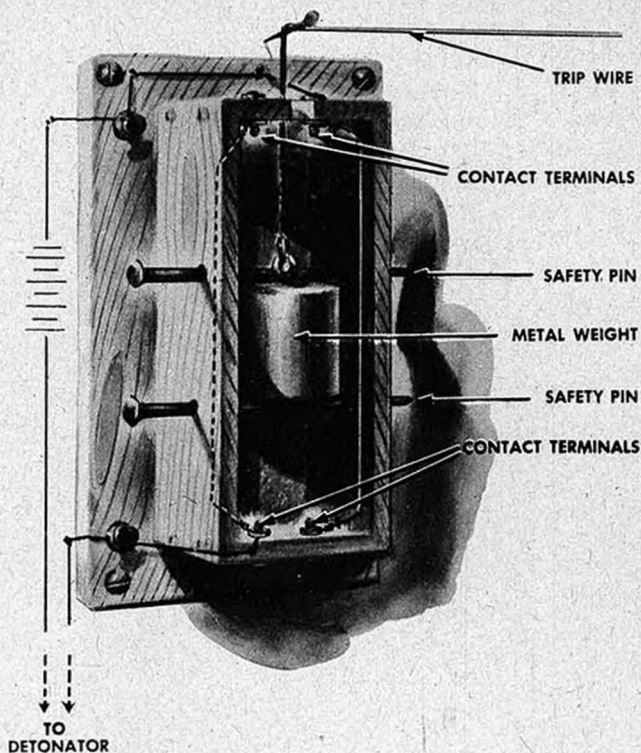

TYPE. Improved electric contact

EMPLOYMENT

As circuit closer for electrically fired booby-trap charge.

FUNCTIONING

Additional pull or release of tension in trip wire raises or lowers metal weight, which acts as bridge between contact terminals to complete circuit.

INSTALLING AND ARMING

Construct as shown in illustration. Battery can be mounted on backboard so switch and battery form a single assembly. Arm as follows:

1. Test for short circuit and for break.
2. Adjust trip-wire tension and insert safety pins so weight hangs between them without touching either.
3. Connect charge.
4. Remove safety pins.

DISARMING

Disconnect battery.

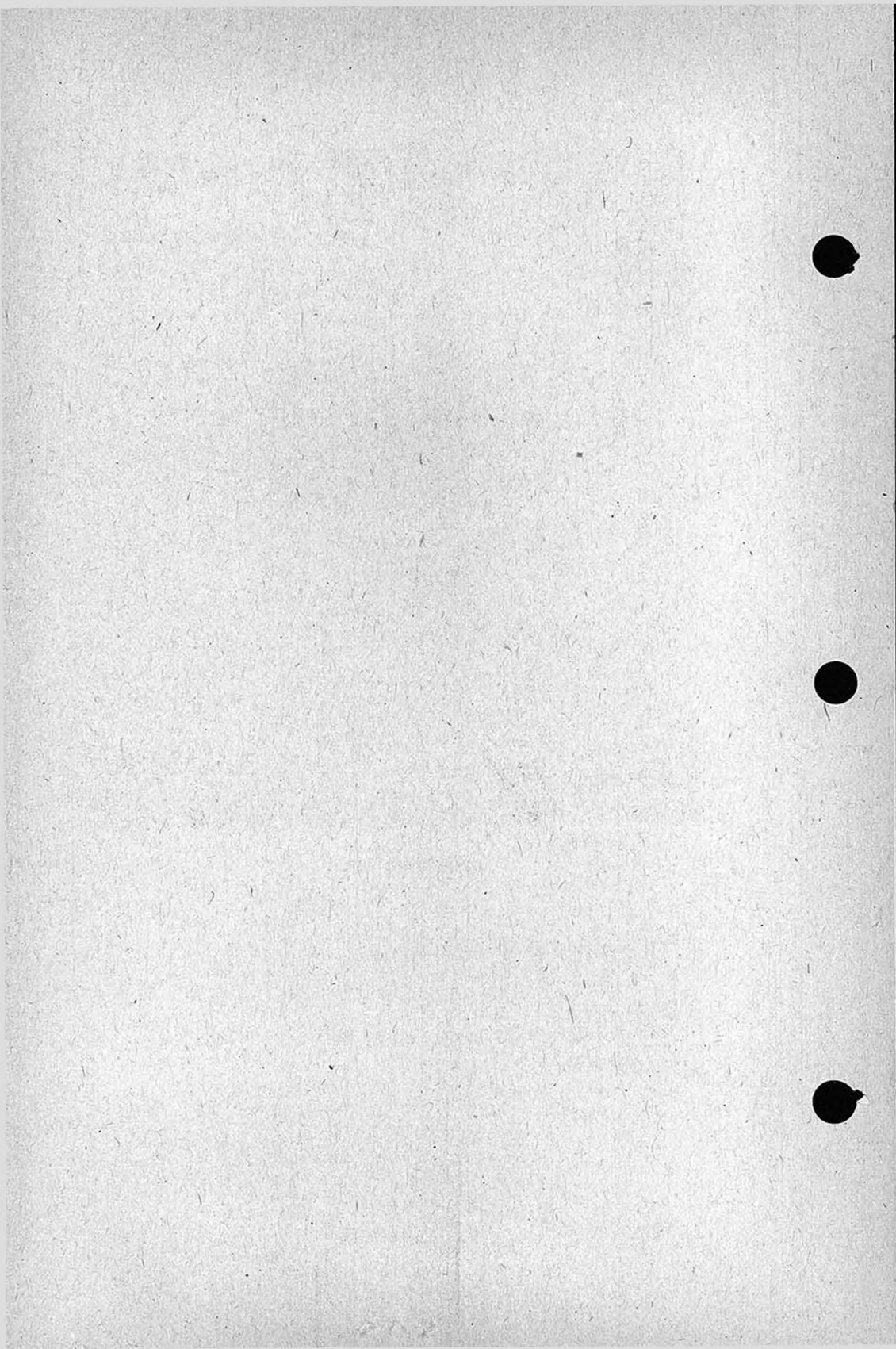

BRITISH RELEASE FUZE WITH RIFLE

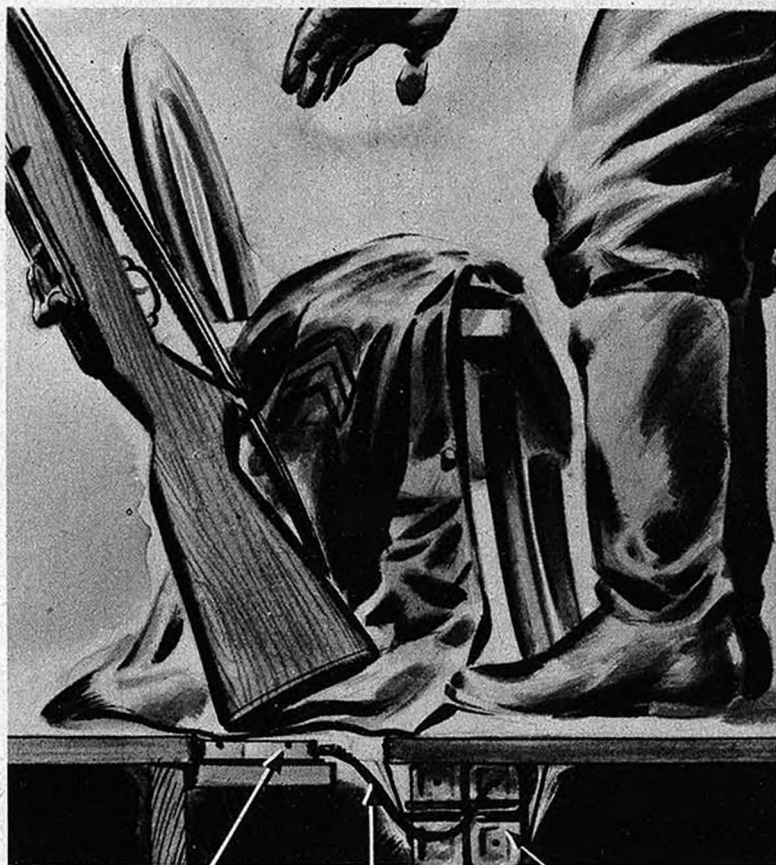

BRITISH RELEASE
FUZE NO. 3

DETONATING CORD

CHARGE

May be used in booby trap installed under flooring as shown in sketch.

INSTALLING

Follow directions for installing release fuze (see page 63.06-b).

DISARMING

Locate fuze, identify, and follow directions for disarming it (same reference).

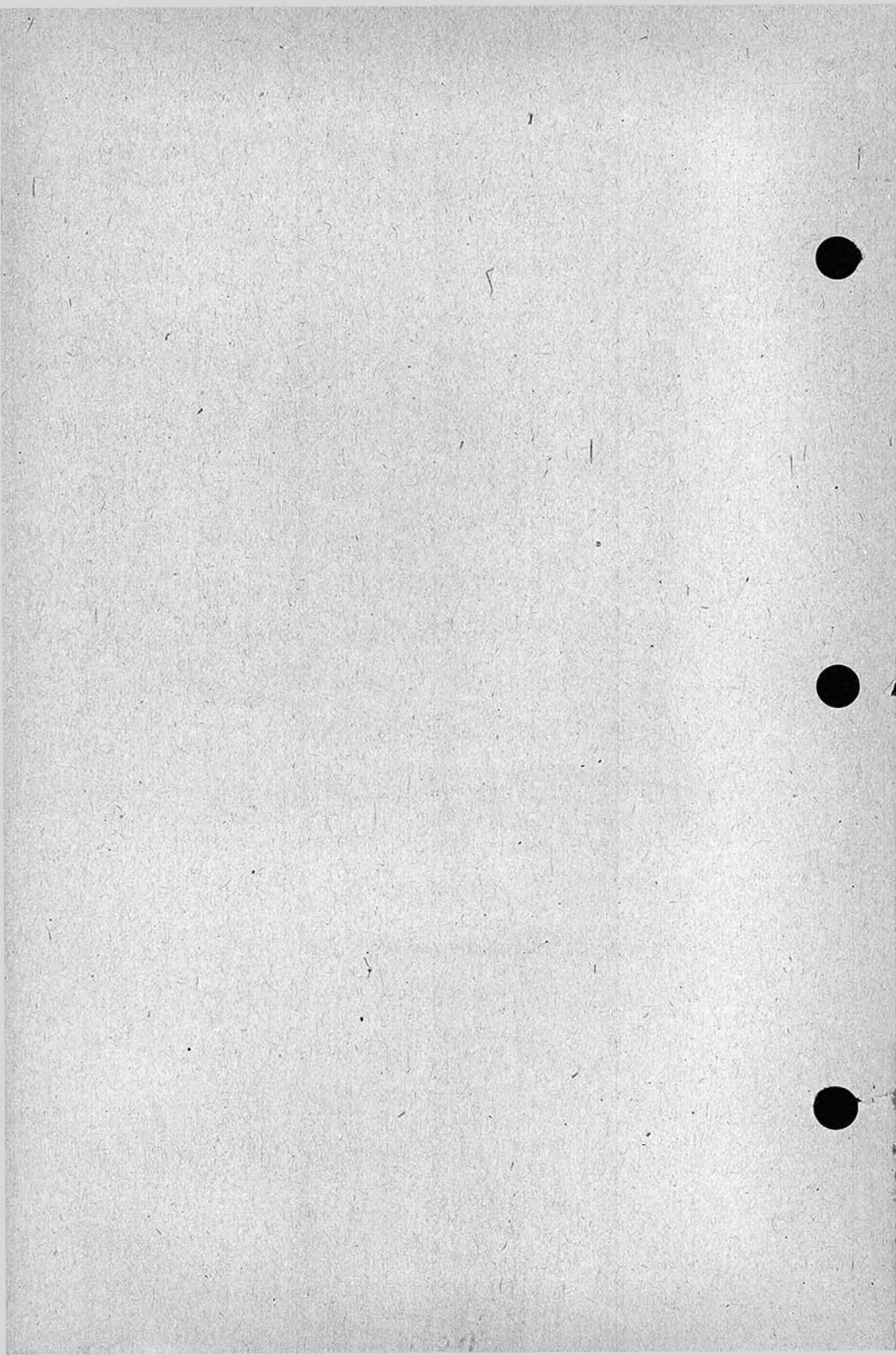

BRITISH DOUBLE-DRAWER BOOBY TRAP

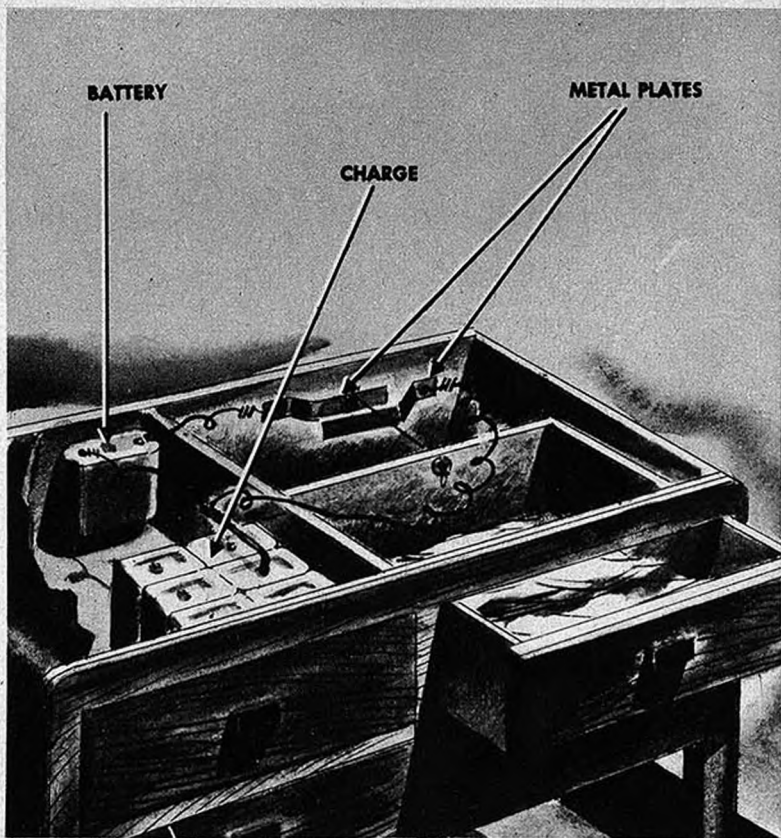

INSTALLING AND ARMING

1. Connect lead wires to metal plates and attach string from rear plate to drawer.
2. Connect battery and charge and lock adjoining drawer.

DISARMING

1. Working from above or below the booby-trapped drawer disconnect lead wires from metal plates.
2. Disconnect battery and charge.

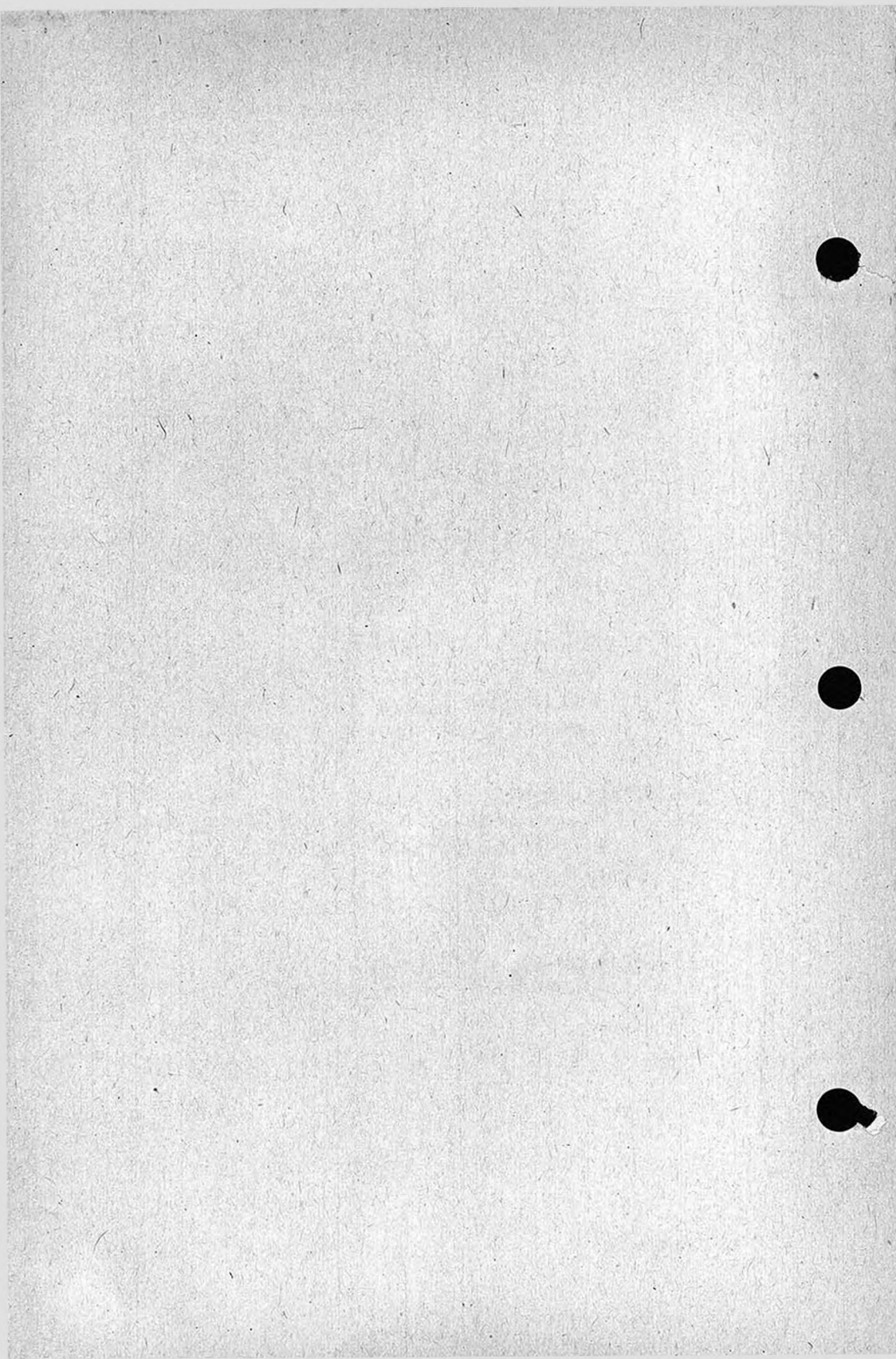

BRITISH WATER-BARREL BOOBY TRAP

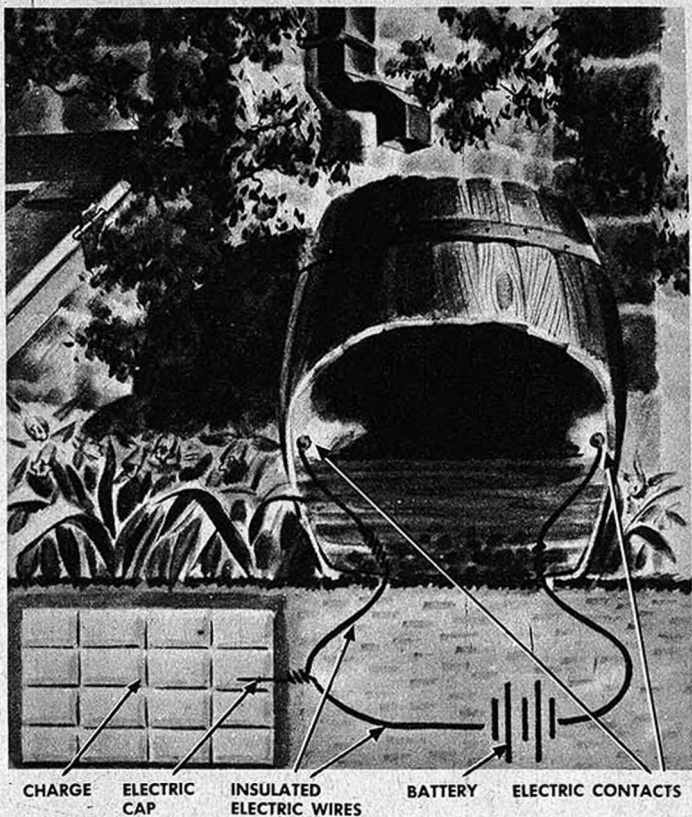

FUNCTIONING

When water in rain barrel reaches level of two electric contacts, circuit is closed and charge fired.

INSTALLING

Install wiring. Place copper sulphate in barrel. Connect charge last.

DISARMING

Disconnect battery and charge.

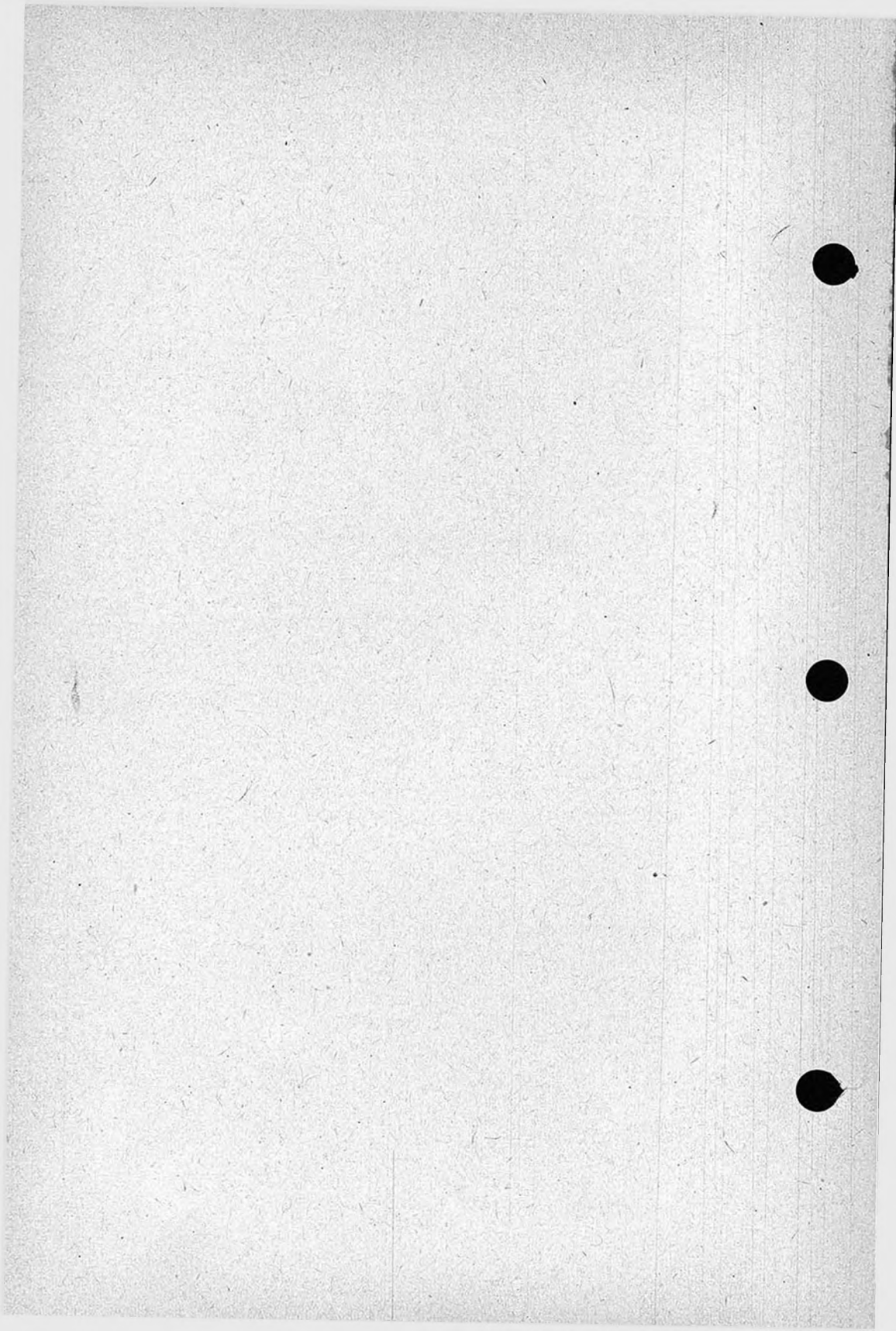

FRENCH

MINE TACTICS, MINES,

AND FUZES



FRENCH LIGHT ANTITANK MINE

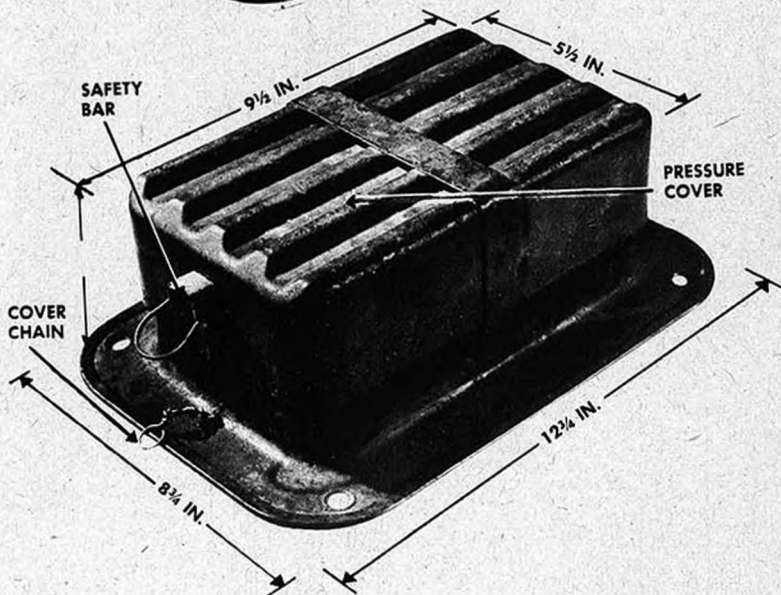
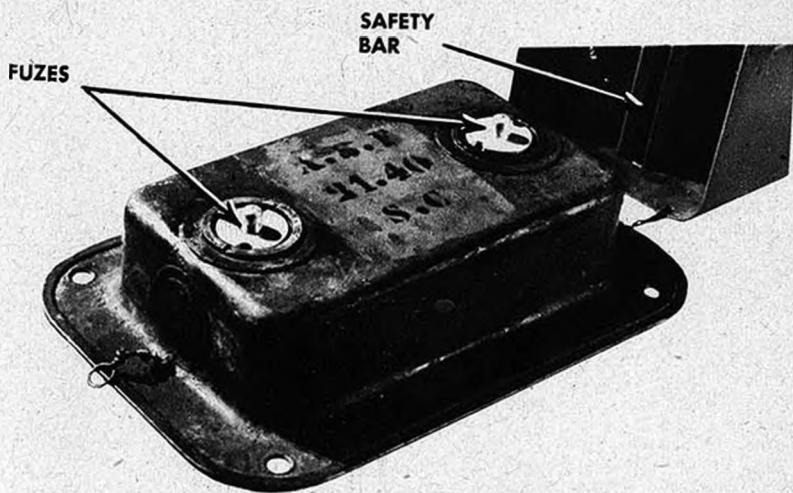

TYPE. Antitank mine

COLOR. Dull green

CASE. Steel

WEIGHT. 14 1/2 pounds

EXPLOSIVE. 5 3/4 pounds

EFFECT. Disables tanks

FRENCH LIGHT ANTITANK MINE

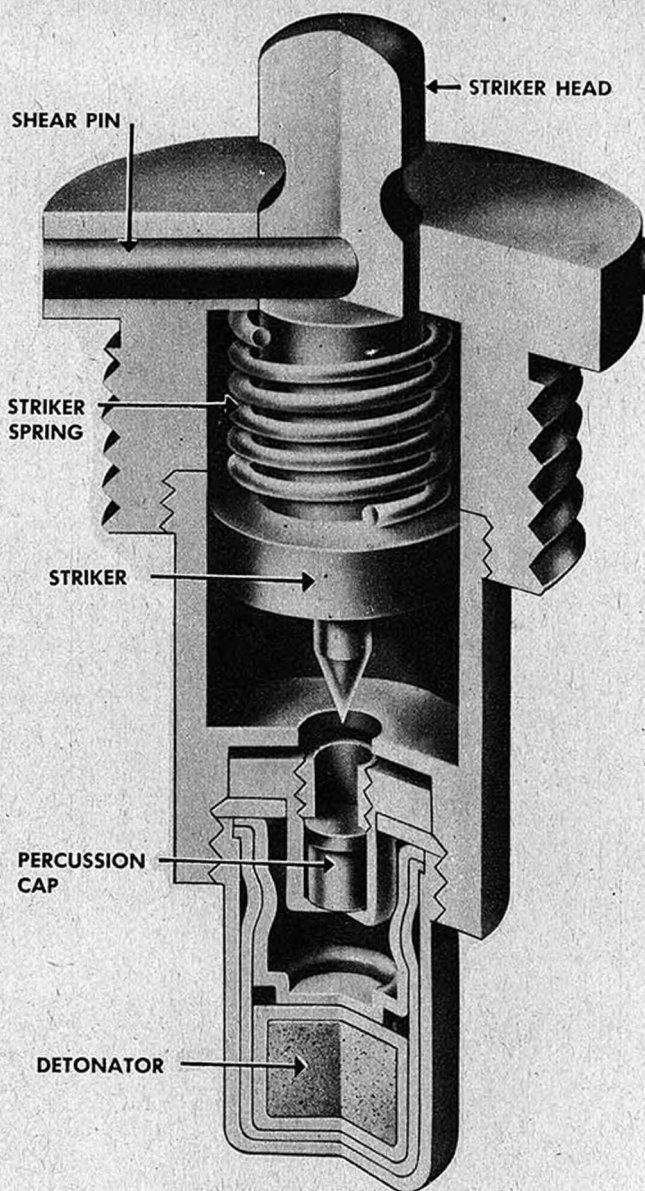

FUNCTIONING

1. Pressure of 300 to 500 pounds on cover depresses striker head of one or both fuzes, breaking shear pin and releasing striker.
2. Driven by striker spring, striker fires percussion cap—detonator—booster—main charge.

FRENCH LIGHT ANTITANK MINE

DEFUZING



1. Detach chain, and lift off cover.



2. Unscrew and remove both fuzes.



3. Replace cover.

FRENCH LIGHT ANTITANK MINE



4. Search for booby traps. Cut any trip wires attached to hole in base flange. Lift mine.

INSTALLING AND ARMING

1. Lift cover and screw in fuzes.
2. Insert safety bar in cover, and lock in place with safety pin.
3. Replace cover, and fasten with chain and clip.
4. Bury mine flush with surface of ground or slightly below it.
5. Remove safety pin.
6. Withdraw safety bar.

RE-USE

Inspect fuzes for signs of rust or deterioration.

CAUTION

The cover on this mine may be booby-trapped. After loosening chain, examine carefully, or pull off from a safe distance.

SPACE FOR NOTES

GERMAN

**MINE TACTICS, MINES
AND FUZES**

MINE TACTICS

80.01. GENERAL

Germans employ essentially the same principles in mine-field siting as those outlined in American and British mine-field policies. Maximum use is made of surprise. Natural and artificial barriers are utilized fully to force approaching vehicles to cross the mine field. Mine fields are closely coordinated with antitank and supporting-weapon fire. Extensive use is made of antipersonnel mines and booby-trapped antitank mines.

80.02. TYPES OF MINE FIELD

a. The Germans distinguished between laying mines broadcast and in regular fields. Strict rules regulating the laying and recording of patterned mine belts have been drawn up by the German General Staff. Frequently it has proved possible to forecast the location of every mine in a section once the first few have been located. In such fields the mines are laid at regular intervals in equidistant rows, the mines of one row lying behind the gaps in the row in front, sometimes centrally, sometimes offset. Where speed is the main consideration, or during a withdrawal, mines are laid indiscriminately and in small groups. During the later stages of the North African campaign mines usually were laid in this way, causing considerable delay and casualties even though frequently the mine fields were not covered by fire. This practice may be expected in all future campaigns when the enemy is in full retreat and does not expect to reoccupy lost ground.

b. The main belts of a major antitank mine field laid in uniform pattern normally consist of antitank mines with a sprinkling of antipersonnel mines in the forward edge of the field. Both types may be fitted with antilifting devices, and some of the antipersonnel mines normally have trip wires attached. In some cases these mines are placed in the intervals between the diagonal wires of a double-apron fence, with trip wires fastened to the diagonals. The trip wire is the first part of the fence touched by the approaching enemy.

c. Frequently a number of antitank mines are laid in the forward edges of antipersonnel mine fields to prevent the use of armored vehicles for detonating the main belt of antipersonnel mines.

d. The forward edges of mine fields of all types often are sown with explosive charges placed in wooden boxes fitted with pressure fuzes. These act as both antitank and antipersonnel mines, and tend to prevent determining the exact location of mines by use of detectors.

e. Forward of most regular fields, and particularly in front of lanes, mines may be found widely spaced or scattered at random in unmarked groups. Mines also are laid in spurs running at right angles to the forward edge of the mine field to damage vehicles moving along the field in search of lanes.

80.03. TYPICAL GERMAN MINE-FIELD PATTERNS

a. The pacing method normally is used to establish the locations of individual mines in a mine-belt section. Five paces is the normal interval between mines. Both hasty and deliberate mine-belt sections are used.

b. An example of the lay-out for a German hasty mine belt is shown in figure 80.03a.

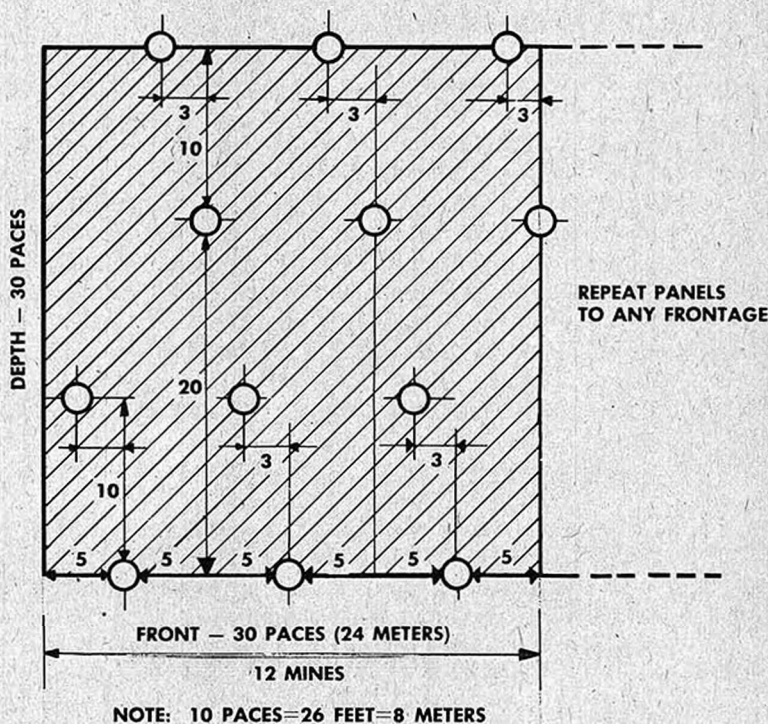
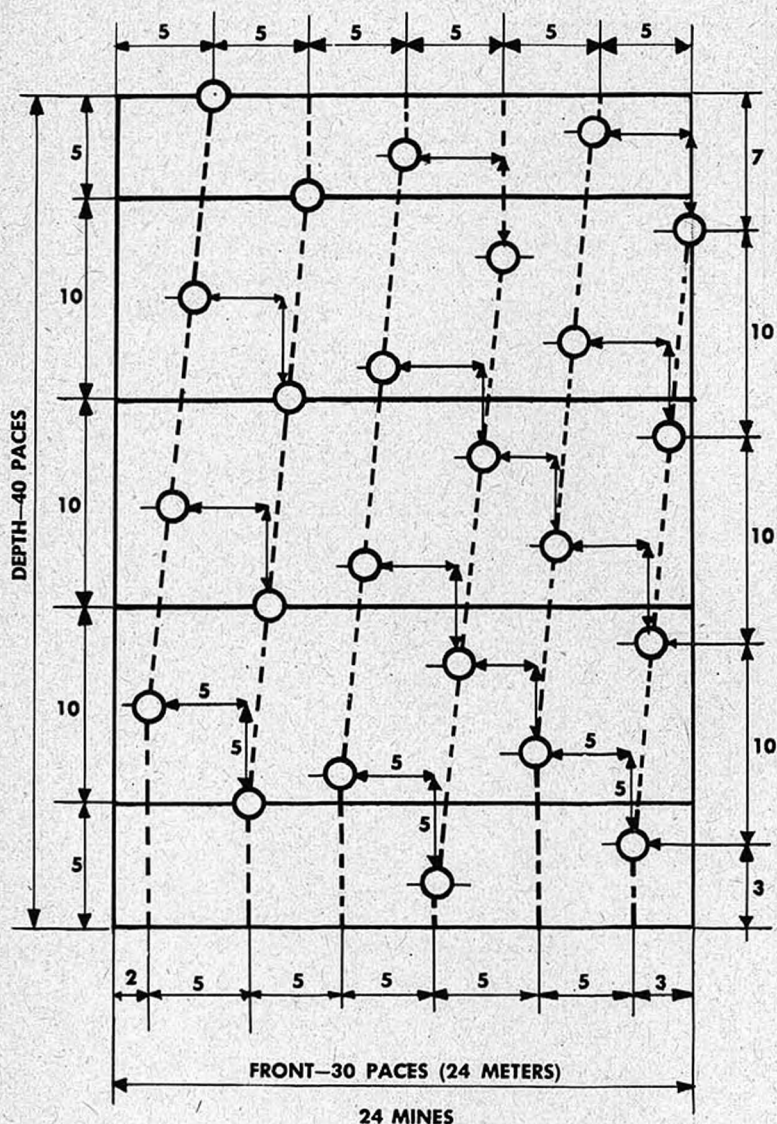

Figure 80.03-a. German Hasty mine field pattern.

It has sections 30 paces wide by 30 paces deep, or approximately 80 by 80 feet. Each section contains 12 mines. The density averages 1 mine per 2 yards of front. The sections are repeated to extend the mine belt as desired.

c. A typical German deliberate mine belt is shown in figure 80.03-b.



NOTE: 10 PACES=26 FEET=8 METERS

Figure 80.03b. German deliberate mine-field pattern.

This mine belt is laid in sections 30 paces wide by 40 paces deep, or approximately 80 by 105 feet. The section contains 24 mines. The density averages 1 mine per yard of mine-field front. The sections usually are staggered, and for extensive mine belts are combined in units of three or four as shown in figures 80.03c, and 80.03d.

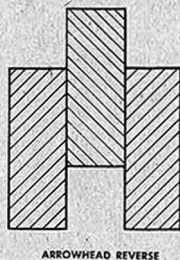
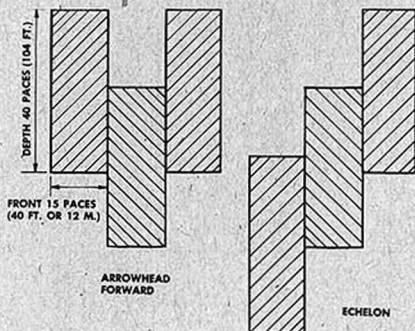
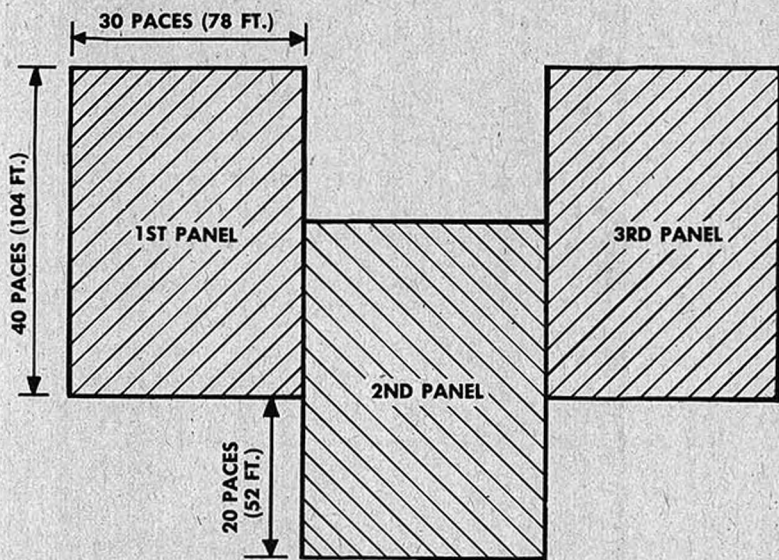

NOTE: EACH PANEL, 15x40 PACES, CONTAINS 24 MINES WITH CLOSE SPACING.

Figure 80.03c. German panel arrangement.

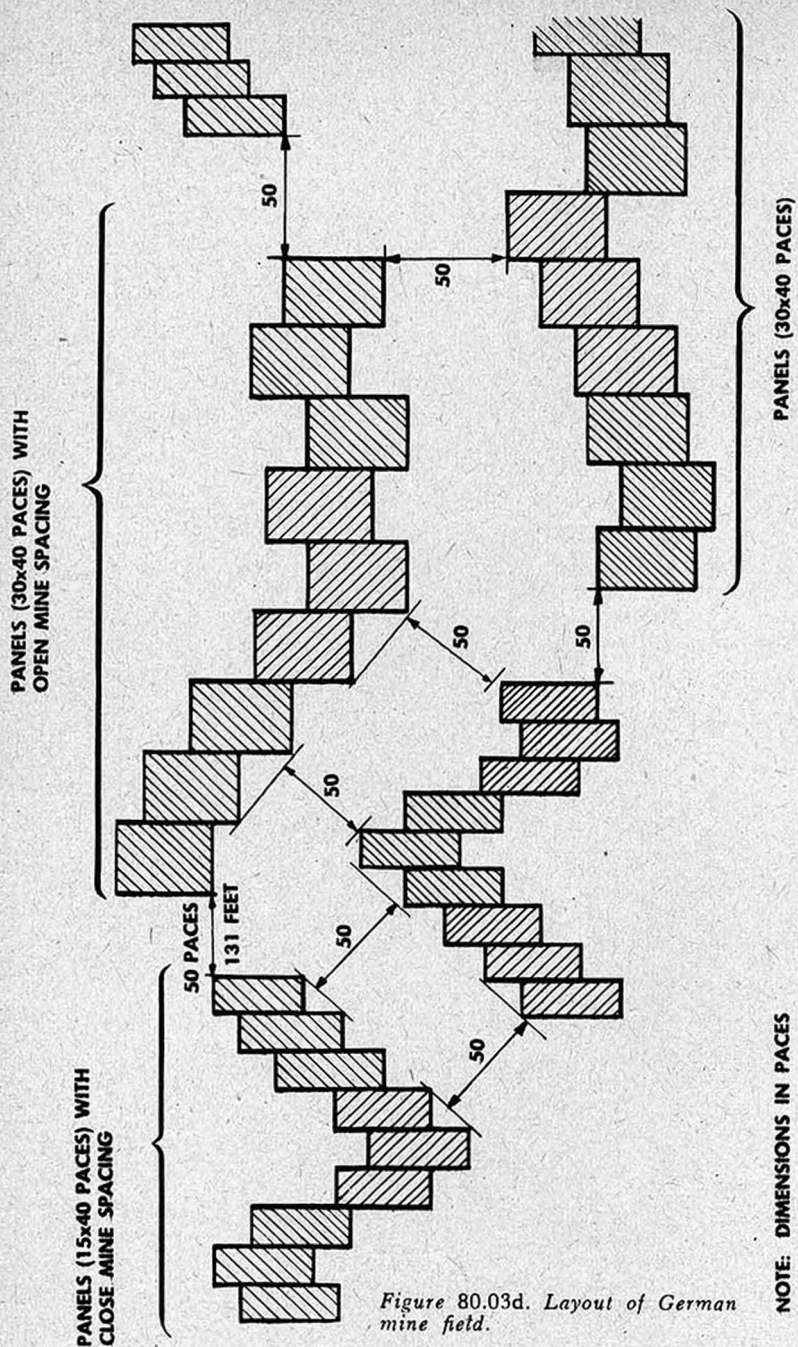

Figure 80.03d. Layout of German mine field.

80.04. PROTECTION OF MINE FIELDS

The Germans teach that mine fields must be covered by fire, although during the withdrawal in North Africa many nuis-

ance fields were left unmarked and without fire cover. It is common for a regular mine field to have at the rearward edge a listening post of two men and about 70 or 80 yards to their rear a covering party of four or five men with one or two light machine guns.

80.05. IRREGULAR OR NUISANCE MINE FIELDS

a. An indication of the haste with which the German withdrawals in Tripolitania and Tunisia were carried out was the comparative rarity of regular mine fields and the large number of small nuisance fields which were laid. These nuisance fields contained many different types of mine, often were unmarked, and showed every evidence of having been laid in a hurry. The consequent lack of uniformity made their detection and clearance a laborious and dangerous business. Though no consistency was noted in lay-out and types of mines used in such fields the Germans showed certain marked preferences in their choice of sites for them.

(1) In general, mines were laid either close to or on roads, on airfields and railways, and along telegraph-line routes.

(2) The surfaced portion of roads usually defeated the hasty mine layer, but khaki-painted Tellermines sometimes were placed on the road where it dipped sharply, in the hope that drivers would be unable to check their vehicles in time to avoid them.

(3) The main effort was directed towards catching vehicles off the road at narrow places where they had to pull out to pass and at entrances to defiles where they had to pull off the road and wait for vehicles moving in the opposite direction. Other places frequently sown with antitank mines were turn-outs, sharp bends which fast-moving traffic might overshoot, the unsurfaced island sometimes found at crossroads, berms, and well-worn wheel ruts.

(4) Efforts to evade detection included—

(a) Burying mines as much as 24 inches below the surface where they would explode only after the passage of a number of vehicles had compacted the earth cover sufficiently to operate the fuze.

(b) Putting explosives in wooden boxes to foil mine detectors.

(c) Marking tire prints in the earth on top of the mine by drawing a detached axle and wheels over it.

b. The Germans showed considerable ingenuity in siting random antipersonnel mines on the line of the British advance. Road demolitions were plentifully sown with S mines, and kilometer posts at points where vehicular drivers would have to dismount to read the directions were similarly treated. S mines also were placed in ditches often close to the trip-wire peg of another mine. Trip wires of white string were difficult

to see against a background of sand but the pegs to which they were attached, and sometimes a peg at the actual mine, pointed to the presence of S mines with pull fuzes. S mines with push fuzes normally were buried with the prongs either level with the surface of the ground or projecting about 3 inches above it, sometimes carefully camouflaged with twigs. S mines with push-firing devices also have been found sometimes buried to a depth of 4 inches.

c. Nuisance fields on lines of communication generally were closely spaced—occasionally so closely as to cause sympathetic detonation, particularly when the mines were laid with their pressure plates almost flush with the surface of the ground and only lightly covered with earth.

80.06. MARKING

German methods of marking mine fields are not uniform. The front edge of the field often is unmarked, the rear edge seldom so. Some fields have been found both unmarked and unwired. Certain markings usually indicate the presence of mines. The following are typical examples of such markings:

- a. Double-apron fence on the enemy side and a single trip wire on the friendly side, or the reverse.
- b. A single knee-high wire, cattle fencing, and empty mine crates.
- c. Notices bearing the word "Minen" fixed to the perimeter wiring, the wording facing away from the mines.
- d. In Tunisia ration boxes and pickets marked the corners of some fields.
- e. Parti-colored red and white rectangular boards, or luminous strips visible at night, sometimes marked lanes.
- f. Jerricans on kilometer posts indicate mines in the vicinity, and small pickets have been found marking mined turn-outs.
- g. Empty mine containers normally are buried or dumped some distance away from the field. The buried crates may be used as reference points by the Germans, as S-mine crates have been found buried flush with the ground at the foot of the telegraph pole nearest to a nuisance field on the roadside.
- h. Definite reference points generally are lacking; the Germans probably locate their fields by taking azimuth and distance from kilometer posts, track junctions, or other fixed objects or points.
- i. Individual mines sometimes are disclosed by the disturbed appearance of the ground above them, and many hundreds of mines in Tunisia thus were detected by eye.

80.07. ANTILIFTING DEVICES AND BOOBY TRAPS

The proportion of mines having antilifting mechanisms varies greatly from field to field; in some cases every mine is thus treated and in others none, or only a few, depending on the haste of laying. Examples of the commonest methods observed in North Africa are:

- d. Tellermines were laid upside down with pressure fuzes in the base well.
- b. Tellermines were laid on the surface with the fuze set at "safe" and with a wire attached to the base or handle leading to a pull fuze fitted in either a 3-kilogram charge or in another Tellermine buried underneath.
- c. Armed and buried Tellermines commonly were attached by two separate wires to an S mine fitted with two pull fuzes, buried about 5 feet away.
- d. In some cases the wire from a pull fuze—presumably in the side pocket—led from a Tellermine to a stake about 1 foot away, so anyone digging around the mine would depress the wire and fire the charge.
- e. A wire attached to a pull fuze in an S mine was found anchored to a small bush; when the bush was removed the mine exploded.
- f. British GS MK IV mines were laid with a wire leading to a pull fuze in a 3-kilogram explosive charge. Lids of both British GS MK II and Italian B 2 mines are reported to have been similarly treated.

80.08. DUMMY MINE FIELDS

German dummy mine fields take various forms. In some cases a trip wire is laid to give the appearance of a mine-field perimeter wire, with the usual lanes, and the ground is disturbed at regular intervals. Scrap metal is placed in shallow holes to cause a reaction in the mine detector. Smoke candles were buried 4 inches below the surface in one of the dummy fields at Merduma West landing ground. The lids of Italian B 2 mines frequently were laid in dummy fields, wired in, and booby traps interspersed.

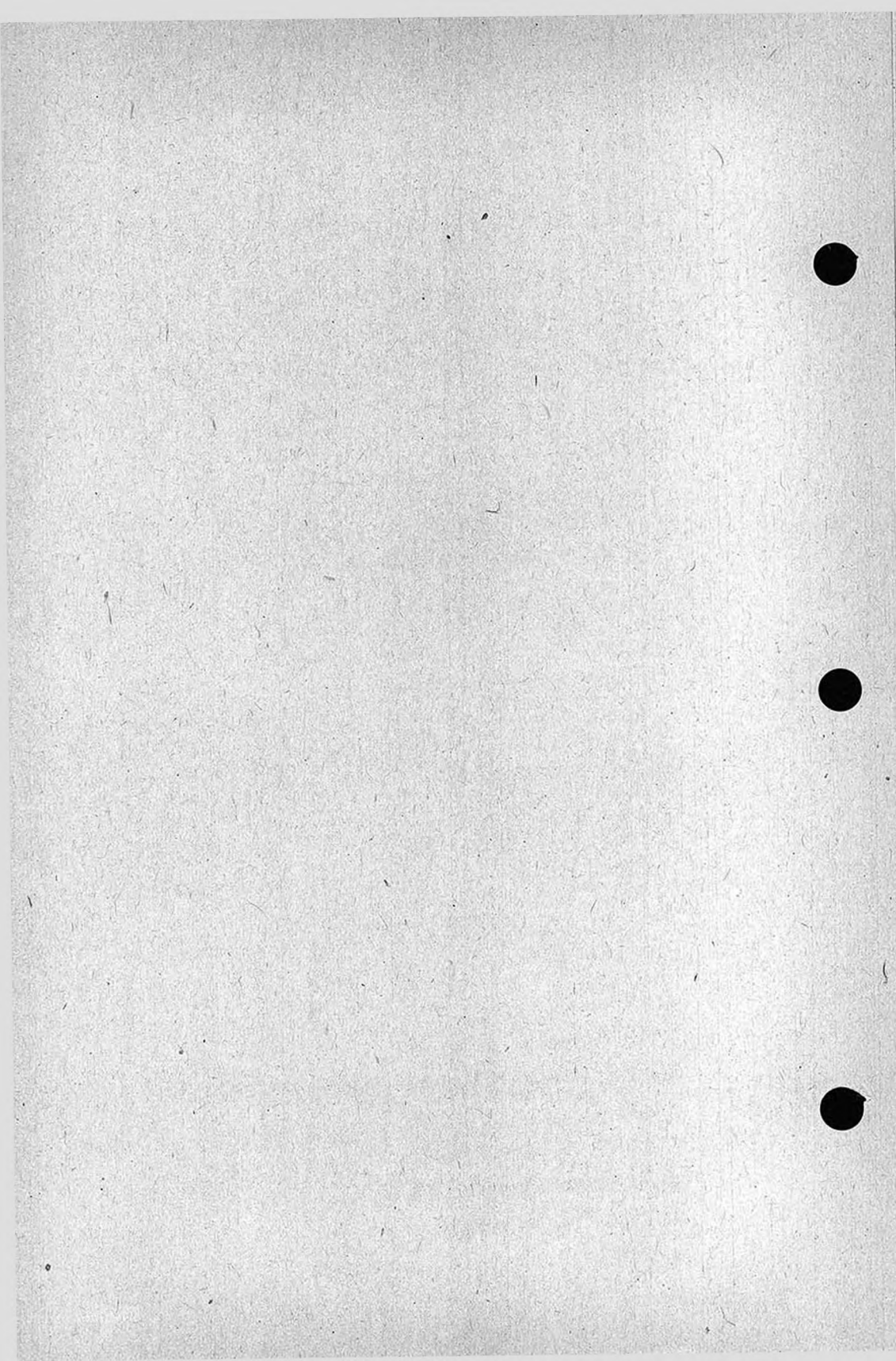

GERMAN TELLERMINE 35

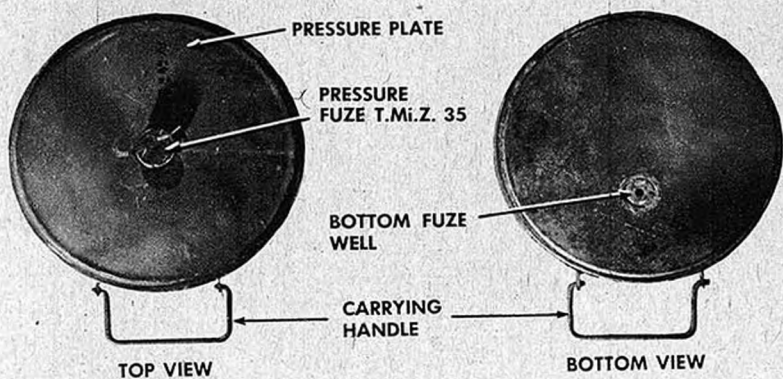
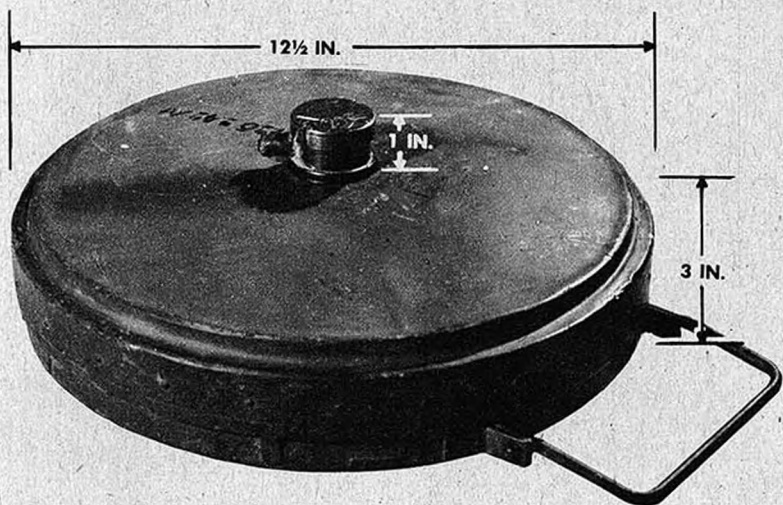

TYPE. Antitank mine

COLOR. Gray or dark green, European pattern; tan, desert pattern

CASE. Steel

WEIGHT. 20 pounds

EXPLOSIVE. 12 pounds TNT

EFFECT. Disables tanks

GERMAN TELLERMINE 35

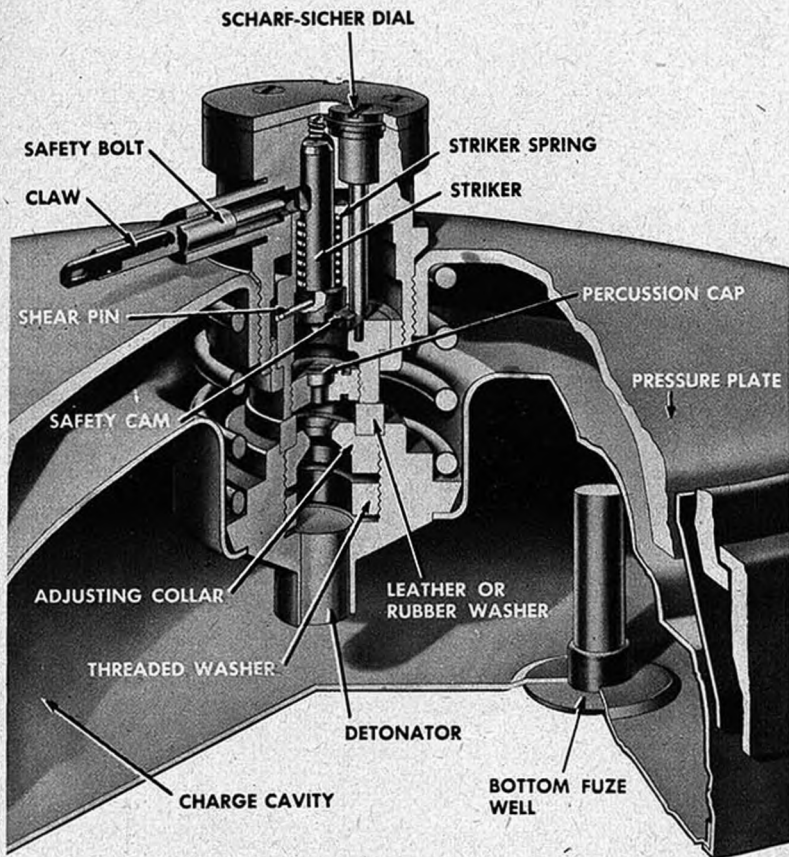

FUNCTIONING

1. Pressure of 200-400 pounds on pressure plate depresses plate and fuze housing.
2. Fuze housing presses on top of striker, shearing shear pin which holds striker in cocked position.
3. Driven by striker spring, striker sets off percussion cap, detonator, booster, main charge.

FUNCTIONING OF SAFETIES

Fuze T. Mi. Z. 35 has two safeties, as follows:

1. Safety bolt, which passes through slotted hole in top of striker and prevents it falling. Bolt pulled out by a claw.
2. Rod attached to SCHARF-SICHER dial with cam at lower end. When dial is set at SICHER (safe), cam is beneath striker. When set at SCHARF (armed), cam is withdrawn. Main use of this safety cam is to take pressure off shear wire when striker is not in use.

GERMAN TELLERMINE 35

DISARMING

Mine has *shear-pin* fuze. Blast or other disturbance may have partially sheared pin. If disturbed, do not attempt to disarm or defuze. Destroy in place with explosive. Or, lying prone, pull mine loose with 50-yard rope or wire, drag to safe place, and destroy.



IF UNDISTURBED

1. Press safety bolt home. If safety bolt does not press home easily *do not force*. Treat as disturbed mine.

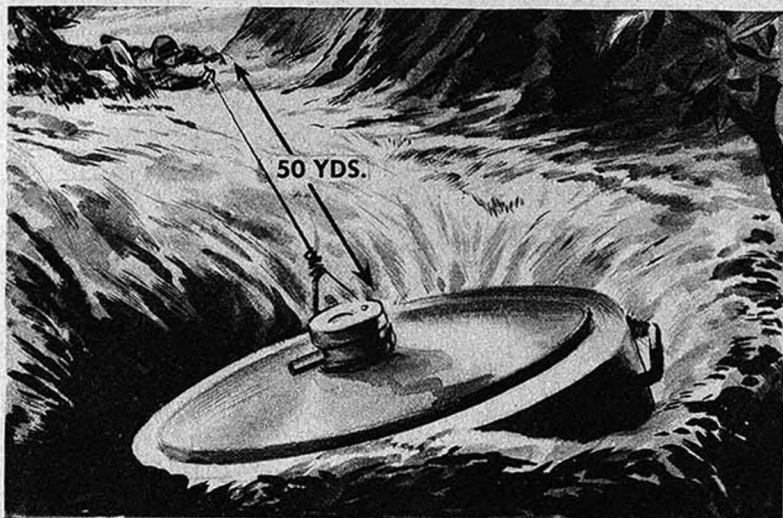

2. Pull mine from hole with 50-yard rope or wire. Or, seek and disarm secondary fuzes (page 85.01-a) and lift mine.

GERMAN TELLERMINE 35

DEFUZING

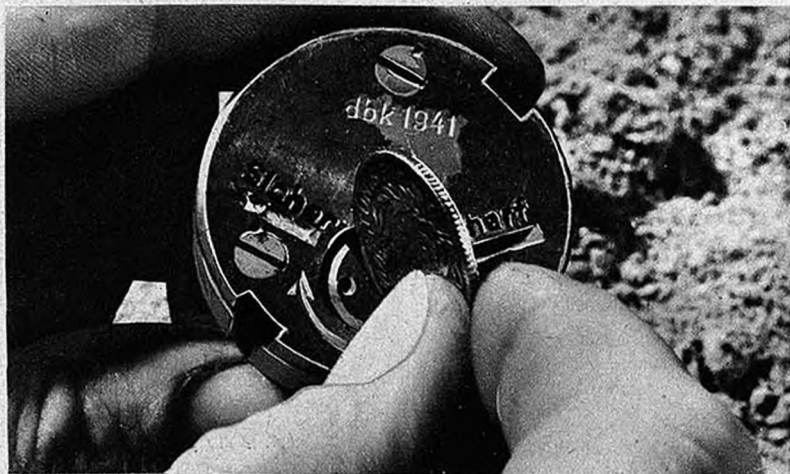

1. After disarming, remove fuze and turn dial from SCHARF to SICHER. Use coin or knife—not screwdriver.



2. Tape or wire safety bolt in place; replace fuze in mine.

INSTALLING AND ARMING

(For booby-trapping, see page 85.01-b).

1. Dig circular hole 7 inches deep, $1\frac{1}{2}$ feet across at bottom, 3 feet across at top.
2. Place mine in hole, with handle horizontal or down—not up.
3. Turn dial from SICHER to SCHARF.
4. Cover mine, and from safe distance withdraw safety bolt.

GERMAN TELLERMINE 35

ASSEMBLING

Use standard Tellermine tools, since correct assembly cannot be made without them. If improperly adjusted, mine will not function properly.

1. With small screwdriver, loosen set screw in adjusting collar.
2. Using Tellermine box spanner, adjusting collar and threaded washer.
3. Insert detonator whose protective label is undamaged.
4. Screw threaded washer in position, tighten with box spanner.

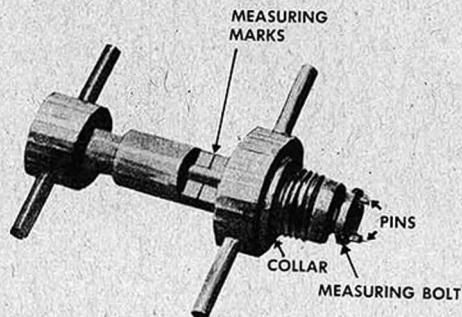

TELLERMINE ADJUSTING GAGE

5. Screw collar in place, using Tellermine adjusting gauge as follows to obtain proper clearance between washer and collar.

a. Slip leather or rubber washer onto gauge as far as collar at base.

b. Screw gauge into cover and tighten.

c. Press measuring bolt down, turn until adjusting pins engage holes in collar.

d. By rotating bolt right or left bring mark on measuring bolt to same height as mark on gauge casing.

e. Release measuring bolt and unscrew gauge.

6. Screw in set screw tightly. If it coincides with one of sockets in washer, turn collar $\frac{1}{8}$ inch to left before screwing.

7. Place sealing ring and washer over head of collar. Mine now is ready for fuzing.

8. If adjusting gauge is not available, an approximate adjustment can be obtained by screwing the threaded washer down tight on the detonator and screwing in the adjusting collar in $4\frac{1}{2}$ turns.

RE-USE

Immediately before reusing, test fuze as follows:

1. Remove fuze and hold away from mine.

2. Turn dial from SICHER to SCHARF, and, pointing bottom of fuze away from body, withdraw safety bolt. If fuze fires, pin was sheared.

GERMAN TELLERMINE 35

3. If fuze does not fire, turn dial from SCHARF to SICHER, push in safety bolt with claw, and replace fuze in mine.

PACKING AND TRANSPORTING

Transported with disarmed fuze in place. Has two German cases: one holds two mines, weighs 51 pounds loaded; the other holds one mine, weighs 28 pounds loaded.

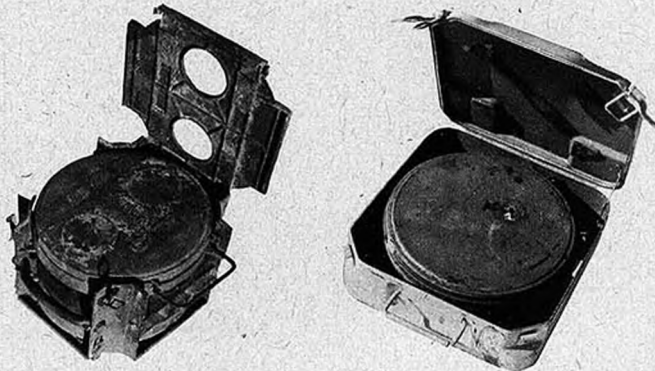

NOTE

Tellermine 35 has been used with fuze T. Mi. Z. 42, and opening in cover filled with screw plug. If used this way, treat like Tellermine 42.

SPACE FOR NOTES

GERMAN TELLERMINE 35 (STEEL)

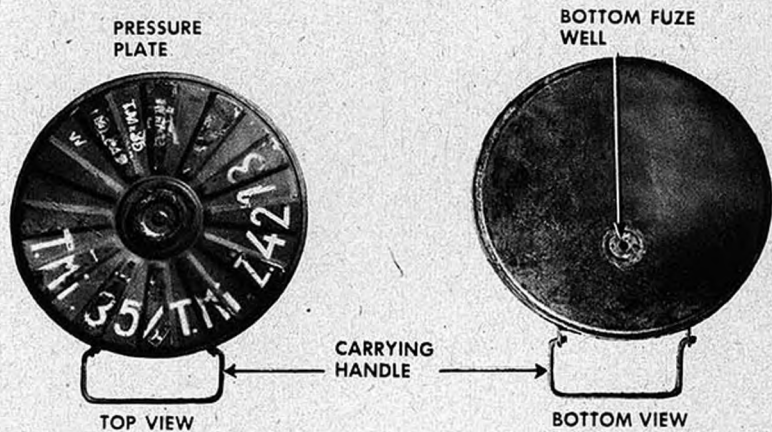
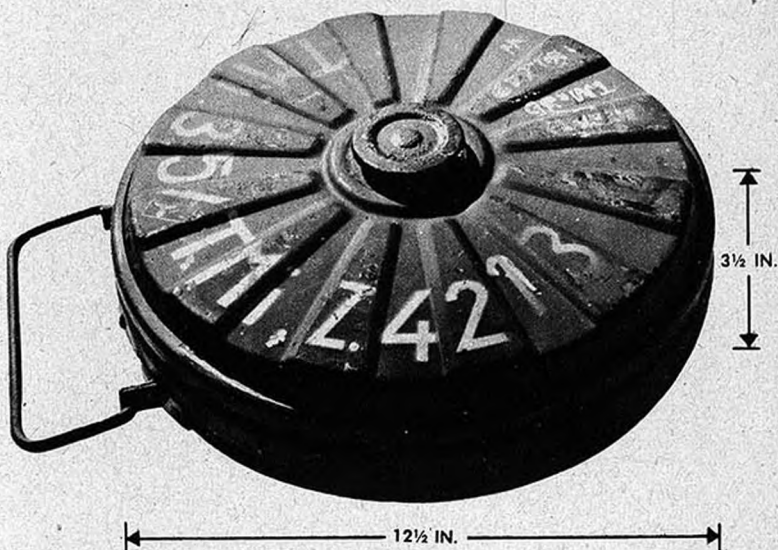

TYPE. Antitank mine

COLOR. Gray

CASE. Steel

WEIGHT. 21 pounds

EXPLOSIVE. 12 pounds TNT

EFFECT. Disables tanks

GERMAN TELLERMINE 35 (STEEL)

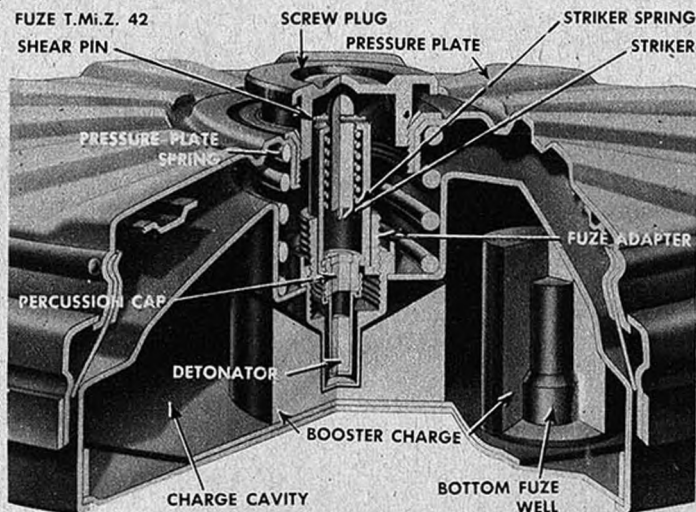
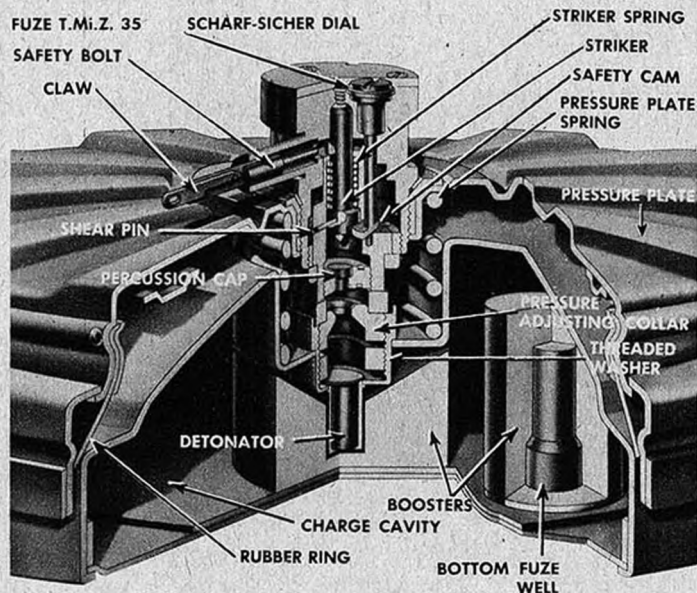

The Tellermine 35 (steel) is a modification of Tellermine 35. It uses either fuze T. Mi. Z. 42 or fuze T. Mi. Z. 35. If used with fuze T. Mi. Z. 35 (screwed into cover plate), treat exactly like Tellermine 35 (page 81.01). Detonator and adjusting collar are in place in the mine. If used with fuze T. Mi. Z. 42 (screw plug in cover plate), treat exactly like T. Mi. Z. 42 (page 81.03-c). Detonator and adjusting collar are removed and a fuze adapter is installed. Screw plug takes place of hexagonal cap.

GERMAN TELLERMINE 42

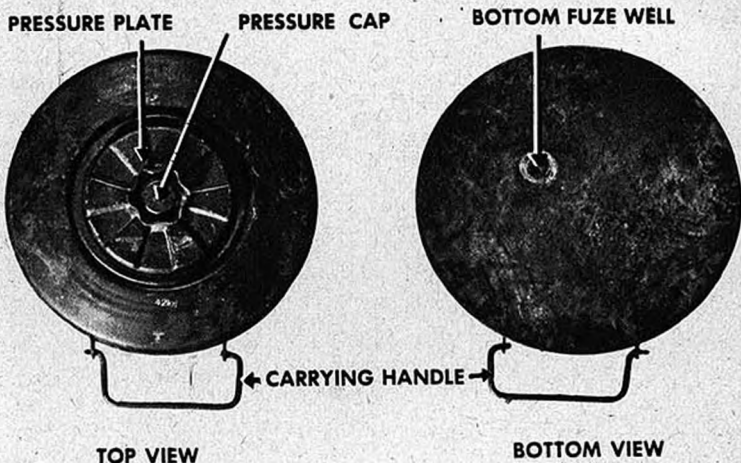
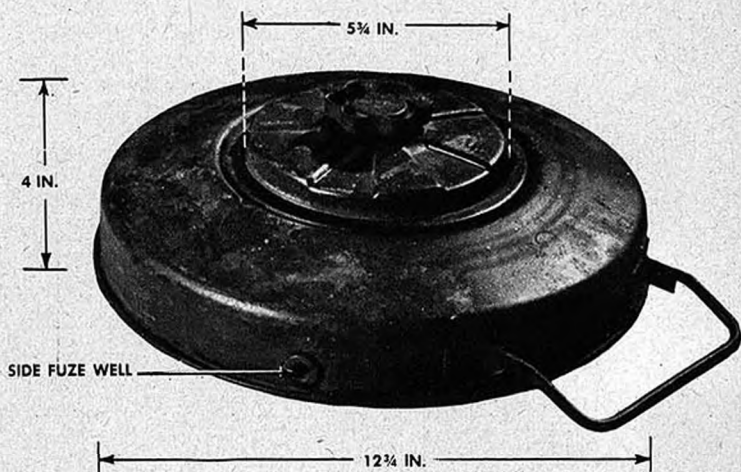

TYPE. Antitank mine

COLOR. Gray

CASE. Steel

WEIGHT. 20 pounds

EXPLOSIVE. 12 pounds TNT

EFFECT. Disables tanks

FM 5-31

1 NOV 1943

81.03-a

RESTRICTED

GERMAN TELLERMINE 42

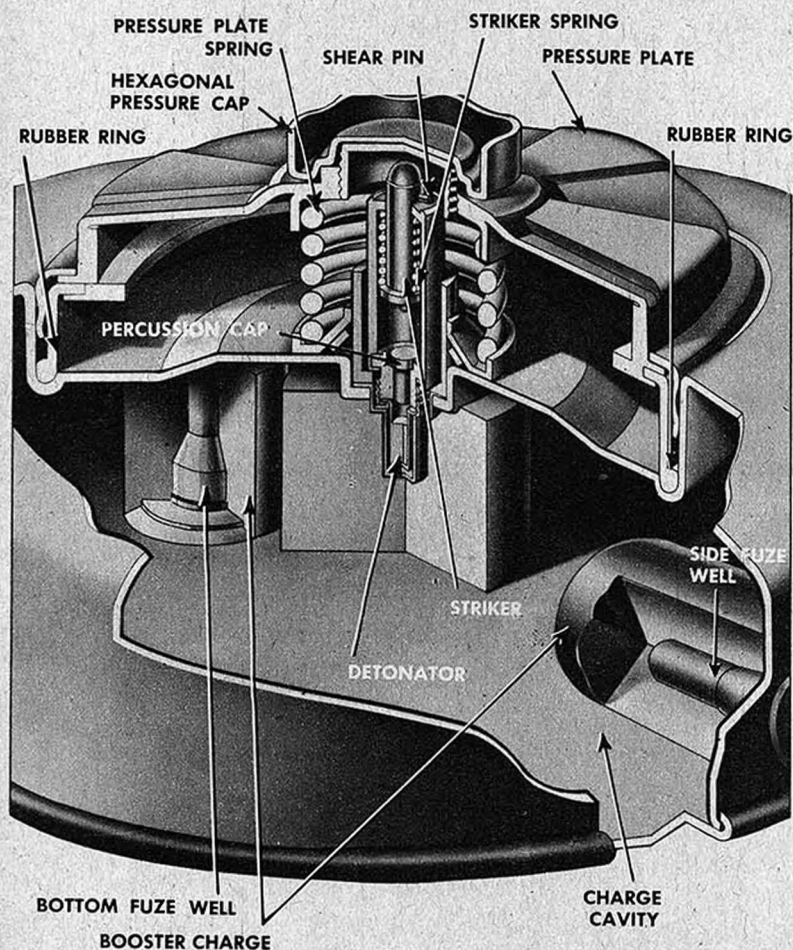

FUNCTIONING

1. Pressure of 250-400 pounds on pressure plate depresses hexagonal cap and top of striker.
2. Striker shears shear pin.
3. Released striker, driven by spring, explodes percussion cap—booster—main charge.

GERMAN TELLERMINE 42

DISARMING

Mine has *shear-pin* fuze. Blast or other disturbance may partially shear pin. If there is evidence of disturbance, do not attempt to disarm or defuze. Destroy in place with explosive; or, lying prone, pull mine loose with 50 yards of rope or wire, drag to a safe place, and destroy.



IF UNDISTURBED

1. Remove hexagonal cap, lift out fuze, and replace cap.

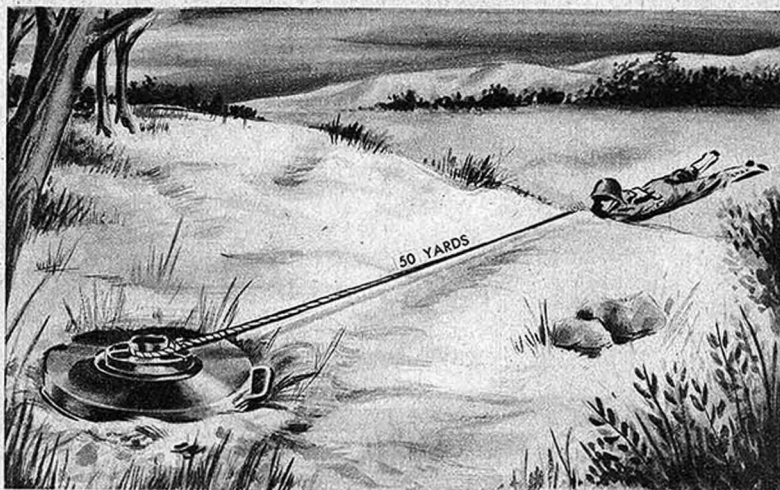

2. Pull out mine with 50 yards of rope or wire; or, search for and disarm secondary fuzes (page 85.01-a), and then lift mine.

GERMAN TELLERMINE 42

DEFUZING

In this mine disarming, as explained above, is defuzing.

INSTALLING AND ARMING

(If mine is to be booby-trapped, see page 85.01-b.)

1. Dig circular hole 7 inches deep, $1\frac{1}{2}$ feet across at bottom, and 3 feet across at top.
2. Set mine in hole, with handle horizontal or down—*not up*.
3. Remove hexagonal cap, insert fuze.
4. Replace cap, cover mine.

PACKING AND TRANSPORTING

Transport mine and fuze separately, using either one- or two-mine carrying case. Latter, loaded, weighs 51 pounds. One-mine case, loaded, weighs 28 pounds.

RE-USE

Examine shear pin and cap for deterioration or evidence of having been fired. If hexagonal cap is in place, it is almost certain explosive in mine is in good condition.

SPACE FOR NOTES

GERMAN TELLERMINE 43 (MUSHROOM)

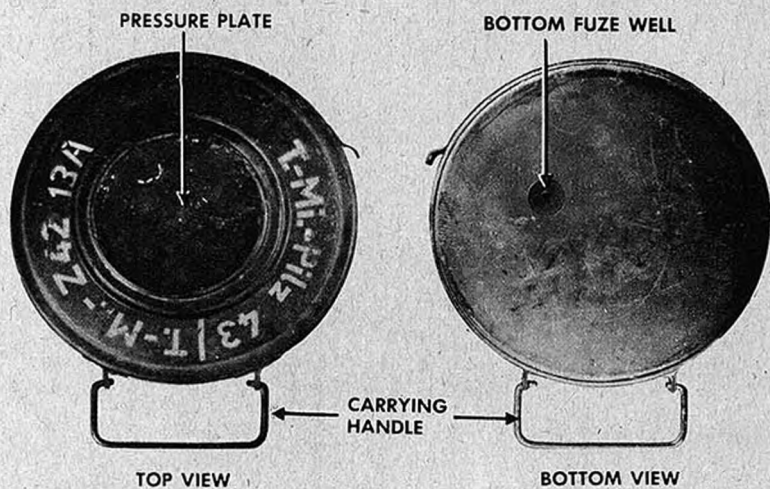
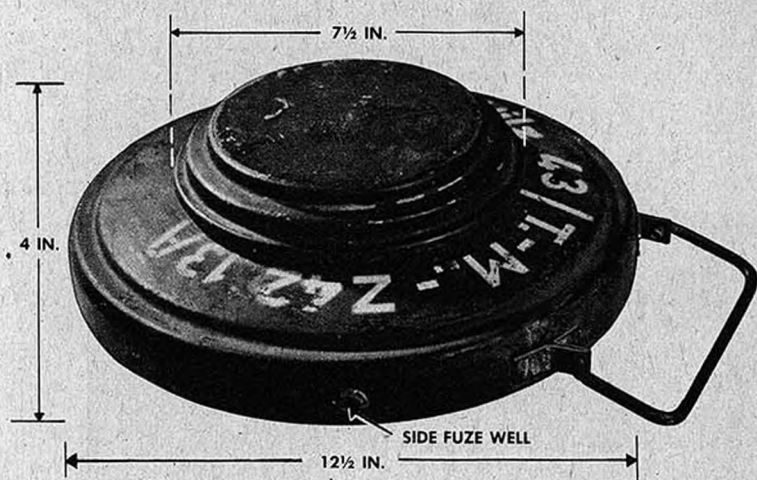

TYPE. Antitank

COLOR. Gray

CASE. Steel

WEIGHT. 18 pounds

EXPLOSIVE. 12 Pounds TNT

EFFECT. Disables tanks

GERMAN TELLERMINE 43 (MUSHROOM)

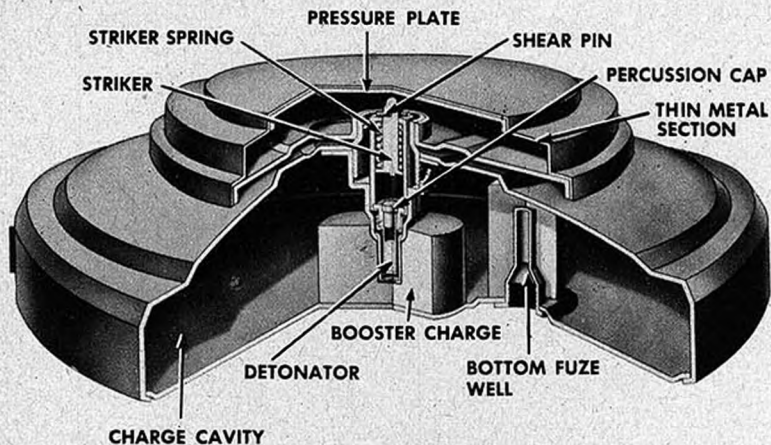

T. Mi. 43 (mushroom) is a modification of T. Mi. 42 (page 81.03), uses same fuze (T. Mi. Z. 42), and is handled same way. Principal difference is that the entire pressure plate T. Mi. 43 (mushroom), rather than just hexagonal cap as in T. Mi. 42, unscrews to uncover fuze. Initial resistance to pressure is provided by thin walls of pressure plate rather than by an inner spring.

SPACE FOR NOTES

GERMAN L. P. Z. MINE

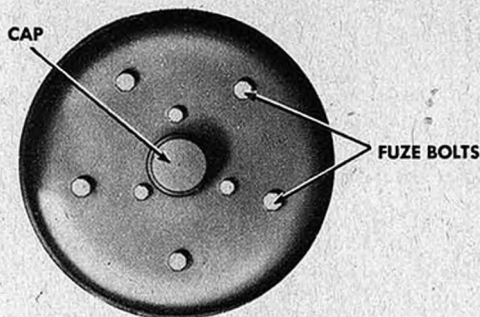
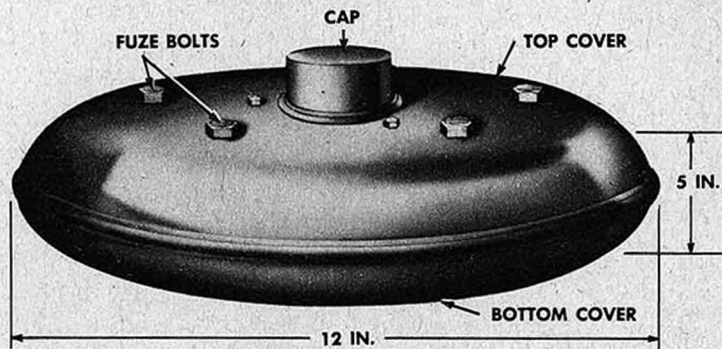

TOP VIEW

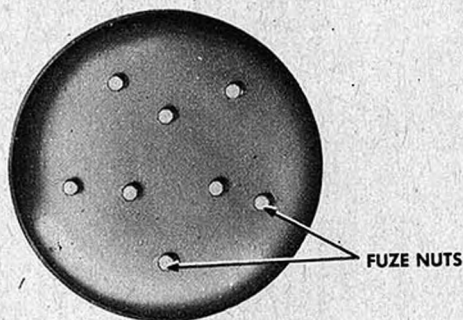

BOTTOM VIEW

TYPE. Light antitank mine, convertible to antipersonnel.

COLOR. Gray

CASE. Sheet metal

WEIGHT. 9 pounds

EXPLOSIVE. 5 pounds TNT

EFFECT. Disables vehicles, breaks tracks on light tanks, sometimes on medium tanks

GERMAN L. P. Z. MINE

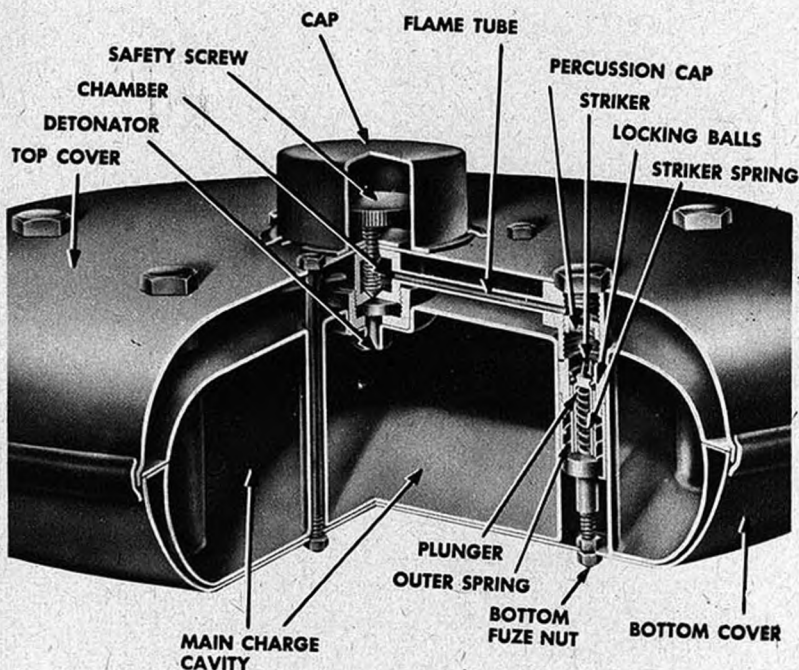

FUNCTIONING

1. Pressure crushes mine covers, pushes one or more fuze housings downward over their plungers. **NOTE.** If mine is used against personnel, bottom fuze nuts are removed and mine, resting on threaded end of plungers, is placed on flat, hard surface. Light pressure on mine cover depresses entire mine and forces plungers upward into fuze housings.
2. Either action compresses outer spring, allows steel balls to be forced outward into upper recesses, releasing striker.
3. Released striker, driven by striker spring, explodes percussion cap.
4. Flame from cap travels through flame tube and chamber, ignites detonator—booster—main charge.

FUNCTIONING OF SAFETY SCREW

When safety screw is screwed tightly clockwise, and white line marked **SICHER** on screw head is opposite white mark on mine, beveled end on screw closes flash hole leading to detonator.

GERMAN L. P. Z. MINE

DISARMING



1. Unlock bayonet catches, remove cap above safety screw.

2. Turn safety screw tight, clockwise, until line marked SICHER coincides with white mark on case.

3. Lying prone, pull mine from hole with 50 yards of wire; or disarm booby traps and lift mine from hole without tilting. Before setting down, examine to see if all bottom nuts are in place. If not, defuze immediately.

DEFUZING

1. Stand mine on edge and remove five top fuze bolts and cap-holders and caps.

2. Turn mine upside down, remove all bottom nuts.



3. Remove tape from joint between covers, and pry loose bottom cover.

4. Remove felt washers from fuze bases, and lift explosive body from top cover.

5. Unscrew retaining collar, and remove detonator.

6. Reassemble case.

GERMAN L. P. Z. MINE

INSTALLING AND ARMING

With mine covers, fuzes, and detonators in place—

1. For antitank use, remove cap, unscrew safety screw.
2. For antipersonnel use, remove bottom nuts from fuzes; set on flat, hard surface; remove cap; unscrew safety screw.

PACKING AND TRANSPORTING

Germans transport mine complete with detonator and fuzes, safety screw turned down firmly. Safer to transport with cap holders and caps removed. Wooden box containing five mines weighs about 60 pounds.

RE-USE

If tape is undamaged, and cap over safety screw is in place, mine probably is serviceable. Check to see percussion caps are in position before installing.

CAUTION

Without nuts on fuze plungers mine is so sensitive that its own weight is almost enough to set it off.

SPACE FOR NOTES

GERMAN "S" MINE

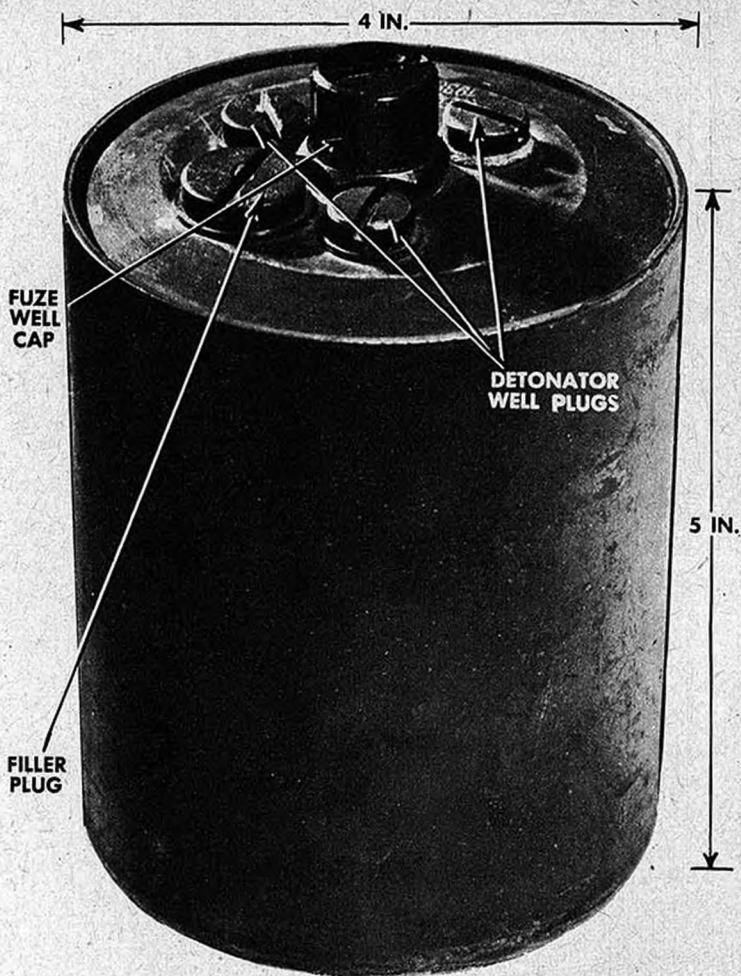

TYPE. Bounding antipersonnel mine

COLOR. Olive-drab

CASE. Steel

WEIGHT. 9 pounds

EXPLOSIVE. 6.5 oz. TNT

EFFECT. Causes casualties up to 150 yards

RE-USE

Examine mine for signs of rust or deterioration around fuze well, detonator wells, or top edge. If mine has seal around top edge, and cap on fuze well, probably it is in good condition.

GERMAN "S" MINE

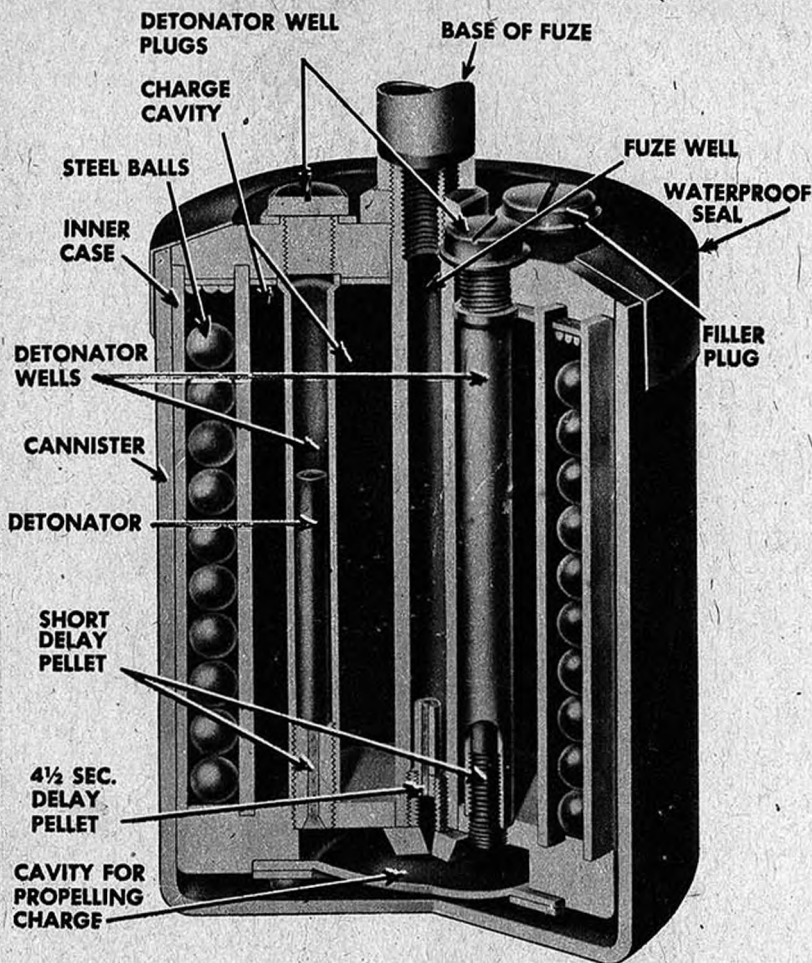

FUNCTIONING

Pressure fuze S. Mi. Z. 35, pull fuze Z. Z. 35, pull tension-release fuze Z. U. Z. Z. 35, or electric fuze E. S. Mi. Z. 40, commonly are used with this mine. Other standard German fuzes may be used.

IN ALL TYPE FUZES

1. Flash from fuze sets off $4\frac{1}{2}$ -second-delay pellet.
2. Pellet ignites black-powder propelling charge.
3. Powder charge projects inner case upward and at same time ignites short-delay pellets.
4. Short-delay pellets set off detonators and main charge when mine is 3 to 7 feet in air.
5. Main charge scatters 320 steel balls and fragments of case, up to 200 yards.

GERMAN "S" MINE

DISARMING

Disarming the "S" mine means disarming attached fuze or fuzes.

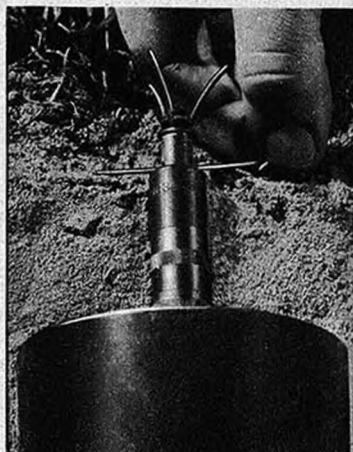

1. Insert pin in safety hole.
2. Cut any trip wires after checking anchor ends.
3. Check for booby traps and remove mine from hole.

DEFUZING



1. Remove fuze or fuzes.
2. Unscrew three plugs from detonator wells; remove detonators.
3. Replace plugs; place cap on or plug fuze well.

GERMAN "S" MINE

INSTALLING AND ARMING

1. Remove three screw plugs from detonator wells, insert either three standard German detonators or three United States non-electric blasting caps, OPEN END DOWN.
2. Replace screw plugs.
3. Remove cap from fuze well, attach pressure fuze, or Y connector and two pull fuzes.
4. Place mine in hole so that ends of pressure prongs or pull rings are just above ground level; if pull fuzes are used, attach trip wires, ANCHOR END FIRST.
5. Cover and camouflage mine; remove safety pins.

PACKING AND TRANSPORTING

Store and transport "S" mines with detonators removed, plugs in detonator wells, cap on fuze well. Watertight, pressed-metal carrying case, containing three mines, weighs 33 pounds. Wooden case containing three mines weighs about 35 pounds. Fuzes and other accessories are packed separately.

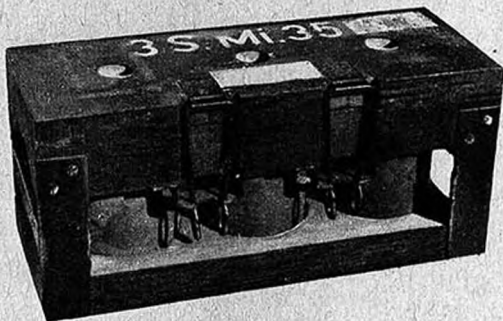

NOTE

Some of latest "S" mines have a spring beneath each detonator-well plug. This holds detonators in contact with short-delay pellets and insures uniform explosion; has no effect upon disarming or installation. In some mines balls are diamond shape, or pieces of $\frac{3}{8}$ -inch steel rod.

GERMAN STOCK MINE (CONCRETE)

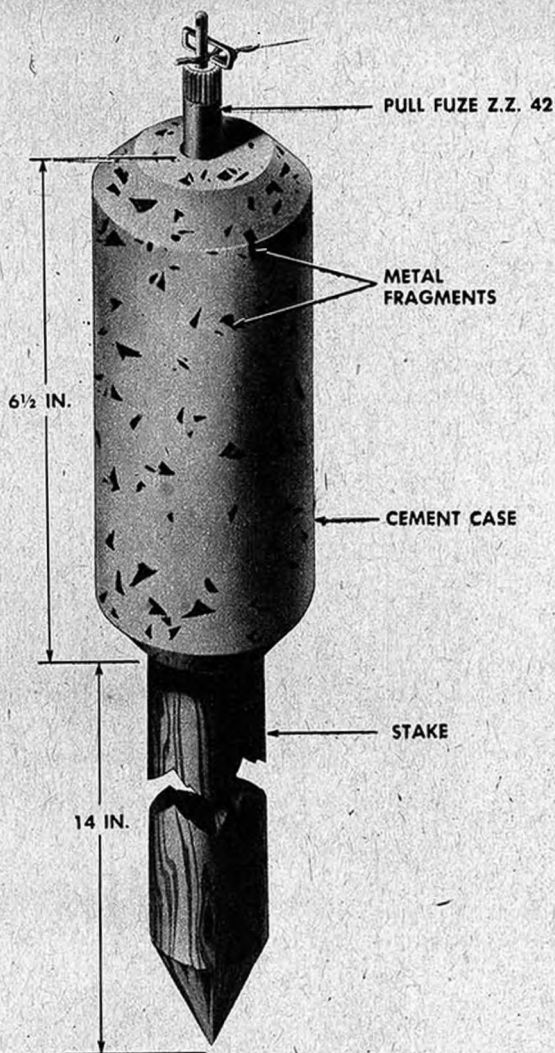

TYPE. Antipersonnel

COLOR. Gray.

CASE. Concrete with inserted steel fragments

WEIGHT. $4\frac{1}{2}$ pounds

EXPLOSIVE. Standard German borehole charge

EFFECT. Causes casualties up to 50 yards

EMPLOYMENT. With trip wires and pull fuze Z. Z. 42, issued with it
Also used with pull fuzes Z. Z. 35 or Z. U. Z. Z. 35.

GERMAN STOCK MINE (CONCRETE)

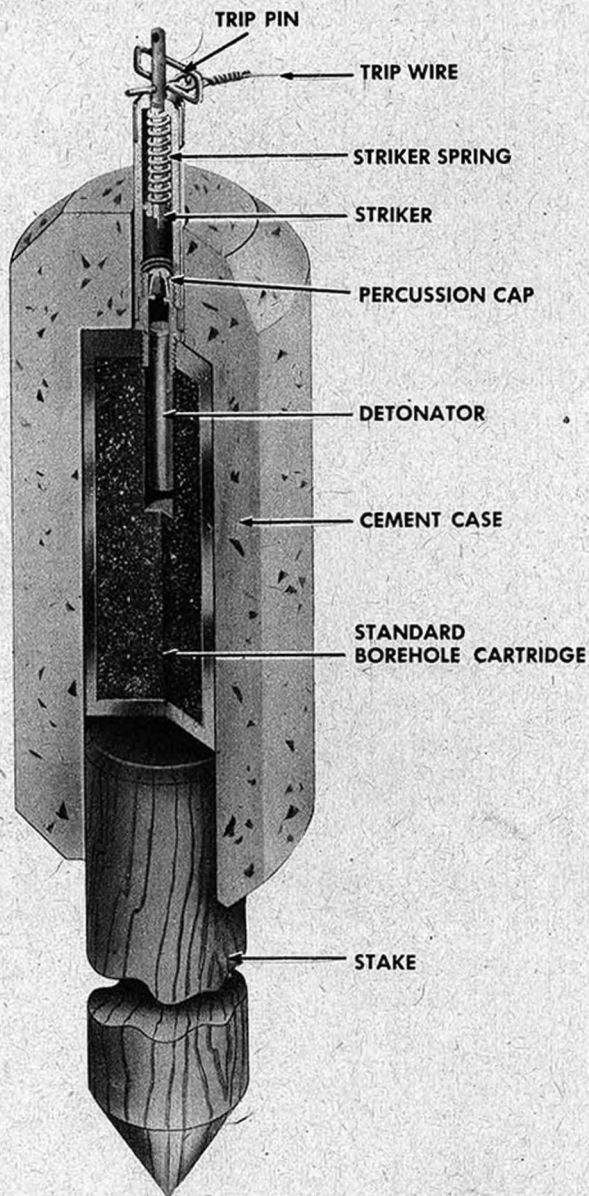

FUNCTIONING

1. Pull on trip wire withdraws pin from striker of Z. Z. 42 fuze.
2. Released striker, driven by spring sets off percussion cap—detonator—borehole charge.

GERMAN STOCK MINE (CONCRETE)

DEFUZING

IF PULL FUZE Z. Z. 42 IS USED—



1. Hold pin firmly in place, cut trip wire.

CAUTION

If pin is partially pulled out, do not attempt to disarm. Explode from safe place by charge placed near mine.



2. Remove fuze and detonator.



3. Pull mine and stake loose with 50-yard length of wire. Stake may be booby-trapped.



4. Remove stake and charge from mine.

IF PULL FUZE Z. Z. 35 or Z. U. Z. Z. 35 IS USED, insert safety pin before cutting trip wire; then repeat above procedure.

GERMAN STOCK MINE (CONCRETE)

INSTALLING AND ARMING

1. Drive stake until about 5 inches remains above ground.
2. Assemble mine by inserting German standard borehole charge in bottom and screwing into top of charge either pull fuze Z. Z. 42 or Z. Z. 35, with German detonator or U. S. nonelectric cap attached.
3. Impale mine on stake; or, if tree is used, tie mine to tree and plug hole in bottom. Germans provide cork plug for this. If fuze Z. Z. 35 is used, drive second stake, higher than and alongside mine, so that trip wire will run up over it and pull upwards on fuze when tripped.
4. Anchor trip wire.
5. Attach loose trip wire to pin if fuze Z. Z. 42 is used, or to trip-wire slot if fuze Z. Z. 35 is used. Camouflage.
6. Pull safety pin if pull fuze Z. Z. 35 is used.

PACKING AND TRANSPORTING

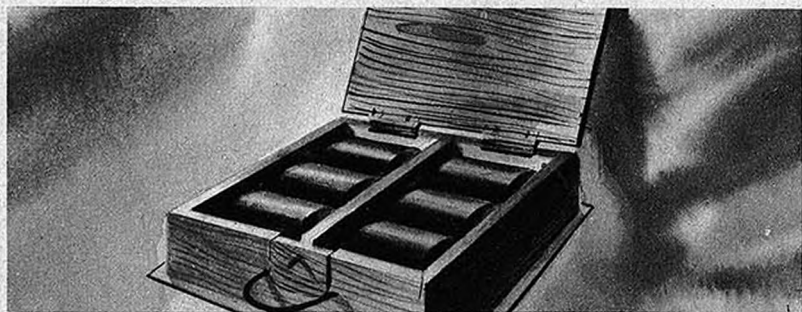

Wooden chest containing six mines weighs about 39 pounds.

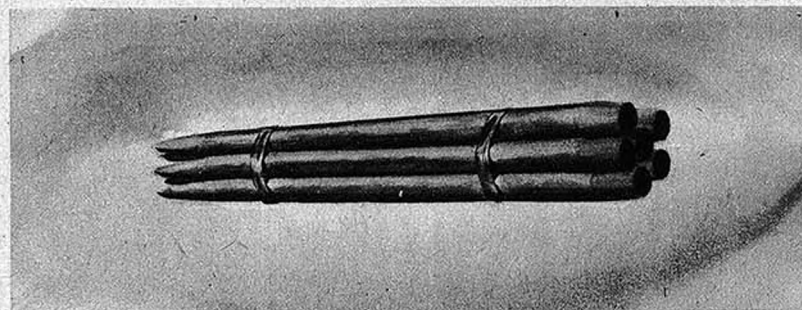

Stakes, in bundles of six, furnished with chests. Fuzes, borehole charges, and detonators are obtained from German demolition stores.

GERMAN BUTTERFLY BOMB

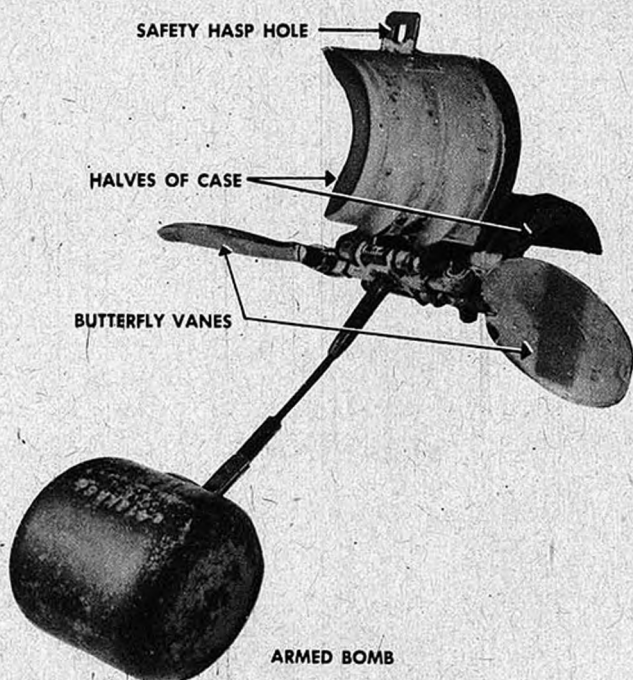

TYPE. Antipersonnel bomb

COLOR. Green-gray

CASE. Sheet metal

WEIGHT. 4½ pounds

EXPLOSIVE. Yellow TNT (7.5 oz.)

EFFECT. Causes casualties within a radius of 50 feet

EMPLOYMENT. Dropped from low-flying aircraft.

PACKING AND TRANSPORTING

Container holds 23 bombs.

CAUTION

Three types of fuze have been found in bomb. In 41 fuze, selector screw can be set at ZEIT to explode bomb 3 seconds after arming, or at AZ to explode on impact. Clockwork in 67 fuze is adjustable for delays of 10, 20, or 30 minutes. ZEIT and AZ often are stamped on this fuze for deception. Fuzes 70 (A) and 70 (B) are antihandling devices, probably similar in action to that in Italian thermos bomb. Bombs extremely dangerous when armed with them.

GERMAN BUTTERFLY BOMB

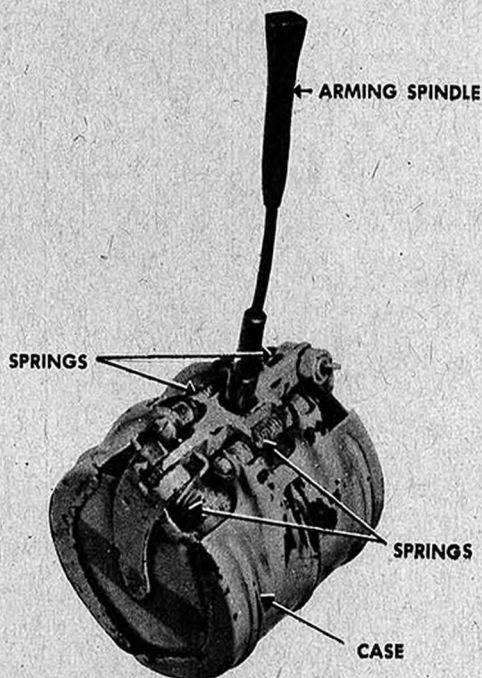

UNARMED BOMB

FUNCTIONING

1. Container holding 23 bombs opens after falling predetermined distances, allowing bombs to scatter.
2. Springs force apart two halves of bomb case.
3. Halves of case and two butterfly vanes move to top of spindle wire, arming bomb.
4. Bomb explodes at predetermined time, on impact, or when handled, depending on type of fuze installed.

DEFUZING

If case still is closed, bomb is unarmed and fuze may be removed. If bomb is armed, wait 45 minutes. To destroy bomb, build sandbag wall around it and, from behind sandbags, pull bomb with rope; or, set off small charge next to it.

SPACE FOR NOTES

GERMAN PRESSURE FUZE S. MI. Z. 35

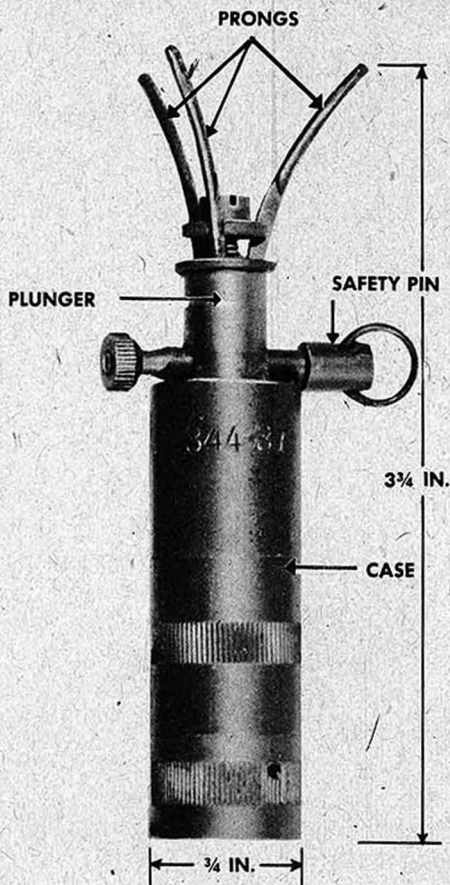

TYPE. Pressure fuze

COLOR. Olive-drab

CASE. Aluminum

EMPLOYMENT

This is the standard German pressure fuze for the "S" mine. Usually only tips of prongs are above ground surface.

PACKING AND TRANSPORTING

Use standard German fuze container.

RE-USE

Before reuse, check fuze by testing safety pin to see if it can be withdrawn, and looking at cap to see if it has been fired. Do not test by firing, as fuze cannot be recocked without special tools.

GERMAN PRESSURE FUZE S. MI. Z. 35

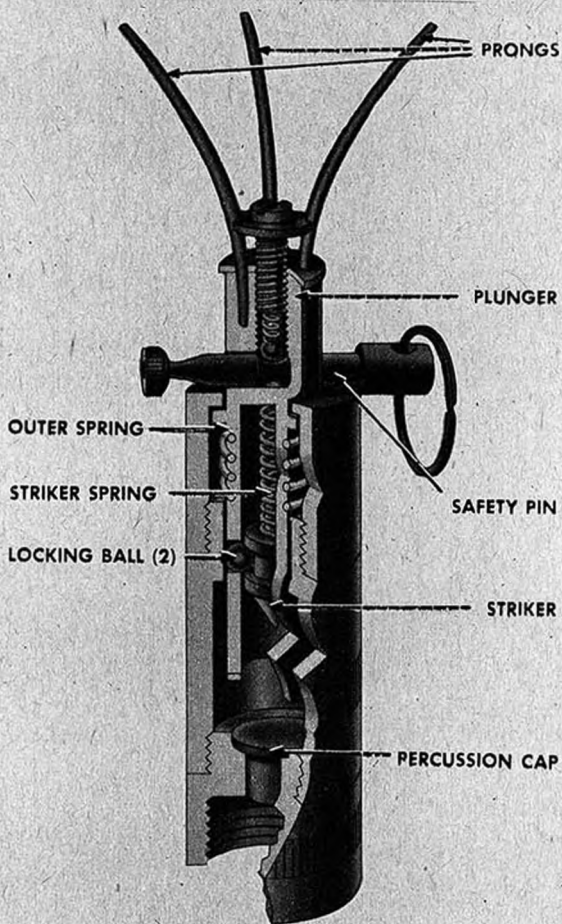

FUNCTIONING

1. With safety pin removed, 8-10 pounds pressure on prongs overcomes resistance in outer spring, and depresses plunger.
2. This permits two locking balls to be forced outward, releasing striker.
3. Released striker, driven by striker spring, explodes percussion cap.

DISARMING

Insert pin or wire in safety hole.

INSTALLING AND ARMING

1. Attach fuze to mine.
2. Install mine and camouflage.
3. Remove safety pin.

GERMAN PRESSURE FUZE D. Z. 35

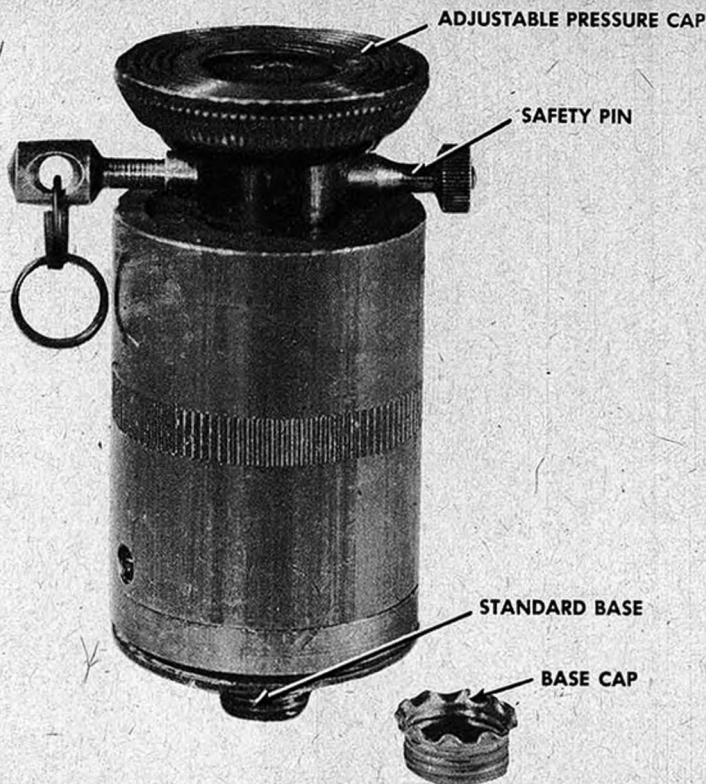

LARGE TYPE

TYPE. Pressure fuze

COLOR. Large type, brown; small type, unpainted

CASE. Large type, aluminum; small type, brass

EMPLOYMENT

Large type generally used in improvised wood mines; small type for booby-trapping.

DISARMING

Insert safety pin in hole of plunger.

DEFUZING

1. Remove fuze and detonator from charge or mine.
2. Detach detonator from fuze. No detonator if used with "S" mine.

PACKING AND TRANSPORTING

Use standard German fuze container.

RE-USE

Examine to see an unfired cap is in place.

GERMAN PRESSURE FUZE D. Z. 35

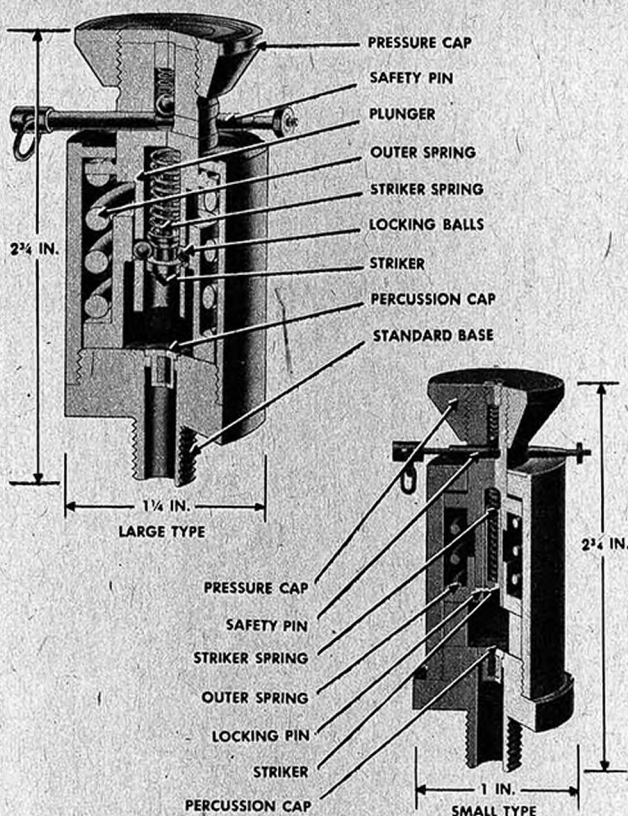

FUNCTIONING

1. Pressure (130-160 pounds for large type, 15-20 pounds for small type) on pressure cap forces plunger downward against resistance of outer spring.
2. Two locking balls (large-type fuze) or two locking pins (small-type fuze) are forced outward into lower open space, releasing striker.
3. Released striker, driven by striker spring, sets off percussion cap.

INSTALLING AND ARMING

1. Attach German detonator to base of fuze or wedge United States nonelectric cap into it.
2. Attach fuze to charge or mine. Detonator must go inside mine.
3. Adjust height of pressure cap. By raising or lowering pressure cap, vary distance top of mine must be depressed to bear on cap, thereby varying operating pressure of mine.
4. Remove safety pin.

GERMAN PRESSURE FUZE PX 32

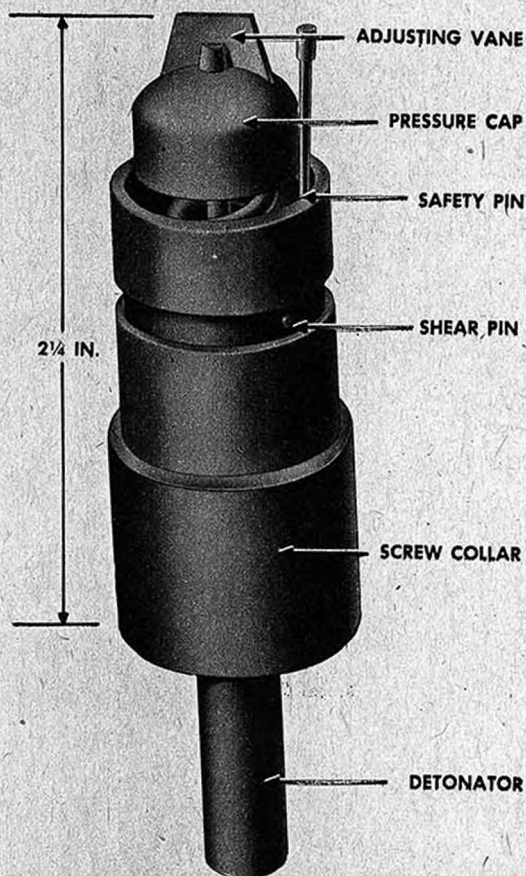

TYPE. Pressure fuze

COLOR.

CASE. Metal

EMPLOYMENT. With improvised mines

DISARMING

Remove fuze and attached detonator from charge.

INSTALLING AND ARMING

1. Fuze comes with detonator attached. If detonator has been removed, remove screw collar at base, insert standard German detonator, screw on collar to hold in place.
2. Insert detonator in charge.
3. Remove safety pin.

GERMAN PRESSURE FUZE PX 32

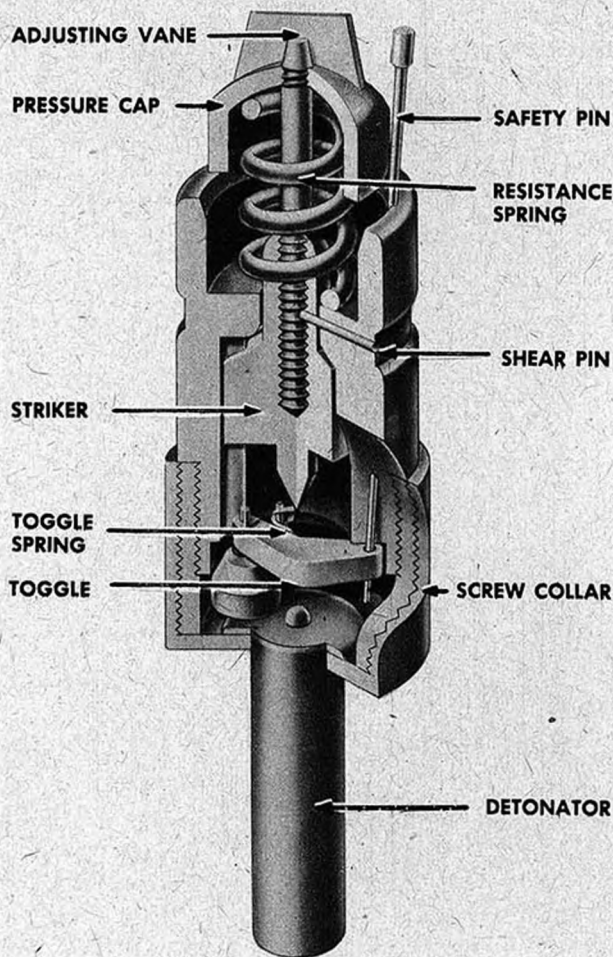

FUNCTIONING

1. Pressure on pressure cap overcomes resistance in spring, shears shear pin, and forces striker onto percussion cap.
2. Flame from percussion cap ignites attached detonator.

FUNCTIONING OF SAFETY

Safety pin holds toggle in position covering percussion cap. When pin is removed, toggle spring swings toggle away from above cap. Fuze should not be reused if safety pin is withdrawn.

PACKING AND TRANSPORTING

Fuze transported with cap and detonator in place. Use standard German metal fuze container.

GERMAN PULL FUZE Z. Z. 35

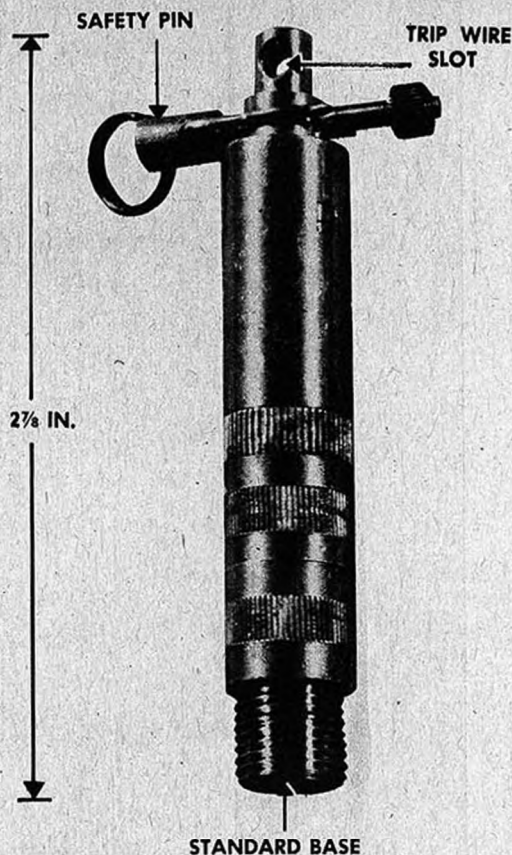

TYPE. Pull fuze

COLOR. Unpainted brass

CASE. Brass

EMPLOYMENT

Standard for "S" mines and prepared charges, for booby-trapping Tellermines, and for booby traps employing trip wires. Threaded base fits all standard charges, grenades, and mines.

PACKING AND TRANSPORTING

Use German standard fuze container.

RE-USE

Check fuze by testing safety to see if it can be withdrawn, and look at cap to see if it has been fired. Do not test by firing, as fuze cannot be reset without special tools.

GERMAN PULL FUZE Z. Z. 35

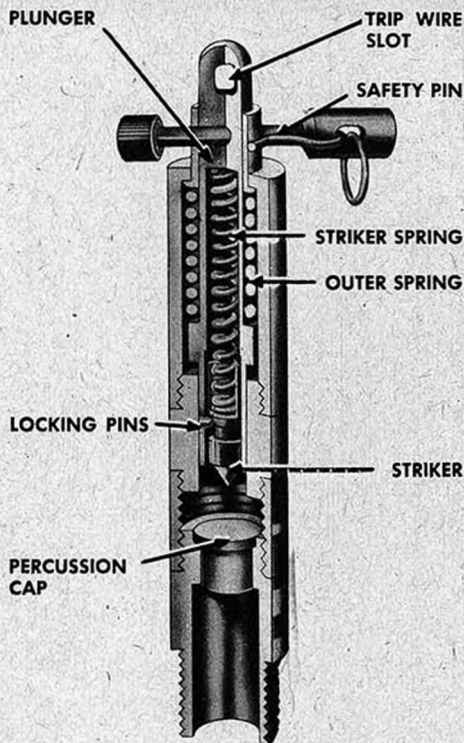

FUNCTIONING

1. Pull on trip wire moves plunger upward against resistance of outer spring.
2. Two locking pins are forced outward when they come opposite open spaces, releasing striker.
3. Released striker, driven by striker spring, sets off percussion cap.

DISARMING

1. Insert pin in safety-pin hole.
2. Remove trip wire, first checking anchor end.

DEFUZING

1. Remove fuze and detonator from charge or mine.
2. Remove detonator from fuze.

INSTALLING AND ARMING

1. Attach German detonator to base of fuze, or wedge United States nonelectric cap into it.
2. Attach fuze to mine or charge, detonator inside.
3. Attach loose trip wire, first to anchor then to trip wire slot.
4. Unscrew nut and remove safety pin.

GERMAN PULL-RELEASE FUZE Z. U. Z. Z. 35

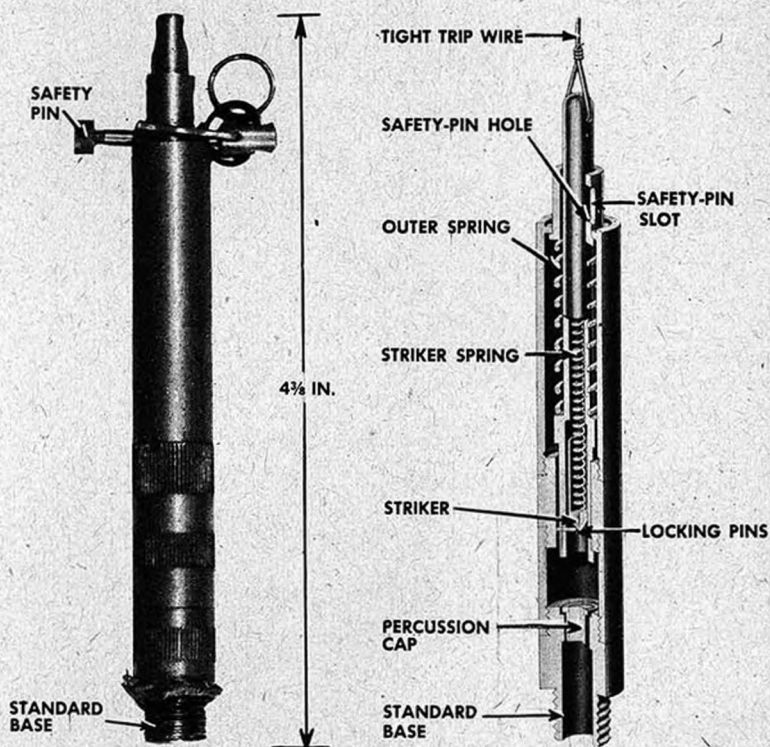

TYPE. Either pull or tension-release fuze

COLOR. Unpainted

CASE. Brass

EMPLOYMENT

Used with "S" mines, prepared charges, and booby traps.

FUNCTIONING

Trip wire on this fuze must be under tension. Fuze is fired by pulling on trip wire; or, by loosening, cutting, or breaking it.

1. Pull on trip wire pulls plunger upward against resistance of outer spring; two locking pins are forced outward into upper open space, releasing striker.

2. When trip wire is cut, outer spring forces plunger down until two locking pins are forced outward into lower space, releasing striker.

3. In either case released striker, driven by striker spring, sets off percussion cap.

GERMAN PULL-RELEASE FUZE Z. U. Z. Z. 35

DISARMING

1. Insert pin in safety slot.
2. Remove trip wire, first checking anchor end.

DEFUZING

1. Remove fuze and detonator from charge.
2. Detach detonator from fuze.

INSTALLING AND ARMING

1. Attach German detonator to base of fuze, or wedge U. S. nonelectric cap into it.
2. Attach fuze to charge or mine. Detonator must go inside charge.
3. Anchor trip wire.
4. Attach trip wire to trip-wire slot, adjusting tension so that safety pin comes just past middle of safety-pin slot.
5. Remove nut and pull out safety pin.

PACKING AND TRANSPORTING

Use German standard fuze container.

RE-USE

Examine fuze to make sure unfired cap is in place.

NOTES

This fuze has proved so dangerous to use that a number have been returned to the factory and modified. The modified fuze is stamped NUR ZUGZUNDER (only pull fuze). Interior works are the same, but trip-wire slot has been cut off end of plunger, and fuze is tripped by withdrawal of safety pin to which trip wire is attached.

SPACE FOR NOTES

GERMAN PULL (BAKELITE) FUZE Z. Z. 42

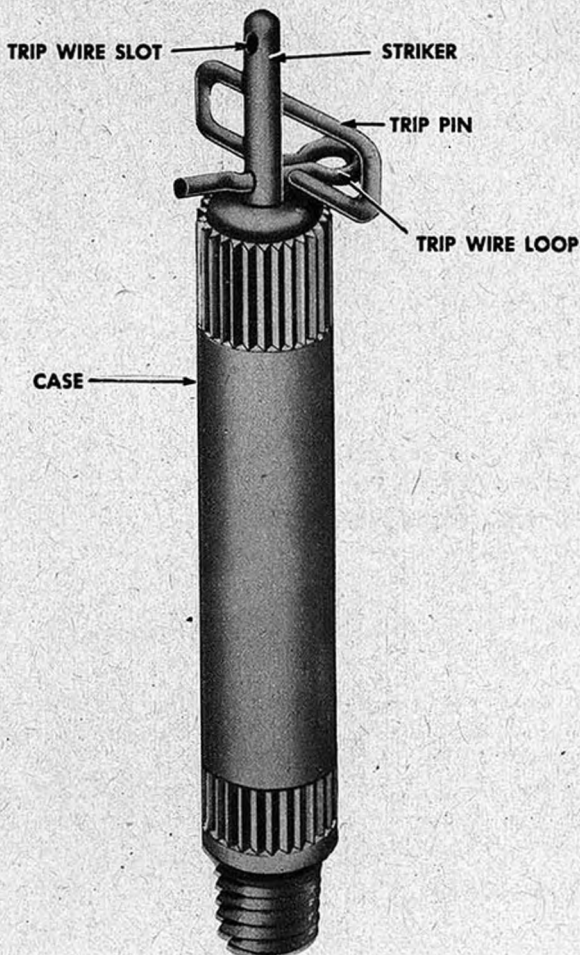

TYPE. Pull

COLOR. Unpainted

CASE. Bakelite

EMPLOYMENT. In booby traps and with stock mine

PACKING AND TRANSPORTING

This fuze comes as part of STOCK MINE SET. If carried separately, put cap over its base and/or carry in German standard fuze container.

RE-USE

Before using as pull-type fuze, make sure spring is strong enough to hold safety pin firmly.

GERMAN PULL (BAKELITE) FUZE Z. Z. 42

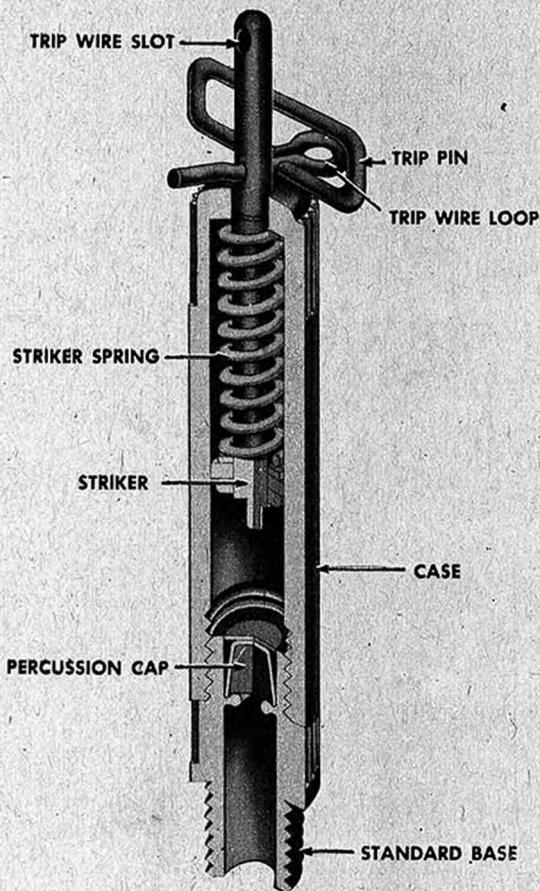

FUNCTIONING

1. Pull on trip wire withdraws tip pin, releasing striker.
2. Striker, driven by spring, explodes percussion cap.

DEFUZING

1. Hold pin in position, cut trip wire near trip pin.
2. Remove fuze and detonator from charge.

INSTALLING AND ARMING

1. Attach detonator.
2. Insert in charge.
3. Anchor far end of wire.
4. Fasten other end to trip pin, making sure wire is *not* taut.

NOTE

This fuze can be used as a release fuze by removing trip pin and holding striker in a cocked position with a tight trip wire.

GERMAN ELECTRIC FUZE E. S. MI. Z. 40

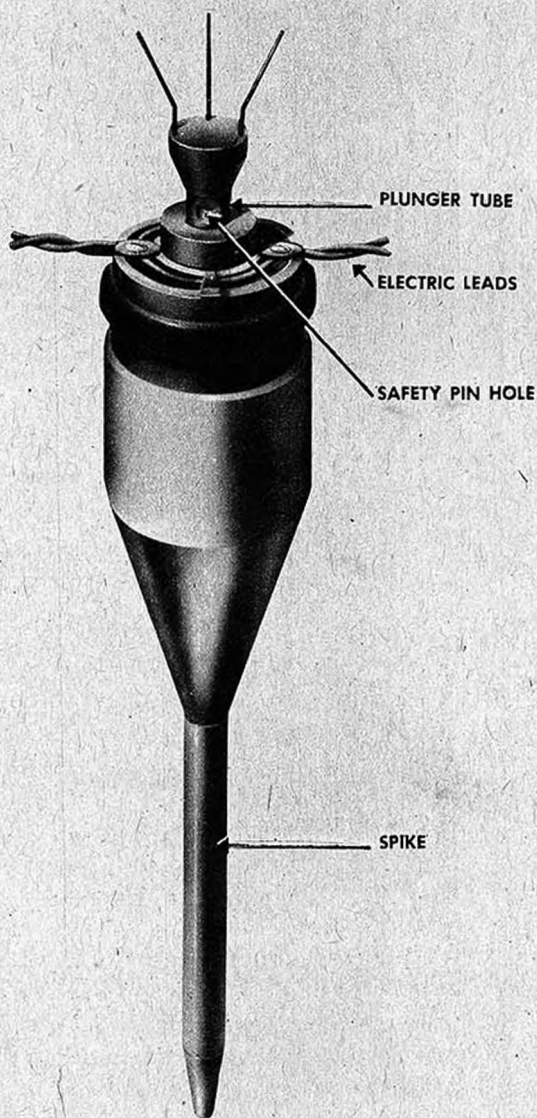

TYPE. Pressure

COLOR. Initiating fuzes, black; firing bridge, aluminum

CASE. Initiating fuzes, ebonite; firing bridge, aluminum

EMPLOYMENT

To explode German "S" mine. For each "S" mine, use a firing bridge and two chains of nine electric fuzes each.

GERMAN ELECTRIC FUZE E. S. MI. Z. 40

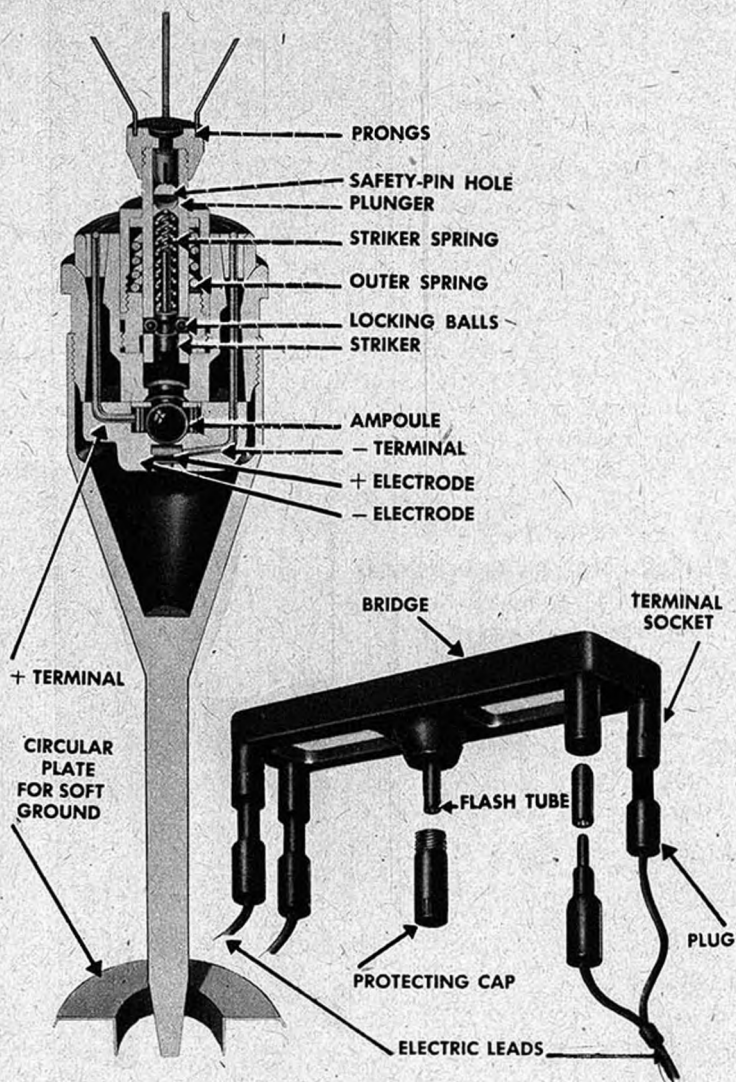

FUNCTIONING

1. Pressure on prongs of electric fuze depresses plunger.
2. Two steel balls disengage from groove in head of striker, releasing striker.
3. Striker, driven by spring, breaks ampoule.
4. Electrolyte in ampoule sets up electric current between electrodes.
5. Current induces flash in flash tube of firing bridge, exploding mine.

GERMAN ELECTRIC FUZE E. S. MI. Z. 40

DISARMING

To disarm chain of electric fuzes, remove lead plugs from sockets in bridge.

To disarm individual electric fuzes, insert nail in safety-pin hole in top of plunger tube.

INSTALLING AND ARMING

1. Connect in parallel two chains each of nine electric fuzes, with 2 feet $7\frac{1}{2}$ inches of wire between fuzes, and 5 feet 3 inches between end fuzes and plugs.

2. Make two furrows in ground to receive wires, drive down fuzes to top of safety transit cap.

3. Test electric leads with lead tester by plugging into tester and short-circuiting most distant fuze.

4. Unscrew safety transit cap, release safety-pin rings from plunger tubes, attach withdrawal cords to rings.

5. Screw firing bridge onto "S" mine and set mine in U-clamp.

6. Insert red plug in red bridge socket, and black in black.

7. Pull withdrawal cords.

PACKING AND TRANSPORTING

Case carries U-clamp, bridge, and two metal bars each holding mine fuzes in sockets.

RE-USE

Test leads before re-using.

NOTE

Pressure bar, 1 foot $4\frac{1}{2}$ inches long, can be placed between prongs of adjacent fuzes.

SPACE FOR NOTES

GERMAN ELECTRIC FUZE E. S. MI. Z. 40

SPACE FOR NOTES

GERMAN CLOCKWORK LONG-DELAY FUZE

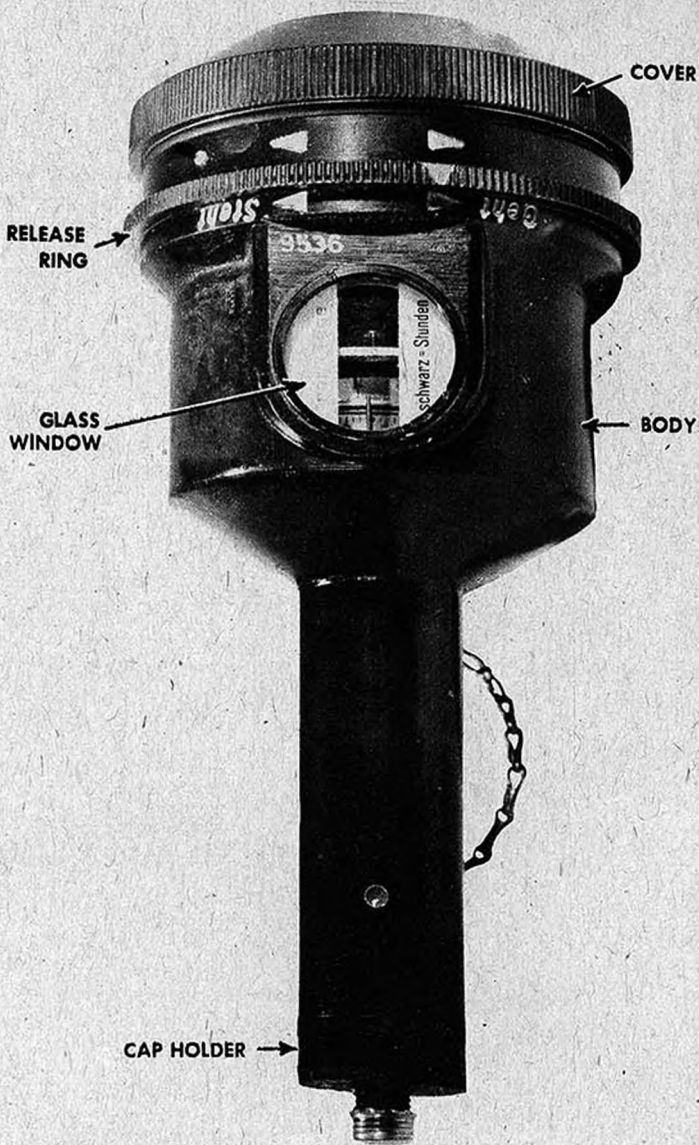

TYPE. Clockwork

COLOR. Black

CASE. Aluminum casting or Bakelite

EMPLOYMENT. For large-scale delayed demolitions. May be set for $\frac{1}{4}$ -hour to 21-day delay

GERMAN CLOCKWORK LONG-DELAY FUZE FUNCTIONING

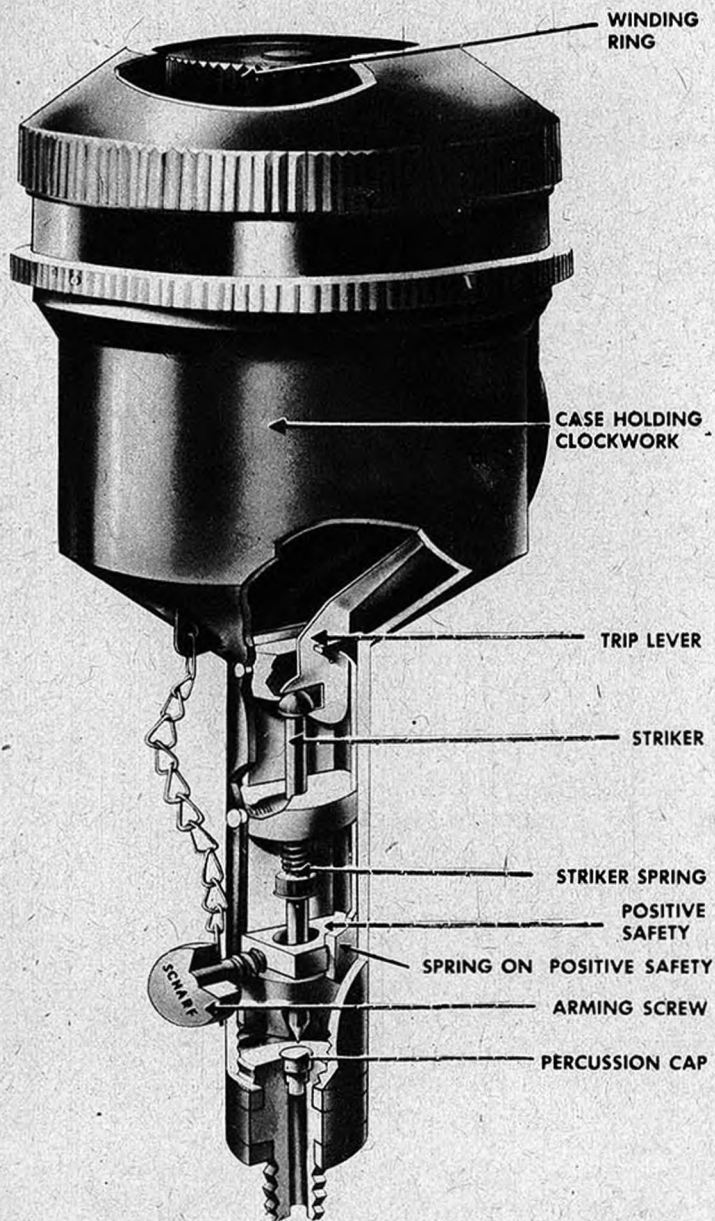

1. At end of delay period, lever arm on rotating control disk in clockworks bears against trip lever, disengaging striker.
2. Striker, driven by spring, explodes percussion cap in base.

GERMAN CLOCKWORK LONG-DELAY FUZE

DISARMING



1. Remove set screw marked SCHARF to allow spring to push safety block between striker and cap, and screw in plug marked BLIND.



2. Turn red mark on release ring from GEHT (go) to STEHT (stop), arresting clockwork.
3. Remove fuze and detonator from charge.

INSTALLING AND ARMING

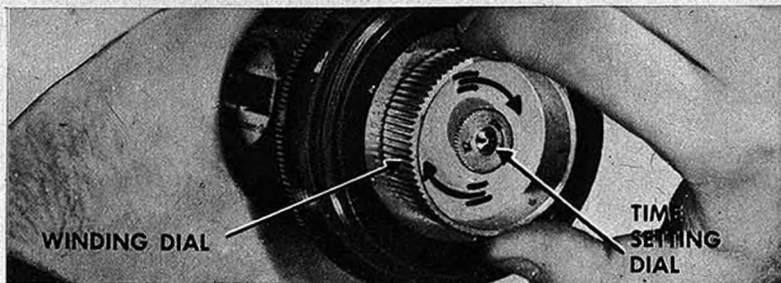

1. Unscrew cover and wind clock by turning knurled cylinder clockwise.
2. Set time-setting knob for desired delay. Setting is visible through glass window, TAGE for days and STUNDEN for hours.
3. Attach detonator to cap holder, insert in charge.
4. Remove plug marked BLIND and screw in fully set screw marked SCHARF.
5. Turn red mark on release ring from STEHT to GEHT.

GERMAN CLOCKWORK LONG-DELAY FUZE

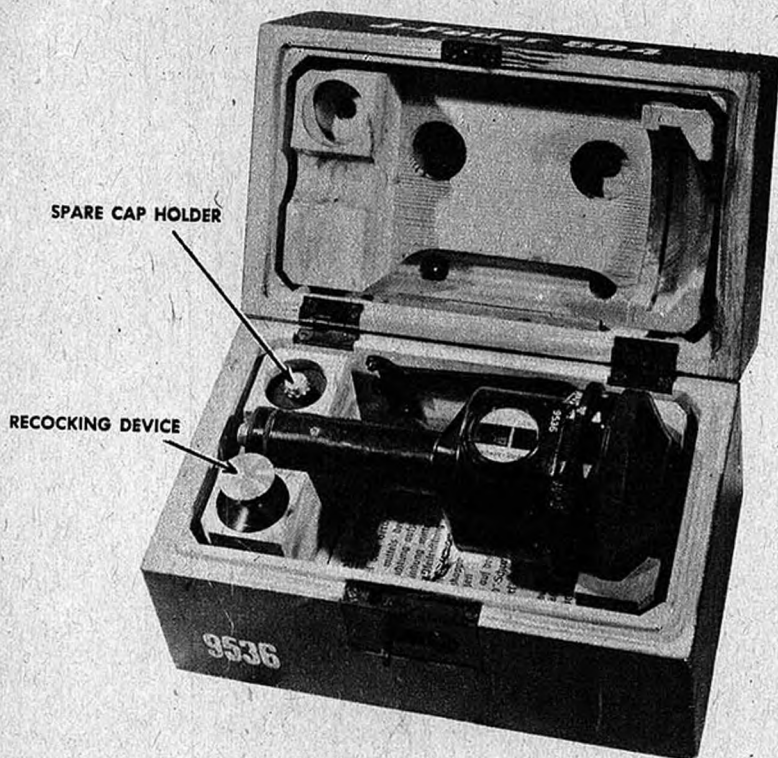

PACKING AND TRANSPORTING

Fuzes individually packed in black wooden boxes stenciled "J-Feder 504." Cap holder and cocking device inserted in welled blocks.

RE-USE

Test fuze, with percussion cap removed, by setting clockwork for $\frac{1}{4}$ hour. After testing, recock striker with recocking device.

SPACE FOR NOTES

GERMAN FRICTION FUZE ZDSCHN. ANZ. 29

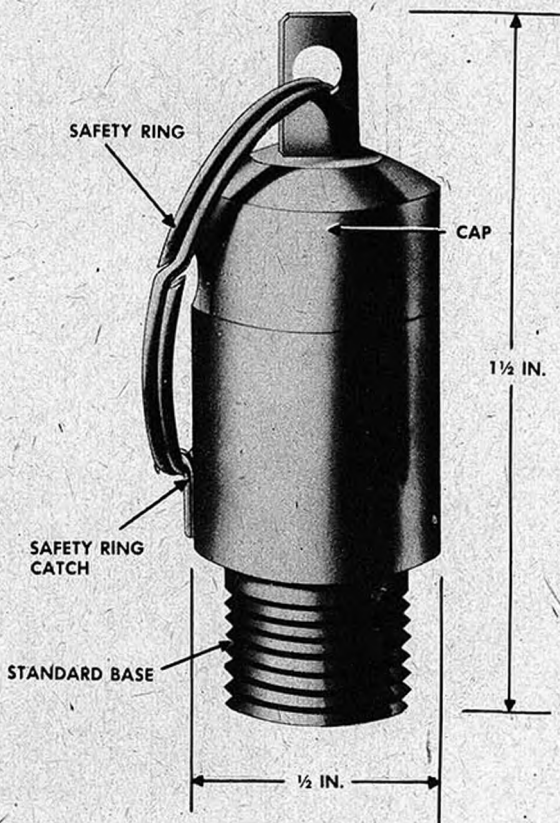

TYPE. Pull-friction fuze

COLOR. Unpainted

CASE. Brass

EMPLOYMENT

Attached to either safety fuze or detonator to set booby traps, to booby-trap mines, to ignite smoke candles and prepared charges.

DISARMING

Safe to handle as found. Fasten safety ring to body of fuze with tape to prevent its being pulled. Discard if ring has been partially pulled.

DEFUZING

Remove fuze and detonator from charge, detach detonator.

PACKING AND TRANSPORTING

Fuze is easily damaged by moisture. Pack in waterproof case, with cover cap in place on fuze base.

GERMAN FRICTION FUZE ZDSCHN. ANZ. 29

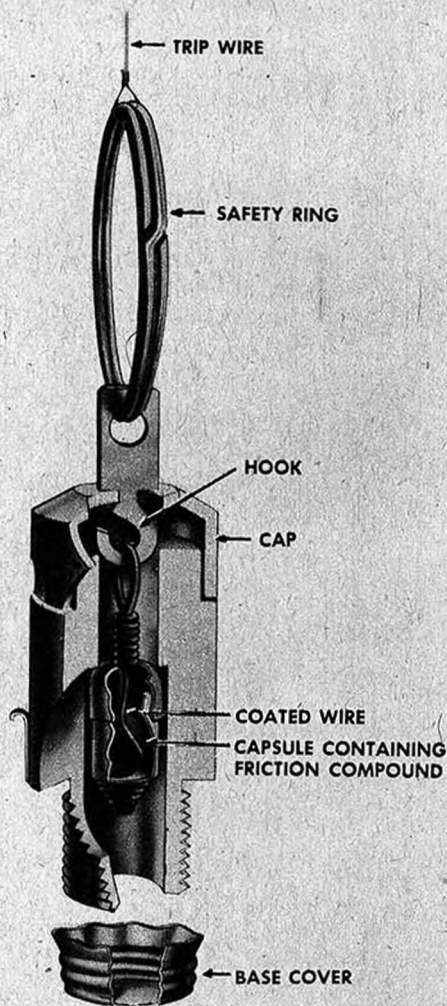

FUNCTIONING

1. Pull on trip wire attached to safety ring separates cap and hook from body.
2. Hook draws coated wire through friction compound, causing flame to spout out opening in threaded base.

INSTALLING AND ARMING

1. Attach German detonator to base of fuze, or wedge United States nonelectric cap into it. Length of safety fuze may be inserted between fuze and detonator.
2. Attach fuze to mine or charge. Detonator must be inside.
3. Detach safety ring from side of mine.
4. Attach loose trip wire to safety ring.

GERMAN FRICTION FUZE ZDSCHN. ANZ. 39

REMOVEABLE
HEAD



STANDARD
BASE

2 1/8 IN.

TYPE. Pull friction fuze

COLOR. Field gray

CASE. Aluminum

EMPLOYMENT

Primarily used for the ignition of safety fuze in demolition work. Also used to ignite smoke candles, to booby-trap Tellermines and grenades, and to set off improvised mines and booby traps.

PACKING AND TRANSPORTING

Important to keep fuze dry. With cap and base cover in place fuze is fairly waterproof. However, it should be stored and transported in a watertight container.

GERMAN FRICTION FUZE ZDSCHN. ANZ. 39

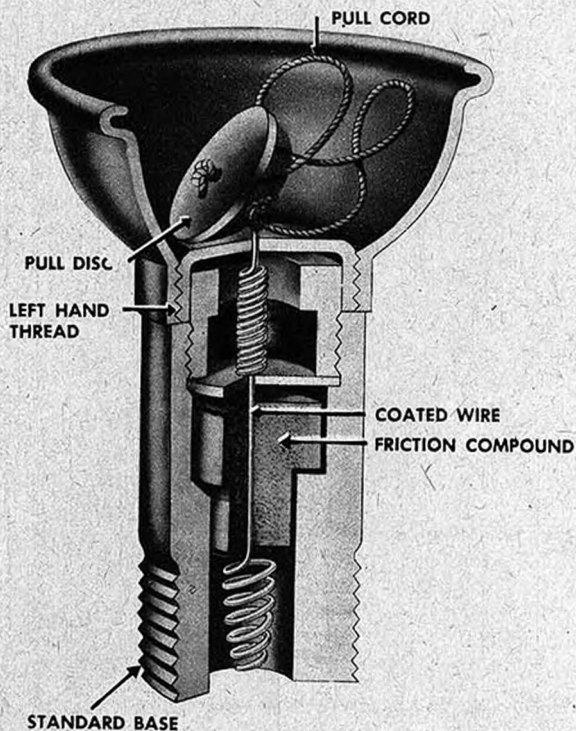

FUNCTIONING

WITH CAP REMOVED

1. A pull on pull disc and cord—
2. Draws the coated wire through the friction compound—
3. And ignites the friction compound, which shoots flame out the open end of the threaded base.

DISARMING

1. Unfasten pull cord from anything to which it might be attached.
2. Remove fuze and detonator from charge.
3. Detach detonator from fuze and replace cap if available.

INSTALLING AND ARMING

1. Attach German detonator to base of fuze, or wedge U. S. nonelectric cap into it.
2. Attach fuze to mine. Detonator must be inside.
3. Remove cap (left hand thread to distinguish from friction fuze B. Z. E.), attach trip wire, and conceal.

RE-USE

Examine for signs of water deterioration before using.

GERMAN FRICTION FUZE B.Z.E. WITH DELAY PELLET

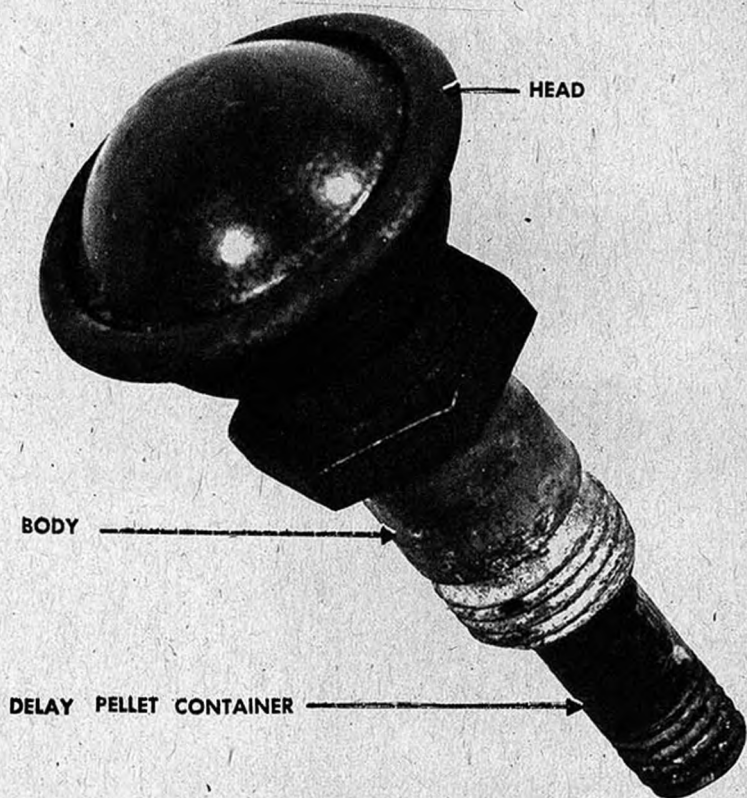

TYPE. Pull

COLOR. Head blue when used with "egg" grenade; red when used with "message-box" smoke flare

CASE. Brass body; steel tube

EMPLOYMENT. Generally with "message box" smoke flare and "egg" or "shaving stick" grenades

RE-USE

Check for presence of delay pellet in steel tube.

NOTES

Blue pellet used with "egg" grenade gives $4\frac{1}{4}$ -second delay.
Red pellet used with "message-box" smoke flare gives 1-second delay.

CAUTION

Germans vary color of head and length of delay. Always check delay before using.

GERMAN FRICTION FUZE B.Z.E. WITH DELAY PELLET

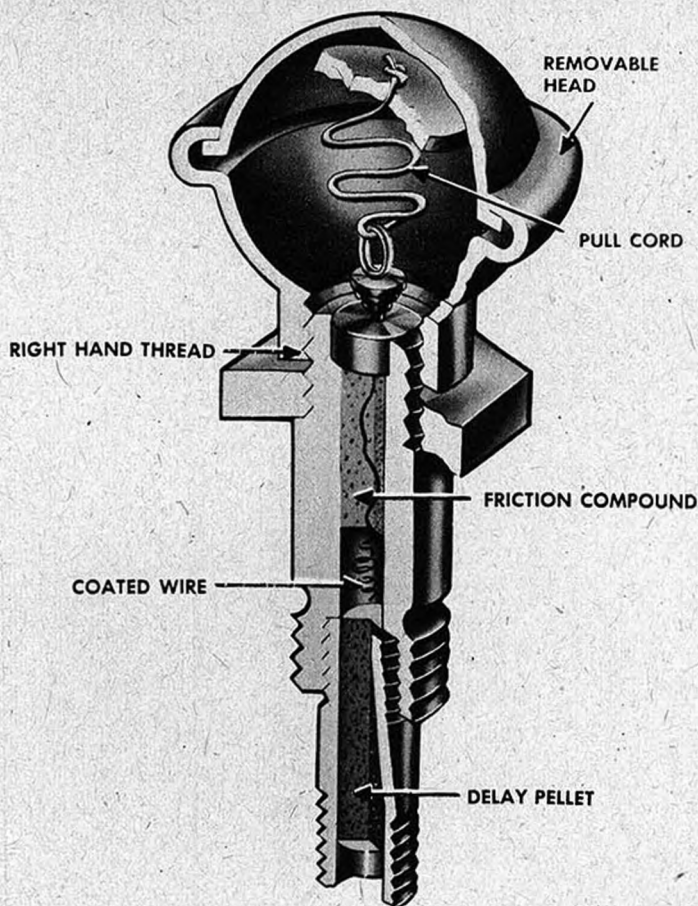

FUNCTIONING

1. When head is unscrewed and cord pulled, coated wire ignites friction compound in body.
2. Flame from compound sets off delay pellet in tube.
3. Burning pellet ignites attached fuze or detonator.

DISARMING

When head is screwed to body, fuze is safe to handle. If fuze is found with trip wire—

1. Cut trip wire, near pull wire.
2. Unscrew head of fuze.

INSTALLING AND ARMING

1. Screw into grenade or flare.
2. Unscrew head of fuze (right hand thread to distinguish from friction fuze Zdschn. Anz. 39).

GERMAN FRICTION FUZES B. Z. 24 AND NB. B. Z. 38, WITH DELAY PELLETS

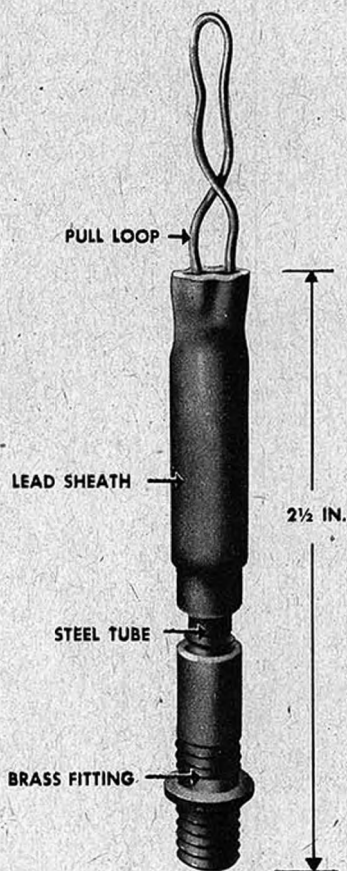

TYPE. Pull

CASE. Soft lead sheath; brass fitting; steel tube

EMPLOYMENT. B. Z. 24 fuze generally used with "stick" grenade;
Nb. B. Z. 38 with smoke grenade.

RE-USE

Make sure lead sheath is flattened at end, to prevent accidental firing.

NOTE

Band at base of lead sheath on Nb. B. Z. 38 appears to be white.
Pellet in B. Z. 24 igniter has $4\frac{1}{2}$ -second delay.

CAUTION

Duration of delay frequently is reduced in booby-trap installations, making grenades extremely dangerous.

GERMAN FRICTION FUZES B. Z. 24 AND NB. B. Z. 38, WITH DELAY PELLETS

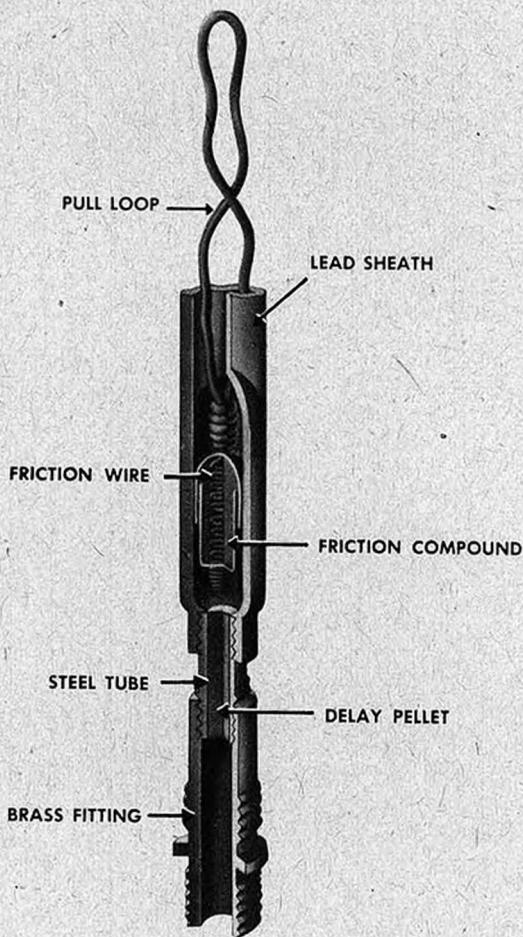

FUNCTIONING

1. When pulled, loop is freed from flattened lead sheath, drawing coated wire through friction compound in capsule.
2. Resulting flame ignites delay pellet.
3. Burning pellet ignites fuze or detonator attached to fitting.

DISARMING

Enclose pull loop completely in lead sheath, flatten sheath; or, cut pull loop near friction wire.

INSTALLING AND ARMING

1. Unscrew cap from fitting.
2. Screw entire fuze into head end of grenade.
3. Attach fuze loop to trip cord in grenade.

GERMAN ALUMINUM MINE

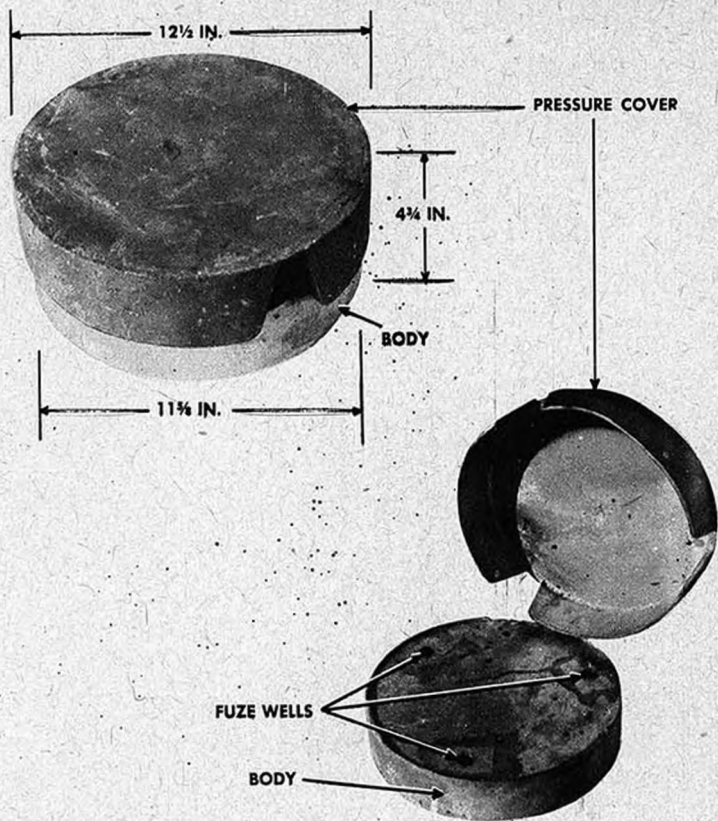

TYPE. Improvised antitank mine

COLOR. Tan

CASE. Aluminum alloy from salvaged aircraft

WEIGHT. 14 to 16½ pounds

EXPLOSIVE. 7 to 9 pounds of cheddite with tolite boosters

EFFECT. Disables tanks

PACKING AND TRANSPORTING

In transporting, remove fuzes and place adhesive tape over holes in lid.

RE-USE

If T. Mi. Z. 42 fuzes are used, make sure shear pins are not partially cut.

NOTE

Can be detected by mine detector.

GERMAN ALUMINUM MINE

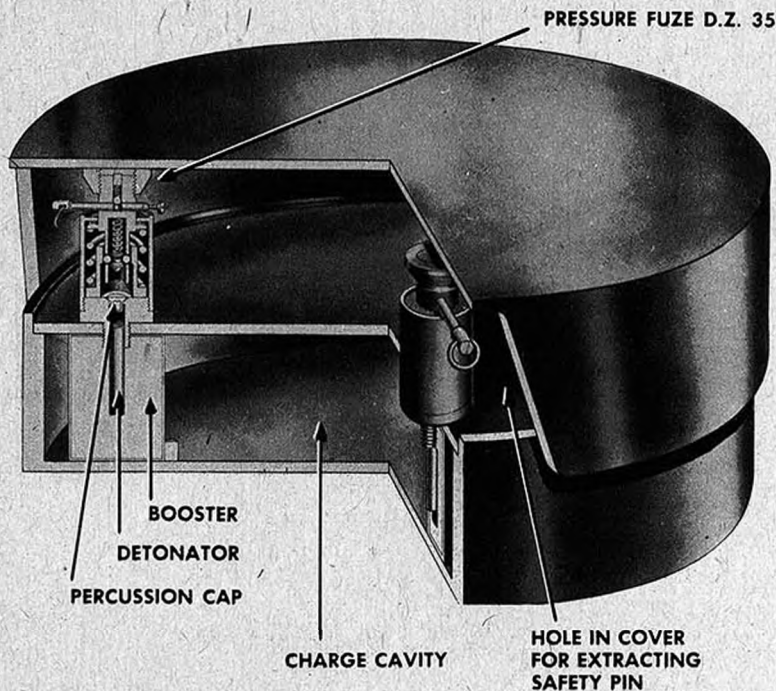

FUNCTIONING

1. Pressure of 130 pounds on sides to 390 pounds in center depresses cover and sets off one or more of three pressure fuzes, either German D. Z. 35 or T. Mi. Z. 42.
2. Fuzes explode detonators, boosters, main charge.

DISARMING

1. Remove cover.
2. If fuzes are D. Z. 35, insert nails or stout wires in safety-pin holes; if T. Mi. Z. 42, remove from mine.

DEFUZING

1. Remove D. Z. 35 fuzes.
2. Unscrew detonators from fuzes.
3. Replace cover.

ARMING AND INSTALLING

1. Screw detonators on fuzes, making sure safety pin is inserted in D. Z. 35 fuzes.
2. Remove mine cover.
3. Install fuzes, making sure pressure heads are adjusted equally.
4. Replace cover.
5. Remove safety pins from D. Z. 35 fuzes by pulling on attached cords.

GERMAN IMPROVISED WOODEN BOX MINES

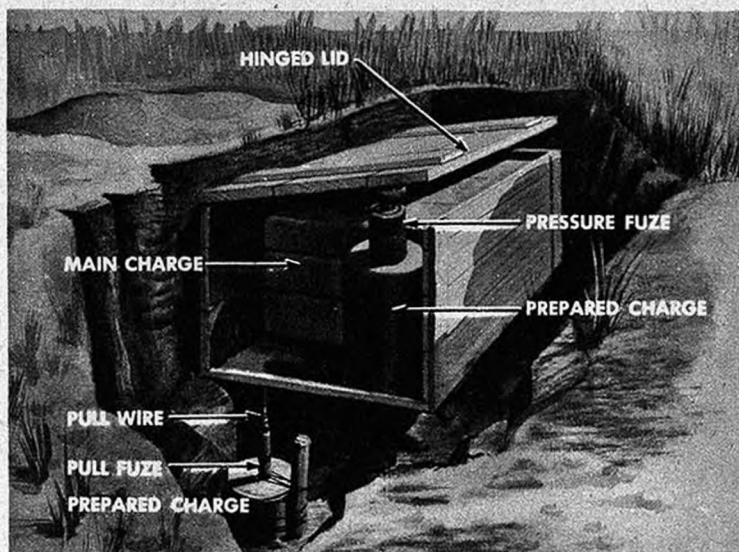

TYPE. Antitank mine

COLOR. Tan

CASE. Wooden box

WEIGHT. 7 to 20 pounds

EXPLOSIVE

5 to 18 pounds of trinitol, borehole charge (model 28), or metal-container HE charge (models 24 and 28).

GERMAN IMPROVISED WOODEN BOX MINES

FUNCTIONING

1. Pressure on hinged or loosely attached lid depresses pressure cap of pressure fuze, usually D. Z. 35 type.
2. Fuze explodes detonator in prepared charge, which acts as booster setting off main charge.

DISARMING

1. Investigate for pull fuzes. If one is attached to lid of mine, cut pull wire and remove lid; or, from covered position, pull off lid with 50 yards of rope or wire.
2. Insert safety pin in pressure fuze.

DEFUZING

1. Unscrew pressure fuze from prepared charge.
2. From covered position, pull out mine with 50 yards of rope or wire.
3. Wait at least 10 seconds before leaving position, in case delay-action secondary fuze has been attached.

INSTALLING AND ARMING

1. Place box packed with explosive in hole.
2. Attach pull fuze to side or bottom.
3. Screw into prepared charge pressure fuze with detonator.
4. If feasible, attach pull fuze to lid.
5. Remove safety pins.
6. Cover with 5 to 6 inches of earth; camouflage.

RE-USE

Inspect explosive carefully for deterioration.

NOTE

Mines buried 5 to 6 inches cannot be detected by mine detector.

SPACE FOR NOTES

GERMAN IMPROVISED RAMP MINE

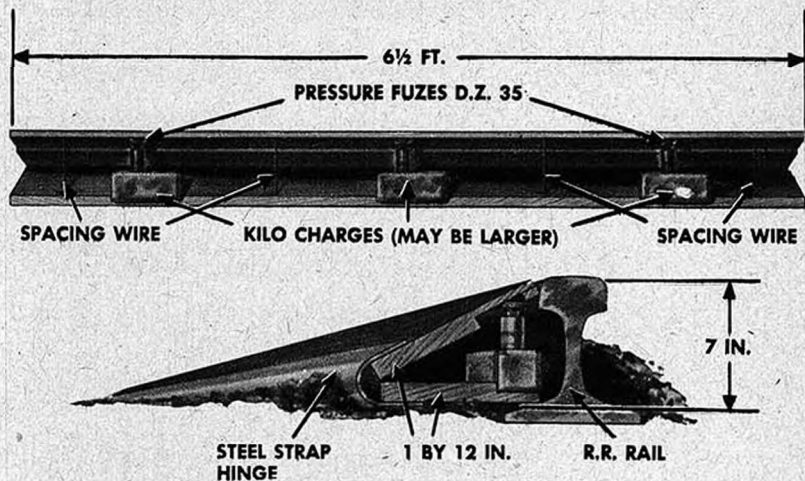

TYPE. Antitank

COLOR. Natural

CASE. Wood

EXPLOSIVE. Three or more standard kilo cartridges

EFFECT. Disables tanks

EMPLOYMENT

Laid at railroad crossing, simulating ramp to assist vehicles in crossing rails.

FUNCTIONING

Pressure on hinged plank depresses pressure caps on three pressure fuzes, setting off percussion caps—detonators—kilo cartridges.

DEFUZING

1. Examine for booby-trapping.
2. Cut tie wires and lift lid.
3. Insert safety pins in D. Z. 35 push fuzes.
4. Remove fuzes from charges, charges from mine.

INSTALLING

Use standard procedure for installing any improvised mine using D. Z. 35 fuzes.

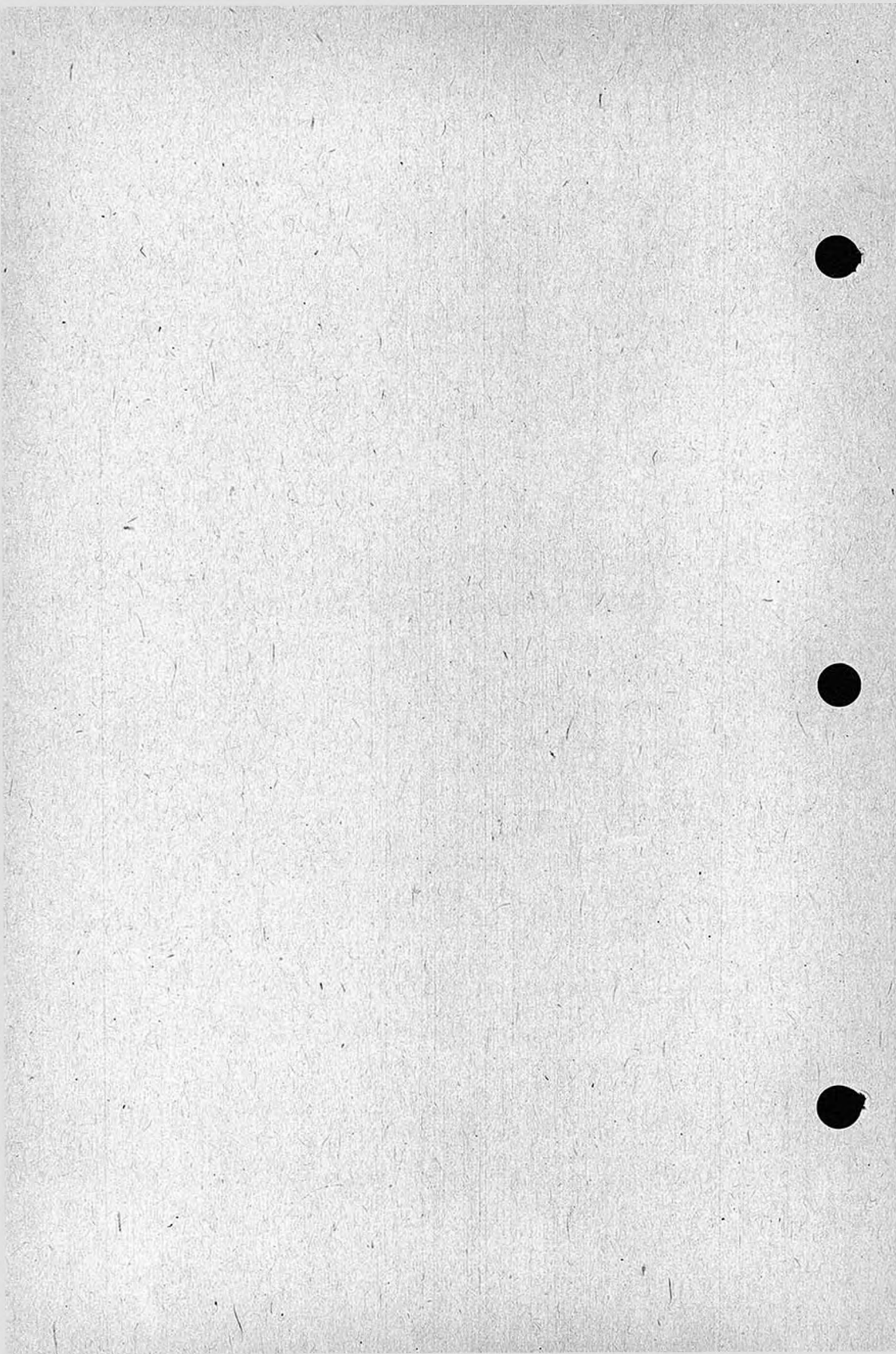

GERMAN BOOBY-TRAPPED TELLERMINES

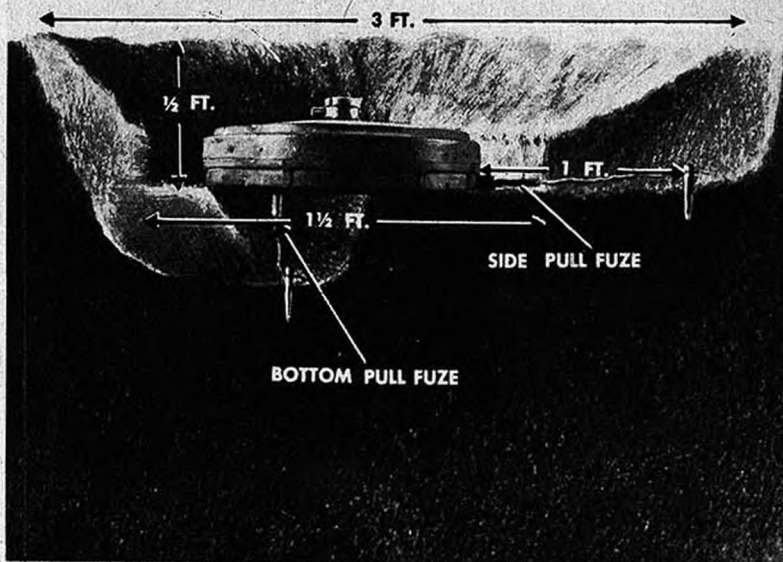

The Germans usually booby-trap mines to make removal of their mine fields and road blocks more hazardous and time-consuming. The number booby-trapped depends upon the time spent in laying the field, and on its importance. For this purpose the Tellermines have two secondary fuze wells, one in the side and the other in the bottom. (See sections 81.01-81.04, Tellermines.) Any of the standard pull fuzes, with detonator attached, fits into these wells.

DISARMING AND DEFUZING

To disarm and defuze a booby-trapped mine, cautiously uncover top of mine and disarm main fuze. Then remove mine by attaching a 50-yard rope or wire and pulling it from the hole. IF A SILENT LIFT IS REQUIRED—

1. Cautiously uncover top of mine and disarm main fuze.
2. Gradually scoop earth away from sides of mine until secondary fuze on side is found.
3. Disarm side fuze.
4. Commence about 6 inches from edge of mine and dig beneath it, locating bottom fuze.
5. Disarm bottom fuze.
6. Cut both trip wires, remove mine from hole.
7. Remove fuzes from mine.

GERMAN BOOBY-TRAPPED TELLERMINES

INSTALLING AND ARMING

1. Dig a hole $\frac{1}{2}$ -foot deep, $1\frac{1}{2}$ feet in diameter at bottom and 3 feet at the top.
2. Dig two trenches into hole, each about one hand wide. Make one trench $\frac{1}{2}$ -foot deeper than mine hole and extending to its middle, the other same depth as mine hole and extending about 1 foot from side.
3. Drive stake at end of each trench.
4. Attach standard German detonators, or wedge U. S. non-electric caps into bases of two pull fuzes.
5. Insert pull fuzes in wells in Tellermine.
6. Attach short length of trip wire to trip-wire slots and safety pins on fuzes.
7. Place mine in hole, attach loose ends of trip wires to stakes, arrange safety-pin wires for easy removal.
8. Fill bottom hole, remove safety pin from bottom fuze.
9. Fill around sides of mine, remove safety pin from side fuze.
10. Arm main fuze.
11. Cover mine.

SPACE FOR NOTES

GERMAN BOOBY-TRAPPED GRENADES

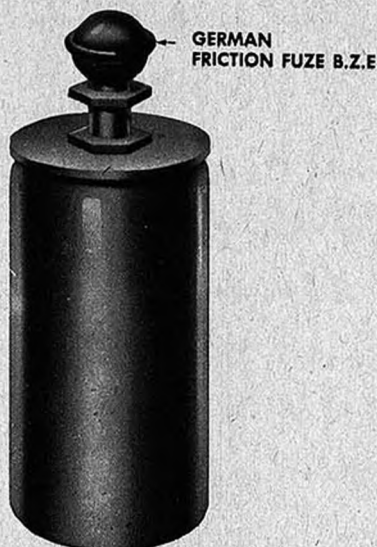

German grenades employ a friction fuze with a $4\frac{1}{2}$ -second delay pellet so the grenade reaches the target before exploding. Friendly troops using captured grenades sometimes find they explode immediately upon pulling the friction wire. This means grenades have been booby-trapped by removing the delay pellet. Before using captured grenades, examine as follows:

1. Remove fuze from one grenade, examine pellet, jerk pull wire, and time its delay before firing.
2. Remove all fuzes. Pellet, located in tube between fuze and base, should be solid and dry. A pin hole through it will make it burn much more rapidly.
3. If pellets are same as one tested, reassemble grenades and mark them with delay period.

GERMAN BOOBY-TRAPPED GRENADES

This booby-trapping is most easily done with grenades employing friction fuze B. Z. E. with delay pellet. Friction fuze Zdschn. Anz. 39, having the same general appearance but no delay pellet is substituted. It may be identified either by color or by the fact that its removable head has left hand thread rather than right hand thread as in friction fuze B. Z. E.

SPACE FOR NOTES

GERMAN PUSH-FUZE TRAPS

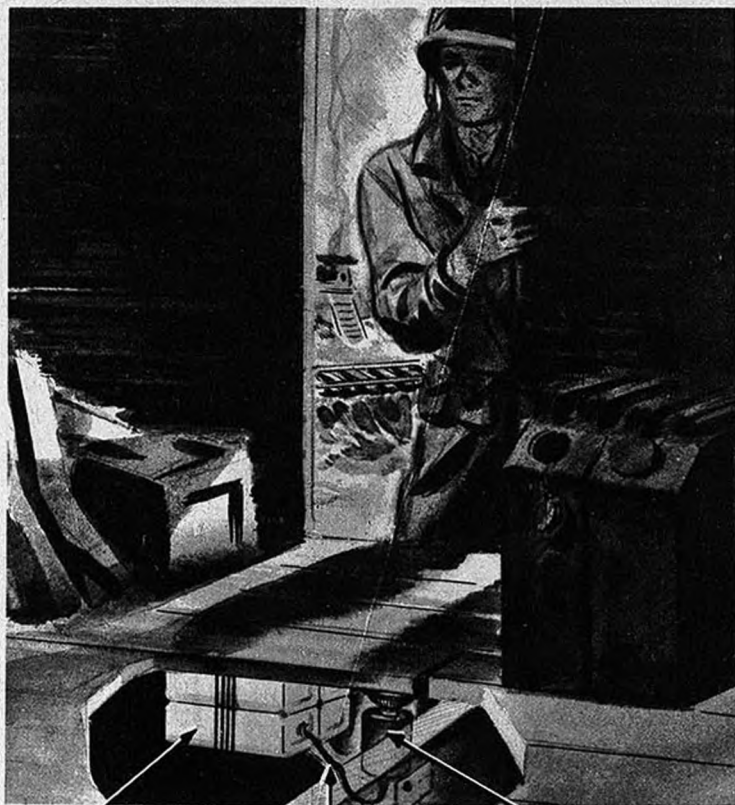

CHARGE

DETONATING CORD

PRESSURE FUZE

Germans leave booby traps for the unwary to tread on, particularly in populated places but also in the fields. The fuze may be either D. Z. 35, S. Mi. Z. 35, or Es. Mi. Z. 40. The charge may be an "S" mine, a grenade, one or more slabs of tolite, a Tellermine, or a shell or bomb. To find and disarm these traps—

1. Examine carefully for pressure firing devices all loose floor boards, trench boards, areas just in front of wheels of abandoned vehicles, any recently disturbed patches of ground, and similar suitable locations.
2. Identify fuze and disarm.
3. Remove fuze and detonator from charge, and charge from its locations.

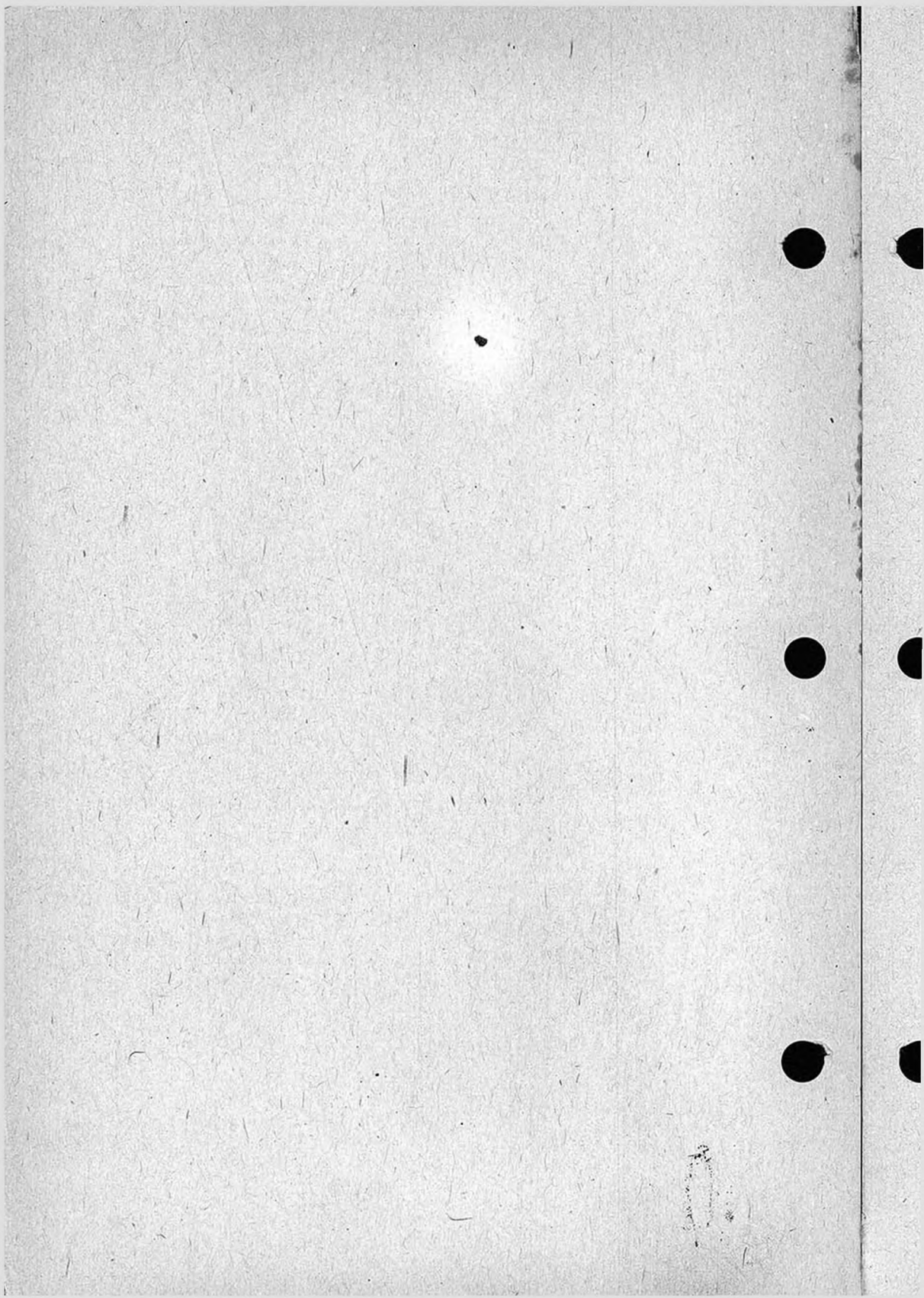

GERMAN PULL-FUZE TRAPS

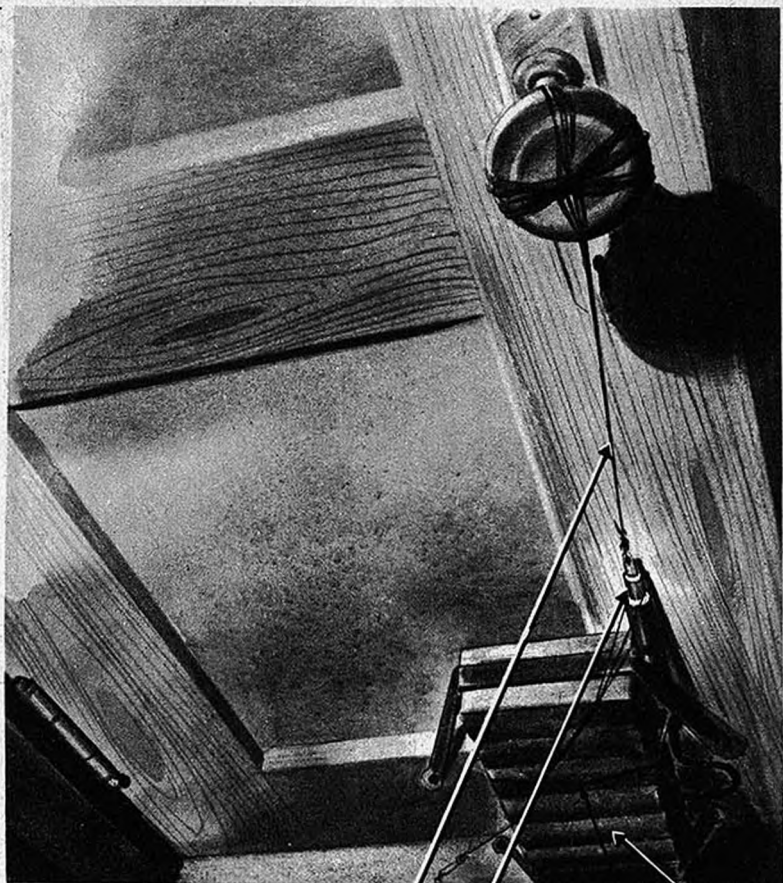

TRIP WIRE (PULLED WHEN KNOB IS TURNED) PULL FUZE Z. Z. 35 CHARGE

German fuzes Z. Z. 35, Z. U. Z. Z. 35, and the various friction fuzes, are commonly used in booby traps. The above illustration of a booby-trapped door is a simple example. The charge employed usually consists of two to eight slabs of Tolyte, two to eight cylindrical cartridges, an "S" mine, Tellermine, or one or more grenades. To discover these traps and disarm them—

1. Never disturb any movable object without first searching for attached trip wires.
2. Follow all trip wires to their source.
3. Identify fuze and disarm.
4. Remove fuze and detonator from charge, and charge from its location.

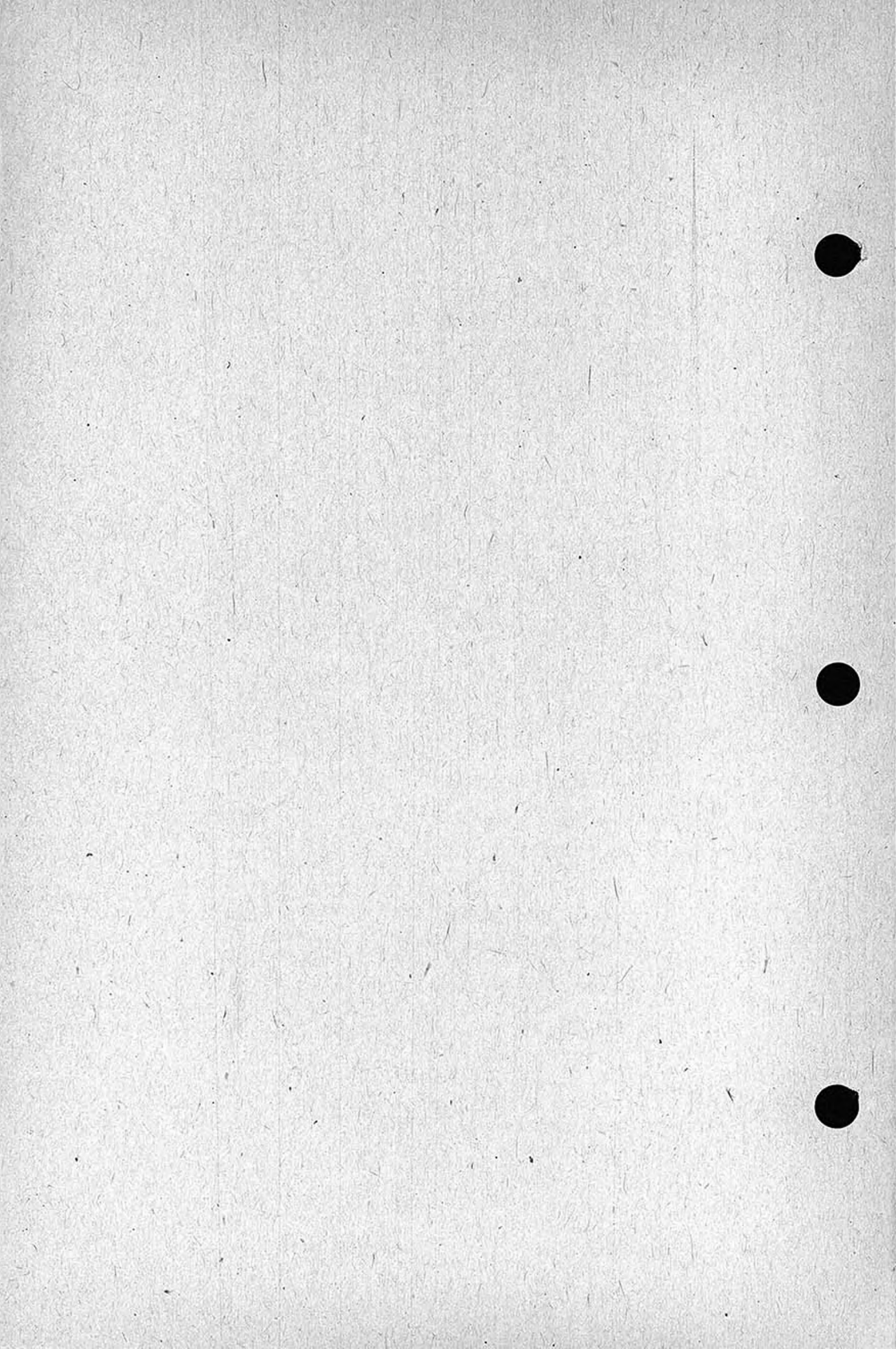

GERMAN TIME-DELAY FUZE TRAPS



GERMAN LONG DELAY FUZE

LARGE CHARGE

A favorite German trick is to leave large charges of explosive—as much as 2,000 pounds—in abandoned buildings. Basements are favorite locations, though stoves, furnaces, chimneys, attics, and cupboards have been used. Clockwork fuzes are used, set for delays from several hours to many days. To find and disarm this type of booby trap—

1. Systematically search all buildings, particularly prominent ones, since Germans booby-trap them on theory they will be used for higher headquarters. Look in all nooks and crannies, examine all piles of rubble, being careful of other types of booby traps.

2. If found, either rope off building and area as unsafe, or find and disarm fuzes and remove charges carefully, piece by piece.

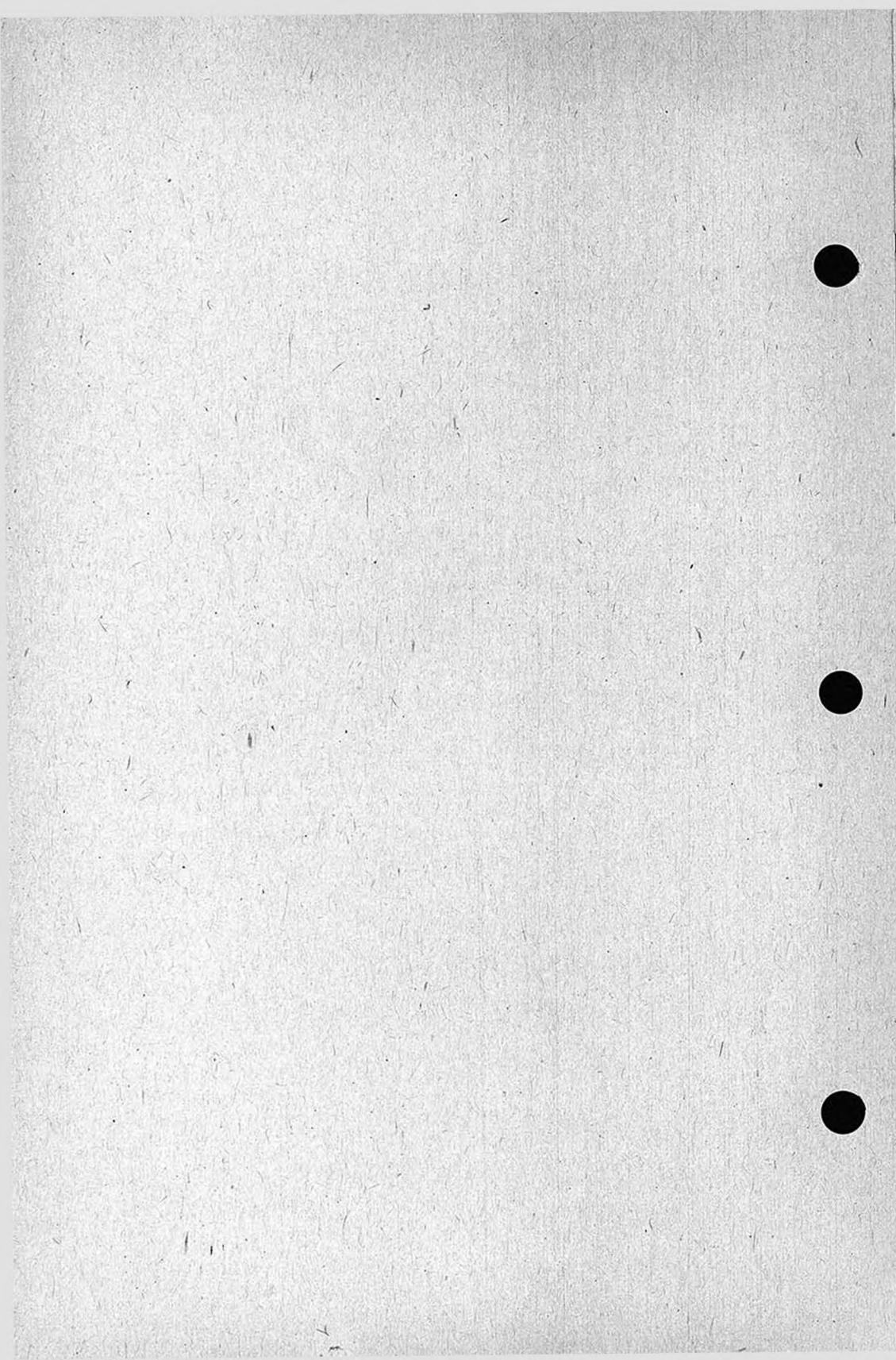

CHAPTER 9

HUNGARIAN

MINE TACTICS, MINES,
AND FUZES

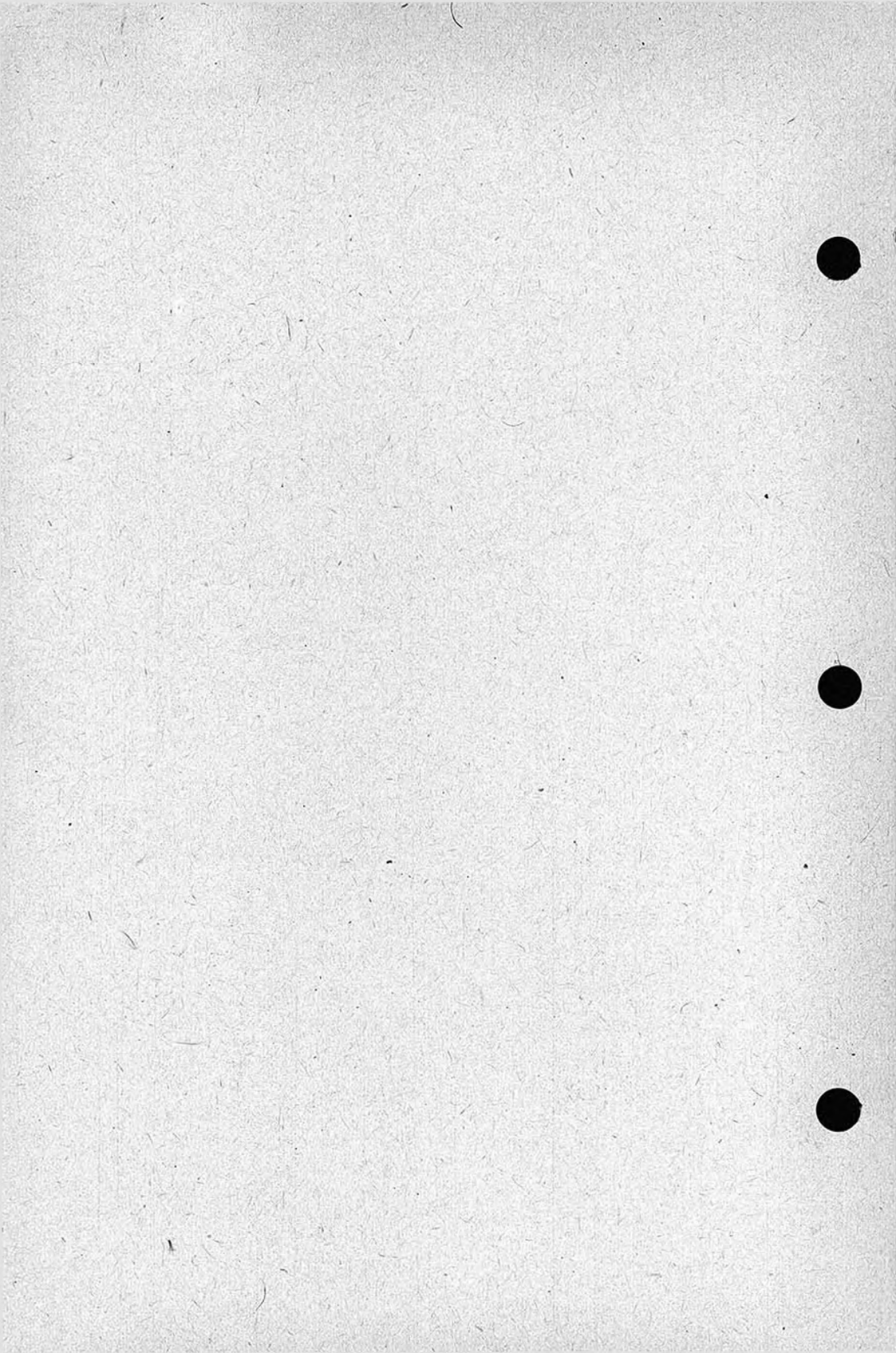

HUNGARIAN VARIABLE PRESSURE MINE C.V.P.

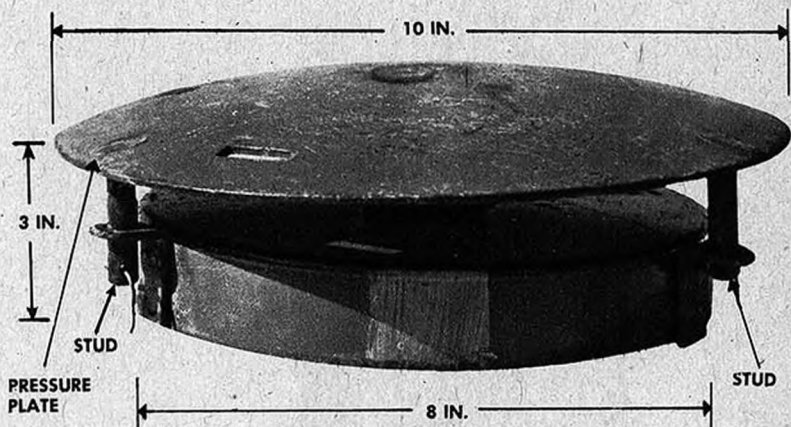

TYPE. Antitank mine; adjustable for use against personnel by either pressure or trip wire.

COLOR. Olive-drab or black

CASE. Steel

WEIGHT. 8 pounds

EXPLOSIVE. 3½ pounds of TNT

EFFECT. Breaks tank tracks. Effective up to 25 yards

PACKING AND TRANSPORTING

As issued, wooden plug with threaded aluminum cap is in fuze well. Plate is held in place above this by placing split pins in upper holes in studs. Six fuzes are carried in separate, circular, steel carrying case. Six mines and one case of fuzes are strapped together in a long cylinder by slots in mine lids. Total weight, about 55 pounds.

HUNGARIAN VARIABLE PRESSURE MINE C.V.P.

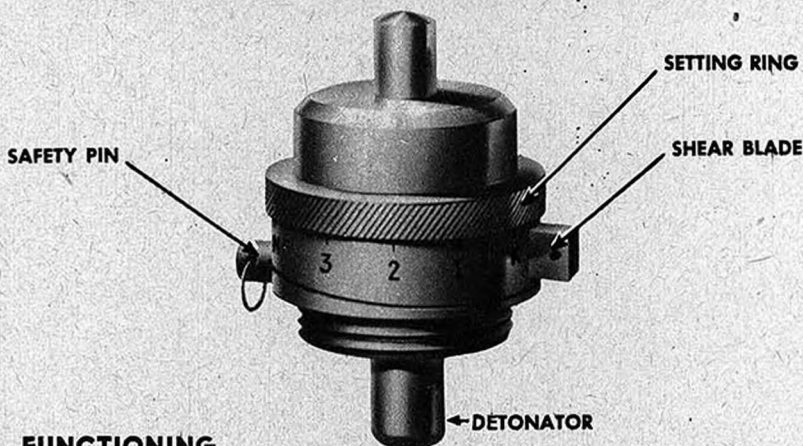
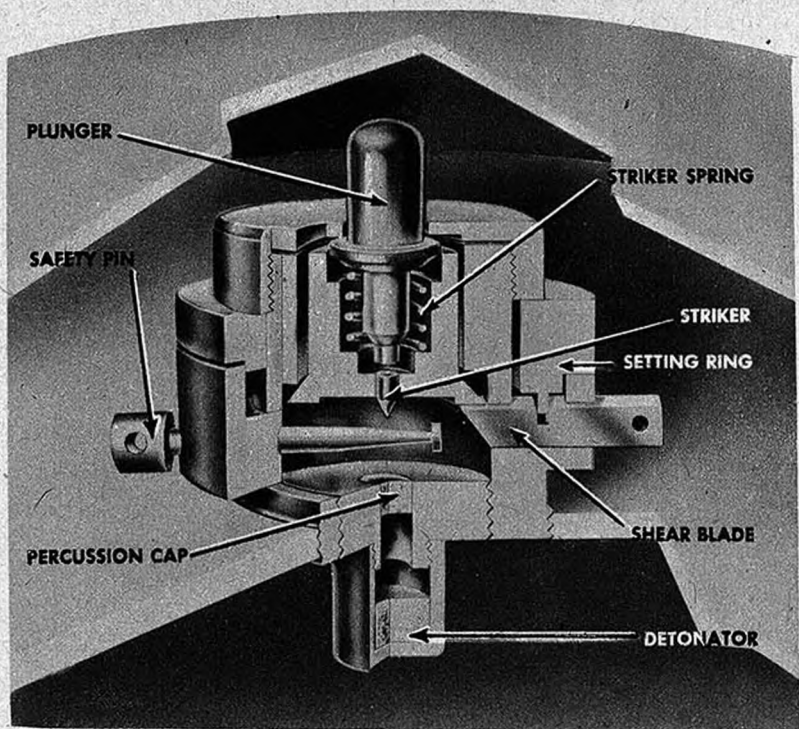

FUNCTIONING

1. Pressure on pressure plate depresses plunger, compressing striker spring and striker.
2. Striker is forced downward against resistance of shear blade which cuts through triangular brass flange on side of striker.
3. Released striker, driven by striker spring, sets off percussion cap—detonator—booster—main charge.

HUNGARIAN VARIABLE PRESSURE MINE C.V.P.

FUNCTIONING OF SETTING RING

Operating pressure for this mine is varied by rotating the setting ring. Eccentric segment on base of ring projects into slot in shear blade and moves it in or out as ring is revolved. This varies amount and thickness of triangular flange on striker through which blade must cut; hence varies operating pressure of mine. Red setting mark on ring, and scale on igniter body, indicate settings as follows:

SCALE SETTING

K
1
2
3
N
H

OPERATING PRESSURE

(Pounds)

77

220

440

660

770

When set at "H" mine can be fired by pulling on trip wire attached to shear blade.

DISARMING



1. Cut trip wires, if any, without exerting pressure on shear blade; remove pins from studs; remove pressure plate.

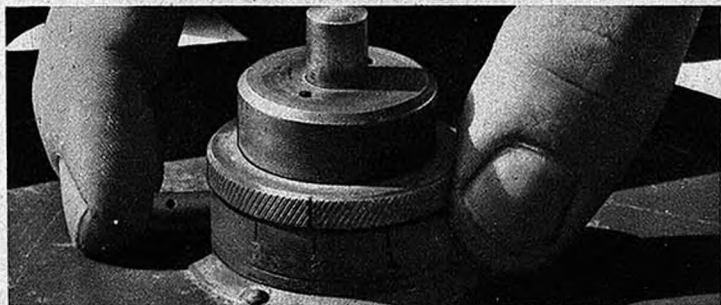

2. Insert heavy piece of wire or 16-penny nail into safety-bolt hole.

HUNGARIAN VARIABLE PRESSURE MINE C.V.P.

DEFUZING



1. If setting ring is at "H," press in shear blade.
2. Unscrew fuze.



3. Replace pressure cover, hold in place by pins or wire in upper holes in studs.

INSTALLING AND ARMING

1. Set ring for desired pressure.
2. Place fuze in mine, set mine in hole.
3. Attach trip wire, if ring setting "H" is used.
4. Place cover on mine, pins in lower stud holes.
5. Cover, camouflage.
6. Withdraw safety pin by attached string.

RE-USE

Check both fuze and fuze well for dampness or deterioration. Before inserting fuze in mine, check safety pin by pulling out. If it does not come easily, striker has fallen and its shoulder is engaging shoulder on safety. Discard fuze and use another.

HUNGARIAN RAMP MINE

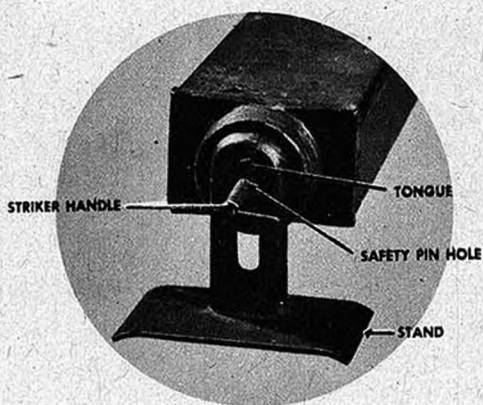
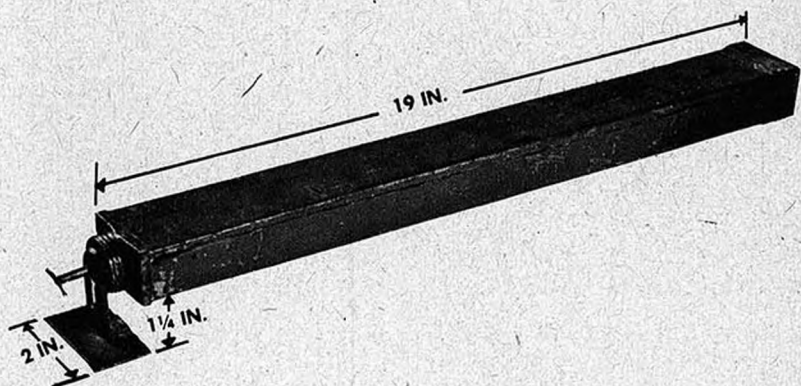

TYPE. Antipersonnel mine

COLOR. Green

CASE. Metal

WEIGHT. 5 pounds

EXPLOSIVE. 2 pounds TNT

EFFECT. Causes casualties to personnel up to 20 yards

FM 5-31

1 NOV 1943

92.01-a

RESTRICTED

HUNGARIAN RAMP MINE

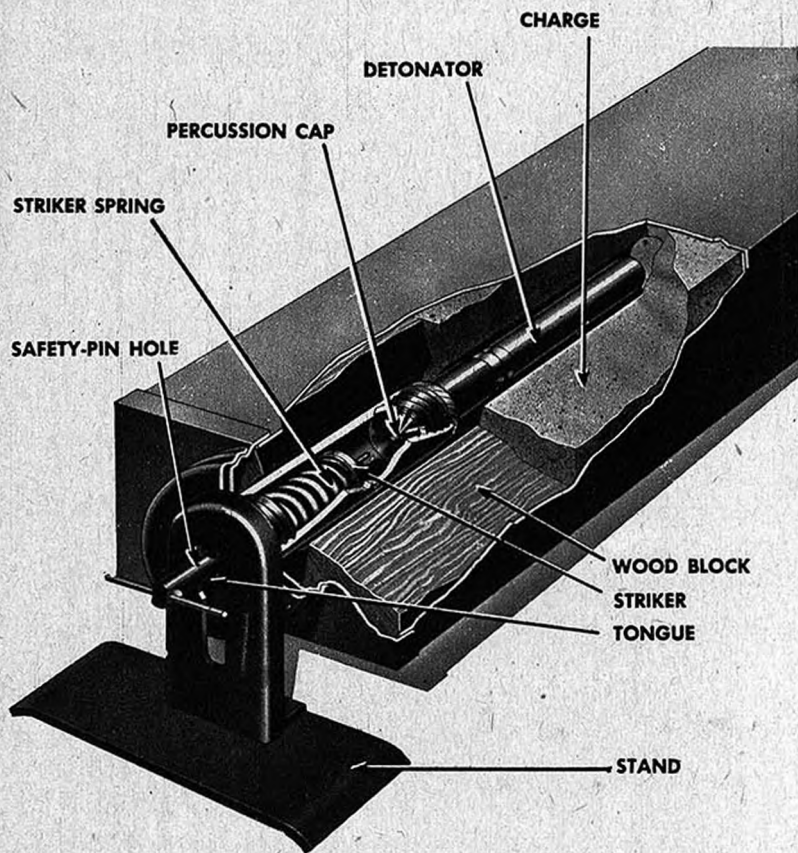

FUNCTIONING

With mine set for pressure firing, striker is held in cocked position by tongue of stand, which projects downward through hole in striker handle.

1. Pressure on mine cover presses whole mine downward, releasing striker.

2. Released striker, driven by striker spring, sets off percussion cap—detonator—booster—main charge.

With mine set for trip-wire firing, striker is held in cocked position by safety pin with trip wire attached. Stand is not used.

1. Pull on trip wire withdraws safety pin, releasing striker.

2. Released striker, driven by striker spring, sets off mine.

HUNGARIAN RAMP MINE

DISARMING

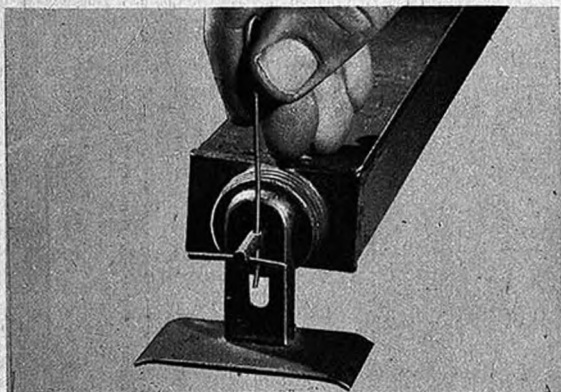

1. Insert safety pin in free hole of striker.



If mine is set with free safety hole on inside, hence not visible, grasp striker firmly and pull out until free hole is visible.

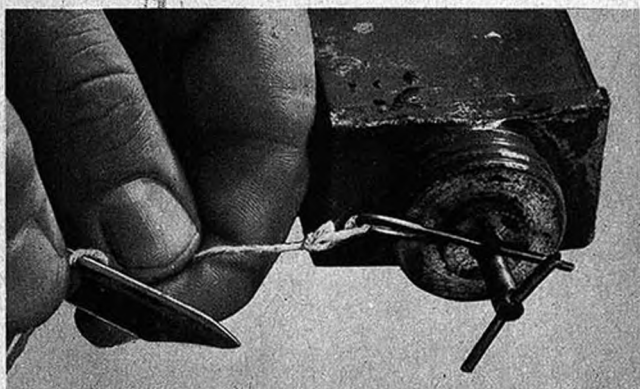

2. If mine is set for firing by trip wire, cut wire.

HUNGARIAN RAMP MINE

DEFUZING

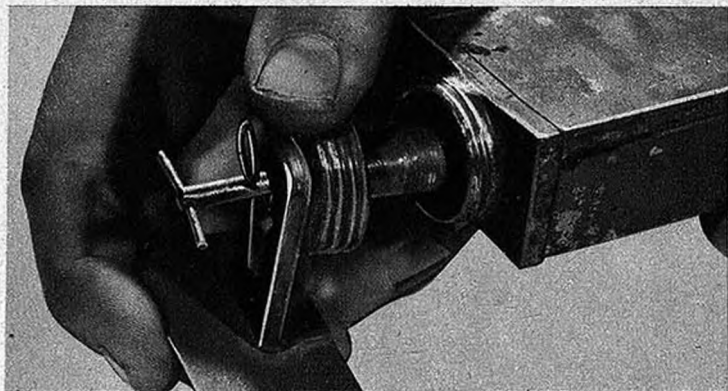

1. Unscrew and remove fuze and detonator.
2. Detach detonator from fuze.

INSTALLING AND ARMING

1. Attach detonator to fuze.
2. Cock striker and insert safety pin in either hole.
3. Insert tongue of stand in other hole.
4. Install fuze.
5. Place mine in position and attach trip wire to safety pin if trip wire is to be used.
6. Withdraw safety pin if stand is used.

PACKING AND TRANSPORTING

Transported with fuze separate.

SPACE FOR NOTES

ITALIAN

MINE TACTICS, MINES,

AND FUZES

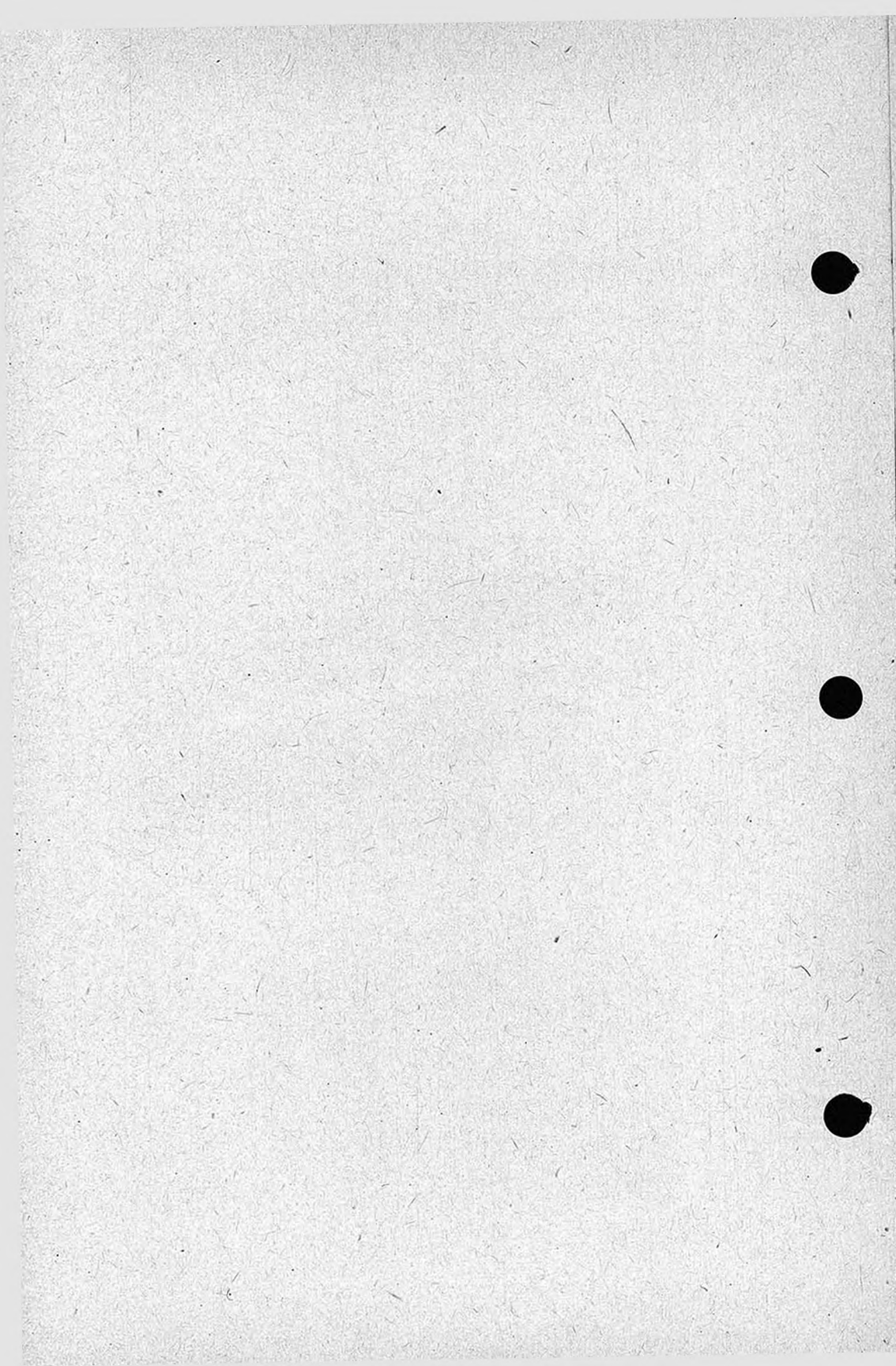

ITALIAN B-2 MINE

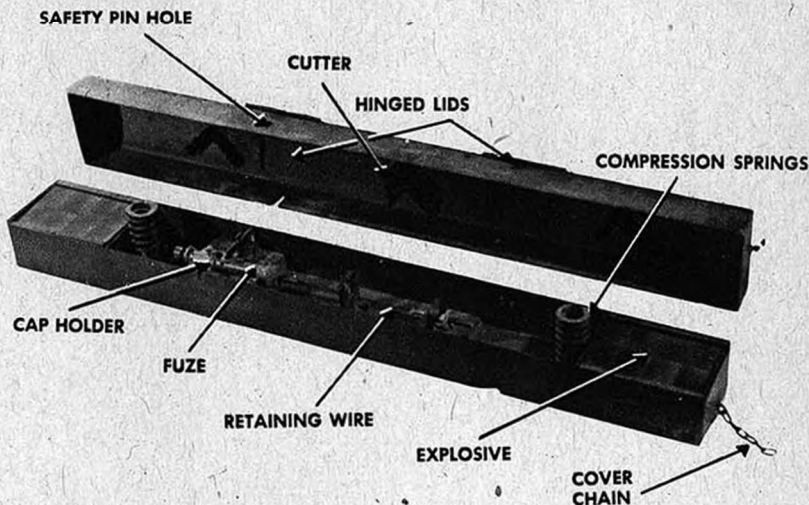
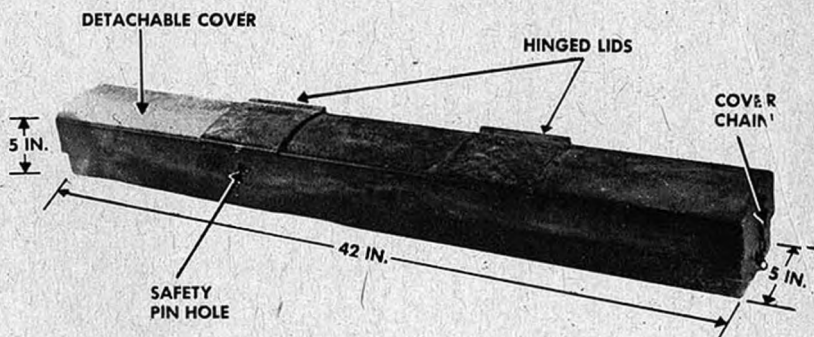

TYPE. Light antitank mine

COLOR. Black

CASE. Welded sheet steel

WEIGHT. 33 pounds

EXPLOSIVE. Two 4-pound charges, probably TNT

EFFECT. Disables tanks

FM 5-31

1 NOV 1943

101.01-a

RESTRICTED

ITALIAN B-2 MINE

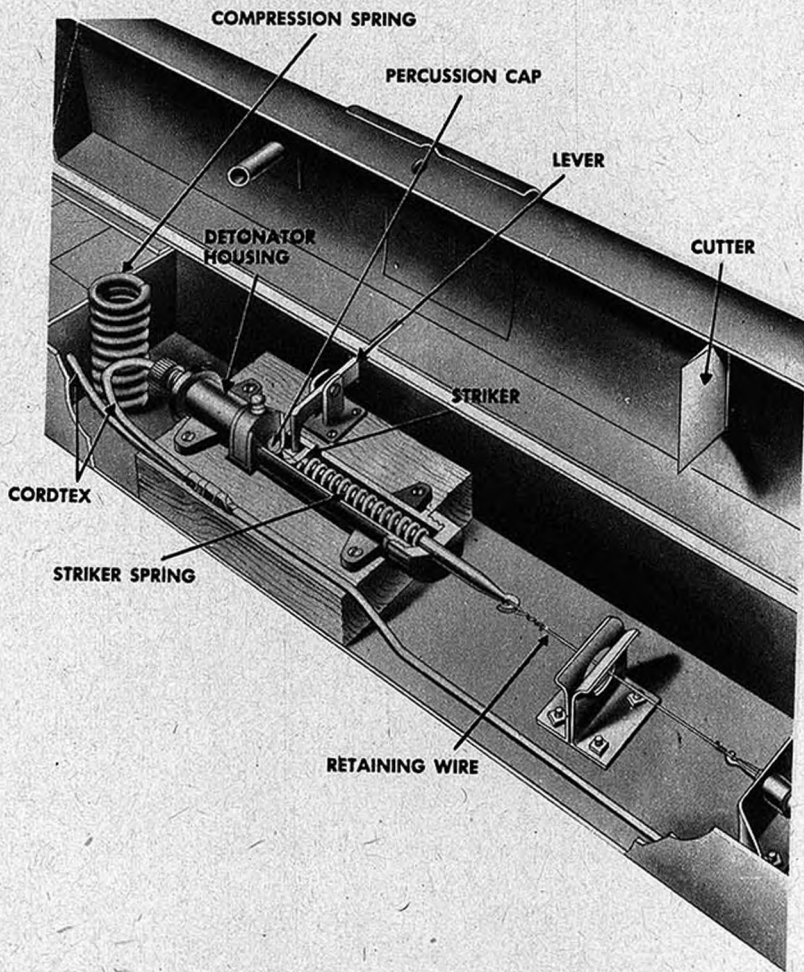

FUNCTIONING

1. Pressure of 300 pounds or more moves cover downward against compression of springs.
2. Edge of cover moves end of lever enough to free its hold in striker. At same time cutter shears wire, releasing striker.
3. Striker spring forces striker against percussion cap.
4. Flame from cap ignites detonator which sets off two cordtex fuzes—charges.

ITALIAN B-2 MINE

DISARMING

1. Uncover mine, feeling for trip wires. Attach 50-yard rope or wire to both lids and pull open from cover position.



2. Insert strong wire through safety pin hole in side of cover, case, and fuze housing.

DEFUZING

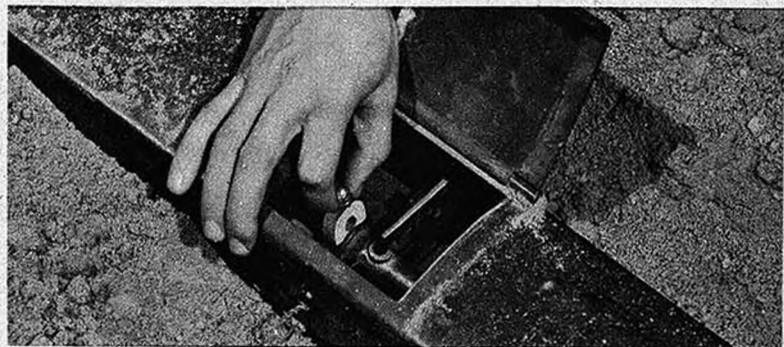

1. Remove cap holder and cap.

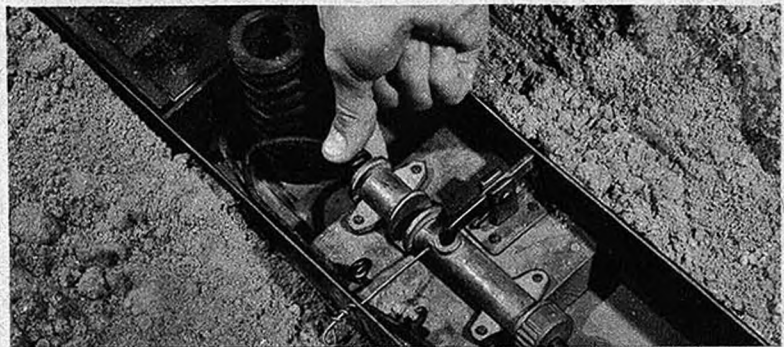

2. Withdraw safety pin and lift off cover.
3. Unscrew and remove detonator.
4. Release tension on striker spring by turning screw head.

ITALIAN B-2 MINE

INSTALLING AND ARMING

1. Open hinged lids of cover, and cock striker spring by turning knurled thumb screw until safety lever falls.
2. Insert detonators and attach cordtex.
3. Insert safety pin in hole through side of box.
4. Insert cap in removable holder and place in slot opposite detonator.
5. Close the lids, cover mine with earth, and from safe distance withdraw safety pin.

PACKING AND TRANSPORTING

Mine always is defuzed completely before packing or transporting.

RE-USE

Examine mines for evidence of deterioration, or damage caused by blast or handling.

SPACE FOR NOTES

ITALIAN FOUR-FUZE MINE



TYPE. Antitank mine

COLOR. Camouflage-painted

CASE. Wooden box

WEIGHT. 14 $\frac{1}{4}$ pounds

EXPLOSIVE. 11 pounds of TNT

ITALIAN FOUR-FUZE MINE

FUNCTIONING

When armed with friction fuze

1. Pressure of 100 to 360 pounds on cover crushes one or more fuzes.
2. Flash from friction compound in crushed fuze explodes detonator.
3. Detonator explodes mine.

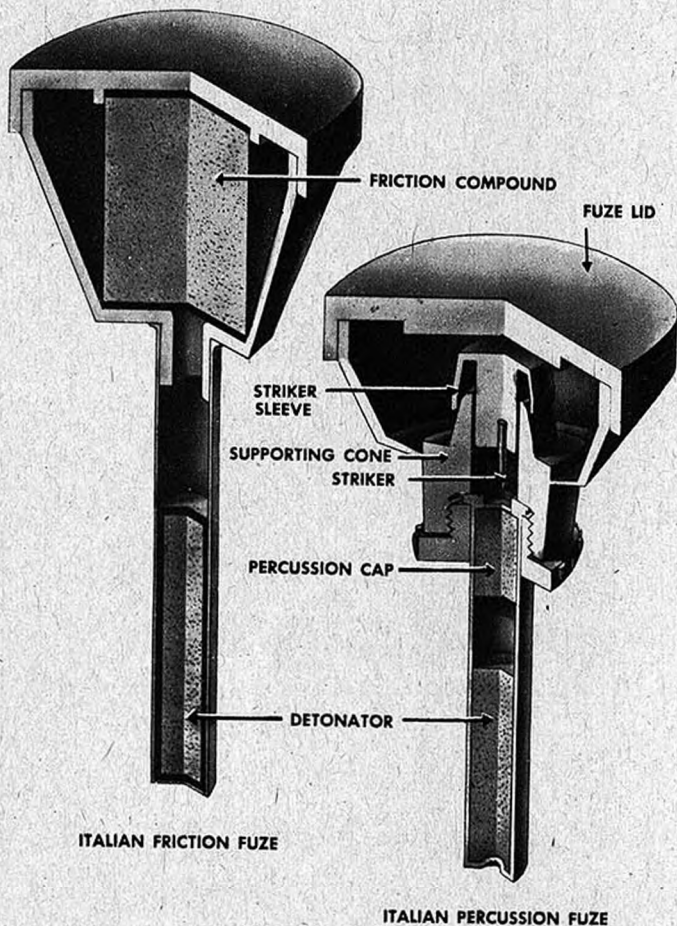

When armed with percussion fuze

1. Load on cover forces fuze lid downward.
2. Fuze lid crushes bakelite supporting cones and forces strikers down.
3. Uprturned cone at base of striker breaks apart bakelite striker sleeve, permitting striker to continue downward.
4. Striker fires percussion cap.
5. Flame from cap explodes detonator—main charge.

ITALIAN FOUR-FUZE MINE

DISARMING

Avoid applying pressure on false pressure lid. If mine appears deteriorated, or has been disturbed by blast or artillery fire, destroy by hand-placed charges.

DEFUZING

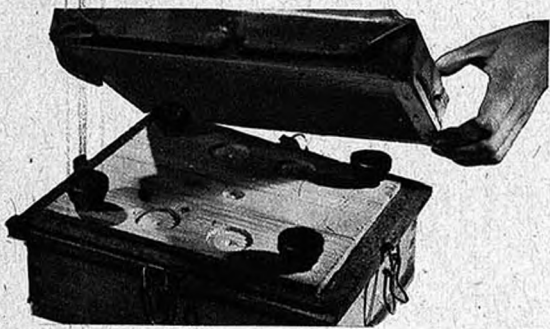

1. Open clips and remove cover.



2. Remove fuzes and detonators.



3. Detach detonators from percussion type fuzes. Detonators are not detachable from friction type.
4. Plug arming holes and prepare mine for transport.

ITALIAN FOUR-FUZE MINE

INSTALLING AND ARMING

1. Remove cover.
2. Remove detonators and fuzes from storage recesses.
3. Fasten detonators to fuzes and insert into corner holes.
4. Replace cover and fasten clips.
5. Place mine in hole, with cover 2 to 3 inches below ground surface.
6. Cover with earth, and camouflage.

PACKING AND TRANSPORTING

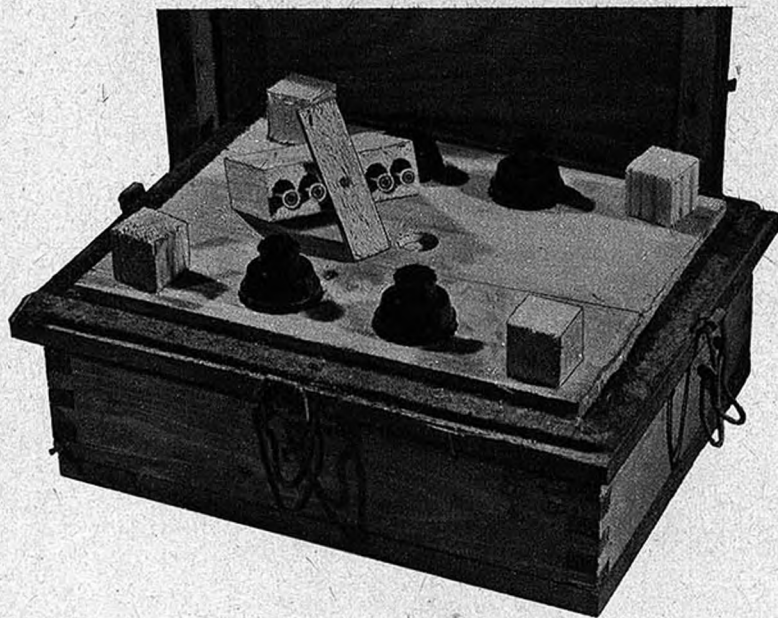

Before transporting, each mine is packed as follows:

1. Insert wooden spacer cubes with pins in four fuze holes.
2. Place fuzes upside down in circular recesses in lid piece.
3. Store detonators in wooden block. Lug on block fits into another circular recess in lid piece.

RE-USE

Make sure dowel pins in cover are not partially sheared. Inspect fuzes for cracks.

NOTE

Mine was designed to avoid detection by mine detectors. However American detector detects mine at 6 inches.

ITALIAN WOODEN-BOX MINE

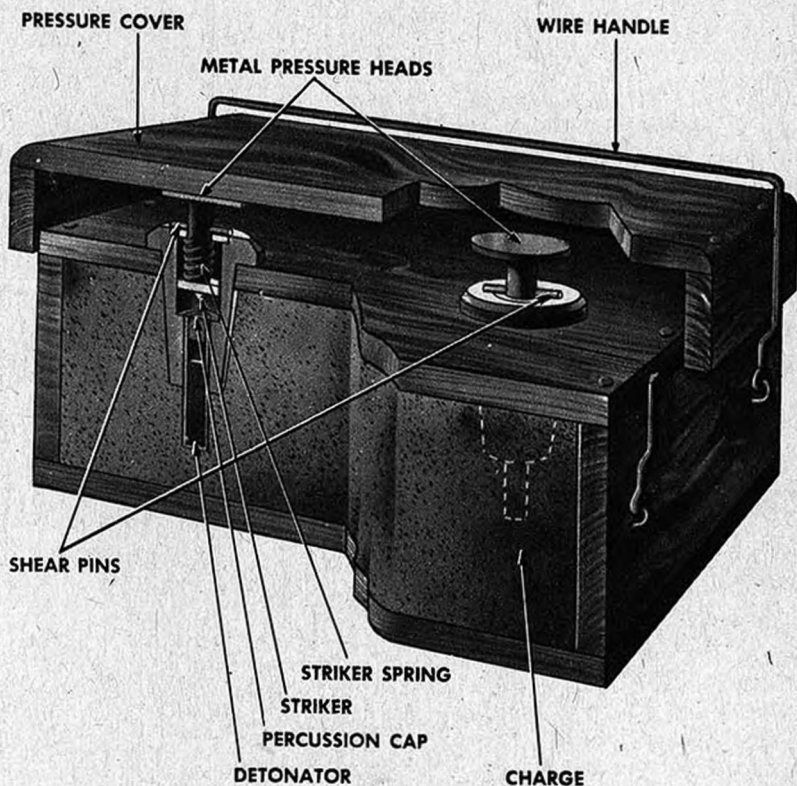

TYPE. Antitank mine

CASE. Wooden box

EXPLOSIVE. 5½ pounds gelignite

FUNCTIONING

1. Pressure of 185 to 380 pounds on cover shears copper shear pins.
2. Springs drive strikers onto percussion caps.
3. Caps explode detonators—main charge.

ITALIAN WOODEN-BOX MINE

DISARMING

Inspect for booby traps before moving.

DEFUZING

1. Remove cover.
2. Lift out fuzes.
3. Remove detonators.

INSTALLING AND ARMING

1. Remove cover.
2. Insert detonators in holes in mine lid.
3. Place fuzes in detonators.
4. Replace cover and fasten with wire handles.
5. Bury and camouflage.

RE-USE

Make sure shear pins are not partially sheared.

SPACE FOR NOTES

ITALIAN PICKET MINE

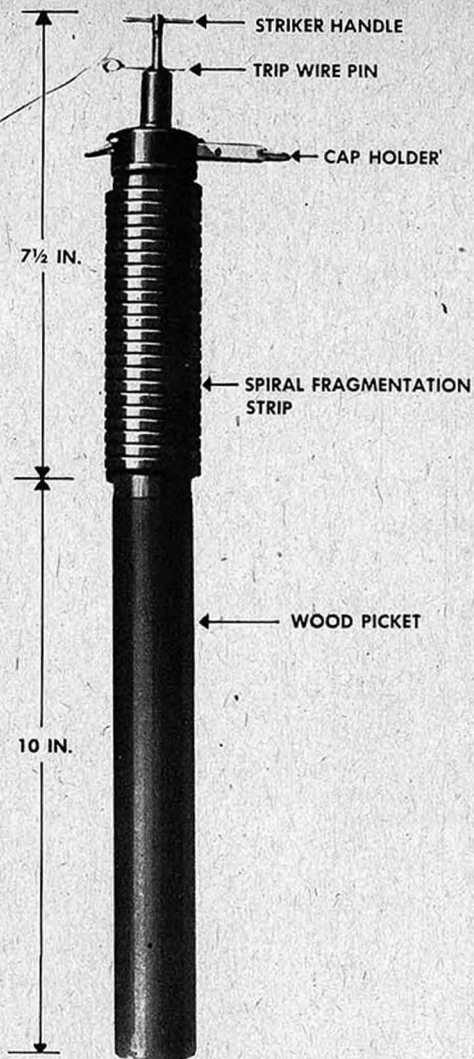

TYPE. Antipersonnel mine and booby trap

COLOR. Gray

CASE. Sheet metal surrounded by steel spiral

WEIGHT. 13 $\frac{1}{4}$ pounds

EXPLOSIVE. 3 $\frac{1}{2}$ -ounce borehole charge

EFFECT. Effective fragmentation within radius of 10 yards; dangerous at greater distances.

EMPLOYMENT. As antipersonnel mine in forward areas.

ITALIAN PICKET MINE

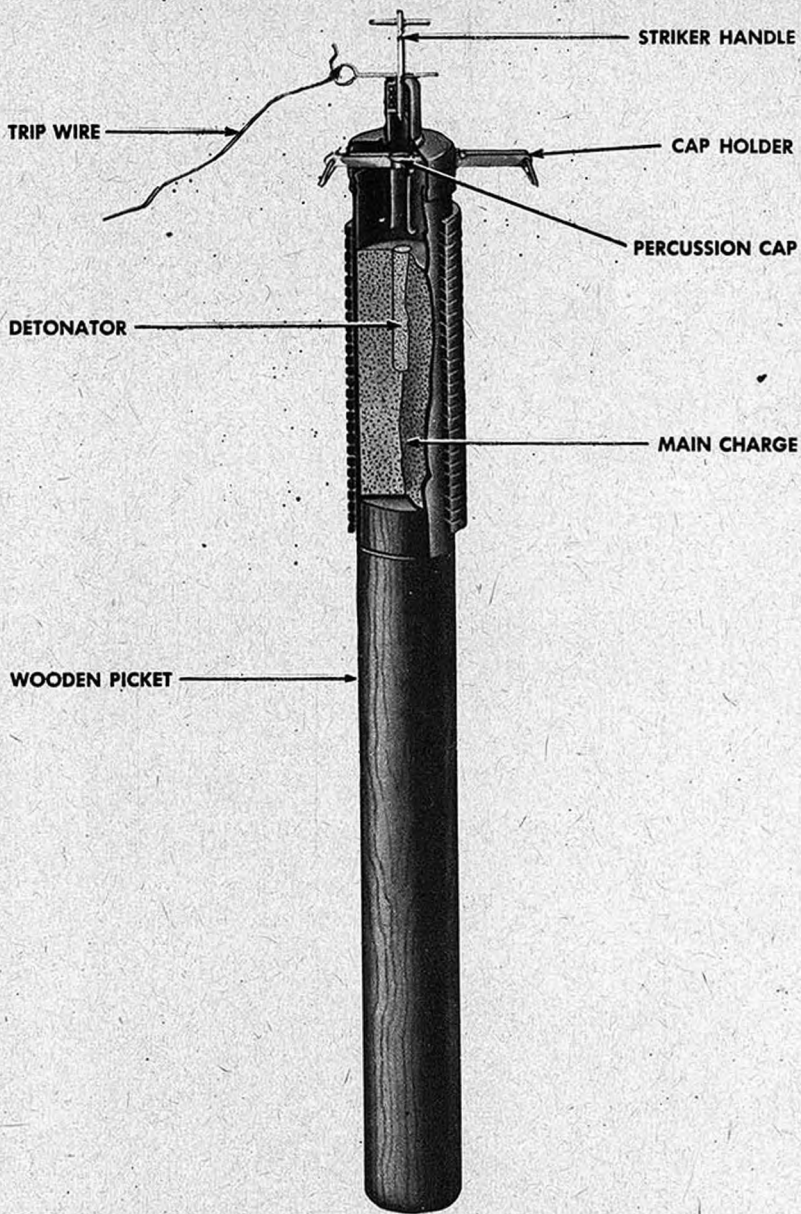

FUNCTIONING

Trip-wire pin holds striker in cocked position.

1. Pull on trip-wire pin releases striker.
2. Striker driven by striker spring sets off cap—detonator—main charge.

ITALIAN PICKET MINE

DISARMING

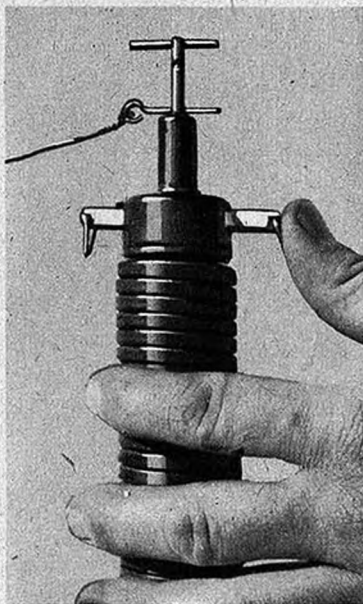

1. Avoid all trip wires and slide cap holder to safety position.

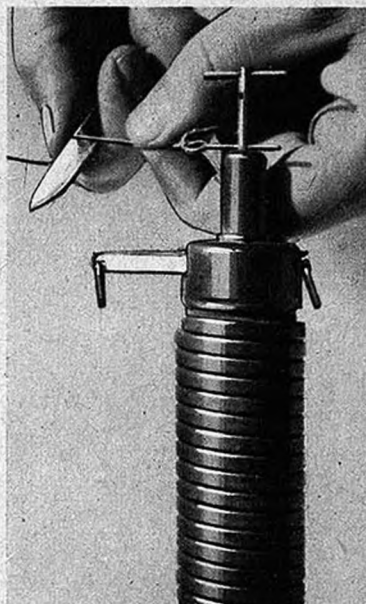

2. Cut trip wires.

3. Remove pin and lower striker gently. Notch in cap holder engages end of striker when holder is in safe position.

4. Replace pin in upper hole.

DEFUZING

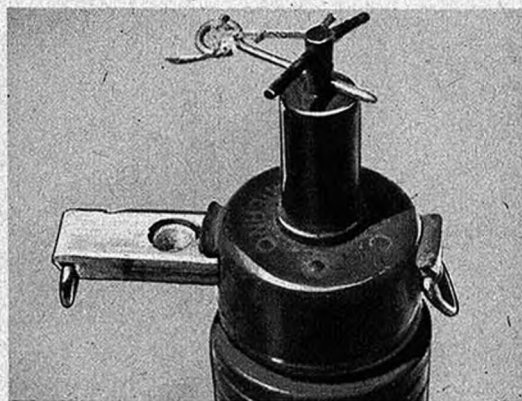

1. Remove percussion cap from holder.

2. Unscrew striker group and remove detonator.

ITALIAN PICKET MINE

INSTALLING AND ARMING

1. Drive metal-covered picket in ground to form hole for mine. Remove.
2. Place mine upright in hole, with $7\frac{1}{2}$ inches extending above ground.
3. Insert detonator and screw on striker group.
4. Lay trip wire and anchor other end.
5. Raise striker and insert pin in bottom hole.
6. Attach trip wire to pin.
7. Camouflage
8. Place cap in cap holder, and push to armed position.

PACKING AND TRANSPORTING

Wooden box contains 20 mines, one mallet, and one metal-covered wooden picket 15 inches long and $1\frac{1}{2}$ inches in diameter.

NOTE

It is possible to arm this mine by inserting the safety pin in the top hole. Disarm by pulling up on striker and sliding cap holder to safe position.

SPACE FOR NOTES

ITALIAN B4 MINE

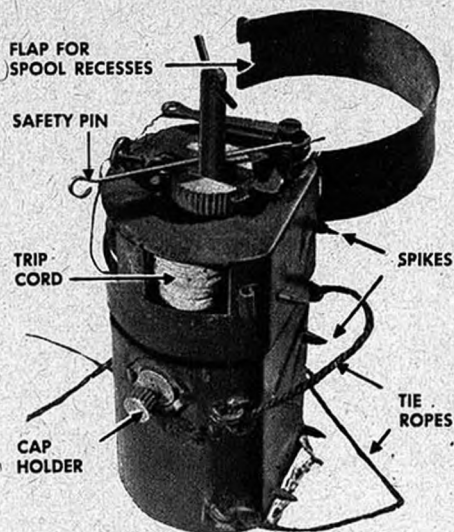

TYPE. Antipersonnel mine

COLOR. Black

CASE. Sheet metal

WEIGHT. 2¼ pounds

EXPLOSIVE. ¼-pound powdered TNT

EFFECT. Causes casualties within radius of 10 to 15 yards.

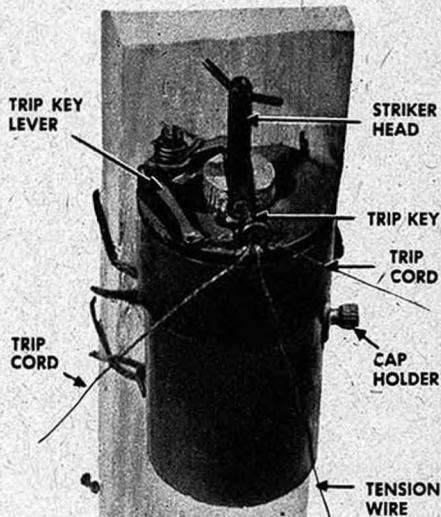

ITALIAN B4 MINE

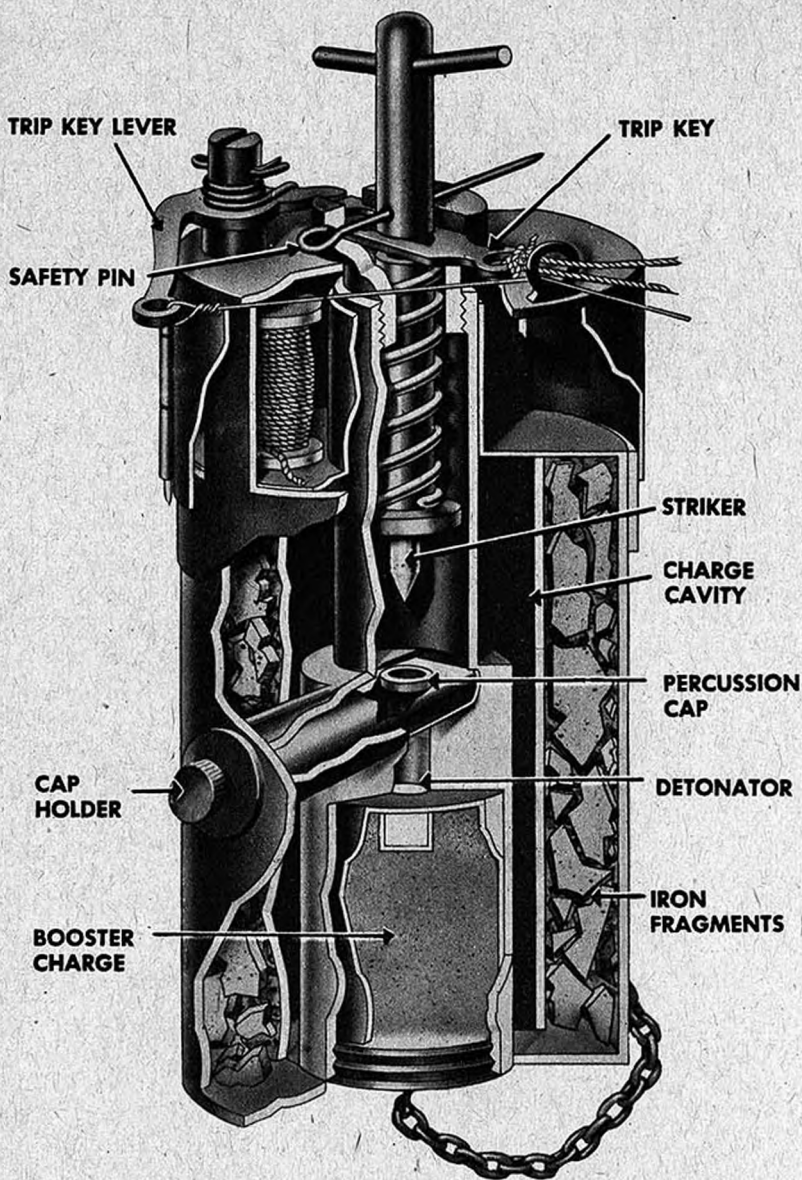

FUNCTIONING

1. When tension wire is released, or either of two trip cords is pulled, keyhole slot in trip key disengages striker.
2. Striker, driven by striker spring, sets off percussion cap—detonator—booster—main charge.

DISARMING

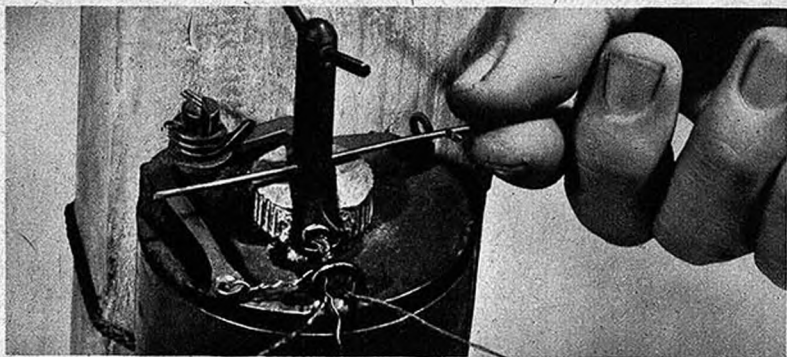

Do not cut cords or wires. Insert nail or stout wire in safety-pin hole in striker.

DEFUZING

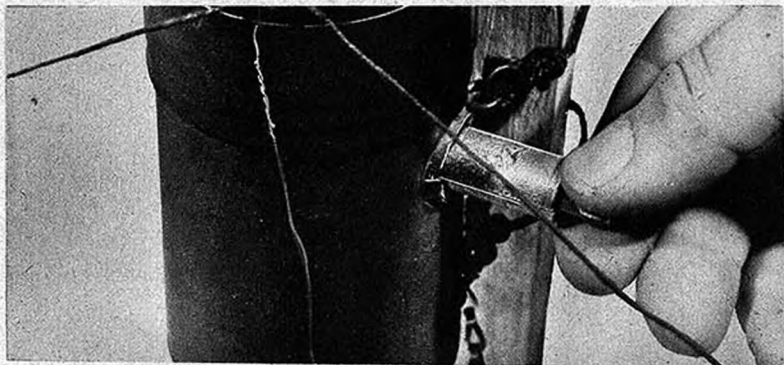

1. Pull percussion-cap holder straight out of side of mine.

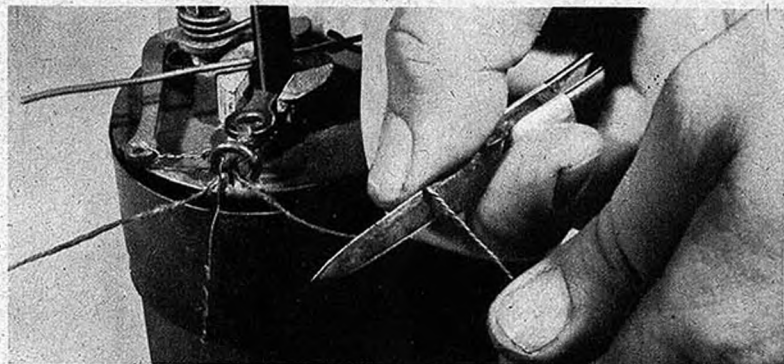

2. Cut cords and wire.

ITALIAN B4 MINE

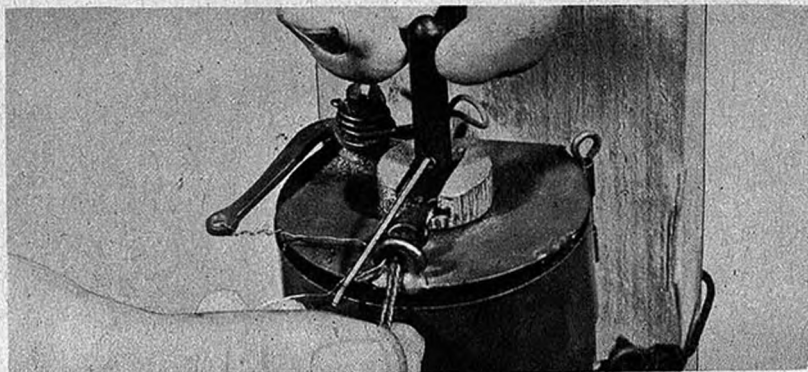

3. Disengage key from striker.

EMPLOYMENT

In antitank mine fields, laid in irregular line in front of field. In wire obstacles, spaced about 5 yards apart. In antipersonnel mine fields, laid 7 to 10 yards apart in combination with a few German "S" mines. As booby traps.

INSTALLING AND ARMING

1. Anchor far ends of cords and wire to wooden pegs, bushes, or the like.
2. Attach other ends of pull cords to trip key, and other end of tension wire to lever, passing all three through guide ring. Leave pull cords loose, tighten tension wire until there is a $\frac{1}{4}$ -inch gap between trip key and nose of lever.
3. Insert safety pin and engage trip key with striker.
4. Insert cap and cap holder in side of mine. Make sure holder is turned so cap is directly below point of striker.
5. From safe distance, withdraw safety pin by a long cord.

PACKING AND TRANSPORTING

Mines are shipped in wooden packing boxes $22 \times 25\frac{1}{2} \times 5$ inches. Each box holds three rows of seven mines, on their sides. Mines are shipped complete except for percussion caps.

RE-USE

1. Remove base screw plug and make sure booster charge has not leaked out.
2. Make sure percussion cap is fitted to cap holder.

NOTES

1. Spools of cord and wire are stored in recesses in top section of mine.
2. Pin from flap can be used as a safety pin.

ITALIAN THERMOS BOMB

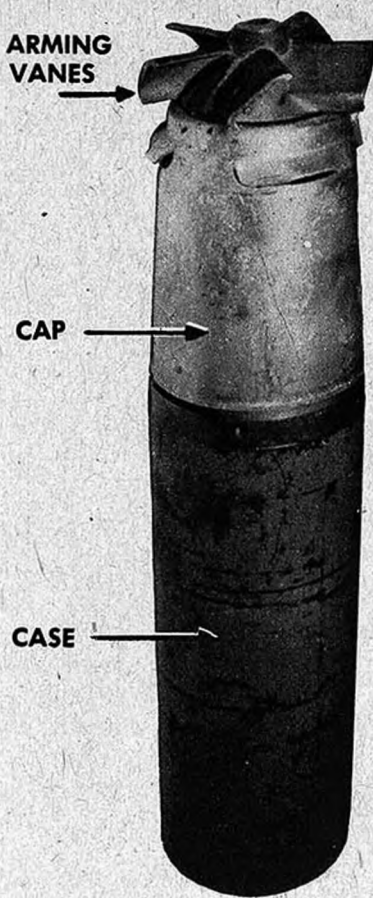

UNARMED BOMB



ARMED BOMB

TYPE. Antipersonnel bomb

COLOR. Buff or green

CASE. Metal cylinder resembling thermos bottle

WEIGHT. 8½ pounds

EXPLOSIVE. 1⅓ pounds TNT

EFFECT. Causes casualties to personnel up to 150 yards

EMPLOYMENT. Dropped from planes in large numbers; design indicates use as antipersonnel mine.

ITALIAN THERMOS BOMB

FUNCTIONING

1. As bomb falls, vanes rotate, unscrewing aluminum nut holding cap on.
2. Cap is pulled off by projecting tabs.
3. Removal of cap releases six clips which partially arm bomb.
4. When bomb lands, it is fully armed by internal action in a few seconds.
5. Bomb now will explode if moved.

DISARMING

Do not try to disarm it; destroy it.

1. Explodes by small-arms fire from safe distance, or by small charge next to it.
2. Coil rope on ground around bomb without touching it, and jerk on rope from safe distance.

If bomb must be moved, carry it gently and *horizontally*, never vertically. Destroy in safe place.

RE-USE

Impossible.

CAUTION

When armed, bomb is extremely sensitive to any jerk or jolt. Never touch it except in extreme emergency, and then only with greatest care. If it is to be exploded, soldier exploding it, or any nearby installations, can be protected by sandbags.

SPACE FOR NOTES

JAPANESE

MINE TACTICS, MINES

AND FUZES

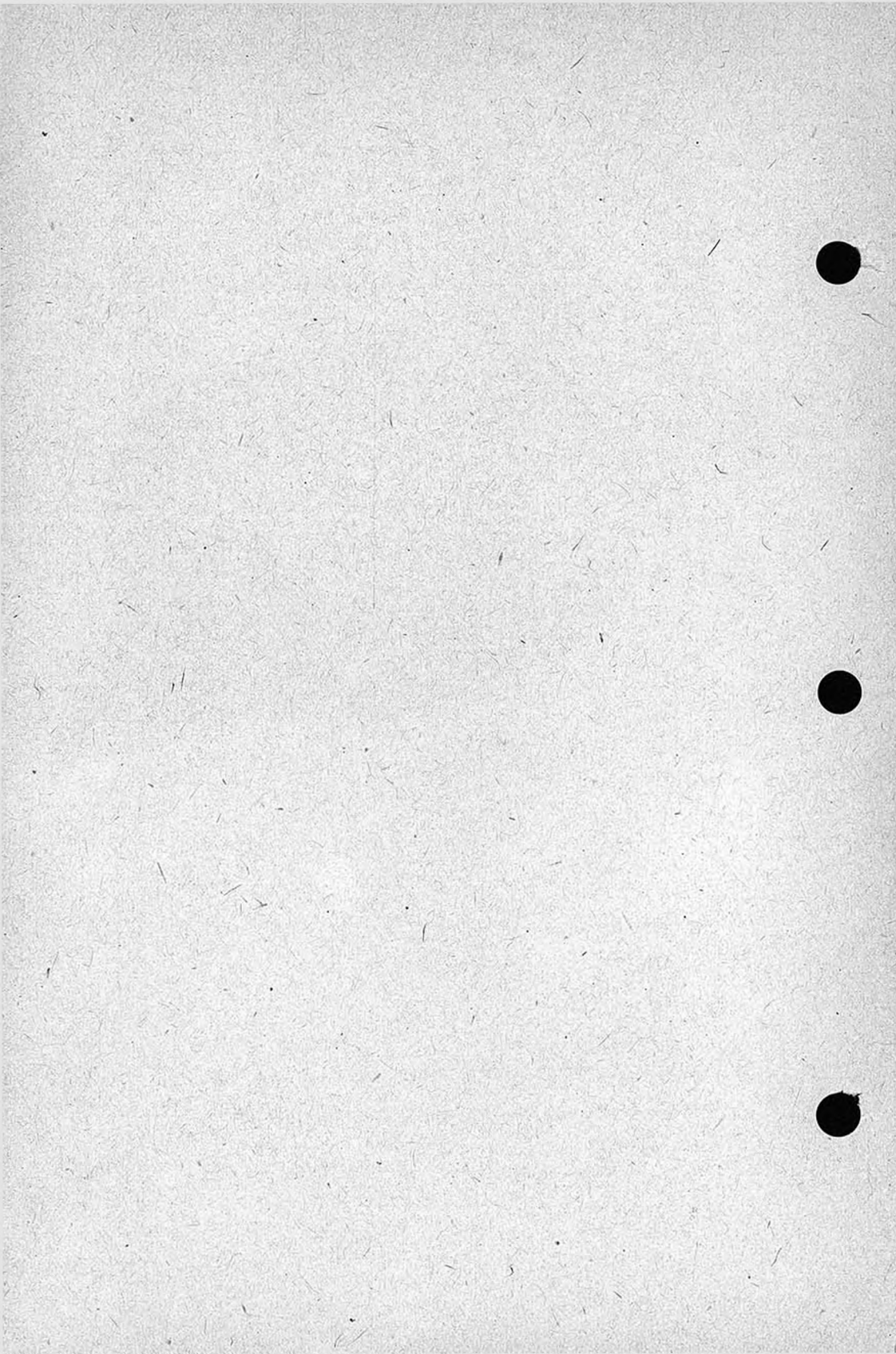

JAPANESE ANTITANK MINE, TYPE 93

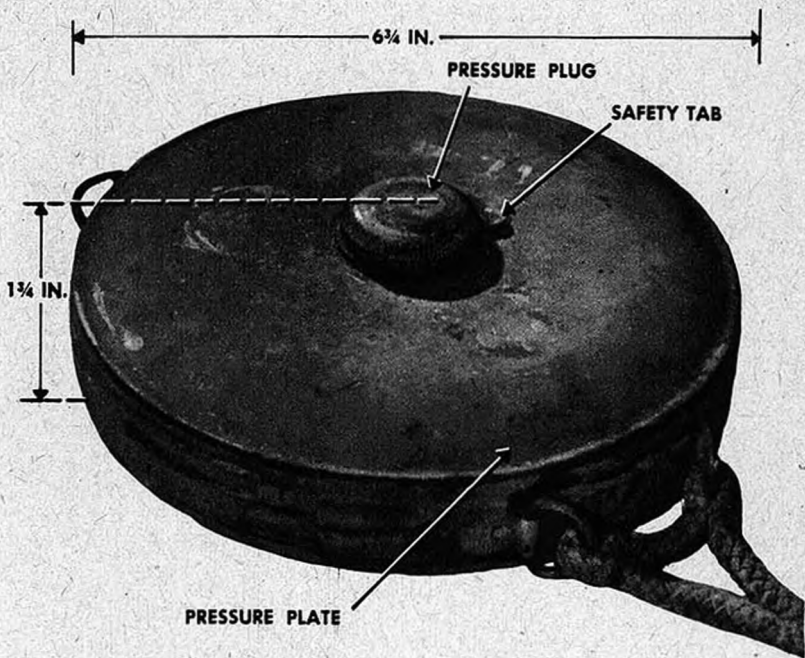

TYPE. Antitank mine

COLOR. Olive-drab, with red ring on top

CASE. Tin

WEIGHT. 3 pounds

EXPLOSIVE. 2 pounds picric acid

EFFECT. Disables vehicles. Used in groups of three to disable tanks.

RE-USE

Mines can be reused if shear pin is not cut or partially cut, and if the mines otherwise are in good condition.

JAPANESE ANTITANK MINE, TYPE 93

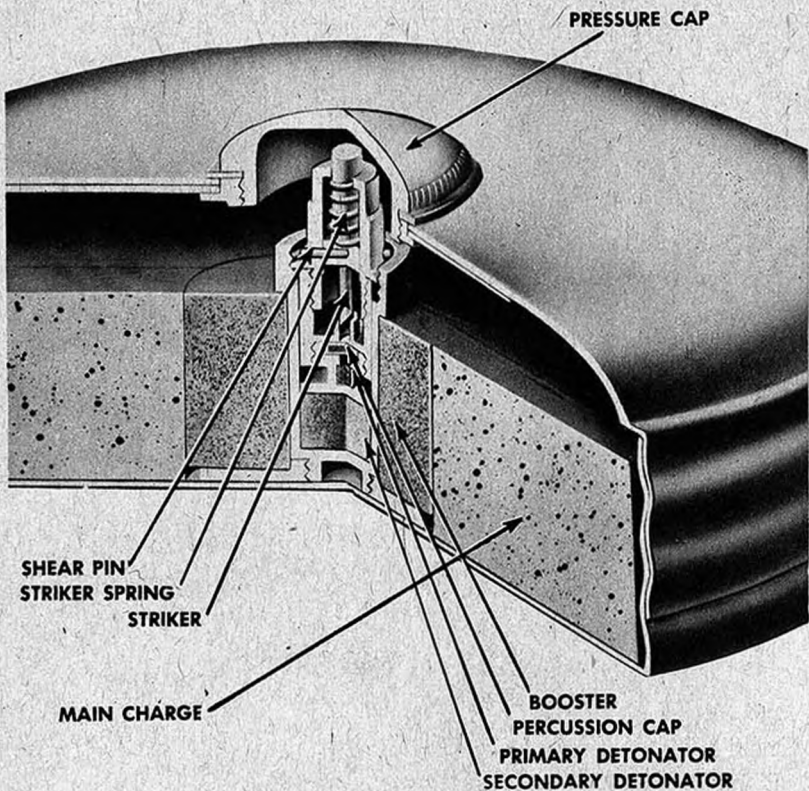

FUNCTIONING

1. Two hundred and fifty pounds pressure applied on pressure plug depresses striker pin and cuts shear pin.
2. Spring drives striker pin downward, firing percussion cap—detonator—booster—main charge.

JAPANESE ANTITANK MINE, TYPE 93

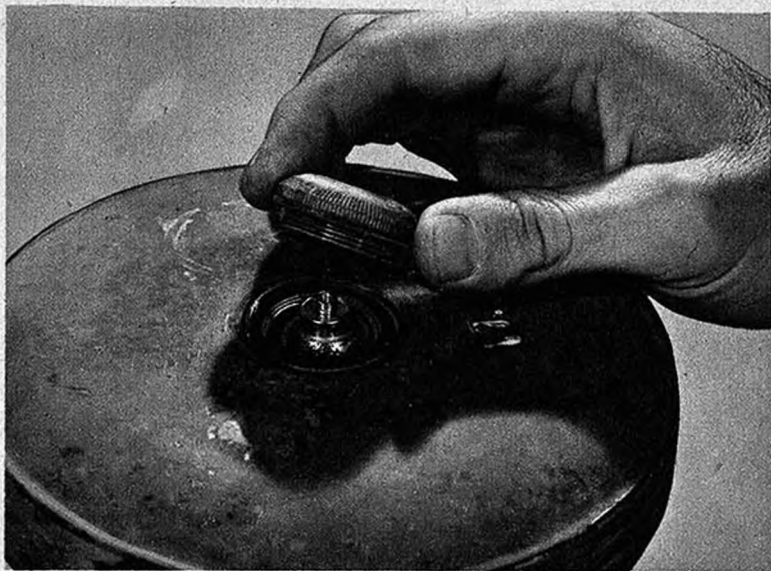

DISARMING

1. Examine area around mine for booby traps.
2. Without moving mine or exerting any pressure on pressure plate unscrew brass pressure plug.



3. Screw brass safety cap, if available, firmly into top of fuze; similarly, if combination washer and sleeve are available place them over brass safety cap and replace pressure plug.

JAPANESE ANTITANK MINE, TYPE 93



DEFUZING

1. Unscrew pressure plug.
2. Unscrew whole fuze.

INSTALLING AND ARMING

1. Unscrew pressure plug and remove leather washer.
2. Lift off combination washer and sleeve (tab attached).
3. Unscrew safety cap from fuze.
4. Replace leather washer and screw pressure plug into place.
5. Bury mine with pressure plug at ground level.

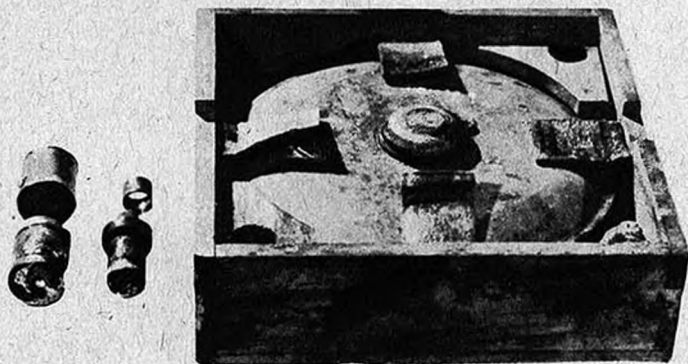

PACKING AND TRANSPORTING

Each mine is packed in a small wooden frame. No data on shipping crate.

NOTE

Japanese have two sizes of shear wire for this mine. One, for antipersonnel use shears at 70 lbs. The other, for antitank use shears at 250 lbs. These mines have been found buried upside down, with additional explosives placed beneath them to increase their effect.

JAPANESE MAGNETIC MINE

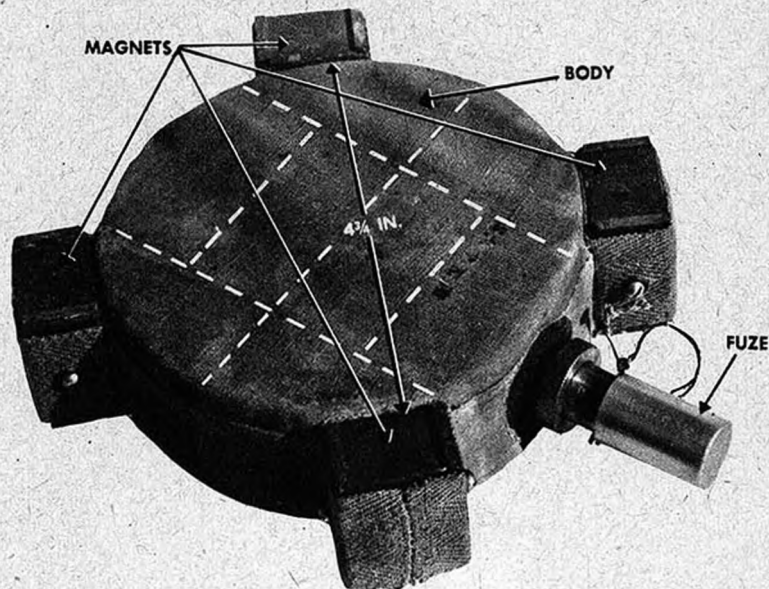

TYPE. Magnetic antitank charge

COLOR. Khaki

CASE. Canvas covering

WEIGHT. 2½ pounds

EXPLOSIVE. 1½ pounds

EFFECT. Single mine perforates ¾-inch armor plate. Two mines used in combination perforates 1¼-inch armor plate.

EMPLOYMENT

For direct use against armored vehicles, doors of pill-boxes, and similar targets. Mine is placed in contact with iron or steel objects and adheres by attraction of four magnets. Soldier placing mine removes safety pin and depresses a plunger on delay-action fuze. He then has 4 to 5 seconds to take cover. Usual practice is to use two mines together.

JAPANESE MAGNETIC MINE

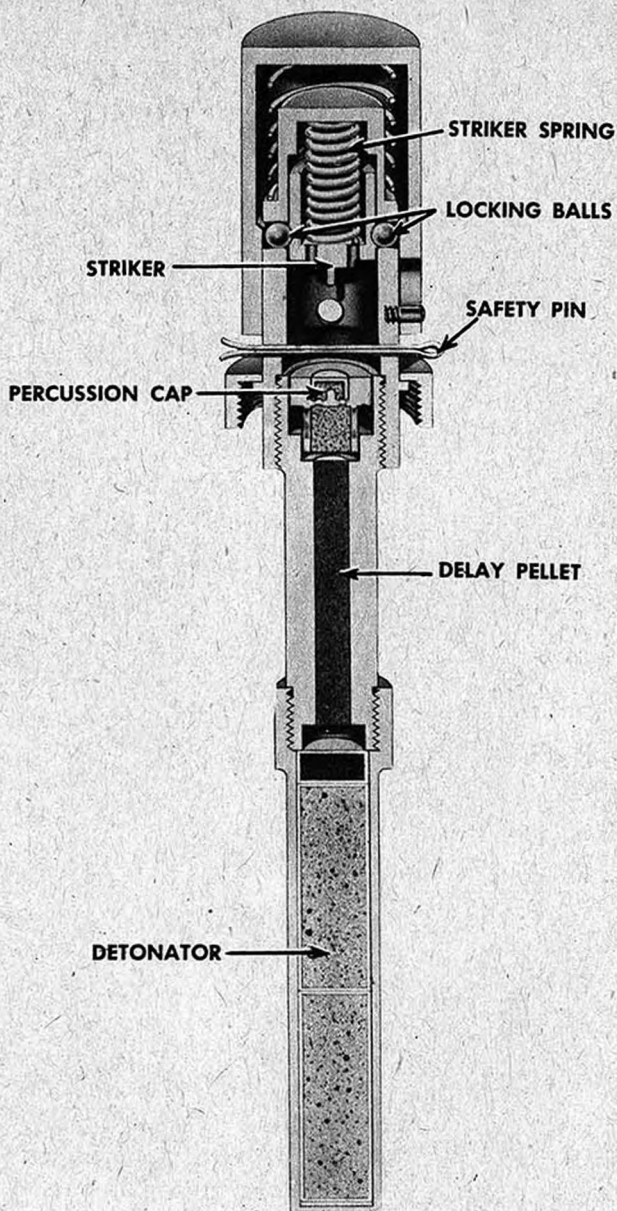

FUNCTIONING

1. Hand pressure on end of fuze depresses plunger releasing steel balls into groove in sliding cap.
2. Striker, driven by spring, fires percussion cap—delay pellet—detonator—main charge.

JAPANESE MAGNETIC MINE

DISARMING

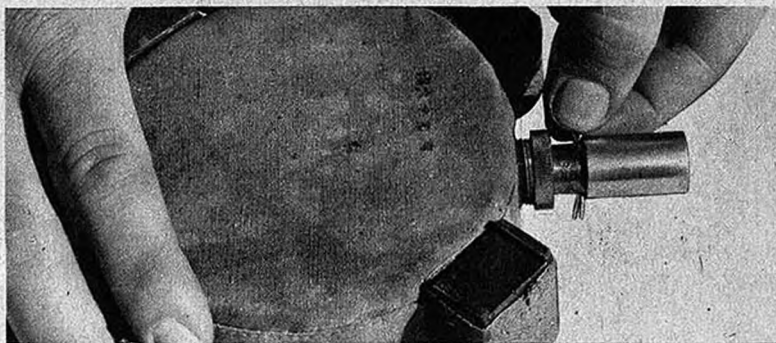

Insert safety pin in safety-pin hole.

DEFUZING

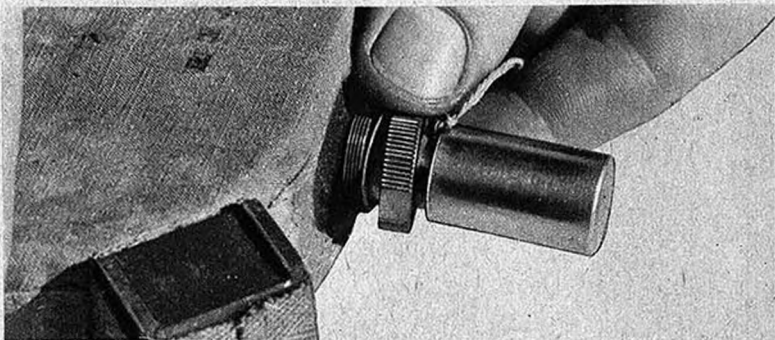

1. Loosen ring holding fuze in place.



2. Remove fuze from mine body.
3. Unscrew detonator from fuze to make parts safer to handle.

JAPANESE MAGNETIC MINE

INSTALLING AND ARMING

1. Remove mine from carrying pouch.
2. Remove wooden plug from mine body.
3. Screw fuze into mine body.
4. Pull out safety pin.
5. Press on cap. Four to five seconds later mine will detonate.

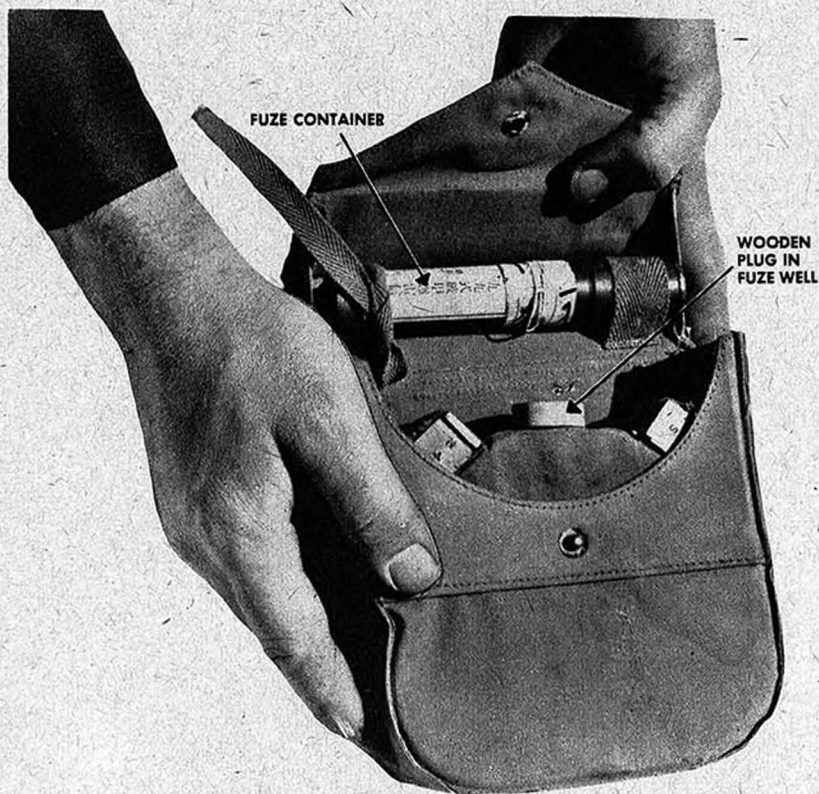

PACKING AND TRANSPORTING

Carried in a stiff canvas pouch which attaches to soldiers belt. Fitted to inside of pouch is a cylindrical, metal container for holding fuze.

JAPANESE FRICTION-FUZED LAND MINE

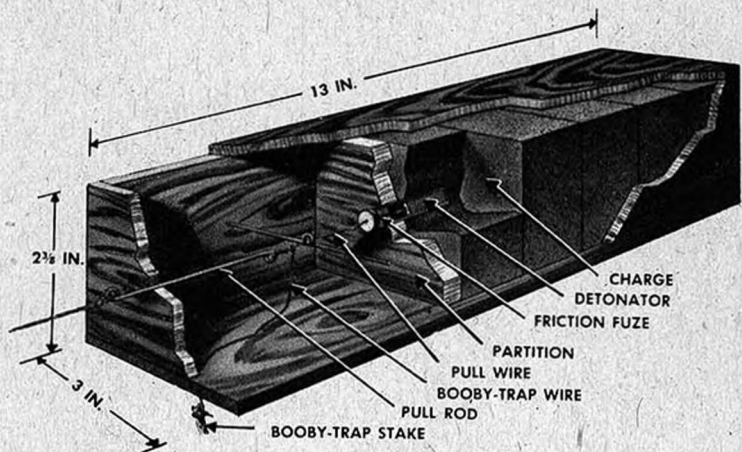

TYPE. Antitank and antipersonnel mine

CASE. Wooden box

EXPLOSIVE. 3½ pounds "yellow explosive," probably picric acid or TNT

FUNCTIONING

Pull on side trip wire or on booby-trap wire underneath causes friction fuze to flash and fire detonator—main charge.

DISARMING

1. Cut side trip wire.
2. Carefully remove soil where trip wire enters ground to buried mine.
3. Wedge pull rod firmly in place where it emerges from box.
4. Cut booby-trap wire just below bottom of box.
5. Remove lid and cut pull wire.

JAPANESE FRICTION-FUZED LAND MINE

DEFUZING

Withdraw fuze. Separate fuze from detonator.

INSTALLING AND ARMING

1. Drive stake into prepared hole.
2. Tie bottom booby-trap wire to stake.
3. Lay mine in place.
4. Thread booby-trap wire into box.
5. Attach one end of the side trip wire to pull rod, and other end to tree or other object.
6. Insert fuze through hole in partition.
7. Thread pull wire through loop of supporting wire, and tie to loop of pull rod.
8. Fasten booby-trap wire to pull wire.
9. Fill hole and camouflage.

RE-USE

Check condition of explosive and friction fuze before re-use.

SPACE FOR NOTES

JAPANESE PRESSURE AND TRACTION LAND MINE

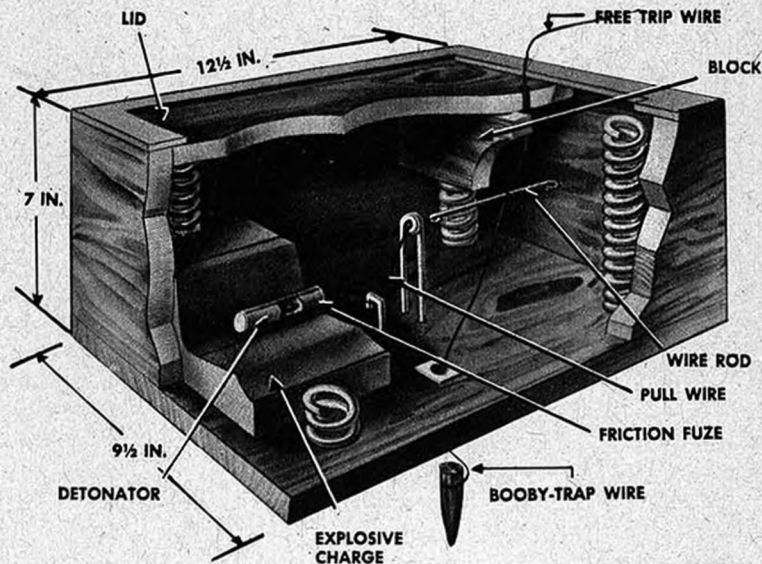

TYPE. Antitank and antipersonnel mine

CASE. Wooden box

EXPLOSIVE. 2 pounds "yellow explosive," probably picric acid or TNT

EMPLOYMENT

No information as to uses to which this mine is put. Assumed it may be used as a road mine, or placed in trail as an antipersonnel mine. By increasing size of box, amount of explosive can be increased to make it effective for antitank use.

FUNCTIONING

Can be fired by one or more of three methods.

1. Pulling trip wire, free end of which is attached to tree or stake.
2. Lifting box and exerting pull on portion of trip wire fastened to stake.
3. Pressing on lid, making block depress pivoted wire rod. In all three cases movement of wire rod by either pull or push causes pull in wire, which fires fuze—detonator—main charge.

JAPANESE PRESSURE AND TRACTION LAND MINE

DISARMING

1. Cut trip wire.
2. Remove retaining strips and lift off lid.
3. Cut pull wire.

DEFUZING

Cut portion of trip wire between pivoted wire rod and stake. Remove friction fuze and detonator and, if possible, separate friction fuze tube from detonator tube.

INSTALLING AND ARMING

1. Drive stake into excavated hole. Tie wire to stake.
2. Lay mine in hole so stake is just under hole of box.
3. Pass wire from stake through hole of box and tie to wire rod.
4. Tie trip wire to wire rod.
5. Insert friction fuze and detonator in hole provided in charge.
6. Pass pull wire under wire hook and through coiled wire, and tie it to rod.
7. Thread trip wire through lid.
8. Set lid in place on springs, and fasten retaining strips in place.
9. Cover and camouflage.
10. Make fast end of trip wire. It must be loose.

RE-USE

Check condition of explosive and fuze before re-use.

SPACE FOR NOTES

CHAPTER 12

R U S S I A N

**MINE TACTICS, MINES,
AND FUZES**

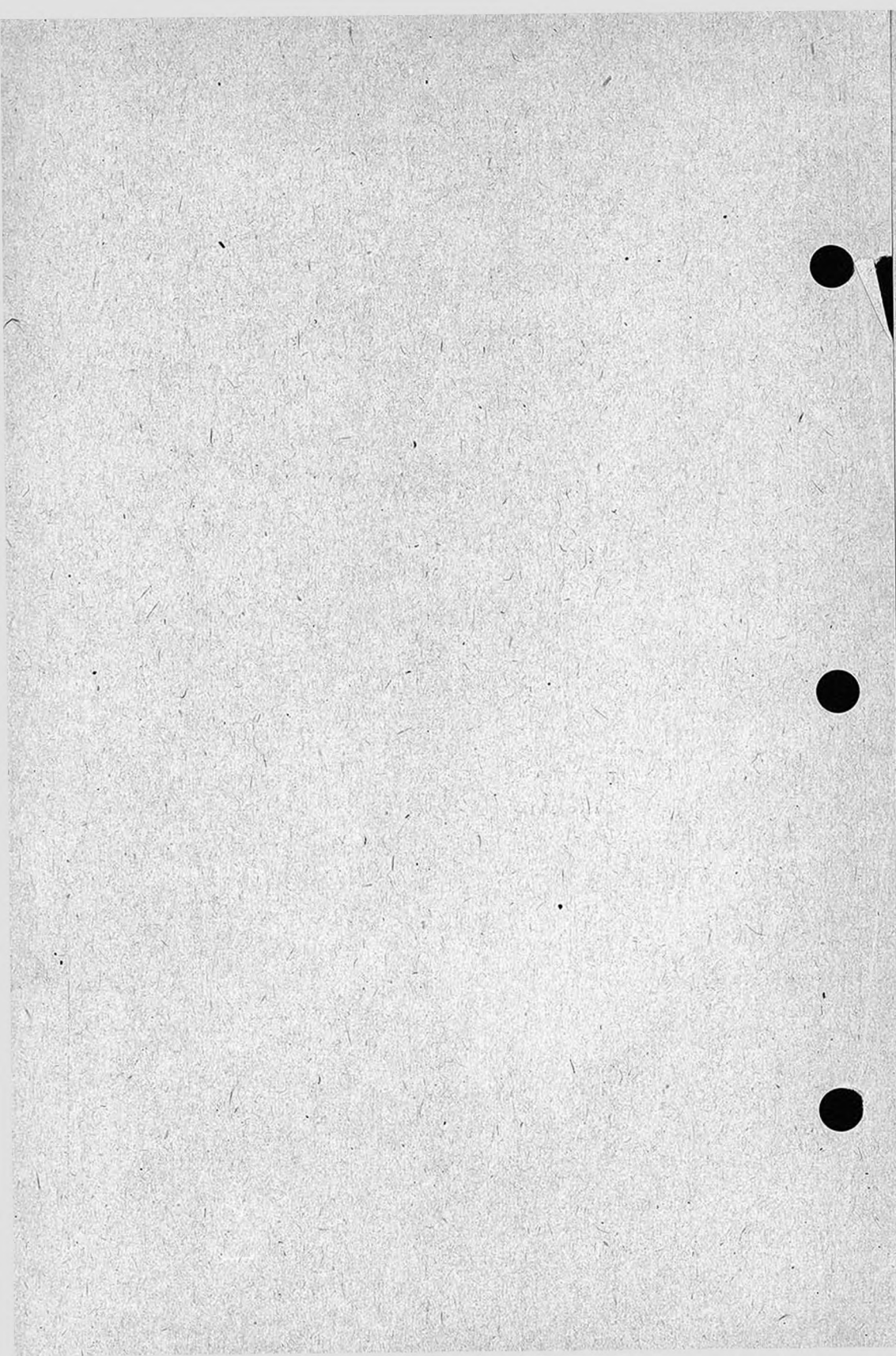

CHAPTER 13

MISCELLANEOUS

MINES AND FUZES

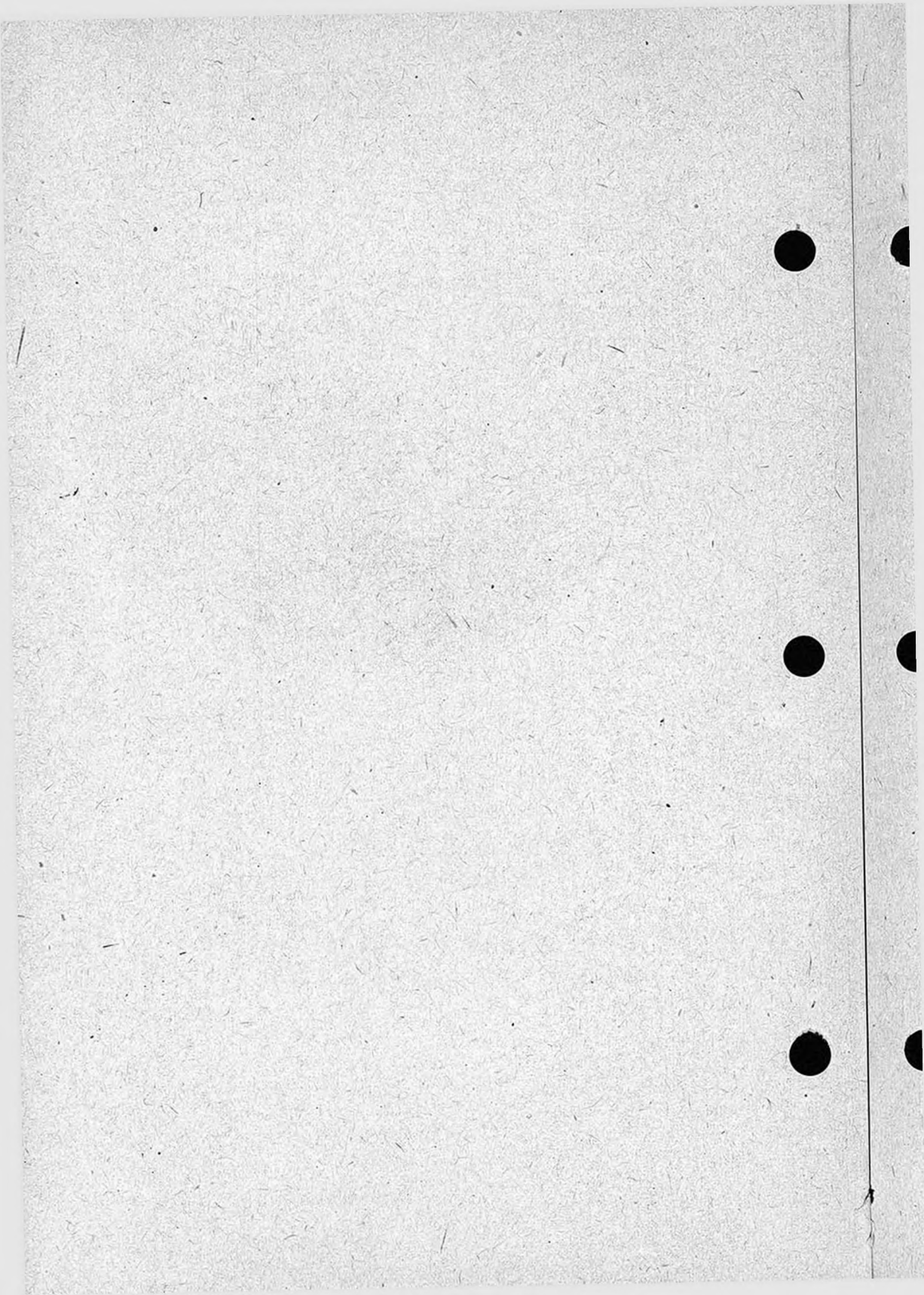

DUTCH MUSHROOM-TOP MINE

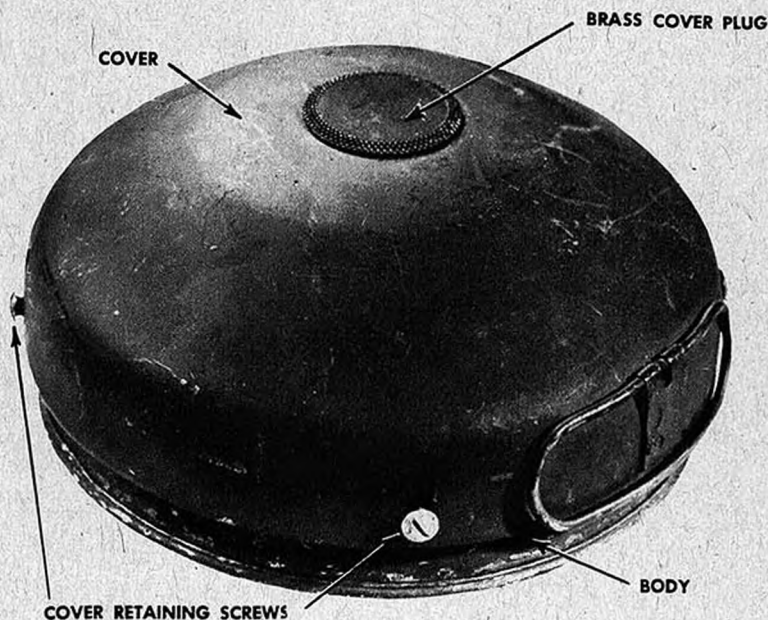

TYPE. Antitank and antipersonnel mine

COLOR. Olive-drab

CASE. Sheet steel

WEIGHT. 9½ pounds

EXPLOSIVE. 5¼ pounds cast TNT

EFFECT. Breaks tank tracks; causes casualties to personnel within radius of 20 yards.

EMPLOYMENT

Supplies of this type mine have been captured by the Japanese, who use them mainly against personnel, laying them in narrow trails, on beaches, and at entrances to bivouac areas. Normally they lay it on top of ground.

DUTCH MUSHROOM-TOP MINE

FUNCTIONING

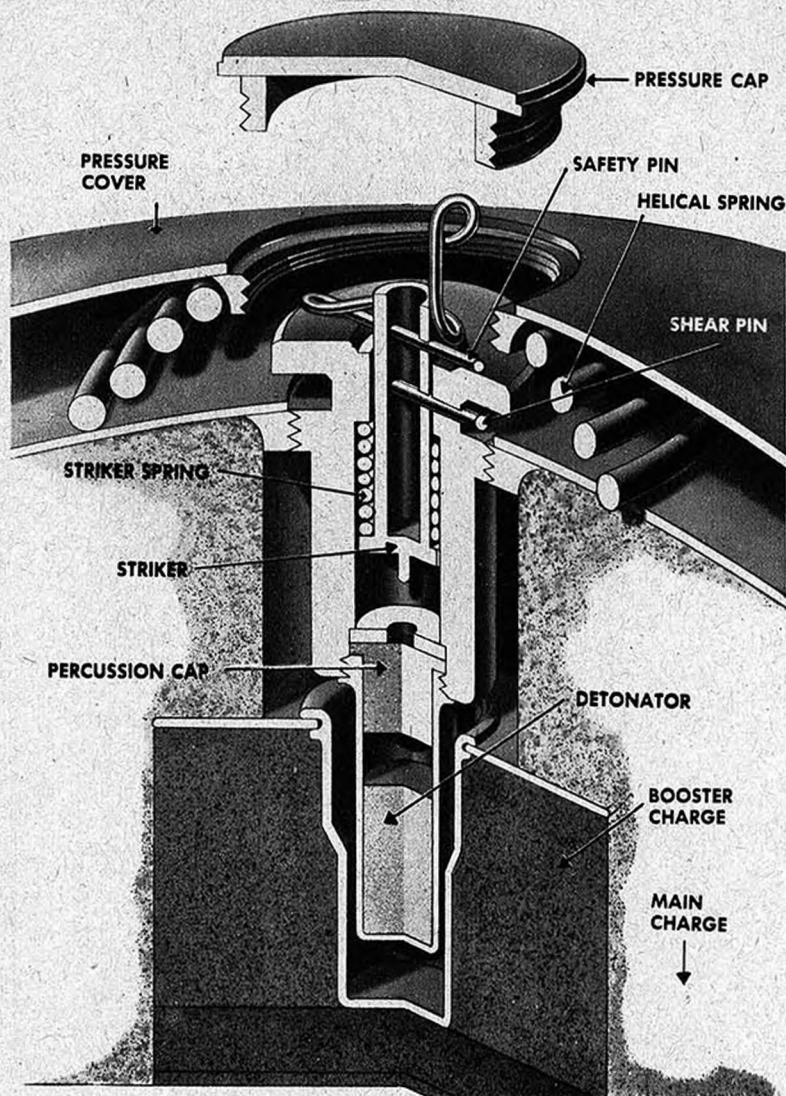

1. A 180-240 pound pressure on cover shears copper shear pin, releasing striker.
2. Striker, driven by spring, explodes percussion cap.
3. Flame from cap fires detonator—booster—main charge.

DUTCH MUSHROOM-TOP MINE

DISARMING



1. Unscrew brass cover plug.



2. Insert nail or stout wire in safety-pin hole. Some models of this mine do not have a safety-pin hole.

DEFUZING



1. Unscrew and remove fuze.
2. Replace cover plug.

DUTCH MUSHROOM-TOP MINE

INSTALLING AND ARMING

1. Remove brass cover plug and wax cork from fuze cavity.
2. Screw in fuze.
3. Remove safety pin.
4. Replace cover plug.

PACKING AND TRANSPORTING



Wooden packing box holds five mines, and five fuzes each sealed in a tin container.

RE-USE

Remove plug and cover. Check presence of helical spring and make sure waxed cork in fuze cavity is intact.

NOTE

The mine described here is the model that was manufactured in the United States. A slightly different model, manufactured in both Holland and Java, has been used by both the Germans and the Japs. This model has an operating pressure of only 50 pounds, has no safety pin, and is so made that the booster is an integral part of the fuze. It functions and is treated in the same way as the American model.

APPENDIX I

ELECTRICAL MINE DETECTORS

1. GENERAL

The SCR 625 electrical mine detector is a precision instrument and must be treated as such. In combat operations there should be a 100 percent reserve of electrical detectors available to each engineer unit at a mine-detector repair depot established at a central point as far forward as battle conditions permit. Normally, signal corps personnel operate this depot, to which, during battle, all units send mine-detector units for repair, receiving workable detectors in exchange.

2. TRAINING

a. Regular training in the use of electrical detectors is a necessary part of all engineer training. All other combat units should have certain personnel capable of using the detector. Only by continued training is it possible to establish the proper speed and swing for its effective use. A trained detector operator can sweep a 9-foot front.

b. While searching for mines, the operator must keep the detector head parallel with the ground, and 9 inches above it throughout the full swing, stepping forward between swings the length of the detector heads. To avoid incomplete sweeping as a result of fatigue, operators should be relieved regularly, at no time using the detector for longer than 20 minutes continuously.

c. Detector operators must become familiar with all types of enemy mines and trip-wire installations and with the methods of neutralizing each. They must be picked men who can be trained to accomplish their task under all battle conditions, even during a complete blackout.

d. When breaching a mine field, the three detector men in each party must work as a team. They make sure the necessary frontage is covered and that no strip between their individual areas is unswept. They must coordinate their speed and cover carefully the lanes assigned to them.



Figure 1.2. Electrical mine detector.

1 NOV 1943

FM 5-31

RESTRICTED

APPENDIX II

NOTES ON HOUSE BOOBY TRAPS FOR ARMS OTHER THAN ENGINEERS

1. TYPES AND CHARACTERISTICS

a. A house-booby trap consists of a main charge, a detonator, and a fuze. The fuze may be attached directly to the detonator or connected to it with a length of blasting time fuze or primacord. The trap may be rendered inoperative by disconnecting any one of these components from another.

b. The most commonly used fuzes are:

(1) **PULL FUZES.** Most enemy house booby traps are set with pull fuzes which fire when the attached trip wire is pulled. This type fuze is set in a great variety of ways, but usually by attaching a wire to objects likely to be moved, such as doors and furniture.

(2) **PRESSURE FUZES.** Pressure fuzes are fired by pressure on a cap or prong. In a house device, they may be installed to respond to pressure from the side as well as from above.

(3) **RELEASE FUZES.** These are fired when a weight is lifted off them.

(4) **COMBINATION FUZES.** Any combination of the above three types.

c. A fuze whose type is not recognized should be marked and left for engineers to deal with.

(1) **ELECTRICALLY OPERATED TRAPS.** These rarely are encountered. They can be identified by the presence of electric leads, dry cells, or batteries. If found, they should be left for the engineers—but *marked*.

(2) **TIME FUZES.** Those are long cylinders or clockwork devices. They are easy to recognize and easy to disarm. When disarmed they can be removed safely.

d. The sequence of dealing with booby traps is—

- (1) Find the trap.
- (2) Find and recognize fuze used.
- (3) Disarm trap.
- (4) Defuze trap.

The first step is the most difficult. Once found, house booby traps usually are easy to deal with.

2. LOCATING HOUSE BOOBY TRAPS.

a. Before opening a door look at the other side of it to see if it is trapped. Usually this can be done by looking through a window. Beware of pressure operated traps laid in the ground

by the doors or windows.

- b.** Don't open a window until you have examined both sides.
- c.** If you must open doors or windows and are unable to look at both sides, pull them open with a long rope.
- d.** Because you have found one trip wire attached to a door or other object do not assume there are no others.
- e.** Look carefully where you are treading—loose tiles, floor boards, or carpets may conceal traps with pressure fuzes.
- f.** Don't move furniture, pictures, or similar objects before examining them carefully for release fuzes or wires attached to pull fuzes.
- g.** Don't open any box, cupboard, lid, or drawer before examining it carefully.
- h.** Don't sit on any chair, sofa, or bed until it has been examined.
- i.** Avoid doing the obvious or natural thing until you are sure it is not what the enemy wanted you to do.
- j.** When removing the main charge of a trap make sure it, in turn, is not trapped.
- k.** Because traps are not found immediately, do not assume without further investigation that the entire area is not booby trapped.
- l.** Look before you leap. Afterwards, you may not be able to.

3. DEALING WITH HOUSE BOOBY TRAPS

- a.** Slack trip wires are safe to cut. If tight, you must find the fuze and put in the safety pin before you cut the wire. If you cannot reach the fuze, pull the wire from a safe distance.
- b.** Insert the safety pin in pull fuzes; then it is safe to unscrew or detach them.
- c.** In pressure fuzes, insert a safety pin thick enough to fit or nearly fit the hole. When this is done the fuze can be unscrewed or detached safely.
- d.** Time fuzes are safe to handle except at the time set for the explosion. They are detached from the main charge by unscrewing or cutting the fuze connecting them.
- e.** Release fuzes are disarmed by inserting a safety pin before removing the weight from them.

APPENDIX III

MINE-WARFARE TRAINING

1. GENERAL

Officers and enlisted men of all arms must have some training in mine warfare and enemy mine technique. All combatant personnel must know how to employ mines effectively.

2. TRAINING STANDARDS

a. Officers and enlisted men of all arms should know—

(1) Enough about the common types of mines—allied and enemy—to be able to locate, recognize, disarm, and remove them with a rope, even when they are booby-trapped.

(2) How to find mines by eye and by prodding.

(3) Simple mine-field reconnaissance and reporting procedure.

(4) The common types of roadside mines and booby traps, where to expect them and how to avoid them.

(5) The standard mine-field marking signs and danger signs, both allied and enemy.

(6) Simple marking and reporting procedure for mines and booby traps.

(7) How to lay and report a hasty, local, protective mine field.

b. Minefield specialists must be trained—

(1) To recognize, disarm, remove, and defuze all U. S., Allied, and enemy mines and booby traps.

(2) To reconnoiter and report enemy mine fields.

(3) To clear and mark lanes through mine fields.

(4) To clear roads, bridges, and other localities of mines and booby traps and to remove delayed-action charges.

(5) To clear houses of booby traps.

(6) To lay, mark, and report mine fields.

c. Combat engineers must be thoroughly trained and regularly drilled in the standard procedure for breaching mine fields in cooperation with other arms.

d. Each division must be trained in the method of crossing mine fields. For deep mine fields, this will involve both day and night training.

e. Every man should be as accustomed to mines as he is to his rifle. Continuous practice under realistic conditions is essential.

3. EMERGENCY MINE-FIELD BREACHING

All unit mine-warfare training must be based upon the fact that engineers often will not be available at a critical time and place to breach mine fields encountered unexpectedly in battle.

Therefore, units have specially trained detachments capable of

breaching a mine field and of marking the lane clearly. These detachments are organized as follows:

a. In each infantry battalion the pioneer platoon is trained in mine field breaching. This training is extended, as quickly as possible, so not less than 20 men in each infantry company are fully trained in the prodding method of clearing a 16-yard gap.

b. Detachments of other arms are trained in mine clearance according to the following scale:

- (1) Artillery, 10 men per battery.
- (2) Tank battalion, both light and medium, 2 men per tank crew.
- (3) Reconnaissance battalion, 20 men per company.
- (4) Signal company, 15 men per company.
- (5) Trains, 20 men selected from the units represented.

The number of personnel designated above is the minimum required for efficient operations in combat theaters. All possible personnel should be trained in mine clearance.

4. PRECAUTIONS

a. To keep alive and able to fight, you must know and obey these precautions of mine warfare:

- (1) Let one man deal with one mine, while the rest stay out of danger.
- (2) When in doubt, get help from specially trained troops.
- (3) Be careful when you are most tired.
- (4) Keep your eyes on the ground while moving through a mine field.
- (5) Keep yourself and your men in constant practice.
- (6) Remember that in mine warfare time spent on reconnaissance saves lives.
- (7) Expect and be prepared for continual changes in enemy methods.
- (8) Remember that the man who does the wrong thing usually kills not only himself but others.
- (9) Insist on alertness and the strictest discipline in dealing with mines.
- (10) Remember that knowledge gives confidence.
- (11) Treat mines as just one of the normal risks of war.
- (12) Mark the area or lane you clear, and report it.
- (13) Mark all mines and booby traps you find.

b. Also remember the following:

- (1) DO NOT trust anything—suspect everything.
- (2) DO NOT bunch together.
- (3) DO NOT pull a loose trip wire, DO NOT cut a taut one.
- (4) DO NOT run in a mine field.
- (5) DO NOT get careless or overconfident.
- (6) DO NOT rush into a mine field to help a man who has been hit or blown up.

(7) DO NOT assume an enemy fence means there are no mines beyond it.

(8) DO NOT jump to the wrong conclusion because the first few mines you find are not booby-trapped.

(9) DO NOT forget your enemy is a ruthless, cunning, and ingenious killer.

(10) DO NOT sit back and do nothing when you encounter mines. You can get through them if properly trained.

(11) DO NOT forget to look for booby traps.

(12) DO NOT use the obvious and easiest terrain without searching it first.

c. Remember, the enemy uses mines to delay you. If you are slow, he has succeeded and you have failed. Everybody else is held up while you are doing your job. You *MUST* get through, *IN THE SHORTEST POSSIBLE TIME*. This means intense determination and great practical skill, which can come only from continual training and practice under realistic conditions.

extérieur, et dépose les deux ampoules de verres à l'intérieur du corps de l'allumeur. Le mélange des liquides produit une étincelle qui met le feu au détonateur et à la mine.

5. Pour armer la mine.

Les topf mines ne sont pas armées avant d'être amenées au lieu de pose. Là, on munit l'allumeur de topf mine d'un détonateur, on replace sur l'allumeur la douille de protection du détonateur, et on visse alors l'allumeur dans le bouchon d'amorçage. Puis on visse fortement le bouchon d'amorçage dans le corps de la mine, en s'assurant que le rebord circulaire et la rondelle en caoutchouc sont parfaitement propres de façon que la mine soit absolument étanche.

Une mine armée de cette façon avec l'allumeur de Topf mine est toujours posée le plateau de pression au-dessus.

6. Emploi.

La topf mine est posée de la même façon que la Tellermine 42. Il est préférable de l'enterrer et non pas de la poser sur le sol; cette dernière méthode n'est acceptable que lorsqu'une attaque ennemie est imminente. Pour éviter une détonation des mines par influence, la distance entre deux topf mines ne doit pas être inférieure à 2 m 15 quand les mines sont enterrées et 4 m 30 quand elles sont posées sur le sol.

Dans un rayon de 1 m autour d'une topf mine enterrée, la terre doit être ameublie de façon à faciliter l'action de la mine. Pour camoufler l'engin on recouvre le plateau de pression d'une couche de 5 cm d'épaisseur au maximum.

Quand on utilise un allumeur du type à tige, ou tout autre allumeur réglementaire, on doit poser la mine avec le plateau de pression en dessous, l'allumeur étant vissé dans le logement pour allumeur supplémentaire. Dans ce cas on ne place aucun allumeur de topf mine dans le logement pour allumeur principal.

7. Pour désarmer l'engin.

- A) Découvrir complètement la mine, et s'assurer qu'elle n'est pas endommagée, en particulier le long de la rainure de cisaillement.
- B) Soulever soigneusement la mine, la poser de CHAMP et dévisser soigneusement le bouchon d'amorçage.
- C) Enlever l'allumeur de son logement.
- D) Dévisser la douille de protection du détonateur.
- E) Retirer soigneusement le détonateur, et remplacer la douille protectrice sur le détonateur.

8. Mesures de sécurité.

Le règlement allemand déclare qu'il est interdit de transporter une topf mine armée, quel que soit le

TOFF MINE "A" (suite,)

type de l'allumeur. Les topf mines non munies de leurs allumeurs peuvent être transportées avec ou sans leur caisse d'emballage, mais on ne doit pas les engorger sans leur caisse. Les mines doivent être conservées dans un endroit frais, et protégées de la pluie et des grosses chaleurs.

Les allumeurs de topf mines ne doivent être transportés que dans leur boîte d'emballage en bois. L'allumeur est dangereux et peut occasionner de graves brûlures s'il vient à se briser.

9. Emballage.

Les topf mines sont approvisionnées chacune dans une caisse à claire voie en bois, marquée To Mi 453I .

Les allumeurs de topf mines sont approvisionnés dans des boîtes en bois marquées, To.Mi.Z.SF I, et contenant chacune 5 allumeurs.

Les détonateurs non métalliques sont fournis aux unités, à part, dans des petites boîtes en bois contenant chacune 15 Détonateurs.

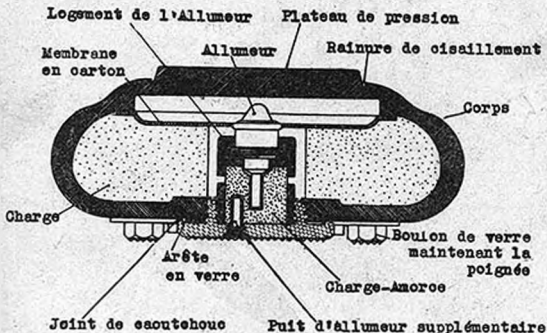

Coupe de la Topfmine