

MHI
Copy 3

FM 8-40

WAR DEPARTMENT

MEDICAL FIELD MANUAL

FIELD SANITATION

FM 8-40

MEDICAL FIELD MANUAL



FIELD SANITATION

Prepared under direction of
The Surgeon General



UNITED STATES
GOVERNMENT PRINTING OFFICE
WASHINGTON: 1940

For sale by the Superintendent of Documents, Washington, D. C.
Price 25 cents

WAR DEPARTMENT,
WASHINGTON, *August 15, 1940.*

FM 8-40, Medical Field Manual, Field Sanitation, is published for the information and guidance of all concerned.

[A. G. 062.11 (6-5-40).]

BY ORDER OF THE SECRETARY OF WAR:

G. C. MARSHALL,
Chief of Staff.

OFFICIAL:

E. S. ADAMS,
Major General,
The Adjutant General.

TABLE OF CONTENTS

	Paragraphs	Page
CHAPTER 1. GENERAL.....	1-5	1
CHAPTER 2. CONTROL OF COMMUNICABLE DISEASES.		
Section I. General.....	6-15	5
II. Respiratory diseases.....	16-17	12
III. Intestinal diseases.....	18-22	17
IV. Insect-borne diseases.....	23-26	20
V. Venereal diseases.....	27-34	22
CHAPTER 3. WATER.		
Section I. Responsibility for water supply..	35-36	25
II. Water characteristics and re- quirements.....	37-39	26
III. Sources.....	40-42	27
IV. Purification.....	43-48	29
V. Water reconnaissance.....	49-53	34
CHAPTER 4. WASTE DISPOSAL.		
Section I. General.....	54-55	39
II. Human wastes.....	56-69	40
III. Garbage.....	70-75	50
IV. Liquid wastes.....	76-82	61
V. Manure.....	83-91	66
VI. Rubbish.....	92-94	70
CHAPTER 5. MESS SANITATION.		
Section I. Responsibility.....	95-96	72
II. Facilities.....	97-99	73
III. Cleansing of utensils and disposal of wastes.....	100-101	74
IV. Menus and serving of food.....	102-105	77
V. Mess inspection.....	106-107	79
CHAPTER 6. HYGENIC CONTROL OF FOOD PRODUCTS OF ANIMAL ORIGIN.		
Section I. Meat and meat food products...	108-114	84
II. Sanitary inspections.....	115-117	86
III. Poultry and eggs.....	118-119	88
IV. Fish and sea foods.....	120-121	89
V. Milk and dairy products.....	122-126	92
CHAPTER 7. FLY CONTROL.		
Section I. Development and characteristics of the fly.....	127-128	96
II. General control measures.....	129-130	97
III. Fly traps.....	131-135	98
IV. Other special measures.....	136-140	104
CHAPTER 8. MOSQUITO CONTROL.		
Section I. Development, habits, and char- acteristics of the mosquito....	141-145	106
II. Control measures.....	146-164	111
CHAPTER 9. CONTROL OF LICE.		
Section I. General.....	165-168	121
II. Methods of disinfection.....	169-178	123

TABLE OF CONTENTS

	Paragraphs	Page
CHAPTER 10. RAT CONTROL.		
Section I. Importance, classification, and habits of the rat.....	179-181	132
II. General control procedure.....	182-183	133
III. Eradication by poisoning.....	184-187	133
IV. Eradication by trapping and fumigating.....	188-192	135
V. Rat surveys.....	193-196	137
CHAPTER 11. SANITARY SURVEYS AND SANITARY ORDERS.		
Section I. Sanitary surveys.....	197-199	139
II. Sanitary orders.....	200-205	141
CHAPTER 12. FIELD EPIDEMIOLOGY.		
Section I. Epidemiological investigation...	206-209	144
II. Carriers and missed cases.....	210-211	147
CHAPTER 13. PHYSICAL EXAMINATIONS.		
Section I. Responsibility and standards....	212-214	149
II. Conduct of examinations and inspections.....	215-217	149
CHAPTER 14. IMPORTANT FACTORS RELATIVE TO PERSONAL HYGIENE.		
Section I. General.....	216-219	153
II. Prevention and treatment of skin diseases	220-221	155
III. Oral hygiene.....	222-224	158
CHAPTER 15. VITAL STATISTICS.		
Section I. Statistical rates and strengths...	225-227	160
II. Methods of computing rates and ratios.....	228-231	161

MEDICAL FIELD MANUAL

FIELD SANITATION

CHAPTER I

GENERAL

■ 1. PURPOSE OF MILITARY SANITATION.—The application of well-established practical measures for the preservation of the health and the prevention of disease is essential in order that the military personnel may be kept at its maximum effective strength. It is of the greatest importance that all officers and enlisted men should be conversant with the fundamentals of military sanitation as outlined in this manual, and amplified in TM 8-255 (now published as Army Medical Bulletin No. 23), and that they cooperate in observing and carrying out the measures prescribed in Army Regulations. The issuance of proper orders and regulations regarding military sanitation will not produce satisfactory results unless they are intelligently enforced and implicitly obeyed by all, from the highest to the lowest grades.

■ 2. RESPONSIBILITY FOR SANITATION.—*a. Commanding officers.*—Commanding officers of all grades are responsible for sanitation and for the enforcement of the provisions of sanitary regulations within their organizations and the boundaries of areas occupied by them. Commanding officers will take such steps as they deem practicable and feasible to correct sanitary defects.

b. Medical Department.—The Medical Department is charged with the duty of investigating the sanitary conditions of the Army and making recommendations in relation thereto, of advising with reference to the location of camps, the quality of water supply and purification, efficiency of waste disposal, the prevention of disease among military personnel and animals, and the execution of all measures for conferring immunity from disease on military personnel and animals. The Medical Department is further charged with the responsibility

of investigating and making recommendations concerning the following:

(1) Training in matters of personal hygiene and sanitation.

(2) The adequacy of the facilities for maintaining sanitary conditions.

(3) Insofar as they have a bearing upon the physical conditions of troops—

(a) The equipment of organizations and individuals.

(b) The character and condition of the buildings or other shelters occupied by troops.

(c) The character and preparation of food.

(d) The suitability of clothing.

(e) The presence of rodents, vermin, and disease-bearing insects and the elimination thereof.

c. Medical officers.—The senior medical officer of a command or station is charged, under the commanding officer, with the general supervision of the Medical Department of the command in the performance of its duties. Medical officers, as technical advisers of their commanding officers, are responsible for pointing out insanitary conditions and making proper recommendations for their correction, but the direct responsibility rests with the commanding officer. When, however, a commanding officer authorizes a medical officer to give orders in his name for the correction of sanitary defects, as is advisable under proper limitations, the duties and responsibilities of the latter are correspondingly increased.

d. Medical inspectors.—The medical inspector is an assistant to the surgeon and under him is charged especially with the supervision of the sanitation of the command to which he is assigned and the prevention of communicable diseases therein. The veterinarian of a command or station is considered as a medical inspector as regards animal sanitation and the performance of the prescribed duties in connection with meat and dairy hygiene.

■ 3. SANITARY SUPERVISION.—Supervision of the sanitation of a station or command is one of the most important duties devolving upon a medical officer. Inspections and reports will not be made in a perfunctory manner. (See AR 40-275.)

Sanitary defects susceptible of correction by local authority will be reported to the responsible officer immediately with recommendations for practical remedial measures. Reports of inspection are made in accordance with requirements outlined in AR 40-275.

■ 4. SANITATION DETAILS.—*a. General.*—The senior medical officer of each station or command large enough to warrant such action will organize one or more sanitation details from officers and enlisted men of the Medical Department. Sanitation details ordinarily function under the direction of the medical inspector.

b. Duties.—The duties of the sanitation details are in general—

(1) To assist the medical inspectors in the performance of their duties.

(2) To make inspections of sanitary appliances and measures in use, and to report to the medical inspectors infractions of sanitary orders or regulations.

(3) To inspect and report upon the methods employed in the removal and disposal of excreta and refuse, the construction of simple sanitary appliances, the adequacy of bathing and delousing facilities, water-purification apparatus, and all other appliances used in maintaining the health of the command.

(4) To give instruction to troops in technical sanitary matters. *The duties of sanitation details are distinct from and must not be confused with those to be performed by police details.*

■ 5. SANITATION IN A THEATER OF OPERATION.—*a. Area sanitation.*—In a theater of operation, when practicable, each army and corps area and each section of the communications zone, including particularly any rest or training areas containing large bodies of troops distributed over considerable territory, will be divided and subdivided into a convenient number of sanitary areas and subareas, by the designation of definite lines of demarcation, for the purpose of systematizing and supervising sanitation. One officer of the Medical or Sanitary Corps will have charge, under the medical inspector of the military area or sector involved, of each sanitary area so designated. A sanitation detail (see par. 4) will be assigned

to each such officer. One or more enlisted men of the sanitation detail will be assigned by the officer in charge of the sanitary area to the subareas under his jurisdiction.

(1) The duties in general of such officers in charge of a sanitary area are to—

(a) Instruct enlisted men assigned to his area in the sanitary fundamentals to be put in operation, distribute them in small groups to each subarea, and supervise their work.

(b) Keep himself informed as to all matters of sanitary importance in his area and to furnish such information to all incoming organizations.

(c) See that all outgoing organizations leave the territory occupied by them in good sanitary condition.

(d) Make such reports to the medical inspector under whom he is serving as may be required.

(e) Perform such other duties in connection with sanitation as may be directed or authorized by proper authority.

(2) The duties, in general, of the enlisted men assigned to each subarea are to—

(a) Keep detail maps of the subarea showing location of water sources, latrines, urinals, stables, dumps, baths, kitchens, billets, barracks, and camps.

(b) Regularly inspect and report upon the condition of sanitary appliances located in the subarea.

(c) Report to the officer in charge of the sanitary area concerning sanitary conditions and prevalence of disease in the subarea.

(d) Furnish information as to sanitary conditions and location of sanitary appliances to incoming troops.

(e) Perform such other duties in connection with sanitation as may be directed or authorized by proper authority.

b. Disposal of deceased personnel and animals during and immediately after a battle.—During or immediately preceding or following battle, labor troops or like organizations will be assigned to follow in the path of each corps or division in the line to make prompt disposal of the bodies of deceased personnel and animals under the sanitary supervision of the corps (or army) medical inspector. The bodies of deceased personnel will be properly buried, and those of animals will be either buried or burned as circumstances may indicate.

CHAPTER 2

CONTROL OF COMMUNICABLE DISEASES

	Paragraphs
SECTION I. General	6-15
II. Respiratory diseases.....	16-17
III. Intestinal diseases.....	18-22
IV. Insect-borne diseases.....	23-26
V. Venereal diseases.....	27-34

SECTION I

GENERAL

■ 6. CLASSIFICATION.—Communicable diseases may be classified in a number of ways. From the viewpoint of *control* they are best classified into the following five groups:

- a. Respiratory diseases.
- b. Intestinal diseases.
- c. Insect-borne diseases.
- d. Venereal diseases.
- e. Miscellaneous.

■ 7. RESPONSIBILITY FOR INITIATION AND ENFORCEMENT OF PREVENTIVE MEASURES.—*a. Medical Department.*—The Medical Department is charged with the initiation and supervision of measures for the control and prevention of disease in military personnel and animals and among inhabitants of occupied territories. The functions of officers of the Medical Department are, in the main, of an inspectorial and advisory nature.

b. Commanding officers.—Commanders of all grades are charged with the responsibility of putting into effect sanitary orders or regulations. Commanders of all grades will devote attention to the enforcement of regulations, especially the following:

- (1) Thorough washing of hands after visiting latrines and before meals.
- (2) Proper sterilization of dishes and mess kits.
- (3) Vaccination against smallpox, typhoid and paratyphoid fevers, tetanus, and other diseases if indicated.

- (4) Prevention of venereal disease.
- (5) Proper ventilation of barracks or tents.
- (6) Elimination of overcrowding.
- (7) Eradication of mosquitoes.
- (8) Destruction of flies, lice, and other insects.
- (9) Purification of nonpotable water supplies.
- (10) Proper disposal of human excreta and manure.
- (11) Proper disposal of garbage.

■ 8. PRINCIPAL OBJECTS.—*a. General.*—Certain of the measures enumerated in this manual relate to the prevention of disease in the individual while others deal directly with the communicable disease itself and place the responsibility of prevention of its spread on specially trained experts.

b. Objects.—A program of military sanitation has in view the accomplishment of the following objects:

(1) Continuous maintenance in each individual of the highest possible state of health.

(2) Training of the soldier in such rules of personal conduct as will enable him to avoid the infective agent of communicable diseases.

(3) Specific immunization of each individual against communicable disease when it is possible of accomplishment.

(4) Supervision of all known infectious cases with a view to preventing the transference of the causative agent to others.

(5) Supervision of the common avenues of transmission with a view to freeing them from any living causative agents by means of the filtration and chlorination of water, pasteurization of milk, thorough cooking of food, and destruction or exclusion of flies.

■ 9. DEFINITION OF SPECIAL TERMS.—In the application of the measures relating to the prevention of the communicable disease in man, the following terms are used as defined below:

a. Contact.—A contact is a person quartered in the same tent or occupying a nearby bed in a squad room, or closely associated at mess or otherwise, with an individual infected with the causative agents of a communicable disease.

b. Carrier.—The term "carrier," as used in this manual, is applied to an individual who harbors and excretes causative

agents of a communicable disease without the usual evidence of the disease produced by the agent in question. Carriers may be classified as follows:

(1) *True carriers* who harbor parasites which are pathogenic and virulent. True carriers are subdivided into—

(a) Incubationary carriers who are temporary carriers in the incubation stage of a communicable disease.

(b) Convalescent carriers who may be temporary or chronic. Temporary convalescent carriers are persons who are in the convalescent stage of a communicable disease but have not as yet eliminated all the causative organisms. Chronic convalescent carriers may have apparently recovered entirely from the disease, but they presumably still have some concealed lesion which permits the parasite to continue its growth. The excretion of parasites in such cases is often intermittent.

(c) Contact carriers who may be temporary or chronic. Contact carriers are those who acquire parasites from association with cases or carriers without themselves developing the disease.

(2) *Pseudo carriers* who harbor organisms morphologically and culturally indistinguishable from pathogenic and virulent parasites which are, however, found on further examination to be nonpathogenic and avirulent. During the course of this examination these individuals must be regarded as true carriers until nonpathogenicity and avirulence are established.

c. *Suspect*.—A suspect is a person exhibiting signs or symptoms which, though not definitely diagnostic in character, may indicate some stage of a communicable disease.

d. *Quarantine*.—Quarantine is the application of such restrictive measures to the activities of contacts, carrier suspects, and cases of communicable disease as may reasonably be expected to prevent further spread of the causative organisms of these diseases.

(1) Working quarantine is the segregation of selected carriers or contact groups in such a manner that a given group is not brought into contact with another group or with other persons, yet the performance of certain duties (such as fatigue, drill, or instruction) is not interrupted.

(2) Absolute quarantine is the detention of contacts, carriers, suspects, persons ill with communicable disease, or other groups of individuals in complete isolation, either individually or collectively, as the circumstances may warrant.

■ 10. INFLUENCE OF ENVIRONMENT.—The specific part that environment plays in the spread of communicable diseases depends upon whether or not it permits of the exchange of human discharges or whether or not certain insects which are known to act as transmitters of disease constitute an integral part of environmental conditions. The presence of certain insects and overcrowding, combined with faulty discipline and limited facilities for bathing the body and washing the hands, contribute to the spread of communicable diseases whenever certain specific infections are introduced into the community. In addition, unfavorable environment will lower body resistance and thereby the individual is predisposed to contract disease. The rapid mobilization of large numbers of recruits and the bringing together of detachments of men from different units for the formation of new organizations result in rapid dissemination of nonpathogenic and pathogenic micro-organisms carried by individuals. Such conditions are ideal for the spread of communicable diseases.

■ 11. PRIMARY FACTORS IN SPREAD.—*a.* A communicable disease is a process of the interaction of specific microbic parasites and of host. Before such a process can be set up, the parasites must be implanted in or carried to the susceptible tissues of the susceptible host, and the parasites must be alive and endowed with the characters necessary to give rise to the disease. The three primary factors in infection are the—

(1) *Seed.*—The available reservoir of specific pathogenic micro-organisms of adequate infectivity and virulence.

(2) *Sower.*—The adequate means of transmitting these micro-organisms in adequate numbers to—

(3) *Soil.*—The susceptible tissues of the susceptible individual.

b. When these three primary factors are present and operative together, a case of communicable disease will arise. As often as this chain of factors is in conjunction so often will cases of communicable disease arise, an outbreak, an epidemic,

or a pandemic ensuing. The sum total effect of these factors giving rise to communicable disease at a given time and place may be termed the *dispersibility* of that disease for that time and place. As the disease spreads the number of reservoirs will increase and, other things being equal, the cases will multiply in geometric progression. The three primary factors are, however, mutually dependent, and if one factor is totally absent the chain is broken and the number of cases will fall.

■ 12. ESTABLISHMENT OF QUARANTINE.—The establishment of quarantine measures at a military station will be made by the commanding officer, when necessary, upon recommendation of the surgeon. Absolute quarantine of large bodies of troops will be instituted only when a disease of a serious nature exists in a command or threatens to become widely disseminated therein. Ordinary contacts will be held in working quarantine, and will be subjected to one or more careful physical inspections daily in order that early cases and suspects may be detected. In the control of certain communicable diseases all quarantine measures may be dispensed with, reliance being placed upon careful physical inspections conducted at intervals to insure detection of cases in their incipiency. The special quarantine measures applicable to the various diseases will be found in AR 40-210 to AR 40-240, inclusive.

■ 13. OBSERVATION OR DETENTION CAMPS.—Observation or detention camps for incoming recruits will be established at stations when necessary. Recruits arriving in groups or individually at frequent intervals will be detained in these camps for observation during a period of time sufficient to insure detection of acute communicable diseases contracted prior to arrival, thereby preventing their introduction into the command. The status of personnel held under observation will ordinarily be that of working quarantine. They will be carefully inspected by a medical officer at least once a day for the detection of disease. The minimum period of observation will be 2 weeks. In case recruits not known to have been exposed recently to a communicable disease of a serious nature are joining a command at infrequent intervals and in small numbers, they may be assigned directly to organizations, provided

that they report to the unit surgeon once a day during a period of at least 2 weeks for examination. In large commands receiving great numbers of recruits, quarantine camps may be necessary for the segregation of carriers, certain known contacts, and suspected cases of communicable diseases.

■ 14. OTHER MEANS OF PREVENTING COMMUNICABLE DISEASES.—

a. Control of transmitting agencies.—The control of disease through the control of transmitting agencies is accomplished by so modifying certain environmental factors as to prevent the transmission of the causative agents of disease. This method of disease control involves, for example, the purification of water supplies, the control of disease transmitting insects, the proper disposal of infected wastes, or the correction of housing defects. The methods to be employed to control transmitting agencies are discussed in detail in succeeding chapters.

b. Immunization.—Immunization is practiced routinely in the control of typhoid and paratyphoid fevers, smallpox, and tetanus. Where indicated, it may be used in the control of diphtheria, cholera, or plague. Artificial immunization does not confer permanent, absolute immunity to the extent of rendering a group completely nonsusceptible to the disease concerned. Thus, while immunization against typhoid fever will render the greater proportion of a group immune for the time being against a moderate dose of the infection, it does not protect all individual members of the group against continued massive doses nor does the immunity last for an indefinite period of time without further vaccination. Artificial immunization should be employed in the control of these diseases in conjunction with and for the purpose of augmenting the control of transmitting agencies. In the control of smallpox, artificial immunization is the only control measure of practical value and must be repeated at intervals to maintain a protecting degree of immunity.

c. Treatment as a preventive measure.—Early or prophylactic treatment may be employed in the control of certain diseases to prevent the development of symptoms. Thus malaria may be controlled by prophylactic treatment with quinine or atabrine during a period of exposure to the bites of infected mosquitoes, or venereal disease can be prevented

by the use of chemical prophylaxis immediately after exposure to infection.

d. Discipline and physical training.—(1) Military discipline insures the cooperation of the individual in the enforcement of disease prevention and health promotion procedures, and is also an important factor in securing uniformity in the employment of health measures throughout a command. The success of many disease control procedures depends wholly or in part on the cooperation of the officers and enlisted men, that is, on the discipline of the command. The employment of chemical prophylaxis in the control of venereal diseases, the use of mosquito bars to protect the troops from the bites of infected mosquitoes, or the maintenance of proper air conditions by window ventilation are some of the many measures in the enforcement of which discipline plays an all important role.

(2) Military discipline and physical training are in a sense synonymous, in that one cannot be attained without the other. Aside from any question of specific immunity to disease, the trained soldier is more resistant to infection than the recruit. To recruits, generally, the military environment is strange and at times depressing; they are unaccustomed to the physical exertion incident to military training, and they react quickly and unfavorably to cold and exposure. The trained man does not become unduly fatigued by the performance of military work, and he is able to withstand exposure to cold without excessive loss of body heat. These factors, together with the general nonspecific resistance to infection conferred by continuous close contact with others, tend to render the trained soldier less susceptible to disease than the raw recruit.

■ 15. STATISTICAL CHARTS AND REPORTS.—Surgeons of stations and commands are responsible for the collection, tabulation, and graphical presentation of information concerning the incidence of communicable diseases. Tables and charts showing the movement of communicable diseases in commands will be kept available at all times for inspection by commanding officers and inspectors. When rates are in excess of the normal average every effort will be made to determine and remove the causes.

SECTION II

RESPIRATORY DISEASES

■ 16. CLASSIFICATION.—The following diseases are known to be or are strongly suspected of being transmitted, in most instances, by the discharges from the respiratory tract:

Measles, mumps, diphtheria, scarlet fever, the common respiratory diseases (coryza, acute laryngitis, acute tonsillitis, and acute bronchitis), influenza, the pneumonias, epidemic meningitis (cerebrospinal), pulmonary tuberculosis, whooping cough, plague, and poliomyelitis.

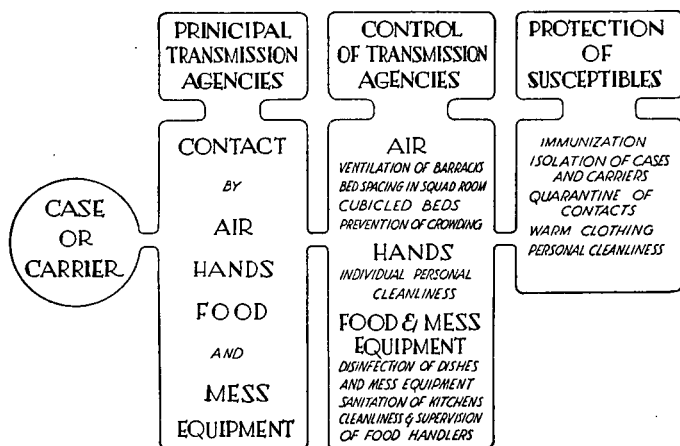

FIGURE 1.—General factors in the control of respiratory diseases.

■ 17. PREVENTIVE MEASURES.—*a. General.*—Commanding officers must devote particular attention to the enforcement of the following general measures for the control of any one of the diseases of this group:

(1) *Allowance of more than the authorized floor space in barracks and tents when practicable.*—Crowding and the consequent close contact between infected persons and non-immunes are most important factors in the spread of respiratory diseases. The most dangerous crowding is that which

occurs between the sleeping occupants of squad rooms. This crowding must be minimized in one or more of the following means:

(a) By utilizing all available space including tentage (if weather permits) so that individuals will not be in close contact.

(b) By constructing cubicles either with screens, sheets, or shelter halves. A cubicle screen should extend to not less than 2 feet nor more than 4 feet above the surface of the bed at the head of the bed.

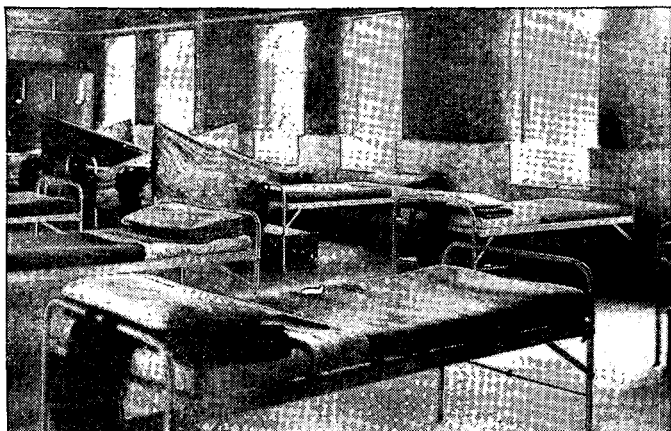

FIGURE 2.—Method of constructing cubicles in squad rooms by the use of shelter tent halves with head and foot arrangement of beds

(c) By proper bed arrangement so that the heads of individuals in adjacent beds will be as far apart as possible. This may be done by head to foot sleeping and by staggering beds. Under average conditions a minimum of 60 square feet of floor space should be allotted for each bed exclusive of that occupied by furniture or fixtures, other than the bed and foot locker. Calculation of minimum floor space should not include any that extends to a distance of more than 4 feet from either end of the bed. In an emergency the minimum floor space may be reduced to 50 square feet per bed provided

ventilation is adequate. If sides of beds are less than 5 feet apart, the beds should be so arranged that the head of each bed is opposite the foot of the adjacent bed.

It is best to limit the number of beds to a room by having a number of small rooms, rather than one large one.

The standard pyramidal tent has a floor space of approximately 250 square feet. Under average conditions not more than six men should be housed in one tent and in the presence of an epidemic of respiratory disease not more than five.

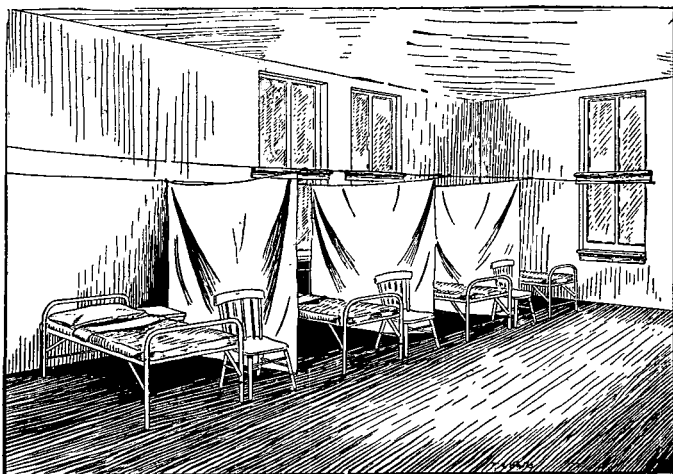

FIGURE 3.—Cubicles made by hanging sheets between beds. This method is usually preferred in hospital wards.

(2) *Proper ventilation of barracks and tents.*—(a) For practical purposes the existing air conditions are determined by the temperature as shown by a thermometer and the effects of the air on the senses. Overheating is normally an evidence of poor ventilation. Lack of freshness when a room or tent is first entered also indicates improper ventilation.

(b) Under average conditions, and when there is no considerable difference between outdoor and indoor temperatures, squad rooms which provide 600 to 720 cubic feet of air space

per man will require at night from 1,800 to 2,200 cubic feet of fresh air per man per hour or three changes per hour. During the day a much smaller volume is required since only a few men are ordinarily in the room.

(c) Wind velocities of about 4 feet per second will produce definite drafts.

(d) Window ventilation is the simplest form of ventilation. Windows should be opened from the top on the windward side and from the bottom on the opposite side.

(e) It is essential that squad rooms and tents be properly ventilated. In order to enforce proper ventilation at night, especially in cold weather, frequent inspections must be made by an officer or noncommissioned officer.



FIGURE 4.—Ventilation of squad rooms showing method of arranging window openings. A—Inlet. B—Outlet

(3) *Issue of suitable clothing.*—Fatigue or chilling will in many instances lower the resistance of the individual. Exposure to inclement weather and exercise resulting in excessive fatigue should be avoided. Sufficient bedding to prevent chilling of men while asleep must be issued.

b. Special.—(1) *Isolation of cases.*—Since the patient with the disease is the greatest source of danger to susceptible members of the command, it is of vital importance that he be removed from contact with other individuals and hospitalized at the earliest possible moment. The fact that many

diseases of this group are most infective in the earliest stages of illness renders imperative their early recognition and immediate hospitalization.

(2) *Physical inspections.*—Upon the appearance of the first recognized case of any of these diseases (except the common respiratory infections), the command or such part thereof as the surgeon may recommend (ordinarily contacts) should be inspected at least daily and during the presence of an epidemic twice daily until the disease in question is eradicated from the command. Special attention must be at all times directed to the recognition of cases in the early stages.

(3) *Hospitalization of suspects.*—All cases of illness with catarrhal symptoms accompanied by a temperature of 100° F. or above will be considered as suspects and hospitalized as such for observation. The retention and treatment of sick men *in quarters* must not be practiced when epidemics prevail. Under these circumstances, unit commanders and noncommissioned officers will send at once to a medical officer any soldier who may become ill between the hours of the general inspections.

(4) *Control of suspects.*—The exanthemata contacts of the command should be separated into two groups, one composed of susceptible individuals and the other of nonsusceptible persons. When this separation has been accomplished, control measures such as physical examinations, working quarantine, or other restrictions will be especially applicable in the management of the susceptible groups.

(5) *Immunization.*—With the exception of diphtheria and scarlet fever, the present status of scientific knowledge concerning immunity against the diseases of this group does not permit of the general application of routine specific methods of immunization.

(6) *Measures applicable to special diseases.*—For special measures applicable to prevention of individual diseases of this group see TM 8-255 (now published as Army Medical Bulletin, No. 23) and AR 40-220.

SECTION III

INTESTINAL DISEASES

■ 18. GENERAL.—The intestinal diseases as a group are transmitted from person to person by food and water, the infective agents being disseminated in the excreta of cases or carriers. The causal organisms are introduced into water with the infected excreta, and into food through the medium of hands contaminated with infected material, by water, by contaminated dishes and utensils, by flies, or by direct contact with excreta. Occasionally intestinal diseases may be transmitted by contact, that is, by the direct transference of infected excreta by the hands or by fomites to the mouth without the intervention of food or water as an intermediate agency. However, under average conditions, such contact is a relatively unimportant factor in the transmission of most of the intestinal infections among troops.

■ 19. CLASSIFICATION.—The important diseases belonging to this group are—

Typhoid fever.	Cholera.
Paratyphoid fever.	Helminthic infestations.
Common diarrhea.	Undulant fever.
Bacillary dysentery.	Food infection.
Protozoal dysentery.	Botulism.

■ 20. GENERAL IMPORTANCE AND PREVALENCE.—*a.* Intestinal diseases are of great potential importance to a military force. However, measures are available by which the incidence of intestinal diseases can be greatly reduced below that which would and does occur in situations where the spread of these infections is inadequately controlled.

b. As sources of infection are constantly present in military organizations, and in the civilian populations with which the troops are in contact, any relaxation in measures for the control of intestinal infections will almost inevitably be followed by the occurrence among troops of some of these diseases in epidemic form. The prevalence of intestinal diseases and their importance to a military force are, therefore, to a very considerable degree dependent on the extent to which

suitable control measures are enforced. In this respect, intestinal diseases differ markedly from such respiratory infections as influenza or common colds. In many instances, the latter cannot be completely controlled by any practical procedure, while uncontrollable epidemics of intestinal diseases seldom if ever occur in military forces under normal conditions.

c. While one attack of certain of the intestinal diseases, particularly typhoid, will usually confer permanent immunity, troops generally have a high group susceptibility to intestinal diseases.

d. The group of diarrheal diseases which are classified as common diarrhea are from a military viewpoint, under ordinary conditions, the most important of the intestinal diseases, largely because of their influence on the noneffective rate. This group includes those conditions diagnosed as enteritis, colitis, or diarrhea, which in many instances are probably actually mild dysenteries or food infections. These conditions tend to occur as small explosive epidemics and incapacitate a relatively large number of men before control measures can be made effective. On the other hand, typhoid is of relatively minor importance, but only because it can be controlled by available and practical control measures.

■ 21. GENERAL CONTROL MEASURES.—a. The control of intestinal diseases is based on the control of environmental conditions with a view to preventing the transmission of the causal organisms by water and food. General measures for the control of intestinal diseases include water purification, food protection and control, waste disposal, and control of the housefly. Each of these subjects is considered in detail in succeeding chapters.

b. Group quarantine of contacts is not as a rule effective or of value in the control of intestinal diseases. It may, however, be employed in the control of cholera. Cases of intestinal disease may be isolated as individuals or in groups during the infectious stage of the disease. Carriers may be quarantined or their activities restricted in order to prevent the contamination of food or water or the transmission of infection by contact.

c. Food handlers are particularly important in the transmission of the etiological agents of many of the intestinal diseases, in that they have many opportunities to transfer the infective organisms to the food or eating utensils of other persons. All food handlers should be required to cleanse their hands thoroughly before starting work in a kitchen or mess and after each visit to a latrine. Preferably, they should disinfect their hands by washing them in a weak solution of cresol and drying them in the air without wiping.

d. Prophylactic immunization is employed as a routine measure in the control of typhoid fever, and may at times

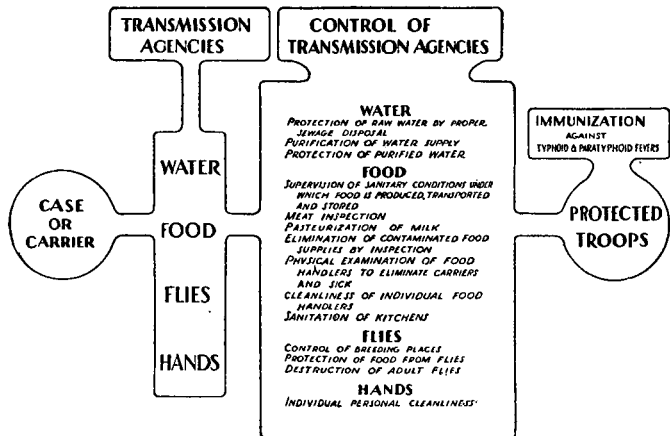

FIGURE 5.—General factors in the control of intestinal diseases.

be utilized in the control of other intestinal diseases, particularly paratyphoid fever, cholera, and bacillary dysentery. See AR 40-225.

■ 22. **CONCURRENT AND TERMINAL DISINFECTION.**—*a.* Concurrent disinfection should be practiced in the care of patients having an intestinal disease, in order to prevent the transmission of the causal organisms by contact or through contamination of food or water which is to be consumed by others. It is essential that the feces and urine be thoroughly

disinfected and properly disposed of. Any articles which might be soiled by excreta should be disinfected or burned.

b. Intestinal discharges may be disinfected by adding 2 percent cresol solution or 10 percent formaldehyde and allowing them to stand for at least 1 hour. The quantity of disinfectant used for this purpose should be equal to at least twice the volume of the material to be disinfected. Urine may be disinfected by the addition of sufficient cresol to make an approximate 2 percent solution. Mercuric chloride in amounts sufficient to make a 1:1,000 solution may also be used.

c. Patients should have separate dishes and eating utensils which should be disinfected by boiling after use. Any food which has been served to patients but not consumed should be destroyed or disposed of in such a manner that it will not convey the infection to others.

d. All sheets, pajamas, towels, or similar articles used by the patient should be disinfected by boiling or by immersion in a 2- or 3-percent cresol solution.

e. Medical officers, nurses, and attendants should exercise care to prevent the transmission of infection by the hands or clothing.

f. Terminal disinfection should consist generally of thorough cleaning of the room or ward and disinfection of the bedding.

SECTION IV

INSECT-BORNE DISEASES

■ 23. GENERAL.—The insect-borne diseases are those transmitted by biting or bloodsucking insects. In order for these diseases to spread, three things are necessary:

- a.* Reservoir of infection.
- b.* The specific vector.
- c.* Susceptible individuals.

■ 24. CLASSIFICATION.—The following insect-borne diseases are of particular interest to the Army:

<i>Disease</i>	<i>Principal vector</i>
Malaria.....	Anopheles mosquito (a number of species).
Yellow fever.....	Aedes egypti.
Dengue.....	Aedes egypti and albopictus.
Tularemia.....	Fly, tick, louse, and flea (also contact with infected material).
Rocky Mountain spotted fever.....	Tick.
Relapsing fever.....	Louse and tick.
Typhus fever, epidemic.....	Body louse.
Typhus fever, endemic.....	Flea.
Trench fever.....	Body louse.
Plague.....	Rat flea and others.
Filariasis.....	Mosquito principally.
Encephalitis.....	Aedes mosquitoes and possibly other insects.

■ 25. TRANSMISSION.—There are two types of insect transmission of disease:

a. Mechanical.—Virus undergoes no change in the insect host but is transmitted by a specific insect in the form it is taken from the infected person. No period of incubation in the insect.

b. Biological.—Virus or parasite undergoes certain changes in the insect host before it becomes infective. This is the extrinsic period of incubation as seen in malaria and yellow fever.

■ 26. OBJECTS OF PREVENTIVE MEASURES.—The various preventive measures (chs. 7, 8, 9, and 10) to be employed must be directed toward the accomplishment of the following objects:

a. Protection of—

(1) Patients and carriers of the causative agents from the bites of insects capable of transmitting such agents.

(2) Healthy persons from the bites of insects infected with the causative agents.

b. Eradication of—

- (1) Insects capable of transmitting the causative agents.
- (2) Causative agents from the persons of patients and carriers. For further details see AR 40-230.

SECTION V

VENEREAL DISEASES

■ 27. **PREVALENCE.**—Under average conditions, venereal disease is by far the most important cause of noneffectiveness among troops. The prevalence of venereal disease among civilian populations is difficult to determine. Studies have shown that from 60 to 75 percent of prostitutes in the United States present demonstrable evidence of venereal disease. Actual incidence is probably very much higher.

■ 28. **GENERAL CONTROL MEASURES.**—Measures for control fall generally into two groups, the first is to attempt prevention to exposure, and the second, to prevent the development of the disease in the exposed individual. The measures employed to control exposure consist of the control of prostitution, educational and recreational measures, and regulations. Mechanical and chemical means of prevention play a very important part in the control of these diseases should exposure take place. The discipline, training, and administration of organizations are the basic factors and are more important in the control of venereal diseases than in the control of any other class of diseases. (See AR 40-235.)

■ 29. **MECHANICAL PROPHYLAXIS.**—*a.* The condom affords the only practicable mechanical protection against venereal infection. Where properly used, the condom is effective in preventing gonorrheal infection and, to a less extent, syphilis, chancroid, or lymphogranuloma inguinale. The gonococci are infective only in the urethra which is protected by the condom, while the infective agents of the other three venereal diseases may be inoculated into the skin or tissues of the genitals or adjacent body surfaces that are unprotected by the condom.

b. Post exchanges are required to stock condoms, the composition and quality of which will be prescribed by the commanding officer upon the recommendation of the surgeon.

(See Cir. Letter 4, Jan. 8, 1940.) Chemical prophylaxis should be given even when a condom has been used.

■ 30. CHEMICAL PROPHYLAXIS.—Chemical prophylaxis consists of the application of disinfectants for the purpose of destroying the infectious agents of venereal disease immediately after exposure and thus preventing invasion of the tissues and the consequent development of the disease. Chemical prophylaxis may be applied at a prophylactic station or from an individual packet. Application at a prophylactic station is by far the better method as it is most effective when properly applied. Venereal prophylactic stations are as a rule established wherever troops are assembled. Soldiers should be impressed with the fact that the sooner after exposure the prophylaxis is given the more effective the result.

■ 31. OPERATION OF PROPHYLACTIC STATION.—*a.* The station should be in charge of well-trained attendants and should be easily accessible to the troops. At times it may be advantageous to establish stations in adjacent civilian communities. Frequent inspections should be made by the responsible medical officer.

b. A high degree of cleanliness and orderliness is essential to success in the operation of a prophylactic station. A prophylactic station should be similar in this respect to an operating room in a hospital.

c. The station should be so arranged that the prophylactic treatment can be given in private. All boisterousness, joking, or loafing should be strictly prohibited. Otherwise, men who should receive the prophylaxis will risk infection rather than report at the station.

■ 32. METHOD OF APPLYING VENEREAL PROPHYLAXIS.—The minor details of the technique of administering the venereal prophylaxis may vary somewhat but the same basic methods are employed throughout the Army. The individual reporting for prophylactic treatment should first be thoroughly examined for venereal disease. He should urinate if possible immediately prior to the beginning of the treatment. The genitals and the contiguous surfaces of the thighs and abdomen are then thoroughly washed with soap and water. The soap is a disinfectant and also serves to remove substances

which would interfere with the action of disinfectants which are to be subsequently applied. The same area is then bathed and the soap removed with a 1:1,000 solution of mercuric chloride. From 4 to 6 cc of a 2 percent solution of protargol are then injected into the urethra and retained for 5 minutes. Finally, calomel ointment is rubbed thoroughly over all surfaces of the genitals. A paper towel or napkin should be used to protect the clothing. All records should be completed at the time the prophylaxis is given.

■ 33. **INDIVIDUAL CHEMICAL PROPHYLAXIS.**—The individual prophylaxis has been found to be of great value if properly applied, especially if a prophylactic station cannot be reached until a considerable time after exposure or where men are going on furlough or pass to places where prophylactic stations are not available. These packets contain as a rule calomel ointment to which 1 to 3 percent of phenol has been added.

■ 34. **TREATMENT AS A CONTROL MEASURE.**—The prompt and adequate treatment of persons having venereal diseases until they are no longer infectious is a most effective method of controlling the spread of venereal diseases in the civil population. It is essential that soldiers having venereal disease do not serve as sources of infection in civil communities, and, consequently, all those who contract a venereal disease should be restricted to the station or camp until the infectious stage of the disease is past.

CHAPTER 3

WATER

	Paragraphs
SECTION I. Responsibility for water supply.....	35-36
II. Water characteristics and requirements.....	37-39
III. Sources.....	40-42
IV. Purification.....	43-48
V. Water reconnaissance.....	49-53

SECTION I

RESPONSIBILITY FOR WATER SUPPLY

■ 35. **QUARTERMASTER CORPS.**—The Quartermaster Corps is responsible for the construction, maintenance, and operation of water-purification plants and distributing systems and for the quantity and quality of the water supply at all stations and permanent or semipermanent installations in time of peace, and in the zone of the interior in war. The Corps of Engineers is responsible for all water supplies in the theater of operations except, at times, in the case of smaller units where it may be impracticable for the engineers to furnish water.

■ 36. **SANITARY CONTROL BY MEDICAL DEPARTMENT.**—The Medical Department is charged with the responsibility for making surveys, inspections, and examinations of water supplies, and such recommendations as may be necessary to protect the health of the troops. The Medical Department cooperates with the Quartermaster Corps or the Corps of Engineers, as the case may be, in all phases of water-purification work. The scope of the sanitary control exercised by the Medical Department includes the following measures:

a. Sanitary surveys of the source or sources of proposed water supplies, or extensions of existing supplies, for actual or potential sources of contamination, and for adequacy of supply insofar as quantity will affect the health of the troops.

b. The study of plans for proposed water-purification

works and other appliances or installations to be utilized in the treatment of water, with particular reference to sanitary features, prior to their final adoption.

c. Sanitary surveys and inspections of existing water-supply systems, including sources, installations, appliances, the distributing system, and procedures utilized in the treatment of the water.

d. The bacteriological and chemical analysis of water as delivered to the troops.

e. The technical supervision of the procurement and purification of the water supply where emergency measures are necessary, such as the use of the water sterilizing bag (Lyster bag).

SECTION II

WATER CHARACTERISTICS AND REQUIREMENTS

■ 37. **TURBIDITY.**—Turbidity may be estimated in the field with the United States Geological Survey turbidity rod. In laboratories the Hellige turbidimeter is used. Ordinarily, these procedures cannot be carried out, so that inspection of the water will have to suffice. Troops will object to drinking a highly turbid water even if they are assured of its freedom from pathogenic organisms. A turbidity of 5 parts per million is barely noticeable in an ordinary drinking glass; from 10 to 15 parts per million will render the water objectionable; 100 parts give it a decidedly muddy appearance; while 500 to 1,000 parts render it practically opaque.

■ 38. **HARDNESS.**—The hardness of water is due to the presence of the soluble bicarbonates, sulphates, chlorides, and nitrates of calcium and magnesium. These chemicals form deposits in boilers and pipes of steam-heating and hot-water plants and appliances, decreasing their efficiency and necessitating more frequent cleaning. They also form insoluble salts with soap and impair the value of the water for domestic or laundry purposes.

■ 39. **WATER REQUIREMENTS OF TROOPS.**—*a.* During the World War the National Army cantonments consumed 55 gallons of water per capita per day and the tent camps of National

Guard divisions 30 gallons. These amounts are very greatly increased in permanent camps and stations.

b. Where water must be distributed by trucks or water carts, particularly in temporary camps, about 5 gallons per man per day are required for drinking, cooking, and washing.

c. If watering troughs for animals are supplied, about 10 gallons per animal per day are required.

d. In bivouac or on the march, troops will require 2 gallons and animals 10.

e. In combat, under average conditions, physical efficiency can be maintained for a period of not more than 3 days if from 3 pints to 2 quarts of water per day are supplied to each man. Under like conditions animals require from 3 to 5 gallons per day.

SECTION III

SOURCES

■ 40. SURFACE OR GROUND.—The remote source of all water is the rain or snow which falls upon the earth. This water occurs in nature as surface water (ponds, lakes, or streams) or as ground water (below surface and not in contact with atmosphere). Ground water which is obtained from wells or springs has been subjected to a certain amount of filtering process and may or may not be pure. When obtained from beneath the first impervious stratum it is usually pure.

■ 41. ESTIMATING STREAM FLOW.—Water for troops in the field is usually surface water obtained from streams. As the quantity of water is important it may be necessary to measure stream flow. For a rapid and approximate method the velocity-area method is used. A section of the stream is selected having a fairly uniform width and depth which are determined by measuring. The velocity of the flow through the measured section is ascertained by observing the time required for the current to carry a surface float from the upper to the lower boundary of the section. The mean velocity of the stream is about four-fifths of the surface velocity. The rate of flow in cubic feet per second would be—

$$\frac{D \times W \times L}{V}$$

Where D =average depth of the water in the measured section.

W =the average width of the measured section.

L =length of measured section.

V =mean velocity expressed as the number of seconds required for the measured section to empty.

The rate of flow in gallons per second would be the number of cubic feet per second multiplied by the number of gallons in a cubic foot, which is 7.48. For example, given a section of a stream which has an average width of 4 feet, an average depth of 6 inches, and is 25 feet long, through which it requires 20 seconds for the current to carry a surface float. As the mean velocity is four-fifths of the surface velocity, 25 seconds would be required to empty the 25-foot section, or in other words, V in this problem is 25.

$$\begin{aligned} \text{Rate of flow} &= \frac{4 \times 0.5 \times 25}{V} \\ &= \frac{4 \times 0.5 \times 25}{25} \\ &= \frac{50}{25} \\ &= 2 \text{ cubic feet per second.} \end{aligned}$$

$$= 2 \times 7.48 \text{ or } 14.96 \text{ gallons per second.}$$

■ 42. YIELD OF WELLS.—The rate of flow of water into a well, or the yield of the well, may be roughly determined by reducing the depth of the water a measured distance, noting the time required for the water to reach again a given level which should be below the original level, and calculating the capacity in gallons of the space between the two levels. The quantity of water expressed as cubic feet in any given depth of a circular well is determined by multiplying the square of the diameter of the well in feet by 0.7854 and multiplying the figure thus obtained by the depth of the measured section in feet. The content in gallons is determined by multiplying the number of cubic feet by 7.48, which is the number of gallons in one cubic foot. For example, given a circular well 3 feet in diameter in which the normal water level has been reduced 2 feet by pumping, and assuming that the water rises 1 foot

in 30 minutes after the pumping has ceased, the yield is computed as follows:

$$\begin{aligned} \text{Yield} &= 0.7854 \times 3^2 \times 1 \times 7.48 \\ &= 0.7854 \times 9 \times 1 \times 7.48 \\ &= 7.07 \times 1 \times 7.48 \\ &= 7.07 \times 7.48 \\ &= 51.9 \text{ gallons in 30 minutes.} \end{aligned}$$

If the yield is 51.9 gallons in 30 minutes, the yield for 24 hours will be 48 times 51.9, or 2,491 gallons. If, under the conditions of actual use, the pumping rate is greater than during the test, the yield will be somewhat more as the water will be drawn from a larger area. The depth of the water-bearing stratum and the rate of pumping are factors which must be considered in making an accurate estimate of the yield, but can be ignored in making practical field tests.

SECTION IV

PURIFICATION

■ 43. **PURIFICATION OF TEMPORARY WATER SUPPLIES.**—In stations and semipermanent camps, water works may be installed similar to those used in towns and municipalities. The water supply for moving troops, for temporary camps and installations, and for troops in the theater of operations must be purified under conditions which do not permit the installation of permanent water purification works. The agencies employed for this purpose are temporary or improvised facilities installed by engineer regiments, troops, or units, and the water sterilizing bag which is included in the equipment of each company or its equivalent.

■ 44. **ENGINEER WATER SUPPLY EQUIPMENT.**—Engineer regiments (combat) have certain pumps and canvas tanks which may be used for obtaining and storing water. In addition they are allowed a mobile water purification unit which is mounted on a 2½-ton truck. The water supply battalion (an Army unit) is equipped with 9 mobile water purification units and 135 water tank trucks. Engineer battalions (combat) are not equipped with water purification apparatus except the water-sterilizing bag which is issued to all troops.

■ 45. WATER-STERILIZING BAG (LYSTER BAG).—The water-sterilizing bag is made of heavy canvas or rubberized cloth and has a capacity of 36 gallons. These bags are issued to all organizations at the rate of one for each 100 men or fraction thereof. The water-sterilizing bag is used primarily for the *distribution* of water previously disinfected by a water-purification unit or otherwise. Water can be purified in a water-sterilizing bag only by chlorination, and owing to the difficulty of chlorinating small quantities of water having a

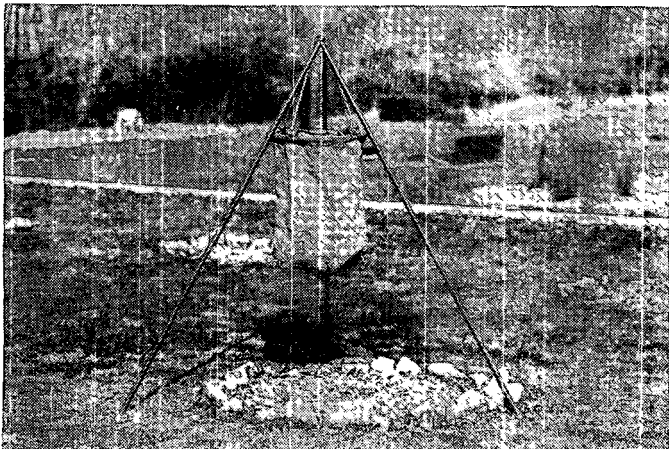

FIGURE 6.—Water-sterilizing bag suspended from tripod.

varying organic content, it is used for the disinfection of water only when no other facilities for obtaining purified water are available. The purification of water in the sterilizing bag is essentially an emergency measure. The proper disinfection of water is essential in preventing disease among troops operating in the field. Where the water-sterilizing bag must be used for this purpose, the chlorination of the water should be under the direct supervision of Medical Department personnel. Ordinarily, however, as the disinfection of the water is a function of the company concerned, the actual work of chlorination is delegated, ultimately, to the personnel

of the company kitchen. Consequently, the chlorination of the water supply for the unit concerned is frequently left to the kitchen police who, as a rule, are untrained in the technique of water chlorination. As a result, the water may be underchlorinated and therefore contaminated, or overchlorinated to a degree which renders it nonpotable.

■ 46. TECHNIQUE FOR STERILIZING WATER IN WATER-STERILIZING BAG.—The water should be as clear as possible. Clarification may be aided by allowing the water to settle in a barrel or galvanized can and then decanting or straining. The steps then used are as follows:

a. Fill the bag to the 36-gallon mark, or if this mark is not present, to within 4 inches of the top.

b. Draw a small quantity of water through one of the faucets into a canteen cup.

c. Break an ampule of the calcium hypochlorite into the water in the cup and with a clean stick rub it into a thin paste containing no visible lumps. Then add sufficient water to fill the cup two-thirds full.

d. Empty the solution of calcium hypochlorite in the cup into the water in the bag and stir thoroughly with a clean stick which is long enough to reach the bottom of the bag. Then flush out each of the faucets.

e. After the calcium hypochlorite has been in contact with the water in the bag for at least 10 minutes, wash out the faucets by allowing a small amount of water to run through it onto the ground. Then fill a clean cup about two-thirds full of water from one of the faucets.

f. Add one cc (approximately 15 drops) of the orthotolidine solution to the water in the cup and allow it to stand for about 5 minutes so that the color will develop. Because of the reflected light, the color of the water in the cup is more intense than it would be if the same water were placed in a glass tube. A well-marked yellow color indicates that the water contains about the proper amount of residual chlorine. An orange color is evidence of overchlorination.

g. If no residual chlorine is present at the end of the 10-minute contact period, the chlorination procedure as outlined above is repeated. Where it is suspected that the calcium hypochlorite is inert, a preliminary test with orthotoli-

dine should be made immediately after the addition of the calcium hypochlorite solution to determine if the water contains any free chlorine at that time.

h. As a factor of safety, the water should be allowed to stand for 20 minutes after the end of the contact period, or for 30 minutes after the addition of the calcium hypochlorite, before being used for drinking purposes.

i. The calcium hypochlorite now furnished is the kind known as "Grade A" hypo., and contains about 70 percent available chlorine. This is the equivalent of 2.5 parts per million free chlorine when added to a bagful of water. The organic matter in most water supplies in the field will utilize a great deal of this free chlorine so that the residual chlorine will be reduced to 0.5 to 2 parts per million. If there is little or no organic matter present only a fractional part of the tube of hypochlorite should be used. When there is any doubt as to the purity of water furnished a unit it should be chlorinated.

■ 47. OTHER EMERGENCY MEASURES.—*a.* If water sterilizing bags are not available, the water may be sterilized in the unit water cans, clean, galvanized iron cans, pails, or barrels. A proportional amount of calcium hypochlorite is used and the method of chlorination is the same as with the water sterilizing bag.

b. If larger containers are not available, canteens may be utilized. One-half gram of grade A calcium hypochlorite is dissolved in a canteen of water. This strong solution is then used to purify water in other canteens. The cap of a canteen is used as a measure and 1 canteen capful of the strong solution is added to each canteenful of water to be treated. The water should be well shaken and not used until 30 minutes after chlorination.

c. Iodine may be employed as a disinfectant instead of chlorine. Ten cc of the tincture of iodine are used to disinfect a water sterilizing bagful of water (36 gallons). Two or three drops are used to disinfect a canteenful of water. Iodine is expensive and the supply would be limited during war. Further, in the treatment of some waters, iodine is apparently much less effective than chlorine. The water

should not be used until 30 minutes after the iodine has been added.

d. If calcium hypochlorite or iodine is not available, water may be purified by boiling for 10 minutes. This method should not be used, if avoidable, by the individual soldier, but the water should be boiled under supervision in comparatively large quantities and then distributed to the troops. Water may be boiled in galvanized iron cans if they are available. Aeration of the water by pouring it through the air from one receptacle into another will eliminate the flat taste due to boiling.

48. WATER DISCIPLINE ON THE MARCH.—a. In marching 1 mile, a fully equipped soldier generates 90 calories, which will require 180 cc of water to dissipate as heat. For 3 miles, or 1 hour, 540 cc of water are required, which is a little over 1 pint (473 cc). For 2 hours the soldier will lose 2 pints or the equivalent of 1 canteen of water. There are too many factors entering into the water requirements to dogmatize or standardize the fluid intake too rigidly. It is safe to assume that the soldier starts the march with about 1 pint of extra fluid in his stomach. The following diagram shows the ordinary consumption of water on a day's march:

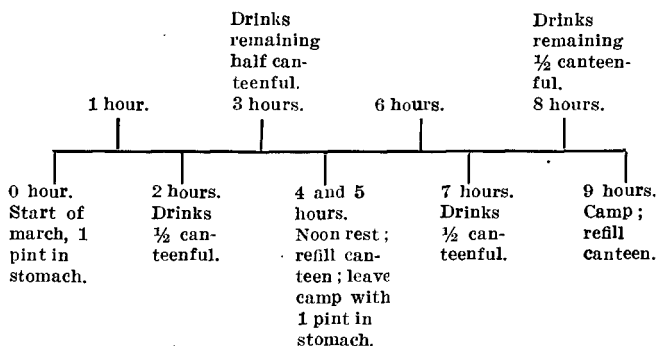

b. Water should be chlorinated and canteens filled the night before a march is started. Chlorinated water in company cans should be available at the noon halt.

SECTION V

WATER RECONNAISSANCE

■ 49. GENERAL.—A source of water supply for moving troops, for troops in the theater of operations, or for forces engaged in occupational work must frequently be located by reconnaissance. Only in extreme cases where there is a marked shortage or an absence of water will the water supply be a governing factor in the movement of troops or in the conduct of military operations. Ordinarily, the military mission will not be influenced by the availability of a water supply, and the best source of water from the standpoint of quantity, accessibility, and purity in the area in which the troops are operating, or will operate, must be located by reconnaissance.

■ 50. RESPONSIBILITY FOR WATER RECONNAISSANCE.—*a.* The Corps of Engineers is responsible for the procurement and purification of water for the major units and installations in the theater of operations and is, therefore, responsible for water reconnaissance where such action is necessary.

b. In situations where intestinal disease is, or may become, epidemic or where the the protection of the health of the troops renders it desirable, the Medical Department assists in the conduct of, or makes water reconnaissance, and submits recommendations concerning the procurement and purification of water supplies. In the case of small units and installations or minor forces operating independently, engineer personnel may not be available for this purpose and the responsibility for water reconnaissance will devolve upon the Medical Department personnel attached to such organizations.

■ 51. CONDUCT OF WATER RECONNAISSANCE.—Information as to the location and extent of water supply sources in a given area may be obtained from geologic or topographic maps, from government reports, from the inhabitants, from aerial photographs, or by reconnaissance on the ground. The purpose of a water reconnaissance is to locate a suitable source of supply and determine, if indicated, the quantity of water available from a given source, the time and labor required to

develop it, and the quality of the water, insofar as the quality will influence the purification measures. In scope, the reconnaissance may consist of inspection of an easily accessible and satisfactory supply, a more extensive survey to determine upon the best of two or more unsatisfactory sources or to locate one satisfactory supply, or a study of larger or smaller water works systems.

■ 52. SUMMARY OF POINTS TO BE COVERED AND REPORTED ON IN A WATER RECONNAISSANCE.—The following summary indicates the points that should be covered in the average water reconnaissance. Not all the points given in the summary are applicable in any one situation, while in some instances it will be necessary to secure data not mentioned herein.

a. Location.—Sources and works should be shown on a map or the location given by description.

b. Character of sources.—Well, spring, stream, lake, or pond.

c. Quantity of water available.

Rate of flow of streams.

Rate of flow and capacity of wells.

Rate of flow of spring.

Dimensions and estimated depth of lake or pond and, if indicated, rate of inflow and outflow.

d. Quality of water.

Turbidity.

Color.

Taste.

Result of bacteriological examination, if indicated, and if it is practicable to secure samples and have them analyzed.

e. Source of bacterial contamination.

Character of sources.

Location in relation to water supply.

Control measures indicated.

f. Accessibility.—Accessibility of sources of water to troops by railroad, highway, improvised roads, trails, or hand carry.

g. Wells.

Diameter.

Depth of well.

Depth of water.

Distance from surface of ground to the surface of the water.

Type, condition, and depth of casing or lining.

Kind of soil.

Nature of impervious strata if indicated and ascertainable.

Method of recovering water; i. e., pump, windlass, etc.

h. Spring.

Kind of spring.

Protection provided; i. e., coping, watertight basin, ditching, etc.

i. Streams.

Mean velocity.

Mean width.

Mean and maximum depth.

Nature of stream bed.

Height of banks above surface of water.

j. Existing installations.

Purification facilities—chlorinating apparatus, filters, etc.

Pumps—number, type, size, speed, and capacity.

Engines—type, size, speed, and horsepower.

Electrical equipment.

Storage facilities—type and capacity.

Pipe lines—length, size, and material.

Present condition (description).

k. Proposed developments.









Description.



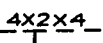



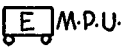



Material available.

Material required.

Time required.

■ 53. MAPS AND CONVENTIONAL SIGNS FOR WATER SUPPLIES.—Wherever practicable, the data obtained by water reconnaissance should be transferred to a map by the use of conventional signs. A map is one of the best means of recording certain parts of such information and transmitting it to others. The following conventional signs may be used for this purpose:

Valves.....	
Air valves.....	
Check valves.....	
Tees (with size).....	
Wyes.....	
Elbows.....	
Laboratory.....	
Mobile purification unit.....	
Pump.....	
Tank and reservoirs (with numbers and capacity).....	

Water point.....	
Water point, animals only (number of animals).....	J  20
Railway water point.....	R. W. P
Railway spill tank.....	R. S. T.
Water works.....	 W. W.
Engineer water supply battalion.....	 W. S.
Well.....	
Spring.....	
Direction of dip.....	
Flowing well areas.....	 Green
Pipe line or aqueduct (diameter may be shown).....	 4"  Blue
Water tank train.....	 W

CHAPTER 4

WASTE DISPOSAL

	Paragraphs
SECTION I. General	54-55
II. Human wastes	56-69
III. Garbage	70-75
IV. Liquid wastes	76-82
V. Manure	83-91
VI. Rubbish	92-94

SECTION I

GENERAL

■ 54. CLASSIFICATION OF WASTES.—*a.* Human excreta (feces and urine).

b. Garbage.

c. Liquid wastes (kitchens, baths, and ablution benches).

d. Manure.

■ 55. RESPONSIBILITY FOR DISPOSAL.—Unit commanders are responsible in their areas for all waste disposal. If the wastes from more than one unit are disposed of in some common manner, the quartermaster is then responsible for the construction, operation, and maintenance of all permanent facilities and installations. This activity, however, is a responsibility of the Corps of Engineers in the theater of operations. The scope of the sanitary control exercised by the Medical Department includes the following activities:

a. The sanitary survey of sites and the study of plans for proposed waste-disposal facilities of a permanent nature.

b. Surveys and inspections of existing permanent waste-disposal installations for defects in construction or operation which are of sanitary significance.

c. The formulation of recommendations relative to the installation of temporary appliances or the adoption of emergency measures for the disposal of waste material inimical to the health of the troops.

- d. The sanitary supervision and inspection of existing temporary or emergency facilities for waste disposal.
- e. The laboratory analysis of sewage and sewage effluents.

SECTION II

HUMAN WASTES

- 56. GENERAL.—In many semipermanent camps or cantonments human feces may be disposed of by a water-carriage system. Should this system discharge into a municipal system the disposal is simplified. More often, however, a sewage-disposal plant has to be constructed. Should this be the case the representative of the Medical Department should familiarize himself with the method of construction and the operation of such a plant, even though it be operated by the Corps of Engineers or the Quartermaster Corps.
- 57. SEATING SPACE.—No matter what type of installation is used there should be sufficient latrine seat spaces to accommodate from 5 to 10 percent of the command at one time. In temporary latrines this requires 2 lineal feet per space. Usually 8 percent of the command are provided for.
- 58. DISPOSAL ON THE MARCH.—During brief halts on the march the men who desire to relieve themselves should fall out, dig a hole with the entrenching tool, piece of stick, or some similar material, and after depositing feces should cover it well with earth. A trench may be dug for use during a halt for a meal.
- 59. DISPOSAL IN BIVOUAC.—In camps of short duration (1 to 5 days) trench latrines are provided. This consists of a trench not more than 1 foot wide and from 18 to 24 inches deep. Earth from the trench is piled at one end and the trenches should be constructed so as to provide 2 feet per man for about 8 percent of the command. No seats are provided, the man straddles the trench and squats over it. Each man covers his deposit with earth from the pile at the end of the trench. Toilet paper rolls may be placed on tent pegs near trenches if the weather is dry; otherwise, toilet paper should be kept dry in a box turned on its side. When the troops depart the trench is filled in after spraying contents well with

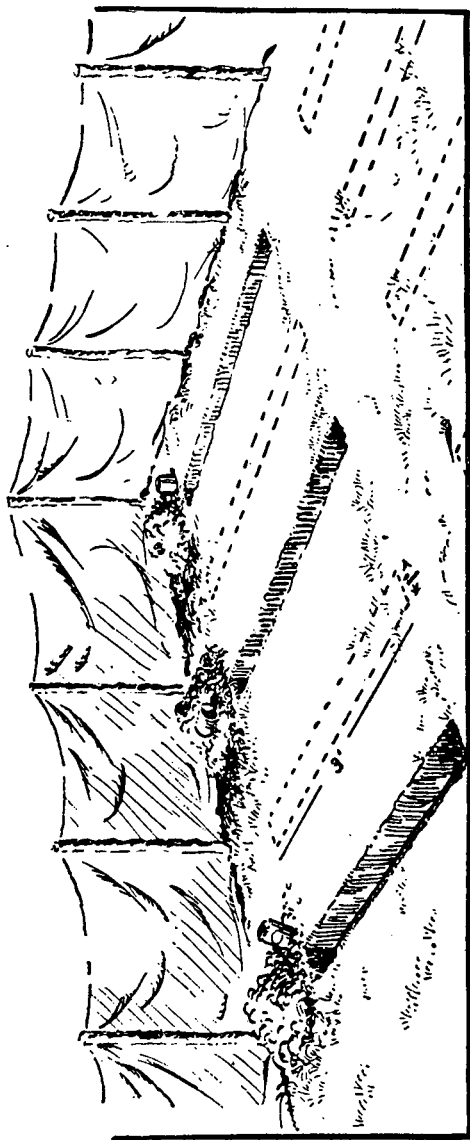

FIGURE 7.—Trench latrine.

crude oil, and if there is a possibility of other troops occupying the site it should be marked.

■ 60, DISPOSAL IN CAMPS.—*a. General.*—Certain kinds of latrines have been found to be best suited for use in military camps. The pit latrine is the type most commonly used. This is an adaptation of the ordinary earthen privy.

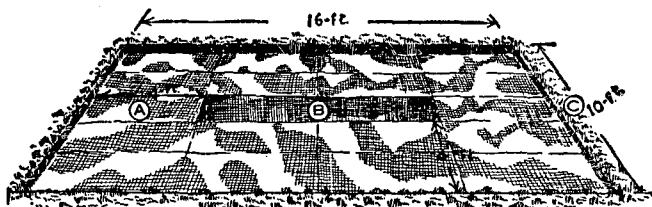

FIGURE 8.—Flyproofing latrine pit. A—Oil soaked burlap extending completely around pit. B—Opening of pit. C—Sidewall of excavation in which burlap is placed.

Size of pit:

Length—8 feet or multiple thereof, as quartermaster latrine boxes are constructed 8 feet in length.

Width—2 feet.

Depth—4 feet for 2 weeks and add 1 foot for each additional week. Usually a maximum of 10 or 12 feet but governed by character of soil.

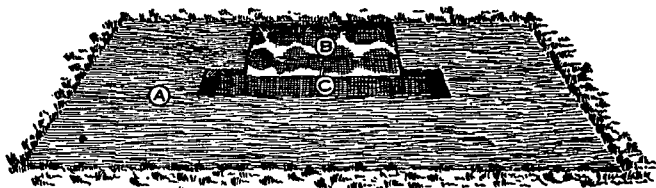

FIGURE 9.—Method of flyproofing latrine pit with oiled burlap. A—Layer of earth replaced and tamped down over oil-soaked burlap. B—Oiled burlap exposed before replacement of earth. C—Opening of pit.

b. Flyproofing.—Excavate an area 4 feet wide completely surrounding the pit to a depth of 6 inches. Cover this area with burlap soaked in crude oil, the burlap being placed so that it hangs down into the pit to a depth of 18 inches. The

earth is then replaced over the burlap and tamped down. If burlap is not obtainable the earth from excavated area may be mixed with crude oil and tamped back into place.

■ 61. STANDARD QUARTERMASTER LATRINE BOX.—This box is built as shown in figure 10. When the box is placed over the pit, earth should be tamped around the base to prevent the entrance and exit of flies. The box may be made "knockdown"

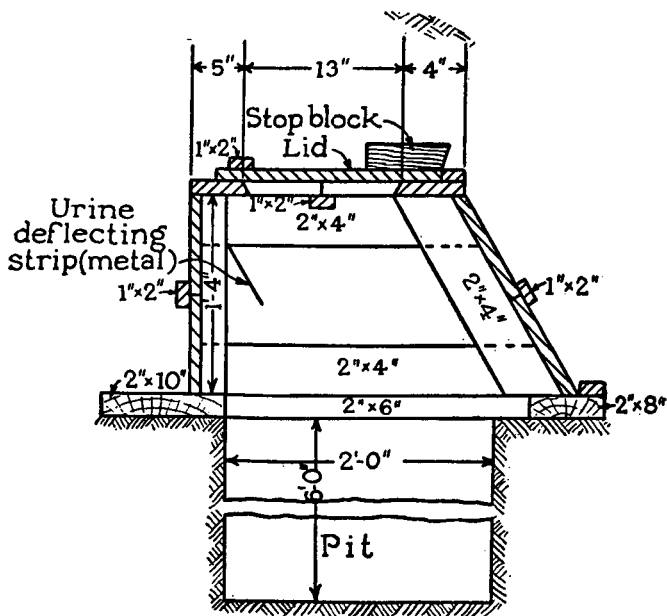

FIGURE 10.—Latrine box showing different sections.

in type so that it can be taken apart and packed more easily on a truck or wagon.

■ 62. URINALS.—When the latrine is installed a trough urinal should be built near enough to it so that it may be enclosed in the same enclosure. Ordinarily this trough may be V-shaped (see fig. 12) and lined with tar paper or galvanized iron. This trough is then connected with the latrine pit by

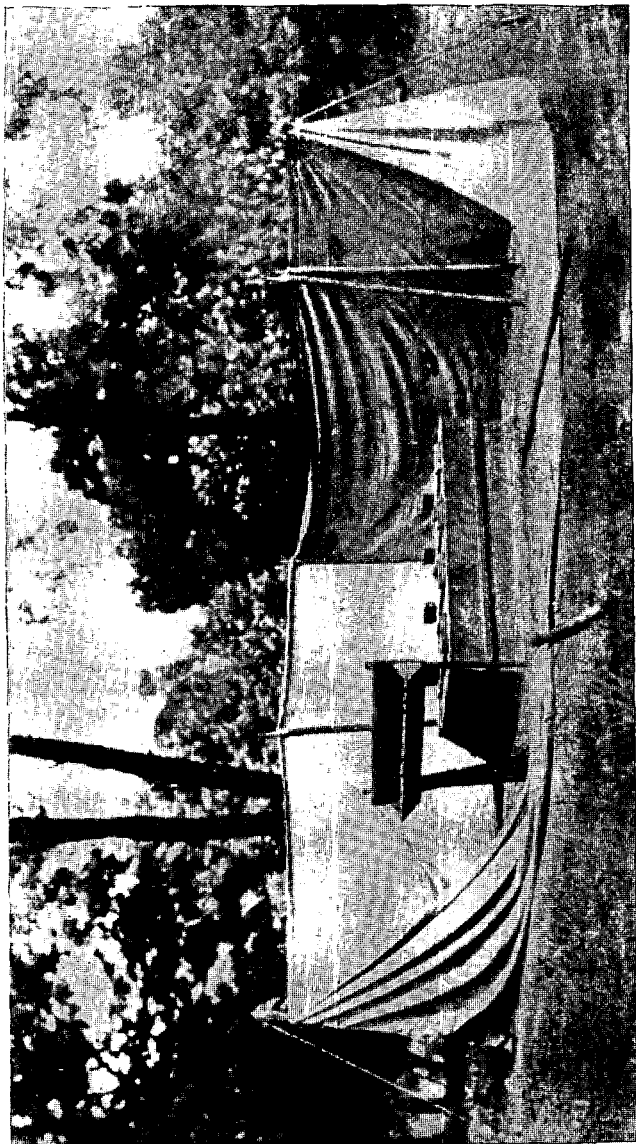

FIGURE 11.—Latrine with screen dropped on one side to show box and urine trough.

means of ordinary galvanized drain pipe. The trough should slant toward the end in which the drain is located and the drain hole should be protected by a wire mesh insert in order that it be not blocked by extraneous material thrown into the trough. The trough may be connected to a urine soakage pit which is built outside of the enclosure if it is not desired to have the urine flow into the latrine pit.

■ 63. PROTECTION.—Latrine and urine trough should be enclosed with a latrine screen made of canvas, or an improvised screen should be made of wood, brush, etc. Latrines should, wherever possible, be protected from rain by use of tents or tent flies. The entire enclosure should be ditched all around so that rain and drainage water will be carried away.

■ 64. MATERIAL FOR ONE LATRINE.—Bill of material for one enclosure and one quartermaster box and one trough urinal. (Labor—one carpenter, 20 hours.)

Top of box-----	2 pieces 1 inch by 12 inches by 8 feet.
Front of box-----	2 pieces 1 inch by 8 inches by 8 feet.
Rear of box-----	2 pieces 1 inch by 10 inches by 8 feet.
Ends of box-----	1 piece 1 inch by 8 inches by 8 feet.
Seat covers-----	{ 1 piece 1 inch by 12 inches by 7 feet.
	{ 1 piece 1 inch by 2 inches by 7 feet.
Batten and strips (if T & G material be used batten may be omitted).	8 pieces 1 inch by 2 inches by 8 feet.
Frame for box..	{ 1 piece 2 inches by 2 inches by 4 feet 6 inches.
	{ 2 pieces 2 inches by 4 inches by 9 feet.
Front plank under box.	1 piece 2 inches by 10 inches by 8 feet.
Rear plank under box.	1 piece 2 inches by 6 inches by 8 feet.
End plank-----	1 piece 2 inches by 6 inches by 3 feet.
End plank-----	1 piece 2 inches by 12 inches by 3 feet 6 inches.

End strip----- 1 piece 1 inch by 6 inches by 2 feet
9 inches.

If wooden enclosure is used:

Posts----- 10 pieces 10 feet.
Boarding (may use equivalent of other than 1") 48 pieces 1 inch by 12 inches by 6 feet.
Battens----- 48 pieces 1 inch by 2 inches by 6 feet.
Rails----- 8 pieces 2 inches by 4 inches by 12 feet.
Paper----- 2 rolls.

If roof is used:

Stringer----- 1 piece 2 inches by 4 inches by 14 feet.
Stringer----- 2 pieces 2 inches by 4 inches by 14 feet.
Nails----- { 3 pounds twentypenny.
 { 8 pounds tenpenny.
 { 4 pounds eightpenny.
Strap hinges---- 4 pairs 4 inches.
Flathead screws. 4 dozen No. 8.

For urine trough:

Ends----- 1 piece 6 inches by 6 inches by 3 feet.
Pipe (approximate size). 1 piece 1¼ inches by 1 inch by 1 foot
4 inches.
Pipe bent (approximate size). 1 piece 1¼ inches by 1 inch by 4 feet.
I. C. tin----- 1 sheet 20 inches by 28 inches.

■ 65. BORED HOLE LATRINE.—This type of latrine has been used extensively in the far east. It consists of a round hole 14 to 18 inches in diameter and 15 to 20 feet deep, made with a post hole auger. The box may be a single seat or a concrete slab with a hole which may be used by squatting.

■ 66. URINE SOAKAGE PIT.—a. A hole 4 feet square is dug and filled with broken stone 1 to 4 inches in diameter (may substitute flattened cans, broken bottles, bricks, etc.). A square ventilating shaft 4 to 6 inches in diameter minimizes odor production. The shaft should extend from about 1 foot above the surface to within 6 inches of the bottom and should

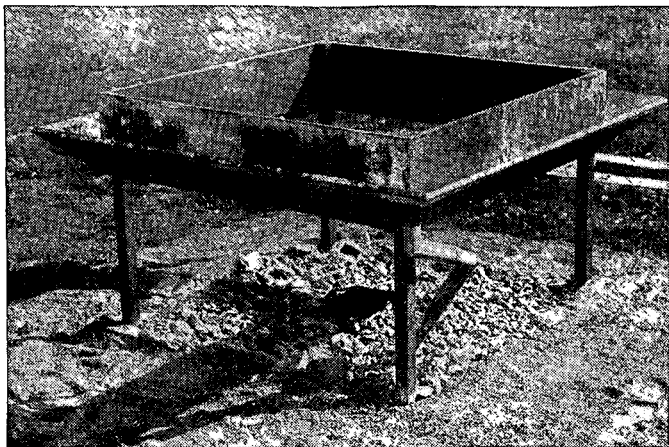

FIGURE 12.—Urinal and urine soakage pit.

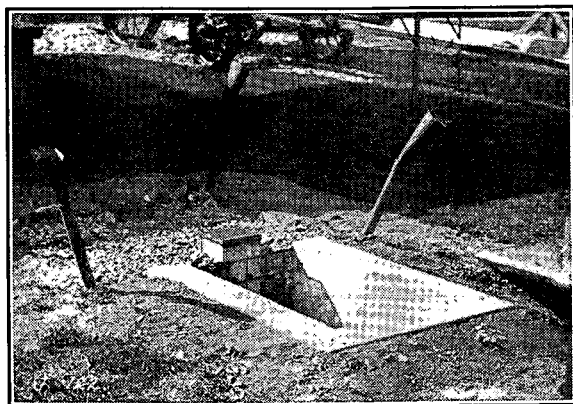

FIGURE 13.—Urine soakage pit.

contain a number of holes. The top of the shaft should be covered with fine screening to prevent ingress of flies.

b. The pit may be surmounted by a square trough urinal as shown in figure 12, or it may have a $\frac{1}{2}$ - to 2-inch pipe placed in each corner at an angle of 30° to the vertical plane and extending about 1 foot into the pit. A metal or tarpaper funnel is placed in each pipe to receive the urine.

c. In loose soil one soakage pit will dispose of urine from 100 men for an indefinite period.

■ 67. LOCATION OF LATRINES.—Latrines should be at least 100 yards away from company kitchens and at least 100 feet from any well or spring.

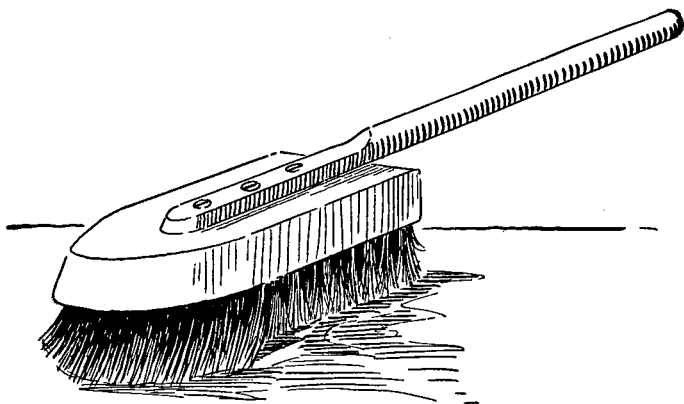

FIGURE 14.—Scrubbing brush for latrine seats, toilet bowls, and urinals. Made by fastening a handle onto one-half of scrubbing brush.

■ 68. CARE OF LATRINES.—Latrines should be policed daily and should be lighted at night. If flies are prevalent, baited fly traps should be placed about in the enclosure. The pit walls and contents should be sprayed daily with either crude oil or sodium-arsenite spray (formula par. 140). The outside of the box should be scrubbed daily with soap and water and the seats twice weekly with 2-percent cresol solution. Urine troughs should be scrubbed daily with soap and water. *Crude oil should not be used in urine trough if trough is lined with*

tar paper or drains into a urine soakage pit. A brush for latrine seats and urine troughs may be made by fastening a handle to one-half of an ordinary scrubbing brush.

■ 69. PAIL LATRINES.—The pail latrine is usually installed where buildings without adequate plumbing facilities are used as barracks or hospital wards. A standard latrine box may be adapted for use as a pail latrine as shown in figure 15. When located in a building the latrine should be built in so that the pails can be removed from the rear and from the outside of the building through openings in the wall. These openings should be fitted with hinged doors. The pails should be removed at least once daily and replaced by a

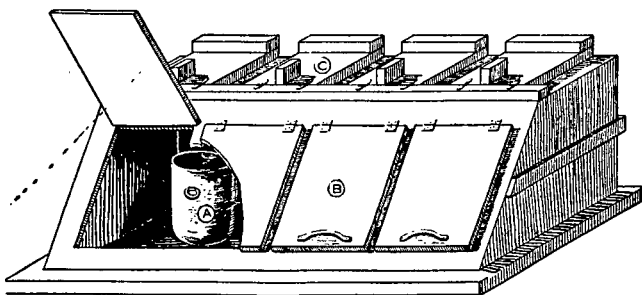

FIGURE 15.—Method of adapting standard latrine box for use as pail latrine. A—Latrine pail. B—Hinged doors. C—Self-closing lids.

clean pail immediately. The bottom of the pail should contain about 1 inch of a 2 percent cresol solution. Pails of excreta from pail latrines may be removed by hand, cart, truck, or wagon and disposed of in one of the following ways:

- a. By burial.
- b. By dumping into manhole of community sewer if one is available and sewage disposal plant will handle additional load.
- c. By incineration.
- d. By placing in flyproof concrete tanks where it undergoes decomposition.

SECTION III

GARBAGE

■ 70. GENERAL.—*a.* Garbage is composed of the solid and semisolid wastes produced in the preparation of food. It includes waste food, the nonedible portions of foodstuffs, and waste materials incident to the preparation of food such as tin cans and coffee grounds. It does not include ashes or rubbish such as street sweepings, rags, boxes, or paper unless the paper is used to wrap the garbage.

b. Amount and character of garbage produced in temporary or semipermanent camps are as follows:

Amount per man per day-----	0. 5-0. 8 pounds.
Water content-----	65-80 percent.
Amount of dry matter combustible--	85 percent.
Amount available for hog feeding---	50 percent.

■ 71. METHODS OF GARBAGE DISPOSAL.—*a.* *Burial.*—On the march or in bivouac, burial of garbage is the method of choice. In larger camps, if soil is favorable, garbage may be buried in trenches 2 to 3 feet deep; however, it requires about 2,500 square feet of ground for the burial of the garbage produced by 100 troops in one month. When garbage trenches are filled to within 1 foot of surface they should be back-filled and the earth well tamped down. Garbage pits should not be within 100 feet of any source of water used for drinking or cooking.

b. *Sale or gift.*—Arrangements may be made, especially in semipermanent camps, to either sell or give the garbage to farmers. This is usually done by contract made by the quartermaster. The contractor should be bonded in order that the government may be protected in case of failure. All of the safeguards mentioned in paragraph 72 should be demanded in order that sanitary defects do not develop. If garbage is utilized for animal food the edible portion must be separated from the nonedible at the kitchens. The following are nonedible articles:

- Coffee grounds.
- Tea leaves.
- Eggshells.

Banana peels and stalks.

Fish heads and scales.

Citron rinds.

Tin cans, paper, and other rubbish.

c. Hog feeding.—This is not feasible unless there are at least 500 troops in a camp for a considerable period of time. Hogs consume an average of 15 to 20 pounds of garbage per day. As 500 troops produce about 200 pounds of edible garbage per day, this will care for 10 to 15 hogs. Hogs should always be immunized against hog cholera.

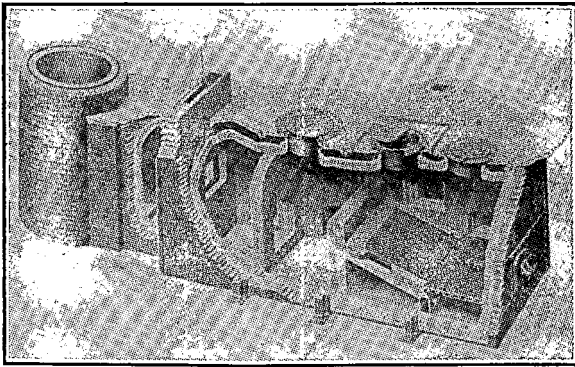

FIGURE 16.—U. S. standard incinerator. Stack about 50 feet in height.

d. Reduction.—The cost of a reduction plant, both as to construction and operation, renders it impracticable for camp or cantonment.

e. Closed incineration.—Closed incinerators are of two types, low temperature (1,400° F.) and high temperature (minimum 1,800° F.). The high temperature types cost more to install but consume all noxious gases. The U. S. standard incinerator is a typical high temperature incinerator (see fig. 16).

f. Semiclosed incinerator.—The semiclosed incinerator is more easily built with unskilled labor than the closed type and is protected from rain and wind. The incline plane incinerator is a type which may be considered semiclosed and which

will consume the garbage from about 1,000 troops and is easily constructed. A trench is dug 11 feet 8 inches long, 2 feet 9 inches wide, and 1 foot 6 inches deep, as the firebox is below



FIGURE 17.—Incline plane incinerator.



FIGURE 18.—Incline plane incinerator, side view.

the level of the ground at one end. (See fig. 17.) The rock shown in the figure supports a piece of corrugated iron which is level for the first 20 inches and then slopes down to the



FIGURE 19.—Incline plane incinerator, end view.

grate. The upper part of the incline plane is roofed over with two pieces of oil drum, each consisting of one-third of a drum cut longitudinally. The entire outside except the doors is covered with a thick layer of wet clay, dried in place with a

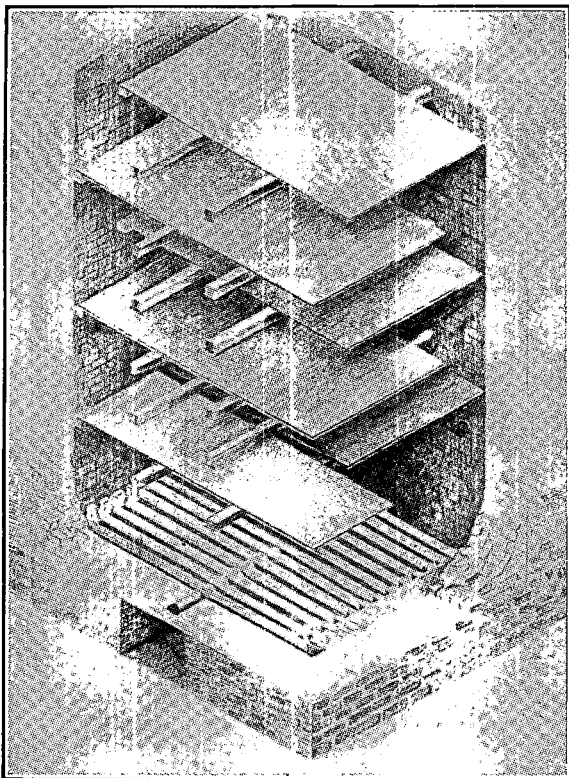

FIGURE 20.—Multiple shelf incinerator with side cut away to show interior construction.

slow fire. Kitchen wastes are fed through the top door onto the corrugated platform and are gradually pushed down the plane toward the grate. Being dried out on the way down they are easily burned.

g. Open incineration.—(1) If none of the methods of disposal previously described exist, the garbage produced in a camp is disposed of by open incineration. Sometimes one incinerator is built for the camp and operated by the quartermaster. This type is usually a multiple shelf incinerator (see fig. 20) or a rock pile incinerator. The latter type is difficult to operate and uses a great deal of fuel so is not constructed unless it is impossible to construct other types.

(2) As a rule company incinerators will be found satisfactory in most camps where garbage has to be burned in the

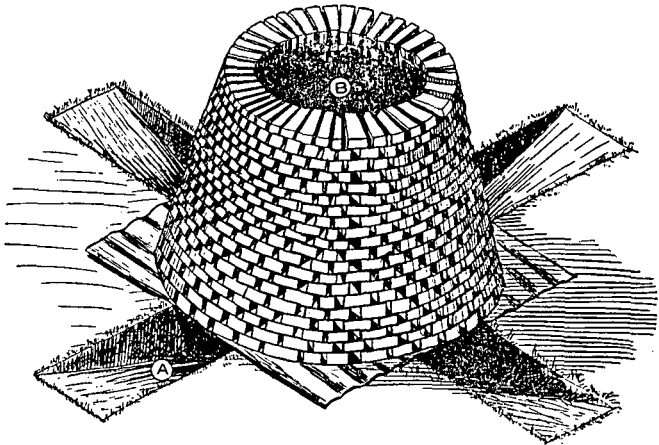

FIGURE 21.—Barrel and trench incinerator.

camp for relatively short periods. However, this type of incineration may be carried on over a period of many months.

(3) The company incinerator of choice is the *barrel and trench* incinerator. This consists of a barrel-like stack which is placed over the intersection of cross trenches. The stack provides means of preheating and partially drying the garbage prior to burning. In constructing a barrel and trench incinerator there are three parts to consider, the trench, the stack, and the supporting material and grate.

(a) Two trenches 1 foot wide and 10 feet long are so constructed that they cross at right angles at the center of each

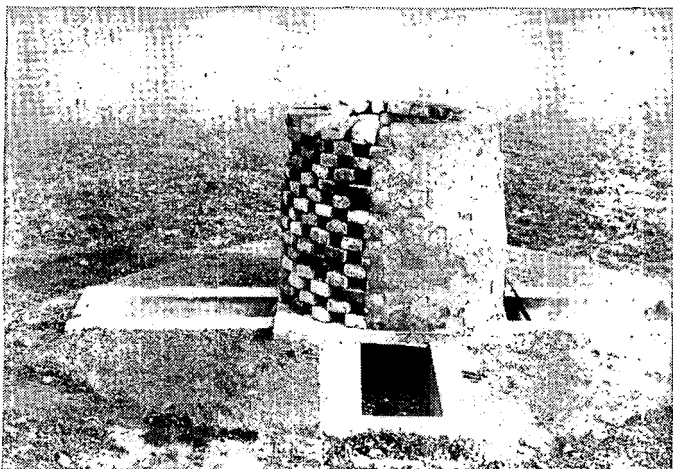

FIGURE 22.—Cross trench incinerator.



FIGURE 23.—Cross trench incinerator with barrel made of packed clay molded over a wooden barrel.

trench. Each trench slopes from the surface of the ground at each end to a depth of 18 inches at the center at the intersection.

(b) The stack may be made of brick or stone either with or without mortar and measures about $4\frac{1}{2}$ feet in diameter at the bottom and 3 feet at the top (outside measurements). The stack may also be made of clay molded over a barrel from which both ends have been removed. An oil drum or galvanized iron garbage can with ends removed may also be utilized.

(c) The supporting structure may be either wide pieces of corrugated iron, sheet iron, or strips of strap iron, iron bars,

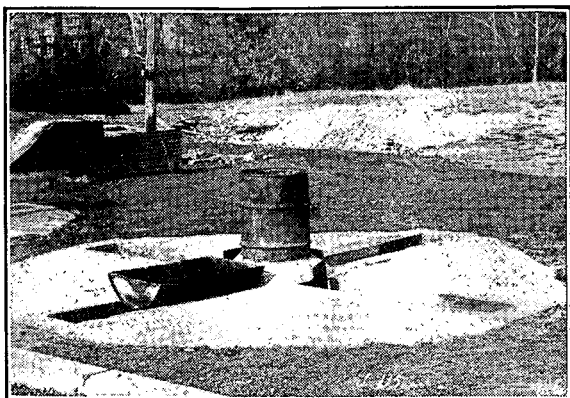

FIGURE 24.—Cross trench incinerator made with 50-gallon oil drum. The trenches are longer than normal in order to give room for the drying pan.

or rails. The grate irons are made from iron rods or pipe and are inserted 3 or 4 inches apart and about 6 inches above the ground in all but the metal oil drum and galvanized iron can types where they are placed at the bottom of the stack.

(4) Other types of company incinerators are—

(a) The rock pit incinerator (fig. 25) which is not economical to operate on account of fuel consumption.

(b) The drying pan incinerator (fig. 26) which may be used where it is difficult to dispose otherwise of liquid kitchen wastes.

(5) Operation of open incinerators is an important factor in the successful disposal of garbage. Attendants should be trained to add garbage slowly so that it will not put out the fire, to use care in dumping garbage receptacles so as not to break in the top of the stack, and to clean the firebox at frequent enough intervals so as not to clog it with ashes.

■ 72. GARBAGE COLLECTION.—Garbage should be collected in standard galvanized iron cans with tightly fitting lids. The cans should be transported by truck or wagon to the point of ultimate disposal or to a central transfer station. Garbage should not be transferred to a garbage cart or wagon or from can to can at the kitchen.

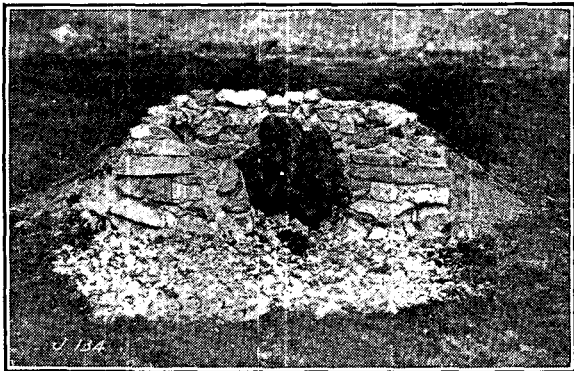

FIGURE 25.—Straub rock pit incinerator.

■ 73. GARBAGE STANDS.—In semipermanent camps, garbage stands should be installed adjacent to the kitchens. The best garbage stands are built in the form of solid concrete blocks with center cores of stone and earth, and with an apron of 12 to 18 inches of concrete at the base. In height, the stand may be from 1 foot to 44 inches. The higher stands will have to be supplied with steps but are at the level of truck floors so as to facilitate can transfers. If concrete is not available, stands may be made of wood, the boards laid crosswise and separated at least 1 inch to prevent the retention of organic

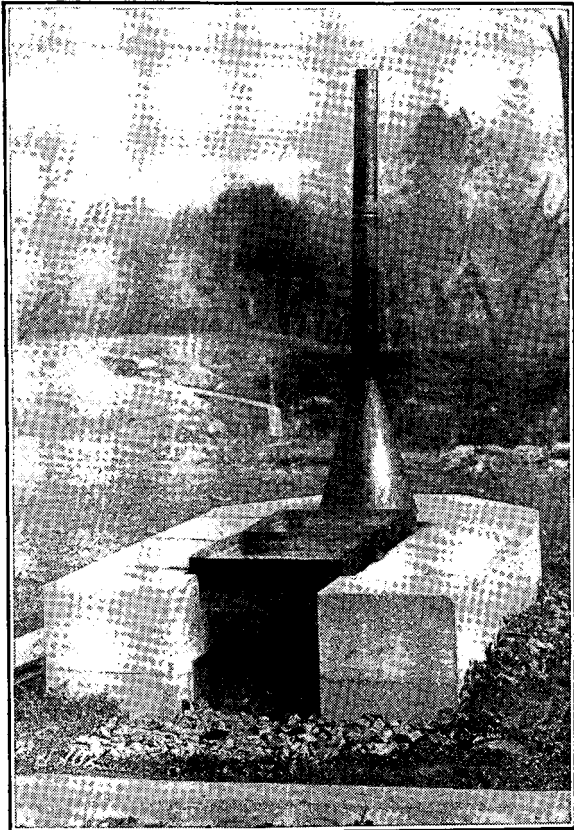

FIGURE 26.—Guthrie drying pan incinerator.

matter. Garbage stands should not be screened or whitewashed.

■ 74. CARE OF GARBAGE STANDS AND CANS.—*a.* In order to minimize the danger of spilling garbage during transportation, the cans should not be filled to within more than 4 inches of the top. The lids should be kept on at all times except when removed to deposit garbage. Care should be exercised that no garbage is spilled on the ground, and if solid garbage is spilled, it should be immediately collected and placed in a can.

b. The platform should be scrubbed daily with a stiff scrubbing brush and hot soapy water, and the ground about the

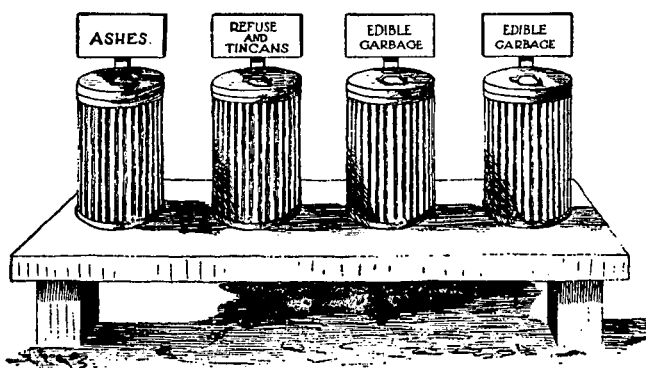

FIGURE 27.—One method of labeling garbage cans for the collection of classified garbage. Concrete garbage stand.

stand should be sprayed at weekly intervals with crude oil and firmly tamped. Intervals between collections should not be more than 2 days in the summer and 3 days in the winter. Garbage cans should be placed in sufficient numbers on the stand so that edible and nonedible garbage, ashes, and refuse can be kept separate. Markers may be used as shown in figure 27. Garbage cans should not be whitewashed or painted.

■ 75. TRANSFER STATION.—*a.* In large camps, where other than company incineration is used, it is usually necessary to install a transfer station. This may be at a central incinerator or at

a point where the garbage is turned over to a contractor. This station should consist of a platform (20 by 100 feet in a large camp), at one end of which is a storeroom for paper and cans, while at the other end is a room where cans are washed. The height of the platform should be about on a level with the floor of a truck. A rubbish incinerator is usually installed near the platform.

b. Can-cleaning equipment consists of tanks or vats in which to soak cans in cleaning compound, adequate hot-water supply, and stiff scrubbing brushes. Equipment shown in figure 28 may be installed to straighten cans and lids.

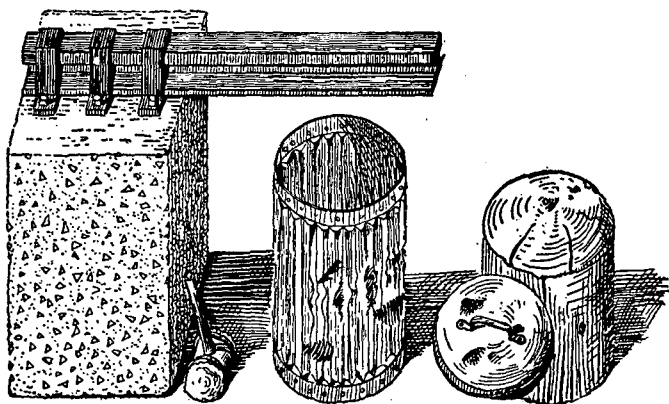

FIGURE 28.—Device used for straightening garbage cans and garbage-can lids.

SECTION IV

LIQUID WASTES

■ 76. GENERAL.—In camps where sewers are available, liquid kitchen wastes may be disposed of by dumping them directly into sewer lines. In most camps, however, this is impossible and some arrangement must be made to dispose of these liquids in the soil. In order to facilitate absorption and to prevent clogging of the soil, liquid kitchen wastes should have the grease removed before they are discharged into any kind of pit or trench.

■ 77. IN BIVOUAC.—Kitchen liquids are disposed of in bivouac by dumping them into trenches or pits. These pits or trenches are filled in when the troops depart. While waste water may be disposed of on the surface of the ground, it provides a breeding place for flies which may annoy other troops who encamp there or persons who live in that vicinity.

■ 78. SOAKAGE PITS.—The ordinary kitchen soakage pit is built the same as the urine soakage pit (par. 66) except that it is equipped with a grease trap instead of a urine trough.

■ 79. GREASE TRAPS.—Grease traps are of two general types, filter and baffle.

a. Filter grease trap.—(1) Filter grease traps consist of galvanized pails, cans, etc., in the bottom of which a number of small holes are punched. The pail or can is placed in the center of the pit with the bottom about 2 inches below the surface. It is filled two-thirds full with a filtering material consisting of hay, grass, straw, or cloth which catches and retains a part of the grease and the debris such as bread crumbs or vegetable fragments. Where a larger quantity of liquid is to be disposed of, a wooden barrel or a metal or wooden tub may be substituted for the pail or can.

(2) The ash barrel grease trap is a very satisfactory trap of the filter type. It is made by drilling about 30 holes in the bottom of an ordinary barrel. About 8 inches of gravel or coarse wood ashes are placed on the bottom and this is covered with about 18 inches of finer ashes. The top of the barrel is covered with a piece of burlap for a strainer, held in place with a barrel hoop. About twice a week the ashes should be removed and burned to remove the grease and then buried.

b. Baffle grease traps.—The baffle or cold water grease trap consists of a container which is divided by a hanging baffle into an influent and effluent chamber, the former having about twice the capacity of the latter. The lower edge of the baffle is separated from the bottom of the container by a space of about 1 inch. The outlet leads from the effluent chamber and is placed from 3 to 6 inches below the upper edge of the container. It may consist of a short piece of 1- or 2-inch pipe or a wooden trough. A strainer should be made of a perforated pail or box containing hay or straw to remove

debris before the liquid passes into the container. When in use both chambers are filled at all times with cool water. When the warm liquid wastes strike the cool water in the influent chamber the grease rises to the surface and is pre-

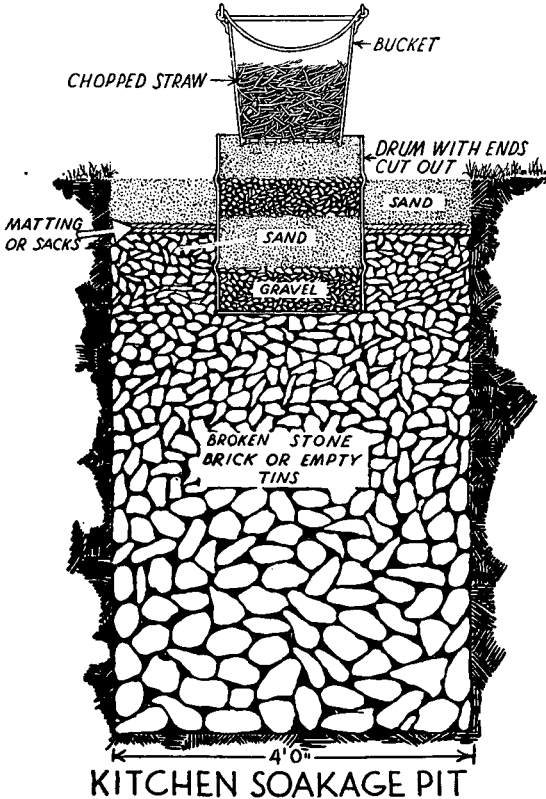

FIGURE 29.—Pail grease trap.

vented by the baffle from reaching the outlet to the soakage pit. Retained grease should be removed at daily intervals and the trap emptied and scrubbed weekly. Sediment removed at the time of cleaning should be burned or buried.



FIGURE 30.—Soakage pit and grease traps. Left, cold water grease trap; right, ash barrel grease trap.

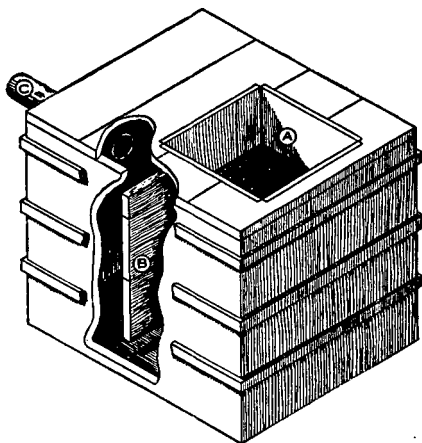
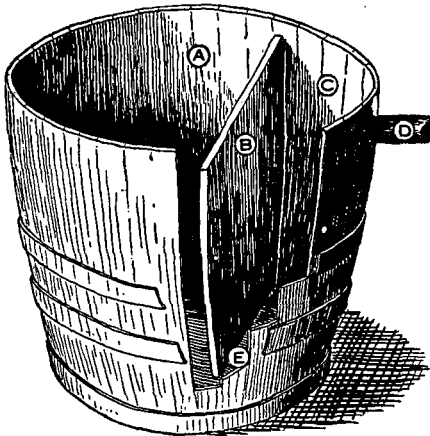

FIGURE 31.—Baffle grease trap. A—Strainer. B—Baffle. C—Outlet. D—Outlet pipe. E—Space under baffle leading from the influent chamber to the effluent chamber.



FIGURE—32.—Baffle grease trap made of a half barrel. A—Influent chamber into which the greasy fluid is emptied. B—Baffle. C—Effluent chamber. D—Outlet pipe. E—Space under baffle leading from the influent chamber to the effluent chamber.

■ 80. SOAKAGE TRENCHES.—A soakage trench consists of a central pit 2 feet square, 1 foot deep, from each corner of which a trench radiates outward for 6 feet. The trenches are 1 foot wide, 1 foot deep where they leave the pit, sloping to a depth of 18 inches at the outer extremity. The central pit

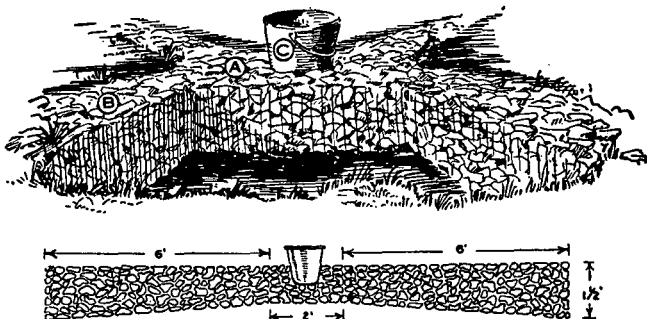

FIGURE 33.—Soakage trench. A—Central square area. B—Radiating lateral trenches. C—Pail grease trap.

and the trenches are filled with rocks, broken bricks, or flattened tin cans. A pail with numerous small holes punched in the bottom and containing straw as filtering material is placed over the center of the pit as a grease trap. The soakage trench is used when the ground water table is so close to the surface that a soakage pit would be flooded, or where the condition of the ground makes the construction of a soakage pit impractical.

■ 81. OPERATION OF SOAKAGE PITS AND TRENCHES.—In order for a soakage pit to function properly, the permeability of the soil must be such that the liquids are drained away so that there will be a rest period during which the pit contains little or no fluid. At times it may be desirable to have two pits using them on alternate days. All debris and as much grease as possible should be removed from liquid before it is allowed to flow into the pit or trench. If clogging tends to occur a week's rest period each month may correct it.

■ 82. DISPOSAL OF BATH AND WASH WATER.—If sewers are not available it may be necessary to dispose of bath and wash water in soakage pits or trenches. Water should pass through a grease trap before it enters the pit or trench. Where no sewered lavatories are available, improvised facilities for washing of hands and faces should be provided. Usually, a wash bench is installed at one end of each company street similar to the one shown in figure 34.

SECTION V

MANURE

■ 83. GENERAL.—Manure is of sanitary significance as it provides an excellent breeding place for flies. The quantity of manure produced varies somewhat with the method of caring for the animals. The average where animals are kept on picket lines without bedding is 10 pounds per animal per day. If bedding is used there will be from 2 to 3 cubic feet of material per animal per day to be disposed of.

■ 84. COLLECTION.—Manure should be collected daily before 10:00 a. m. if possible. All sweepings from picket lines or stables should be included in the collection. The manure should be hauled from the picket line or stable to the place

of disposal in such a manner that none of it will be spilled en route.

■ 85. DISPOSAL BY CONTRACT.—The contractor may collect the manure at the stables or picket line or it may be transferred to him at a transfer point. The contractor should be bonded and the terms of his contract prescribed to see that the manure is collected and transported in such a manner that fly breeding within the military reservation is prevented. The place of ultimate disposal should be far enough away that flies produced in the manure will not return to the camp or,

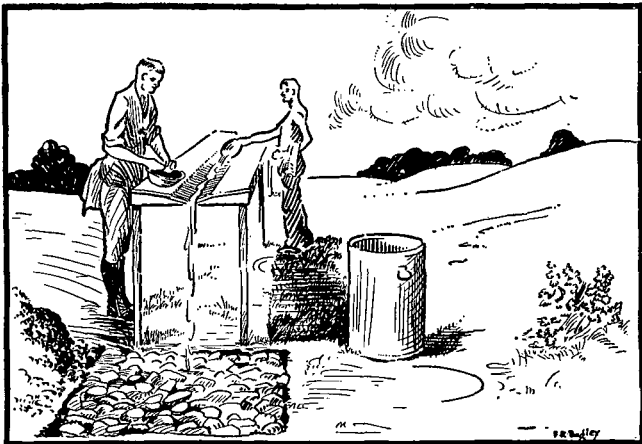

FIGURE 34.—Wash bench showing center trough draining into a soakage pit.

if disposed of near the camp, measures should be taken by the contractor to control fly breeding. Consideration should be given to any existing local laws or regulations when the contract is made.

■ 86. DISPOSAL BY COMPOSTING.—*a.* Composting or close packing of manure in a heap, bin, or other container causes a temperature of from 140° to 160° F. in the center of the mass. This is caused by fermentation, and as fly larvae are killed at 115° F. within a few minutes, they are readily destroyed at all places except the outside of the heap.

b. The following describes a method which will care for the accumulated manure from 100 animals for a period of 6 weeks to 2 months. The area may be enlarged for a greater number of animals or for a longer duration. Eight men should be able to prepare this area in 4 hours. The method consists in the careful preparation of a trenched earthen area upon which the manure is placed in a systematic manner and thereafter properly cared for.

(1) The compost area should be level or nearly so, 60 feet long and 20 feet wide, surrounded by a vertical-walled, flat-



FIGURE 35.—Compost pile.

bottomed trench 12 inches wide and 12 inches deep. Interior and exterior to the trench, the vegetation is removed for a distance of 2 feet. The ground thus bared is treated with oil, preferably road oil, and tamped firmly. A shallow secondary trench, V-shaped, 4 inches wide and 2 inches deep, should be placed 6 inches interior to the main trench.

(2) Manure is to be placed on the compost as shown in figure 36. Beginning at one corner, say at A, place the first day's manure in a space half the width of the platform extending 4 feet lengthwise and piled to a height of 4 or 5 feet. The manure should be packed tightly as it is placed

and the sides of the pile kept vertical. The second day's manure should be similarly placed on the adjacent corner B, tightly packed against the end of pile one; the third day's manure tightly packed against the first day's; the fourth day's against the second day's. On the fifth day the manure should be placed on top of the first pile; the sixth day on top of the second pile; the seventh against the third; the eighth against the fourth. The placing of succeeding days' manure is similar to that of the first 8 days. The upper surface of the pile should be concave, at least not convex, in order to retain rather than shed rain.

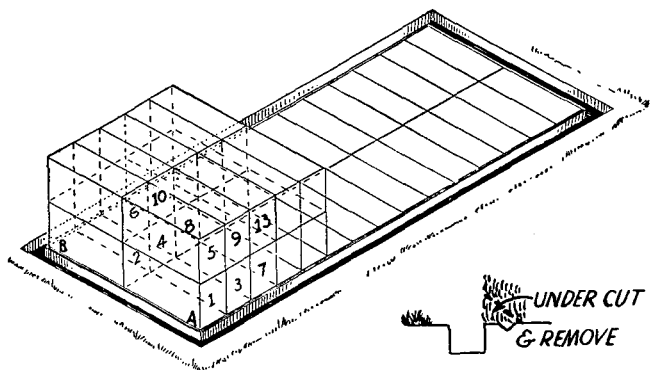

FIGURE 36.—Compost pile. Scheme for placing manure on pile. Numbered spaces each represent 1 day's accumulation of manure.

■ 87. CARE OF COMPOST PILE.—The care of the composted manure consists in keeping it sufficiently moist to promote active decomposition. The sides of the heap should be sprayed daily with either the sodium arsenite fly spray or with a mixture of fuel oil, one part kerosene to which 2 percent of cresol compound is added. The main trench should contain oil which should be of such a consistency as to impede the progress of the larvae and also be larvicidal. There should be but a small amount of oil on the bottom of the trench and the sides should be saturated with oil. A heavy road oil is satisfactory for this purpose. The purpose of the secondary trench is to entrap the larvae and pupae which are always found in large numbers at the edge of the pile. This

trench should contain road oil. It will also contain the larvicide mixture which has dripped down after spraying the pile. As a further control measure, the lower edge of the pile should be undercut after 3 or 4 days and the manure raked out and burned or buried in the top of the pile. A number of well cared for fly traps should be kept near the compost pile. There is sufficient work about a compost pile of this size to keep one man busy most of the time.

■ 88. COMPOST BIN.—A flyproof concrete or wooden bin may be used in which to compost manure. This method is feasible only in stations or semipermanent camps. From 0.5 to 1 cubic foot of space will be required per animal per day.

■ 89. DISPOSAL AS FERTILIZER.—Only composted manure should be used if possible. If fresh manure is used it should be spread thin and plowed under as soon as possible. Even if fresh manure is plowed under (unless dried), a fly nuisance may result as it is almost impossible to obtain it free from eggs.

■ 90. DISPOSAL BY DRYING.—This method is only feasible in dry climates. The manure is spread on the ground in a thin layer not over 1 or 2 inches thick. The drying area required varies from 4 to 12 square feet per animal depending on amount of bedding. At least 25 square feet per day is required for 100 animals. The drying time required is from 4 to 7 days, hence from 4 to 7 areas 25 square feet must be selected. The ground should be smooth and packed down before each application of manure and all lumps and masses broken up. Dried manure may be burned or stored. Should it become wet again after drying, it may afford a breeding place for flies.

■ 91. INCINERATION.—Fresh manure may be dumped on the ground in long windrows, sprayed with oil, and burned. If dried for 3 or 4 days, it may be burned with little or no oil. A grid incinerator may be built of rails as shown in figure 37. The rails may be placed over a pit rather than on supports as shown.

SECTION VI

RUBBISH

■ 92. GENERAL.—Certain items such as tin cans and burned bones may be disposed of on dumps. The dump should be

located where it will produce the least nuisance due to appearance or odors. If practicable, a dump site should be selected where the dumped material will serve to fill a low area.

■ 93. CONSTRUCTION.—A bank fill dump should always be made with a face not less than 8 feet or more than 12 feet in height. Where practical, the dump should be built on a hillside so that the surface may be made approximately level. The face of the dump should be kept as near vertical as possible. Backing logs of heavy timbers should be placed along the upper edge of the face against which the loaded vehicles

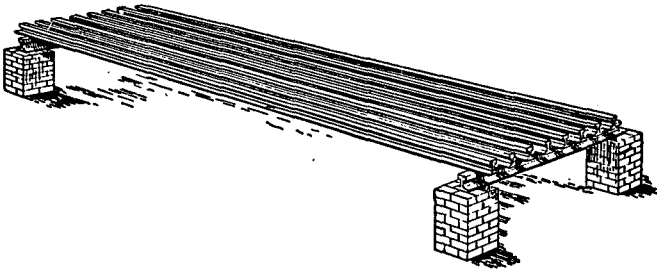

FIGURE 37.—Manure incinerator consisting of grid made of railroad rails elevated on brick piers.

may back and dump their loads down the face of the dump. Vehicles not equipped for dumping should be driven alongside the timbers and unloaded from the side.

■ 94. MAINTENANCE.—As each load is dumped, the face of the dump should be trimmed and all combustible material removed and burned in the incinerator. All large or unsightly articles, or materials which will interfere with plowing or ditching the surface of the finished dump, should be placed on the bottom of the dump, or if necessary broken up. As the dump is completed, the top and sides should be covered with material which will support vegetation. Earth or earth mixed with ashes or manure should be used for this purpose.

CHAPTER 5

MESS SANITATION

	Paragraphs
SECTION I. Responsibility.....	95- 96
II. Facilities.....	97- 99
III. Cleansing of utensils and disposal of wastes.....	100-101
IV. Menus and serving of food.....	102-105
V. Mess inspection.....	106-107

SECTION I

RESPONSIBILITY

■ 95. ADMINISTRATION.—*a.* An Army mess is administered by or under the direct supervision of the commanding officer whose unit it serves, and he is responsible to higher authority for all matters pertaining to the operation of the mess. The commanding officer of a unit may appoint a subordinate officer as *mess officer*. The mess officer functions under the direct supervision of the commanding officer, to whom he is responsible for the management of the mess.

b. The mess sergeant, cooks, and at times certain other individuals, who are on duty in the mess for continuous periods are referred to as permanent food handlers. Kitchen police, waiters, and dishwashers are usually detailed for daily periods and are referred to as temporary food handlers.

■ 96. SANITARY CONTROL.—The Medical Department is responsible for the sanitary inspection of messes and for reports and recommendations relative to sanitary defects. In scope the sanitary control of a mess includes the following factors:

- a.* Sanitation of mess buildings.
- b.* Inspection of food when received.
- c.* Storage of food to prevent deterioration.
- d.* Cleanliness of mess utensils and equipment.
- e.* Disposal of kitchen wastes.
- f.* Methods of formulating menus and character of food served.

- g.* Methods of serving food.
- h.* Physical examination of food handlers.
- i.* Training of mess personnel in mess sanitation.

SECTION II

FACILITIES

■ 97. MESS BUILDINGS.—Where mess buildings are provided they should be properly screened during the fly season. These buildings should be properly and adequately ventilated

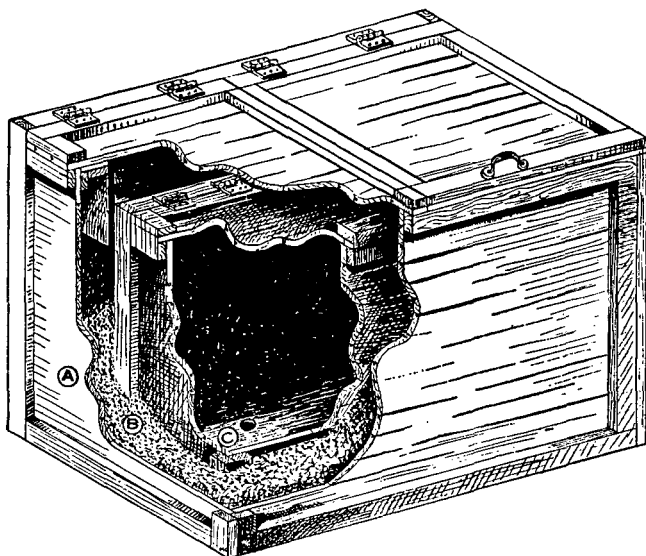

FIGURE 38.—Underground ice or cooling box. A—Outer wall. B—Insulating material. C—Inner wall.

and lighted. Special attention should be given to floors as these, unless made of impervious material, will become grease soaked and unsightly.

■ 98. INSPECTION OF FOOD WHEN RECEIVED.—All food received at a mess should be inspected by the mess sergeant, the mess

officer, or the commanding officer of the organization to which the mess belongs. The primary purpose of this inspection is to determine if the food in question is of proper quality and free from contamination. If evidence of deterioration, spoilage, or contamination is found, the proper Medical Department officer, either the surgeon or the veterinarian, should be notified and the suspected articles reserved for his official inspection.

■ 99. STORAGE FACILITIES.—Adequate storage should be provided for reserve food supplies and these should be protected from dust, dirt, and insects. Perishable foods should be kept at suitable temperatures to prevent their deterioration.

a. In the field where commercial refrigerators are not available a satisfactory substitute is the underground icebox. This is a double-walled box sunk in the ground. The pit should be dug several feet deeper than required and filled with crushed rock so as to form a soakage pit to take care of melted ice. Dimensions of outer box are 5 feet long, 4 feet wide, and 4 feet deep; of inner box, 4 feet long, 3 feet wide, and 3 feet deep. Earth is packed into the crevices between the outer wall of the box and the sides of the pit. A non-conductor—hay, straw, or sawdust—is packed between the inner and outer walls. Floor is perforated to drain water into soakage pit.

b. Bread should always be kept in screened cabinets. In the field a suspended bread container may be made as shown in figure 39.

SECTION III

CLEANSING OF UTENSILS AND DISPOSAL OF WASTES

■ 100. DISHWASHING.—a. More attention is now being given to the danger of the spread of communicable diseases through the media of dishes and kitchen utensils. In order to prevent danger of infection, dishes and utensils must be treated by heat or chemicals. Immersion in water at a temperature of 160° F. for 1 minute will destroy pathogenic organisms. If the temperature is lower the immersion time must be longer, until at a temperature of 140° to 145° F. the dishes must remain 30 minutes.

b. Because of the difficulties encountered in disinfecting dishes by heat, certain chemicals have been found satisfactory. After dishes have been washed in hot soapy water and rinsed in hot clear water they are immersed in a chlorine solution containing at least 50 parts per million of free chlorine. When the solution is freshly prepared it should contain 200 parts of chlorine per million. One ounce of grade A hypochlorite to 25 gallons of water will give this strength solution.

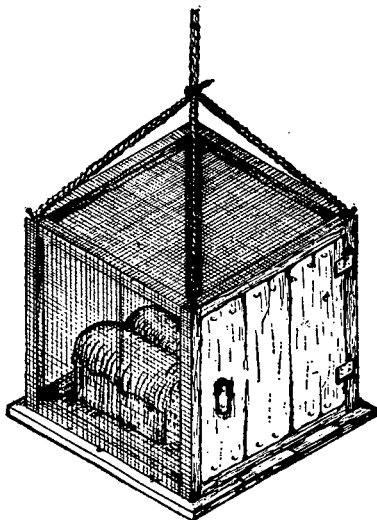

FIGURE 39.—Suspended food container.

c. Dishes and utensils should always be air-dried and dish towels should not be used.

d. Mess kits should have waste food scraped off into suitable container and then be washed in two changes of hot soapy water, rinsed in hot clear water, and air-dried. Ordinary galvanized iron cans over a trench may be used for mess kit washing (see fig. 40). In semipermanent camps, in order to conserve fuel and save labor, an apparatus similar to the one shown in figure 41 may be constructed. A pit is dug 11 feet long, 2 feet wide, and 4 feet deep; it is filled to

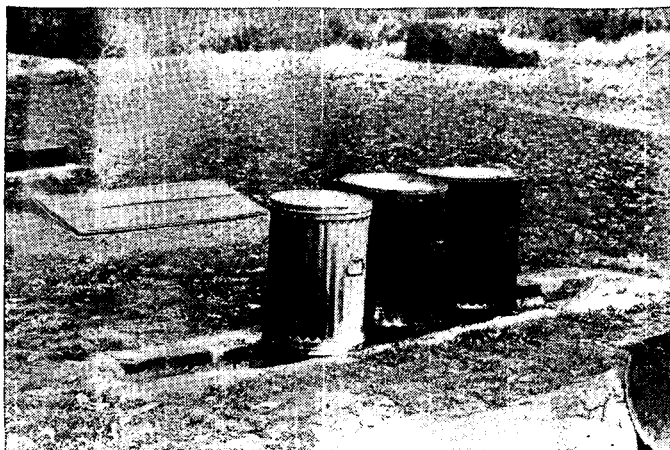

FIGURE 40.—Fire trench and cans for washing mess kits.

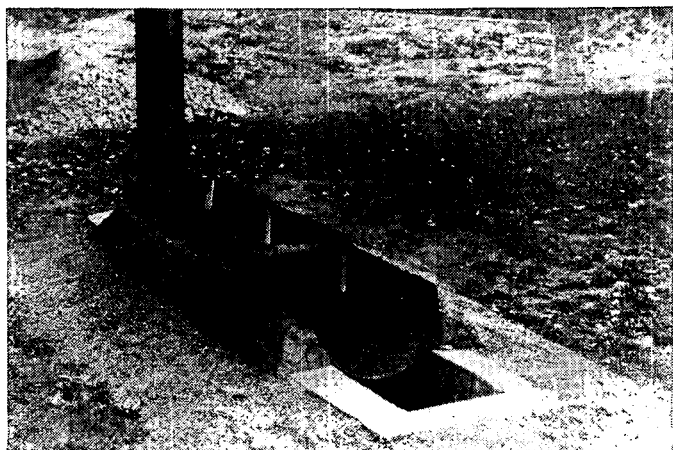

FIGURE 41.—Appliance for washing mess kits for use in semipermanent camps.

within 1 foot of the surface with stones. Along the two sides and one end a wall of stone, brick, or concrete is built, extending 2 feet above the ground level and forming a firebox. The water containers are made from 50-gallon oil drums, cut along the longitudinal axis, 4 inches above the center line. Drums with bungs should be used and so cut that the bungs will be at the most dependent part of the drum when it is placed on the firebox. Pieces of iron pipe of sufficient length to extend above the water level are threaded at one end to fit the bung hole and drilled at the other end to receive an iron rod used to turn them in or out. After the drums are placed on the firebox, the space between the drums and walls, and between the ends of each drum, is filled with clay. A stack is placed at the closed end just beyond the last drum and the open space between drum and stack is also filled with clay. This device will require a relatively small amount of fuel to boil the water, and the draft will be such that it will be found desirable to place a damper in the stack. The men can wash their mess kits without being bothered by flame or smoke. When washing is completed, the pipes in the bung holes are removed and the water escapes into the soakage pit.

■ 101. DISPOSAL OF KITCHEN WASTES.—See section III, chapter 4.

SECTION IV

MENUS AND SERVING OF FOOD

■ 102. METHODS OF FORMULATING MENUS AND CHARACTER OF FOOD SERVED.—*a. General.*—A menu should provide for the proper qualities of each food constituent and for articles which will be acceptable to the group served by the mess in question. In formulating menus, care must be taken to vary the kinds of food served and methods of preparing and serving the articles of food. Few foods can be prepared and served in the same manner day after day without soon becoming nonacceptable to the greater proportion of the group served. The frequency with which a dish can be repeated without becoming nonacceptable varies greatly with the different articles of food and is, to some extent, modified by the character-

istics of the individuals making up the group served. For example, meat and potatoes can be, and are, served day after day and, with variation in methods of preparing, do not become nonacceptable to the average American soldier. On the other hand, troops tire quickly of the same kind of sweet pastry or of such vegetables as carrots, cabbage, or beets.

b. Menu period.—A menu should be formulated for each day for a period of days, usually for a period of 5 or 10 days. The menu period should be planned for an odd number of days, such as five or ten, and not for weekly periods, so that the same menu will not be served on corresponding days of each week. The most satisfactory menu for the average Army mess is a 10-day menu providing for basic dishes to which other dishes may be added as opportunity is offered to secure desirable articles of food. The acceptability of food served by a mess can be enhanced and the nutritional value of the ration increased by the addition or substitution of special dishes at irregular intervals. This can be accomplished by the mess officer or mess sergeant through the exercise of a certain amount of ingenuity and foresight without materially increasing the cost of the ration.

■ 103. METHOD OF SERVING FOOD.—*a.* Food must be served in such a manner that it will not be contaminated during the process of serving. The method of serving should enhance or at least not lessen the acceptability of the food or its appeal to the group appetite, and the food should be so served as to reduce wastage to a minimum.

b. There are two general methods of serving food in a mess, the line service or cafeteria method and the table service method. In the field, except in semipermanent camps, the line service has to be used as there will be no facilities for mess hall service. If personnel and equipment are available, a well-conducted table service will generally have a more favorable effect on the morale and contentment of troops than the cafeteria service.

■ 104. FOOD HANDLERS.—*a.* Every man who is to be assigned to duty as a permanent food handler should be reported by his organization commander, or the mess officer, to the surgeon of the command for a physical examination. If the

man is found to be free from communicable disease and is not a carrier of communicable disease, the surgeon should issue a certificate to this effect to the organization commander or mess officer concerned. No one should be assigned to duty as a permanent food handler who has not been examined by a medical officer and certified to be free from communicable disease and not a carrier. Permanent food handlers should be re-examined at intervals of not more than 6 months.

b. Permanent food handlers' certificates should be kept posted, or on file available for inspection, in the place where the food handlers concerned are employed.

c. No one should be considered fit for assignment to duty as a food handler who, when physically examined, presents evidence of acute or chronic inflammatory conditions of the respiratory tract, or any signs or symptoms of venereal disease, intestinal disease, or other communicable diseases.

d. The medical history of the examinee is of paramount importance in determining his fitness for duty as a food handler. Any history indicating that he may have had typhoid fever or bacillary or amebic dysentery should be regarded as rendering him unsuited for duty as a food handler.

e. When deemed desirable by the examining surgeon, the feces and urine may be examined bacteriologically to determine if the man is a carrier of intestinal disease.

■ 105. TRAINING OF MESS PERSONNEL IN MESS SANITATION.—The medical officer who inspects the mess should ascertain whether or not personnel are familiar with ordinary rules of mess sanitation. Instruction of personnel is the responsibility of the unit commander. However, he may call upon the surgeon for assistance.

SECTION V

MESS INSPECTION

■ 106. SANITARY INSPECTION OF MESSES.—The principal purpose of a sanitary inspection of a mess is to determine the existence and nature of any defects which would result in contamination of the food and the transmission of disease-producing organisms to the troops, or which would impair the nutritive value or lessen the acceptability of the food as served to the troops.

■ 107. **OUTLINE FOR SANITARY INSPECTION OF MESS.**—The following outline may be followed in making a complete sanitary inspection of a mess. It is suggested as a guide only:

a. Attendants:

Is mess sergeant qualified for position as to—

Knowledge of food requirements and preparation of food?

Ability to maintain discipline?

Business ability?

Are cooks adequately trained? How?

Have food handlers all had "food handlers'" examination and been certified as to health condition by the surgeon?

Are food handlers cleanly as to—

Clothing?

Hair?

Hands (inspect fingernails)?

Personal habits? Care in washing hands after urination and defecation.

Is there a convenient washroom for food handlers?

b. Menus:

Does food served correspond with menu posted?

Are menus well balanced and amount of food adequate?

Check file of menus and mess account balance sheet.

NOTE.—Daily food supplied each man should yield at least 3,000 calories, provide at least 100 grams of protein, and contain adequate vitamins.

c. Food supplies:

Meat and fish:

Source.

Quality.

Freshness.

Handling.

Storage.

Preparation.

Milk and dairy products:

Same consideration as meat.

Has bacteriological and chemical analysis been made?

Is milk raw or pasteurized?

c. Food supplies—Continued.

Fruit and vegetables:

Is supply adequate and satisfactory?

Are men educated to their use?

Canned foods:

Is supply satisfactory?

Bread and bakery products:

Source.

Quality.

Delivery method.

Storage.

d. Food storages:

Refrigerator:

Is space adequate?

Condition and sufficiency.

Cleanliness.

Disposal of drip water.

e. Pantries:

General neatness, cleanliness, and adequacy of storage facilities.

Vegetable storage:

Have vegetable bins been provided?

Condition of vegetables in storage.

Do facilities for storage guard against undue wastage by rotting?

f. Bread boxes:

Sufficiency, cleanliness, and neatness.

g. Food preparation and serving:

Refer to cooks' training.

Is food served in a reasonably attractive manner?

Could you eat and enjoy the meals served and as served to the men in your organizations? If not, what corrections are advisable?

h. Police:

Dishwashing:

Does the method meet the requirements of Army Regulations?

Are trays, dishes, and utensils clean? Look between fork tines and around hilt of knife.

*h. Police—Continued.***Kitchen utensils:**

Are pots and pans kept grease free?

Are they properly stored when not in use?

Are knives and forks clean? Look around handles and hilts.

Is there a knife rack and a knife sharpener?

Are stoves kept clean?

Is fuel supply adequate?

Kitchen police:

Cleanliness of floors, walls, and ceilings.

Are dirty rags allowed to accumulate on ledges, top of bread box, top of refrigerator, etc.?

Are personal belongings of mess attendants allowed to accumulate in kitchen?

i. Waste disposal:

Is waste handled in a cleanly, satisfactory manner inside the kitchens and storerooms?

Is vegetable preparation and peeling carried out in a neat and satisfactory manner?

Is waste properly sorted and kept in proper receptacles?

Ashes.

Combustible trash and tin cans.

Edible garbage for piggery.

Nonedible garbage.

Are empty cans crushed and perforated before going to the trash can?

Has a trash and garbage stand been provided? Is it kept clean?

Is the surrounding area kept dry and free from soil pollution?

Is waste removed at reasonable intervals?

Are clean containers provided at reasonable intervals?

How and by whom are containers washed?

How are wastes disposed of:

Ashes to dump? Location of dump?

Combustible trash burned? Where?

Garbage incinerated? Or sold?

i. Waste disposal—Continued.

If garbage is sold, are terms of contract being met as to—

Frequency of collection?

Method of collection?

Cleanliness of cans?

j. Insects and rodents:

Is mess screened adequately?

Is there a supply of fly swatters or other fly destroyers?

Are they used?

Have fly traps been provided and are they kept properly baited and set up for use?

Are roaches and other insects present? If so, what method is being used to control them?

Are rodents troublesome? What steps have been taken for their destruction?

CHAPTER 6

HYGIENIC CONTROL OF FOOD PRODUCTS OF ANIMAL ORIGIN

	Paragraphs
SECTION I. Meat and meat food products.....	108-114
II. Sanitary inspections.....	115-117
III. Poultry and eggs.....	118-119
IV. Fish and sea foods.....	120-121
V. Milk and daily products.....	122-126

SECTION I

MEAT AND MEAT FOOD PRODUCTS

■ 108. GENERAL.—*a.* Except in an emergency, food products of animal origin such as meat and meat products, poultry and eggs, fish and other seafoods, as well as all dairy products, usually arrive at the consuming organization after careful and thorough inspections by various civil and military inspecting agencies that have had as their purpose the protection of the health of troops by preventing the introduction of deteriorated or contaminated products into organizational messes.

b. Appropriate Army Regulations place the responsibility for the inspection of food products of animal origin on the Veterinary Corps of the Medical Department whose purpose is to protect the health of the troops by preventing the purchase or issue of meat and dairy products which, by reason of their source, nature, handling, or condition, may be unsafe or unsuitable for food purposes. As a sanitary procedure, this is a direct extension of the sanitary service maintained by the Medical Department which assures a safe sanitary product up to the point of issue to troops.

c. However, when improperly handled and stored, meat and meat products are subject to rapid deterioration and during the time products remain in the company kitchens, messes, or refrigerators, very careful supervision should be exercised by medical officers to assure the use of only sanitary products.

■ 109. SPOILAGE OF MEAT.—Meat is considered to be unsound which has deteriorated or undergone any undesirable changes.

The meat of a healthy animal is free from bacteria, and all bacterial decomposition is due to contamination subsequent to slaughter. It is not practicable, however, to prevent a certain amount of contamination during the handling of meat so that all fresh meat is more or less contaminated with bacteria and fungi. Where the meat is properly handled, the contaminating organisms are nonpathogenic but they may cause spoilage of meat. Under insanitary conditions the meat may be contaminated with pathogenic organisms. In meat which has been thoroughly dried and properly chilled, the bacteria grow slowly and the bacterial penetration is delayed while a moist and improperly chilled product is conducive to rapid bacterial growth and penetration. Bacteria may penetrate rapidly and deeply into the tissues by growth along moist surfaces between muscular tissues or through open vessels causing areas of decomposition in the deep parts of the tissues and around the bones without evidence of surface deterioration.

■ 110. PRESERVATION OF MEATS.—In order to prevent or retard bacterial invasion resulting in decomposition, products must be stored in a temperature which is not conducive to bacterial growth or cooked sufficiently to destroy bacteria or fungi present. Meat which has been properly handled prior to receipt will usually remain free from decomposition for from 6 to 10 days if immediately placed in a temperature of about 35° F. However, the average ice box or refrigerator maintains a temperature of from 45° F. to 55° F. and is not satisfactory as storage for more than 72 hours. It is essential that meat under refrigeration be hung in such a manner as to allow free circulation of air around it. Covering or wrappings should be removed to hasten chilling process.

■ 111. SMALL REFRIGERATORS.—A small refrigerator or ice box should be desirably located, preferably away from heat of stoves or direct rays of the sun. It should be cleaned every day and well iced. Doors should be kept closed to conserve refrigeration. Meat should not be stored in the ice compartment and never in contact with ice as the ice may not be clean, also the meat will become wet and this hastens spoilage. Drain pipes should be sanitary and open. Food com-

partments should not be overcrowded and meats should be unwrapped and so placed as not to retard circulation. At 55° F. it is possible to keep good, fresh, dry meat for 24 to 36 hours; at 45° F. three days or more; while above 57° F. the refrigerator is inefficient. A good thermometer should be used in each refrigerator.

■ 112. TEMPORARY CAMPS.—In temporary camps, meat and meat and dairy products may be stored for a short time in watertight containers and immersed in springs or streams, care being taken to prevent contamination. Food may also be buried below the surface of the ground in underground ice boxes.

■ 113. DISEASE TRANSMISSION.—Any disease, the causative organisms of which can be conveyed by food to a point of invasion within the body, may be transmitted by food. The diseases most frequently transmitted in this manner are those belonging to the intestinal group such as typhoid fever, the food infections, dysenteries, and diarrheas, but food may also be the transmission agency for other diseases such as tuberculosis, scarlet fever, and diphtheria. Diseases due to a pre-formed toxin, of which botulism is an example, may be caused by food in the sense that the food carries the toxin from the point of origin in infected food to the alimentary tract of man.

■ 114. MEAT POISONING, BOTULISM.—The inspection of meat offers but little safeguard against the meat poisoning group of bacteria and botulism, or sausage poisoning, for the reason that the micro-organisms may pervade the meat without in the least changing its appearance, color, flavor, or odor. Thorough cooking will destroy the infection and eliminate the danger of meat poisoning and botulism but the cooking must be thorough and it must be remembered that the *bacillus botulinus* grows well in cooked foods.

SECTION II

SANITARY INSPECTIONS

■ 115. FRESH MEATS.—Assuming that all prior inspections have shown the product to be acceptable up to the point of

issue to the consuming organization, a further and final safeguard is essential in order to assure that deterioration or contamination has not occurred subsequent to issue and prior to consumption. This is accomplished by the sanitary inspection of products exercised by the responsible medical officer. The sanitary inspection within the company or organization mess should include the appearance of a package or product as an indication of prior handling, evidence of prior official inspection, as well as evidence of contamination, deterioration, and adulteration. Inspecting officers should be familiar with the appearance, color, odor, flavor, consistency, and other factors in order to determine acceptable sanitary conditions.

a. Color.—The color of fresh meats depends mainly upon kind, age, conditions at slaughter, and part of the carcass from which derived. Choice fresh beef should be a bright cherry red; veal should be pinkish brown; mutton, a dark pink or red; lamb, a light pink, and pork, a light pink.

b. Odor.—Meat should be free from any abnormal odor. Decomposed meat may be detected if it has a strong, sour, disagreeable, musty, mouldy, or other off odor. Putrid odors are usually due to ammonia or hydrogen sulfide. Rancidity of fats may be determined by the odor or flavor. A steel trier or knife may be used as an aid in the examination for odors, passing the trier into the tissue especially in the vicinity of bone and withdrawing for evidence of decomposition.

c. Consistency.—Sound meat should be reasonably firm to the touch and should barely moisten the finger. Meat should not be flabby or pit on pressure. If, upon examination, meat or meat food products are found to be affected with an unsoundness of slight or limited extent, which in the opinion of the inspector can be removed by trimming, wiping, or other manipulation, this action should be taken followed by reinspection to determine condition of the product. If the unsoundness involves any considerable proportion of the carcass or cut and in all doubtful cases, the carcass or cut should not be used for food. The removal of surface rancidity or sourness may be accomplished by wiping with a dilute vinegar or baking soda solution.

■ 116. CURED MEATS.—Cured meats showing deep tissue decomposition, insect infestation, rancidity, sourness, or extensive mold or slime should not be used for food. Slight degrees of mold or slime may be removed by washing or wiping the surface with a dilute vinegar or soda solution.

■ 117. CANNED MEAT FOODS.—Canned meat foods should be examined carefully for evidence of defective containers allowing contamination of the contents or of improperly processed contents resulting in spoilage dangerous to health. Defective cans are readily detected and are classified as leakers, swellers, or springers (AR 40-2200).

a. *Leaker*.—A leaker is a can presenting a defect through which air may enter or the contents escape. If the defect is small, leakage may be indicated only by the removal of the vacuum and the disappearance of the concavity in the ends or sides of the can.

b. *Sweller*.—A sweller is a can which contains gas in sufficient quantities to produce bulging or distention of the sides or ends. The gas is usually due to contamination with gas-producing organisms resulting in incomplete sterilization or infection subsequent to sterilization.

c. *Springer*.—A springer is a can in which gas within the can is sufficient to cause a disappearance of the normal concavity from one end or side. External pressure on the flattened or bulging side causes the other end or side to flatten the bulge.

All leakers, swellers, and springers should be rejected for food. The presence of *bacillus botulinus* in canned foods is noted by its characteristic foul odor. Such foods should not be used for food and should not be tasted.

SECTION III

POULTRY AND EGGS

■ 118. POULTRY.—a. The term "poultry" includes chickens, ducks, geese, turkeys, and such other domestic birds as may be used for food. Poultry is generally subject to the same kind of contamination as meat products, though the tissues of poultry may afford a more suitable medium for the growth of organisms. While the diseases common to poultry are not

readily communicable to man, very careful post mortem inspections are necessary in order to prevent the consumption of food contaminated with organisms pathogenic for man.

b. Inspection.—Poultry will usually be received freshly killed, chilled, or frozen and should be undrawn, with head and feet on unless processed under supervision of Federal inspection agencies when they may be accepted fully drawn. Evidence of decomposition, slimy or sour carcasses, or any other unsoundness render the carcass unfit for food.

■ 119. Eggs.—*a.* The term "egg" usually includes only chicken eggs and while they do not ordinarily serve as a transmitting agency for disease-producing organisms, it is possible for micro-organisms to pass through the porous shell or reach the interior through a break in the shell.

b. Inspection.—Eggs are inspected for freshness, soundness, cleanliness of the shell, color, and size. Candling and breaking are used to test the freshness or soundness of eggs. In candling, the unsoundness is indicated by mixing of the white and yolk, adherence of the yolk to the shell, blood rings, abnormally colored yolks, movable air cells, discolored whites, or foreign bodies. Unsound eggs should not be used for food. If, upon breaking, a considerable proportion are unsound, the entire lot should be discarded. An efficient candling apparatus may be easily constructed by placing a lamp or electric light bulb in a can, shoe box, or other receptacle through which has been cut a hole about the size of the small end of an egg. The egg is placed to this hole through which the light shines allowing the inspector to determine the internal condition of the eggs.

SECTION IV

FISH AND SEA FOODS

■ 120. FISH.—From the time fish are caught until finally consumed they should be handled, transported, and stored under proper and sanitary conditions. Otherwise, rapid deterioration characterized by putrefactive decomposition will occur. The flesh of fish may contain chemical poisons which will produce illness in man or it may serve as a transmitting agency for disease-producing organisms. Most of

the fish so affected are found in the tropics. The toxic substance is usually found in the ovaries and eggs but may also be found in the head and liver. Inasmuch as the toxic substance is not removed by boiling, the most careful supervision must be exercised to assure the removal of these portions of the fish. In some localities, various types of fresh water fish (pike, perch) may contain the encysted larvae of the fish tapeworm which, when ingested in a viable state, develop into the adult forms in the intestines. Thorough cooking will destroy the larvae. Smoking, drying, salting, or freezing will not destroy the larvae.

a. Inspection.—In the inspection of fresh chilled fish, certain characteristic indications of soundness should be sought. If a fish is fresh and sound, the following conditions will be noted:

- (1) *Gills.*—Bright red, usually closed, no abnormal odor.
- (2) *Eyes.*—Prominent appearance, transparent cornea.
- (3) *Scales.*—Adherent.
- (4) *Skin.*—Free from malodorous slime, not discolored.
- (5) *Flesh.*—Firm, only transient indentations by pressure with fingers.
- (6) *Body.*—Stiff, tail rigid.
- (7) *Carcass.*—Will sink in water.

The carcass of any fish showing evidence of unsoundness, injury, or contamination should not be used for food.

b. Storage of fresh, chilled fish.—Sound, fresh fish which have been properly handled and packed in ice may be held in storage at a temperature of 32° F. for 10 to 14 days. However, strictest care should be exercised to prevent variation of temperature. Should fish be defrosted they should be consumed promptly. Fish should be defrosted gradually in a cooler or refrigerator and not exposed to heat or soaking in either hot or cold water as this action will lessen the palatability and food value.

☒ 121. SEA FOODS.—*a. Fresh.*—(1) Many individuals exhibit idiosyncrasies to shellfish, such as oysters, clams, crabs, shrimp, etc., which are usually manifested by urticaria, nausea, and vomiting. These symptoms should not be confused with those of food poisoning.

(2) Inasmuch as oysters thrive best in water, the salinity of which is less than sea water, many of the producing areas are located where the sea water is diluted with fresh water. Some of these areas may be contaminated with the effluents of sewage systems. The production and handling of oysters are governed by State laws and regulations insofar as factors which result in contamination, deterioration, or adulteration are concerned and the shipment in interstate commerce is prohibited by Federal laws. The use of oysters or other sea foods should be confined to products handled under jurisdiction of State or Federal agencies.

(3) *Inspection.*—Oysters may spoil or become stale after being shipped or they may become contaminated during transportation. Hence, a piece inspection should be made for evidence of spoilage, staleness, or adulteration. Oysters whether in the shell or shucked are highly perishable. They deteriorate rapidly when improperly handled and present a characteristic, disagreeable odor or a gassy or milky appearance. Oysters may show a green or pink discoloration and while there is no evidence that they are detrimental to the health of the consumer, they are generally regarded as undesirable for food and should not be used. Ordinarily, only canned crabs, clams, shrimps, and lobsters are used in Army messes, but should they be furnished fresh, the inspection is, in general, the same as for oysters.

b. Canned.—(1) It is considered that all canned sea foods have been prepared under official supervision of civilian or military inspection agencies and that the quality of product and method of processing is satisfactory. However, deterioration of the canned product is subject to spoilage or damage and the product should be subject to sanitary inspection prior to use.

(2) *Inspection.*—The inspection is made by examination of the unopened can and the contents of suspected or selected cans. If the contents of the can are sound, the ends of round cans and the sides of square or flat cans are concave. Should the ends or sides become flattened or bulged, it may be due to a defect in the can allowing air to enter, or to decomposition of the contents with gas formation. Cans presenting defects through which air might enter or contents escape

or which "bulges" or "swells" as the result of gas formation should be rejected for food. Upon inspecting suspected cans, care should be taken when opening the can not to damage contents. The contents should be carefully examined for abnormal odor, appearance, or taste indicative of decomposition. The inside surface of the can should be inspected for evidence of black discolorations due to chemical reaction. Any abnormal odor or appearance should be considered as indicative of decomposition and as a cause of condemnation.

SECTION V

MILK AND DAIRY PRODUCTS

■ 122. DAIRY FARMS.—*a. Milk.*—Milk is a most important agency of transmission for certain pathogenic organisms. It is usually served in an uncooked state and, consequently, many of the organisms which it may contain will be viable when ingested, therefore strict sanitary supervision during all stages of production is essential. When possible, the use of milk should be confined to establishments operating under supervision of the Army veterinary inspection service. A dairy farm examination consists of an investigation into the sanitation of the dairy farm establishment and all parts, equipment, employees' health and hygiene of dairy animals, methods of operation, and products concerned.

b. Inspection.—Under certain conditions it may be necessary to investigate the conditions under which milk is produced. All bovines on the dairy farm should be free from disease as shown by a thorough physical examination conducted by a qualified veterinarian. The barns should be well ventilated, providing at least 3 square feet of window space and 500 cubic feet of air space for each animal. Manure must be removed and disposed of in such a manner as to prevent fly breeding. All milking utensils must be of non-absorbent material, in good repair, and properly sterilized. Milk must be promptly cooled within 1 hour after milking to 50° F. and maintained at or below that temperature until delivered to the pasteurizing plant (AR 40-2230). All personnel concerned with milking or handling of milk should be familiar with the necessity of strictest sanitary precautions

and be required to undergo careful periodical physical examination to assure freedom from contagious or communicable disease.

■ 123. PASTEURIZING ESTABLISHMENTS.—*a. General.*—Pasteurization is the heating of all particles of milk or milk products to a temperature of not less than $143\frac{1}{2}^{\circ}$ F. and holding at such temperature for not less than 30 minutes in approved pasteurization apparatus. The hygienic condition of fresh milk depends to a considerable degree upon the conditions existing at the source of supply. Insanitary milk due to diseased animals or contamination at the source is correctible only in part, therefore it is necessary that milk be obtained from healthy cows and produced and handled under hygienic conditions even when it is pasteurized.

b. Inspection.—Inspection of pasteurizing plants requires, in addition to a thorough knowledge of the pasteurizing process, an adequate understanding of the equipment, its construction, installation, and operation. Pasteurizing plants should have in satisfactory operation vats or holders in which the temperature of the milk is raised to at least $143\frac{1}{2}^{\circ}$ F. and held for 30 minutes, automatic devices for registration of the pasteurizing temperature, coolers wherein the milk may be rapidly cooled to 45° F. or less after pasteurization, automatic bottling and capping machines, automatic bottle washers, and facilities for cleansing and sterilizing all parts of the pasteurizing equipment with which the milk comes in contact. All milk bottles should be sterilized before being filled and all pasteurizing equipment sterilized immediately before being used. Cleanliness throughout is essential in the operation of a milk plant. Pasteurization plants should be efficient and meet all sanitary requirements as to construction, equipment, personnel, products, and methods of operation. An ample supply of safe water and steam for cleansing and disinfecting purposes is essential. Doors, windows, and other openings should be screened and kept in good repair.

■ 124. MILK.—*a. General.*—Milk issued to troops for beverage and cooking should be grade A pasteurized. When this is not obtainable, grade B pasteurized milk may be used. The use of bulk milk should be discouraged and the use of

raw milk should not be countenanced. If grade A or grade B pasteurized milk is not available, evaporated milk should be used.

b. Inspection.—Samples for bacteriological and chemical analysis should be frequently obtained for laboratory tests. These should be packed in ice and promptly transferred to the laboratory. If laboratory facilities are not available locally, a sample should be furnished corps area laboratory for analysis (AR 40-310). Use a sample of 1 quart of milk and pour it 25 times between sterile containers. Then add 1 cc of commercial formalin to the quart of milk and agitate thoroughly. Fill sample bottle flush with lower end of stopper and fasten securely. Label specimen, furnishing following information: Station from which sent, date of collection, nature of specimen, specific examination required, name of establishment from which milk was obtained, and the word "formalized."

c. Storage.—Milk should be placed in clean refrigerated storage at a temperature of 45° F. promptly upon receipt. Underground ice or cooling box may be utilized for short storage periods. Bottled milk should not be submerged in water for cooling because the contraction of the contents accompanying the cooling process may create a sufficient vacuum within the bottle to suck in water around the edge of the cap resulting in possible contamination.

■ 125. CONDENSED MILK.—*a. General.*—Condensed milk is primarily fresh milk from which a part of the water has been removed and to which sugar may or may not have been added.

b. Storage.—It should be stored at temperatures below 60° F. and above freezing and the cases should be occasionally turned in order to offset the tendency of the fat to separate and of the milk to solidify. Long storage is undesirable due to tendency of acid content of milk to react on metal of the container producing off flavors, solidification, or swells due to hydrogen gas.

c. Inspection.—Deterioration of condensed milk is evidenced by the formation of gas, the development of abnormal tastes or odors, or by discoloration. Cans presenting the above conditions should be rejected for food. Certain of the

constituents of milk may settle out to form precipitates, however, this does not necessarily indicate that the milk is unsuitable for food. Such supplies should, however, be very carefully examined for evidence of other conditions which would render the product unfit for food.

■ 126. BUTTER.—*a. General.*—Butter is the fat derived from milk or sweet or sour cream, formed into a mass together with water and small amounts of other natural constituents of milk, such as curd, lactose, and acid. It is essential that the production of butter be safeguarded in the same manner as the production of milk.

b. Storage.—Butter exhibits a marked tendency to absorb odors and tastes from other substances and for this reason should not be stored in the same place or close to odorous substances such as fish, cheese, or certain vegetables. If butter is to be held for any considerable length of time it should be placed in cold storage at a temperature of from 5 to 10 degrees below zero F. where it may be held for as long as 6 months without deterioration. Butter should not be held at temperature of from 20° F. to 30° F. for longer than 1 month and storage space should be kept dry and clean.

c. Inspection.—Sanitary butter should be clean, sweet, of an agreeable aroma, palatable, of fine texture and grain, and should not contain adulterations, insects, or foreign substances. It is bright in color and of a light straw shade.

CHAPTER 7

FLY CONTROL

	Paragraphs
SECTION I. Development and characteristics of the fly.....	127-128
II. General control measures.....	129-130
III. Fly traps.....	131-135
IV. Other special measures.....	136-140

SECTION I

DEVELOPMENT AND CHARACTERISTICS OF THE FLY

■ 127. DEVELOPMENT.—The housefly (*Musca domestica*) develops by complete metamorphosis as follows:

a. *Egg*.—The eggs of the housefly are oval, white, glistening bodies about 1 millimeter in length. They are deposited in clusters or masses on or in moist organic material. The individual fly deposits 100 to 150 eggs at one time and lays two to four batches during her lifetime. Under favorable circumstances the number of eggs may be increased to over 2,000. The length of egg stage varies from 8 hours at a temperature of 85° F.—90° F., about 24 hours when the temperature is between 60° F. and 68° F., and in 2 or 3 days at a temperature of 40° F.

b. *Larva*.—Newly hatched larvae (maggots) are about twice the length of the egg. They grow rapidly and feed on organic matter. They develop by successive molts reaching maturity under average conditions in 4 to 5 days. Cold, lack of food, and moisture will prolong the larval stage. Optimum temperature is about 90° F.

c. *Pupa*.—The pupae are dark in color and about 6 millimeters in length. Pupae are nonmotile and do not feed. Under average conditions this stage lasts 3 to 10 days.

d. *Adult*.—When the adult fly emerges from the puparium it crawls upward through the loose soil, manure, or other material to the surface. As soon as the wings harden it is ready for flight. The female reaches maturity and oviposition begins in 2½ to 20 days after emergency from puparium.

The newly hatched fly does not grow after it leaves the puparium but emerges full size.

■ 128. RANGE OF FLIGHT.—The housefly does not migrate very far if food and breeding places are accessible. Normally this is from 500 to 1,000 yards. They may be carried on animals, in vehicles or by wind currents much greater distances.

SECTION II

GENERAL CONTROL MEASURES

■ 129. HABITS TENDING TOWARD CONTROL.—The principal habits and characteristics of the housefly which are to be considered in the formulation and execution of control procedures are—

a. The preference for horse manure as breeding material and the tendency to breed freely in horse and other animal manure, human excreta, and fermenting vegetable wastes.

b. The necessity for moisture, warmth, and soluble food for the normal development of the larvae.

c. The susceptibility of the larvae to temperature of 110° to 115° F.

d. The tendency of the mature larvae to migrate from the breeding material prior to pupation.

e. The development of the pupa at or beyond the borders of the mass of breeding material.

f. The ability of the larvae and the adult insect to crawl through loose manure or earth.

g. The attraction of adult flies to food by odor.

h. The tendency of flies to fly toward light.

i. The tendency of flies to rest on vertical surfaces or hanging objects.

■ 130. DESTRUCTION OF ADULT FLIES.—Adult flies may be destroyed by the use of traps, fly paper, poison sprays, and swatting. These measures are temporary ones, and the elimination of breeding places and destruction of immature forms of the insect are more important.

SECTION III
FLY TRAPS

■ 131. TYPES OF TRAPS.—*a.* Fly traps vary in design and size but all consist of two main parts, the bait chamber and the trap chamber. The bait chamber is the lower and darker part of the trap into which the flies are enticed by the odor of the bait. The trap chamber is the upper part and is connected

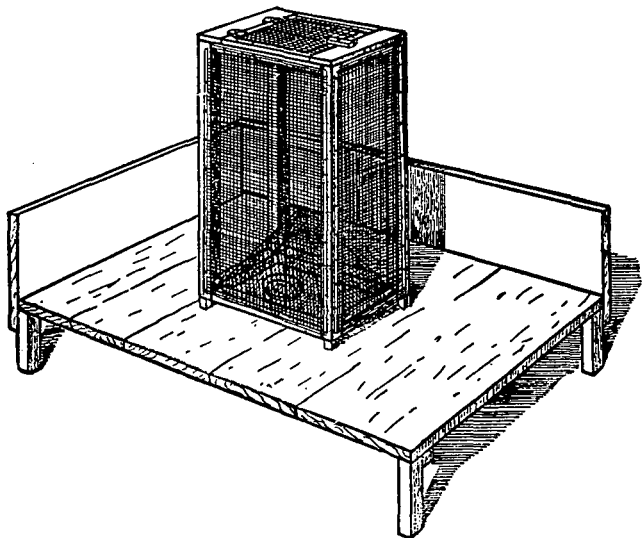

FIGURE 42.—Square fly trap with board windshield to protect the trap from the wind.

with the bait chamber by an aperture through which the flies crawl toward the light after having fed on the bait.

(1) The *square trap* is from 12 to 18 inches square and 18 to 24 inches in height (see fig. 42).

(2) The *round trap* is similar to the square trap except as to shape. Nail keg hoops are valuable in the preparation of the framework.

(3) The *box trap* is made in the same manner as the square trap except that the sides are made of boards. The cone and lid are made of screening.

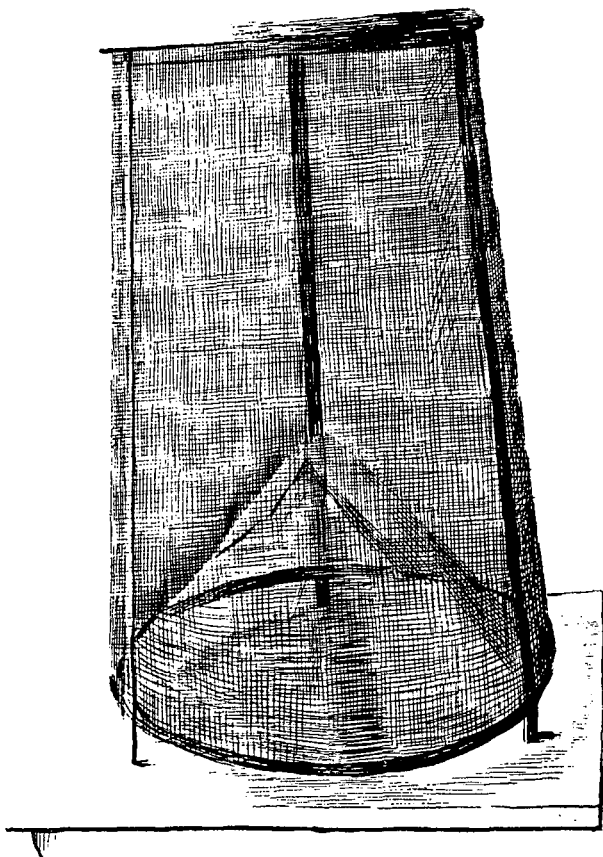

FIGURE 43.—Round fly trap with conical shaped bait chamber and removable top or lid.

(4) The *triangular trap* should not be less than 12 inches high and 12 inches long and made as shown in figure 45. If traps are less than 12 inches in length the solid ends exclude much of the light necessary to attract flies into the trap chamber.

b. Comparative effectiveness of square, round, triangular, and box traps.—The square and round traps are more effective than the triangular trap, principally because the light enters the trap chamber from all sides. They are, however, more difficult to construct than the triangular trap. Exposure to the weather, and the handling to which fly traps

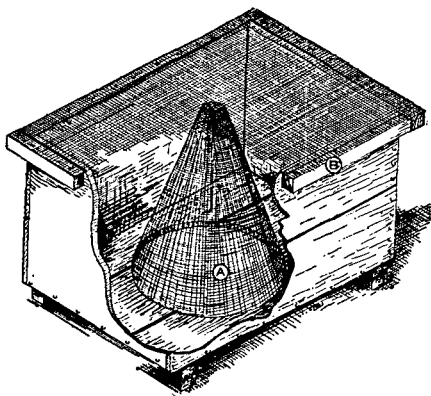

FIGURE 44.—Fly trap constructed of packing box. Corner cut away to show method of installing cone.

are subjected, will cause the square and round traps to warp and become unserviceable much sooner than the triangular traps. Despite the fact that the triangular trap is somewhat less effective as a single unit than the square or round trap, it will as a rule prove more practical for use in camps and large stations than either of the latter because of the comparative ease and rapidity with which it can be constructed in large numbers, the availability of material, and greater serviceability. The box trap will not catch as many flies as the square or round trap, largely because the wooden sides exclude the light from the trap chamber. The box

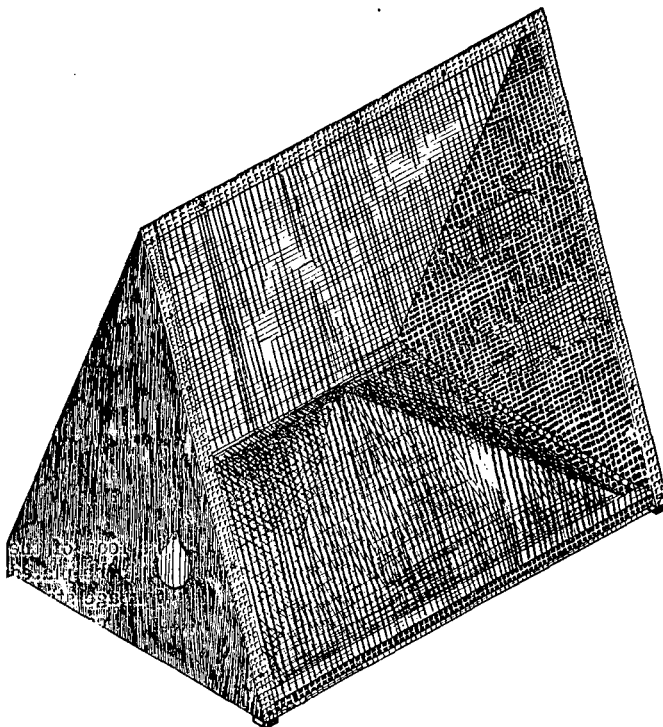

FIGURE 45.—Triangular fly trap with cone shaped bait chamber. Single opening at apex of cone leading into trap chamber. The small tin disk covers an opening through which flies may be removed from the trap chamber.

trap is, however, more durable than any of the others and if packing boxes are available, it can be more quickly and cheaply constructed.

■ 132. FLY TRAP STANDS.—The efficiency of fly traps is increased if they are elevated above the ground on stands or on boxes, benches or tables. The stand affords a smooth base for the trap and a place to alight before entering the

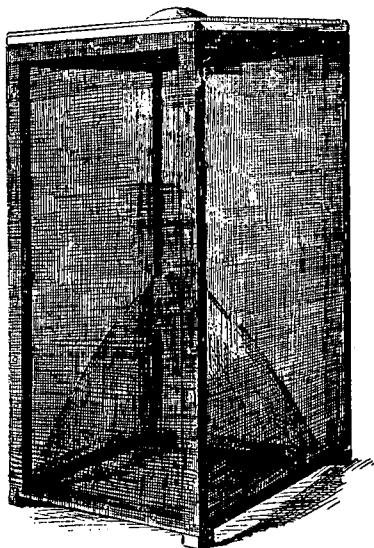

FIGURE 46.—Square fly trap with removable top and pyramidal bait chamber.

trap. It also protects the bait from dirt and may be so constructed as to protect trap from the wind.

■ 133. LOCATION.—Fly traps should be placed in or near breeding places such as manure piles or latrines, or in the vicinity of mess halls, kitchens, or dumps.

■ 134. FLY BAITS.—Baits must have an odor that will attract flies but will not constitute a nuisance. The material should

be cheap and readily obtainable. In general, there are two types of bait, *putrefactive* and *fermented*:

a. Putrefactive baits consist of spoiled raw meat or fish. Fish heads or canned salmon may be used.

b. Fermented baits are those which contain alcohol or in which alcohol is being formed. Usually, they consist of a mixture of cereal, sugar or molasses, yeast and water, which is allowed to ferment before or while being used as a bait. A formula for a cornmeal bait is as follows:

(1) Ingredients:

Cornmeal-----	8 ounces (by volume).
Molasses-----	5 ounces.
Water-----	16 ounces.
Yeast-----	½ cake.

(2) *Preparation*.—Mix the water and the molasses and heat to boiling. Pour the molasses and water while boiling over the cornmeal, stir, and allow to cool. Add the yeast and allow to stand exposed to the air for 3 or 4 days.

(3) Bran or cornstarch, or bran and cornstarch, may be substituted for the cornmeal if the latter is not available. Syrup made of water and sugar may be substituted for the molasses.

(4) Other fermented baits may be made as follows:

(a) Two parts of molasses and one part of vinegar.

(b) Molasses which has been allowed to stand exposed to the air for 3 or 4 days.

(c) Crushed, overripe bananas in milk.

(d) Brown sugar and sour milk.

Under comparable conditions various baits may be rated as follows:

Putrefying meat-----	100
Fermenting cornmeal-----	95
Molasses and vinegar-----	80

■ 135. CARE.—The following directions should be followed in caring for fly traps:

a. Place bait in wide shallow containers so that volatile constituents are readily evaporated and flies have easy access to bait.

b. There should be at least 3 inches between edge of bait pan and edge of trap.

- c. Two bait pans should be used in large traps.
- d. Baits should be inspected once daily.
- e. Solid baits such as meat or fish should not be allowed to become dry.
- f. Bait pans should be kept filled to desired level and be cleaned and refilled when scum forms on surface.
- g. All baits should be kept free from dirt and dust.
- h. Empty traps whenever a sufficient number of flies accumulate so as to interfere with light, otherwise empty traps at about weekly intervals.

SECTION IV

OTHER SPECIAL MEASURES

■ 136. FLY WIRES AND FLY PAPER.—Paper or wire covered with fly mucilage may be used to trap flies indoors. Fly wires consist of pieces of wire 18 to 36 inches long, bent at one end to form a hook or eye and twisted in a circular manner at right angles at the bottom to prevent dripping. Two or more wires may be twisted together. Wires are coated with mucilage and suspended from the ceiling. They should be cleaned and recoated at frequent intervals. Fly mucilage is made by beating together one part by weight of castor oil and two parts of white rosin. The hot material is stirred while being heated until a sticky, homogeneous mass is obtained. Care should be taken to avoid boiling. A good grade of white rosin should be used as the crude product renders it difficult to secure a homogeneous mixture and produces an odor that is repellent to houseflies. Variations in atmospheric temperature and in the grade of oil or rosin used may render it necessary to vary the relative proportions of the ingredients

■ 137. FLY POISONS.—*a.* The two substances commonly employed for fly poisons are formalin and sodium salicylate:

(1) Formalin poison consists of about 3 teaspoonfuls of formalin to a pint of water. It is better to use equal parts of water and lime water or water and milk. Formalin solutions should be freshly made. A small quantity of fermented molasses added to formalin bait makes it more attractive.

(2) Sodium salicylate poison is made from a 1 percent solution of the drug with the addition of a small amount of brown sugar.

b. Poison baits should be put out in shallow containers with pieces of bread or blotting paper soaked in the poison so as to give the flies a place on which to light.

■ 138. FLY SPRAYS.—Fly sprays depend largely on extracts of pyrethrum flowers. An efficient fly spray can be made by soaking crude pyrethrum powder in kerosene, in proportion of from $\frac{1}{2}$ to 1 pound of the powder to 1 gallon of kerosene, for from 2 to 4 days. The supernatant liquid is then decanted or siphoned off and is ready for use as a spray. Its insecticidal power is appreciably increased by the addition of approximately 1 ounce of the oil of pennyroyal or citronella to 1 gallon of the extract. The efficacy of pyrethrum as an insecticide depends upon the pyrethrin content of the particular lot of pyrethrum used. Extracts of pyrethrum are available on the market in which the pyrethrins extracted from 20 pounds or more of the standardized pyrethrum flowers are contained in 1 gallon of the extract. A fly spray which is approximately equal in toxicity to the kerosene spray described above can be made by diluting the concentrated extract with 20 volumes of kerosene. A more potent spray may be made by using a proportionately greater quantity of the extract.

■ 139. SWATTING.—Fly swatting in kitchens and mess halls is a valuable control measure and should be used just before food is placed on the table.

■ 140. SODIUM ARSENITE.—A very good material for spraying compost piles, latrines, etc., is made as follows:

Commercial sodium arsenite.....	4 pounds.
Molasses.....	2 quarts.
Water	50 gallons.

CHAPTER 8

MOSQUITO CONTROL

	Paragraphs
SECTION I. Development, habits, and characteristics of the mosquito.....	141-145
II. Control measures.....	146-164

SECTION I

DEVELOPMENT, HABITS, AND CHARACTERISTICS OF THE MOSQUITO

■ 141. **GENERAL.**—Mosquitoes are known as transmitters of malaria, dengue, yellow fever, and filariasis. The most important of these from a military viewpoint at the present time is malaria. In order to successfully combat the disease-bearing mosquito something must be known of its life habits. All species are not vectors, and as various genera and species differ as to habits it is important that before starting an antimosquito campaign the specific vector or vectors be well known. This knowledge will prevent much useless effort.

■ 142. **LIFE CYCLE.**—Mosquitoes develop by complete metamorphosis and the life cycle consists of egg, larval, pupal, and adult stages. The egg, larval, and pupal stages are passed in water while the adult is a free flying insect.

a. Egg Stage.—Mosquito ova are dark, oval bodies varying in size from 0.5 to 2 millimeters in length. They are deposited either singly or in masses on the surface of water or near the edge of water collections.

(1) In a favorable environment, the eggs of *Anopheles* are deposited singly on the surface of water, usually in batches of from 40 to 100 or more. *Anopheles* ova are 0.5 to 0.8 millimeter in length. They are boat-shaped with a membranous ribbed structure or float on either side. If undisturbed, *Anopheles*' eggs tend to collect together into triangular, star-shaped, or ribbon-like groups or patterns.

(2) The eggs of *Aedes aegypti* are usually deposited on the surface or near the edge of water contained in artificial receptacles located in or near inhabited buildings. Natural

collections of water which are near occupied houses may be utilized as breeding places. The eggs may be deposited on the sides of the container or on the earth above the level of the water. They are laid singly, usually in lots of 25 to 50 or more. Those laid on the surface of the water may sink to the bottom without interference with hatching. In an unfavorable environment, the eggs of *Aedes aegypti* may lie dormant for months without losing their vitality. They are resistant to drying and cold and will hatch if placed in water after several months storage in dry or cold places.

(3) The eggs of *Culex* are deposited in rafts or boat-shaped masses, 4 to 8 millimeters in length, consisting of 100 to 400 eggs cemented together.

b. Larval stage.—Mosquito larvae are actively motile, cylindrical organisms. They vary in length from 1 millimeter to about 10 millimeters, depending on the genus and species and the stage of development. They may be gray, green, yellowish or reddish brown, dark brown, or black in color.

(1) The mosquito larva develops by molting, that is, the skin splits and a larger and more fully developed form emerges. The larva molts four times and at the fourth molting passes into the next, or pupal, stage.

(2) Given a relatively high atmospheric temperature, ample food supply, and other favorable conditions as to sun and shade, the larval period of development may be completed in as short a time as 5 days. In a more adverse environment, especially if the temperature is low, development is inhibited and the larval stage may be prolonged for several weeks. Under average conditions in the Tropics, or during the warm seasons of the year in the temperate zones, the larval period is usually completed in about 10 days.

(3) The larval phase of development is divided into four stages or instars. Under certain conditions, the stage of larval development may be an important factor in estimating the efficacy of larvicidal control and determining the frequency with which larvicides should be applied. The first stage, or first instar, larva is the form that emerges from the egg. It is a minute, nearly transparent body. First stage larvae develop rapidly and reach the first molt in about 24 hours, when they pass into the second stage, or second instar.

The second stage larvae are darker, larger, and more easily detected in the water. In the second stage the specific anatomical characteristics are more fully developed than in the preceding stage. After a period of growth the second stage larvae molt and enter the third stage. During the third stage, feeding and growth continue until molting occurs, when the fourth stage forms emerge. Fourth stage larvae are mature and practically full grown. The head is broad and prominent. After a period of feeding the fourth stage larva becomes quiescent and soon thereafter the skin splits to permit the pupa to escape. The larvae move tail foremost through the water by relatively rapid darting or jerking movements.

c. Pupal stage.—A mosquito pupa is a comma-shaped body enclosing the developing adult within a pupal case. The head and thorax of the insect form a globular mass called the cephalo-thorax, to which is attached the curved flexible abdomen. Two paddle-shaped appendages are attached to the extremity of the abdomen and two breathing tubes or trumpets arise from the dorsum of the cephalo-thorax. The pupae obtain air through their breathing trumpets. They are actively motile, locomotion being accomplished by flexion and extension of the abdomen. They have no mouth parts. The pupal stage varies somewhat in length, but usually lasts 24 to 72 hours. At the end of that period the pupal case splits and the full-grown insect gradually emerges. As soon as the wing veins and the exoskeleton have hardened in the air the mosquito is ready for flight.

d. Adult stage.—With few exceptions the female mosquito is a bloodsucking insect. It is probable that blood is required to stimulate the mating instinct and for the development and maturation of the ova. The males have no piercing mouth parts and subsist entirely on plant juices and exudates.

■ 143. LONGEVITY.—Under favorable conditions it is probable that the adult female mosquito may live as long as 3 months. They are, however, subject to many dangers from natural enemies and from adverse climatic and other environmental conditions. Because of these factors the normal life expectancy of the mosquito is probably 2 weeks to 1 month and, when breeding places are controlled, the majority of the adult

forms present in a locality may be expected to disappear within a month. Some may, however, hibernate in heated buildings throughout the winter.

■ 144. IDENTIFICATION.—For detailed instructions relative to specific identification see TM 8-255 (now published as Army Medical Bulletin No. 23).

■ 145. DISTRIBUTION AND BREEDING HABITS.—The following table will be of value in antimosquito work. These mosquitoes are the important vectors found in the United States and its possessions. No *Anopheles* are found in Hawaii.

Species	Remarks
<i>Anopheles in United States</i>	
<i>A. quadrimaculatus</i>	Pond breeder, preferring quiet water such as intermittent pooled streams and small ponds. Does not normally breed in streams or acid waters. Most common vector into United States. Is found throughout southern and southeastern states. Become numerous in late spring or early summer.
<i>A. maculipennis</i>	Vector in the far west. Occurs from California to Alaska. Same breeding habits as <i>A. quadrimaculatus</i> . Partial to small, shallow, sunlit pools or collections of water containing green algae.
<i>A. atropos</i>	Breeds in brackish pools and has been found in pools containing grass and algae. Rare species.
<i>A. barberi</i>	Breeds in water in tree holes. Rare species.
<i>A. crucians</i>	Appears early in the spring in the south, reaching a maximum in March or April. Fresh-water variety breeds in pools, ponds, fresh water swamps, etc. The salt-water variety breeds in the brackish water of salt-water swamps and tidal pools.
<i>A. pseudopunctipennis</i>	California, Arizona, New Mexico, and west Texas. Breeds in clear water in pools and springs and along the edges of streams, also in ditches and puddles.
<i>A. walkeri</i>	Breeding places not well known. Seems to prefer water containing considerable vegetation, especially permanent waters. Rare species.
<i>Anopheles in Panama</i>	
<i>A. albimanus</i>	Breeds in fresh or brackish water in pools, ponds, swamps, etc. Apparently prefers water exposed to the sun and that contains algae. More prevalent during rainy season.

Species	Remarks
<i>Anopheles in Panama</i> —Continued	
<i>A. tarsimaculatus</i>	Breeds similar to <i>A. albimanus</i> .
<i>A. argyritarsus</i>	Breeds in small collections of fresh water in seepage pools, small ditches, and hoofprints. Also will breed in water in artificial containers.
<i>A. pseudopunctipennis</i>	Prevalent in dry season.
<i>A. punctimaculata</i>	In Panama breeds in shaded pools and streams.
<i>A. punctipennis</i>	Breeds in pools, in springs, and often in small collections of rain water. It also breeds in and seems to prefer the quiet water along the edges of streams. Appears early in the spring and continues breeding until late in the fall.
<i>Anopheles in the Philippine Islands</i>	
<i>A. minimus</i>	Breeds in clear water streams. Is principal vector in the Philippines.
<i>A. maculatus</i>	Breeds in quiet edges of trickling streams in the open sunshine.
<i>Anopheles in Puerto Rico</i>	
<i>A. albimanus</i>	More prevalent during rainy season. (See Panama.)
<i>Aedes</i>	
<i>A. aegypti</i>	Breeds in water in artificial containers in or near human habitations such as barrels, cisterns, eaves troughs, or gutters. A very small amount of water will suffice.
<i>A. albopictus</i>	Same as <i>A. aegypti</i> . Common in the Orient.
<i>Culex</i>	
<i>C. fatigans</i>	Will breed in water contained in artificial receptacles in or near inhabited houses but also prefer water containing organic material. They will breed freely in water contained in catch basins or cesspools and in swamps, roadside ditches, and puddles.
<i>C. pipiens</i>	Similar in habits to <i>C. fatigans</i> .

SECTION II

CONTROL MEASURES

■ 146. DRAINAGE.—Antimosquito drainage to be effective must usually be planned and installed for the specific purpose of eliminating or reducing the extent of mosquito breeding waters. Ordinary agricultural or roadside drainage not only frequently fails to remove the water in a way that will prevent mosquito breeding but, by spreading the water and increasing its surface area, may actually cause an increase in mosquito breeding. Antimosquito drainage may be accomplished by means of surface ditches of either the unlined, lined, or rock-filled type, or by subsurface tile drains. Careful planning for and supervision of the construction of a drainage system will increase its effectiveness and reduce the cost of maintenance. Grade lines should be established for at least the main ditches or subsurface drains.

■ 147. OPEN DITCHES.—Open ditches should be so constructed that standing water will be completely removed and storm water drained from the face of the ground and from the ditches within a short time after a storm. The grade and width of the ditches should be such that while all water will be carried away, the velocity will not be sufficient to produce "potholes" by erosion of the bottoms or sides of unlined ditches. A ditch that is too wide or too flat may retain water in small depressions and thus defeat the purpose of drainage. Grade lines must be followed during construction as either low areas will be produced which retain water or high sections, which will prevent complete drainage.

■ 148. FACTORS IN DITCH CONSTRUCTION.—*a.* Dig only sufficient ditches to accomplish desired purpose. Too many, increase cost of construction and maintenance.

b. Ditches should be constructed with narrow bottoms, smooth sloping sides, with as few curves as possible, and without sharp turns. Usually, sides of ditches should have a slope of about 45°, in soft mud or sand this slope may be flatter while in rock or clay it may be nearly perpendicular.

c. If ditches are built at an angle to the slope of a hill, the upper side should be somewhat flatter than the lower to lessen erosion.

d. Bottom of all ditches should be U-shaped, not V-shaped.

e. Main ditch should be constructed first and laterals installed only when and where necessary (may have to wait until after a storm to locate additional or all lateral ditches).

f. Lateral or branch ditches should join main ditch at an acute angle or gentle curve in order to prevent debris deposit or erosion of opposite bank.

g. Care should be exercised that dirt thrown out does not form banks which prevent drainage by pool formation.

h. Where ditch goes through a culvert or wherever a pipe section is installed, the grade should be increased to prevent interference with the flow by deposits of debris.

i. At the downstream end of a pipe or culvert, the bottom of the ditch should be lined with stone or concrete to prevent erosion (may screen upper end with iron rod or wood grating to prevent entrance of debris or floatage).

■ 149. **LINED DITCHES.**—In loose soil or in ditches where the flow reaches a high velocity it may be advisable to line the ditches. Lining also facilitates cleaning. Lining may be of concrete or stones set in cement mortar. Continuous concrete lining may be constructed by the use of forms. Ditches less than 2 feet in width should have about a 2-inch lining reinforced with 2-inch mesh poultry wire. Seepage holes should be made in the lining whenever it is probable that water will accumulate or flow behind the lining.

■ 150. **SUBSURFACE DRAINAGE.**—Tiles or rock-filled ditches may be used for this purpose. The tiling used varies in size from 3 to 12 inches. The average depth of tiling below the surface is 2 to 4 feet. The so-called "double decker" drain has proved of value in draining areas where there is a flow of water at all times but where, at certain seasons, the volume of water is too great to be carried by the ordinary tile drains. The double decker drain consists of a ditch, on the bottom of which 6- or 8-inch tile is laid in the usual manner. Instead of completely back-filling the ditch, ordinary sectional, concrete ditch linings (par. 149) are laid on top of or immediately above the tiling. The dry weather flow is carried by the tile line while the wet weather flow is drained away through both the tile line and the superimposed open, concrete-lined ditch.

■ 151. FILLING.—Depressions and low areas which serve to collect and retain water in which mosquitoes breed may, in some instances, be permanently eliminated by filling. Filling may also be employed to reduce the amount of water in areas which are below grade and difficult to drain, and may thus facilitate other control measures. Filling may also be employed to eradicate accidental collections of water in small depressions such as wheel ruts, hoofprints or holes, and pits resulting from construction work. Filling is usually a quite satisfactory method of treating low areas or depressions of varying sizes in which rain water tends to collect, but can be seldom utilized successfully to cope with collections of seepage water. Filling permanently eradicates the breeding places and it has a further advantage over open drainage that no maintenance work is ordinarily required. At times it will be found that, while the first cost is greater, filling is ultimately the cheapest and the most effective method of controlling mosquito breeding in a given area.

■ 152. STREAM TRAINING.—In order to prevent pools and quiet backwater areas, the bends in the stream may be straightened and the marginal depressions removed by filling, draining, or regrading. The stream bed may be narrowed or even regraded in places to increase the velocity. Vegetation and debris in the stream bed, which might retard the flow or shelter the larvae, should be removed.

■ 153. ELIMINATION OF ARTIFICIAL WATER CONTAINERS.—Certain species of *Anopheles* and *Culex*, but especially *Aedes*, will breed in artificial containers. All empty tin cans should be crushed so that they will not hold water before being disposed of on dumps or other places in the open. Barrels, buckets, or other receptacles in which water stands should, if practicable, be emptied and dried in the sun at least once each week. The water in fire buckets may be treated with a phenol larvicide. When vessels of water are emptied, care should be taken to remove or destroy the eggs and larvae on the sides and bottom before refilling. Effective control of mosquito breeding in artificial collections of water can be maintained only by thorough and repeated inspections. Some person or persons should be made responsible by proper authority for

the conduct of such inspections, and the inspections should be made routinely at designated intervals.

■ 154. OILING.—*a.* When properly spread over the water, oil produces a film which kills mosquito larvae and pupae. The lethal effect of oil is probably due to the toxic action of volatile gases after inspiration of the oil into the tracheal tubes. Oils which have a boiling point between 200° to 500° F. have been found to kill larvae and pupae by direct toxic action in about 30 minutes.

b. Oil larvicides consist, generally, of crude oil or waste motor oil, either of which may be diluted with kerosene. Light crude oil which has a specific gravity of from 0.85 to 0.87 spreads readily and will form a satisfactory film in any temperature suitable for mosquito breeding. Kerosene may be used to dilute the heavier oils so that they will spread to form a film. The proportion of kerosene required varies from 20 to 75 percent, depending on the viscosity of the crude oil.

c. Kerosene alone may be used as a larvicide, but it evaporates rapidly, the film is fragile and easily broken, and it is usually too expensive for routine use.

d. Waste motor oil or other waste oils may be used as a base in lieu of the crude oil. Motor oil is relatively nonvolatile and is therefore nontoxic. It will kill larvae and pupae only when the film is sufficiently thick and intact to prevent them from reaching the air. As it is difficult to maintain such a film, the best results are obtained when the motor oil is mixed with and diluted by kerosene in the same manner as crude oil. The resulting product is apparently as efficient in the destruction of larvae as crude oil and, where the waste oil is available, it is considerably cheaper.

e. The spreading quality of any of the oils is greatly increased by the addition of 2 percent of crude castor oil.

f. Oiling is essentially a temporary measure and must be repeated at intervals, the length of which is determined to some degree by the weather conditions, the kind of oil used, and the character of the water. During summer months oil should be applied about once each week. A film of toxic oil which is iridescent in the sunlight is thick enough to kill mosquito larvae. Under the most ideal conditions, in quiet

waters containing no vegetation or debris, 3 to 5 gallons of a light, well-spreading oil will produce a thin but satisfactory film over an area of about 1 acre.

■ 155. OIL APPLICATION.—*a. General.*—Oil may be effectively applied to small collections of water by means of an oil-soaked broom, an oil mop, or oil-soaked cloths tied to a stick or similar contrivances. The ordinary watering pot used for watering plants may be used to oil small collections of water, or the oil may be poured on the surface of the water.

b. Sprayers.—The knapsack sprayer consists of an oil container, hand pump, and spray nozzle, and is carried and operated by one man. The ordinary sprayer has a capacity of about 5 gallons and a spraying range of about 25 feet. The knapsack sprayer is a practical and economical apparatus for applying oil to ditches, small ponds, or other collections of water which can be reached by the spray. Larger sprayers may be employed to oil extensive areas such as the borders of large lakes or, in some instances, large swampy places. Such a sprayer usually consists of a barrel or tank container and a pump mounted on a vehicle or boat.

c. Continuous oilers.—Where the oil is dispersed by currents, as in streams or ditches, a film can be maintained only by the constant application of oil. This type of oiling has many disadvantages and is as a rule of three types:

(1) Drip oilers which consist of a 5-gallon tin or drum which is placed on supports over the stream or ditch so that the oil will drip on the surface of the water below. It should be several feet higher than the stream surface so that the oil will spread quickly when the drop strikes the water. The rate of flow to furnish a satisfactory film depends on a number of factors. Generally, an average flow of from 10 to 20 drops per minute will suffice for each foot of width of water in the stream.

(2) Submerged oilers are containers having 2 small openings and so designed that when sunk to the bottom of the stream or pond, oil will escape through one opening and be replaced by water which enters through the other. They have the disadvantage that they are difficult to adjust so that the oil will flow properly and the opening is easily clogged.

(3) Oil may be applied continuously by means of a weighted, submerged bag of oil-soaked sawdust or oil-soaked sawdust may be scattered over the surface.

■ 156. PHENOL LARVICIDE.—*a.* The Panama larvicide is the best example of this type of larvicide. It is made as follows:

Crude carbolic acid..... 5 gallons.
Rosin (finely crushed and sifted) 6 pounds.
Caustic soda..... 1 pound.

Heat carbolic acid in iron container until it is steaming hot, the resin is added, and the solution stirred until the resin is completely dissolved. The caustic soda is dissolved in a pint of water and added and the heating and stirring is continued for about 5 minutes. A sample of the mixture is then poured into water and if a complete emulsion results, the larvicide is ready for use. If the mixture does not emulsify in water, or the emulsion is incomplete, the heating and stirring are continued until a satisfactory emulsion is obtained. The crude carbolic acid should contain not less than 15 percent of phenol and have a specific gravity of not more than 0.97.

b. The Panama larvicide is prepared for use by mixing one part of the larvicide with five parts of water. The resulting emulsion is applied by spraying, or in the case of small collections of water, a watering pot may be used or the larvicide may be poured into the water. The larvicide should be applied in such amounts that an emulsion with the treated water of from 1 to 1,000 to 1 to 10,000, preferably about 1 to 5,000, will result. An emulsion of 1 to 5,000 will kill the larvae in about 10 minutes. The Panama larvicide can be used wherever hand oiling is feasible. As it kills the greater proportion of the larvae, it need be applied only at such intervals as will prevent complete larval development. This interval is usually 1 week but may be as long as 3 weeks.

■ 157. PARIS GREEN LARVICIDE.—Commercial paris green containing not less than 50 percent of arsenious oxide is used, diluted with some inert dust. The diluting dust may be hydrated lime, road dust, powdered limestone, soapstone, ashes, or stearates of calcium and aluminum. This larvicide is cheap, easily transported, and very effective against larvae of the anopheles. It is ordinarily diluted with 99 parts of the

diluting material to one part of paris green. The mixture may be prepared in an eccentrically mounted keg as shown in figure 47. The larvicide may be applied by means of a hand blower of bellows type or by means of a hand-operated duster similar to those used in agriculture for dusting fruit trees. For large swampy areas with rather open waters the larvicide may be applied by means of an airplane. The airplane flies low (75 feet from ground) at about 80 miles per hour. It is difficult to apply paris green in windy or rainy weather.



FIGURE 47.—Equipment for mixing and applying paris green larvicide.

■ 158. DESTRUCTION BY NATURAL ENEMIES.—Fish and certain aquatic insects are natural enemies of mosquito larvae. Top feeding minnows are most effective for this purpose. The fish should be indigenous to the locality in which they are used. The most efficient minnow for use in the United States is the *Gambusia affinis*. This fish is found in all States east of the Rocky Mountains and south of Delaware and Illinois. All vegetation and flottage which might protect larvae should be removed before the fish are introduced.

■ 159. DESTRUCTION OF ADULTS.—Adult mosquitoes may be destroyed by spraying with pyrethrum spray, by fumigation (in buildings), by swatting, and by hand catching.

■ 160. SCREENING.—Mosquitoes may be kept out of buildings by effective screening. This is difficult in temporary buildings on account of cracks and other openings. While a mesh of 16 wires to the inch will exclude *Culex* and *Anopheles*, it requires 18 wires to the inch to exclude *Aedes*. Copper screening should be used near the sea as the ordinary galvanized screening deteriorates very rapidly.

■ 161. MOSQUITO NETS.—*a.* Mosquito netting or bars are employed for individual protection against mosquitoes and their effectiveness in this respect depends upon the care exercised by the individual. They are utilized principally where troops are sleeping in tents or in poorly screened buildings. The degree of protection which can be attained by the use of mosquito bars is largely a question of discipline. Troops, in general, object to sleeping under mosquito bars and will not use them in the proper manner unless suitable orders are enforced by unit commanders. Mosquito bars should be so adjusted that no part of the netting will touch the sleeper and so that the lower edges of the netting are tucked in under the bedding completely around the bed. If the netting touches the bare skin of the occupant of the bed, mosquitoes will be able to bite through the spaces between the threads. If the netting is not tucked in under the bedding upon which the sleeper is lying, mosquitoes will gain entrance between the bedding and the netting. The mosquito net may be made and installed so that the lower edges reach and lie upon the floor.

b. A mosquito bar frame should be provided for beds and cots, while in the case of shelter tents the netting should conform to the shape of the interior of the tent and be suspended from the tent.

c. During the day all mosquito bars should be rolled up to prevent mosquitoes from hiding within the folds. When put in place at night, the interior of the net should be searched for mosquitoes. All nets should be inspected at regular intervals for tears, holes, and broken threads.

d. During dusk and the early hours of the night, *Anopheles* and *Culex* bite freely in the open. Men on guard and others whose duties require them to remain out of doors in localities where infected *Anopheles* mosquitoes are prevalent should be provided with head net and gloves.

■ 162. MOSQUITO REPELLENTS.—Various essential oils are at times applied to the person as mosquito repellents or deterrents. These are of value for short periods only as they soon volatilize. When individuals are obliged to spend time in the open exposed to mosquitoes, especially at night, repellents will be found of value as a small quantity applied to the neck and face or to the wrists and hands will last all night. It is nonirritating to the skin. This repellent is prepared by melting 60 grams of white petrolatum and then adding the following: 15 cc citronella oil, 8 cc spirits of camphor, and 8 cc oil of cedar wood. Stir well, pour in jars, and cool rapidly by placing jar in refrigerator or basin of cold water.

■ 163. MOSQUITO SURVEYS.—Mosquito surveys are conducted for the purpose of determining the most feasible, and usually the quickest and least expensive procedures for controlling the disease-transmitting species in the area under consideration.

a. Normally, the most important features of a mosquito survey are the identification of the species involved, study of the relative density and importance of each species, and the location of the breeding places of the species, or of each species if there is more than one present. It is usually essential that the species of mosquito concerned be determined, and this phase of the survey is of special importance if *Anopheles* are to be controlled when there are two or more species breeding in the vicinity.

b. In making a mosquito survey and deciding upon the control measures to be instituted, consideration must be given to the degree of protection required or obtainable and the funds and facilities available for mosquito control purposes. In war, it may be that the mission of the troops or the exigencies of the military situation will be such that only partial control will be required or obtainable. In con-

centration or rest areas, the lack of time and facilities, or even enemy activities, may render it inexpedient to attempt to obtain more than partial control of a varying degree. On the other hand the conditions at fixed installations during peace, or in the zone of the interior or communications zone during war, are usually such that the disease-bearing mosquitoes can be adequately controlled.

■ 164. METHOD OF CONDUCTING MOSQUITO SURVEY.—*a.* Identify prevailing species.

- b.* Locate all breeding places.
- c.* Dispersion of adult mosquitoes.
- d.* Nature of terrain.
- e.* Climatic conditions.
- f.* Facilities for control work.
- g.* The disease situation.
- h.* The military situation.

CHAPTER 9

CONTROL OF LICE

	Paragraphs
SECTION I. General.....	165-168
II. Methods of disinfection.....	169-178

SECTION I

GENERAL

■ 165. DISEASES TRANSMITTED.—Typhus fever, trench fever, and relapsing fever.

■ 166. CLASSIFICATION OF LICE.—The species of lice (*Pediculus humanus*) which infest man are *P. humanus corporis* (body louse), *P. humanus capitis* (head louse), and *Phthirus pubis* (crab louse).

■ 167. LIFE CYCLE.—Lice develop by incomplete metamorphosis. They pass through three stages: the egg, the larva, and the adult.

a. The eggs are deposited on the hairs of the body or head or the fibers of clothing. They are ovoid in shape and about 1 millimeter long. The egg hatches in about 8 days at a temperature of 86° to 90° F. At a lower temperature the egg stage may be prolonged several weeks. The eggs are operculate.

b. The larva is similar to the adult except that it is much smaller (pin head and white in color). Unless the larvae obtain food within 24 hours they will die. The larval form molts three times at about 3-day intervals and emerges sexually mature.

c. The adult female starts to lay eggs within a day after emergence from larval stage. Eggs are laid at a rate of 5 to 10 per day and under favorable conditions continued for 30 days.

■ 168. CONTROL MEASURES.—a. In order to be effective, measures for the control of lice must accomplish complete disinfection of both the individual and the unit to which the

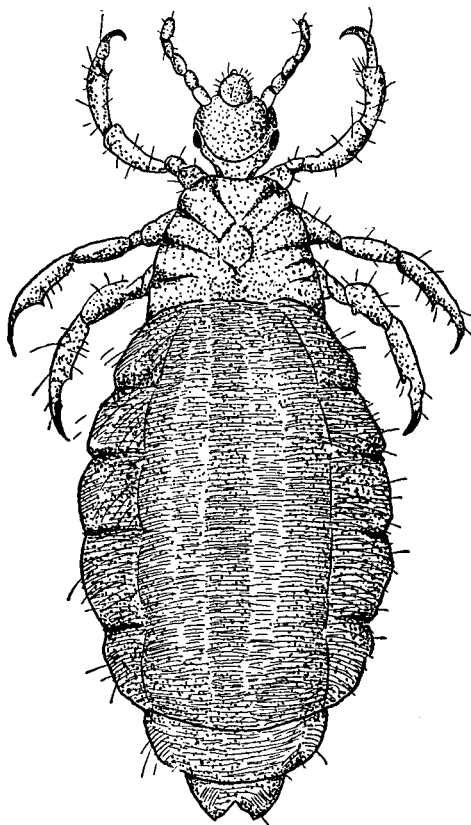

FIGURE 48.—*Pediculus humanus corporis* (body louse).

infested man or troops belong. Control measures are directed toward—

- (1) Disinfestation of the individual.
- (2) Disinfestation of clothing and equipment.

To be successful, the soldier's body as well as his equipment and clothing must be freed from ova, larvae, and adult lice. Bathing and disinfestation of clothing are carried out simultaneously.

b. Lice and their eggs are killed in 1 minute when subjected to dry heat at a temperature of 155° F. or in 5 minutes at 131° F. Immersion in boiling water for 30 seconds will kill

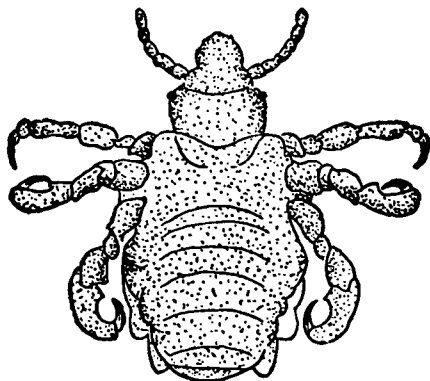

FIGURE 49.—*Phthirus pubis* (crab louse).

both adults and eggs. Dry heat will not injure leather, felt, or webbing but will harm woolen fabrics. Boiling water will cause shrinking of wool but steam causes very little shrinkage.

SECTION II

METHODS OF DISINFESTATION

■ 169. BATHING.—*a.* This may be carried on in either a fixed installation, a quartermaster bathing and delousing unit, or by means of improvised shower baths.

b. An excellent soap to use is made as follows:

Boil 1 part of ordinary issue soap in 4 parts of water.

Add 2 parts of kerosene.

Mix with 4 parts of water.

c. A simple device for bathing can be made from a water sterilizing bag suspended from a scaffold or a tree limb. One faucet of the bag is replaced by a rubber tube in the end of which is placed a short section of pipe closed at one end and perforated at a number of places to act as a shower head.

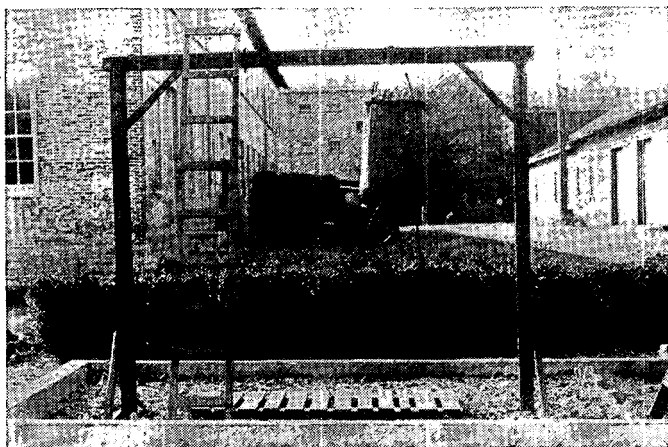

FIGURE 50.—Shower bath made from water sterilizing bag.

d. A perforated kerosene or gasoline can with a perforated bottom resting on a platform may be used with one man pouring water through while another bathes.

e. A more elaborate device may be made by means of inserting a small perforated tin can in the bottom of a barrel. The water is retained in the barrel by means of a plunger which fits into the can. This plunger is controlled by means of a lever and handle within reach of the bather.

f. Bathing with soap and water will not, in many instances, destroy all of the eggs attached to the hairs of the body.

Where infestation is evidenced either by the presence of eggs on the hairs or by indication of louse bites the hair in the axillary, pubic, and inguinal regions and, if necessary,

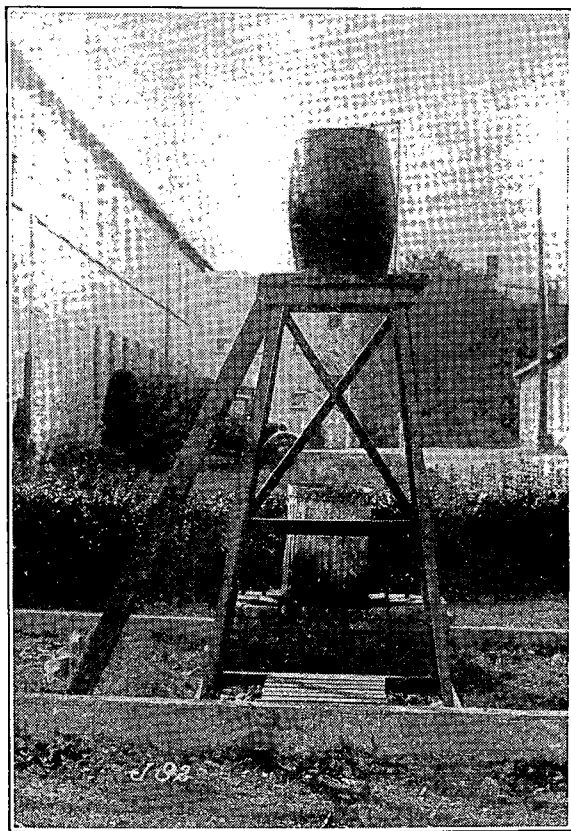

FIGURE 51.—Shower bath.

on the chest should be shaved or clipped. If shaving or clipping is not practical, these parts of the body surface should be thoroughly scrubbed with vinegar, kerosene, or gasoline.

■ 170. DISINFESTATION OF CLOTHING AND EQUIPMENT.—Outside of permanent installations and delousing units the disinfection of clothing and equipment is done by means of one of the following methods:

- a. Mobile disinfestor.
- b. Serbian barrel type of disinfestor.
- c. Improvised hot air disinfestors.
- d. Hot irons.
- e. Hot water.
- f. Storage.
- g. Chemicals.

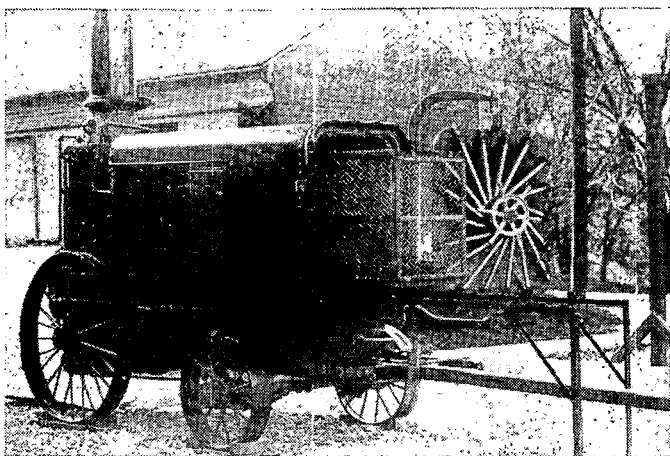

FIGURE 52.—Portable pressure disinfestor.

■ 171. MOBILE DISINFESTORS.—These are of the four-wheel trailer type and are usually steam pressure disinfestors although a current steam disinfestor is manufactured (thresh type). The pressure type consists of a horizontal steam chamber around which there is an outer jacket which is assembled as a unit with a boiler. After the clothing is placed in the disinfestor a vacuum of 10 to 15 inches is created after which steam is turned in until a positive pressure of 15 pounds is attained, this being held for about 20 minutes. At



FIGURE 53.—Disinfestor, Serbian barrel type.



FIGURE 54.—Hooks for suspending material in Serbian barrel.

the end of this time the steam is released and a vacuum of 10 to 15 inches is produced in order to dry the clothing. This vacuum is held for about 5 minutes. Clothing should be placed in loosely in order that the steam may penetrate.

■ 172. SERBIAN BARREL.—*a.* Serbian barrel type disinfestors consist of barrels or similar containers for the material to be



FIGURE 55.—Disinfector, Serbian barrel type, showing water pan and the wire netting across lower opening of steamer.

disinfested, below or in the lower part of which there is a receptacle for water and an improvised furnace or firebox. The ordinary galvanized iron garbage can is usually the most readily available. This can does not need a water receptacle beneath it but does require a screen to keep the clothing from falling down into the water. Water to a depth of about

6 inches is placed in the bottom of the can and the can placed directly over a fire. Hooks on the sides or lid will hold the clothing suspended. The can may be heated over either a single or cross trench. This type of disinfestor may be made from a barrel with tightly fitting lid and water pan beneath, or it may be made knockdown type as shown in figure 57.

b. Operation of a Serbian barrel consists in first heating the water to the boiling point, after which the clothing or equipment is placed loosely in the barrel. The lid is placed

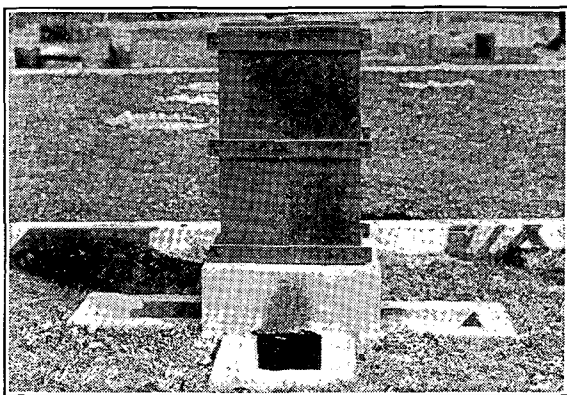

FIGURE 56.—Disinfestor, Serbian barrel type. Steam chest so made that it can be disassembled.

on and disinfestation should continue for 45 minutes after steam begins to escape around the edges of the top or bottom of the barrel.

■ 173. IMPROVISED HOT AIR DISINFESTORS.—Clothing and equipment may be placed in ovens, boxes, or cans and subjected to dry heat. Small buildings or dugouts may be converted into hot air disinfestors by installing heating apparatus which will heat the air to 160° F. Clothing should be hung loosely and exposed for about 30 minutes.

■ 174. HOT IRONS.—Clothing can be partially deloused and the degree of infestation reduced by removing the adult lice

by hand and then killing the eggs by ironing the cloth, especially the seams and folds, with a hot iron. An ordinary sadiron, or a piece of iron pipe or scrap iron with a wooden handle attached, may be used for this purpose.

■ 175. HOT WATER.—Cotton, linen, or silk clothing may be disinfested by immersion in boiling water for 1 minute, or in water having a temperature of 135° F. or more for 5 minutes. In order to disinfect as well as disinfest, the clothing should be subjected to a temperature of at least 160° F. for 15 to 30 minutes. Woolen clothing can be disinfested by this process, but considerable shrinkage will occur. Leather, felt, or webbed articles are damaged by exposure to hot water.

■ 176. STORAGE.—Storage of infested clothing will accomplish disinfestation by depriving the lice of a food supply. When denied access to a human host, the adult forms die of starvation within a 10-day period and the larval forms will survive for only about 24 hours after hatching. However, in order to allow sufficient time for all the eggs to hatch, infested articles should be kept in storage for at least 30 days in cold weather and for not less than 3 weeks in warm weather. Not infrequently, storage is a very practical method of disinfesting clothing and blankets in hospitals or camps, provided clean equipment is available for issue and facilities for storage can be obtained. The rooms or buildings used for storage should be dry. Freshly infested articles should not be stored with those which have been in storage for some time. No article should be removed from a storage room until after all articles in that room have been in storage at least 30 days.

■ 177. CHEMICALS.—*a.* Chemicals such as acetic acid (vinegar), kerosene, gasoline, cresol, or naphthaline may be applied to the person or clothing of the infested individual. Most of these substances will not kill the eggs however.

b. A 5 percent solution of cresol in water is an efficient disinfestant for washing articles such as leather shoes and belts, felt hats, or web belts which may be damaged by exposure to steam. Clothing and other articles may be

disinfested by immersion in a 2 percent solution of cresol if the temperature is held at 100° F. for 30 minutes.

■ 178. OPERATION OF DELOUSING PLANT.—The following general considerations should be observed in the installation of a delousing plant:

a. There must be no mixing of clean and infested men or of clean and infested clothing.

b. The plant should be definitely divided into two parts—a clean side and an infested side—which are connected only through the shower baths for the men and through the disinfestors for the clothing and blankets.

c. The floor should be made of concrete and provided with sufficient slope and drainage outlets to permit rapid and adequate cleaning by flushing.

d. The entire building should be well lighted by natural lighting, but special care should be taken that the rooms or parts of the building used for the physical inspection or the inspection of clothing are adequately lighted.

e. Separate toilet facilities should be provided for infested men and for clean men.

f. Means should be provided for heating the building to a suitable temperature.

g. The minimum divisions of a large delousing plant should be—

(1) A receiving room large enough to care for an excess number of men if troops are sent to the plant too rapidly.

(2) A disrobing room.

(3) A checking room where shoes, belts, and other articles that may not require disinfestation may be checked, together with valuables.

(4) A shower bathroom.

(5) A disinfestor room.

(6) A dressing room.

(7) A barber shop.

(8) A physical inspection room.

h. In the case of smaller plants, some of the divisions in *g* above may be combined.

CHAPTER 10

RAT CONTROL

	Paragraphs
SECTION I. Importance, classification, and habits of the rat	179-181
II. General control procedures.....	182-183
III. Eradication by poisoning.....	184-187
IV. Eradication by trapping and fumigating.....	188-192
V. Rat surveys	193-196

SECTION I

IMPORTANCE, CLASSIFICATION, AND HABITS OF THE RAT

■ 179. GENERAL.—The rat is probably the most expensive parasitic animal living at the expense of man. In addition to huge economic losses caused by rats these animals are causative factors in the spread of several diseases as follows:

a. Bubonic plague.—Rat acts as reservoir and rat flea transmits the disease.

b. Endemic typhus.—Same manner as plague.

c. Infectious jaundice.—Rat contaminates food with excreta containing *leptospira icterohaemorrhagiae*.

d. Rat bite fever.—*Spirillum minus* transferred to man by bite of infected rat.

e. May harbor intestinal parasites, particularly tapeworms.

f. May transfer pathogenic organisms from feces to food mechanically.

g. Factors in spread of *trichinella spiralis* among hogs.

■ 180. CLASSIFICATION.—The genus *rattus* includes three species of sanitary importance: These are the brown rat, *R. norvegicus*, the black rat, *R. rattus*, and the roof or Egyptian rat, *R. alexandrinus*.

■ 181. HABITS.—Rats are nocturnal animals but at times come out in the daylight. In order to make an intelligent effort toward its destruction some knowledge of the habits of the various species is necessary.

a. The brown rat keeps mainly to the lower floors and basements of buildings, as it lacks climbing ability. It is a burrowing animal and will burrow into the hardest soil to live and breed. The brown rat has great gnawing ability and will eat anything without reference to its degree of freshness or decay.

b. The black rat and the roof rat are both excellent climbers and live in hollow walls, garrets, or loose material such as boxes, barrels, or rubbish. These rats are cleanly in their habits and prefer grain and fresh, clean food.

c. All rats are great travelers and are found on ships, in boxcars, and at times go great distances themselves in search of food.

SECTION II

GENERAL CONTROL PROCEDURE

■ 182. CONTROL PROCEDURES.—Control procedures are either suppressive or destructive. Suppressive measures are designed to prevent rats from reaching a food supply and to deny them access to spaces where they can nest and breed. Destructive procedures include poisoning, trapping, fumigation, and employment of natural enemies.

■ 183. RATPROOFING.—Temporary buildings in camps especially if they are to be used as storehouses should either be built up off of the ground or ratproofed. Ratproofing consists in the use of concrete floors and walls of concrete or of brick and stone laid in cement mortar, with the occlusion of all openings with metal flashings, grating, or screening. See TM 8-255 (now published as Army Medical Bulletin No. 23) for methods of ratproofing buildings. Should buildings which are not ratproof be used to store food in, the food should be elevated or stored in containers which prevent rats from gaining access to the food.

SECTION III

ERADICATION BY POISONING

■ 184. POISONING.—a. Poisoning is an effective rat control measure where there are large numbers of rats but it will

not kill all of the rats as many will soon learn not to touch the bait. The remainder may be killed or trapped.

b. One of the best poisons is red squill. This may be mixed with either canned salmon, ground fresh meat, or cooked cornmeal in the proportion of $\frac{1}{2}$ ounce of commercial red squill to 1 pound of the food base. It is well to mix the squill with several different food bases as some rats may prefer the meat or fish rather than the cereal, or the reverse may be true. Oven-dried rather than sun-dried squill should be used as it is much more effective.

c. Barium carbonate is another very good poison and it has similar advantages to squill in that it is relatively non-poisonous to children, dogs, and cats. It is mixed the same way as squill.

d. Arsenious oxide, phosphorus, strychnine, and thallium are also used but have the disadvantage of being highly poisonous to all animals.

■ 185. BAIT PREPARATION.—The consistency of bait should be such that it can be cut or shaped into small balls, cubes, or cakes. Balls or cakes should be about $\frac{1}{2}$ inch in diameter and should be well moistened rather than hard or dry. Bait should not be handled but mixed with a knife or spoon as the human odor may cause the rat to shun the bait. The baits are best wrapped in plain squares of paper, the corners being brought together and twisted into a torpedo-shaped package. The men who wrap the baits should wear rubber gloves and when the baits are placed, a pair of forceps should be used to handle them.

■ 186. BAIT DISTRIBUTION.—Baits are best distributed late in the afternoon so that they will be fresh when the rats start to search for food. The baits should be laid in places that are easily accessible to and frequented by rats. Generally the best results are obtained when the baits are placed along rat runways leading from rat harborages. These runways usually lie alongside of walls or other similar objects. The baits may be placed singly or in groups. Frequently, several kinds of bait may be used in one place as, for example, a ground meat bait together with a cereal bait. Single baits or groups of bait should be placed not more

than 10 to 20 feet apart along runways or in areas frequented by rats in search of food.

■ 187. **PREBAITING.**—In order to accustom rats to eating the kind of food materials which will be used to carry the poison, unpoisoned baits which are exactly like those that are to be employed later, except that they contain no poison, may be distributed for several days prior to placing the poisoned baits. The uneaten baits should be collected daily and replaced with fresh material. When the unpoisoned baits are eaten freely by the rats, all those that remain uneaten should be collected and a comparatively large number of poisoned baits distributed. Frequently, this procedure will result in the destruction of a large proportion of the rat population.

SECTION IV

ERADICATION BY TRAPPING AND FUMIGATING

■ 188. **TRAPPING.**—*a.* Trapping is an effective rat control measure, but requires greater skill and more labor than poisoning. A readily accessible food supply decreases the efficiency of trapping as a rat control measure.

b. Rats soon become suspicious of traps, particularly if the traps are unskillfully set, and will then consistently avoid them. Where many rats are present, a comparatively large number of traps should be set at the beginning of the campaign in order to destroy as many rats as possible before they learn to avoid the traps.

c. Trapping is a very practicable and efficient procedure for the control of rats in large warehouses or storerooms if it is persistently and systematically carried out. It also has the advantage that it can be constantly employed to destroy new arrivals where the continued exposure of poison would be undesirable.

■ 189. **TYPES OF TRAPS.**—There are two general types of traps, snap (guillotine or spring) traps and cage traps. Rats soon become suspicious of cage traps so that the snap trap is to be preferred. The trap should be strong and durable and preferably made of steel.

■ 190. TRAP BAITS.—Baits may be fried bacon, fish, cheese, liver, fresh bread or doughnuts, cantaloupes, or tomatoes. Fried bacon, cheese, and doughnuts as a rule prove the most attractive baits. If trapping is continuous the kind of bait should be changed frequently.

■ 191. TRAP SETTING.—Bait should be large and fastened to the trigger securely. It may be tied on with string or thread. Traps should be placed in locations normally frequented by rats. Where the trap is set along a runway, it should be set with trigger end against the wall. The trap may be disguised by covering it wholly or in part and prebaiting may be used at first by not setting spring of trap. The trigger should be so set that the slightest movement of the bait will spring the trap. All traps should be scalded or flamed at intervals to remove the odor derived from the hands. Traps may be deodorized by dipping in hot melted paraffin.

■ 192. FUMIGATION.—*a.* Hydrocyanic acid gas and sulphur dioxide are the gases commonly used for rat destruction. The difficulty in using these gases in the field is so great that they are of little value.

b. Rat burrows in dumps, around the exterior of buildings, or in other locations may be fumigated and the rats killed by carbon monoxide delivered through the exhaust pipe of an automobile. Where the burrows are accessible, a flexible pipe or a rubber hose is attached to the exhaust pipe and the other end is passed into the burrow. The carburetor should be adjusted for a rich mixture. In gassing the average burrow, the engine should be allowed to run at moderate speed for at least 10 minutes. The burrows and harborages treated in this manner should be made as airtight as possible by sealing the cracks and the openings of connecting burrows with earth.

c. Carbon disulphide on balls of cotton or waste may be plugged in rat burrows. This is more effective in damp weather and when ground is damp.

SECTION V

RAT SURVEYS

■ 193 GENERAL.—Rat surveys are conducted to determine the presence of rats infected with plague or to delimit the areas harboring infected rats. Surveys may also be made for the purpose of estimating the degree of rat infestation in a building or area with a view to deciding upon the control measures to be employed.

■ 194. SURVEY TO DETERMINE PRESENCE OF PLAGUE INFECTED RATS.—*a.* If a rat survey is made for the purpose of determining if plague infected rats are present, the suspected area is trapped in order to obtain specimens which will represent a cross section of the rat population. The rats thus secured are sent at once to a laboratory for examination for evidence of plague infection. Usually, trapping should be continued until an infected rat is found or, if the area is within a town or thickly populated section, until from 30 to 50 rats have been examined for every 100 persons living in the area.

b. If an infected rat is captured, it is a strong indication that a number of other plague rats are present in the locality. The point where the infected rat was captured is considered as a center of infection. The trapping activities are extended to gradually increasing distances from this center until infected rats are no longer found and the circumference of the infected area is determined. The area thus mapped out may be subjected to intensive rat eradication measures which progress from the circumference inward toward the center.

■ 195. SURVEY TO DETERMINE DEGREE OF RAT INFESTATION.—Prior to instituting an antirat campaign in a military station or camp, a survey should be made to determine the extent of the rat infestation and should include the following factors:

- a.* The location of burrows and harborages.
- b.* The kinds of food materials available to rats.
- c.* To what extent the food materials that are accessible to rats can be rendered inaccessible.
- d.* The kind of control measures that will probably be the most successful under local conditions.

As the rat instinctively seeks concealment, the degree to which a given building or area is infested must be determined by signs of the activities of rats rather than by the number that are to be seen. These signs consist of damaged food, the presence of rat runways as evidenced by tracks and marks of dragging tails in the dust, or by greasy appearing, discolored marks on woodwork made by the feet and tails of the rats, burrows and harborages, freshly gnawed wood, or rat excreta.

- 196. ORGANIZATION OF ANTIRAT CAMPAIGNS.—The results of a rat survey of a station or camp will indicate the kinds of control measures that should be instituted. These necessarily will vary according to the conditions but, given average conditions with moderate rat infestation, successful control can usually be established and maintained by reducing the food supply to a minimum and by ratproofing to eliminate harborages, followed by an intensive poisoning campaign with persistent and systematic trapping thereafter. Slight infestation may be controlled by protection of food materials and by poisoning. In any event, a definite and predetermined plan of action, trained personnel, and constant supervision are necessary for success.

CHAPTER 11

SANITARY SURVEYS AND SANITARY ORDERS

	Paragraphs
SECTION I. Sanitary surveys.....	197-199
II. Sanitary orders.....	200-205

SECTION I

SANITARY SURVEYS

■ 197. **GENERAL.**—A sanitary survey is an analysis of the conditions existing in a community which exert a favorable or an unfavorable influence on the health of the inhabitants. Sanitary surveys vary widely in scope and character and may consist of a more or less complete study of all the conditions within a community which actually or potentially affect health. It may, on the other hand, be limited in scope and restricted to the consideration of some specific factor.

■ 198. **FORM FOR SANITARY SURVEY.**—The following outline is suggested as a guide in the conduct of a military sanitary survey but it does not constitute a form which can be adhered to in all instances:

a. Military features.

(1) *Military personnel.*

Strength.

Training and discipline.

Racial characteristics.

(2) *Mission of the troops.*

Peacetime training.

Mobilization.

Wartime training.

(3) *Funds and policies.*

Existing and prospective availability of funds.

Policies relative to the procurement and expenditure of funds.

b. *Environmental features.*

- (1) *Topographical and meteorological conditions.*
 - Nature of terrain.
 - Character of topsoil and subsoil.
 - Amount of rainfall; mean temperature and humidity;
winds and seasonal variations in climate.
 - (2) *Recreational facilities.*
 - Athletics.
 - Entertainment and welfare work.
 - (3) *Water supply.*
 - Sources.
 - Methods of purification.
 - Methods of distribution.
 - (4) *Waste disposal.*
 - Kinds of wastes.
 - Methods of disposal.
 - (5) *Housing.*
 - Kinds of shelter used.
 - Ventilation, heating, and lighting.
 - Bed spacing.
 - (6) *Food supplies.*
 - Sources.
 - Effectiveness of inspection methods.
 - Storage and protection.
 - Operation of messes.
 - Training and supervision of food handlers.
 - Quality of the ration as served.
 - Operation of bakeries and post exchanges.
 - (7) *Insect control.*
 - Kinds of disease-bearing insects present.
 - Control methods employed and their effectiveness.
 - (8) *Stables.*
 - General cleanliness.
 - Fly control methods used and their effectiveness.
- c. *Disease prevalence.*
- (1) *Morbidity rates.*
 - Average total sick rate.
 - Average admission rates for communicable diseases.

(2) *Communicable diseases.*

Epidemic and endemic prevalence.

Sources of infection.

Control measures.

(3) *Hospital facilities.*

Capacity of local hospital installations.

Facilities for segregation and isolation.

■ 199. CONDUCT OF A SANITARY SURVEY.—The first steps in the conduct of a sanitary survey consist of a—

a. Formulation of a more or less complete plan relative to the kind of information to be obtained.

b. Determination of the source of material.

c. Determination of the methods to be used to collect material.

SECTION II

SANITARY ORDERS

■ 200. GENERAL.—A sanitary order is administrative in character, provides for the execution of sanitary procedures applicable to and indicated in the prevailing situation, and designates those responsible for the enforcement of such measures.

■ 201. RESPONSIBILITY.—Sanitary orders are published by the command.

■ 202. PREPARATION.—The surgeon of a command is normally responsible for the preparation of a sanitary order. He may, in practice, delegate the actual writing of the order to his medical inspector, but in so doing he does not delegate his responsibility for its proper preparation. In the preparation of a sanitary order, the surgeon must be conversant with the health situation within the command and with all factors which affect or might affect the health of the troops. He must give full consideration to the mission of the command and to the facilities which are available for the accomplishment of sanitary measures. All measures directed by a sanitary order must be of a practical nature. They should be necessary to meet the sanitary needs of the command, compatible with the mission of the command.

and of such character that they can be accomplished with the facilities available.

■ 203. SCOPE.—The sanitary order contains all of the administrative details necessary to protect the health of the troops and applies with equal force to all elements of the command.

■ 204. HOW SUBMITTED.—The sanitary order as prepared by the surgeon is submitted to the proper military headquarters for approval and publication. In the ordinary small post or camp it is submitted to the commanding officer. In larger camps or in larger tactical commands the order is usually submitted to G-1 of the staff or the adjutant who coordinates it with other staff sections and then submits it to the chief of staff for approval and issue.

■ 205. FORM.—*a.* A sanitary order may be issued in the form of a general order, as an annex to an administrative order, or as a series of memoranda or instructions. Normally, GHQ, army, corps, or communications zone headquarters do not publish sanitary orders as such, but govern sanitation from an administrative point of view by the promulgation of policies pertaining thereto or by instructing subordinate commands relative to action to be taken by them to meet a particular sanitary situation. A sanitary order would normally be published as a general order for a division or analogous command in a mobilization or concentration camp or for a summer training camp.

b. The exact form of the general order will vary with the conditions under which the order must be enforced. The following may be used as a general guide.

 (Division)

 (Place)

 (Date)

GENERAL ORDER }
 No. _____ }

1. GENERAL.—The following provisions for the sanitation of this division are published for the information and guidance of all concerned:

a. Responsibility of unit commander.

- b. The division surgeon duties and responsibilities relative to sanitation.
 - c. The medical inspector (duties and responsibilities).
 - d. Water supply.
 - e. Food and messes.
 - f. Waste disposal.
 - g. Quarters (barracks, tents, or billets).
 - h. Insect control (where applicable).
 - i. Personal hygiene.
 - j. Dispensaries (location).
 - k. Venereal prophylaxis (location of stations).
 - l. Physical inspections.
 - m. Special measures for the control of communicable diseases.
2. *Civilians*.—All civilians and civilian organizations attached to the division will comply with this order insofar as it applies to them.
- By order of -----

Official:

Distribution.

c. While Army Regulations fix the responsibilities of all concerned with regard to sanitation, the sanitary order as a rule again states the responsibility of the unit commanders, the surgeon, and the medical inspector. This is done in order that the duties of each, and the relations of one to the other in the existing situation, may be clearly defined. Under some circumstances it may be desirable to state in the sanitary order the responsibilities of other staff officers such as the quartermaster, the engineer officer, or the police officer.

CHAPTER 12
FIELD EPIDEMIOLOGY

	Paragraphs
SECTION I. Epidemiological investigation.....	206-209
II. Carriers and missed cases.....	210-211

SECTION I

EPIDEMIOLOGICAL INVESTIGATION

■ 206. GENERAL.—Epidemiology has been defined by the American Epidemiological Society as “the science which concerns itself with the natural history of disease as it is expressed in groups of persons related by some common factors of age, sex, race, location, or occupation, as distinct from the development of disease in individuals.” There are several types of epidemiological work, but the medical officer is concerned largely with the actual investigation of outbreaks of communicable disease in camp or contonment.

■ 207. RECOMMENDATION FOR.—When communicable disease appears among troops an immediate investigation should be instituted so that recommendations for control measures can be made. In formulating recommendations it should be borne in mind that the mission of the troops is of paramount importance. The ideal situation, therefore, insofar as control measures are concerned, may not be attained, but an effort should be made to adapt means of prevention as far as possible to the existing situation.

■ 208. OUTLINE FOR INVESTIGATION.—The following outline will aid in the investigation of an outbreak of communicable disease. In most instances an experienced medical officer will make this investigation in whole or in part, as conditions warrant, without reference to texts or notes. The officer who has had little or no epidemiological experience will find it useful as a guide.

a. Make a careful check to see that the disease is the one in question. That is, confirm the diagnosis before any other steps are taken.

b. Is the outbreak above normal expectancy? At certain seasons of the year, for instance, there is generally an increase in respiratory diseases. Compare rates with previous week, month, and, if available, same period previous year.

c. Ascertain from histories of cases if any common foci of exposure exist. This is of special importance in intestinal diseases where men in different organizations have had a common exposure outside of camp.

d. Isolate patients. Send all patients to hospital and have them placed in a separate ward away from others.

e. Investigate contacts. Include men in same tent and squad, also men who have worked with patients.

f. Investigate food supply and food handlers if disease is one thus acquired.

g. Contacts without symptoms may be placed in working quarantine. Period of quarantine to continue for the number of days coinciding with the period of incubation of the disease. Should new cases appear, continue the period until a complete incubation period has passed after the removal of the last case.

h. Have contacts inspected by a medical officer once or twice daily.

i. Instruct unit commanders as to what symptoms to watch for and request them to send suspects on sick report as soon as discovered.

j. Prophylactic vaccination if indicated.

■ 209. EPIDEMIOLOGICAL DATA.—The following tables show some of the more important data relative to epidemiology and diagnosis of some of the epidemic diseases.

a. *Respiratory group*.—This is the so-called droplet group, the diseases being spread usually through the secretions of the respiratory tract.

Disease	Incubation period	Rash	Remarks
Smallpox.....	12-21 days..	2-4 days...	Usually 14-day incubation.
Chickenpox.....	do.....	1-2 days...	Usually 14-day incubation. Rash appears in crops.
Cerebrospinal meningitis.	2-10 days..	1-5 days...	
Diphtheria.....	do.....	None.....	Rash varies as to type and very often none appears.
Measles.....	7-18 days..	3-4 days...	Usually 14-day incubation.
Mumps.....	10-20 days	None.....	
German measles.....	7-20 days..	24 hours...	Early enlargement of posterior cervical glands.
Scarlet fever.....	1-8 days...	48 hours...	Usually 3-5 day incubation. May be spread by means of infected milk.
Influenza.....	1-4 days...	None.....	
Whooping cough.....	7-14 days..	None.....	
Pneumonia.....	2-3 days...	None.....	
Poliomyelitis.....	7-14 days..	None.....	
Septic sore throat.....	1-5 days...	Not usual.	Infected milk supply important.
Encephalitis.....	4-21 days..	None.....	

b. Intestinal group.—Diseases of this group are usually transmitted through the media of food and water which have become infected from the intestinal discharges of patients or carriers.

Disease	Incubation period	Remarks
Typhoid.....	7-23 days.....	
Bacillary dysentery.....	2-3 days.....	
Protozoal dysentery.....	10-14 days.....	
Cholera.....	1-6 days.....	
Undulant fever.....	About 14 days.....	Milk supply of primary importance.
Food infection.....	2-24 hours.....	

c. *Insect-borne group*.—This group is transmitted by blood-sucking insects.

Disease	Incubation period	Insect vector	Remarks
Malaria.....	6-30 days..	Anopheles mosquito...	
Dengue.....	5-9 days..	<i>Aedes aegypti</i> and <i>Aedes albopictus</i> .	
Typhus endemic...	5-20 days..	Rat flea and rat louse..	Rash about fifth day and tends to disappear before becoming petechial.
Typhus epidemic.....	do.....	Body louse.....	Rash on fourth or fifth day.
Trench fever.....	14-30 days..	do.....	
Plague.....	2-10 days..	Rat flea.....	Rodents other than rat are also susceptible.
Relapsing fever.....	3-12 days..	Lice and ticks.....	Louse borne more likely to be epidemic.
Yellow fever.....	2-6 days..	<i>Aedes aegypti</i> and many other species.	Jungle yellow fever occurs in absence of aedes.
Filariasis.....	Variable..	<i>Culex fatigans</i> and <i>Aedes variegatus</i> .	Also other mosquitoes. May produce no clinical symptoms.
Rocky Mountain spotted fever.	3-12 days..	Tick.....	<i>Dermacentor andersoni</i> and <i>Dermacentor variabilis</i> , also others.
Tularemia.....	1-9 days..	Ticks, lice, and chrysopepsis.	Also transmitted by direct contact with infected animal.
Tick paralysis.....	5-14 days..	<i>Dermacentor andersoni</i> and certain ixodes.	

SECTION II

CARRIERS AND MISSED CASES

■ 210. HEALTHY CARRIERS.—The following diseases are of importance as they may be transmitted by healthy carriers:

Typhoid fever.

Paratyphoid fever.

Dysentery (bacillary and protozoal).

Pneumonia.

Cholera.

Meningococcic meningitis.

Diphtheria.

Scarlet fever.

■ 211. MISSED CASES.—During epidemics there are always mild, subclinical, or atypical cases. These cases are prone to be missed at the beginning of the epidemic but are recognized when the epidemic is established as much greater care is then exercised and everyone is on the alert.

CHAPTER 13

PHYSICAL EXAMINATIONS

	Paragraphs
SECTION I. Responsibility and standards.....	212-214
II. Conduct of examinations and inspections.....	215-217

SECTION I

RESPONSIBILITY AND STANDARDS

■ 212. GENERAL.—Physical examinations constitute an important part of military preventive medicine and are essential in protecting the health of military personnel. Further, troops cannot be recruited or mobilized for military service without being physically examined, and the performance of physical examinations is the first step in the recruitment or mobilization of a military force. Usually, it is the principal basis upon which men are selected for enlistment in the military service. The efficient performance of large numbers of physical examinations, from both an administrative and a professional viewpoint, is a vital feature of mobilization for war.

■ 213. RESPONSIBILITY.—The administrative responsibility for and control of physical examinations rest with the commander of the command or station concerned. The Medical Department is responsible for the performance of physical examinations in accordance with administrative orders of competent military authority.

■ 214. STANDARDS.—Standards of physical qualifications are formulated and promulgated by the War Department and are published in Army Regulations and Mobilization Regulations.

SECTION II

CONDUCT OF EXAMINATIONS AND INSPECTIONS

■ 215. GENERAL.—*a.* The physical examination, whether performed for administrative or health conservation purposes, or both, is an examination of an apparently healthy person.

It is seldom that the examinee complains of any symptoms or conditions indicative of a physical defect or abnormality. The methods used, therefore, differ to some extent from those employed in determining the cause or nature of an existing illness. The examinee may endeavor to conceal physical defects or he may malingering or endeavor to accentuate the importance of minor abnormalities. Consequently, the examiner must be prepared to determine the true physical condition of the examinee and detect and properly evaluate any and all obscure or preclinical abnormalities.

b. Physical examinations must be thorough if they are to be of any considerable value either for health conservation or for administrative purposes. Usually, if there are a number of examinees, administrative conditions require that the examinations be made as rapidly as may be consistent with thoroughness, but thoroughness should not be sacrificed to obtain speed. Where physical examinations are performed with such rapidity that the work is slighted, the results are of but little actual value and the object of the examination is defeated. Such examinations are in reality physical inspections only and should be so regarded. If they are accepted as having the same value as properly performed physical examinations, they will tend to cause more harm than good, in that a great many examinees who actually have physical defects will be erroneously considered as physically fit for military service or will be denied the attention necessary to protect their health.

■ 216. ORGANIZATION OF EXAMINING UNITS.—The organization of a physical examining unit depends upon the number of men to be examined and the number of examiners available to do the actual examining. The organization should be such that the work performed at each station is thorough and complete, and a constant, steady flow of examinees is maintained through the various examining stations without congestion or undue delay at any one station. Figures 57 and 58 show diagrammatic representations of three types of organizations for physical examinations.

■ 217. PHYSICAL INSPECTIONS.—Army Regulations require that all enlisted men be physically inspected once each

company or detachment to which the men belong. Where feasible and when required, a monthly physical inspection may include a dental survey made by a dental officer. Where physical defects are found, appropriate action should be taken, for example, treatment or observation in hospital or a change of duty.

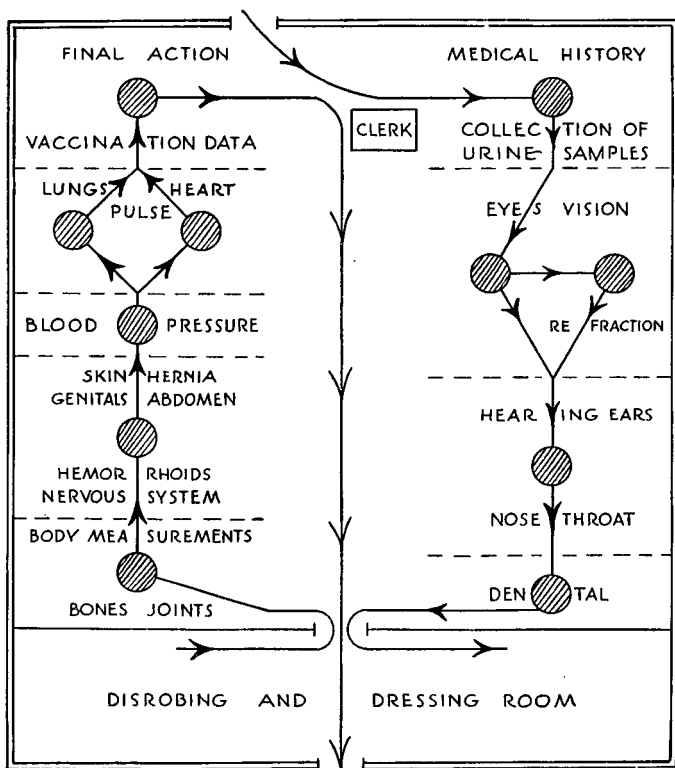

FIGURE 58.—One method of organizing a physical examining board which will permit partial examination before the examinees disrobe.

CHAPTER 14

IMPORTANT FACTORS RELATIVE TO PERSONAL HYGIENE

	Paragraphs
SECTION I. General	218-219
II. Prevention and treatment of skin diseases.....	220-221
III. Oral hygiene.....	222-224

SECTION I

GENERAL

■ 218. **PHYSICAL INSPECTIONS.**—The importance of the monthly physical inspection in detecting pathological conditions cannot be stressed too greatly. It should never be a “venereal” inspection but should include, especially, foot and skin conditions.

■ 219. **CARE OF THE FEET.**—*a. General.*—Ordinary care of the feet and shoe fitting are covered in FM 21-10. However, there are certain pathological conditions of the feet which, if not detected early, may lead to invalidism of the individual or to wholesale infection of the command. The most important of these conditions is ringworm of the feet or “athlete’s foot.” This is also called dermatomycosis or epidermophytosis of the extremities as it may affect the hands as well as the feet. Dermatomycosis is a subacute or acute inflammatory condition of the skin occurring most frequently on the feet, especially between and on the plantar surface of the toes and on the soles of the feet. It is characterized by various types of lesions, including thickening and scaling of the epidermis, excoriation of inflamed areas, fissures, and vesicles or blebs. Usually, there is more or less intense itching.

(1) Ringworm of the extremities is caused by parasitic fungi. It is generally believed that species of *Epidermophyton* and *Trichophyton gypseum* are the most common causative agents. The organisms can be destroyed by ordinary disinfectants and by boiling water.

(2) Ringworm of the extremities is one of the most prevalent of all skin diseases although many cases may pass undiagnosed unless their presence is revealed as the result of special examinations. The presence of this condition in a military organization has an adverse effect on the morale of the troops. Relatively severe infections may incapacitate for the performance of military duties.

(3) The causal agents of ringworm of the extremities are usually transmitted by indirect contact through the medium of inanimate objects. The infection is most commonly spread by contact of the bare feet with the floors, mats, benches, etc., in the bathrooms of gymnasiums, clubs, and swimming pools. Towels, slippers or shoes, or other articles worn next to the bare skin are frequently incriminated in the transmission of the causative organisms. The primary source of the infection is the infected individual. As far as is known, the organisms are not derived primarily from animals or from the soil.

(4) One of the means of preventing the spread of ringworm of the extremities is to supply all bathhouses with calcium hypochlorite foot baths. Grade A calcium hypochlorite in the proportion of 1 ounce of the dry chemical per gallon of water yields 0.5 percent available chlorine, which is the strength recommended. Fresh solutions should be prepared daily. Under ordinary circumstances one foot tub for bathers to use at the completion of bath will suffice. Where fungus infections are present and obstinate in a command, two tubs should be furnished, one to use before bathing and one after. Foot tubs should be of convenient size and shape and should be deep enough to insure thorough wetting of the feet. Foot tubs should be made of concrete or rubber as the calcium hypochlorite acts unfavorably on metal and wood.

(5) Another very important factor in the spread of this infection is the improper drying of the feet, especially between the toes. Men should be instructed to sit down and carefully dry between each toe before putting on socks and shoes.

b. Control measures.—The spread of the infection among troops can be most effectively controlled by the disinfection

of bathhouse floors and equipment and by the sterilization or disinfection of towels, swimming or gymnasium suits, and similar articles by which the infection might be transmitted. Bathhouse floors and equipment, including mats, benches, chairs, etc., should be scrubbed daily with a disinfectant. A solution of calcium hypochlorite, soap, and a hot 1 to 10,000 solution of mercuric chloride, or the various cresol or phenol solutions, may be used as disinfectants. Individual slippers of rubber or other waterproof materials are useful in preventing contact of the bare feet with infected surfaces. All articles that can be boiled should be sterilized by boiling. Leather and rubber goods can be disinfected with a cresol solution. Shoes can also be disinfected by a 1 percent solution of thymol in gasoline or alcohol. This solution is poured into the shoe and allowed to drain away or evaporate. The exchange or common use of towels, gymnasium suits, slippers, gloves, etc., should either be avoided or they should be disinfected after use.

SECTION II

PREVENTION AND TREATMENT OF SKIN DISEASES

■ 220. *TINEA CRURIS*.—*a*. This is a skin disease caused by several species of the genus *Epidermophyton*, the most common being *E. inguinale*. It may also be due to species of *Microsporum*. It is most prevalent in the Tropics and is called "dhobie itch" as it was thought that transmission was through the medium of clothing infected by native washermen (dhobies).

b. Tinea cruris is characterized by reddened, inflamed, and swollen areas which begin as rounded, elevated papules and extend peripherally, producing a raised festooned border covered with scales. The infection is accompanied by intense itching and irritation which is most pronounced at night. Secondary bacterial invasion may occur producing boils and abscesses. The infection occurs most commonly in the perineal region and the adjacent surfaces of the thighs, and in the axillary region. It may spread to the chest and abdomen and frequently occurs between the toes.

c. The clinical symptoms may disappear during cool weather or when the patient goes to a temperate climate,

only to reappear during the next hot season or on return to a moist, hot climate.

d. The causal agent of tinea cruris is transmitted from person to person by contact, chiefly by the hands, clothing, towels, or bathroom floors. It is also possible that the latrine or toilet seat is a factor in the transmission of the fungus.

e. The general preventive measures mentioned under ring-worm of the extremities should be followed if tinea cruris appears. Every patient should be thoroughly treated, even though the infection is slight, in order to eliminate him as a source of infection. It may be desirable to hospitalize acute cases in order to prevent transmission. Daily bathing and the use of a drying powder after the bath serves to prevent to some extent the development of the infection. The powder which may consist of equal parts of boric acid, zinc oxide, and starch should be dusted on the skin of the perineum and axillae.

■ 221. SCABIES.—a. Scabies is an acute inflammatory condition of the skin due to the presence in the epidermis of *Sarcoptes scabiei* var. *hominis*, or itch mite. Simple scabies is characterized by the formation of vesicles and papules accompanied by intense itching which is more pronounced in the presence of warmth. The lesions are most commonly located on the lateral surfaces of the fingers, on the wrists, buttocks, genitals, especially on the penis, and on the elbows, knees, and ankles. Scabies may be complicated by secondary infection with the production of an ecthymotous impetigo, boils, or dermatitis.

b. *Sarcoptes scabiei* var. *hominis* belongs to the order Acarina, which includes the ticks and mites. The female is from 0.3 to 0.4 millimeter and the male about 0.2 millimeter in length. The impregnated female burrows into the epidermis, creating tunnels $\frac{1}{16}$ to $\frac{1}{4}$ inch or more in length. The burrows do not penetrate into the tissues below the epidermis. The eggs are deposited in the burrow. The eggs hatch in 4 to 5 days. The larval and nymphal forms pass through four stages to become adults in about 2 weeks. The larvae also bore into the skin to find protection and food. The males and newly matured females are to be found under the scales

and crusts on the surface of the skin. The female lives 3 to 5 weeks and deposits 25 to 50 eggs. It is probable that the female dies in the burrow, although she may live a week or longer and deposit ova when separated from the body of the host. The activity of the mites is governed to a very considerable extent by the warmth of the skin. Active burrowing takes place when the skin is warm and ceases when it is cold.

c. The parasite is transferred by direct body contact or close indirect contact through the medium of clothes and blankets. General control measures consist of first making a correct diagnosis and then disinfecting the skin, clothing, and blankets of the patient. All troops undergoing treatment should be segregated in group quarantine. The disinfection of the skin can be accomplished only by treatment which will destroy all forms of the parasite. In practice, this treatment consists of thorough bathing with hot water and soap to remove the crusts and scales, followed by the application of an insecticide. Green soap should be used and the entire body should be thoroughly scrubbed 10 to 15 minutes with a coarse bath mit. A bath mit made of turkish toweling or similar cloth may be used, or nail brushes may be employed, especially in scrubbing the extremities. The soap should then be removed with hot water and the body thoroughly dried. Sulphur ointment (USP) is then applied over the entire body from the neck to the tips of the fingers and toes, and thoroughly rubbed in. This treatment is repeated on the following day and, in the more heavily infested cases, on the third day. A cleansing bath is then given and the patient is regarded as cured if no evidence of the insect can be found. Liquor calcis sulphuratae (lime and sulphur lotion, Vleminck's solution) may be used in lieu of the sulphur ointment. Sulphur ointment containing 10 percent of balsam of Peru may be used in the treatment of complicated cases. The itching may continue for some time after treatment and does not necessarily indicate that the treatment has failed to effect a cure. Occasionally the treatment may cause sulphur dermatitis. A pyrethrin or rotenone ointment may be used instead of sulphur, especially in the treatment of individuals subject to sulphur dermatitis. As none of the insecticides will

destroy the eggs, it may be necessary to repeat the treatment in about a week. The clothing and blankets of men having scabies should be disinfested by the methods employed for delousing. Care should be taken that all articles of clothing including gloves and shoes are disinfested.

SECTION III

ORAL HYGIENE

■ 222. DEFINITION.—As used herein the term “oral hygiene” includes all those measures which the individual may practice and apply to himself and which are designed to increase or maintain the healthful condition of the oral cavity. It does not include those professional measures which are rendered by a dental surgeon to a patient for a similar purpose.

■ 223. GENERAL MEASURES.—*a. General.*—In the Military Establishment these measures are largely restricted to the proper use of the toothbrush and various cleansing agents. Each recruit on enlistment is issued a toothbrush as a part of his initial equipment. Thereafter each soldier must provide all toilet articles at his own expense.

(1) Because these measures are futile unless habitually practiced, it is obvious that the individual will have to be trained and disciplined with respect to their performance until he can be depended upon to practice them thoroughly without supervision. The acquisition of habits of oral hygiene is a matter of education and training, and the training must be based upon proved methods and upon professional advice of qualified dental officers.

(2) The best place for the initiation of training measures is at permanent stations, and mobilization, and training camps. Correct habits of oral hygiene may be practiced with profit under all conditions, but it is only under conditions where training is the primary objective that sufficient supervision may be exercised to assure the development of correct habits in an adult who has not previously been trained.

b. Responsibility of commanding officers and dental officers.—The dental officer serves too large a command to

exercise the constant supervision that is essential to the acquisition of correct habits of oral hygiene. The organization commander is the only person who is in a position to inculcate these habits in the members of his command. His efforts must be based upon the advice of the specialist, the dental officer, whose responsibility is to initiate instruction. Even the most ardent efforts will not result in success unless they are supplemented by educational measures that will make the soldier see the profit and comfort that will follow the invariable practice of these habits. This educational feature is a most important phase of this matter and the one that is of vital concern to the dental officer.

■ 224. EDUCATIONAL MEASURES.—Educational measures along this line may be roughly divided into efforts directed at groups and efforts directed at individuals. In instructing either groups or individuals it will be found that it can be best accomplished by the following methods:

a. Exhibits, including actual cases showing the results of good or bad hygienic habits, pictures, and demonstrations of methods.

b. Lectures.

c. Exercises.

CHAPTER 15

VITAL STATISTICS

	Paragraphs
SECTION I. Statistical rates and strengths.....	225-227
II. Methods of computing rates and ratios.....	228-231

SECTION I

STATISTICAL RATES AND STRENGTHS

■ 225. GENERAL.—The Medical Department officer in the field has to be familiar with elementary statistical methods as there are certain reports which require, not only the reporting of the absolute number of cases, but the rate of occurrence.

■ 226. RATES.—*a.* A statistical rate is the number of times an event occurs in a definite number of people during a given period of time. In order to calculate a rate the following must be known:

- (1) Frequencies of the event (cases, deaths, etc.).
- (2) Strength.
- (3) Period of time.

b. Army vital statistics are figured as rates per 1,000, that is, a strength of 1,000 is used as a base. In other places 10,000 or 100,000 may be used, but it is best to use the same figure at all times in order to make rapid and accurate comparisons.

c. In addition, Army rates are estimated on an annual basis. That is, a rate of so many cases per 1,000 per annum. If in a command of 1,000 men there are 10 cases of measles during any one month and the rate per 1,000 for the year is desired, the 10 would be multiplied by 12. The result in this case would be 120 and as there were 1,000 troops, the rate would be 120 per 1,000 per annum. Here we have assumed that the same number of cases would occur during each of the remaining eleven months of the year. In most cases the strength is not in even thousands so additional calculations are required.

■ 227. STRENGTH.—By strength is meant the number of individuals present at a certain time or during a certain period.

To obtain the average strength of a command for a given number of days, the strengths for each day are added and divided by the number of days in the period, the result being the average strength.

SECTION II

METHODS OF COMPUTING RATES AND RATIOS

■ 228. FORMULA FOR ESTIMATING RATES.—The following formula will be found valuable in computing rates per 1,000 per annum for any period:

$$\frac{\text{Number of events in the period} \times 1,000 \times \text{One year (expressed in days, weeks or months)}}{\text{Mean strength} \times \text{Number of days, weeks or months in the period}}$$

To illustrate, suppose there were 12 cases of measles in a command of 610 in a 5-weeks' period. What is the rate per 1,000 per annum?

$$\frac{12 \times 1,000 \times 52}{610 \times 5} = 204.5$$

Here the number of events (cases) is 12 and this is multiplied by 1,000 and by 52. The figure 52 represents one year expressed in weeks. This result is divided by the strength multiplied by 5 (the number of weeks in which the 12 cases occurred).

Suppose these cases had occurred in one calendar month, then

$$\frac{12 \times 1,000 \times 12}{610 \times 1} = 236.0$$

In this case the year is expressed by 12, the number of months in one year, and the strength is multiplied by one, there being one month in the period.

If these events occurred, in say 18 days, then the formula would be—

$$\frac{12 \times 1,000 \times 365}{610 \times 18} = 398.0$$

Most of the morbidity records prepared by camp or station surgeons cover a 4- or a 5-weeks' period so that the first example shown here would be the one to follow.

For a more extended discussion see FM 8-55 or TM 8-255 (now published as Army Medical Bulletin No. 23).

■ 229. **NONEFFECTIVE RATE.**—The noneffective rate is a daily rate and is the number of men sick in hospital or quarters per 1,000 strength on the day for which it is calculated. The noneffective rate is employed to determine the number of troops in a given command that are physically fit for duty on a given day, or the average daily noneffectiveness caused by a disease during a selected period of time.

The noneffective rate for a given day may be calculated as follows:

$$\text{Noneffective rate} = \frac{\text{Number of sick} \times 1,000}{\text{Strength}}$$

The following formula may be used to determine the average daily noneffective rate for a period of more than one day :

$$\text{Noneffective rate} = \frac{\text{Sum of number sick daily} \times 1,000}{\text{Sum of daily strengths}}$$

The following formula may also be used to determine the daily noneffective rate:

$$\text{Noneffective rate} = \frac{\text{Total days lost}}{\text{No. of days in period}} \times \frac{1,000}{\text{average daily strength}}$$

Thus, if in a command of 500 troops, 10 men are sick on a given day, the noneffective rate is 20 per 1,000 troops. It is calculated as follows:

$$\begin{aligned} \text{Noneffective rate per 1,000} &= \frac{10 \times 1,000}{500} \\ &= \frac{10,000}{500} \\ &= 20 \end{aligned}$$

If four cases of measles occur in a command of 500 troops during one month and these cases are sick for 10, 12, 14 and 14 days, respectively, the noneffective rate may be calculated as follows:

$$\begin{aligned} \text{Noneffective rate 1,000} &= \frac{(10 + 12 + 14 + 14) \times 1,000}{30 \times 500} \\ &= \frac{50,000}{15,000} \\ &= 3.33 \end{aligned}$$

Or:

$$\begin{aligned}\text{Noneffective rate} &= \frac{50}{30} \times \frac{1,000}{500} \\ &= 1.666 \times \frac{1,000}{500} \\ &= 1.666 \times 2 \\ &= 3.33\end{aligned}$$

In 1928 the total United States Army, consisting of 134,380 troops, lost 73,144 days from duty because of influenza, or, as expressed by the noneffective rate, 1.49 men out of every 1,000 troops were incapacitated for duty each day of the year. This is determined by the following calculation:

$$\begin{aligned}\text{Noneffective rate per 1,000} &= \frac{73,144}{365} \times \frac{1,000}{134,380} \\ &= 200.39 \times \frac{1,000}{134,380} \\ &= 200.39 \times 0.00744 \\ &= 1.49\end{aligned}$$

■ 230. PROPHYLACTIC RATE.—In the report of venereal diseases the prophylactic rate is required. That is, the number of men per 1,000 strength who have taken venereal prophylaxis during the month. This rate is obtained as follows:

$$\text{Number of prophylactics administered} \times \frac{1,000}{\text{Average daily strength}}$$

■ 231. RATIOS.—Ratios are used to express relationships between frequencies of occurrence of related events. Ratios are usually expressed in percent (per 100). A case fatality rate is the ratio of deaths from a specific disease to the number of cases of the disease. If during an epidemic of meningitis there were 120 cases and 30 of them died, the case fatality rate would be 25 calculated as follows:

$$\begin{aligned}\text{Case fatality rate} &= \frac{30 \times 100}{120} \\ &= 0.25 \times 100 \\ &= 25\end{aligned}$$

INDEX

	Paragraph	Page
Antirrat campaigns, organization of.....	196	138
Baits, rat:		
Distribution.....	186	134
Preparation.....	185	134
Trap.....	190	136
Bath and wash water disposal.....	82	66
Bathing for lice disinfestation.....	169	123
Bored hole latrine.....	65	46
Botulism, meat poisoning.....	114	86
Buildings, mess.....	97	73
Butter.....	126	95
Campaigns, antirrat, organization.....	196	138
Camps, observation or detention.....	13	9
Care:		
Compost piles.....	87	69
Feet.....	219	153
Garbage stands and cans.....	74	60
Latrines.....	68	48
Charts and reports, statistical.....	15	11
Chemical prophylaxis.....	30	23
Individual.....	33	24
Classification:		
Diseases:		
Communicable.....	6	5
Insect borne.....	24	21
Intestinal.....	19	17
Respiratory.....	16	12
Lice.....	166	121
Rats.....	180	132
Wastes.....	54	39
Collection of garbage.....	72	58
Communicable diseases, other means of preventing.....	14	10
Compost bin.....	88	70
Concurrent and terminal disinfection.....	22	19
Condensed milk.....	125	94
Conduct of—		
Examinations and inspections, general.....	215	149
Sanitary survey.....	199	141
Water reconnaissance.....	51	34
Control measures.....	21	18
Lice.....	168	121
Mosquitoes.....	148-159	111-118
Rats.....	182	133
Treatment of venereal diseases as.....	34	24
Dairy farms.....	122	92
Data, epidemiological.....	209	145
Definition of special terms.....	9	6

INDEX

	Paragraph	Page
Delousing plant, operation.....	178	131
Destruction of adult flies.....	130	97
Detention or observation camps.....	13	9
Development of the housefly.....	127	96
Disease:		
Healthy carriers.....	210	147
Transmission by food.....	113	86
Transmitted by lice.....	165	121
Dishwashing.....	100	74
Disinfection, concurrent and terminal.....	22	19
Disinfestation of clothing and equipment.....	170	126
Disinfestors:		
Hot air, improvised.....	173	129
Mobile.....	171	126
Disposal of—		
Bath and wash water.....	82	66
Manure:		
As fertilizer.....	89	70
Composting.....	86	67
Contract.....	85	67
Drying.....	90	70
Incineration.....	91	70
Wastes:		
Human:		
Bivouac.....	59	40
Camps.....	60	42
Marches.....	58	40
Kitchen.....	101	77
Distribution and breeding habits, mosquitoes.....	145	109
Dumps, rubbish:		
Construction.....	93	71
Maintenance.....	94	71
Eggs.....	119	89
Engineer water supply equipment.....	44	29
Environment, influence of.....	10	8
Epidemiological data.....	209	145
Epidemiological investigation.....	206	144
Outline.....	208	144
Recommendation.....	207	144
Establishment of quarantine.....	12	9
Estimation of stream flow.....	41	27
Examinations and inspections, conduct.....	215	149
Examining units, organization.....	216	150
Feet, care.....	219	153
Fish.....	120	89
Flies.....	127-130	96-97
Fly—		
Baits.....	134	102
Paper.....	136	104
Poisons.....	137	104
Sprays.....	138	105
Swatting.....	139	105

INDEX

	Paragraph	Page
Fly—Continued.		
Trap:		
Care	135	103
Location	133	102
Stands	132	102
Types	131	98
Wires	136	104
Food:		
Disease transmission by	113	86
Handlers	104	78
Inspection, on receipt	98	73
Method of serving	103	78
Served:		
Character	102	77
Methods of formulating menus	102	77
Storage facilities	99	74
Forms for sanitary survey	198	139
Formula for statistical rate estimation	228	161
Fumigation, rat	192	136
Garbage	70	50
Cans, care	74	60
Collection	72	58
Disposal methods	71	50
Stands	73	58
Care	74	60
Transfer stations	75	60
General control measures:		
Diseases:		
Intestinal	21	18
Venereal	28	22
General importance and prevalence of intestinal diseases	20	17
Grease traps	79	62
Housefly (<i>musca domestica</i>):		
Destruction of adult	130	97
Development	127	96
Habits tending toward control	129	97
Range of flight	128	97
Identification of mosquitoes	144	109
Individual chemical prophylaxis	33	24
Influence of environment	10	8
Insect-borne diseases	23	20
Classification	24	21
Transmission	25	21
Inspection:		
Food, on receipt	98	73
Physical	217, 218	150, 153
Intestinal diseases	18	17
Classification	19	17
Importance and prevalence	20	17
Kitchen wastes, disposal	101	77

INDEX

	Paragraph	Page
Latrine:		
Bored hole.....	65	46
Box, standard Quartermaster.....	61	43
Care.....	68	48
Location.....	67	48
Material for one.....	64	45
Pail type.....	69	49
Seating space.....	57	40
Larvicides:		
Paris green.....	157	116
Phenol.....	156	116
Lice:		
Classification.....	166	121
Control measures.....	168	121
Diseases transmitted by.....	165	121
Disinfestation:		
Clothing and equipment.....	170	126
Methods:		
Bathing.....	169	123
Chemical.....	177	130
Hot air.....	173	129
Hot iron.....	174	129
Hot water.....	175	130
Storage.....	176	130
Life cycle.....	167	121
Liquid wastes.....	76, 77	61, 62
Location of fly traps.....	133	102
Lyster Bag (water-sterilizing bag).....	45	30
Manure.....	83	66
Collection.....	84	66
Compost bin.....	88	70
Disposal:		
As fertilizer.....	89	70
Composting.....	86	67
Contract.....	85	67
Drying.....	90	70
Incineration.....	91	70
Maps and conventional signs for water supply.....	53	36
Marches, water discipline on.....	48	33
Material for one latrine.....	64	45
Meat and meat food products.....	108	84
Preservation.....	110	85
Sanitary inspection:		
Canned.....	117	88
Cured.....	116	88
Fresh.....	115	86
Spoilage.....	109	84
Storage, in temporary camps.....	112	86
Meat poisoning, botulism.....	114	86
Mechanical prophylaxis.....	29	22
Medical Department, sanitary control of water supply.....	36	25
Menus, method of formulating.....	102	77
Mess:		
Buildings.....	97	73
Personnel, training in mess sanitation.....	105	79

INDEX

	Paragraph	Page
Mess—Continued.		
Sanitary control.....	96	72
Sanitary inspection.....	106	79
Outline for.....	107	80
Sanitation administration.....	95	72
Methods:		
Garbage disposal.....	71	50
Food serving.....	103	78
Formulating menus.....	102	77
Venereal prophylaxis application.....	32	23
Military sanitation:		
Purpose.....	1	1
Responsibility for.....	2	1
Military sanitation program, principal objects.....	8	6
Milk.....	124	93
Condensed.....	125	94
Missed cases.....	211	148
Mobile disinfestors.....	171	126
Mosquito.....	141	106
Control measures:		
Adult destruction.....	159	118
Artificial water container elimination.....	153	113
Destruction by natural enemies.....	158	117
Ditches:		
Construction, factors in.....	148	111
Lined.....	149	112
Open.....	147	111
Drainage.....	146	111
Filling in low areas.....	151	113
Oil application.....	155	115
Oiling.....	154	114
Phenol larvicide.....	156	116
Stream training.....	152	113
Subsurface drainage.....	150	112
Distribution and breeding habits.....	145	109
Identification.....	144	109
Life cycle.....	142, 143	106, 108
Nets.....	161	118
Repellents.....	162	119
Screening.....	160	118
Surveys.....	163	119
Methods of conducting.....	164	120
Objects of preventive measures.....	26	21
Observation or detention camps.....	13	9
Operation:		
Delousing plant.....	178	131
Prophylactic station.....	31	23
Soakage pit and trench.....	81	66
Oral hygiene:		
Definition.....	222	158
Educational measures.....	224	159
General measures.....	223	158
Organization of examining units.....	216	150
Outlines for—		
Epidemiological investigation.....	208	144
Sanitary inspections, mess.....	107	80
Pail latrines.....	69	49

INDEX

	Paragraph	Page
Paris green larvicide.....	157	116
Pasteurizing establishments.....	123	93
Prenol larvicide.....	156	116
Physical examinations.....	212	149
Physical inspections.....	217, 218	150, 153
Poultry.....	118	88
Preservation of meats.....	110	85
Prevalence of venereal diseases.....	27	22
Preventive measures, disease.....	17	12
Objects of.....	26	21
Responsibility for initiation and enforcement.....	7	5
Primary factors in spread of disease.....	11	8
Principal objects of military sanitation programs.....	8	6
Prophylactic—		
Rate.....	230	163
Station, operation.....	31	23
Prophylaxis:		
Application, method.....	32	23
Chemical.....	30	23
Individual.....	33	24
Mechanical.....	29	22
Purification of temporary water supply.....	43	29
Purpose of military sanitation.....	1	1
Quarantine, establishment.....	12	9
Quartermaster Corps, responsibility for water supply.....	35	25
Rat.....	179	132
Bait:		
Preparation.....	185	134
Distribution.....	186	134
Classification.....	180	132
Control procedures.....	182	133
Fumigation.....	192	136
Habits.....	181	132
Poisoning.....	184	133
Prebaiting.....	187	135
Proofing.....	183	133
Surveys.....	193	137
To determine—		
Degree of infestation.....	195	137
Presence of plague infected.....	194	137
Trapping.....	188	135
Traps, types.....	189	135
Ratios.....	231	163
Refrigerators, small.....	111	85
Repellents, mosquito.....	162	119
Reports and charts, statistical.....	15	11
Requirements of troops, water.....	39	26
Respiratory diseases, classification.....	16	12
Responsibility for—		
Initiation and enforcement of preventive measures.....	7	5
Physical examinations.....	213	149

INDEX

Responsibility for—Continued.	Paragraph	Page
Sanitation.....	2	1
Waste disposal.....	55	39
Water reconnaissance.....	50	34
Water supply by Quartermaster Corps.....	35	25
Rubbish dumps.....	92	70
Construction.....	93	71
Maintenance.....	94	71
Sanitary—		
Control of water supply by Medical Department.....	36	25
Details.....	4	3
Inspections:		
Meats:		
Cured.....	116	88
Fresh.....	115	
Meat foods, canned.....	117	88
Messes.....	106	79
Orders.....	200	141
Form.....	205	142
Preparation.....	202	141
Responsibility.....	201	141
Scope.....	203	142
Submission.....	204	142
Supervision.....	3	2
Survey, conduct.....	199	141
Sanitation, in theater of operation.....	5	3
Scabies.....	221	156
Screening, mosquito.....	160	118
Sea foods.....	121	90
Seating spaces, latrine.....	57	40
Serbian barrel.....	172	128
Soakage—		
Pits:		
Liquid waste.....	78	62
Operation.....	81	66
Urinal.....	66	46
Trench.....	80, 81	65, 66
Sodium arsenite.....	140	105
Special terms, definitions.....	9	6
Spoilage, meat.....	109	84
Spread of disease, primary factors in.....	11	8
Standards for physical qualifications.....	214	149
Statistical charts and reports.....	15	11
Statistical rates.....	225, 226	160
Formula for estimation.....	228	161
Noneffective.....	229	162
Statistical strengths.....	225, 227	160
Storage:		
Facilities, food.....	99	74
Meat and meat food products in temporary camps.....	112	86
Stream—		
Flow estimation.....	41	27
Training.....	152	113
Summaries, points covered and reported on, water reconnaissance.....	52	35

INDEX

	Paragraph	Page
Surveys:		
Mosquito-----	163	119
Methods of conducting-----	164	120
Rat-----	193	137
To determine—		
Degree of infestation-----	195	137
Presence of plague infested-----	194	137
Sanitary-----	197	139
Form for-----	198	139
Tinea Cruris-----	220	155
Trap—		
Baits-----	190	136
Setting-----	191	136
Types-----	189	135
Urinals-----	62	43
Protection-----	63	45
Uriné soakage pits-----	66	46
Venereal diseases:		
General control measures-----	28	22
Prevalence-----	27	22
Treatment of, as a control measure-----	34	24
Wastes:		
Classification-----	54	39
Disposal:		
Human-----	56	40
In bivouac-----	59	40
In camps-----	60	42
On marches-----	58	40
Kitchen-----	101	77
Liquid-----	76	61
In bivouac-----	77	62
Responsibility for-----	55	39
Water—		
Discipline, on marches-----	48	33
Hardness-----	38	26
Reconnaissance-----	49	34
Conduct-----	51	34
Responsibility for-----	50	34
Summary of points reported on-----	52	35
Requirements, troops-----	39	26
Sources, ground or surface-----	40	27
Sterilization, other emergency measures used-----	47	32
Supply—		
Equipment, Engineer Corps-----	44	29
Maps and conventional signs for-----	53	36
Quartermaster Corps responsibility for-----	35	25
Sanitary control by Medical Department-----	36	25
Temporary, purification-----	43	29
Turbidity-----	37	26
Wash and bath, disposal-----	82	66
Water-sterilizing bag (Lyster bag)-----	45	30
Technique for use-----	46	31
Wells, yield-----	42	28