

WAR DEPARTMENT

ORDNANCE FIELD MANUAL

ORDNANCE SERVICE
IN THE FIELD

July 11, 1942

RESERVED
FOR REFERENCE USE ONLY

**REFERENCE USE
ONLY**

NOT TO BE TAKEN FROM LIBRARY

ORDNANCE FIELD MANUAL

ORDNANCE SERVICE IN THE FIELD

CHANGES }
No. 6 }

WAR DEPARTMENT,
WASHINGTON 25, D. C., 29 July 1944.

FM 9-5, 11 July 1942, is changed as follows:

CHAPTER 7

ORDNANCE SERVICE IN THE COMBAT ZONE

SECTION IV (Added)

AMPHIBIOUS OPERATIONS

84.1. GENERAL.—*a.* An amphibious operation is an expedition dispatched by sea to make a landing assault on a hostile shore. The composition of the task force involved is determined by joint planning and training of Army and Navy personnel. Army landing forces are organized to facilitate embarkation and debarkation, to attain a powerful invasion force, and to provide logistic support of the operation. Normally the initial landing team will consist of one battalion of combatant troops. The logistic functions for this unit will be accomplished by a "shore party" to which ordnance personnel may be added when considered feasible. The shore group is the task organization of the landing force for the control of army administrative functions on the beach. This group includes the shore parties augmented by necessary service personnel. Ordnance personnel would normally be included. A large portion of the equipment used by the combat troops to establish, consolidate, and extend any beachhead consists of ordnance matériel. Ordnance units which are included in the task force organization must be especially organized and equipped to perform the ordnance service to the force. It is therefore very necessary that a definite and specific ordnance plan be included in the general over-all plan for the proposed operations, with emphasis on those necessary items normally included in class IV supply.

b. Joint oversea operations are covered in FM 60-5 (when published) (revision of 31-5).

■ 84.2. PLANNING.—*a.* If ordnance troops are included in the initial phases of the landing operation, the plan for these troops will be based upon the tactical plan of the units they support. In order to prepare the ordnance annex, the ordnance officer must be advised of the complete plans of the combat teams for seizing the beachhead line, including the number and type of weapons and vehicles with which the task force is equipped.

b. Selection of tentative sites for initial ammunition storage areas is the responsibility of the shore party commander, who may be assisted by an ordnance officer.

c. Plans for the debarkation will include the order and priority in which ordnance personnel and equipment are to be debarked.

d. The ordnance plan should include in detail the supply, maintenance, evacuation, and replacement of ordnance matériel. The failure of an adequate supply and replacement system may result in the failure of the operation, regardless of the initial tactical success. The following will be included in detail:

(1) The selection of appropriate ordnance units to be included in the landing force, and their strength and composition together with details for attachment to combat units, when advisable.

(2) Supplies to be taken in the initial ship-to-shore movements, together with detailed plan for packing and stowage. This, in turn, will depend upon—

(*a*) Mission, strength, and composition of the task force.

(*b*) Supplies required en route, and the amount of beach reserves and landing force reserves to be established and maintained.

(3) The level of supplies to be maintained.

(4) The amount and kind of matériel to be serviced, the extent of maintenance to be rendered, and the anticipated battle losses and damage to equipment.

(5) The schedule of supplies necessary to increase the basic stock to the required landing force reserve level.

e. The plan should include the numbers of major items to be taken for limited replacement of small arms damaged or lost in landing operations, and the echelon or echelons in which these replacement items will be carried.

f. So far as practicable, all elements of the task force should be equipped with the same types of weapons and vehicles, in order to simplify the maintenance and supply problems. All

ORDNANCE SERVICE IN THE FIELD

ordnance matériel of the task force should be placed in completely serviceable condition, including waterproofing, prior to embarkation, and stowage items carefully checked. Provision should be made for limited inspection and maintenance en route, when warranted by conditions.

g. The ordnance plan will show in detail the necessary changes to organizational equipment necessary to support the assigned mission.

h. Ordnance troops should establish maintenance and resupply functions immediately after they disembark.

i. The plan should include provisions for a de-waterproofing area, in order to keep litter and debris from beaches and transportation routes.

■ 84.3. INITIAL ORDNANCE TROOPS.—*a.* When ordnance troops are attached to the shore party, they will function under the shore party commander. As soon as possible, all advance ordnance personnel will revert to the control of the task force ordnance officer or the army ordnance officer as specified by the task force commander.

b. The initial ordnance troops should normally consist of ammunition, bomb disposal, general supply, and maintenance personnel.

(1) Ammunition for a battalion landing team will normally be moved from the beach to selected areas by the shore party. During subsequent organization of regimental or divisional supply points, ordnance personnel will be charged with this responsibility. The dispersion of ammunition supply points should be given due consideration so as to provide accessibility to troop units, lateral supply and protection from enemy action.

(2) The bomb disposal detail should be made up of one officer and a sufficient number of enlisted men with equipment to handle any anticipated requirement. When practicable, each detail should be a bomb disposal squad, separate. Bomb disposal personnel will also be able to give advice and assistance on handling of captured enemy ammunition and inspection of suspected booby traps. Ordnance personnel who are not trained in bomb disposal technique should never attempt to handle unexploded enemy bombs.

(3) In the initial landing, ordnance general supplies will usually be limited to replacement items, cleaning and preserving

materials, and fast-moving spare parts which will be required during the first few days of operations. Corrosion, due to salt water, will be the most important factor which will cause equipment to become unserviceable. If available, knocked-down bins may be landed in order to set up the depot before arrive.

(4) Maintenance personnel and equipment will be limited to small arms, artillery, and vehicle emergency repair. Usually it will be advisable to consolidate the maintenance and supply operations during the initial stages.

(5) During the early stages, transportation will be non-existent, or very limited. Ordnance contact parties will be prepared to operate on foot, and the service which they can render will be limited to the tools and parts which can be carried on their persons.

(6) As soon as the initial ordnance services have been established, all units should be notified as to their locations. Signs indicating locations of ordnance installations should be made up prior to embarkation in order to be ready for immediate use when needed.

■ 84.4. OPERATIONS ON SHORE.—*a.* Usually troops in the initial landing will carry sufficient ammunition to meet their needs, until reserve stocks can be brought in by succeeding waves. Artillery troops usually land with their basic load of ammunition plus a reserve, as authorized by the task force commander.

b. Since the combat troops will be occupied in establishing the beachhead and placing guns in position, it is the duty of the shore party personnel to unload the ammunition onto the beach. It is desirable that this be accomplished under ordnance supervision to assure that ammunition is segregated and stacked by type and caliber on suitable high ground with sufficient dunnage and cover to keep ammunition dry, and that powder charges, fuzes, primers, etc., are available and issued in appropriate quantities and that all safety precautions are observed.

c. The troops in the initial wave will usually carry a very limited amount of supplies so that their mobility will not be impaired. Boats of later waves will bring in additional supplies. These additional supplies are dumped on the beach and will require rehandling under difficult conditions. Carrying

ORDNANCE SERVICE IN THE FIELD

parties must be used to advance supplies inland to selected sites.

d. The initial ammunition and general supply points are established near the beach and supplies arriving by boat are moved directly to these points. These locations will have been tentatively selected prior to landing (see par. 84.2b) from a study of available maps or aerial photographs. Final determination is made only after careful reconnaissance by the shore party commander, assisted by any advance ordnance ammunition personnel. Factors considered during the selection of these sites are:

- (1) Convenience to boat landings.
- (2) Cover from enemy observation and fire.
- (3) Terrain conditions.
- (4) Traffic routes inland, including beach exits.
- (5) Facilities for handling supplies and unit trains.
- (6) Possibilities of expansion.
- (7) Access to probable routes of forward displacement.
- (8) Tidal movements.

e. Every means should be taken to expedite the movement of supplies from the beach to the selected sites. The beach should be cleared as soon as possible to avoid congestion, possible loss of supplies due to enemy action, and to expedite segregation. Suggested aids are:

(1) Supplies may be loaded on pallets or skids prior to embarkation. These pallets or skids are then moved intact from the ship to the shore, and tractors or bulldozers may be used to pull them along fairly smooth beaches and trails.

(2) Vehicles may be loaded with supplies and landed completely loaded if sufficient roads are available. The loaded vehicles can then be driven directly to the ordnance area.

(3) When available, amphibian vehicles may be used to haul supplies direct from the ship across the beach to inland sites.

f. As soon as practicable, complete ordnance maintenance and supply units should be landed. Bivouac areas and depot and maintenance sites should be selected and prepared by the personnel with the initial force, so that these units can move directly to these areas upon arrival.

■ 84.5. RESUPPLY.—Resupply will be effected by two methods: water and air transport.

ORDNANCE FIELD MANUAL

a. The majority of the resupply will be by water transport. In the event that no port facilities are available, the bulk of the supplies will be unloaded from the ship to a lighter, and from the lighter onto the beach. The supplies must then be moved from the beach to the supply points which have been established. Supervision by ordnance personnel must be provided at the point of debarkation, and should be maintained all the way to the supply point. The additional labor required to move all of these supplies normally will be furnished by detail from the army quartermaster service organizations, as provided in FM 100-10.

b. In the initial planning for the operation, the task force commander may prescribe a procedure for the supply of the ground units by air. Ordinarily, the greatest demand on the part of combat troops for resupply by air will be for ammunition and emergency spare parts. During the initial stages, the delivery of supply by air necessarily may be by parachute. Type loads for parachute delivery units are contained in FM 31-40. If air fields are captured or built, air supply can be made by transport planes or gliders. In the event that an air field is established, it is advisable to have a small ordnance detachment on duty at the air field in order that ordnance supplies are properly segregated, safely handled, and directed to the proper point.

■ 84.6. EXPANSION.—a. Base depots are established as soon as the advance justifies, and all supplies remaining at supply points near the beach are absorbed by these depots. Reserves in base depots are maintained at a level prescribed in the administrative plan of the task force.

b. First priority on construction services and personnel are for the building of docks, air fields, and main roads. It may therefore be necessary in the initial stages for the ordnance troops themselves to start the construction work necessary in building a base depot.

c. The planning for the establishment of ordnance base depots should take into account the fact that many items in excess of T/O & E will be required, and provision must be made for them.

d. As soon as the situations will allow, ammunition which was landed in the initial waves will be inspected and any unserviceable items will be disposed of by dumping at sea or by another approved method.

ORDNANCE SERVICE IN THE FIELD

e. When the expansion of the base reaches the point where it becomes an established port, the ordnance problem becomes one of general ordnance service in the combat zone.

[A. G. 300.7 (26 Apr 44).]

BY ORDER OF THE SECRETARY OF WAR:

G. C. MARSHALL,

Chief of Staff.

OFFICIAL:

J. A. ULIO,

Major General,

The Adjutant General.

DISTRIBUTION:

As prescribed in paragraph 9a, FM 21-6; Base Comds (5);
Island Comds (5); Def Comds (5); Sectors (5); Sub-
Sectors (5); B (2); R (2); Bn 1-7, 17, 44 (2), 9 (10);
Co. 9 (10).

For explanation of symbols, see FM 21-6.

ORDNANCE FIELD MANUAL

ORDNANCE SERVICE IN THE FIELD

CHANGES }
 No. 5 }

WAR DEPARTMENT,
 WASHINGTON 25, D. C., 18 February 1944.

FM 9-5, 11 July 1942, is changed as follows:

■ 32. TYPES AND MISSION.

* * * * *

b. *Functional types.* (As added by C 1.)

* * * * *

(4) (Added) *Composite.*

[A. G. 300.7 (9 Feb 44).] (C 5, 18 Feb 44.)

■ 35. ORDNANCE BASE COMPANIES. (As changed by C 1.)

* * * * *

m. (Added) *Ammunition renovation company* (no T/O).—
 (1) *General.*—The requirements of tactical organizations for this company are so varied that it is not deemed desirable to standardize on a fixed composition. These companies are made up as required from appropriate cells of T/O & E 9-500 (see par. 35.3), the number and types of which are dictated by the requirements of the specific situation. Cell GA, ammunition renovation platoon, comprises the working element. A typical composition of a renovation company is this cell, plus three others of T/O & E 9-500: company headquarters, cell AB; mess team No. 2, cell AE; and ammunition supply team No. 1 cell BD; or a total of 4 officers and 101 enlisted men. The mission of such a company is the renovation and modification of American ammunition and the salvage and reconditioning of enemy ammunition.

(2) *Operations.*—American ammunition received in an over-sea theater will not normally be inspected at the point of receipt except for the repair of ammunition boxes. When ammunition is issued to using troops and any concealed damages are discovered, such damaged ammunition will be segregated at the batteries or other combat unit positions and returned to the ammunition supply points where it will be repaired if within the capabilities of the small renovation kit assigned to ammunition companies (see SNL N-17). Items more seriously damaged will be evacuated to an ammunition depot where it will be collected and held until a sufficient quantity is assembled to make it worth while to send a renovation company to that point. It will be

*This change is printed as a pamphlet to conserve paper and printing and to expedite delivery to the field.

impractical to provide one such company for each ammunition depot, but the equipment of the renovation company has been made highly mobile so that it can be taken from location to location as the requirements for the work accumulates.

[A. G. 300.7 (9 Feb 44).] (C 5, 18 Feb 44.)

■ **35.3 COMPOSITE ORGANIZATIONS (Added).**—*a. General.*—Composite ordnance organizations are authorized by T/O & E 9-500. This Table of Organization and Equipment consists of a number of cells covering the entire field of ordnance service. These cells may be grouped together in any suitable combination. The specific composition will be established by the War Department order activating the particular organization. Composite organizations will find their principal use in furnishing the ordnance service for task forces and as special ordnance organizations, the requirements for which may be so varied as not to warrant the standardization of any one composition. An example of this latter is the ammunition renovation company described in paragraph 35*m*. In the case of task forces, as the theater of operations expands and additional troops are moved into the area, established types of ordnance organizations will be moved in and gradually take over ordnance service, or the composite organization may be increased in strength by the addition of cells to enable it to carry the increased load. In this latter situation, the War Department will effect the augmentation by the activation and assignment of the necessary cells.

b. Composition.—T/O & E 9-500 consists of a number of various sized cells under each of the following categories; administration, depot, maintenance, distribution, recovery, bomb disposal, and ammunition renovation. The type and size of the operational teams grouped together depend on the expected mission of the organization. Then, depending on the number of individuals assigned, the suitable headquarters, mess, service, and repair teams are assigned. The capabilities of each of the cells are indicated in the "Remarks" section of the published T/O & E.

[A. G. 300.7 (9 Feb 44).] (C 5, 18 Feb 44.)

BY ORDER OF THE SECRETARY OF WAR:

OFFICIAL:

J. A. ULIO,

Major General,

The Adjutant General.

G. C. MARSHALL,

Chief of Staff.

ORDNANCE SERVICE IN THE FIELD

a. Methods of destruction used should be the simplest which will accomplish the desired purpose. As an example, explosives should not be used in a case where the use of a heavy hammer will effect the desired destruction.

b. Selection of a feasible method requires imagination and initiative. If only a few rifles in the small-arms section are to be destroyed, individual methods of destruction can be applied in a matter of minutes. On the other hand, if a large number of rifles in original containers are in stock, such methods are obviously impractical. Mass destruction by fire or explosives is required in such a case.

c. If normal and reasonable safety precautions are observed, demolition of large quantities of matériel may require considerable space and time. Destruction by gunfire may be desirable if time is limited.

d. Care should be taken to destroy repair parts as well as major items. It will do little good to destroy a ring gear if the enemy finds a new one in a spare parts truck.

■ 31.3 DESTRUCTION BY WELDING AND CUTTING.—Destruction by means of acetylene cutting torches and electric welding may be applicable where only a few large items are affected. Cutting operations may be limited by the amount of oxygen and acetylene available. Destruction by these means should be under the supervision of the shop foreman or section chief since a high degree of technical knowledge is necessary to discern between effective and ineffective operations.

■ 31.4 ORDNANCE DEPOT.—The destruction of matériel in an ordnance depot is associated with inherent difficulties. This is due in part to the packing of much matériel in original containers and to the lack of the required facilities. Destruction should be accomplished by explosives and fire. The materials required for destruction of the depot should be estimated and kept on hand at all times.

[A. G. 300.7 (21 Jan 44).] (C4, 10 Feb 44.)

ORDNANCE FIELD MANUAL
ORDNANCE SERVICE IN THE FIELD

CHANGES } WAR DEPARTMENT,
No. 4 } WASHINGTON 25, D. C., 19 February 1944.

FM 9-5, 11 July 1942, is changed as follows:

CHAPTER 4.1 (Added)

DESTRUCTION OF ORDNANCE MATÉRIEL

■ 31.1 **PLAN FOR DESTRUCTION.**—*a.* It may sometimes be necessary for ordnance personnel to destroy the matériel in their possession to prevent it falling into the hands of the enemy. The decision for this destruction rests with the army or theater commander, and should not be carried out without his orders unless communication with him is impossible. However, it is the responsibility of the unit commander to prepare a plan for the destruction and thoroughly train his personnel in its execution in order to insure its success when its application is necessary.

b. Two considerations require that this plan be flexible.

(1) The matériel under consideration is subject to wide variation as to type and quantity. In depots, this variation will be caused by changes in stock levels; in maintenance shops, by changes in matériel to be repaired; and in both, the variations will be affected by the tactical situation.

(2) The second requirement for flexibility is due to the fact that means for evacuation may become impaired. Trucks may be knocked out by accident or enemy action, roads may become jammed with traffic or may be interdicted by hostile fire. Time required for complete destruction may be lacking.

c. The first step in the plan is the determination of what is to be evacuated and what is to be destroyed. Material to be evacuated will be limited by available transportation.

d. The second step is the determination of materials required for complete destruction of that material which is to be destroyed. This will include demolition materials, oxygen and acetylene, welding rod, incendiary grenades, gasoline, and other incendiary materials, depending on the methods of destruction chosen. The matériel to be destroyed should be listed by types, the method

*This change supersedes Training Circular No. 18, War Department, 1943, and is printed as a pamphlet to conserve paper and printing and to expedite delivery to the field.

and degree of destruction stated, and the materials required for one article, the number of articles, the total materials required, the time for destruction of one item, and the time in man-hours for destruction of the required number of items should all be given.

e. The third step is the assignment of personnel to the task. This should be planned so that all destruction is completed at approximately the same time. It may be necessary to assign men to other than their normal work to accomplish this. For example, instrument men may have to assist in the destruction of small arms. It may also be necessary to revise the selection of methods of destruction.

f. After the plan has been carefully balanced, the men available for the work should be trained in its execution. Every man should know exactly what he is to do and be trained in simulation of the job.

g. A plan for complete destruction as outlined above will probably require more time or more materials than the organization can reasonably expect to have. It should be revised as to the extent of destruction of the individual items on the basis of expected available time. The required materials should then be obtained and kept on hand at all times.

h. The above plan is based on the evacuation of certain matériel. An addendum should be prepared for the destruction of this matériel also, to be used in case its evacuation is impossible.

i. In the event actual destruction becomes necessary, it is very probable that the prepared plan will require revision on the spot. If possible, the unit commander should be on hand to render such decisions as may be necessary. In any event, his principal assistants (shop or depot officer and foremen or chief clerk) should be on the job to supervise the work.

j. An illustrative plan prepared as outlined above is shown in appendix IV.

■ 31.2 METHODS OF DESTRUCTION.—The approved method of destruction of each item of ordnance matériel is published in the pertinent Field Manual. This method should be used whenever possible in order to obtain uniform results throughout the Army. However, the specific method employed is a decision of the commander and should be based on the considerations given below.

APPENDIX IV (Added)

PLAN FOR DESTRUCTION

■ 1. GENERAL.—Preparation of a plan for the destruction of ordnance matériel in the hands of ordnance units as outlined in paragraphs 18.1 to 18.4 is illustrated below. The plan is based on the requirement for the destruction of matériel on hand in a maintenance shop. As it is intended only to illustrate a method for developing a plan, all numerical quantities are taken at random.

2. PLAN FOR DESTRUCTION OF MATÉRIEL.—a. Small arms.

Item	Number	Time each (minutes)	Total man-hours	Instructions	Materials							
					TNT		Gas		Oxygen		Acetylene	
					Each	Total	Each	Total	Each	Total	Each	Total
Pistol.....	125	1.5	3.1	Flatten recoil spring, remove link, smash magazine.								
Rifle, M1903.....	43	1.0	.7	Bend barrel, break striker point.....								
Rifle, M1.....	67	2.5	2.8	Bend barrel, break striker point, break hammer hooks.								
Gun, submachine.....	15	1.5	.4	Break pivot plate.....								
Machine gun, caliber .30..	48	2.5	2.0	Smash cover, back plate, T-slot lock frame, barrel extension.								
Machine gun, caliber .50..	21	3.5	1.2	Smash cover, back plate, depressors, barrel extension.								
Carbine.....	82	2.0	2.7	Bend barrel, break striker point, bend operating rod.								
Rifle, automatic.....	6	1.0	.1	Bend barrel, break striker point, bend operating rod.								
Total.....			13.0									

ORDNANCE SERVICE IN THE FIELD

b. Artillery

Item	Number	Time each (minutes)	Total man-hours	Instructions	Materials											
					TNT		Gas		Oxygen		Acetylene		Rod			
					Each	Total	Each	Total	Each	Total	Each	Total	Each	Total		
Mortar, 81-mm.....	3	6	0.3	Cut tube and base cap, cut screws.....					20	60	20	60				
Gun, A.T., 37-mm.....	8	13	1.7	Cut breech ring, firing pin, weld, recoil rod, cut elevating and traversing racks, cut axle and pintle.		0.2	1.6	40	320	40	320	40	320	0.5	4.0	
Howitzer, 105-mm.....	6	30	3.0	Cut breech ring, firing pin recuperator cylinder, elevating and traversing racks, axle, and pintle.				60	360	60	360					
Howitzer, 155-mm.....	1	30	.5	Weld breech threads, cut breechblock threads, recoil cylinders, and elevating rack.		0.2	0.2	40	40	40	40	40	40	1.0	1.0	
Total.....			5.5				2	780	780	780	780				5.0	5.0 lb.
Total welding time.....			.7													
Total cutting time.....			4.8													

c. Instruments.

Item	Number	Time each (minutes)	Total man-hours	Instructions	Materials															
					TNT		Gas		Oxygen		Acetylene		Rod							
					Each	Total	Each	Total	Each	Total	Each	Total	Each	Total						
Glass, field.....	11	1.0	0.1	Smash with hammer.....																
Binocular.....	15			Evacuate.....																
Finder, range, 1-meter.....	7			do.....																
Circle, aiming, M1.....	6			do.....																
Circle, aiming, M1916.....	9	1.0	.1	Smash with hammer.....																
Telescope, panoramic, M5A2.....	11			Evacuate.....																
Telescope, panoramic, M6.....	3			do.....																
Sight, quadrant, M1918A1.....	2			do.....																
Telescope, battery commander's.....	5			do.....																
Total time.....			.2																	

ORDNANCE SERVICE IN THE FIELD

d. *Automotive.*

Item	Number	Time each (min-utes)	Total man-hours	Instructions	Materials													
					TNT		Gas		Oxygen		Acety-lene		Rod					
					Each	Total	Each	Total	Each	Total	Each	Total	Each	Total				
Truck, ¼-ton.....	1	3	0.1	Burn.....			5	5										
Truck, 2¼-ton.....	6	3	.2	do.....			10	50										
Truck, command.....	2	3	.1	do.....			10	20										
Car, half-track.....	3	3	.2	do.....			10	30										
Tank, light.....	1	10	.1	Demolition on engine, transfer case, and differential.	7	7												
Total.....			.7		7 blocks; 3½ lb.				105 gal.									
Time for demolition.....			.1															

e. Miscellaneous.—Organizational equipment not listed to be evacuated.

Item	Number	Time each (minutes)	Total man-hours	Instructions	Materials														
					TNT		Gas		Oxygen		Acetylene		Rod						
					Each	Total	Each	Total	Each	Total	Each	Total	Each	Total					
Range, field, M1937(QMC)	3	2	0.1	Smash with hammer.															
Paulins	5	2	.2	Burn			0.5	3.0											
Typewriters	3	2	.1	Smash with hammer.															
Unit, generating (Signal Corps)	1	5	.1	Burn			5.0	5.0											
Earth auger (engineer)	1	10	.2	Demolitions on engine, transmission, and driving head.	10	10													
Total			.7			10 blocks; 5 lb.		8.0								gal.			
Time for demolitions			.2																

ORDNANCE SERVICE IN THE FIELD

f. Special crews formed.

Crew	Squad	Men
Demolition.....	1	3
Welding (1 machine available).....	1	3
Cutting (5 torches available).....	5	15
Evacuation ¹		18
Moving ²		18
Total.....		57

¹ To gather up, load, and otherwise assist in preparation of matériel for evacuation.

² To move vehicles and artillery to areas convenient for destruction, and otherwise assist as may be necessary.

g. Men available for destruction.

	Total	Super- visory	Net
Service section.....	15	1	14
Small-arms section.....	12	1	11
Artillery section.....	22	2	20
Instrument section.....	12	1	11
Automotive section.....	88	4	84
Total.....			140
Special crews.....			57
Available for hand destruction.....			83

h. Total man-hours required.

Section	Weld- ing	Cut- ting	Demol- ition	Hand	De- struc- tion
Small arms.....					13.0
Artillery.....	0.7	4.8			
Instrument.....					.2
Automotive.....			0.1		.6
Miscellaneous.....			.2		.5
Total.....	.7	4.8	.3		14.3

i. Total time required.

Hand destruction.....	$14.3/83 \times 60 = 10.3$ minutes.
Welding.....	$0.7/1 \times 60 = 42$ minutes.
Cutting.....	$4.8/5 \times 60 = 58$ minutes.
Demolition.....	$0.3/1 \times 60 = 18$ minutes.
Evacuation.....	20-30 minutes (estimated).
Moving.....	20-30 minutes (estimated).

j. Changes.—It is apparent that less destruction must be accomplished by welding and cutting. Welding time may be saved by reducing the amount of bead applied to the recoil rods on the 37-mm gun, reducing the time for this task from 4 minutes to 2 minutes each. Cutting may be reduced by effecting destruction of the axle and pintle of the 37-mm and 105-mm weapons by means of demolitions. This will eliminate 5 minutes each on the guns, and 15 minutes each on the howitzers. Time required for the additional demolitions will be 14 weapons at 5 minutes each. TNT required will be 8 guns at 2 blocks each, plus 6 howitzers at 3 blocks each, or 17 pounds. Two extra demolition crews may be organized for the job, reducing the number of men available for hand destruction to 77.

k. Revision.—The plan is revised accordingly; the revised artillery sheet is given in *l* below.

(1) Revised times are—

Hand destruction...	$14.3/77 \times 60$	11 minutes (11.14)
Welding.....	$0.4/1 \times 60$	24 minutes
Cutting.....	$2.4/5 \times 60$	29 minutes
Demolition.....	$1.5/3 \times 60$	30 minutes

(2) The distribution of the men who are to perform hand destruction is as follows:

Small arms.....	$13.0 \times 60/11.14$	69
Artillery.....	None	--
Instruments.....	$0.2 \times 60/11.14$	2 (no section
Automotive.....	$0.6 \times 60/11.14$	3 should have
Miscellaneous.....	$0.5 \times 60/11.14$	3 less than 2
		— men)

77

ORDNANCE SERVICE IN THE FIELD

I. Artillery (revised).

Item	Number	Time each (minutes)	Total man-hours	Instructions	Materials										
					TNT	Gas	Oxygen	Acetylene	Rod	Each	Total	Each	Total		
Mortar, 81-mm.....	3	5	0.3	Cut tube and base cap, cut screws.			20	60	20	60					
Gun, 37-mm. A.T.....	8	11	1.6	Cut breech ring, firing pin, elevating and traversing racks, weld recoil rod. Demolition on axle and pintle.	2	16	0.1	25	200	25	200		200	0.3	2.4
Howitzer, 105-mm.....	6	20	2.0	Cut breech ring, firing pin, recuperator, cylinder, elevating and traversing racks. Demolition on axle and pintle.	3	18		30	180	30	180				
Howitzer, 155-mm.....	1	30	.5	Weld breech threads, cut breechblock threads, recoil cylinder, elevating rack.			.2	40	40	40	40		40	1	1
Total.....			4.3			34 blocks; 17 lb.	1 gal.		480		480		480		4 lb.
Total welding time.....			.4												
Total cutting time.....			2.4												
Total time for demolitions.....			1.2												

ORDNANCE FIELD MANUAL

■ **3. ASSIGNMENT OF PERSONNEL, EXCLUSIVE OF SUPERVISORY PERSONNEL.**—A roster will be prepared giving the assignments by name, including supervisory personnel. The duties of each team or squad will be specifically stated in detail.

From	Small arms	Artillery	Instruments	Automotive	Miscellaneous	To					Total
						Welding squad	Cutting squad	Demolition squad	Evacuation squad	Moving squad	
Service section.....						2	10	2			14
Small arms.....	11										11
Artillery section.....	7					1	5	7			20
Instrument section.....	9		2								11
Automotive section.....	42			3	3				18	18	84
Total.....	69		2	3	3	3	15	9	18	18	140

■ **4. SUMMARY OF MATERIALS REQUIRED.**—This material should be obtained and kept on hand at all times. The demolition material should include an abundant supply of nonelectric detonators and slow burning fuses, even if electric equipment and detonators are available.

ORDNANCE SERVICE IN THE FIELD

Team or squad	TNT (pounds)	Gasoline (gallons)	Oxygen (drums)	Acetylene (drums)	Welding rod (pounds)
Small arms.....					
Artillery.....	17	1	3	3	4
Instrument.....					
Automotive.....	4	105			
Miscellaneous.....	5	8			
Evacuation.....					
Moving.....		10			
Total.....	26	124	3	3	4

[A. G. 300.7 (21 Jan 44).] (C 4, 19 Feb 44.)

BY ORDER OF THE SECRETARY OF WAR:

G. C. MARSHALL,
Chief of Staff.

OFFICIAL:

J. A. ULIO,
Major General,
The Adjutant General.

ORDNANCE FIELD MANUAL

ORDNANCE SERVICE IN THE FIELD

CHANGES }
 No. 3 }

WAR DEPARTMENT,
 WASHINGTON 25, D. C., 30 December 1943.

FM 9-5, 11 July 1942, is changed as follows:

■ 13. REQUIREMENTS (Superseded). — *a. General.* — Initial requirements of supplies for a new theater of operations are usually incorporated in the plans of the War Department. These requirements, together with their shipment dates, are reviewed by the appointed theater commander prior to his departure for the theater. Thereafter the theater commander requisitions additional requirements or replenishment supplies from the zone of the interior through the port of embarkation serving his theater.

b. Requisitions. — Requisitions submitted subsequent to supply of initial requirements are filled in accordance with priorities established by the War Department with due consideration being given to the detailed desires of the theater commander as to priority of items and dates of shipment. Within the theater of operations, supply services must insure the timely anticipation of requirements by careful planning and early submission of requisitions.

c. Basic loads of ordnance units. — (1) Ordnance units which are organic with tactical organizations will carry spare parts and tools when entering any theater of operations.

(2) Ordnance units which are part of a task force destined to occupy a new theater of operations will carry their full basic loads of tools and spare parts on debarkation in accordance with the ordnance matériel of the task force and with the ordnance plan.

(3) Ordnance units going to an already established theater will carry the tools and spare parts listed in the appropriate SNL in the N Group or in the event this SNL has not been published, the units will carry the tools and spare parts computed from the T/BA or appropriate T/E and pertinent SNL addenda. These units will not carry special spare parts and tools upon embarkation unless their specific mission is known. These special spare parts and tools will be drawn from the oversea depots upon arrival.

(4) Theater ordnance officers must make certain that depots in their theater are stocked with tools and spare parts covering the maintenance requirements of the ordnance matériel being shipped or about to be shipped to the theater.

[A. G. 300.7 (21 Dec 43).] (C 3, 30 Dec 43.)

BY ORDER OF THE SECRETARY OF WAR:

G. C. MARSHALL,
Chief of Staff.

OFFICIAL:

J. A. ULIO,
*Major General,
 The Adjutant General.*

ORDNANCE FIELD MANUAL

ORDNANCE SERVICE IN THE FIELD

CHANGES }
 No. 2 }

WAR DEPARTMENT,
 WASHINGTON 25, D. C., 17 September 1943.

FM 9-5, 11 July 1942, is changed as follows:

■ 38. **GENERAL.**—Ordnance troops with air forces are divided into three categories:

a. Ordnance sections of the headquarters of the various staff echelons.

b. Ordnance sections which are an integral part of a tactical squadron.

c. Ordnance companies.

[A. G. 300.7 (13 Aug 43).] (C 2, 17 Sep 43.)

■ 39. **ORDNANCE SECTIONS.**—*a.* **Staff sections.**—Ordnance sections for the performance of special staff functions are found in the headquarters of the following organizations:

Army Air Forces

Air forces

Air force commands

Air depot groups

Service groups

Wings

Other prescribed Army Air Forces training and technical installations.

The officer and enlisted personnel for the ordnance sections of the above mentioned organizations are included in the Table of Organization of the pertinent headquarters and headquarters squadron. (See app. III.)

b. (Added.) **Tactical sections.**—Ordnance sections which are an integral part of the tactical squadrons are included in—

Bombardment squadrons.

Fighter squadrons.

Observation squadrons.

Photographic squadrons.

Reconnaissance squadrons.

Airdrome squadrons.

The officer and enlisted personnel of the above ordnance sections are included in the pertinent Table of Organization. (See app. III.) For the functions and operations of these sections, see paragraphs 105 and 106.

[A. G. 300.7 (13 Aug 43).] (C 2, 17 Sep 43.)

■ 40. **ORDNANCE COMPANIES, AVIATION.**—Ordnance service for aviation units is performed by the following ordnance companies:

a. (Superseded.) *Ordnance supply and maintenance company, aviation* (T/O 9-417).—One of these companies is authorized for each service squadron. Its function is the supply of all items of ordnance general supply in a service center area; the repair and maintenance of all ordnance matériel, within the capabilities of its equipment (third echelon); the evacuation of all unserviceable equipment which is beyond repair with available facilities; and the operation of a reserve ammunition refilling point (RP) for all combat units located in the service center area.

b. (Superseded.) *Ordnance maintenance company, air force* (T/O 9-257).—The normal assignment is one per air force general depot. It establishes and operates a mobile or fixed shop in conjunction with the air force general depot for the maintenance, repair, and evacuation of ordnance matériel in the hands of air force units. It is the highest echelon of ordnance maintenance under the control of the Army Air Forces. Maintenance requirements beyond the capabilities of these facilities are evacuated to base shops in the communications zone.

c. (Superseded) *Ordnance depot company* (T. O. 9-57).—An ordnance depot company is normally assigned for each air force general depot. It establishes and operates the ordnance section of the depot. Its function is to store and issue class II and IV ordnance supplies.

d. (Added.) *Ordnance ammunition company* (T/O 9-17).—Normal assignment is one company per air force. It establishes, operates, and maintains the air force ammunition depot. It supplies bombs and other ammunition direct to the squadron distributing points and/or to the service center refilling points.

e. (Added.) *Ordnance service company, aviation.*—This company is established on special authorization and is assigned to air forces and commands for the purpose of augmenting the

ORDNANCE SERVICE IN THE FIELD

ordnance sections of base headquarters and air base squadrons where necessary. It is also assigned to the named air service commands in the zone of the interior where it is responsible for ordnance maintenance.

[A. G. 300.7 (13 Aug 43).] (C 2, 17 Sep 43.)

■ 41. MISSION OF ORDNANCE DEPARTMENT.—The mission of the Ordnance Department in the theater of operations is the supply and maintenance of prescribed articles, including generally all arms, armament, ammunition, tanks, ordnance vehicles, and other equipment and supplies issued by the Ordnance Department.

[A. G. 300.7 (13 Aug 43).] (C 2, 17 Sep 43.)

■ 43. ORGANIZATION.—The initial personnel for the theater ordnance office will be prescribed by the commander of the field forces, and its subsequent expansion will be in accordance with the directives of the theater commander.

[A. G. 300.7 (13 Aug 43).] (C 2, 17 Sep 43.)

■ 46. RELATIONSHIP OF ORDNANCE STAFF OFFICERS.—The ordnance staff officer, theater of operations, exercises control over ordnance activities through the ordnance officer, communications zone; the ordnance officers at the regulating stations; the air force ordnance officers; and the army ordnance officers. Figure 7 shows the relationship of these staff officers.

[A. G. 300.7 (13 Aug 43).] (C 2, 17 Sep 43.)

■ 48. GENERAL.

* * * * *

c. Function of base and forward depots.—Supplies arriving in * * * of this level. (Sec par. 18b, C 1.)

* * * * *

[A. G. 300.7 (13 Aug 43).] (C 2, 17 Sep 43.)

■ 52. OPERATION OF DEPOTS.—*a. Control of stockages and issues.*—The organization and administration of communications zone depots are direct responsibilities of the ordnance officer, communications zone. Their operation is in conformity with

the ordnance provisioning system. Stocks are prescribed
* * * see figure 9.

* * * * *

[A. G. 300.7 (13 Aug 43).] (C 2, 17 Sep 43.)

■ 58. MISSION.—The army ordnance * * * at its disposal. This includes the evacuation of ordnance matériel from ordnance collecting points to the proper ordnance shop for repair.

[A. G. 300.7 (13 Aug 43).] (C 2, 17 Sep 43.)

■ 60. RESPONSIBILITIES AND DUTIES.—*a. Responsibilities.*

* * * * *

(7) Collection and evaluation of information concerning enemy ordnance matériel in order to effect the maximum exploitation of enemy resources and matériel.

(8) (Added.) Operation of the necessary facilities for the evacuation of ordnance matériel from the forward echelons to the rear for repair.

* * * * *

[A. G. 300.7 (13 Aug 43).] (C 2, 17 Sep 43.)

■ 62. ORGANIZATION AND FACILITIES.—*a. General.*—The army ordnance service consists of an ordnance section and such troops as may be required for the performance of the ordnance maintenance and supply functions of the army. The number and nature of the troops assigned are dependent upon the number and types of combat troops assigned to the army. Normally, there will * * * a single series.

b. Army ordnance office.—A suggested organization of the army ordnance office is shown in figure 11. A discussion of this organization follows:

* * * * *

(2) The chief of the operations division must be constantly in liaison with the army G-2, and G-3, in order to keep abreast of the tactical situation. He must maintain, * * * at frequent intervals.

(3) The maintenance and general supply division has general supervision of ordnance maintenance operations and the flow of general supply. It has direct * * * in lower echelons.

ORDNANCE SERVICE IN THE FIELD

(4) The ammunition supply division functions, in relation to ammunition supply, in a manner similar to that of the maintenance and general supply section.

c. (Superseded.) Maintenance and supply.—Maintenance and supply functions within each army are carried out by ordnance companies grouped together in several battalions. Each of these battalions consists of from two to five companies under a battalion headquarters and headquarters detachment (T/O 9-76). The greatest of flexibility can and should be exercised in the use of army ordnance troops. Army ordnance battalions will normally be in two general locations; in the rear or army area, and in the corps areas.

(1) *In corps areas.*—Those battalions in the corps areas will normally be of the third echelon maintenance type, including evacuation companies, but not normally including depot companies. These battalions must be quite mobile. Disabled equipment, the repair of which is not practicable within the time available, should be displaced freely to the rear to prevent its becoming an encumbrance. The battalions will dispatch such contact parties to the supported troops as may be required. Any one or more of these battalions may be attached to the corps if conditions warrant such action.

(2) *In army area.*—The battalions in the army area may be composed of various types of companies to do general supply and maintenance work, or they may contain only similar companies to do specialized work as the situation demands. It is preferable to have one shop specializing in maintenance of automotive equipment of the transport type, one specializing in antiaircraft equipment, and one for armament in general. Similarly, the depot companies charged with storage and issue to troops (as distinguished from issues to shops) may be grouped into one battalion, even though there may be several depots and any one of these depots may be divided into sections with groups of ordnance items stored in separate locations. The alternative is to have the issue depots adjacent to and operating under the appropriate specialized shop battalion.

d. (Superseded.) Ammunition.—The army function in ammunition supply is administered in the same manner as is the maintenance function, that is, ammunition depots or supply points are established by army, utilizing ammunition battal-

ions, within reach of organizational trains of divisions or other units. The detailed procedure of ammunition supply is contained in FM 9-6. Vehicles which are dispatched to the rear for ammunition should be utilized, when practicable, for the evacuation of matériel and wounded personnel.

[A. G. 300.7 (13 Aug 43).] (C 2, 17 Sep 43.)

■ 63. OPERATIONS.—*a.* (Superseded.) *Ammunition supply.*—For administrative details of ammunition supply, see FM 9-6.

b. General supplies.—(1) *General.*—General supplies are * * * items becomes critical. (For details of supply administration, see FM 9-25.)

(2) (Added.) *General method of supply.*—(a) *Automotive.*—Medium maintenance units turn in to an army depot any unserviceable vehicle beyond third echelon repairs for immediate replacement by exchange. The army depot then evacuates the vehicle to an appropriate maintenance unit for repair and return to stock of the depot. If no exchange item is immediately available, and the vehicle is economically repairable, it is sent to an appropriate repair unit by the army depot for repair and return to the using organization. When vehicles must be issued and there is no disabled vehicle to be presented in exchange, the battalion commander assigns personnel to deliver the vehicle to the appropriate third echelon maintenance unit for delivery to the using troops.

(b) *Weapons and accessories.*—The supply of other major items, accessories, etc., is made from the army depots, by direct exchange or request from army or division ordnance units. The supply to troops is augmented by third echelon maintenance units as indicated in paragraph 33a (1), C 1. A prescribed amount of major items will be carried by maintenance units for quick supply to the troops. When the supply status is restricted, units and organizations within the army may be required to submit their requisitions to the ordnance officer of the army who will exercise the necessary control to insure the equitable distribution of the restricted supply in accordance with policies prescribed by the army commander.

(c) *Parts.*—Assemblies, subassemblies, and parts required by using organizations will be obtained by them at the nearest ordnance third echelon maintenance unit, normally by direct exchange. Third echelon maintenance units in turn obtain

ORDNANCE SERVICE IN THE FIELD

resupplies from the nearest depot (normal) or heavy maintenance unit. Heavy maintenance units obtain resupplies from army depots or from bases.

c. Maintenance.—Periodic reports of the work performed and the status of work currently in the shops will be submitted by maintenance company commanders through battalion commanders to the army ordnance officer. Whenever the status * * * by lower echelons. All ordnance maintenance throughout the army will be supervised by the army ordnance officer assisted by the commanding officers of the ordnance battalions. The standards of * * * and theater commanders. Modifications of ordnance matériel will not be made without proper authority, but when authorized, as much of this work as possible will be done by army maintenance units. (For details pertaining to maintenance operations, see FM 9-10.)

[A. G. 300.7 (13 Aug 43).] (C 2, 17 Sep 43.)

■ 63.1. (Added.) UTILIZATION OF ARMY ORDNANCE TROOPS.—

a. Delivery of supplies.—The army will make delivery from its depot stocks directly to railheads, or other designated points, normally utilizing the following methods:

(1) For track-laying vehicles—depot personnel, fourth echelon units, and/or evacuation companies.

(2) For other automotive vehicles—under own power, driven by personnel of the depot company (except when direct exchange is made by third echelon personnel), and/or truck regiment personnel.

(3) For wheeled artillery—by personnel and truck from third echelon units, the organization making the request, evacuation companies, and/or truck regiment personnel.

(4) For other equipment—the most suitable of the above.

b. Evacuation and resupply.—Battlefield recovery is the function of the division or other using unit. Evacuation and resupply is the function of the service units above the division. Evacuation service is primarily an army or theater function of transporting recovered matériel which has been severely damaged, from ordnance collecting points and points on the axis of evacuation, or from maintenance establishments, to army repair centers, railheads, or communications zone bases. Damaged matériel is placed at the collecting points by combat personnel (supplemented by service personnel if necessary). Evac-

uation companies are designed to transport all types of heavy matériel, but particularly tanks, self-propelled artillery, and other track-laying vehicles. They may be used to transport heavy engineer equipment when feasible. Evacuation units should be utilized to the maximum in carrying equipment and supplies forward at all times. If the situation requires it, separate evacuation companies may be attached to lower echelons, particularly armored divisions, where the distance from collecting points for recovered vehicles to division repair centers is beyond the reasonable operating radius of the organic evacuation vehicles.

c. Inspection.—In the normal course of resupply of tanks and other combat vehicles to units, it is essential that a final inspection service be performed at the point where these vehicles are removed from the transporters of the evacuation units and turned over to troop units. This service should be carried out by selected ordnance heavy maintenance companies (tank), preferably under a battalion commander, and such other personnel as is essential to check the vehicles in every way to see that they are completely ready for combat. The check will include mechanical condition, arms serviceability, stowage, items, ammunition, and, when applicable, food and water. Signal personnel should be available at this point to check radios.

d. Maintenance units.—(1) Medium maintenance units will be utilized by army (or corps) to reinforce divisional maintenance units. These medium maintenance units should be sufficiently close to the units being served to give close contact service, due consideration being given to such aspects of the position as terrain, road net, cover, and concealment. However, positions should not be so close to the front as to be within medium artillery range, or to be endangered by temporary fluctuations of the front elements.

(2) Heavy maintenance and depot companies should be sufficiently close to medium maintenance companies to give them the closest practicable support. However, they should not be so close to the front lines that their withdrawal, if necessary, would be impracticable considering their semimobile characteristics. Heavy maintenance and depot companies maintain an aggressive contact with the medium maintenance shops. However, heavy maintenance shops, once established, should remain

ORDNANCE SERVICE IN THE FIELD

in operation in the same locality as long as practicable without sacrificing service to lower echelons.

(3) When special combat troops such as antiaircraft battalions, tank-destroyer battalions, tank battalions, etc., are attached to army or subordinate commands, the appropriate type and number of maintenance units will normally be brought under army command at the same time, so as to preserve the proper ratio between combat and service units. These maintenance units will normally be assigned to appropriate ordnance battalion headquarters and headquarters detachments so that their special qualifications may be properly utilized.

(4) In general, maintenance companies should be "leap-frogged" as the using units move. This will enable each company to have as long a time as practicable to complete the work on hand. This may involve frequent regroupings among battalions. Maintenance units should be informed of the tactical situation at all times, so that close liaison may be maintained with units serviced, and appropriate defensive measures taken. Maintenance units should be disposed laterally and in depth so as to offer the best possible service to the combat troops.

(5) Administrative orders will normally announce assignments for service by battalions, leaving the further distribution of work and responsibility among the companies to the battalion commander. These orders must make clear the responsibility of the corps in case of interrupted communications, or other conditions.

[A. G. 300.7 (13 Aug 43).] (C 2, 17 Sep 43.)

■ 64. MISSION.—The mission of ordnance service in a corps acting alone is the same as in the army. When a corps is part of an army it operates, as far as practicable, as a purely tactical unit. The functions of supply and maintenance are normally performed by the army service troops.

[A. G. 300.7 (13 Aug 43).] (C 2, 17 Sep 43.)

■ 65. SCOPE OF ACTIVITIES OF CORPS ORDNANCE OFFICER.—The corps ordnance officer * * * within the corps. He supervises the execution of these plans when approved, and commands all ordnance facilities assigned or attached to the corps. His normal post * * * army ordnance officer.

[A. G. 300.7 (13 Aug 43).] (C 2, 17 Sep 43.)

■ 67. ORGANIZATION AND FACILITIES. Rescinded.

Figure 12 is rescinded and the following substituted therefor:

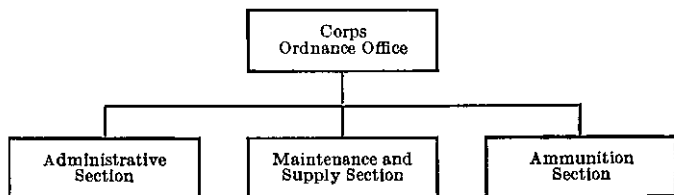

FIGURE 12.—Organization of corps ordnance office.

[A. G. 300.7 (13 Aug 43).] (C 2, 17 Sep 43.)

■ 68. CORPS ORDNANCE OFFICE.—The corps ordnance office may be divided into three principal sections: the ammunition section, the administrative section, and the maintenance and supply section.

a. Ammunition section.—The ammunition section is responsible for all administrative details pertaining to the ammunition supply plan of the corps as prescribed in FM 9-6. This includes the * * * and corps troops.

* * * * *

c. (Superseded.) Maintenance and supply section.—This section will normally prepare for the corps ordnance officer the ordnance plan for maintenance and supply within the corps, and prepare recommendations for submission to the army ordnance officer in the name of the corps ordnance officer, on the number, types and desired locations of army ordnance troops for ordnance service to the corps. This section will also maintain such records of, and prepare such reports on, the maintenance and supply status in the corps as may be required by the corps ordnance officer to keep that officer fully cognizant of the situation of these factors in the corps.

[A. G. 300.7 (13 Aug 43).] (C 2, 17 Sep 43.)

■ 69. (Superseded.) MAINTENANCE AND SUPPLY FACILITIES.—The corps ordnance officer, in coordination with the appropriate general and special staff officers, will submit to the army ordnance officer recommendations as to the number, types, and suggested locations of the necessary army ordnance troops to carry out the approved ordnance plan for the corps. These rec-

ORDNANCE SERVICE IN THE FIELD

ommendations are determined by the number and types of combat troops assigned to the corps, and by the tactical situation. The maintenance and supply organizations operating in the corps service area will keep the corps and army ordnance officers informed on the status of maintenance and general supply in the corps, will closely support the maintenance echelons of divisions and corps troops, and will maintain a sufficient stock level of spare parts and replacement items to provide the necessary continuity in the maintenance operations within the corps. (For details concerning maintenance and supply, see FM 9-10 and 9-25.)

[A. G. 300.7 (13 Aug 43).] (C 2, 17 Sep 43.)

■ 70. GENERAL SUPPLY. Rescinded.

[A. G. 300.7 (13 Aug 43).] (C 2, 17 Sep 43.)

■ 71. AMMUNITION SUPPLY. (Superseded.)—For the administrative procedure relative to ammunition supply, see FM 9-6.

[A. G. 300.7 (13 Aug 43).] (C 2, 17 Sep 43.)

■ 72. MISSION.—The mission of ordnance service in the division involves the handling of the administrative details pertaining to ammunition supply within the division, the supply and maintenance of ordnance matériel within the capabilities of the divisional ordnance troops, and the provision of liaison between the combat troops of the division and the facilities and agencies of the army ordnance service.

[A. G. 300.7 (13 Aug. 43).] C 2, 17 Sep 43.)

■ 73. SCOPE OF ACTIVITIES OF DIVISION ORDNANCE OFFICER (DOO).—The division ordnance * * * they are approved. He commands the division ordnance troops, but leaves to the unit commander the normal duties of administration and interior functioning. His normal post is at the forward command post of the division. The responsibilities and duties of the division ordnance officer correspond, with proper modifications, to those described in paragraph 60 for the army ordnance office. The division ordnance officer will usually find it of assistance in the efficient accomplishment of his mission to maintain an ordnance situation map or chart showing the distribution of

the facilities under his control and also the location of the troops being supported.

[A. G. 300.7 (13 Aug 43).] (C 2, 17 Sep 43.)

■ 75. ORGANIZATION AND FACILITIES (Superseded).—*a. General.*—Ordnance service within the division is furnished by the division ordnance section and division ordnance troops. A suggested organization of ordnance service in an infantry division is shown diagrammatically in figure 13. The ordnance organization in other types of divisions will be similar to that shown, the major difference being in the maintenance unit assigned.

b. Ordnance troops.—The ordnance troop units organically assigned to the various type divisions are discussed in paragraph 33a(1), C 1. These troops will perform such of the third echelon maintenance and supply functions for the division as are within their capabilities. They will be supported by medium and/or heavy army ordnance units.

c. Division ordnance section.—The headquarters office of the division ordnance officer is organized to assist that officer in his staff functions. It is located at the forward echelon of the division command post and may be subdivided into two coordinate elements: the maintenance and supply section, and the division ammunition office.

Figure 13 is rescinded and the following substituted therefor:

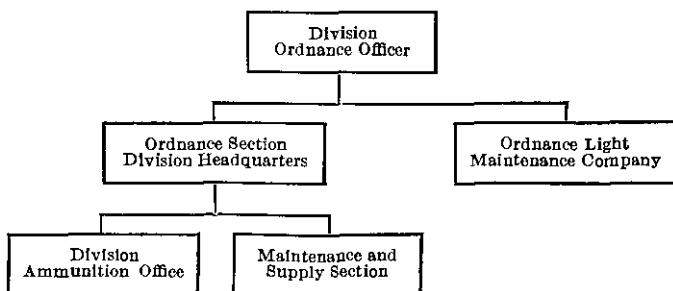

FIGURE 13.—Organization of ordnance service, infantry division.

[A. G. 300.7 (13 Aug 43).] (C 2, 17 Sep 43.)

(1) *Maintenance and Supply section.*—The function of this section is similar, with the necessary modifications, to those of

ORDNANCE SERVICE IN THE FIELD

the corresponding sections of the corps and army ordnance offices as described in paragraphs 62*b* (3) and 68*c* of this change.

(2) *Division ammunition office*.—For details pertaining to this office and the administrative details of ammunition supply, see FM 9-6.

[A. G. 300.7 (13 Aug 43).] (C 2, 17 Sep 43.)

- 76. AMMUNITION SUPPLY. Rescinded.
[A. G. 300.7 (13 Aug 43).] (C 2, 17 Sep 43.)
- 77. ALLOCATIONS OF CREDIT. Rescinded.
[A. G. 300.7 (13 Aug 43).] (C 2, 17 Sep 43.)
- 78. PROCUREMENT OF AMMUNITION BY COMBAT TROOPS. Rescinded.
[A. G. 300.7 (13 Aug 43).] (C 2, 17 Sep 43.)
- 80. DIVISION AMMUNITION OFFICE (DAO). Rescinded.
[A. G. 300.7 (13 Aug 43).] (C 2, 17 Sep 43.)
- 81. MAINTENANCE AND GENERAL SUPPLY. Rescinded.
[A. G. 300.7 (13 Aug 43).] (C 2, 17 Sep 43.)
- 82. MAINTENANCE OPERATIONS. Rescinded.
[A. G. 300.7 (13 Aug 43).] (C 2, 17 Sep 43.)
- 83. ORDNANCE SERVICE IN INFANTRY DIVISION (SQUARE). Rescinded.
[A. G. 300.7 (13 Aug 43).] (C 2, 17 Sep 43.)
- 84. REFERENCES. Rescinded.
[A. G. 300.7 (13 Aug 43).] (C 2, 17 Sep 43.)

ORDNANCE FIELD MANUAL

Figures 14 and 15 are rescinded and the following substituted therefor :

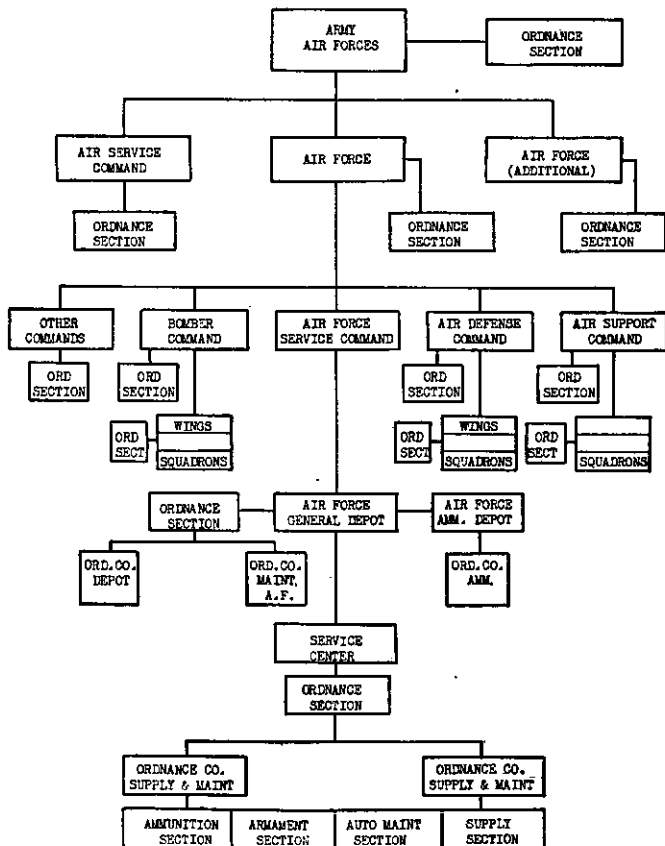

FIGURE 14.—Organization of ordnance service, Army Air Forces.
 [A. G. 300.7 (13 Aug 43).] (C 2, 17 Sep 43.)

ORDNANCE SERVICE IN THE FIELD

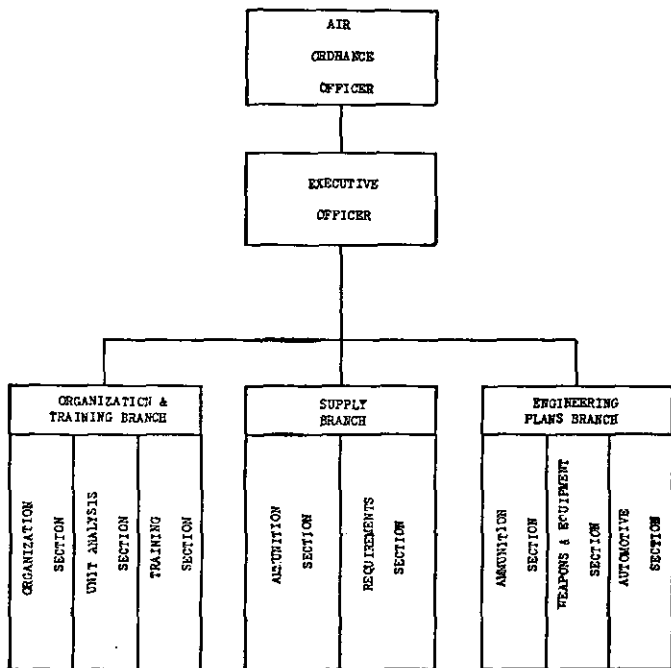

FIGURE 15.—Headquarters office, ordnance officer, Army Air Forces.
 [A. G. 300.7 (13 Aug 43).] (C 2, 17 Sep 43.)

■ 86. MISSION.—The mission of ordnance service in the Army Air Forces includes—

* * * *

d. Operation of air force ordnance depots and ordnance sections of air force depots, service centers or air bases, and ammunition distributing points.

* * * *

g. (Added.) Making or causing to be made the necessary inspections of ordnance activities throughout all echelons of the Army Air Forces.

h. (Added.) Collection, study, and distribution of information pertaining to enemy ordnance matériel, and recommendations concerning it.

i. (Added.) Supervision and coordination of all ordnance activities within the Army Air Forces.

NOTE. (Added.)—Service centers and air bases are analogous establishments. The service center is the theater of operations establishment which performs functions corresponding to those of the air base in the continental United States. Therefore, functions ascribed in this manual to service centers may also be ascribed to air bases.

[A. G. 300.7 (13 Aug 43).] (C 2, 17 Sep 43.)

■ 87. ORDNANCE SECTION, ARMY AIR FORCES. (Superseded.)—

a. General.—The air ordnance officer, headquarters, Army Air Forces, has the normal duties of a special staff officer. His duties require that he review and make recommendations to the Commanding General, Army Air Forces, on all matters pertaining to ordnance; act as advisor to the Air Staff on ordnance matters; and act as liaison between the Commanding Generals, Army Air Forces and Army Service Forces on all ordnance matters. He also acts as liaison agent between the Army Air Forces and the Bureau of Ordnance, Navy Department.

b. Headquarters office.—The office of the air ordnance officer, Army Air Forces, is divided into three sections as follows (see fig. 15) :

(1) *Supply division.*—The supply division is charged with—

(a) The supply and distribution of combat ammunition items to all subordinate headquarters, and the maintenance of the necessary records of requests for, and status of, ammunition items.

(b) Liaison between headquarters, Army Air Forces, and the Air Service Command concerning the status of credit and controlled items of equipment, materials, and supplies.

(c) Liaison between the director of military requirements and requirements division, Army Service Forces, for information and data necessary for computation of Army Air Forces requirements.

(2) *Organization and training division.*—This section is charged with—

(a) The study of recommended changes of all phases of aviation ordnance organization.

ORDNANCE SERVICE IN THE FIELD

(b) The responsibility for the preparation and coordination of training standards for ordnance units with the Army Air Forces.

(c) The collection and maintenance of information on the status of assigned ordnance troops as to units, strength, and state of training.

(d) The initiation of corrective action whenever the existing status of (c) above is determined to be unsatisfactory.

(3) *Engineering planning division.*—This section is charged with—

(a) The evaluation of plans concerning the development, to meet experimental and tactical requirements, of all ordnance matériel and ammunition employed by organizations of the Army Air Forces.

(b) The assembly of all data pertaining to the standardization of ordnance items peculiar to the Army Air Forces.

[A. G. 300.7 (13 Aug 43).] (C 2, 17 Sep 43.)

■ 88. **GENERAL SUPPLY** (Superseded.)—*a.* The supply of ordnance credit items other than those of exclusive interest to the Army Air Forces will be effected in the same manner as to the Army Service Forces and Army Ground Forces. All major items in stock at depots are available to meet requirements of units in the area supplied by the depot. The priority for supply will be the same as for the issue of controlled items. In order to provide a stockage of noncontrolled items for emergency issues, the commanding general, air service command, will maintain air embarkation stocks at certain localities within the Army Air Forces.

b. The supply of ordnance items of exclusive interest to the Army Air Forces such as aircraft weapons, pyrotechnic projectors, etc., are supplied within the continental United States and to oversea theaters in accordance with the policies established by the commanding general, air service command.

[A. G. 300.7 (13 Aug 43).] (C 2, 17 Sep 43.)

■ 89. **AMMUNITION SUPPLY.**—Control of ammunition service in the Army Air Forces is accomplished by means of a system of authorizations and reports of expenditure. (Ammunition re-

ferred to herein is defined as including all class V supplies.)
 There are two kinds of authorizations, as follows:

* * * * *

[A. G. 300.7 (13 Aug 43).] (C 2, 17 Sep 43.)

■ 90. ADMINISTRATIVE DETAILS OF AMMUNITION SUPPLY.—*a.*
Supply authorities.—The Army Air Forces issues supply authorities to the air force or command concerned for the ammunition to be made available to it in depots in the zone of the interior or elsewhere. The commanding general of the air force or air force command decides on the types of missions and the stock levels to be maintained in the air force depot, the air base RP's and airdrome DP's. He then issues * * * air force installations. (See fig. 16.)

* * * * *

[A. G. 300.7 (13 Aug 43).] (C 2, 17 Sep 43.)

ORDNANCE SERVICE IN THE FIELD

Figures 16, 17, 18, and 19 are rescinded and the following substituted therefor

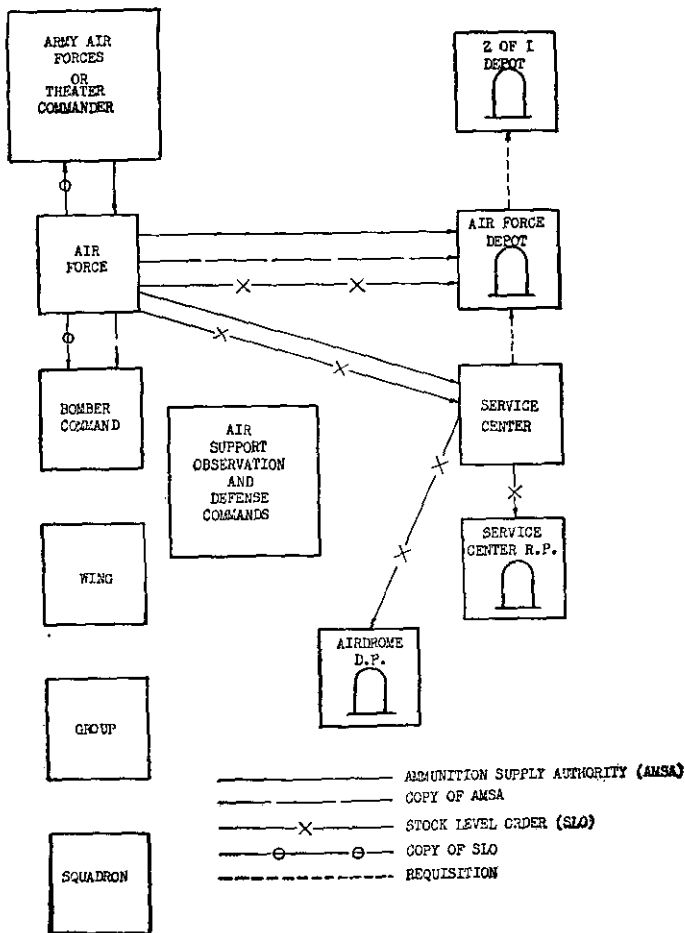

FIGURE 16.—Ammunition supply.

[A. G. 300.7 (13 Aug 43).] (C 2, 17 Sep 43.)

ORDNANCE FIELD MANUAL

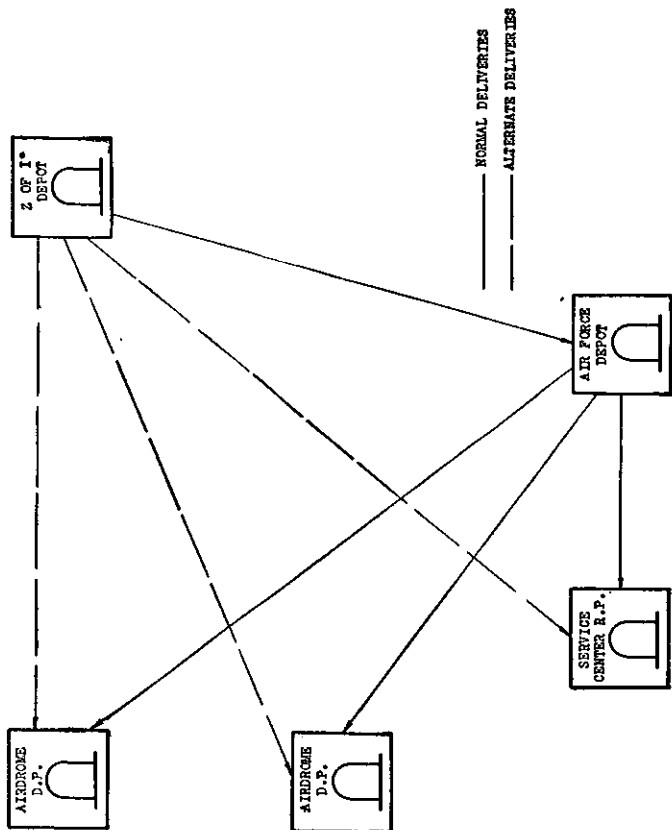

FIGURE 17.—Flow of ammunition.
 [A. G. 300.7 (13 Aug 43).] (C 2, 17 Sep 43.)

ORDNANCE SERVICE IN THE FIELD

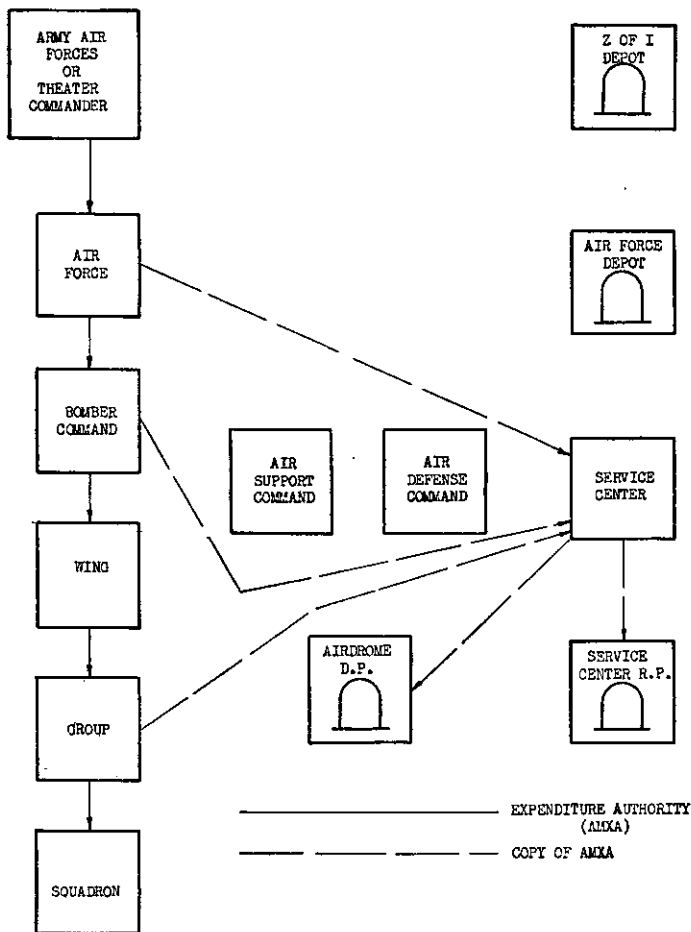

FIGURE 18.—Ammunition expenditure.
[A. G. 300.7 (13 Aug 43).] (C 2, 17 Sep 43.)

ORDNANCE FIELD MANUAL

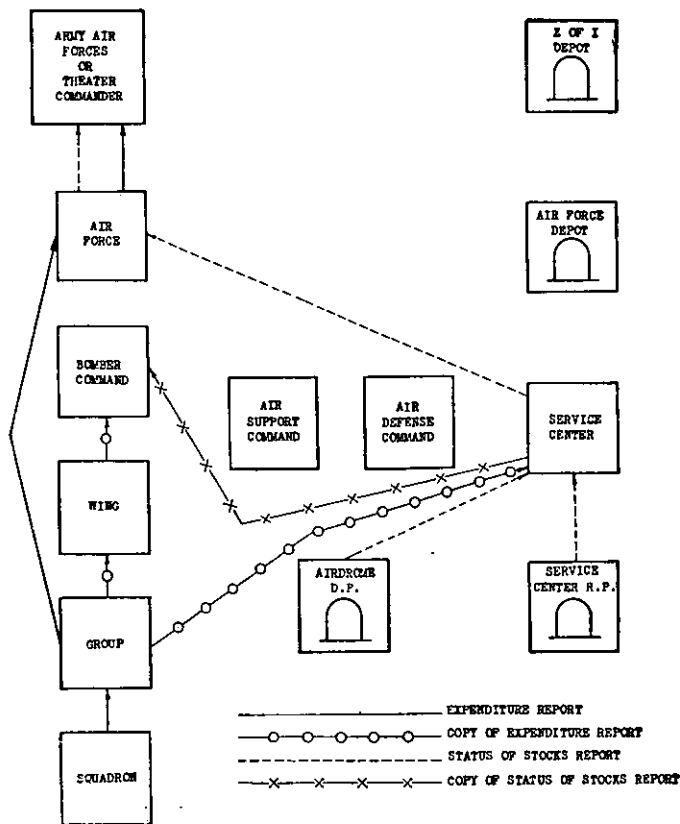

FIGURE 19.—Ammunition reports.

[A. G. 300.7 (13 Aug 43).] (C 2, 17 Sep 43.)

■ 91. MAINTENANCE.—The responsibility for maintenance and technical inspection of ordnance matériel in the Army Air Forces is delegated to the air forces and commands. The Army Air Forces, when required, arranges for evacuation of unserviceable matériel from the air forces and commands. (See sec. V, ch. 3, FM 1-195.)

[A. G. 300.7 (13 Aug 43).] (C 2, 17 Sep 43.)

ORDNANCE SERVICE IN THE FIELD

SECTION II (SUPERSEDED)

AIR SERVICE COMMAND

■ 92. GENERAL.—The air service command is the supporting maintenance and supply agency for the Army Air Forces. Its installations and facilities in the zone of the interior operate under the control of the Commanding General, Army Air Forces. In a theater of operations, these facilities operate under the control of the theater commander.

[A. G. 300.7 (13 Aug 43).] (C 2, 17 Sep 43.)

■ 93. ORGANIZATION.—*a. General.*—Due to differences in service functions required of task forces as against operations within the continental limits, it is necessary to establish two plans. Within the continental limits, service functions are increased to include the activation, organization, training, and equipping of service units (air depot groups and service groups) for assignment to task forces. (See fig. 19.1.) In the zone of the interior, more extensive permanent construction will be undertaken, and more elaborate facilities for supply and maintenance established than in a theater of operations. Responsibility for most service functions in the Army Air Forces at home rests with a command separate from the air forces, namely the air service command. In a task air force, service functions revert to the control of the air force commander. For a detailed discussion of the organization and functions of this command, see Army Air Forces Regulations 65-1.

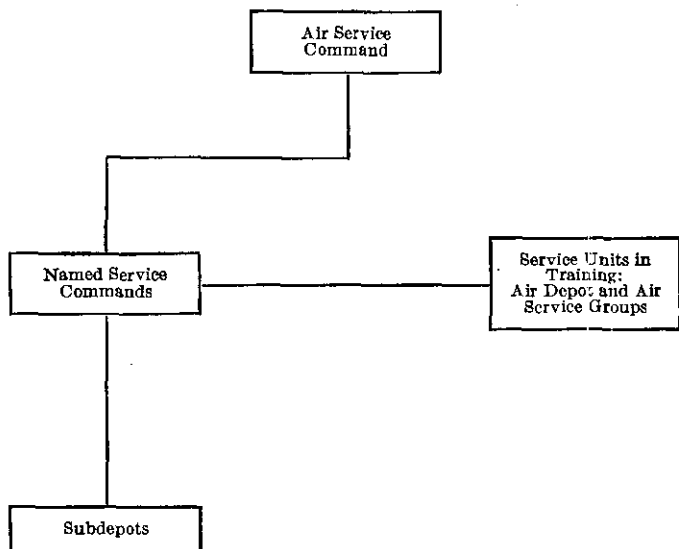

FIGURE 19.1.—Air Service Command.

[A. G. 300.7 (13 Aug 43).] (C 2, 17 Sep 43.)

b. In zone of interior (see fig. 19.1).—The air service command is organized in the United States into a headquarters and 11 named air service commands. These air service commands are named after the air depot, designated for a definitely prescribed geographical area, for example, Fairfield Air Service Command. They consist of the headquarters control air depot and its subordinate subdepots.

(1) *Control air depots* are the headquarters of the named air service commands. They are permanent in nature and perform major overhaul of aircraft for any air force units in the prescribed area.

(2) *Subdepots* are subordinate echelons of the named air service commands. They are located at air force stations within the area serviced by the particular air service command. They store, issue, and perform third echelon maintenance for all equipment which the Army Air Forces designs and procures.

c. In theater of operations.—(1) *General.*—Air service command units in a task air force are analogous to those found in

ORDNANCE SERVICE IN THE FIELD

the United States. In the theater, these units operate under the control of the air force commander.

(2) *Air force service command headquarters.*—There is assigned to each air force in a theater of operations, an air force service command, for example, XII Air Force Service Command. The headquarters of this command is operated by the headquarters and headquarters squadron, air service command (task force) (T/O 1-400-2S). This organization is analogous to the headquarters of the air service command in the United States.

(3) *Air force general depot.*—This is the theater installation analogous to the air depot in the United States. One or more air force general depots are established for each air force. They are established and operated by mobile air depot groups.

(4) *Air force ammunition depot.*—This is a theater of operations installation and is operated by the ordnance ammunition company (T/O 9-17). It supplies bombs and other ammunition direct to the squadron distributing points and/or service center refilling points. The transportation of ammunition is a function of the Quartermaster Corps. The number and size of ammunition depots will depend on the size of the air force and upon the character of operations.

(5) *Service center.*—The service center is analogous to sub-depots or air bases in the United States. They are manned by service groups (one service group per service center), and furnish service for two combat, or tactical, groups. (See pars. 100 to 104, incl.)

[A. G. 300.7 (13 Aug 43).] (C 2, 17 Sep 43.)

■ 94. **FUNCTIONS.**—The Air Service Command operates as a supporting maintenance and supply agency for the several air forces. It receives newly procured equipment from manufacturing sources in the zone of the interior, and stores and issues such equipment to the air forces as required. It receives for repair, from field units and other sources, damaged equipment and such repair work as is beyond the facilities of the air forces or separate commands. (See par. 98.)

[A. G. 300.7 (13 Aug 43).] (C 2, 17 Sep 43.)

■ 95. **ORGANIZATION OF ORDNANCE SERVICE IN AIR SERVICE COMMAND.**—The organization of the ordnance service in the air service command includes:

a. The ordnance section of the staff of the commanding general, air service command, and of the commanders of the named air service commands.

b. One aviation company (service) consisting of a small section of approximately six men for each of the air depots. The company commander is located at the headquarters of the air service command.

c. There is no ordnance personnel at any of the subdepots. Repairs to ordnance matériel at subdepots are normally made by ordnance tactical organizations which are organic in the air force squadrons at the station.

[A. G. 300.7 (13 Aug 43).] (C 2, 17 Sep 43.)

■ 96. FUNCTIONS OF ORDNANCE SERVICE IN AIR SERVICE COMMAND.—*a. Responsibilities of ordnance officer, air service command.*—In addition to the usual responsibilities and duties of an ordnance staff officer, the ordnance officer, air service command, is responsible for—

(1) Supply of aircraft machine guns and cannon for initial equipment of new airplanes.

(2) Supply of aircraft machine guns and cannon to air depots.

(3) Supply of ammunition, including pyrotechnics, at air depots.

(4) Supervision of credits set up by the Commanding General, Army Air Forces, for noncontrolled items of supplies which pertain to aircraft armament in the various depots of the Ordnance Department in the United States.

b. Functions of ordnance troops in air service command depots.—(1) *Air depots.*—Ordnance troops at air depots are responsible for the receipt, storage, and issue of ordnance matériel and the accomplishment of some minor repairs. Since fixed depots are located only in the United States, complete overhaul can be performed at regular ordnance arsenals and similar installations.

(2) *Mobile air depots.*—Ordnance troops at mobile air depots are responsible for the complete overhaul of ordnance equipment installed on airplanes which are sent to the depot for overhaul. In addition, these depots have responsibility for the receipt, storage, and issue of ordnance matériel.

[A. G. 300.7 (13 Aug 43).] (C 2, 17 Sep 43.)

ORDNANCE SERVICE IN THE FIELD

SECTION III (SUPERSEDED)

IN AN AIR FORCE

■ 97. GENERAL.—The ordnance officer of an air force is charged with the normal duties of a special staff officer. He operates under the technical supervision of the theater ordnance officer. He coordinates ordnance service in the air force service command, bomber command, air defense command, and air support command. When only one air force is operating in a theater, the air force headquarters will function as the air office of the headquarters of the theater commander.

[A. G. 300.7 (13 Aug 43).] (C 2, 17 Sep 43.)

■ 98. ORDNANCE SERVICE IN TASK AIR FORCE.—*a. General.*—There is an ordnance officer on the special staff of the commanding general of a task air force, and on the special staffs of each of the commands under his jurisdiction. The detailed control and operation of ordnance service activities of the task air force is the responsibility of the ordnance officer of the air force service command. This officer has an adequate ordnance section for the maintenance of the necessary control and supervision of ordnance service activities in the air force. The strength and composition of the assigned ordnance troops depend on the following factors:

- (1) Strength and composition of combat units.
- (2) Location of theater and nature of terrain.
- (3) Availability of local supplies and ground force supply points.
- (4) Number and condition of airdromes.
- (5) Probable nature of operations.

b. Ordnance troops.—Ordnance troops in an air force are—

- (1) One or more ordnance depot companies (T/O 9-57) for the operation of the ordnance section of the air force general depot.
- (2) One or more ordnance ammunition companies (T/O 9-17) for the operation of the air force ammunition depot.
- (3) One or more ordnance maintenance companies, air force (T/O 9-257) for fourth echelon maintenance of all ordnance equipment used by the air force.

ORDNANCE FIELD MANUAL

(4) One or more service center ordnance organizations. (See par. 102.)

c. Supply.—(1) *General.*—Credit items of general supply allocated to the air force are controlled by reallocation to service groups. A complete record of the status of credit and controlled items in all echelons of the air force is maintained by the ordnance section, air force service command.

(2) *Ammunition.*—Ammunition is controlled as outlined in paragraph 89. Complete records of the status of ammunition in all echelons of the air force are maintained by the ordnance section, air force service command. For a complete discussion of ammunition supply in the Army Air Forces, see FM 9-6.

d. Maintenance.—Ordnance maintenance in the air force service command is performed by the ordnance supply and maintenance company, aviation (T/O 9-417). It provides technical information and guidance on maintenance matters to all echelons of the air force. It maintains required records on maintenance and inspection in the air force. The ordnance maintenance company, air force (T/O 9-257), provides the maintenance facilities for work which cannot be accomplished within the service centers. Arrangements are made for the evacuation of ordnance matériel from the air force area to army base installations for fifth echelon maintenance work.

[A. G. 300.7 (13 Aug 43).] (C 2, 17 Sep 43.)

■ 99. **ORDNANCE SERVICE IN BOMBER, AIR DEFENSE, AND AIR SUPPORT COMMANDS.**—The ordnance officer of these commands has the normal duties of a special staff officer, with the exception of the control and supervision of supply and maintenance. The technical phases of these staff duties are particularly important. There is an ordnance section in the headquarters of each of these commands. The ordnance troop units serving these commands are an integral part of, and operate directly under the tactical (flying) organizations. (See par. 105.)

[A. G. 300.7 (13 Aug 43).] (C 2, 17 Sep 43.)

ORDNANCE SERVICE IN THE FIELD

SECTION IV (SUPERSEDED)

IN A SERVICE CENTER

■ 100. **DEFINITION.**—A service center is an intermediate supply point between the air force depots and dispersed squadron airdromes. It controls the flow of all classes of supplies forward to squadrons. It is the theater of operations substitute for the permanent base in the continental United States. A service center is normally established to provide service for two combat groups. It is manned by a service group and allied organizations and should be close enough to the supported elements to permit truck delivery of supplies within a turn-around time of less than 8 hours. The service center provides third echelon maintenance service.

[A. G. 300.7 (13 Aug 43).] (C 2, 17 Sep 43.)

■ 101. **GENERAL.**—Ordnance service in the service center comprises—

a. Supply of ordnance matériel to the units of the air force within the service center area.

b. Third echelon ordnance maintenance and evacuation.

c. Supply of completely assembled bombs, pyrotechnics, and belted aircraft ammunition to ordnance sections of combat organizations, and if such sections are not available, to the combat airplanes themselves. This supply is effected at any time as required by the combat unit.

[A. G. 300.7 (13 Aug 43).] (C 2, 17 Sep 43.)

■ 102. **ORDNANCE TROOPS.**—*a. General.*—To provide the prescribed ordnance service, ordnance troops are furnished to the service center commander as follows:

(1) Ordnance section, headquarters and headquarters squadron, service group (T/O 1-412)—one per service center.

(2) Ordnance supply and maintenance company, aviation (T/O 9-417)—one per service squadron.

b. Operations.—(1) The ordnance section, headquarters, and headquarters squadron, service group, is the special staff section for the service group commander. The senior ordnance officer in this section is the service center ordnance officer. In addition to his duties as a special staff officer, he is directly

responsible for the training and operation of the ordnance supply and maintenance companies in the service center area. He is likewise charged with the supervision of the ordnance sections of all airdrome squadrons within the service center area. He is responsible for maintaining the prescribed stock levels of ammunition and supplies.

(2) For a description of the operation of the ordnance supply and maintenance company, aviation, see paragraph 40a.

[A. G. 300.7 (13 Aug 43).] (C 2, 17 Sep 43.)

■ 103. SUPPLY.—*a. General supply.*—A service center refilling point for ordnance general supplies is established to supply dispersed airdromes and units at the service center. Service is direct to each unit airdrome in the area being serviced. Requisitions and requests for service go direct from each squadron airdrome to the service center, except when the squadron is drawing supplies direct from a ground force establishment. The service center controls the flow of all supplies from the air force depots to the combat units.

b. Ammunition supply.—A service center refilling point for ammunition is established in the same manner as for ordnance general supplies. However, deliveries are normally made direct from the air force ammunition depot to squadron airdromes, the service center refilling point being maintained in cases of temporary break-down in this service. The ordnance section, headquarters, and headquarters squadron, service group, maintains a complete record of the status of ammunition in the service center area.

[A. G. 300.7 (13 Aug 43).] (C 2, 17 Sep 43.)

■ 104. MAINTENANCE.—All third echelon ordnance maintenance within the service center is performed by the ordnance supply and maintenance companies, aviation (T/O 9-417). Inspections of ordnance matériel are made as directed by the service center commander or higher authority. The ordnance section, headquarters and headquarters squadron, service group, maintains complete records of the status of maintenance and inspection in the service center.

[A. G. 300.7 (13 Aug 43).] (C 2, 17 Sep 43.)

ORDNANCE SERVICE IN THE FIELD

SECTION V (SUPERSEDED)

AT A DISPERSED AIRDROME

■ 105. GENERAL.—The organization of an ordnance section with a tactical (flying) squadron, such as bombardment, observation, and fighter, provides direct ordnance service to a combat unit at a dispersed airdrome. The service establishment at such a dispersed airdrome is known as the airdrome distributing point. The distributing point operates directly under the control of the squadron airdrome commander. The functions of these ordnance sections are—

a. Maintain all necessary records and prepare all necessary reports and requisitions pertaining to ordnance.

b. Supervise the establishment and operation of the squadron ammunition storage area and ordnance maintenance facilities of the squadron.

c. Direct delivery of ammunition and bombs, completely ready for use, to the airplanes of the squadron, when and where needed.

d. Direct the performance of second echelon maintenance of ordnance equipment of the squadron.

e. The commander of the ordnance section is also the squadron ordnance officer. As such he is responsible for the operation of the section. His duties and responsibilities include—

(1) Furnishing the squadron commander with technical advice on all matters pertaining to ordnance.

(2) Supervision of the operations and training of the personnel of the ordnance section of the squadron.

(3) Working in close cooperation with the armament and operations officer of the squadron in order to prepare in advance the necessary ordnance plans for contemplated operations.

(4) Under combat conditions, keeping all interested agencies fully cognizant of the squadron ammunition situation.

(5) Investigation and recommendations concerning the use and operation of ordnance matériel.

(6) Making frequent aerial flights to observe the function of ordnance matériel under actual or simulated combat conditions.

[A. G. 300.7 (13 Aug 43).] (C 2, 17 Sep 43.)

■ 106. SUPPLY.—*a. General supply.*—The ordnance spare parts set for an ordnance section is established for the organization by Standard Nomenclature Lists. This set is normally carried on the emergency repair truck of the ordnance section. It is replenished from the service center refilling point. Complete records on the status of ordnance general supplies at the airdrome are maintained by the ordnance section.

b. Ammunition supply.—An ammunition distributing point is established to provide ammunition for the combat squadrons and other troops at the dispersed airdrome. Normally deliveries are made directly from the air force ammunition depot to squadron airdromes, depending on the local conditions and routes of communication. A complete record of the status of ammunition at the distributing point is maintained by the ordnance section of the airdrome squadron.

[A. G. 300.7 (13 Aug 43).] (C 2, 17 Sep 43.)

ORDNANCE SERVICE IN THE FIELD

APPENDIX III (SUPERSEDED)

ORDNANCE TROOP ASSIGNMENTS

NOTE.—The Tables of Organization of the various headquarters and organizations are subject to change. The sources and dates of the information contained in this appendix are given wherever possible. For the latest information on the assignment of ordnance troops, the latest revision of the pertinent Tables of Organization should be consulted.

Organization	T/O	Ordnance service	T/O
AAF headquarters and headquarters squadron, Army Air Forces.	None.....	Ordnance section, 12 officers, 1 warrant officer	T/O
AAF headquarters and headquarters squadron, air depot control area command.	None.....	Ordnance section, 13 officers, 1 warrant officer	-----
AAF headquarters and headquarters squadron, air service command.	None.....	Ordnance section, 56 officers, 3 warrant officers	-----
AAF headquarters and headquarters squadron, fighter command (special).	M/T tent. 2-23-43.....	Ordnance section, 2 officers, 6 enlisted men	-----
AAF headquarters and headquarters squadron, air force service command.	M/T tent. 1-17-43.....	Ordnance section, 5 officers, 1 warrant officer, 15 enlisted men.	-----
AAF headquarters and headquarters squadron, matériel command.	T/O tent. 3-15-42.....	Ordnance section, 37 officers	-----
AAF headquarters and headquarters squadron, air force service command (foreign).	T/O tent. 6-30-42.....	Ordnance section, 5 officers, 1 warrant officer, 15 enlisted men.	-----
AAF headquarters and headquarters squadron, air force.	T/T tent. 2-23-43.....	Ordnance section, 3 officers, 1 warrant officer, 10 enlisted men.	-----
AAF headquarters and headquarters squadron, fighter command (special).	1-1-18.....	Ordnance section, 2 officers, 8 enlisted men	-----

ORDNANCE FIELD MANUAL

Organization	T/O	Ordnance service	T/O
AAF headquarters and headquarters squadron, fighter wing (special).	1-10-18, 9-26-42	Ordnance section, 1 officer, 2 enlisted men.	
AAF fighter squadron, single-engine.	1-27, C2 1-25-43.	Ordnance section, 1 officer 15 enlisted men.	
AAF fighter squadron, two-engine.	1-37, C1 1-25-43.	Ordnance section, 1 officer 15 enlisted men.	
AAF headquarters and headquarters squadron, fighter command (special).	1-50-18, 2-22-43.	Ordnance section, 2 officers, 7 enlisted men.	
AAF night fighter squadron.	1-67, C1 1-25-43.	Ordnance section, 1 officer, 11 enlisted men.	
AAF headquarters and headquarters squadron, bomber command.	1-100-1, 2-15-43.	Ordnance section, 2 officers, 6 enlisted men.	
AAF headquarters and headquarters squadron, bomber command (special).	1-100-18, 1-1-42.	Ordnance section, 5 officers, 23 enlisted men.	
AAF headquarters and headquarters squadron, bomber command (special).	1-100-18-2, 2-15-43.	Ordnance section, 2 officers, 5 enlisted men.	
AAF headquarters and headquarters squadron, bomber command (special).	1-110-1, 11-21-42.	Ordnance section, 2 officers, 7 enlisted men.	
AAF bombardment squadron, heavy.	1-117, 3-28-43.	Ordnance section, 1 officer, 29 enlisted men.	
AAF bombardment squadron, medium.	1-127, C2 1-25-43.	Ordnance section, 1 officer, 20 enlisted men.	
AAF headquarters and headquarters squadron, bomber wing (light or dive).	1-130-1, C1 3-8-43.	Ordnance section, 2 officers, 6 enlisted men.	
AAF bombardment squadron, light.	1-137, C2 1-25-43.	Ordnance section, 1 officer, 18 enlisted men.	
AAF bombardment squadron, dive.	1-147, C2 1-25-43.	Ordnance section, 1 officer, 27 enlisted men.	
Air Corps headquarters and headquarters squadron, interceptor command.	1-200-1, 7-1-41.	Ordnance section, 1 officer, 2 enlisted men.	
AAF headquarters and headquarters squadron, fighter command (special).	1-200-18, 7-1-42.	Ordnance section, 1 officer, 2 enlisted men.	
AAF observation squadron.	1-287, C2 2-23-43.	Ordnance section, 1 officer, 17 enlisted men.	

ORDNANCE SERVICE IN THE FIELD

AAF headquarters and headquarters squadron, troop carrier command.	1-800-1, 1-12-43.	Ordnance section, 3 officers, 5 enlisted men.
AAF headquarters and headquarters squadron, troop carrier wing.	1-810-1, 2-15-43.	Ordnance section, 1 officer, 2 enlisted men.
AAF headquarters, troop carrier group.	1-812, 2-15-43.	Ordnance section, 1 officer.
AAF headquarters and headquarters squadron, air force service command (special).	1-400-1S, 7-13-42.	Ordnance section, 5 officers, 1 warrant officer, 18 enlisted men.
AAF headquarters and headquarters squadron, air force service command (special).	1-400-2S, 9-1-42.	Ordnance section, 4 officers, 1 warrant officer, 18 enlisted men.
AAF headquarters and headquarters squadron, service group.	1-412, C1 10-23-42.	Ordnance section, 2 officers, 5 enlisted men.
AAF base headquarters and air base squadron.	1-422, C2 1-25-43.	Ordnance section, 2 officers, 24 enlisted men.
AAF airdrome squadron (special).	1-487S, C1 1-25-43.	Ordnance section, 1 officer, 31 enlisted men.
AAF headquarters and headquarters squadron, air support command.	1-500-1, C1 1-25-43.	Ordnance section, 2 officers, 5 enlisted men.
AAF headquarters and headquarters squadron, air defense wing.	1-550-1, C1 1-25-43.	Ordnance section, 4 officers, 12 enlisted men.
AAF headquarters and headquarters squadron, ferrying wing.	1-650-1, C1 9-1-42.	Ordnance section, 2 officers, 4 enlisted men.
AAF headquarters and headquarters squadron, island air command (special).	1-690-1S, 7-1-42.	Ordnance section, 1 officer, 5 enlisted men.
Air Corps headquarters and headquarters squadron, technical training command.	1-700-1, 7-16-41.	Ordnance section, 1 officer, 1 enlisted man.
Air Corps headquarters and headquarters squadron, technical training command district.	1-750-1, 3-4-42.	Ordnance section, 1 officer, 2 enlisted men.
AAF photographic squadron, light.	1-757, C3 3-5-43.	Ordnance section, 2 enlisted men.
AAF photographic squadron, mapping.	1-758, C1 11-21-42.	Ordnance section, 2 enlisted men.
AAF headquarters and headquarters squadron, air force.	1-800-1, C1 2-15-43.	Ordnance section, 7 officers, 1 warrant officer, 21 enlisted men.
AAF headquarters and headquarters squadron, air force (special).	1-800-1S, 5-5-42.	Ordnance section, 4 officers, 1 warrant officer, 12 enlisted men.

ORDNANCE FIELD MANUAL

Organization	T/O	Ordnance service	T/O
AAF headquarters and headquarters squadron, air force (special) (RS).	1-800-1S-RS, C12-1-43	Ordnance section, 2 officers, 7 enlisted men.	-----
AAF headquarters and headquarters squadron, air force (special).	1-800-1S-2T, 8-15-42	Ordnance section, 2 officers, 1 warrant officer, 10 enlisted men.	-----
AAF headquarters and headquarters squadron, air force composite command.	1-801-1, 7-1-42	Ordnance section, 5 officers, 1 warrant officer, 12 enlisted men.	-----
AAF headquarters and headquarters squadron, air depot group.	1-852, 7-1-42	Ordnance section, 2 officers, 19 enlisted men	-----
AAF headquarters and headquarters squadron, proving ground command (proof dept.)	M/T 1-893T, C19-25-42.	Ordnance section, 2 officers	-----
AAF headquarters and headquarters squadron, antisubmarine command.	1-1000-1, 11-1-42	Ordnance section, 3 officers, 1 warrant officer, 19 enlisted men.	-----
AAF headquarters and headquarters squadron, antisubmarine wing.	1-1010-1, 11-1-42	Ordnance section, 2 officers, 1 warrant officer, 11 enlisted men.	-----
AAF headquarters and headquarters squadron, air service department, AAFSA T.	T/D 1-1352-4, 11-1-42	Ordnance section, 4 officers, 1 warrant officer, 18 enlisted men.	-----
AAF headquarters and headquarters squadron, A T C, ferrying division.	M/T 1-3555, 11-1-42	Ordnance section, 1 officer, 2 enlisted men.	-----
AAF headquarters and headquarters squadron, transport command.	1-3600-1, 1-23-43	Ordnance section, 3 officers, 3 enlisted men.	-----
AAF headquarters and headquarters squadron, proving ground command.	M/T 1-3800-1, 11-1-42	Ordnance section, 7 officers, 1 enlisted man.	-----
AAF reconnaissance squadron, fighter combat.	P A T 114, 1-25-43	Ordnance section, 1 officer, 17 enlisted men.	-----
AAF reconnaissance squadron, bombardment combat.	P A T 114, 1-25-43	Ordnance section, 1 officer, 20 enlisted men.	-----
AAF bombardment group (H, M, D) headquarters combat.	P A T 117, 1-30-43	Ordnance section, 1 officer, 2 enlisted men.	-----

ORDNANCE SERVICE IN THE FIELD

AAF headquarters and headquarters squadron (special) air service area command (foreign).	PAT 121, 2-22-43	Ordnance section, 2 officers, 9 enlisted men.	9-17
AAF headquarters and headquarters squadron, air support department, AAFSAT.	PAT 132, 3-16-43	Ordnance section, 1 officer, 3 enlisted men.	9-57
Air force service command, desert training center.	PAT 133, 3-17-43	Ordnance section, 1 officer, 2 enlisted men.	9-257
AAF reconnaissance squadron fighter combat.	PAT 144, 3-29-43	Ordnance section, 1 officer, 15 enlisted men.	0-417
AAF reconnaissance squadron, bombardment com- bat.	PAT 144, 3-29-43	Ordnance section, 1 officer, 20 enlisted men.	9-87
AAF headquarters and headquarters squadron, air force.	PAT 139, 3-30-43	Ordnance section, 6 officers, 18 enlisted men.	9-7
AAF headquarters and headquarters squadron, air force service command.	PAT 144, 3-25-43	Ordnance section, 3 officers, 1 warrant officer, 14 enlisted men.	9-65
Task air force.		Ammunition company (one or more)	9-66
		Depot company (one or more)	9-67
		Maintenance company (air force) (one or more).	9-67
		Supply and maintenance company (one per service squadron, in service group).	9-87
Airborne division.	71, 10-15-42	Ordnance maintenance company, airborne division.	9-7
Cavalry division.	2, 8-1-42	Ordnance medium maintenance company.	9-7
Cavalry division, headquarters.	2-1, 8-1-42	Ordnance section.	9-8
Coast Artillery headquarters coastal frontier.	4-222, 11-1-40	Ordnance light maintenance company.	9-137
Infantry division.	7, 8-1-42	Ordnance maintenance company, mountain division.	9-65
Mountain division.	70, 8-1-42	Ordnance section.	9-66
Port headquarters.	10-260-1, 11-1-40	Ordnance battalion, armored division.	9-67
Armored division.	17	1—headquarters and headquarters company, maintenance battalion, armored division. 3—maintenance companies, maintenance bat- talion, armored division.	9-67

ORDNANCE SERVICE IN THE FIELD

Organization	T/O	Ordnance service	T/O
Armored corps headquarters.....	170-1, 11-15-40.....	Ordnance section.....	
Corps headquarters.....	100-1, 3-29-43.....	Ordnance section.....	
Army headquarters.....	200-1, 7-1-42.....	Ordnance section (ordnance troop units listed below under theater reserve assigned as required.)	
Theater reserve troops.....		Medium maintenance company.....	9-7
		Heavy maintenance company, field army.....	9-9
		Ammunition battalion.....	9-15
		Ammunition company.....	9-17
		Heavy maintenance company (tank).....	9-37
		Depot company.....	9-57
		Headquarters and headquarters detachment, ordnance battalion.....	9-76
		Medium automotive maintenance company.....	9-127
		Heavy automotive maintenance company.....	9-197
		Antiaircraft maintenance company.....	9-217
		Headquarters and headquarters detachment, ordnance base group.....	9-312
		Base armament maintenance battalion.....	9-315
		Headquarters and service company, base armament maintenance battalion.....	9-316
		Base armored vehicle maintenance company.....	9-317
		Base artillery and fire control maintenance company.....	9-318
		Base small arms maintenance company.....	9-319
		Base automotive maintenance battalion.....	9-325
		Base automotive maintenance company (engine rebuild).....	9-327
Communications zone only.....			

Base automotive maintenance company (power train rebuild).	9-328
Motor vehicle distributing company.....	9-337
Tire repair company.....	9-347
Motor vehicle assembly company (portable).....	9-348
Base depot company.....	9-377

[A. G. 300.7 (13 Aug 43).] (C 2, 17 Sep 43.)

BY ORDER OF THE SECRETARY OF WAR:

OFFICIAL:

J. A. ULIO,

*Major General,
The Adjutant General.*

G. C. MARSHALL,
Chief of Staff.

BASIC FIELD MANUAL
ORDNANCE SERVICE IN THE FIELD

CHANGES } WAR DEPARTMENT,
No. 1 } WASHINGTON 25, D. C., 21 August 1943.

FM 9-5, 11 July 1942, is changed as follows:

■ 2. ORGANIZATION OF ORDNANCE SERVICE.

* * * * *

b. Geographical organization of the Army.—There are two * * * of the interior. *The theater of war* comprises those areas of land, air, and sea which are or may become involved directly in the operations of war. *The zone of* * * * the combatant forces.

c. Tactical organization of the Army.—The tactical organization of the Army consists of the Army Ground Forces, the Army Air Forces, the Army Service Forces, and the theaters of operations.

[A. G. 300.7 (7 May 43).] (C 1, 21 Aug 43.)

■ 3. ORDNANCE SERVICE IN THE ZONE OF THE INTERIOR.

* * * * *

b. Facilities.—The ordnance facilities available for the accomplishment of the ordnance service mission within the zone of the interior in the United States only, comprise those establishments under the direct control of the Chief of Ordnance together with agencies under the immediate supervision of service command ordnance officers, and those ordnance organizations which are assigned, or attached to, or organic with, a tactical unit. The major ordnance * * * of such commands. In technical matters, however, they operate in close cooperation with the respective service command ordnance officers, who are representatives of the service command commander are responsible for the coordination of all ordnance service in the service command.

[A. G. 300.7 (7 May 43).] (C 1, 21 Aug 43.)

■ 4. ORDNANCE STAFF OFFICERS.—*a. Organization of staff.*—The existence of * * * special staff constituted. The ordnance officer communicates directly with each general staff member on matters pertaining to their functions, that is, with G-1 on personnel matters, with G-2 on matters dealing with ordnance

intelligence and captured matériel, with G-3 on training and such aspects of operations as affect ordnance functions, and with G-4 on matters of supply and evacuation requiring coordination for inclusion in administrative orders. For complete information * * * FM 100-5, 100-10, and 101-5.

* * * * *

[A. G. 300.7 (7 May 43).] (C 1, 21 Aug 43.)

■ 5. MISCELLANEOUS DUTIES AND RESPONSIBILITIES.

* * * * *

d. Technical functions.—Ordnance staff officers * * * ordnance major items. They should also be conversant with serviceability requirements for ammunition, disposal, or demolition of duds or other unserviceable ammunition, and the provisions of TM 9-1900, 9-981, and 9-1980. They should be * * * is employed tactically.

* * * * *

[A. G. 300.7 (7 May 43).] (C 1, 21 Aug 43.)

■ 15. CLASSIFICATION OF SUPPLIES.—*a. Classes of supplies.*—All supplies issued * * * by FM 100-10. (For classification of supplies in the Army Air Forces, see Army Air Forces Regulation 65-1.) These classes, which * * * are as follows:

* * * * *

(2) *Class II.*—Those authorized supplies for which allowances are established by Tables of Equipment (or Tables of Basic Allowances), and Tables of Allowances, such as clothing, gas masks, arms, automotive vehicles, radio sets, tools, and instruments. (The Army Air Forces except airplane equipment and automotive vehicles from this class. See (4) below.)

* * * * *

(4) *Class IV.*—Those articles of supplies which are not covered in Tables of Equipment and demands for which are directly related to operations contemplated or in progress (except for articles in classes III and V), such as fortification materials, construction materials, and machinery. (The Army Air Forces includes in this class automotive vehicles, complete airplanes, airplane equipment, and all spare parts and supplies required to maintain the complete airplane in commission.)

* * * * *

[A. G. 300.7 (7 May 43).] (C 1, 21 Aug 43.)

■ 18. ORDNANCE GENERAL SUPPLIES (fig. 2).—*a. General.*—
 Ordnance general supplies * * * channel of supply.

* * * * *

b. (Added.) Supply procedure in theater of operations.—(1) *Stock level orders.*—In an active theater of operations, supply depots both in the communications zone and the combat zone should be so organized as to directly support the next foremost depot and finally the troops in the combat zone. To effect this with a minimum of confusion and delay, each depot should be given a prescribed minimum and maximum stock level, and a credit on one or more depots in the rear. This will result in all depots, with the exception of those at the port of debarkation, having a definite level of stocks on hand at all times. The depots at the port of debarkation should likewise be given instructions to maintain certain levels of stock by submitting requisitions for their requirements to the port of embarkation in the United States. (See par. 63*b* for details of the supply system in army depots.)

(2) *Reports.*—The efficient functioning of this method of supply will eliminate the need for periodic reports on the status of stocks, since compliance with instructions will require the maintenance of a known status in all echelons, except for depots at the port of debarkation. These depots will submit general reports to the central headquarters on the status of supply as a whole and the status of shipments of supplies from the zone of the interior to the theater. The central office will not submit requisitions to the ports of embarkation, but may submit general reports asking that supplies be expedited on requisitions already submitted, or giving other information required for planning purposes.

(3) *Controlled items.*—In the event that a shortage of certain items exists, and it is impossible to comply with published instructions on the maintenance of stock levels, a letter report will be submitted to the ordnance officer of the echelon concerned, giving this information. If the supply situation of these items is sufficiently critical, the theater ordnance officer may designate them as "controlled items," and thereafter he will issue credits for these items or other instructions stating when and where they will be issued. Any item may be controlled, that is, major item, spare part, or a supply item. This procedure will enable the central headquarters to maintain control over the distribution

of these critical items and insure their use where they are needed most.

[A. G. 300.7 (7 May 43).] (C 1, 21 Aug 43.)

■ 19. DEFINITIONS OF AMMUNITION TERMS.

* * * * *

b. Groups of ammunition.

* * * * *

(4) *Chemical ammunition* (Superseded).—(a) The Ordnance Department procures, stores, and distributes to the using arms, artillery and mortar chemical shells and aerial bombs loaded with chemical fillers. All other chemical ammunition is procured, stored, and issued by the Chemical Warfare Service.

(b) In the field, when chemical personnel are not present, the Ordnance Department may store and distribute chemical ammunition of types other than those listed in (a) above, except bulk chemicals and types used only by chemical troops.

(c) In the Army Air Forces, ordnance troops may be required to store and issue incendiary bombs at the air force service center and at operating airdromes.

* * * * *

[A. G. 300.7 (7 May 43).] (C 1, 21 Aug 43.)

■ 29. RESPONSIBILITY.

* * * * *

b. Scope.

* * * * *

(4) Rescinded.

c. (Added.) *Extent*.—Ordnance service begins with aiding the individual soldier and ends with assisting the Chief of Ordnance. Responsibility begins with the Chief of Ordnance and ends with the satisfied individual soldier. It is the duty of all intermediate echelons to insure the continuity of this service down to the soldier and the flow of information and advice up to the Chief of Ordnance. This can be done best by the strict observance of the principle that ordnance service extends one echelon up and one echelon down, that is, third echelon units will assist second and fourth echelons, while fourth echelon will assist third echelon and base establishments as required. All ordnance officers and men must be indoctrinated with this principle.

[A. G. 300.7 (7 May 43).] (C 1, 21 Aug 43.)

ORDNANCE SERVICE IN THE FIELD

30. TYPES OF MAINTENANCE.—*a. Classification.*—Ordnance maintenance may be considered under the following headings:

(1) Ordnance maintenance performed by combat personnel (organizational maintenance, that is, first and second echelons).

(2) Ordnance maintenance performed by ordnance personnel in the combat zone (mobile shop maintenance, that is, third and fourth echelons).

(3) Ordnance maintenance requiring permanent or semi-permanent shelter and more time (fixed shop maintenance, that is, fifth echelon).

b. Limiting factors.—Maintenance operations to * * * work normally expected. (AR 850-15 outlines in detail the echelons of motor maintenance. Similar echelons exist for the maintenance of other ordnance matériel.)

[A. G. 300.7 (7 May 43).] (C 1, 21 Aug 43.)

■ 31. MAINTENANCE PRINCIPLES.

* * * * *

g. In the zone of the interior, except during maneuvers, ordnance matériel which is brought to the shop for repair, and which has been involved in an accident, will be held intact as received pending the action of the shop officer who will be promptly notified. Such cases require the action of a board of officers before the matériel should be repaired and also requires the submission of certain reports to higher authority. (See AR 850-15 and 750-10.) In addition to the above, reports of malfunctions and accidents involving ammunition in combat will be of especial interest and value to the Chief of Ordnance. When practicable, these reports will give the type of malfunction, type of ammunition, lot number of the complete rounds or separate loading components, and conditions under which fired.

h. For a complete discussion of the operation of ordnance maintenance units, see FM 9-10.

[A. G. 300.7 (7 May 43).] (C 1, 21 Aug 43.)

■ 32. TYPES AND MISSION.—*a. General.*—The ordnance troop * * * to combat troops. Ordnance troops are also assigned to the communications zone. Their mission is to support ordnance troops assigned to tactical organizations in the communications and combat zones. The mission of ordnance

units is to render ordnance maintenance, supply, or technical service, and to impart instruction in the care, maintenance, adjustment, and functioning of ordnance matériel.

b. (Added.) *Functional types*.—Ordnance units are divided, in accordance with their assigned mission into the following types:

(1) Maintenance (including evacuation and vehicle assembly units).

(2) Depot (including vehicle distribution units).

(3) Ammunition.

c. (Added.) *Assignment types*.—Ordnance units may also be divided, in accordance with their normal assignment, into the following types:

(1) *Army Service Forces units*.—All those ordnance organizations which are not assigned or attached to a tactical unit. The units operating only in the communications zone of a theater of operations (base organizations) are considered under this heading.

(2) *Army Ground Forces units*.—Those assigned or attached to Army Ground Forces tactical organizations.

(3) *Army Air Forces units*.—Those whose typical assignments and mission are with the Army Ground Forces.

[A. G. 300.7 (7 May 43).] (C 1, 21 Aug 43.)

■ 33. ORGANIZATION AND EQUIPMENT.—a. *General*.—The basic ordnance unit is the company. It will habitually keep its own property and personnel records, make its own authorized promotions, and perform its own second (and higher) echelon of maintenance. (This provision is not intended in any way to lessen the responsibility of battalion commanders in training in these matters.) The ordnance company, in its organization, follows closely the basic principles of company organization evident throughout the military service. Each company has been designed with a view to having numbers of trained personnel and quantities of specialized equipment sufficient to handle the particular mission for which the company is organized. For purposes of administration, tactical and technical control, the companies, with the exception of divisional maintenance companies, are normally organized into battalions. When the requirements of the situation warrant, battalions may be organized into groups under a

group headquarters and headquarters detachment (T/O 9-312).

(1) *Divisional units.*—Ordnance units which are organic in divisions comprise the light maintenance company for infantry divisions, the medium maintenance company for cavalry divisions, an ordnance maintenance battalion for armored divisions, and special units for airborne or mountain divisions. The mission of these units is the performance of such of the third echelon maintenance of ordnance matériel for the division as is within their capabilities. They also perform the functions of ordnance supply of material for second echelon maintenance to the regiments, battalions, and separate companies of the division. Divisional maintenance organizations for the most part will have to be reinforced by the services of nondivisional maintenance units under army control. This will be particularly true if combat units such as tank or tank-destroyer battalions are attached to the division.

(2) *Nondivisional units.*—Ordnance companies other than those specifically organized for, and/or attached to divisions, are normally grouped together in battalions. (See pars. 35.1 and 37.1.)

(3) *Control.*—Ordnance units assigned to divisions operate under the control and direction of the division ordnance officer. Other ordnance organizations operate under the control and direction of the army or theater ordnance officer, as the case may be. For a discussion of the operations of ordnance troops, see paragraph 63.1.

(4) *Description.*—A description of the normal mission and assignment of the various ordnance units is given in the succeeding sections of this chapter, and a graphical representation of a method of assignment in a theater of operations is shown in figure 5.1.

Subparagraphs *a*, *b*, *c*, and *d* are relettered *b*, *c*, *d*, and *e*, respectively.

e. Equipment.—Organizational and individual equipment for ordnance units is prescribed in the pertinent Table of Equipment (or Table of Basic Allowances No. 9), as supplemented by SNL Group N.

[A. G. 300.7 (7 May 43).] (C 1, 21 Aug 43.)

■ 34. MILITARY TRAINING AND TECHNICAL TRAINING.

* * * * *

b. Basic military training.—The training of the ordnance soldier will be carried out in accordance with current mobilization training programs (see FM 21-6). Ordinarily the recruit * * * the proper MTP.

* * * * *

d. Advanced training.—Selected officers and men of the organization may obtain advanced technical training by being sent to ordnance schools in accordance with quotas covering students to be sent from each organization as announced from time to time in War Department orders. In addition to * * * its specific mission.

[A. G. 300.7 (7 May 43).] (C 1, 21 Aug 43.)

Section II, With Army Ground Forces, is rescinded and the following substituted therefor:

SECTION I½

ARMY SERVICE FORCES UNITS

■ 35. ORDNANCE BASE COMPANIES.—*a. Headquarters and service company, ordnance base maintenance battalion (armament or automotive)* (T/O 9-316).—There is one of these companies in each ordnance base maintenance battalion (armament or automotive) (T/O 9-315 or 9-325). It furnishes the necessary administrative personnel for the supervision and control of the battalion. It also performs service functions for the other companies of the battalion.

b. Ordnance base armored vehicle maintenance company (T/O 9-317).—The normal assignment of this company is one per ordnance base armament maintenance battalion (T/O 9-315). It performs fifth echelon maintenance on all armored vehicles.

c. Ordnance base artillery and fire control maintenance company (T/O 9-318).—This company is normally assigned one per ordnance base armament battalion (T/O 9-315). It performs fifth echelon maintenance on all artillery matériel and on the fire-control equipment pertaining thereto.

d. Ordnance base small arms maintenance company (T/O 9-319).—Normal assignment is one per ordnance base armament

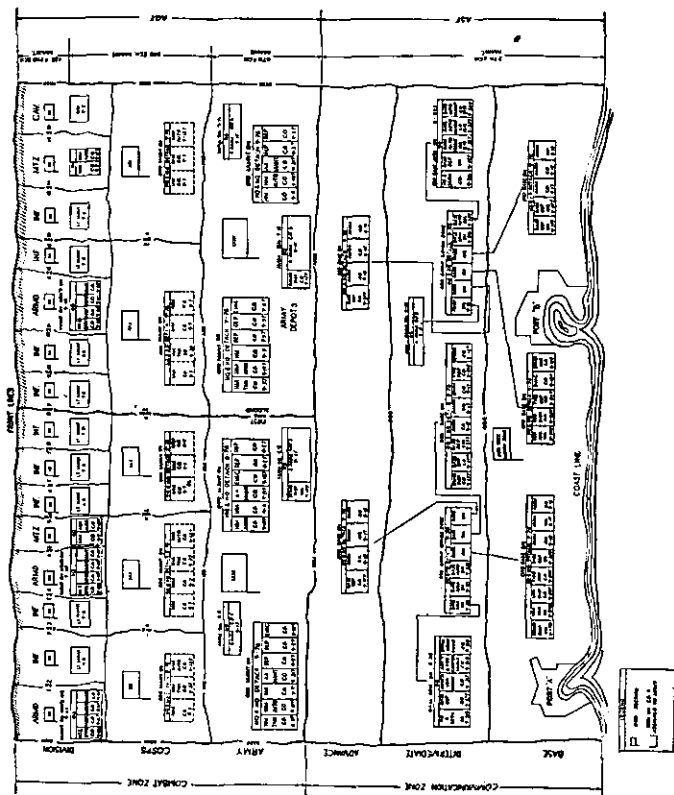

FIGURE 5.1.—Typical assignment of ordinary units in an oversea theater.

maintenance battalion (T/O 9-315). This company performs fifth echelon maintenance on small arms matériel.

e. Ordnance base automotive maintenance company (engine rebuild) (T/O 9-327).—The normal assignment is two per ordnance base automotive maintenance battalion (T/O 9-325). One of these companies is organized on an assembly line basis capable of rebuilding approximately 50 in-line engines per day. The other is organized on a job maintenance basis to take care of seven to ten engines per day.

f. Ordnance base automotive maintenance company (power train rebuild) (T/O 9-328).—The normal assignment is one per ordnance base automotive maintenance battalion (T/O 9-325). This company performs fifth echelon maintenance on axles, chassis, transmissions, transfer cases, differentials, brake drums, brake cylinders, steering gear boxes, etc.

g. Ordnance motor vehicle distributing company (T/O 9-337).—The normal assignment of this company is in base battalions with motor vehicle assembly company (T/O 9-348) in the ratio of one per vehicle assembly company. Its normal mission is to move new and repaired vehicles to forward areas. It should be utilized, as the situation permits, to move other supplies forward and to assist in evacuation of unserviceable matériel to the rear.

h. Ordnance motor vehicle assembly company (portable) (T/O 9-348).—The normal assignment of this company is in ordnance base battalions as required. It is responsible for assembling motor vehicles that are shipped in single and twin unit packs. It has a capacity of approximately 25 vehicles per day.

i. Ordnance tire repair company (T/O 9-347).—The normal assignment of this company is in ordnance base battalions as required. It is charged with the repair and retread of all rubber tires except those on aircraft and other Army Air Forces equipment. The company has an estimated capacity of 125 retreads and 300 sectional repairs per day.

j. Ordnance base depot company (T/O 9-377).—This company is normally assigned to base battalions as required. It furnishes the necessary personnel for the operation of fixed base depots. These depots may be either general or branch. The company will require augmentation by personnel from labor battalions or native labor. It has a capacity for receiving, storing, and shipping all ordnance major items, and approximately 50 tons of

spare parts per day. This company is also utilized as a shop supply company in the ordnance base maintenance battalions.

k. Ordnance bomb disposal company (T/O 9-177).—In the zone of the interior, this company is assigned to defense commands and to service commands. In a theater of operations, it is assigned as required. It is charged with removal and disposition of unexploded and time-delay bombs and ammunition.

l. Ordnance company, service (no T/O).—Ordnance companies, service, are generally composed of station detachments in a prescribed area. They are normally utilized in the zone of the interior service commands, and are commanded by the senior ordnance officer or his representative on the staff of the area commander.

[A. G. 300.7 (7 May 43).] (C 1, 21 Aug 43.)

■ **35.1. ORDNANCE BASE BATTALIONS.**—*a. Headquarters and headquarters detachment, ordnance battalion (T/O 9-76).*—Ordnance companies operating in the communications zone, except those in the base armament and automotive maintenance battalions, are normally grouped into battalions under this headquarters and headquarters detachment. (See par. 37.1.) Battalions operating in the communications zone are under the control of the communications zone ordnance officer.

b. Ordnance base armament maintenance battalion (T/O 9-315).—This is an ordnance base organization assigned to theaters of operations. It is capable of performing base armament maintenance for a force comprising nine infantry divisions or one armored division. It consists of a headquarters and service company (T/O 9-316), a base depot company (T/O 9-377), a base armored vehicle maintenance company (T/O 9-317), a base artillery and fire control maintenance company (T/O 9-318), and a small-arms maintenance company (T/O 9-319). The depot company assigned to this battalion and the base automotive maintenance battalion, is essential for the supply of the shops of the battalion only, and does not make issues to line organizations or to other depots. This battalion is designed to operate as a unit and should not be split up into separate companies except under very unusual circumstances. It performs fifth echelon maintenance on all weapons and armored vehicles.

c. Ordnance base automotive maintenance battalion (T/O 9-325).—This is an ordnance base organization assigned to theaters of operations to perform fifth echelon maintenance for all general purpose vehicles. It is capable of handling the fifth echelon maintenance requirements of a force having from 25,000 to 40,000 motor transport vehicles. This battalion consists of a headquarters and service company (T/O 9-316), two base automotive maintenance companies (engine rebuild) (T/O 9-327), a base automotive maintenance company (power train rebuild) (T/O 9-328), and a base depot company (T/O 9-377).

[A. G. 300.7 (7 May 43).] (C 1, 21 Aug 43.)

■ 35.2. HEADQUARTERS AND HEADQUARTERS DETACHMENT, ORDNANCE BASE GROUP (T/O 9-312).—When the situation warrants, base battalions may be organized into ordnance base groups. The headquarters and headquarters detachment for this group (T/O 9-321), furnishes the necessary personnel for the administration and supervision of three or more of the following ordnance battalions: base, base automotive, maintenance, base armament maintenance, and ammunition. *Para. 35.3 of 1, 6, 25*

[A. G. 300.7 (7 May 43).] (C 1, 21 Aug 43.)

SECTION II

ARMY GROUND FORCES UNIT

■ 36. ORDNANCE SECTIONS.—There are included in the Table of Organization of a number of Army Ground Forces headquarters, ordnance sections composed of a small number of officers and enlisted men. These sections are concerned entirely with staff matters, the exact nature of which is dependent on the function of the headquarters of which they are a part. For a list of these sections and their strength, see appendix III.

[A. G. 300.7 (7 May 43).] (C 1, 21 Aug 43.)

■ 37. ORDNANCE COMPANIES.—*a. Ordnance light maintenance company, infantry division (T/O 9-8).*—The light maintenance company is organic within the infantry division. This company has been set up to perform approximately 30 percent of the third echelon maintenance for the division during combat, and up to 60 percent at other times depending on the mobility of the situation. It gives close support to the troops of the division.

b. Headquarters and headquarters company, maintenance battalion, armored division (T/O 9-66).—This is the company of the ordnance maintenance battalion, armored division (T/O 9-65), in which is located the headquarters of the battalion and the office of the division ordnance officer. This company carries heavy stocks of spare parts and functions as a base operating point for the other companies of the battalion.

c. Company, maintenance battalion, armored division (T/O 9-67).—This company performs third echelon maintenance and supply for the armored division. There are three of these companies in each ordnance maintenance battalion, armored division. They enable the division to be self-sufficient in third echelon maintenance for a short period.

d. Airborne ordnance maintenance company (T/O 9-87).—This company is organically assigned to the airborne division and performs third echelon maintenance of the ordnance matériel of the division.

e. Ordnance maintenance company, mountain division (T/O 9-137).—This company is organically assigned to the mountain division and performs third echelon maintenance of the ordnance matériel of the division.

f. Ordnance maintenance company, engineer special brigade (T/O 9-97S).—This company is organic within the engineer special brigade. It performs third echelon maintenance of ordnance matériel for the brigade.

g. Ordnance medium maintenance company (T/O 9-7).—This company performs third echelon maintenance of small arms, artillery, fire-control equipment, general purpose vehicles, and, if specially trained, for tank-destroyer equipment. It is normally assigned under the ordnance battalion headquarters (T/O 9-76), and is assigned to army or theater. It may be attached to corps under battalion control if necessary, and it is organic within the cavalry division.

h. Ordnance medium automotive maintenance company (T/O 9-127).—This company handles third echelon maintenance of general purpose vehicles, scout cars, half-track cars, and small arms. It is normally assigned to battalions in the army area as required, and may be attached to lower headquarters and commands (AA, etc.) if necessary.

*i. Ordnance antiaircraft maintenance company (T/O-217).—*This company performs third echelon maintenance of antiaircraft guns, fire-control equipment, and to a limited extent, on vehicles. It is assigned to maintenance battalions under army or similar headquarters, normally on the basis of one per five antiaircraft battalions. It may be assigned to headquarters of large antiaircraft concentrations augmented by medium or heavy automotive maintenance companies, or subdivisions may be attached to other maintenance units when antiaircraft dispersion precludes the use of a full company in any one area.

*j. Ordnance heavy maintenance company, field army (T/O 9-9).—*As the name implies, this company is equipped to handle heavier maintenance loads than the medium maintenance company. It is normally assigned to battalions in the army area for the performance of fourth echelon maintenance within its capabilities, of the ordnance matériel evacuated from the forward echelons. It is also frequently assigned to communications zone establishments.

*k. Ordnance heavy automotive maintenance company (T/O 9-197).—*This company is assigned to ordnance battalions under army or theater control as required. It performs fourth echelon maintenance on general purpose vehicles, scout cars, half-track cars, and small arms.

*l. Ordnance company, heavy maintenance (tank) (T/O 9-37).—*This company performs fourth echelon maintenance for all ordnance equipment of armored units, with special emphasis on tanks. It is also capable of fourth echelon maintenance on other vehicles. It is assigned to maintenance battalions under army control as required. It may also be attached to armored forces, corps, or tank groups if necessary.

*m. Ordnance maintenance company, railway artillery (T/O 9-47).—*This company is normally assigned to theater reserve on the basis of one per regiment of railway artillery. It is equipped to handle all normal maintenance problems encountered with such regiments. Platoons of this company are equipped to operate separately.

*n. Ordnance evacuation company (T/O 9-187).—*This company is assigned to theater or army headquarters. Its normal mission is the transportation forward, and the evacuation to the rear, of

armored vehicles and other heavy equipment. It should be assigned on the basis of one company per approximately 250 tank-type vehicles in the theater.

o. Ordnance ammunition company (T/O 9-17).—This company is normally grouped in the ordnance ammunition battalion (T/O 9-15). It is assigned to armies, air forces, theater reserve, and communications zone installations. It operates ammunition depots and ASP's. The usual basis for the assignment of this company is one per 500 tons of ammunition handled per day.

p. Ordnance depot company (T/O 9-57).—Each of these companies is equipped to handle all types of ordnance supply, including automotive, small arms, etc. It operates the ordnance general supply depots. It is normally assigned under a battalion headquarters with other depot companies and/or maintenance companies under army ordnance control.

[A. G. 300.7 (7 May 43).] (C 1, 21 Aug 43.)

■ 37.1. ORDNANCE BATTALIONS.—*a. Headquarters and headquarters detachment, ordnance battalion (T/O 9-76).*—Whenever two or more ordnance companies, except ammunition or base armament or automotive, are operating in any one area, they will be grouped into battalions under this headquarters for control and direction. It furnishes the necessary personnel for the administration and control of two to five companies. In order to maintain the highest flexibility for ordnance service, no type battalions in this category are specified. These battalions are assigned throughout the theater of operations as required. In the combat zone, all battalions except divisional maintenance battalions, are normally under the control of the army ordnance officer. However, they may be attached to corps or comparable headquarters if necessary.

b. Ordnance ammunition battalion (T/O 9-15).—There are normally two of these battalions per field army. They are also assigned to the communications zone as required. Each battalion includes from two to six ammunition companies.

c. Maintenance battalion, armored division (T/O 9-65).—This battalion is assigned organically to the armored division. It operates under the control of the division ordnance officer, in direct support of the combat elements of the division. It consists of a headquarters and service company (T/O 9-66), and

BASIC FIELD MANUAL

three maintenance companies (T/O 9-67). This battallon enables the armored division to be self-sufficient in third echelon maintenance for a short period.

[A. G. 300.7 (7 May 43).] (C 1, 21 Aug 43.)

BY ORDER OF THE SECRETARY OF WAR:

G. C. MARSHALL,
Chief of Staff.

OFFICIAL:

J. A. ULIO,
Major General,
The Adjutant General.

FM 9-5

ORDNANCE FIELD MANUAL



ORDNANCE SERVICE IN THE FIELD



UNITED STATES
GOVERNMENT PRINTING OFFICE
WASHINGTON : 1942

WAR DEPARTMENT,
WASHINGTON, July 11, 1942.

FM 9-5, Ordnance Field Manual, Ordnance Service in the Field, is published for the information and guidance of all concerned. It is based on FM 100-10, Field Service Regulations, FM 101-5, The Staff and Combat Orders, FM 101-10, Organization, Technical and Logistical Data, and the recognized concepts of modern ordnance service in the field.

The primary intent of this manual is to provide a ready reference for ordnance officers, covering the general principles which govern the operation of all ordnance service in the field. The details pertaining to particular aspects of field service are treated more completely in other field manuals published by the Ordnance Department and the various arms and services.

[A. G. 062.11 (4-22-42).]

BY ORDER OF THE SECRETARY OF WAR:

G. C. MARSHALL,
Chief of Staff.

OFFICIAL:

J. A. ULIO,
Major General,
The Adjutant General.

DISTRIBUTION:

R and H (2); Bn 1-7, 17 (2); Bn and L 9 (10).
(For explanation of symbols see FM 21-6.)

TABLE OF CONTENTS

	Paragraphs	Page
CHAPTER 1. General.....	1-3	1
CHAPTER 2. Ordnance staff officer.....	4-10	5
CHAPTER 3. Supply.		
SECTION I. General.....	11-16	12
II. Ammunition supply.....	19-27	19
CHAPTER 4. Maintenance.....	28-31	31
CHAPTER 5. Ordnance troop units.		
SECTION I. General.....	32-34	33
II. With Army Ground Forces.....	35-37	35
III. With Army Air Forces.....	38-40	37
CHAPTER 6. Ordnance Service in the theater of operations.		
SECTION I. General.....	41-46	40
II. Communication zone.....	47-52	43
III. Regulating station.....	53-56	52
IV. Combat zone.....	57	53
CHAPTER 7. Ordnance service in the combat zone.		
SECTION I. In the army.....	58-63	55
II. In the corps.....	64-71	64
III. In the division.....	72-84	68
CHAPTER 8. Ordnance service in the Army Air Forces.		
SECTION I. General.....	85-91	77
II. In an air force.....	92-94	83
III. In an air base area.....	95-99	87
IV. At a dispersed airdrome.....	100-101	88
V. Air service command.....	102-106	89
CHAPTER 9. Basic data.....	107-111	93
APPENDIX I. Check list for ordnance plans.....		96
II. Publications applicable to ordnance activities.....		99
III. Ordnance troop assignments.....		102
INDEX.....		105

ORDNANCE FIELD MANUAL

ORDNANCE SERVICE IN THE FIELD

(This pamphlet supersedes FM 9-5, October 16, 1939, including Training Circular No. 42, War Department 1941.)

CHAPTER 1

GENERAL

■ 1. MISSION AND RESPONSIBILITIES.—*a. Mission.*—The mission of the Ordnance Department in the field is to store and issue ordnance general supplies and ammunition; to inspect, repair, alter, and maintain ordnance matériel in the hands of troops and in storage; to administer the field establishments; and to provide technical information and guidance.

b. Responsibility.—The responsibility of the Ordnance Department includes:

(1) Supply of ordnance general supplies to unit supply officers.

(2) Supply of ammunition up to the point of issue to the troops, except in the case of air force units for which service is provided up to the airplane.

(3) Inspection of ordnance matériel issued to troops, and maintenance of this matériel when such maintenance is beyond the capabilities of the facilities and personnel available in the units themselves.

(4) Collection and dissemination of technical information.

(5) Reception and reclamation of captured or abandoned matériel, general supplies, and ammunition. Enemy resources should be exploited to the fullest extent.

(6) Destruction of ammunition when required. This includes the destruction or removal of duds or delayed action ammunition.

(7) Cooperation with the Chemical Warfare Service in obtaining samples of the chemical filler of any enemy chemical ammunition for analysis.

■ 2. ORGANIZATION OF ORDNANCE SERVICE.—*a. General.*—The organization of ordnance service embraces the establishments,

facilities, and troop units available to the Ordnance Department for carrying out its field mission. The echelons of ordnance service are organized in conformity with both the geographical and tactical organization of the Army of the United States. The relationships of the various elements of ordnance service within the geographical subdivisions and tactical echelons of the field forces, and of the ordnance officers controlling them, are illustrated in figure 1.

b. Geographical organization of the army.—There are two major geographical areas which come into existence by War Department designation of the theater of war on the outbreak of hostilities; these are the theater of operations and the zone of the interior. *The theater of war* comprises those areas of land and sea which are or may become involved directly in the operations of war. *The zone of the interior* in general comprises the area of the national territory exclusive of the theater of operations. The actual areas of operations within the theater of war are denominated *theaters of operations*. The areas comprising the theaters of operations are designated by the War Department. There may be one or more theaters of operations. A theater of operations is further subdivided into the communications zone and the combat zone. *The communications zone* is that part of the theater of operations containing the lines of communication, the establishments of supply and evacuation, and other agencies required for the immediate support and maintenance of the field forces in the theaters of operations. *The combat zone* comprises that part of the theater of operations required for the active operation of the combatant forces.

c. Tactical organization of the Army.—The tactical organization of the Army consists of the Army Ground Forces, the Army Air Forces, the Services of Supply, and the theaters of operations.

■ 3. ORDNANCE SERVICE IN THE ZONE OF THE INTERIOR.—*a. Mission.*—The mission of the ordnance department in the zone of the interior is the design, development, procurement, storage and issue of ordnance matériel adequate in both quality and quantity to meet the needs of the field forces.

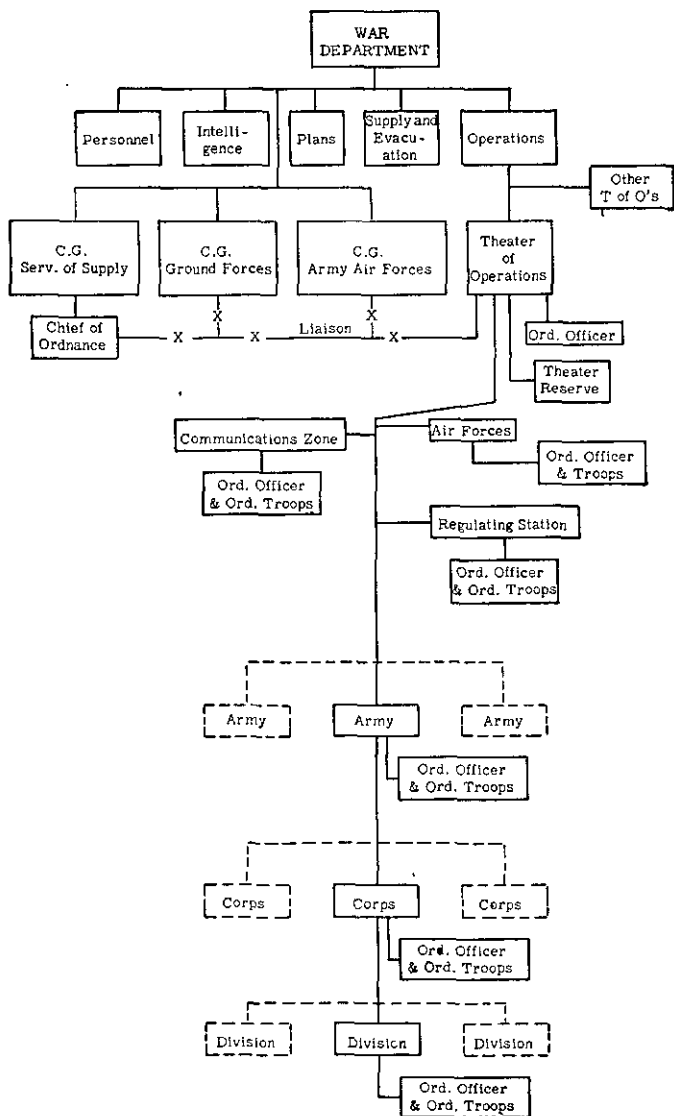

FIGURE 1.—Relationship of ordnance staff officers.

the provision of an uninterrupted flow of this matériel into the hands of troops, and the provision of adequate facilities for the repair of that matériel evacuated to the zone of the interior.

b. Facilities.—The ordnance facilities available for the accomplishment of the ordnance service mission within the zone of the interior in the United States only, comprise those establishments under the direct control of the Chief of Ordnance together with agencies under the immediate supervision of corps area ordnance officers. The major ordnance supporting facilities are those establishments under the direct control of the Chief of Ordnance. These comprise the manufacturing arsenals, procurement districts, proving grounds, loading plants, training centers, and field service depots. Ordnance officers at posts, camps, and stations operate directly under the control of the commanding officers of such commands. In technical matters, however, they operate in close cooperation with the respective corps area ordnance officers, who as representatives of the corps area commander are responsible for the coordination of all ordnance service in the corps area.

CHAPTER 2

ORDNANCE STAFF OFFICER

■ 4. **ORDNANCE STAFF OFFICERS.**—*a. Organization of staff.*—The existence of staffs arises from the necessity for providing the commander of a military unit with certain specially trained officers to assist him in the exercise of his command. This assistance comprises the handling of the manifold details associated with the continuing and complete knowledge which must be furnished the commander in all matters bearing on his command decisions. In order to accomplish this mission, staff work is functionally subdivided into four distinct categories: personnel, military intelligence, operations and training, and supply and evacuation. In units of a division or larger it becomes necessary to vest these four functions in a general staff and, in addition, to supplement this staff with a special staff. The special staff comprises those officers of the various arms and services who may be assigned to a headquarters for technical, supply, and administrative purposes. The special staff operates with the general staff under the policies prescribed by the unit commander. The duties of the individual members of the special staff will be concerned with particular aspects of one or more of the four general staff functions. The importance to the commander and his staff of expert assistance in ordnance matters makes it imperative that an ordnance officer be a member of each special staff constituted. For complete information on general and special staff matters, reference should be made to the appropriate sections of FM 100-5, 100-10, and 101-5.

b. Prescribed duties.—As the senior ordnance member of the special staff, an ordnance staff officer has the following prescribed duties and responsibilities:

(1) Command of ordnance troops not assigned or attached to subordinate units.

(2) Adviser to the commander and the staff in ordnance matters. This applies particularly to ordnance technical

problems and recommendations as to plans for ordnance activities.

(3) Supply of ammunition up to the point of issue to unit trains except in the case of air force units for which service is provided up to the airplane. He should anticipate requirements of the unit and cause to be maintained accurate records as to the status of ammunition and ordnance supplies.

(4) Operation of ordnance storage, maintenance, and repair facilities, including salvage and repair of ordnance matériel, whether friendly or enemy in origin. The search of battlefield areas for abandoned ordnance matériel is a responsibility of the Quartermaster Corps. (See FM 100-10.) However, the Ordnance Department is responsible for technical advice on ordnance matériel at the quartermaster salvage collecting point; for reclamation of ordnance unit assemblies and component parts; and for the repair and reissue of ordnance major items collected by the Quartermaster Corps. Furthermore, ordnance maintenance personnel must salvage usable ordnance matériel whenever it is encountered by them or reported to them.

(5) Technical inspection of ordnance equipment.

(6) Supervision, within limits prescribed by his commander, of ordnance activities in subordinate units.

(7) The collection of information concerning ordnance matériel, that used by our troops and that used by the enemy. (For a discussion of the general functions of a staff officer see FM 101-5.)

(8) The supplementing of our own matériel with captured matériel. This includes not only the assembling for issue to our own troops of captured guns and tanks, but also the supply to such troops of appropriate ammunition, the proper disposition of necessary spare parts, and the proper disposition of information essential to the maintenance of such matériel.

■ 5. MISCELLANEOUS DUTIES AND RESPONSIBILITIES.—*a. Diaries.*—Ordnance staff officers will keep diaries of important events affecting ordnance service. These will include such items as statistical data, operations and procedure, etc.

Diaries properly and carefully maintained constitute invaluable sources of information for future reference.

b. Protective planning.—Ordnance staff officers will prepare plans to guard against ordnance stores falling into enemy hands. Such plans will provide for evacuation and for destruction if evacuation is impracticable. Actual destruction will not be carried out without orders from the commander responsible for the stores unless communication with the commander is impossible. For a more complete discussion of organizations for supply, reserve supplies, number and location of supply points, influence of tactical operations, and movement of supply points see FM 100-10.

c. Safeguarding of information.—Ordnance staff officers will carefully safeguard information which might be useful to the enemy, such as composition and location of tactical units and their supply establishments. They will warn all subordinate personnel that the result of negligence in this respect may have far reaching effects on operations and on the lives of their comrades.

d. Technical functions.—Ordnance staff officers should know the capabilities and limits of all ordnance matériel in their commands. They should be qualified to give the salient ordnance characteristics of all newly approved or experimental ordnance major items. They should also be conversant with serviceability requirements for ammunition, disposal or demolition of duds or other unserviceable ammunition, and the provisions of TM 9-1900. They should be able to instruct using troops in maintenance and operation of ordnance matériel. In general, they should know every aspect of ordnance matériel including how it is employed tactically.

e. Inspections.—They should keep advised of the status of the maintenance and supply of ordnance matériel in their units by means of frequent personal visits.

■ 6. CHANNELS OF COMMUNICATION.—There are two recognized channels of communication between military commands; these are "command" and "technical" channels. Communications within the command channel are either signed by the commander or authenticated by a general staff officer or adjutant general. In order to keep this channel free from the many details of administration which are handled by

special staff officers, the technical channel is employed. In the technical channel correspondence is sent from the special staff officer representing a service at one headquarters to the special staff officer representing the same service at another headquarters. Matter contained in correspondence within the technical channel should not require the action of any other staff officers of either command. It should be confined to normal technical operations of the service which the special staff officer represents and to such information and reports as have been authorized by the higher commanders. Nothing that requires the announcement of a new policy or a variation from prescribed methods will be handled through the technical channels.

■ 7. RELATIONS WITH OTHER ARMS AND SERVICES.—*a. Responsibility.*—Primary responsibility for proper ordnance service to the units rests with the commander. The unit ordnance officer is ordinarily called upon for advice with respect to the ordnance requirements during the preparation of the commander's plan in any situation and should at all times be prepared to submit a complete ordnance plan; the actual execution of such a plan when approved is the responsibility of the unit ordnance officer.

b. Scope of initiative.—The ordnance staff officer is given a mission in the form of approved plans and administrative orders. Within the scope of these plans and orders and within the limits of the resources at his disposal he has complete initiative in insuring the best possible performance of his mission. Matters concerning routine and technical details are usually handled through personal conference with the ordnance staff officers of the next higher or lower echelon. Each unit ordnance officer is concerned that his superiors are fully informed through proper channels of the ordnance situation of his unit.

c. Cooperation.—Cooperation within the special staff is necessary to proper staff team play, and staff team play is necessary to successful execution of the commander's plans, including the ordnance plan. The use of tact and the maintenance of cordial relations between special staff officers promotes cooperation.

d. Supervision.—An ordnance officer furnishes great assistance to his unit by the supervision exercised over ordnance activities in lower echelons, particularly in combat units where ordnance personnel are not present. Such supervision is exercised by means of direct dealing with the unit commander arranged through command channels.

■ 8. RELATION BETWEEN ORDNANCE PLANS, OPERATIONS, AND INSPECTIONS.—In order to carry out approved ordnance plans and administrative orders, the ordnance staff officer must avail himself of all ordnance troops. The approved plan contains the necessary arrangements for labor and transportation which the ordnance staff officer will require in carrying out his operations. In this connection each ordnance staff officer has two distinct functions; planning and operations. Both must be performed simultaneously. While one plan is being carried out, others must be in the process of preparation. His primary role should be that of the planner. While he should supervise the execution of his plans by units placed under his control for the purpose, he should delegate actual operations to subordinates. The importance of inspections is emphasized by this consideration. Not only should the ordnance staff officer inspect to determine a basis for his planning, but also to note the manner of execution of his plans.

■ 9. ORDNANCE PLANS.—*a. Basis.*—The proper anticipation of the ordnance needs of his unit is the function of every ordnance staff officer. Proper planning will produce a continuous ordnance service. If planning is absent, service will be intermittently good and bad. Proper planning is based on the full knowledge of the intentions of the commander.

b. Form.—There is no prescribed form for ordnance plans. Only a limited part of the plan is published to the command in administrative orders. The remainder of the plan contains information necessary to G-4 for the proper coordination of the ordnance plans with those of other services. The plan as approved constitutes the commander's decision and is a directive to the ordnance officer. See check list in appendix I.

c. Preparation.—In preparing an ordnance plan, the ordnance staff officer will usually divide it into a plan for—

- (1) Employment of ordnance troops.
- (2) Ordnance maintenance.
- (3) Class II (general) supplies.
- (4) Class V supplies (ammunition).
- (5) Reclamation of captured matériel.

(6) Other aspects of ordnance service such as the disposition of ordnance stores either by evacuation or destruction when such action becomes necessary to prevent those stores from falling into the hands of the enemy. (This matter involves consideration of stockages at particular times and places, the influence of tactical situations, and other matters discussed in FM 100-10. See also par. 55.)

d. Arrangement.—When submitting an ordnance plan to G-4, the ordnance staff officer will usually arrange it into three parts:

- (1) Information to be published in the administrative order.
- (2) Recommendations concerning operations which require coordination and approval by G-4.
- (3) Detailed information for the use of ordnance personnel in the unit.

■ 10. ORDNANCE INSPECTION.—*a. Purpose.*—By means of inspections of ordnance equipment, the ordnance staff officer acquires much of the necessary knowledge which will enable him to carry out his mission. *The purpose of the inspection is to discover the difficulties of the combat troops and to increase their combat efficiency by remedying these difficulties.*

b. In combat.—During combat, inspections by ordnance representatives are a continuing operation. Every effort is made to determine before the actual need arises, the repairs and supplies which a combat unit will require. The supplies and repair facilities are pushed forward with the inspecting parties to enable the prompt filling of needs when they have been determined.

c. Formal inspections.—Prior and subsequent to combat, thorough formal inspections are made of ordnance equip-

ment in all units to determine supplies and repairs required. Repairs as far as can be made at the unit bivouac are effected at the time of inspection. Unserviceable matériel which cannot be repaired by the inspecting party is withdrawn, and either replaced immediately or arrangements for its replacement made. (See par. 31*d*.) Lists of shortages as well as lists of repair work to be performed by the unit are prepared and turned over in a report, usually formal, to the unit commander.

d. Arrangements prior to inspection.—The authority to inspect must be used solely for the purpose of giving more complete and efficient service to the arms. It must always be arranged through the command channel. Ordnance inspecting parties will not inspect units of any command without previously reporting to all commanders concerned, displaying their authority therefor, and asking the cooperation of the commanders.

e. Inspection reports.—The completeness of the inspection report will depend upon the purpose of the inspection and the conditions under which it is made. Whenever practicable, it is desirable that the result of a periodic inspection be recorded on a form so designed as to indicate clearly the defect found in each item of equipment, those corrected by ordnance personnel, those to be corrected by the organization personnel, other action required, the date of the inspection, and the name of the inspector. A complete discussion of the details pertaining to the conduct of inspections will be found in FM 9-10.

CHAPTER 3

SUPPLY

SECTION I. General.....	Paragraphs 11-18
II. Ammunition supply.....	19-27

SECTION I

GENERAL

■ 11. GENERAL PRINCIPLES OF SUPPLY.—The principles governing supply may be considered in two ways: those which are intrinsically applicable to the supplies themselves; and those which are essential to whatever system is established to meet the supply problem.

a. Principles applicable to supplies.—In the first of these classifications the following doctrines are fundamental:

(1) Supplies must be continuously adequate to the needs of the field forces.

(2) Supplies must be sufficiently mobile to reach the using troops at the moment and in the amount needed.

(3) In order that their mobility may be assured, troops must not be encumbered with a greater quantity of supplies and impedimenta than is absolutely necessary to insure their constant readiness for immediate action. Combat troops must not have their attention diverted, by anxiety over supply details, from their principal mission of defeating the enemy.

(4) Conservation in the use of supplies must be practiced by all echelons. Accordingly, troops must not be allowed to accumulate an *unauthorized excess* of supplies.

(5) All resources of the theater of operations must be thoroughly exploited. With reference to supplies, this means that full advantage should be taken of all supplies available within the theater and susceptible of conversion to practical military use. Each ordnance staff officer is responsible that enemy resources and matériel are exploited in the area which is within the commander's jurisdiction.

(6) Future requirements must be anticipated. This can only be accomplished by the intelligent compilation and in-

terpretation of supply data, and the establishment of tables of consumption rates based thereon.

(7) Reserve supplies must be echeloned in width and depth in order that supplies may be made available when and where needed.

(8) Unit reserves of supplies should be replenished as soon as possible in order to be available in an emergency.

(9) Supplies must be adequately safeguarded against loss from any cause, including enemy action (see par. 5b).

b. Principles essential to supply system.—Under the second classification the following principles are essential:

(1) *Simplicity.*—The simpler the operational details, the less likelihood of mistakes, and the greater the probability of success of the system.

(2) *Flexibility.*—Flexibility is essential to a supply system in order that it may conform readily to the requirements of the tactical or strategic situation. The attainment of this quality in practice depends upon decentralization of operations, efficient administrative control, and intelligent employment of the supply facilities available.

(3) *Elasticity.*—It is entirely possible that the system may be called upon at any time to expand or contract to meet unforeseeable conditions. In order to provide for this, adequate planning must be made for the expansion and contraction of stock levels, the facilities for handling supplies, and the manipulation of the supplies to conform to whatever strategic or tactical plan is put into operation. (See FM 100-10.)

(4) *Mobility.*—Supplies in storage are a potential asset only; until such supplies are given the requisite mobility, they do not become a real asset. Mobility is achieved by proper echelonment, location of installations on or near good transportation nets, and the maintenance of sufficient transport and labor to assure that supplies can be moved where and when needed with the minimum of delay.

(5) *Continuity.*—Supply must be continuous. Such a condition will be the result of a well integrated organization of the entire supply system. In the maintenance of a smooth, uninterrupted flow, reserves of supply are essential. Reserves safeguard continuity during periods of irregularity.

(6) *Forward movement.*—The impetus of supply must be from the rear. This implies that it is the duty of each higher commander to push supplies forward within reach of his subordinate commander. However there is the concurrent responsibility of each subordinate commander to make known his requirements to higher authority and to make the necessary arrangements for drawing and distributing supplies allocated to him. Requirements should be made known in sufficient time to permit forwarding of supplies by normal methods. In practice, a liaison (contact) party between rear and forward echelons is recommended in addition to the regular requisitions to facilitate actual delivery.

■ 12. **FACTORS AFFECTING STOCK LEVELS.**—Stocks of ordnance general supply carried in the various echelons of supply will be determined by—

a. Types and quantities of ordnance matériel in the hands of troops.

b. Amount of transportation available to the supply agency.

c. Type of the echelon and its position in the chain of supply.

d. Type of terrain and climatic conditions.

e. Type of action contemplated.

f. Degree of supply support including the expected time lag of resupply.

■ 13. **REQUIREMENTS.**—Requirements for the theaters of operations are usually incorporated in the plans of the War Department. After operations begin, these are checked by the theater commander and resubmitted with proper recommendations, through commanding generals, Army Ground Forces and Army Air Forces, to the War Department for approval. The final requirement on which issues are made from the zone of the interior to the theater of operations usually takes the form of schedules of priorities. Within the theater of operations, supply services must insure the timely anticipation of requirements by careful planning and early submission of requisitions.

■ 14. **LOCAL PROCUREMENT.**—Although the bulk of supplies required in the theater of operations is obtained from the zone

of the interior, as many of these supplies as practicable under War Department policy should be procured from local sources. The fullest use must be made of salvaged matériel. The quartermaster salvage service is responsible for the evacuation of abandoned ordnance stores from the battlefield and bivouac areas. (See FM 100-10.) Ordnance troops will recover from the salvage service in their respective echelons such serviceable weapons as are required and available. The principles of mobility and simplicity of supply are best applied when minimum transportation facilities are utilized in delivering supplies to the theater of operations.

■ 15. CLASSIFICATION OF SUPPLIES.—*a. Classes of supplies.*—All supplies issued to the field forces fall into one of the five classifications established by FM 100-10. These classes, which are designed to facilitate control and issue of supplies to the field forces, are as follows:

(1) *Class I.*—Those articles which are consumed at an approximately uniform daily rate irrespective of combat operations or terrain and which do not necessitate special adaptation to meet individual requirements, such as rations and forage.

(2) *Class II.*—Those authorized supplies for which allowances are established by Tables of Basic Allowances, and Tables of Allowances, such as clothing, gas masks, arms, automotive vehicles, radio sets, tools, and instruments.

(3) *Class III.*—Engine fuel and lubricants, including gasoline for vehicles and aircraft, diesel oil, fuel oil, and coal.

(4) *Class IV.*—Those articles of supplies which are not covered in Tables of Basic Allowances and demands for which are directly related to operations contemplated or in progress (except for articles in classes III and V), such as fortification materials, construction materials, and machinery.

(5) *Class V.*—Ammunition, pyrotechnics, antitank mines, chemical and demolition explosives.

b. Ordnance supplies.—Ordnance supplies are included normally in classes II and V.

c. Reference.—For other definitions of supply see FM 100-10.

■ 16. FLOW OF SUPPLIES.—*a. Origin.*—The initiation of the flow of ordnance supplies and munitions occurs within the

zone of the interior. From the point of initial reception in the zone of the interior to the place of ultimate issue to troops this material passes through several channels in its flow forward. In the zone of the interior this flow is directed by the Chief of Ordnance in accordance with established priorities and policies of the War Department. He is entirely responsible for the sufficiency and maintenance of this flow. As this material passes into the theaters of operations, the responsibility for its control passes from the Chief of Ordnance to the commander of the field forces, who exercises this control through ordnance staff officers.

b. Subsidiary channels of flow.—There will be tributaries to the main channel of flow just discussed. Ordnance matériel issued to units as initial equipment will accompany these units and individuals into the theaters of operations. Another subsidiary channel of flow, which will be utilized to augment the main channel of flow within the theater of operations, will originate with those materials secured by exploitation of the resources of the theaters of operations.

c. Maintenance of stock levels.—The stocks required to insure adequacy of supply during periods of interruption of the flow of supplies are maintained at the general depots or ordnance depots of the communications zone. From the base depots, ordnance supplies are forwarded to intermediate and advanced depots. These latter depots maintain balanced stocks and stock levels sufficient to provide adequate stocks immediately available for issue to the combat zone. The forward flow from base to intermediate or advanced depots will be in quantities sufficient to maintain these stock levels. Items of ordnance supplies procured locally or obtained by the repair or reconditioning of unserviceable supplies are made available for issue through the ordnance depots and other supply facilities.

■ 17. TRANSPORTATION OF SUPPLIES.—*a. Demands upon transportation facilities.*—The enormous volume of supplies of all categories required by modern armies and the time and space factors which are associated with the provisions of these supplies to the field forces, impose formidable demands upon all available transportation.

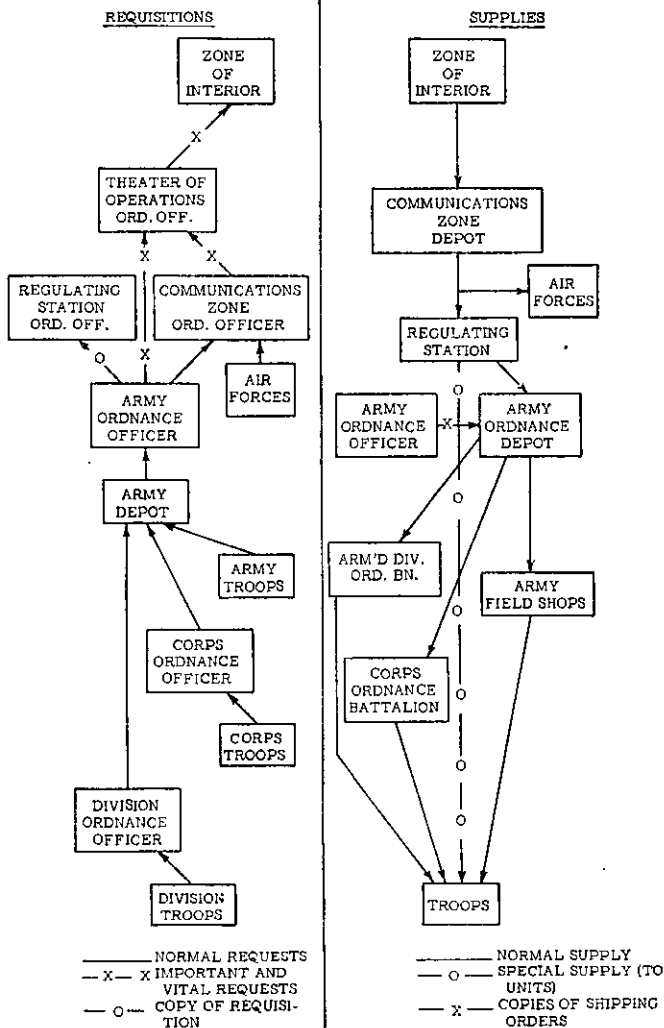

FIGURE 2.—Flow charts for general supplies.

(1) Transportation for supplies from the zone of the interior to the theater of operations is furnished in accordance with priorities recommended by the theater commander and prescribed by the War Department.

(2) Rail movements of supplies between the communications zone and combat zone is controlled from a regulating station designed to maintain regularity of supply and the smooth movement of supplies to and evacuation from the combat zone, and to avoid congestion in the forward areas. In case motor or water transportation is employed instead of, or to supplement rail transportation, agencies similar to the regulating station and the railhead are established for each kind of transportation.

(3) Within the combat zone the transporting of supplies to the point of delivery to the using troops is accomplished by transportation made available by G-4 of the army. Beyond this point the transporting of supplies is the responsibility of the various unit commanders.

b. Priorities.—The apportionment of transportation between various supply services is usually made by the establishment of priorities. To insure smooth operation, these must be rigidly adhered to in the movement of supplies. It is necessary for all supply services using common transportation to submit well-considered recommendations for the transportation required by that particular service in order that proper priorities may be established.

■ 18. **ORDNANCE GENERAL SUPPLIES** (fig. 2) Ordinance general supplies include all ordnance supplies except ammunition. They are usually made available in the form of credits in designated depots. When credits are established for an army in communications zone depots, requisitions are made, as necessary, by the army ordnance officer direct on the proper depot or through the ordnance officer at the regulating station. If sent direct to the communications zone depot, a copy is sent to the regulating officer. Shipments are made up at the depots and dispatched through the regulating stations to the ordnance depot or other designated supply point. Beyond this point the supplies are forwarded through the lower ordnance echelons. However, if large quantities are required,

they are obtained from the army depot by approved requisition. In this case division and corps transportation is sent to the depot for the desired supplies. If sufficient supplies are not available to complete the issue, unfilled portions of the requisitions are extracted, and forwarded for the necessary action to the next higher echelon in the channel of supply.

SECTION II

AMMUNITION SUPPLY

■ 19. DEFINITIONS OF AMMUNITION TERMS.—*a. Ammunition supply point (ASP).*—Supply point is a generic term used to include depots, railheads, and truckheads. However, ammunition supply point, or ASP, has a specific meaning. This point is the advanced ammunition supply installation from which the troops draw the major quantities of their ammunition. Ammunition depots and ASP's are operated by army personnel. ASP's are normally 8 to 20 miles from the front line, whereas the army ammunition depots are usually about 30 miles from the front line. Exact positions will be governed by the transportation net and the terrain.

b. Groups of ammunition.—For supply purposes only, ammunition supplied in the combat zone is divided into groups as follows:

(1) *Artillery ammunition.*—Ammunition fired from cannon of a type manned by artillery personnel.

(2) *Infantry ammunition.*—Ammunition used by all arms and services, except artillery ammunition and ammunition that can be used only in airplanes.

(3) *Aircraft ammunition.*—Ammunition fired or dropped from aircraft.

(4) *Chemical ammunition.*—All chemical ammunition furnished to the forces of the field, except incendiary bombs and the type used only by chemical troops, is stored and distributed by the Ordnance Department.

c. Complete round.—The expression "complete round" includes all the necessary components required to fire a weapon once.

*d. Unit of fire.**—The unit of fire is an arbitrary unit of measure for ammunition supply, representing a specified number of rounds per weapon. The number of rounds per weapon varies with the types and calibers of the weapons. The unit of fire is not synonymous with the term “day of supply.” In general, it represents a balanced expenditure by the various weapons under conditions of normal action. It is a term used as a yardstick or a unit of measure for supply purposes from a tactical point of view. The unit of fire will be prescribed by a theater commander unless it is previously fixed by the War Department.

■ 20. SPECIAL CHARACTERISTICS OF AMMUNITION SUPPLY.—*a. Organization.*—Requirements in ammunition are based on tactical considerations and are subject to great variation. Therefore, the ammunition supply system must be so organized as to meet sudden, unexpected, and urgent demands.

b. Segregation of lots.—As far as possible, ammunition lots are segregated within each type of ammunition. This applies throughout the ammunition supply system.

c. Shipments of ammunition.—Shipments of ammunition must be made to conform with TM 9-1900 and other pertinent technical and field manuals to insure their safe transportation. Except where components are specifically requisitioned, all ammunition shipped into the combat zone, either from the communications zone or from the zone of the interior, will be by complete rounds, plus such additional com-

*It must be remembered that the complete unit of fire for a large unit includes fixed quantities of all types of ammunition for all types of weapons. It is apparent that a complete unit of fire for a large unit, as, for example, an infantry division will not normally be expended in 1 day of fire, nor in any given period of time will the same percentages of all types of ammunition in the unit of fire be fired by any unit. It is, therefore, not practicable to make allocations of ammunition below the army in terms of units of fire. In the initial phases of any operation, when it is necessary to speak of ammunition supply, it is perfectly logical to speak of the stocks on hand in divisions, corps, or army in terms of unit of fire; or in planning for specific operations, it is proper to speak of estimated requirements of ammunition for a large unit in terms of unit of fire. It is not proper, however, after initial allocations have been made, to make allocations of ammunition for replenishment of stocks in terms of units of fire. Troops expend ammunition by rounds. They require replenishment by rounds of specific type. All allocations of ammunition for replenishment purposes will be made in terms of rounds of ammunition.

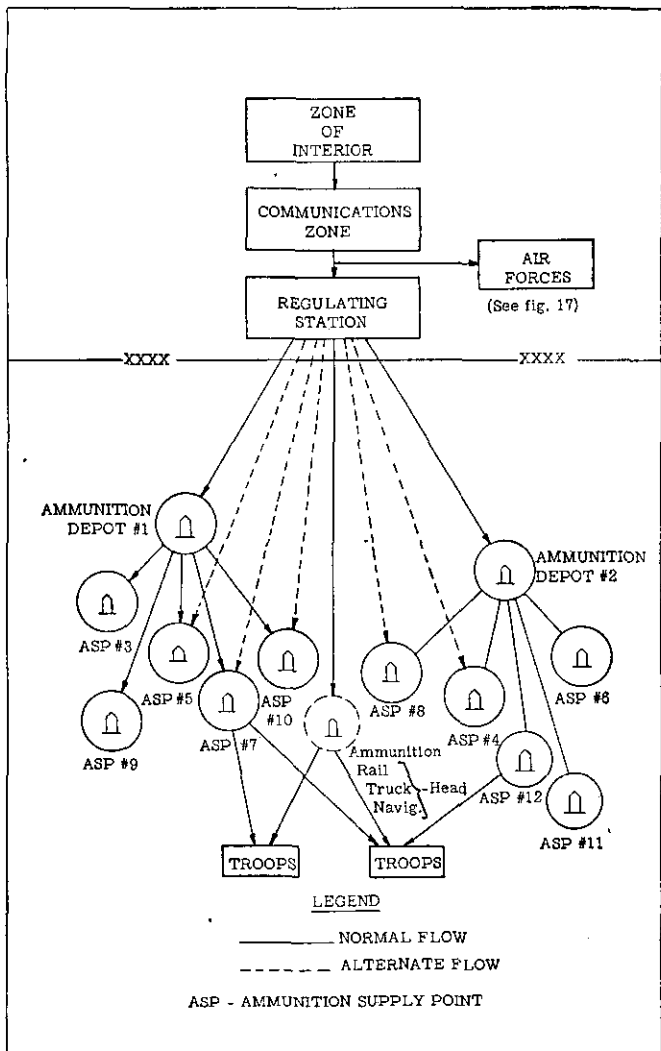

FIGURE 3.—Schematic diagram of an ammunition supply system.

ponents as are specifically requisitioned. In these shipments each vehicle of transportation will be loaded with complete rounds; however, when separate-loading ammunition is involved, components should be segregated within the vehicle.

■ 21. FLOW OF AMMUNITION.—*a. Routing.*—Ammunition arriving in the theater of operations, other than that brought by troops to which it has been issued as initial equipment, normally passes through the communications zone, through the regulating station, and then direct to the army ammunition depots and ASP's. In some instances it may go direct without physically passing through the regulating station. Some ammunition will be used in the communications zone establishments and activities.

b. Transportation.—Normally all movements of ammunition from the communications zone to the combat zone are by rail and truck. In emergencies a small amount of ammunition may be delivered by cargo aircraft.

c. Establishment of dumps.—When tactical plans require an accumulation of ammunition forward of ASP's, unit reserves or dumps are established by the commanders concerned.

■ 22. DISTRIBUTION.—*a. Command responsibility.*—In all units, the responsibility for the supply of ammunition for the unit rests with the commanding officer. This responsibility is discharged by personal action or through staff officers, depending on the size of the unit.

b. Munitions officer.—The ordnance officer is the munitions officer, that is, the special staff member charged with the administrative tasks of ammunition supply.

c. Factors in distribution.—The provision for, and the distribution of ammunition to the combat zone, the establishment and operation of army ammunition supply points, the maintenance of ammunition reserves, and the delivery, using transportation provided by G-4, of ammunition to the army ammunition supply points are responsibilities of ordnance service. The obtaining of ammunition from the ammunition supply points and the transportation and distribution of ammunition are responsibilities of the commander of the combat unit concerned.

■ 23. ADMINISTRATION.—*a. General situations.*—Two general situations occur in ammunition supply: One is a campaign of rapid movement; the other is a battle in which movement is limited for considerable periods of time. The same fundamentals apply in both cases, but the procedure will be different.

(1) *Campaign of rapid movement.*—(a) In a battle of rapid movement an organized depot system will be left behind; communication will become difficult; railheads or truckheads will be employed; and greater latitude must be given to ordnance officers at advanced ammunition installations in the issuing of ammunition. These complications will be somewhat offset by the smaller expenditures of ammunition that can be expected when the troops are making rapid displacements.

(b) In warfare of movement, to provide an adequate ammunition resupply to the units and, especially, to give ammunition to those units whose resupply is most important, requires a directive from each interested headquarters. This directive forms the basis for the actions of ordnance officers engaged in ammunition service. Though such a directive cannot anticipate all situations that may arise, it will be used by ordnance officers at ASP's as a basis for making any required decisions. Senior ordnance officers from corps and army staffs and from ordnance ammunition battalions should be well forward during critical phases of combat to direct the actions of ammunition companies and to obtain a proper picture of the ammunition supply situation.

(2) *Stabilized situations.*—In stabilized situations ammunition is normally made available in the form of credits at designated supply points for a stated period of operation. The initial allocation is made by GHQ. Each commander in turn reallocates to subordinate commanders. Credits provide commanders with definite assurance of the supplies reserved for them and expedite supply. Credits are usually established at designated supply points for a specified period. At the end of the period named in the allocation, all credits against which calls have not been received, revert to the supply point or depot stock.

b. Alternatives.—In warfare of movement, credits will not be the sole method employed in the resupply of ammuni-

tion. A less exact but more rapid procedure will be required. The commander may prescribe that demands for ammunition by certain unit commanders will be honored by specified ammunition supply points within certain specified limits or without limit; or he may direct that prescribed percentages of ammunition available at one or more supply points will be issued to each major unit upon demand. The foregoing constitutes a variation of the normal credit system.

c. Ammunition reports.—The status of ammunition supply is determined by periodic reports by combat units and ammunition supply points, consolidated and forwarded by the various echelons of command to the theater commander (see FM 100-10).

■ 24. CREDITS.—The credit system is normally used. The schematic diagram, figure 4, shows the course taken by requests for credits and the action taken upon such requests (allocations of credits). The actions illustrated by this diagram are as follows:

a. At the start of operations the plan of the commander includes the initial issuance of ammunition credits. Subsequent credits are made as determined by the tactical situation and the status of ammunition supply.

b. Requests for credits are ordinarily initiated by divisions or higher units and consolidated in each higher echelon. The allocation of credits originates at the top and the credits are then further divided in each lower echelon.

■ 25. REQUESTS FOR CREDITS.—When units are not promptly resupplied with ammunition or credits to meet the needs indicated by their ammunition reports, they will submit requests for ammunition or credits to higher headquarters as indicated in figure 4.

a. Division.—In the division, requests for ammunition are transmitted to the ordnance officer. The ordnance officer takes action in accordance with the approved plan. If other action is required he reports the situation to G-4, with a recommendation as to the action that should be taken. In the normal case, such requests are promptly filled from division credits in army supply points. In emergencies, the ammunition will be issued from the division dumps or rolling

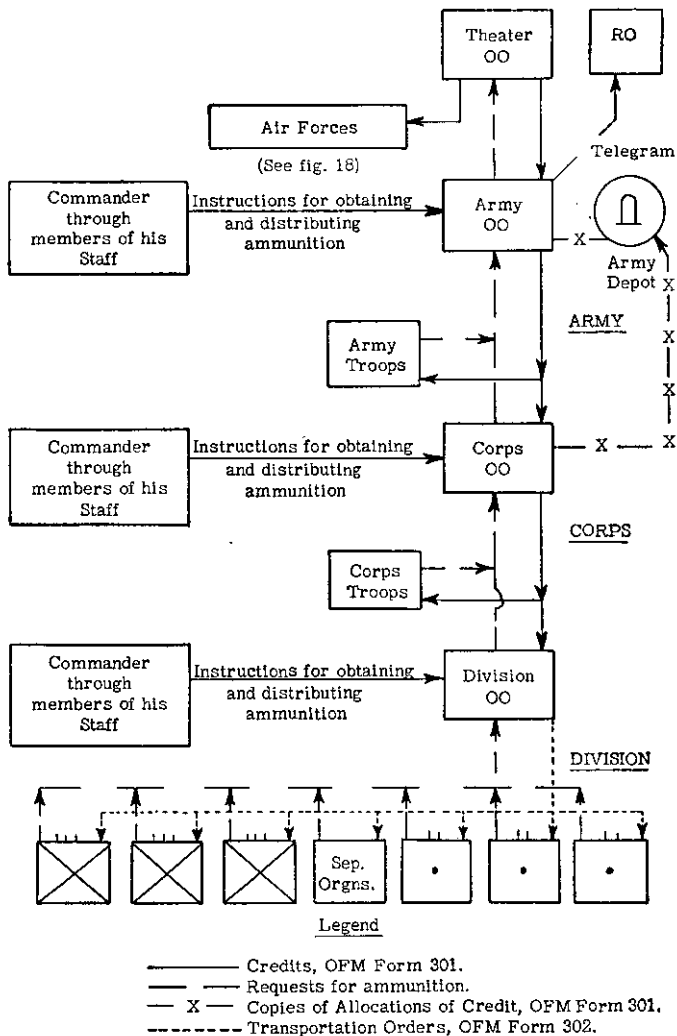

S.F. 41-3873

FIGURE 4.—Schematic diagram of the flow of allocations and requests for credits.

reserves. To effect these issues the division ordnance officer gives the unit (or the unit train commander) an order upon an ASP at which a credit balance exists, or an order upon the division train or ammunition dump. This order is the authority for the train commander to draw the ammunition. The transportation order (OFM Form No. 302) is a convenient form for this purpose. In emergencies, less formal procedures may be used, but troops should be trained to obtain ammunition in a systematic manner to prevent confusion at critical moments. Before his credits become exhausted the division ordnance officer requests the corps ordnance officer for additional credits. Thus it is apparent that the frequency of requests for ammunition and ammunition credits depends upon the rate of expenditure of the ammunition. The requests upon corps may be by telephone, telegraph, radio (exceptional), or by written message. To avoid errors, requests should be confirmed in writing.

b. *Corps.*—Within the corps, requests for ammunition are submitted to the corps ordnance officer by the division ordnance officers and ammunition officers of the troops. As directed by the corps commander, the corps ordnance officer will call upon the army ordnance officer for additional ammunition credits as required.

c. *Army.*—The army ordnance officer, after considering the status of ammunition remaining in reserve, will submit the corps and army troops requests to G-4 with recommendations as to the appropriate action to be taken. He will prepare telegrams to the regulating officer for the replenishing of stocks in the various army depots and ASP's. He will also make requests upon the theater ordnance officer for additional credits.

■ 26. ALLOCATIONS OF CREDITS.—a. *Origin of credits.*—When an army enters a combat zone, the theater commander issues to the army allocations of ammunition credits upon depots in the communications zone. (The ordnance officer on the theater commander's staff maintains the records of ammunition in the zone of communications so as to show the unobligated balance in all depots. He prepares and forwards to the army, to the depots and to the regulating officer con-

cerned, the allocation of credits determined by the theater commander.)

b. Army ordnance officer.—(1) *Action on receiving credits.*—The ammunition credits allocated to the army are received by the army ordnance officer and entered in his records. Interested general and special staff officers are promptly informed of new credits received. Thereafter, the required ammunition covered by these credits is ordered forward to the army depots and ASP's by telegraphing the regulating officer. The telegram is prepared by the ordnance officer and signed by G-4.

(2) *Basis for allocation.*—The army ordnance officer makes allocation of ammunition credits to corps and to army troops in accordance with—

(a) Approved plan.

(b) Special instructions of appropriate members of the general and special staff.

(c) Available ammunition. (Credits are never given in excess of ammunition on hand and unobligated.)

(3) *Transmission of allocations.*—The allocations may be given by telephone, telegraph, or radio (exceptional). Normally they are written; if other methods are used, written confirmation should follow. In all cases the depots concerned must be promptly informed of the credits issued against their stocks.

c. Corps ordnance officer.—When the allocation described above is received by the corps ordnance officer, the same procedure outlined in (2) and (3) above is followed, substituting corps troops for army troops, and substituting divisions for corps.

d. Division ordnance officer.—When the division ordnance officer receives the allocation of ammunition credits from the corps, he enters them upon his records and promptly notifies interested general and special staff officers.

■ 27. **AMMUNITION REPORTS.**—*a. Purpose.*—Ammunition reports serve three purposes:

(1) They inform the commander of the status of ammunition on hand in the elements of his command.

(2) They provide a basis for the allocation of the ammunition placed to his credit in army depots.

(3) They provide the army ordnance officer with a basis for resupplying ammunition depots.

b. Routing.—The schematic diagram, figure 5, shows the course taken by ammunition reports from lower echelons to higher echelons.

c. Reports from combat troops.—In the division, corps, and army, all reports from the combat troops are submitted on OFM Form No. 303. For units of branches such as air, artillery, antiaircraft artillery, having a special staff officer on the staff of the commander, these reports are submitted to the special staff officer for consolidation and transmission to the ordnance officer. For all other units, including the infantry regiments in the division, the reports are submitted directly to the ordnance officer.

(1) *In divisions.*—In divisions the ordnance officer prepares OFM Form No. 304, basing it on—

(a) Reports received from the troops.

(b) His record of allocations, if any are made.

(c) Reserves still on hand in ASP's or other supply points. The original of this report is sent to the corps ordnance officer. A copy is sent to division G-4, and one is placed on file in the division ammunition office. This retained copy will serve later as part of the basis for the ordnance officer's recommendations to G-4 covering the disposition of ammunition credits.

(2) *In corps.*—In the corps, the ordnance officer prepares OFM Form No. 304, basing it on—

(a) Reports received from divisions, from corps troops, and from special staff officers.

(b) His record of allocations made.

(c) The reserves still on hand in depots and other supply points.

The original of this report is sent to the army ordnance officer. A copy is sent to corps G-4, and one is placed on file in corps ordnance office.

(3) *In army.*—In the army, the ordnance officer prepares OFM Form No. 310, basing it upon the reports received from subordinate units as described above in the case of the corps. In the case of the army, however, the report of status of stocks (OFM Form No. 306) shows the unobligated balances in army

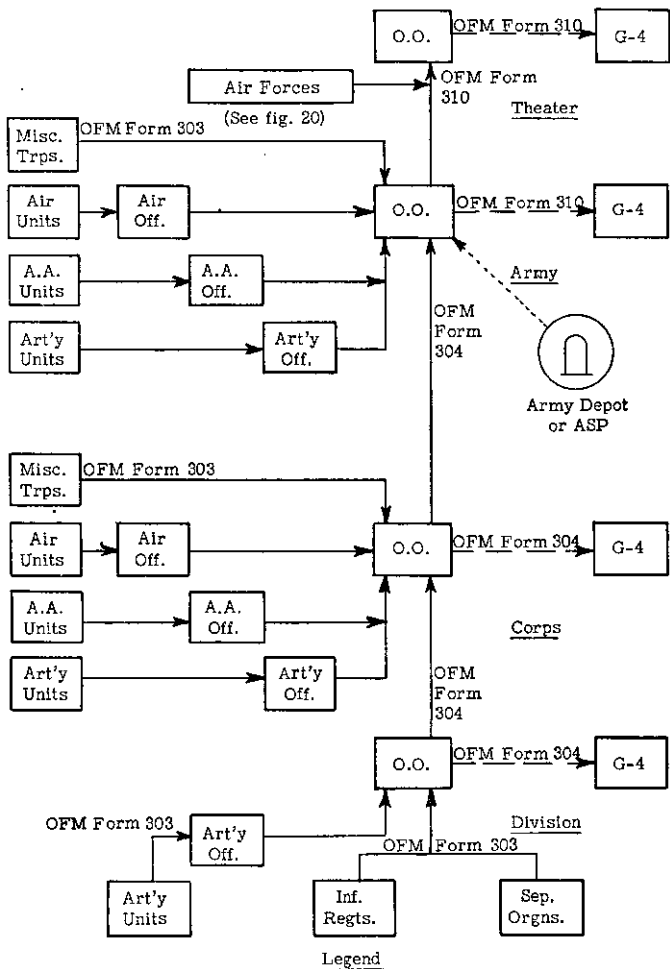

S.F. 41-3875

FIGURE 5.—Schematic diagram of flow of ammunition reports.

depots and ASP's as submitted by these supply points to the army ordnance officer. The original of this report (OFM Form No. 310) is transmitted to the ordnance officer on the staff of the theater commander. A copy is transmitted to army G-4, and one is placed in the file of the army ordnance office. This retained copy will serve later as the basis for the recommendations which the ordnance officer will be called upon to submit in connection with the disposition of ammunition credits. For a complete discussion of the details pertaining to the ammunition supply system, see FM 9-6.

CHAPTER 4

MAINTENANCE

■ 28. **PURPOSE.**—The purpose of ordnance maintenance is to keep ordnance matériel in such condition that it may be operated at maximum efficiency and that its life is prolonged to the utmost. Ordnance maintenance is a function of both the using arms and services and the Ordnance Department.

■ 29. **RESPONSIBILITY.**—*a. Responsible officers.*—The maintenance of ordnance matériel is the responsibility of the commander concerned. The duties of ordnance officers in connection with the maintenance of ordnance matériel are based upon their responsibilities as staff officers of the commander and as representatives of the Chief of Ordnance.

b. Scope.—In addition to the performance of normal maintenance duties, the maintenance responsibility of the Ordnance Department includes—

(1) Inspection and repair of salvaged ordnance matériel, whether friendly or enemy in origin.

(2) Arrangement for evacuation of ordnance matériel which is beyond the maintenance capabilities of available facilities, or which will not be required for reissue.

(3) Conduct of whatever troop schools may be necessary for instructing the combat units in the proper care and technical use of their ordnance matériel.

(4) The repair of any motor vehicle brought to ordnance maintenance units for repair.

■ 30. **TYPES OF MAINTENANCE.**—*a. Classification.*—Ordnance maintenance may be considered under the following headings:

(1) Ordnance maintenance performed by combat personnel (organizational maintenance)

(2) Ordnance maintenance performed by ordnance personnel in the combat zone (mobile shop maintenance)

(3) Ordnance maintenance requiring permanent or semi-permanent shelter and more time (fixed shop maintenance)

b. Limiting factors.—Maintenance operations to be accomplished under each of the above headings are limited only by the equipment, skill, parts available, and time required

to accomplish the work. Tools and parts are supplied to the personnel performing maintenance of each of the three types above in accordance with the work normally expected.

■ 31. MAINTENANCE PRINCIPLES.—*a.* Maintenance of ordnance matériel beyond the capacity of the using troops will be performed by the proper ordnance organization.

b. Ordnance service will be carried to the troops through inspection, the supply of parts, and the exchange of unit assemblies and major items which cannot be repaired immediately.

c. Maintenance operations which are a function of ordnance organizations will be performed with the least possible inconvenience to the troops.

d. Each echelon of ordnance service will support the activities of subordinate echelons. Repair work beyond the capabilities of any echelon will be evacuated to an echelon capable of performing the work. The evacuation of damaged ordnance matériel from divisions and from corps troops is discussed in FM 9-10. The governing principle is that the higher echelon of ordnance service up to and including the army is responsible for the evacuation of unserviceable ordnance matériel in the hands of lower echelons. Evacuation from the army to the communications zone is affected by the regulating officer upon request by the ordnance officer through G-4 of the army.

e. Unless it is otherwise prescribed by higher authority, each echelon of ordnance service will establish and maintain a basic load of spare parts, unit assemblies, and major items suitable for the normal maintenance, during a specified period of operations, of the organic equipment of the unit served. This basic load will be revised as experience dictates. It should be remembered that the basic load constitutes a reserve or pool from which supplies are constantly being drawn for use, and into which they are constantly being placed for replenishment.

Normally, arrangements for the evacuation of unserviceable ordnance matériel will be made through ordnance channels.

For a complete discussion of the operation of ordnance maintenance units, see FM 9-10.

CHAPTER 5

ORDNANCE TROOP UNITS

	Paragraphs
SECTION I. General.....	32-34
II. With Army Ground Forces.....	35-37
III. With Army Air Forces.....	38-40

SECTION I

GENERAL

■ 32. TYPES AND MISSION.—The² ordnance troop units which are normally assigned or attached to tactical organizations exist solely for the purpose of extending ordnance service to combat troops. Their mission is to render ordnance maintenance, supply or technical service and to impart instruction in the care, maintenance, adjustment, and functioning of ordnance matériel. These troop units are divided, in accordance with their prescribed missions, into the following types:

Maintenance

Depot

Ammunition

Aviation ordnance

■ 33. ORGANIZATION AND EQUIPMENT.—*a. Basis for organization.*—Since ordnance troop units are organized primarily to furnish the necessary specialists, tools, and supplies for the performance of particular missions, it is necessary to provide a technical organization for the employment of these means in the accomplishment of each mission. In addition, these units are military organizations designed to function in the field, and consequently must be organized along military lines for discipline, military administration, and their own defense. Details of organization and personnel are given in the appropriate Table of Organization in the 9-series.

b. Military organization.—The military organization of an ordnance unit follows in general that of an infantry unit.

A unit headquarters, or headquarters and supply section, which consists of personnel similar to that prescribed for the headquarters of an infantry battalion or company, is provided for military administration. The unit commander keeps the number of men engaged in military administration to the minimum, and keeps the maximum number of men employed in the accomplishment of the mission of the unit.

Technical organization.—The technical organization is established along functional lines. The unit is divided into sections, or platoons and sections, each of which is charged with the supervision and operation of some particular technical activity.

Equipment.—Organizational and individual equipment for ordnance units is prescribed in Table of Basic Allowances No. 9, as supplemented by ordnance SNL, group N.

■ 34. MILITARY TRAINING AND TECHNICAL TRAINING.—*a. Basis.*—In order to carry out its mission, an ordnance unit must have sufficient military training for its own military administration, protection, subsistence, clothing, transportation, and discipline. The successful technical functioning of an ordnance unit can be accomplished only after the various specialists have been properly trained.

b. Basic military training.—The training of the ordnance soldier will be carried out in accordance with current mobilization training programs. Ordinarily, the recruit will receive his basic military training in replacement training centers before being assigned to an ordnance unit. When recruits are assigned to an ordnance unit without having received this training it is the responsibility of the organization commander to complete the basic military training of the soldier within the organization in accordance with the proper MTP.

c. Basic technical training.—Ordinarily, recruits will receive a certain amount of technical training in the ordnance replacement training center. It is the responsibility of the organization commander to see that these soldiers are given, within the organization, the further technical training and actual experience which will best fit them for the duties which they are to perform.

d. Advanced training.—Selected officers and men of the organization may obtain advanced technical training by being sent to the ordnance school in accordance with quotas covering students to be sent from each organization as announced from time to time in War Department orders. In addition to the technical training of the individual specialists, the unit will be trained as a whole for its specific mission.

SECTION II

WITH ARMY GROUND FORCES

■ 35. **ORDNANCE SECTIONS.**—*a. Ordnance section, infantry division (T/O 7-1).*—This is a small section of officers and enlisted men assigned to the headquarters of the division for the purpose of operating the division ordnance office, providing ordnance general supplies and maintenance, and supervising ammunition supply. For a detailed discussion of the operations of this section see FM 9-10.

b. Ordnance sections, miscellaneous headquarters.—There are included in the Tables of Organization of a number of headquarters, ordnance sections composed of a small number of officers and enlisted men. These sections are concerned entirely with staff matters, the exact nature of their duties depending upon the function of the headquarters of which they are a part. For a list of these sections see appendix III.

■ 36. **ORDNANCE COMPANIES.**—The basic ordnance unit is the ordnance company. In its organization it follows closely the basic principles of company organization evident throughout the military service. The following are type companies:

a. Ordnance company, medium maintenance (T/O 9-7).—This is the basic maintenance unit and is normally assigned to square infantry divisions, cavalry divisions, corps ordnance maintenance battalions, and the army ordnance maintenance and supply battalions. It is assigned to combat troops and to the Army Air Forces on the basis of one per field artillery, or antiaircraft artillery brigade. Additional companies are also assigned to theater of operations reserve and to the communications zone. For a discussion of the operations of maintenance companies see FM 9-10.

b. Ordnance company, heavy maintenance, army (T/O 9-9).—As the name implies, this maintenance company is

equipped to handle maintenance of a heavier nature than that ordinarily performed by the medium maintenance company. It is organically assigned to the maintenance and supply battalion of the army, and will frequently operate installations in the communications zone.

c. Ordnance company, heavy maintenance, tank (T/O 9-9).—This company is equipped with substantially the same equipment as the medium maintenance company plus additional special equipment required for the maintenance of armored units. It is normally assigned to theater of operations reserve on the basis of one per three separate tank battalions.

d. Headquarters and headquarters company, maintenance battalion, armored division (T/O 9-66).—This is the company of the ordnance battalion maintenance, armored division, in which is located the headquarters of the battalion and the office of the division ordnance officer. This company carries heavy stocks of spare parts and functions as a base operating point for the other companies of the battalion.

e. Company, maintenance battalion, armored division (T/O 9-67).—This company is trained and equipped to support elements of the armored division. There are three of these companies in each ordnance battalion, maintenance, armored division.

f. Ordnance company, maintenance, railway artillery (T/O 9-47).—This company is usually assigned to theater reserve on the basis of one per regiment of railway artillery. It is equipped to handle all normal maintenance problems encountered with such regiments. Platoons of this organization are equipped to operate independently.

g. Ordnance company, ammunition (T/O 9-17).—This is the smallest ammunition unit. It is normally assigned to the ordnance battalion, ammunition. It is also assigned to air forces, to theater reserve and to communications zone installations. It operates ammunition depots and ASP's. The usual basis for the assignment of these companies is one per 500 tons of ammunition handled per day.

h. Ordnance company, depot (T/O 9-18).—This company is assigned to the maintenance and supply battalion of the army, to air forces, to the communications zone, and to

theater reserve. It operates ordnance general supply depots, or ordnance sections of general depots.

i. Ordnance company, service (No T/O).—Ordnance companies, service, are generally composed of station detachments in a prescribed area. They are normally organized in the zone of the interior and are commanded by the senior ordnance officer or his representative, on the staff of the area commander.

■ **37. ORDNANCE BATTALIONS**—Ordnance units assigned to large troop units, such as corps and army, and mobile units, such as the armored and motorized divisions, are grouped together in battalions under the command of the ordnance officer of the particular echelon which they are serving. The following are type battalions:

a. Ordnance battalion, maintenance and supply (T/O 9-115).—This battalion is organically assigned to the type field army. It includes elements necessary to operate the army general supply depots, and the field shops of the army. It is designed to provide ordnance service to army troops, and to support the effort of the corps maintenance battalions.

b. Ordnance battalion, maintenance (T/O 9-75).—This battalion is organically assigned to the army corps. It normally consists of three medium maintenance companies. It is commanded by the corps ordnance officer.

c. Ordnance battalion, ammunition (T/O 9-15).—Two of these battalions are normally assigned to the type field army. Each of these battalions includes six ammunition companies. The battalion operates under the control of the army ordnance officer.

d. Maintenance battalion, armored division (T/O 9-65).—This battalion is assigned organically to the armored division. It operates under the control of the division ordnance officer, in direct support of the combat elements of the division.

SECTION III

WITH ARMY AIR FORCES

■ **38. GENERAL**—Ordnance troops with air forces are divided into two categories:

a. Ordnance sections of the headquarters of the various echelons.

b. Ordnance companies.

■ 39. **ORDNANCE SECTION.**—Ordnance sections for the performance of special staff functions are found in the headquarters of the following:

- Army Air Forces
- Air force
- Air force base command
- Bomber command
- Interceptor command
- Air support command
- Air service command
- Air corps training center

The officer and enlisted personnel for the staff sections of the above mentioned commands are included in the Tables of Organization pertaining to the particular headquarters and headquarters squadron.

■ 40. **ORDNANCE COMPANIES, AVIATION.**—Ordnance-service for aviation units is performed by ordnance companies, aviation (air base, bombardment, pursuit, and service).

(a) *Ordnance company, air base (T/O 9-167).*—Authorized on the basis of one per air base and one per mobile air depot groups. In the latter case, the company is organized less the airdrome and ammunition sections. When the company is assigned to an air base, the ordnance station complement is usually attached to this company. The company consists of the following sections:

(1) *Company headquarters.*—Performs the usual company administrative duties.

(2) *Ordnance section, air base headquarters.*—Provides personnel for controlling and coordinating ordnance service in the air base service area.

(3) *Maintenance and general supply section.*—This section is organized and equipped to establish the refilling point (RP) for ordnance general supplies and the ordnance maintenance center for the air base service area.

(4) *Ammunition section.*—This section is charged with the storage, issue, and maintenance of all ammunition in the

air-base ammunition RP. When airdrome platoons are not available, this section performs prescribed delivery service.

(5) *Airdrome section*.—This section consists of three enlisted men. The number of sections in a company is dependent on the number of units to be served. One such section is authorized for each observation squadron, transport squadron, and each Army Air Forces headquarters, except the headquarters squadrons of the air base, bombardment and pursuit groups.

b. Ordnance company, aviation, bombardment (T/O 9-157).—Authorized on the basis of one per bombardment group. The company is organized and equipped to provide prescribed ordnance service to a bombardment group and its related reconnaissance squadron. The company is divided as follows:

(1) *Company headquarters*.—Performs usual company administrative duties.

(2) *Airdrome section*.—Furnishes ordnance service for the headquarters squadron of the bombardment group.

(3) *Airdrome platoon*.—There are normally four of these platoons, one for each bombardment squadron (usually three), and one for the related reconnaissance squadron. The platoon is organized and equipped to provide the prescribed ordnance service to a bombardment or reconnaissance squadron. When required it can perform this service for a single squadron at a dispersed airdrome.

c. Ordnance company, aviation, pursuit (T/O 9-157).—Authorized on the basis of one to each pursuit group. This company is organized and equipped on the same principles as the bombardment company. It consists of a company headquarters, an airdrome section, and one airdrome platoon for each pursuit squadron (normally three). When required, the platoon can provide the prescribed service for a single squadron at its dispersed airdrome.

CHAPTER 6

ORDNANCE SERVICE IN THE THEATER OF OPERATIONS

	Paragraphs
SECTION I. General.....	41-46
II. Communications zone.....	47-52
III. Regulating station.....	53-56
IV. Combat zone.....	57

SECTION I

GENERAL

■ **41. MISSION OF ORDNANCE DEPARTMENT.**—The mission of the Ordnance Department in the theater of operations is the supply and maintenance of prescribed articles, including generally all arms, armament, ammunition, tanks, special ordnance vehicles, and other equipment and supplies issued by the Ordnance Department.

■ **42. GENERAL.**—*a. Theater of operations.*—The theater of operations comprises that area of the theater of war in which military operations are, or may be, conducted (see fig. 6). Initially, in a campaign, the theater of operations may include only a combat zone, installations and facilities of the zone of the interior being utilized for the service of the combatant troops. However, as soon as the demand is such that all of the territory gained is not required for combat operations, a communications zone is organized.

b. Functions of commander.—The commander of a theater of operations, in addition to his many other functions, is responsible for the provision and distribution of supplies, the conduct of maintenance operations, and the control of all means of transportation within the theater of operations. He organizes the system of supply in the manner best suited to the performance of its function.

c. Communications zone.—The communications zone comprises that portion of the theater of operations containing the principal establishments of supply and evacuation and other agencies required for the continuous service of the forces in the combat zone. In some instances the communications

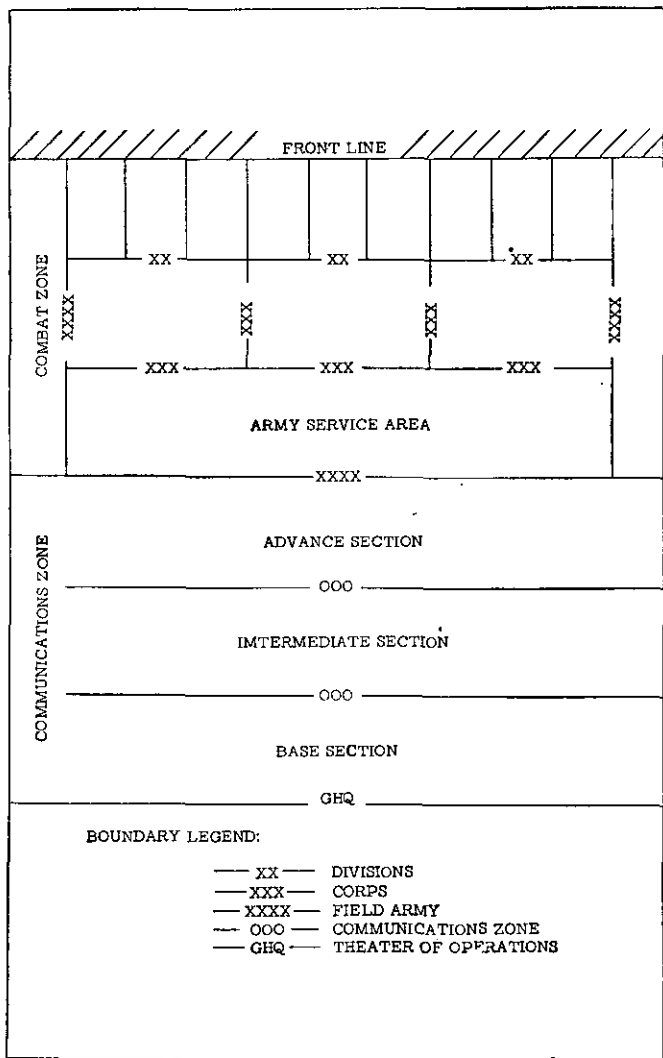

FIGURE 6.—Type of geographical organization of the theater of operations.

zone may become so extended in depth as to make further subdivisions desirable. Figure 6 shows the communications zone divided into advance, intermediate, and base sections. The base section may be further subdivided. In this case the sections are numbered, for example, "Base Section No. 1," "Base Section No. 2," etc.

d. Combat zone.—The combat zone comprises the forward area of the theater of operations. It should embrace only the territory required for active operations and the necessary supply and evacuation establishments for the immediate supply of troops in the combat zone. It is divided into army areas. The forward part of each army area is divided into corps areas and these in turn into an area for corps troops and division areas. Each army, corps, and division area covers the zone of operation of the unit to which it pertains and is under the control of the commander thereof. The army service area covers that territory between the rear boundaries of the corps and the rear boundary of the combat zone. The mass of the army establishments and the army service troops are usually located in this area.

■ 43. ORGANIZATION.—The initial personnel for this office will be prescribed by the commander of the field forces, and its subsequent expansion will be in accordance with the directives of the theater commander.

■ 44. FUNCTIONS.—*a.* The ordnance officer is charged with the supervision and control of ordnance service in the theater of operations. The method of control employed depends primarily upon—

- (1) Strength and equipment of the forces in the theater of operations.
- (2) Character of the operations.
- (3) Distance from the zone of the interior.
- (4) Capacity, availability, and character of transportation facilities, and their relation to the operations contemplated.
- (5) Availability of local resources.

b. The ordnance officer is responsible to his commander for the organization of ordnance facilities and supplies so that tactical or strategical plans are neither hindered nor handicapped. His specific duties include those listed under paragraphs 4 and 5.

■ 45. RESPONSIBILITIES.—The ordnance officer of the theater of operations exercises general technical direction of the ordnance service as a whole. He is responsible to the theater commander for the following operations:

a. Preparation of a plan for the organization of ordnance service in the theater, and its expansion in conformity with the general organization plan and approved priorities.

b. Efficient operation of the ordnance service as a whole.

c. Establishment and maintenance of simplified and uniform methods of administration, operation, and procedure for all ordnance activities in the theater of operations.

d. Coordination of ordnance operations in subordinate commands.

e. Recommendations for new, improved, or special types of ordnance supplies to meet the particular requirements of the theater of operations.

■ 46. RELATIONSHIP OF ORDNANCE STAFF OFFICERS.—The ordnance staff officer, theater of operations, exercises control over ordnance activities through the ordnance officer, communications zone; the ordnance officers at the regulating stations; and the army ordnance officers. Figure 7 shows the relationship of these staff officers.

SECTION II

COMMUNICATIONS ZONE

■ 47. MISSION.—The purpose of ordnance service in the communications zone is to provide the necessary bridge in ordnance activities between the zone of the interior and the combat zone. It must provide the combat zone with ordnance matériel in accordance with the plans of the commander of the field forces. It must provide the means for evacuating unserviceable ordnance matériel from the combat zone and undertaking the necessary repair and salvage thereof, in order to minimize shipments to the theater of operations. Further, it must exploit to the maximum, all existing facilities and sources of supply within the geographical limits of the communications zone. Finally, it must insure the provision of properly trained ordnance personnel for both the combat zone and the communications zone.

ORDNANCE DEPARTMENT

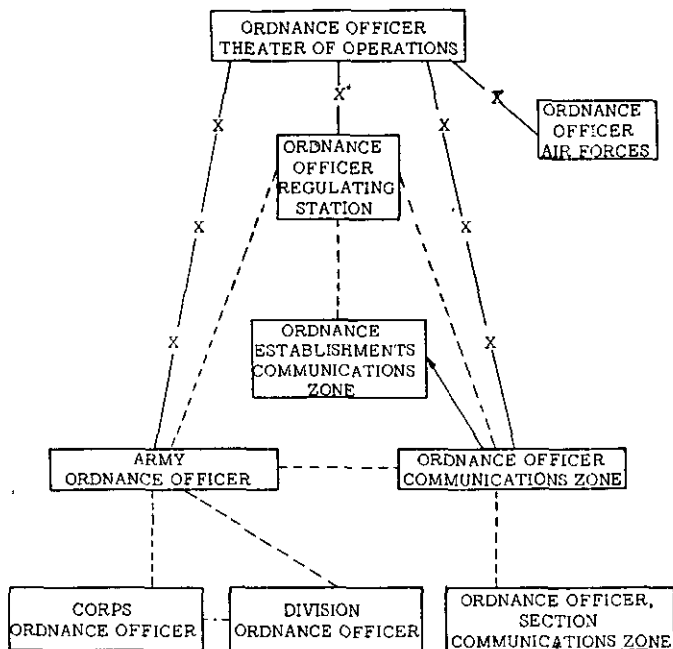

LEGEND

- X — CHANNEL OF TECHNICAL SUPERVISION AND CONTROL USUALLY INVOLVING QUESTIONS OF GENERAL POLICY REQUIRING ACTION OF COMMANDER IN CHIEF.
- - - CHANNEL FOR NORMAL TECHNICAL AND SUPPLY OPERATIONS, ALSO FOR INFORMATION AND REPORTS.
- COMMAND CHANNEL (EXCEPT FOR ORDNANCE SECTIONS OF COMMUNICATIONS ZONE GENERAL DEPOTS, WHERE IT BECOMES A TECHNICAL CHANNEL).

FIGURE 7.—Relationship of ordnance staff officers in the theater of operations.

■ 48. GENERAL.—*a. Composition of communications zone.*—The communications zone contains the administrative establishments required to serve the theater of operations as a whole. It constitutes the base of operations for the army. The communications zone is organized in depth. Initially, it may consist of a base section only, and may be followed later by those of the advanced and intermediate sections in the order named.

b. Establishment of communications zone.—Conditions may arise in the initial phases of a campaign which will permit operations directly between the zone of the interior and the combat zone without an intervening communications zone. However, the early establishment of the communications zone, even though it is of slight depth, is a guiding principle. When only the advanced section is established, depots of the zone of the interior must function as base depots.

c. Function of base and forward depots.—Supplies arriving in the theater of operations from the zone of the interior, or local sources, are usually classified in the rear depots. The forward depots contain the balanced stocks necessary to meet promptly the immediate needs of the troops. Depots in the base section receive supplies as delivered or procured. While economy would indicate that balanced stocks should also be maintained at base depots, expediency indicates otherwise. However, every effort is made to maintain the prescribed level of supply in base depots in completely balanced items, while carrying unbalanced quantities of various items in excess of this level. *C 2*

d. Functions of intermediate section.—The intermediate section is usually the last established. It normally is the most extensive. In it are placed the establishments necessary to give flexibility to the supply and evacuation system. It usually performs the function necessary for the communications zone to maintain itself.

■ 49. ORGANIZATION.—*a. Elements available to ordnance officer.*—It will be presumed for the treatment of all phases of the work of the ordnance officer of the communications zone, that the zone is divided into the three sections; advanced,

intermediate, and base. The ordnance officer of the communications zone has available to him in the execution of his duties, all ordnance personnel and facilities specifically assigned to the zone.

b. Section ordnance staff officers.—When the communications zone is completely organized into sections, there is an ordnance staff officer on the staff of the commander in each section of the communications zone. The functions of these ordnance staff officers will normally be confined to their duties as ordnance staff advisers to the commanders of the respective sections, supplemented by responsibility for providing ordnance service for all troops located within the territorial limits of their particular sections. These ordnance officers are not involved in the operations of any ordnance establishments which have functions other than those of local ordnance supply and repair.

c. Ordnance establishments in communications zone.—The establishments which comprise the principal agencies of ordnance service in the communications zone are the ordnance supply depot, the ordnance sections of general depots, the ordnance ammunition depots, and ordnance shops. When the communications zone is subdivided, these ordnance agencies are named to indicate the section in which they are located, such as, "intermediate ordnance supply depot," "base ordnance shop," etc. Ordnance depots and ordnance sections of general depots, as well as ammunition depots and ordnance shops of all types, are established in the various sections of the communications zone in conformity with the approved ordnance project for the theater, and in accordance with the approved plan of the commanding general of the communications zone.

■ 50. RESPONSIBILITIES OF ORDNANCE OFFICER, COMMUNICATIONS ZONE (fig. 8.)—The ordnance officer of the communications zone must perform the same type of functions as the ordnance officers of higher echelons. In carrying out these functions the ordnance officer of the communications zone must perform the following duties:

a. Maintain stocks of ordnance supplies at the levels prescribed by the theater commander.

b. Take the necessary measures to insure the equalization of stocks between depots.

c. Control the repair operations of all ordnance shops of the communications zone, including the reception, classification, and assignment for repair of all ordnance matériel evacuated from the combat zone by the ordnance service of the armies, or released to the ordnance service of the communications zone by the central salvage agency of that zone (if such agency is established).

d. Supervise and control, subject to the direction of the theater ordnance officer, all ordnance training activities conducted in the communications zone, including the operation of the various ordnance training facilities associated therewith.

e. Require the maintenance of ordnance supply records in such form that prompt reports may be made, when required, concerning the kind, quantity, location, and condition of ordnance supplies available for distribution by the communications zone; and as a corollary, report to the commander of the communications zone all items of ordnance supply with reference to which special attention is required.

f. Procure ordnance personnel adequate to the efficient functioning of ordnance depots, ordnance sections of general depots, and ordnance shops of the communications zone.

g. Prepare instructions for the quartermaster salvage service concerning the disposition of ordnance matériel salvaged by that service.

h. Provide for the inspection of ordnance matériel in the hands of troops in the communications zone and the reequipping of these troops, as directed by the commander of the theater of operations.

■ 51. FUNCTIONS OF COMMANDING OFFICERS OF ORDNANCE ESTABLISHMENTS.—*a. Ordnance sections of general depots.*—Officers in charge of ordnance sections of general depots are responsible for—

(1) Reception, classification, storage, maintenance, and issue of all ordnance supplies.

(2) Operating control of the personnel assigned to the section.

(3) Supply records pertaining to the section.

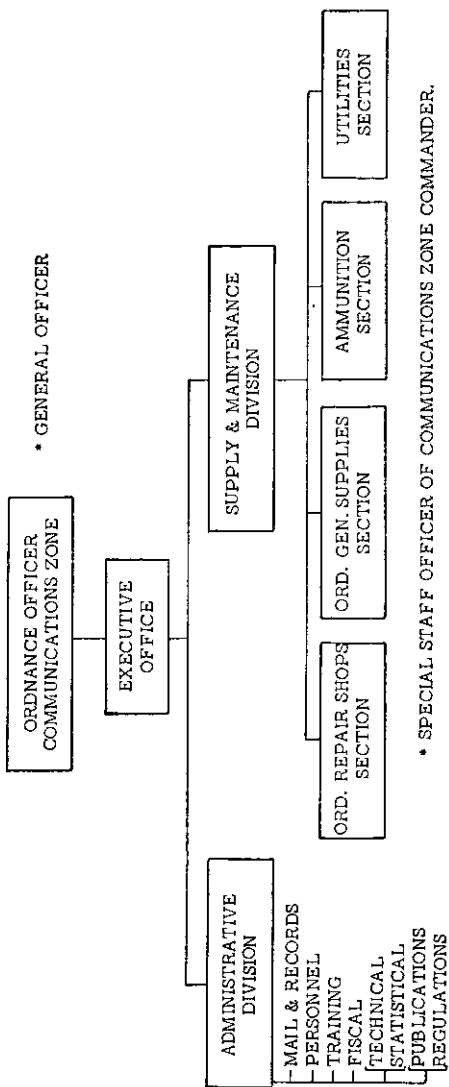

(4) Supervision of the loading and unloading of ordnance supplies.

(5) Proper marking of all shipments.

(6) Necessary arrangements with transportation agencies of the depot for shipments.

(7) Timely transmission, through prescribed channels, of information with respect to shipments.

b. Ordnance general supply depots.—Commanders of ordnance general supply depots and ammunition depots are assigned by the commander of the communications zone on the recommendation of the ordnance officer, communications zone. The duties of these commanders are the same as those of commanders of sections of general depots in addition to those of the commanding officer of a station. (For details pertaining to the operation of a general supply depot, see FM 9-25.)

c. Ammunition depots.—In addition to the provisions of *a*(1) and (2) above, the commanders of ammunition depots, when preparing shipments of ammunition destined for combat zone establishments, will forward to the ordnance officer of the destination, in advance of the shipment, information as to the exact loading of each car, including the lot numbers of all ammunition and ammunition components. An ordnance noncommissioned officer should accompany each train-load shipment of ammunition sent into the combat zone. (For details pertaining to the operation of ammunition depots, see FM 9-20.)

d. Ordnance shops.—The commanding officers of ordnance shops of the communications zone are responsible to the ordnance officer of the communications zone for the proper functioning of their shops and of the personnel assigned thereto. (For details pertaining to the operation of ordnance shops, see FM 9-10.)

■ 52. OPERATION OF DEPOTS.—*a. Control of stockages and issues.*—The organization and administration of communications zone depots are direct responsibilities of the ordnance officer, communications zone. Their operation is in conformity with the ordnance provision system regulations. Stocks are prescribed by the commanding general, communications zone, and replenishment thereof is effected according to plans

and methods prescribed by him. Likewise, issues are directed by the same officer. Depots may be directed to make issues upon requisition from the ordnance officer, regulating station, army ordnance officers, or ordnance officers of sections of the communications zone. These issues may be made in one of two ways; either specific items or groups of items of which there is no prospective shortage can be made available for issue upon requisition by these officers, or definite quantities of specific items may be placed to the credit of these officers. When such credits are established, sufficient supplies must be kept in stock to meet them. When shipments are to be made to the combat zone, arrangements are made with the regulating station for clearance. For type organization of an ordnance depot see figure 9.

b. Personnel.—The personnel required for these establishments varies with the volume of supplies handled. (See par. 107.)

c. Location and construction of depots.—In the actual location of storehouses and sites for open storage, proper consideration must be given to the local character of the terrain in order that requirements as to minimum distances for railroad construction and between storage sites are complied with. The construction work of ordnance and ammunition depots such as erecting storehouses, sheds, and railway trackage, is a function of the corps of engineers. Such construction is done according to plans furnished by the Ordnance Department.

d. Communication and lighting facilities.—Proper telephone communication between the main office, the groups or sub-depots, and all important centers should be installed. In order that receipts and issues may be made at night, all storage points are provided with the necessary electric lights. A master switch under the control of the main office should control all lights of the depot.

e. Provisions for air defense.—Consideration will be given to provisions for air defense, such as camouflage and the construction of necessary trenches or dugouts for the protection of personnel.

f. Protection against fire.—A fire marshal will be appointed for the depot. It is his duty to see that the necessary equip-

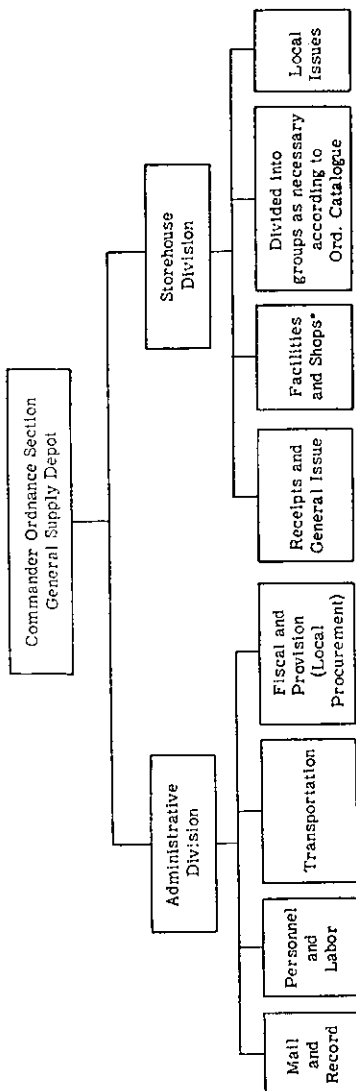

NOTE: This type organization is applicable for the Ordnance Section of a general supply depot.

* The facilities and shops section is that part of the storehouse division which furnishes supplies for the repair shops in the area of the communications zone served by the depot.

FIGURE 9.—Type organization for an ordnance depot (general supply).
communications zone.

ment is obtained and properly placed for fire protection of the establishment. He is responsible that instructions and orders for fire prevention and control are promulgated.

SECTION III

REGULATING STATION

■ 53. **GENERAL.**—The regulating officer commands the regulating station. He is the direct representative of the theater commander. He controls all rail movements forward, either of advance depots of the communications zone, or of holding and reconsignment points between these depots and his station. No movement may be initiated in his zone of responsibility without his authority. He is responsible for the systematic and orderly movement of supplies and replacements to the combat zone, and for evacuation to the rear of unserviceable and salvaged ordnance materials. Based on recommendations of army commanders and policies of the theater commander, he establishes and enforces traffic priorities and designates locations of railheads or truckheads in the combat zone. He provides for the distribution of returning cars to depots in the rear.

■ 54. **MISSION.**—Ordnance service at the regulating station is charged with providing ordnance technical information to the regulating officer and the members of his staff, and with the handling of details of ordnance service at the station.

■ 55. **DUTIES OF ORDNANCE OFFICER.**—The senior ordnance officer on the staff of the regulating officer is the direct representative of the ordnance officer, theater of operations. He is in charge of the ordnance section. His specific duties include the following:

a. In the name of the regulating officer, he makes all calls on communications zone depots for shipment of ordnance supplies into the combat zone in accordance with requests made on him by army ordnance officers and priorities established by the regulating officer.

b. Under the direction of the regulating officer he will provide ordnance personnel to accompany each ammunition train into the army service area.

c. He is responsible for the timely presentation to the transportation section of ordnance requirements for rail transportation.

d. He will make recommendations to the regulating officer as to priority in shipment of ordnance supplies.

■ 56. OPERATIONS.—Ordnance personnel assigned to a regulating station operate the ordnance section of the office of the regulating officer (see fig. 10). This section receives requests for ordnance supplies from the army, transmits the tonnage, car, or train requirements to the transportation section, follows up the arrangements made for shipping, and notifies the army when shipments may be expected. Since a regulating station is primarily a traffic control agency, ordnance depots for general supplies, or for ammunition, should not be located thereat. The transloading of ordnance supplies for storage and issue is not a normal function of the regulating station and, if handled by this station, will cause such congestion as to defeat the object of the establishment. Shipments of ammunition or large shipments of ordnance general supplies to one organization are made, if possible, in one shipment. Under these circumstances, depots in the communications zone load complete shipments of supplies and such shipments are moved without delay directly through the regulating station, or preferably around it, to depots or other supply points. In no case are ammunition trains held at regulating stations. Mobile reserves of ammunition should be located a few miles away from the station itself.

SECTION IV

COMBAT ZONE

■ 57. COMBAT ZONE.—The combat zone, which includes all the area forward of the communications zone, constitutes an integral part of the theater of operations and should properly be treated in this section. Because of its relatively great importance, however, the whole of chapter 7 has been devoted to discussion of the combat zone.

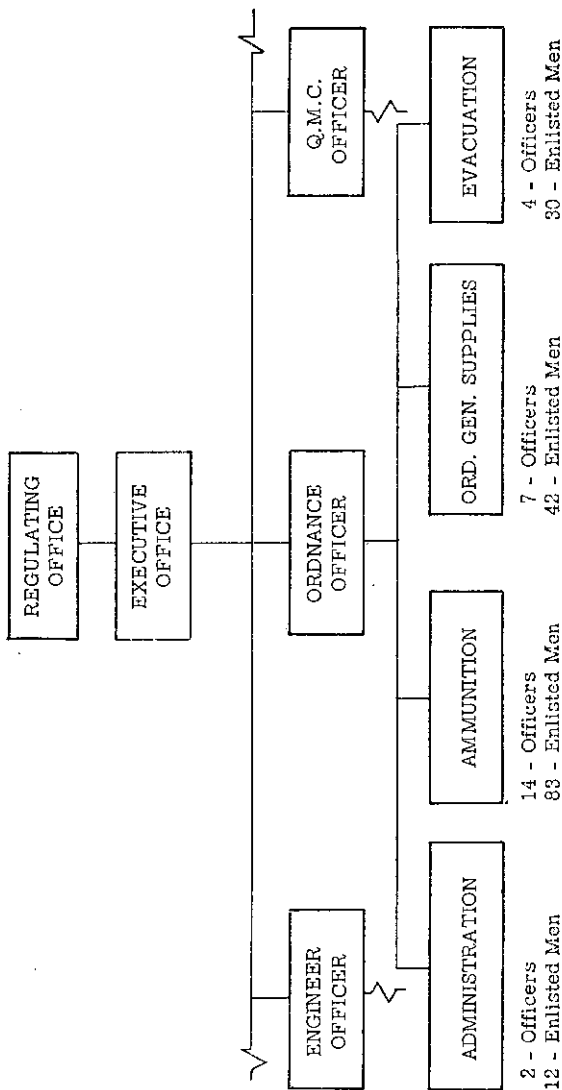

FIGURE 10.—Ordnance officer, regulating station (suggested organization and personnel to supply one type field army).

CHAPTER 7

ORDNANCE SERVICE IN THE COMBAT ZONE

	Paragraphs
SECTION I. In the army.....	58-63
II. In the corps.....	64-71
III. In the division.....	72-84

SECTION I

IN THE ARMY

■ 58. MISSION.—The army ordnance service is charged with the provision for and distribution, within the army, of ammunition and other supplies issued by the Ordnance Department, and the accomplishment of such repairs to ordnance matériel as are within the capabilities of the facilities at its disposal.

■ 59. SCOPE OF ACTIVITIES OF ARMY ORDNANCE OFFICER.—The army ordnance officer is the army munitions officer, and as a member of the special staff of the commander of the army, has all of the duties of a staff officer. He must carry out his functions in pursuance of the plans of the commander. He should maintain close liaison with the theater ordnance officer. He is responsible for planning the ordnance maintenance and supply operations within the army. He puts these plans into operation when approved. He commands the army ordnance troops and has technical supervision over ordnance service in lower echelons. His normal post is at the forward command post of the army.

■ 60. RESPONSIBILITIES AND DUTIES.—*a. Responsibilities.*—The general duties and responsibilities of ordnance staff officers are covered in chapter 2. The army ordnance officer is specifically responsible to his commander for—

(1) Timely provision for ordnance maintenance and supply requirements of the army, in accordance with tactical plans.

(2) Recommendations upon which the ordnance section of the army G-4 plan is based.

(3) Provision of technical information and advice to the commander.

(4) Execution of the army G-4 plan, insofar as ordnance is concerned, including the command of ordnance troops and installations in the army area not assigned or attached to subordinate commanders.

(5) Establishment and operation of the necessary depots to carry out the ordnance supply plan in order to place ordnance supplies within practicable haul of front line divisions and corps.

(6) Establishment and operation of the necessary field shops to execute the ordnance maintenance plan.

~~(7) The maximum exploitation of enemy ordnance resources and matériel.~~

b. *Duties.*—In meeting his responsibilities, the army ordnance officer must—

(1) Exercise direct control over the supply, maintenance, inspection and repair of all ordnance matériel in the hands of army troops.

(2) Prescribe the basic loads and levels of stockage for the elements of the army echelon of ordnance service, and insure the coordination of the requirements set up by lower echelons with those prescribed for army agencies.

(3) Make, or cause to be made, such inspections of ordnance troop units, facilities, and (with the approval of the army commander) ordnance matériel in the hands of combat troops, as he may deem necessary. He determines that the proper precautions are being observed in ordnance storage facilities and that the necessary technical information is available and is being strictly complied with.

(4) Except in emergencies, permit no alterations in ordnance equipment without the approval of the theater ordnance officer.

(5) Maintain such records as will enable him to keep the commanding general informed as to the condition and sufficiency of ordnance matériel, as to the ordnance maintenance facilities under his jurisdiction, and as to the status and condition of all ammunition under army control.

(6) Make such technical reports and maintain such additional records as may be required of him by the commanding general.

(7) Take the necessary steps to insure that technical instructions for maintenance, alterations, and repair of ordnance matériel prescribed by the theater commander are properly complied with.

(8) Make timely provision for the ordnance requirements of the army, in accordance with the army tactical plans.

(9) Prepare the ordnance plan and submit to G-4 the ordnance section of the administrative order, and after its approval assume responsibility for the execution of all ordnance phases of this plan.

(10) The daily compilation of the status of ammunition report for submission to G-4 for the information of the commander and the members of the staff.*.

■ 61. PLANNING.—*a. General.*—Planning for ordnance service in the army requires continuous knowledge of the tactical plans of the army and accurate and timely evaluation of the bearing of these plans on the ordnance problem. Ordnance plans must seek to anticipate the changing ordnance requirements of the combat forces and guard against any interruption in ordnance service. These plans should include expedients to meet unexpected contingencies and to insure the maximum utilization of the ordnance troops and facilities in the army area. In order that the plans for ordnance service in the army may succeed as intended, they must satisfy the requirements of simplicity, flexibility and practicability.

b. Governing considerations.—In conformity with the principles outlined above, the actual preparation of the ordnance plan must include consideration of the following fundamental factors. (For a complete check list of army ordnance plans, see appendix I.)

(1) Conformance with the plans of the superior ordnance echelon and coordination with the plans of the other services of the army.

(2) Tactical plans of the army.

(3) Established policies of the army commander and the decisions of G-4 under these policies.

*This report need be only an average of the units of fire of the various items of ammunition used by the army. OFM Form No. 310, illustrated and discussed in FM 9-6, has spaces for the information required.

(4) Determination of the basic units of supply to be employed.

(5) Evaluation and application of all ordnance statistical data available.

c. Plans for units and facilities.—The plans for ordnance service in the army will include the determination of the location of the ordnance units and facilities operating under the control of the army commander, and the general instructions which will be issued to place these agencies in operation. The detailed plan for supply points may be prepared in the office of the army ordnance officer. When experienced operating personnel are available, however, the planning of that office ends with the designation of the site, the time of opening, a statement of the initial stockage or level of supply, and a computation of the additional transportation and labor which are to be furnished. The actual lay-out and operating plans are prepared and executed by the personnel assigned to the depot or other supply point, under the supervision of the army ordnance officer.

d. Details of plans.—Appropriate sections of the army ordnance office are usually charged with the preparation of plans for the supply of ammunition and ordnance general supplies. These plans are governed by the guiding principles indicated above. Plans normally include the following:

(1) Estimate of probable requirements of the army for the operation contemplated.

(2) Number and location of depots or other supply points, together with the initial stock, time of opening, and the units to be supplied by each.

(3) Desired priorities of shipments and recommended time of arrival of trains.

(4) Method of issue and replenishment, including initial credits and instructions concerning reports.

(5) Method and priority of evacuation of unserviceable and captured enemy matériel.

(6) Number and location of repair installations.

(7) Transportation and labor requirements above that which may be provided by army ordnance service.

(8) Special instructions concerning inspections and inspectors.

e. Arrangements with other staff sections.—The executive section of the army ordnance office consolidates certain common requirements of the maintenance and general supply division and the ammunition division and makes arrangements concerning them with other staff sections. These arrangements comprise requests for priorities; recommended times of arrival of trains; requests for construction of shelters, warehousing facilities, standard- or narrow-gage railroad; camouflage; construction and improvement of roads; and requests for transportation and labor to be supplied for other ordnance service.

■ 62. ORGANIZATION AND FACILITIES.—*a. General.*—(The army ordnance service normally consists of an ordnance office, a maintenance and supply battalion, two ammunition battalions, and any attached ordnance troops. Additional ordnance troops are attached to the army in proportion to the combat troops so attached.) Normally, there will be in the army area one or more general supply depots, several shops, at least two ammunition depots, and a number of ASP's. All army supply facilities, general supply depots, ammunition depots and ASP's are numbered serially in a single series.

b. Army ordnance office.—(The normal organization of the army ordnance office is shown in figure 11. A discussion of this organization follows:)

(1) The executive officer performs such duties as may be assigned by the ordnance officer, and acts for the ordnance officer during his absence from headquarters. He must be fully informed on the details of the sections of the office.

(2) (The chief of the operations section must be constantly in liaison with the army G-2, and G-3, in order to keep abreast of the tactical situation.) He must maintain, on an operations map, an up-to-date record of the disposition of ordnance facilities and troops of the army ordnance service and the lower echelons. He also keeps a file of G-3 operations orders, and furnishes at intervals to ordnance troops as much of this information as is necessary to enable subordinate ordnance units to execute their present mission and to make plans for future operations. This information must be supplied to the army ordnance officer at frequent intervals.

(3) (The maintenance and general supply section has general supervision of ordnance maintenance operations and the flow of general supply.) It has direct control of maintenance and general supply activities in the army ordnance service echelon and supervisory control over similar ordnance service in lower echelons.

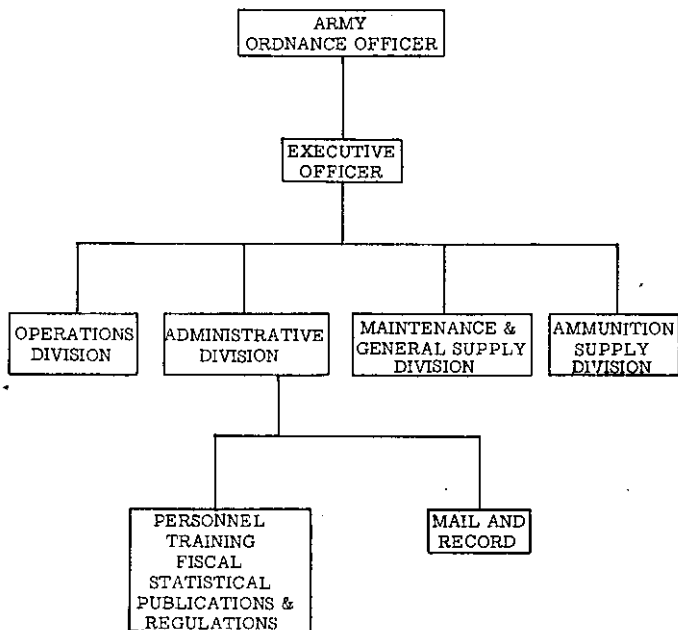

FIGURE 11.—Organization of army ordnance office.

(4) The ammunition supply section functions, in relation to ammunition supply, in a manner similar to that of the maintenance and general supply section.

(c) *Maintenance and supply battalion.*—The detailed organization of the maintenance and supply battalion is given in Table of Organization No. 9-115. This battalion establishes ordnance general supply depots and shops in the army service area. The nature and quantity of supplies to be stored in the

depots require a certain amount of covered storage, preferably with easy access to railroad facilities. There is also required a certain amount of open storage for vehicles and other items which cannot be put into buildings. Frequently, groups of ordnance items will be stored in, and issued from, separately located depots or sections of the main depots. Depots should be as readily movable as is consistent with the facilities available. Normally, there will be several shops, one specializing in maintenance of automotive equipment, one specializing in the maintenance of antiaircraft equipment, and one for general purposes. This arrangement may be varied to meet actual conditions encountered. The battalion will evacuate disabled equipment left by advancing elements and will dispatch to corps ordnance battalions and army troops such contact parties as may be required. All of the work of the battalion is done under the direct supervision of the battalion commander. (See FM 9-10.)

d. Ammunition battalion.—The detailed organization of the ammunition battalion is given in Table of Organization No. 9-15. Each of the two battalions is assigned a subarea within the army area of the combat zone, in order that the depots and the ASP's operated by the companies of each battalion may be properly located and supervised by the battalion commander. Each battalion will operate at least one ammunition depot and several ASP's within the area. The depot is normally located in the army service area and not more than 30 miles from the front. It must be on the best road net obtainable, with access to the front and rear, and should be as near as possible to the railroad or other transportation facilities from which it is to be restocked. This depot will normally contain army reserves and such other ammunition arriving in the combat zone as cannot be transported directly to the ASP's. The ASP's are normally located laterally and in depth within the corps service areas or within the division service areas, at a distance of from 8 to 20 miles from the front, and so placed that trucks from the troops being served may make a round trip during the hours of darkness. In the establishment of ASP's consideration must be given to such matters as the range of medium artillery, the available road net, the requirements for camou-

flage, and other principles, all of which are fully discussed in FM 9-6. Some of these supply points are stocked to serve artillery units, others are stocked to serve infantry and other units. In general, no one supply point will be assigned specifically to any one combat unit. In a type army, five ASP's per corps can normally be operated by the organic ordnance ammunition troops. (See FM 9-20.)

■ 63. OPERATIONS.—*a. Administrative details of ammunition supply.*—(1) *Allocations of credit and stockages.*—The army ordnance officer, as army munitions officer, receives from the theater of operations headquarters, allocations of credit for specific amounts of ammunition in one or more depots of the communications zone. He reports the total quantity of ammunition to G-4 and the quantity of artillery and aircraft ammunition to the proper special staff officers of the army. These officers consider with G-3 the tactical plan and determine the proper apportionment of ammunition to be held in reserve and to be given to each tactical unit. At this time the army ordnance officer requests each corps ordnance officer to designate locations for ASP's and to indicate what units are to be served by the various ASP's. He makes requests on the regulating officer for the quantities of ammunition to be moved into army depots and ammunition supply points in accordance with these apportionments and the distribution of the army reserve. He then issues allocations of credit to the munitions officers of the units for which the apportionments are intended, with copies to each interested depot. In the army, allocations of credit are given to army troops and the several corps.

(2) *Reports.*—The army commander prescribes the duration and closing hour of the reporting period, and the time at which the reports must reach his office. The combat units submit ammunition reports (OFM Form No. 303 or 304), showing expenditures and quantities in hands of troops. The depots and ASP's submit status of stocks reports (OFM Form No. 306). From these reports the ammunition situation within the army is determined and reported to interested general and special staff officers in order that proper request may be made of the theater commander for additional allocations of credit, if credits have not already been provided. A report

(OFM Form No. 310) is submitted to theater headquarters as indicated in paragraph 27c(3). This completes the ammunition cycle.

b. *General supplies.*—General supplies are provided in accordance with the plans of higher authorities and specific quantities are made available to the army by shipping orders or credits on specific depots in the communications zone or the zone of the interior. The army depot commander is advised of the types and quantities of materials to be received on shipping orders and the level of stockages prescribed in the ordnance plan. The depot commander will prepare requisitions against the credit in the communications zone to maintain the proper stock level in his depot as prescribed in the ordnance plan. These requisitions are sent to the regulating officer through the army ordnance officer. Under instructions from the army ordnance officer the depot commander will, in the name of the army ordnance officer, act on and make issues on requisitions from the troop units of the army. Stores reports in the form of duplicate copies of papers covering all receipts and issues will be submitted by the depot to the army ordnance office. By means of these reports the army ordnance officer is kept informed of the current status of stocks in the depot. The depot commander will notify the army ordnance officer whenever the status of any items becomes critical.

c. *Maintenance.*—Periodic reports of the work performed and the status of work currently in the shops will be submitted by maintenance company commanders through the battalion commander to the army ordnance officer. Whenever the status of material in the shops of lower echelons is such that the condition requires action by the army ordnance officer, special reports of such conditions will be submitted direct to that office. The army ordnance officer may, from time to time, require the submission of consolidations of unfilled requisitions by lower echelons. (All ordnance maintenance throughout the army will be supervised by the army ordnance officer assisted by the commanding officer of the maintenance and supply battalion.) The standards of maintenance will be prescribed by the army ordnance office and enforced through inspections. Maximum advantage

will be taken of the maintenance facilities of the army to effect repair of ordnance matériel, including captured enemy matériel. Matériel that cannot be repaired by army ordnance personnel will be evacuated to the communications zone through the proper channels in accordance with directives from the army and theater commanders. Modifications of ordnance matériel will not be made without proper authority, but when authorized, as much of this work as possible will be done in the army service area.

SECTION II

IN THE CORPS

■ 64. MISSION.—The mission of ordnance service in a corps acting alone is the same as in the army. The mission of the Ordnance Department in a corps as part of an army is to provide ordnance service for corps troops, and assigned or attached divisions and other troops.

■ 65. SCOPE OF ACTIVITIES OF CORPS ORDNANCE OFFICER.—The corps ordnance officer is the munitions officer of the corps, and as a member of the special staff of the corps commander has all of the duties of a staff officer. He must carry out his function in pursuance of the plan of the corps commander. He should maintain close liaison with the army ordnance officer. He is responsible for planning the ordnance maintenance and supply operations within the corps. He puts these plans into operation when approved. He commands the corps ordnance troops. His normal post is at the forward command post of the corps. The responsibilities and duties of the corps ordnance officer correspond with proper modification to those described in paragraph 60 for the army ordnance officer.

■ 66. PLANNING.—The planning of ordnance service in the corps is similar in character to that in the army. The same basic considerations as in the army must be taken into account in the formulation of the corps ordnance plan. This subject is fully discussed in paragraph 61.

■ 67. ORGANIZATION AND FACILITIES.—The corps ordnance service (see fig. 12) normally consists of an ordnance maintenance battalion (T/O 9-75) and any attached ordnance

troops. The ordnance battalion will normally be adequate to the ordnance maintenance requirements of an army corps comprising three infantry divisions and corps troops. Whenever the army corps is reinforced by additional tactical elements, a proportionate increase in ordnance personnel must be made by attachment from army or theater reserve. In addition to the facilities established by the ordnance battalion, each corps is provided with ammunition service through ASP's established and operated by the army ordnance service in accordance with recommendations made by the corps ordnance officer.

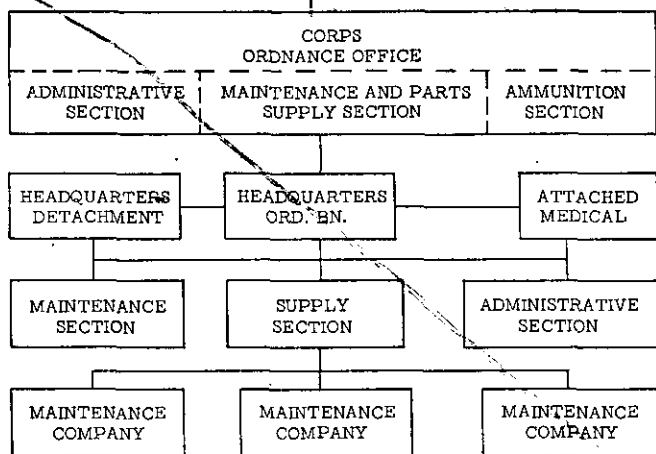

(FIGURE 12.—Organization of corps ordnance service.)

■ 68. CORPS ORDNANCE OFFICE.—(The corps ordnance office is divided into three principal sections: the ammunition section, the administrative section, and the maintenance and parts supply section.)

a. Ammunition section.—The ammunition section is responsible for all administrative details pertaining to the ammunition supply plan of the corps as prescribed in FM 9-6. This includes the preparation of recommendations to the

army ordnance officer concerning the desired locations of ASF's for supplying the divisions of the corps and corps troops.

b. Administrative section.—The administrative section performs the same functions as those performed by the operations and administrative divisions of the army ordnance office. These will include—

- (1) Maintenance of an ordnance operations map.
- (2) Assembly and correlation of ordnance operational data.
- (3) Maintenance of necessary files.

c. Maintenance and parts supply section.—This section will normally perform the same functions for corps ordnance service as the corresponding division of the army ordnance service performs in the army ordnance office.

■ 69. **ORDNANCE MAINTENANCE BATTALION.**—*a.* The ordnance maintenance battalion is responsible for—

- (1) Inspection and maintenance of ordnance matériel in the hands of corps troops.
- (2) Provision of ordnance general supplies for the normal operating requirements of the corps.
- (3) Support of the activities of the ordnance section of the divisions of the corps.

b. This battalion must operate the ordnance field shops of the corps and furnish the necessary contact parties to carry ordnance service to units of the corps, and to support the contact parties of the divisions. The adequacy of ordnance service within the corps as regards maintenance is dependent on cooperation between the ordnance sections of the divisions and the maintenance companies of the corps ordnance battalion. The maintenance battalion of the corps receives maintenance and supply support from the maintenance and supply battalion of the army. It will prepare data required by the corps ordnance officer to keep the army ordnance service informed on the status of the maintenance and general supply in the corps. The manner in which the ordnance battalion of the corps will carry out its functions is prescribed in FM 9-10.

■ 70. **GENERAL SUPPLY.**—The ordnance battalion of the corps carries reserves of supplies in the organic transportation of

the companies of the battalion. In general, the stock level maintained will be sufficient to provide the necessary continuity in the maintenance operations of the corps ordnance battalion and the ordnance sections of the division.

■ 71. **AMMUNITION SUPPLY.**—*a. Establishment of ASP's.*—At the commencement and during the progress of operations the corps ordnance officer will be prepared to submit to the army ordnance officer recommendations concerning the location of ASP's to serve the various units of the corps and the stockages of ammunition, by quantities and types, in the various ASP's. This recommendation will normally be prepared after conference with the proper general and special staff officers.

b. Receipts of credit.—Ammunition is supplied to the army corps through ASP's established and operated by units of the army ordnance service. The corps ordnance officer as corps munitions officer receives allocations of credit for definite amounts of ammunition in the several ASP's in the area of the corps. He reports the total quantity of ammunition to G-4, and the quantities of artillery and aircraft ammunition to the proper special staff officers of the corps. These officers, along with G-3, consider the tactical plans and determine the proper apportionment of ammunition to be held in reserve and to be given to each tactical unit.

c. Reallocations of credit.—In accordance with the decision of the general and special staff officers concerned, the ordnance officer then issues allocations of credit to the munitions officers of the units for which the apportionments are intended, with copies to each interested depot. In the corps, allocations of credit are given to corps troops and to the several divisions.

d. Reports.—At the close of the reporting period the combat units submit ammunition reports (OFM Forms Nos. 303 and 304) showing expenditures and quantities in the hands of troops. From these reports and the status of the corps reserve, the ammunition situation within the corps is determined and reported to interested general and special staff officers in order that a proper request may be made of the army commander for additional allocations of credits.

A report (OFM Form No. 304) is submitted to army headquarters as prescribed in paragraph 27c(2).

SECTION III IN THE DIVISION

■ 72) MISSION.—The mission of ordnance service in the division involves the handling of the administrative details pertaining to ammunition supply within the division, the supply and maintenance of ordnance matériel within the capabilities of the ordnance section, and the provision of liaison between the combat troops of the division and the facilities and agencies of the corps and army ordnance service.

■ 73. SCOPE OF ACTIVITIES OF DIVISION ORDNANCE OFFICER (DOO).—The division ordnance officer is the munitions officer of the division, and as a member of the special staff of the division commander has all of the duties of a staff officer. He must carry on his functions in pursuance of the plans of the division commander. He should maintain close liaison with the corps ordnance officer. He is responsible for planning the ordnance maintenance and supply operations within the division, and puts these plans into operation when they are approved. (He commands the division ordnance troops. His normal post is at the forward command post of the division. The responsibilities and duties of the division ordnance officer correspond, with proper modifications, to those described in paragraph 60 for the army ordnance officer. As a basis for the adequate control of the operation of the division ordnance service, it will usually be necessary that the division ordnance officer—

a. Maintain certain files, such as correspondence, maps, etc.

b. Maintain an ordnance situation map or chart.

c. Conduct studies of ordnance problems to establish a sound basis for future plans.

d. Gather and correlate ordnance operational data for his own use and for the information of higher headquarters.

■ 74. PLANNING.—The planning of ordnance service in the division is similar in character to that in higher echelons.

The same basic considerations as in the corps or army must be taken into account in the formulation of the division ordnance plan. This subject is fully discussed in paragraph 61.

75. ORGANIZATION AND FACILITIES.—*a. General.*—The ordnance section of division headquarters includes all the ordnance personnel organically available for the execution of the ordnance service missions in the division. Whenever the division ordnance service is confronted with a problem beyond the capabilities of its own agencies, proper liaison will insure a prompt solution by the appropriate corps or army ordnance service agency.

b. Office organization.—The division ordnance office will be subdivided functionally into three coordinate elements: headquarters office of the division ordnance office, the division ammunition office, and the division maintenance and supply office.

(1) The *headquarters office* of the division ordnance office accomplishes the details and the duties associated with the planning for, and the coordination of, the division ordnance service. This element constitutes the immediate control agency of the division ordnance officer in the execution of his functions. It is located at the forward echelon of the division command post.

(2) The *division ammunition office* performs the detailed duties associated with the ammunition supply responsibility of the division ordnance officer. This responsibility involves insuring the continuity of ammunition supply to the combat troops. For details pertaining to this office see FM 9-6.

(3) The *division maintenance and supply office* will handle all the details associated with the maintenance of the ordnance matériel of the division. The three contact parties which function with the combat teams of the division will operate under this office. The location of this office will be governed by the same considerations as governed in the case of the division ammunition office. For details pertaining to this office see FM 9-10.

c. Administration.—The enlisted personnel of the ordnance section of the division are assigned for purely routine administrative purposes to the headquarters and military

police company of the division. The control of this personnel for all other purposes rests with the division ordnance officer. They are not available for detail to other than ordnance duties unless in the opinion of the division commander the circumstances are sufficiently compelling to warrant the consequent sacrifice of efficiency in ordnance service. The organization chart of the division ordnance section is shown in figure 13.

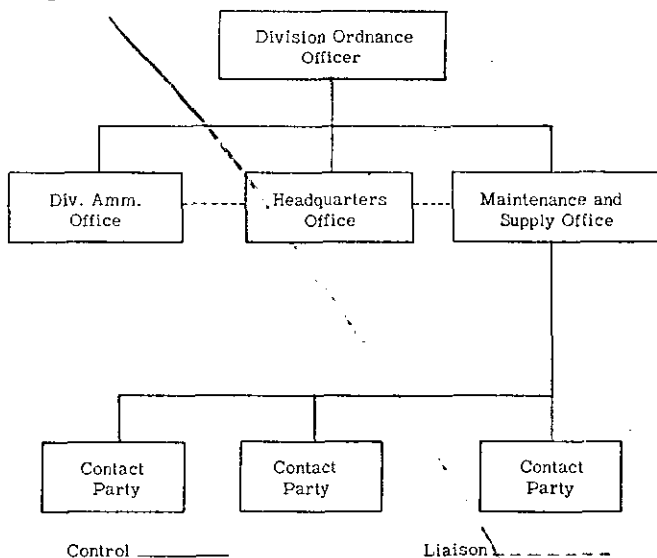

For personnel refer to T/O 7-1 (Ordnance Section)

(FIGURE 13.—Organization of division ordnance service (infantry division).)

■ **76. AMMUNITION SUPPLY.**—Ammunition supply in the division and attached units is based on the following general fundamentals:

a. *Source of ammunition.*—The ammunition for the supply of the division is made available to the division by an allocation of credit from corps headquarters for ammunition in

ASP's established and operated by the army ordnance service.

b. Distribution of ammunition.—Regiments and separate units call upon the division ordnance officer for ammunition required. Following instructions of the division commander the ordnance officer furnishes the unit with orders authorizing the army ammunition supply points to make specified issues of ammunition and to charge them against the credit of the division at the supply point. In some instances the ammunition may be drawn from division dumps or rolling reserves, if such are established.

c. Transportation.—Regiments and separate units normally employ their own transportation. The division may augment the supply to regiments and separate units by employing other transportation under division control.

■ 77. ALLOCATIONS OF CREDITS.—*a. Source.*—Ammunition is usually made available to divisions by allocations of credit from the corps commander. These allocations will specify the army supply point at which the ammunition is available.

b. Use by division ordnance officer.—In order to reduce the volume of paper work that is required in the maintenance of credit records, and to facilitate the procurement of ammunition by the troops, credits are not ordinarily allocated to subordinate units of the division. The division ordnance officer retains on his books the division credits received from the corps and issues orders for ammunition against these credits for the unit combat trains when they require re-supply. These orders may be issued several days in advance of use.

c. Within the division.—The division commander may direct the ordnance officer to allocate ammunition credits to the munitions officer of any unit of the division. This action may be desirable, particularly in the case of the division artillery. A copy of such allocation of credit will be immediately sent to the respective ammunition depots.

■ (78). PROCUREMENT OF AMMUNITION BY COMBAT TROOPS.—*a. Normal procedure.*—Ammunition may be drawn from the army ammunition supply point upon presentation of written request (informal or on OFM Form No. 302) signed by a unit officer and initialed by the division ordnance officer or

by a representative of the division ordnance officer. These requests may be countersigned one or more days in advance of use when the situation permits. The division ordnance officer will give the unit representative the location of the issuing depot and such other information as needed.

b. Emergency procedure.—The foregoing is the normal procedure. When the tactical situation requires it, issues of ammunition will be made without regard to the normal procedure. Such departures will demand judgment and energy on the part of ordnance officers of all echelons to insure that the ammunition supply is handled with speed and efficiency.

■ 79. DIVISION ORDNANCE OFFICER AND AMMUNITION SUPPLY.—

a. Principal duties.—The division ordnance officer has three principal duties relating to ammunition supply:

(1) The application of any control measures over the ammunition supply, as directed by the commander.

(2) The supply of information to the troops concerning the location or the changes in location of existing supply points, and the conditions of or changes in routes to those supply points.

(3) The maintenance of such records and files, and the preparation of such forms and reports as may be required.

b. Tactical situation.—The division ordnance officer must keep in constant touch with the tactical situation of the division and with the plans of the division commander, particularly as to the bearing of these plans on the ammunition supply problem.

c. Ammunition supply situation.—The division ordnance officer must constantly study the ammunition supply situation, particularly with reference to—

(1) Adequacy of stocks available to the division.

(2) Suitability of location of ASP's supplying the division with respect to road nets between division units and the ASP's.

(3) Desirability of maintaining rolling reserves or of establishing division ammunition dumps.

(4) Proper location and employment of the division ammunition office in order that it may function at maximum efficiency in insuring the continuity of ammunition supply to the division.

d. Recommendations to G-4.—The division ordnance officer must be prepared to make timely recommendations to G-4 of the division concerning the above cited subjects.

c. Supervision of rolling reserves and dumps.—The supervision of the operation of the division rolling reserves and dumps (when they become DP's) is the responsibility of the division ordnance officer. He may, when necessary, call on the army ordnance officer through the corps ordnance officer for troops from the army ammunition battalion to operate division DP's.

f. Miscellaneous duties.—The division ordnance officer keeps the records of all allocations and of drafts made therefrom. He receives and acts upon requests for ammunition. He also carries out such other administrative details with respect to ammunition supplies as may be required. He may establish the division ammunition office for this purpose.

■ 80. DIVISION AMMUNITION OFFICE (DAO).—*a. General.*—The division ammunition office is a section of the division ordnance office. It may be physically separated from other sections of the division ordnance office but it is preferable that all sections be located in one position.

b. Records and reports maintained.—The personnel of the ammunition section (DAO) of the division ordnance office maintain the ammunition records and reports of the division. These include the status of ammunition, credits of ammunition within the division, issues made to units, and reports required by higher authority.

c. Information concerning supply points and routes.—The personnel of the division ordnance office must be constantly alert to the development of the tactical situation and its effect on the ammunition supply problem. When occasion demands they will convey critical information concerning supply routes and ammunition supply points directly to the division ordnance officer, or in his absence, to G-4, in order that such information may be made immediately available to the troops.

d. Further information.—Whenever considered necessary, the DAO will not hesitate to send a representative to the various ammunition depots to ascertain the status of stocks allocated to the division; to identify trains from units of the

division; to report any displacement of ammunition supply points and other pertinent information. Information gained in this manner should be made a matter of record, careful attention being paid to dates and times. Such information will be of great value to the division ordnance officer in forming his complete estimate of the ammunition situation, particularly with reference to the quantities actually drawn by units to which orders for ammunition have been issued.

e. Camouflage.—The DAO, and any rolling reserves at or near the DAO, should be so concealed or camouflaged as to protect it as far as possible from terrestrial and aerial observation. They should be located sufficiently close to established roads or trails as to make unnecessary the cutting or marking of new trails by messengers approaching.

f. Communication.—The DAO will be furnished telephone communication with the forward echelon of the division command post. There should be a motor messenger constantly available at the DAO. It is imperative that communication between the DAO and the forward echelon of the division command post be always possible. This is particularly true where constant, close control of ammunition supply agencies is necessary.

g. Signs and markers.—Road signs indicating the location of the DAO should be placed at all crossroads in its vicinity so that unit trains and messengers may locate it easily. Likewise, prominent markers should be placed at its immediate location for the same purpose.

h. Publication of location.—The location of the DAO will be stated in the administrative paragraph of the division field order.

■ 81. MAINTENANCE AND GENERAL SUPPLY.—The maintenance and general supply functions of the division ordnance section are carried out by the maintenance office controlling the contact parties which carry ordnance service to the combat troops of the division. The functions of the maintenance section include—

a. Preparation of all plans for maintenance operations.

b. Preparation of all estimates of parts, major items, and general supplies required as basic loads for the vehicles of the section.

c. Notification of the supporting corps ordnance battalion supply officer, of the requirements of the divisions for ordnance supplies.

d. Institution and prosecution of any follow-up procedure necessary to insure proper supply from the corps battalion.

e. Maintenance of a proper reserve of supplies, and the issue of these supplies to the contact parties and to the troops of the division.

f. Preparation of schedules for the contact parties and keeping of the records of the contacts and inspections made by them.

g. Submission to the division ordnance officer of such reports as may be required by that officer, covering the status of supply and the serviceability of the equipment of the division.

h. Submission to the supporting ordnance battalion, in the name of the division ordnance officer, of requests for such special contact parties as may be required to assist the contact parties of the section.

i. Maintenance, in time of peace or in the zone of the interior, of the records necessary for the proper handling of nonexpendable ordnance supplies issued to the maintenance office.

■ 82. MAINTENANCE OPERATIONS.—The contact parties will make regularly scheduled and emergency visits to the troops for the purpose of providing such ordnance maintenance service as may be required. Maintenance operations of the contact parties will usually extend only to—

a. Inspection of weapons.

b. Accomplishment of repairs to ordnance matériel which are within their capabilities.

c. Issue of ordnance general supplies to the troops.

■ 83. ORDNANCE SERVICE IN INFANTRY DIVISION (SQUARE).—The ordnance service of the infantry division (square) is furnished by a medium maintenance company. When the division is functioning as part of an army corps, the company is detached and placed under the command of the corps ordnance officer, with the exception of an ordnance section which remains as an integral part of division head-

quarters. The function of this section is similar to the function of the ordnance section in the triangular division, as already discussed in this chapter. Four contact parties will be necessary to maintain service to the four combat teams of the square division.

■ '84. REFERENCES.—For a complete discussion of ordnance service in the infantry division see FM 9-10. For the flow of supplies within the theater of operations, see figure 2.

CHAPTER 8

ORDNANCE SERVICE IN THE ARMY AIR FORCES

	Paragraphs
SECTION I. General.....	85-91
II. In an air force.....	92-94
III. In an air base area.....	95-99
IV. At a dispersed airdrome.....	100-101
V. Air service command.....	102-106

SECTION I

GENERAL

■ 85. ORGANIZATION.—This chapter deals with ordnance service in the Army Air Forces including air force units and the air service command. Ordnance service in the Army Air Forces corresponds to ordnance service in an army. There is an ordnance section in the headquarters, Army Air Forces, and in each subordinate headquarters or command. There are in each echelon, the troops required to carry out the prescribed service. See figure 14 for a schematic diagram of the organization of ordnance service in the Army Air Forces.

■ 86. MISSION.—The mission of ordnance service in the Army Air Forces includes—

a. Provision and distribution of all items of ordnance equipment and supply used by the Army Air Forces. This includes delivery of completely assembled bombs and belted machine-gun ammunition to the airplanes of combat squadrons.

b. Maintenance of ordnance matériel, including inspection and repair, or evacuation when repair is beyond the capacity of available facilities and personnel.

c. Provision and distribution of ordnance technical advice and information to all echelons of the Army Air Forces.

(d. Operation of air force ordnance depots and ordnance sections of air force depots, air bases, and distributing points.

e. Destruction of ammunition when ordered.

f. Removal or destruction of duds and delayed-action ammunition when required.

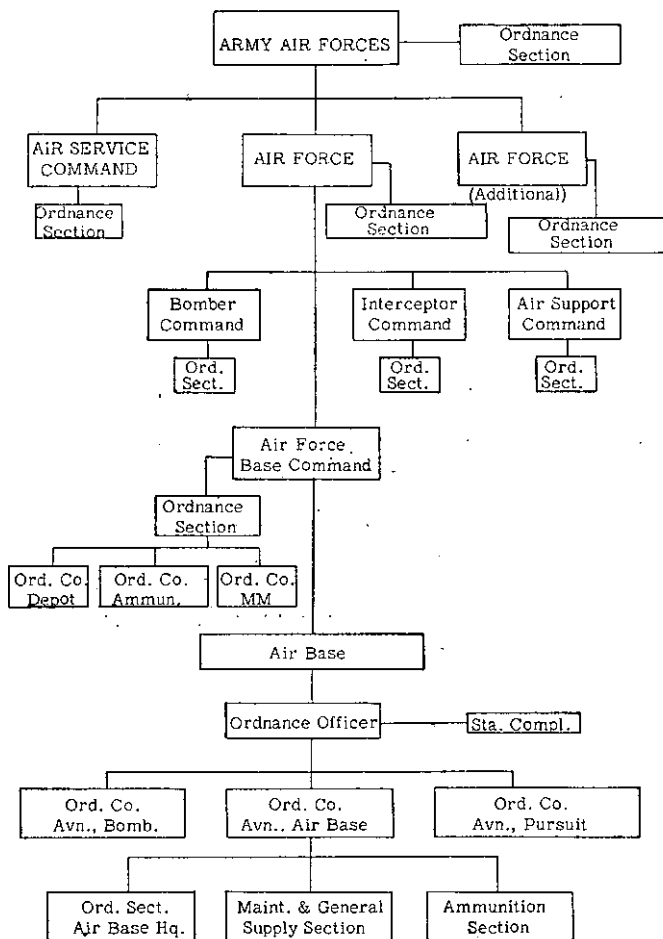

FIGURE 14.—Organization of ordnance service, Army Air Forces.

■ 87. **ORDNANCE SECTION, ARMY AIR FORCES.**—The organization of the ordnance section, Army Air Forces, is shown in figure 15. Normally, there are no ordnance units in this echelon. The following is a brief description of the functions of each section of the office:

a. The *ordnance officer*, Army Air Forces, has the normal duties of an ordnance officer on a special staff.

b. The *control division* exercises administrative control over the entire ordnance section.

c. The *record section* maintains fiscal and civilian personnel records and such other records as may be assigned to this section.

d. The *plans division* is subdivided into two subsections:

(1) The *plans section* is responsible for the preparation of plans and instructions for the training and operations of ordnance units in the Army Air Forces.

(2) The *requirements section* is responsible for the preparation of revisions of Tables of Organization and Tables of Basic Allowances for aviation ordnance troops. It is also responsible for the maintenance of files of technical data pertaining to ordnance equipment and supplies for the Army Air Forces, in addition to the dissemination of such data to subordinate echelons of the Army Air Forces.

e. The *operations division* is subdivided into—

(1) *Supply section*, which is responsible for the collection and maintenance of information on the status of ordnance supplies in all units of the Army Air Forces, and the administration of credits for ordnance matériel and ammunition. Whenever the existing status of supply is unsatisfactory, this section initiates corrective action.

(2) The *ordnance units section* which is responsible for the collection and maintenance of information on the status of assigned ordnance troops as to units, strength, equipment, and state of training. Whenever the existing status is determined to be unsatisfactory this section initiates corrective action.

■ 88. **GENERAL SUPPLY.**—Credit items of general supply allocated to the Army Air Forces are controlled by the

reallocation of credits to the air forces and commands. Complete records of the status of controlled and credit items in each echelon are maintained by the ordnance section, Army Air Forces.

■ 89. AMMUNITION SUPPLY.—Control of ammunition service in the Army Air Forces is accomplished by means of a system of authorizations and reports of expenditure. There are two kinds of authorizations, as follows:

a. Supply authorization, issued in favor of a subordinate administrative unit, authorizing that or a lower unit to req-

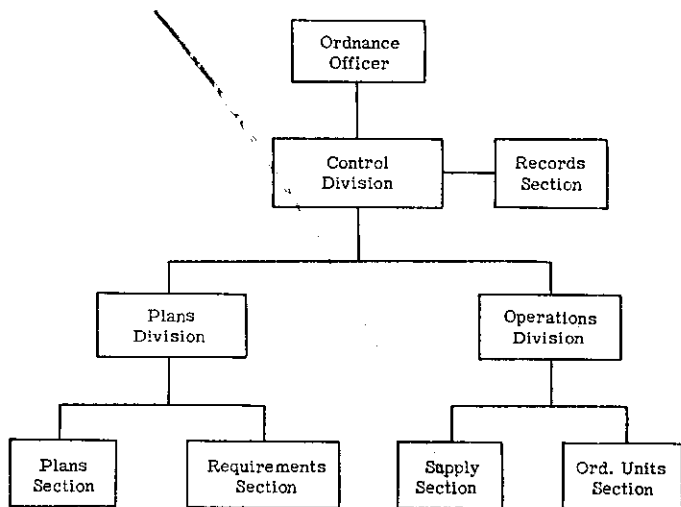

FIGURE 15.—Ordnance section, Army Air Forces.

uisition specified items from a specified establishment within a specified time limit (see fig. 16).

b. Expenditure authorization, issued by a unit in favor of a subordinate tactical unit, authorizing that or a lower unit to expend a specified amount of ammunition for a specified purpose during a specified period (see fig. 18).

■ 90. ADMINISTRATIVE DETAILS OF AMMUNITION SUPPLY.—*a. Supply authorities*.—The Army Air Forces issues supply

authorities to the air force or command concerned for the ammunition to be made available to it in depots in the zone of the interior or elsewhere. The Director of Military Requirements and the Army Air Forces ordnance officer decide on the types of missions and stock levels to be maintained in the air force depot, the air base RP's and airdrome DP's.) He then issues supply authorities (on OFM Form No. 309) and stock level orders to the air force depot and to the various air bases. Any headquarters having authority to issue a supply authority can, when the situation requires, issue shipping instructions for the delivery of ammunition direct to air force installations. (See fig. 16.)

b. Requisitions.—(1) *Air force depot.*—When the air force depot receives its supply authority and stock level order, it submits a requisition to the depot at which its credit is established for the ammunition to bring its stock to the prescribed level. In order to maintain its stock level as prescribed, it continues to submit requisitions as its stock is depleted until its credit is exhausted.

(2) *Air base.*—When an air base receives its expenditure authority and stock level orders, it submits requisitions to the air force or zone of the interior depot, depending on the location of the credit, for the ammunition required to bring the stocks in the air base RP and the various airdrome DP's to the prescribed level. It continues to submit requisitions to the limit of its credit to maintain these stock levels as the need is indicated by the status of stocks report (OFM Form No. 313). (See *d* below.) Figure 17 shows the flow of ammunition in the air force.

c. Expenditure authorities.—Normally, ammunition may be expended only when the expenditure has been authorized for the particular squadron by an expenditure authority. Expenditure authorities originate in the air force and are transmitted down through the various echelons of command to the squadron. The squadron uses this as the authority to request the ammunition from the airdrome DP. (See fig. 18.)

d. Reports (fig. 19).—(1) *Status of stocks report.*—The length of the reporting period is prescribed by the air force ordnance officer. Periodically as prescribed by this officer, each airdrome DP, and air base RP, will submit status of

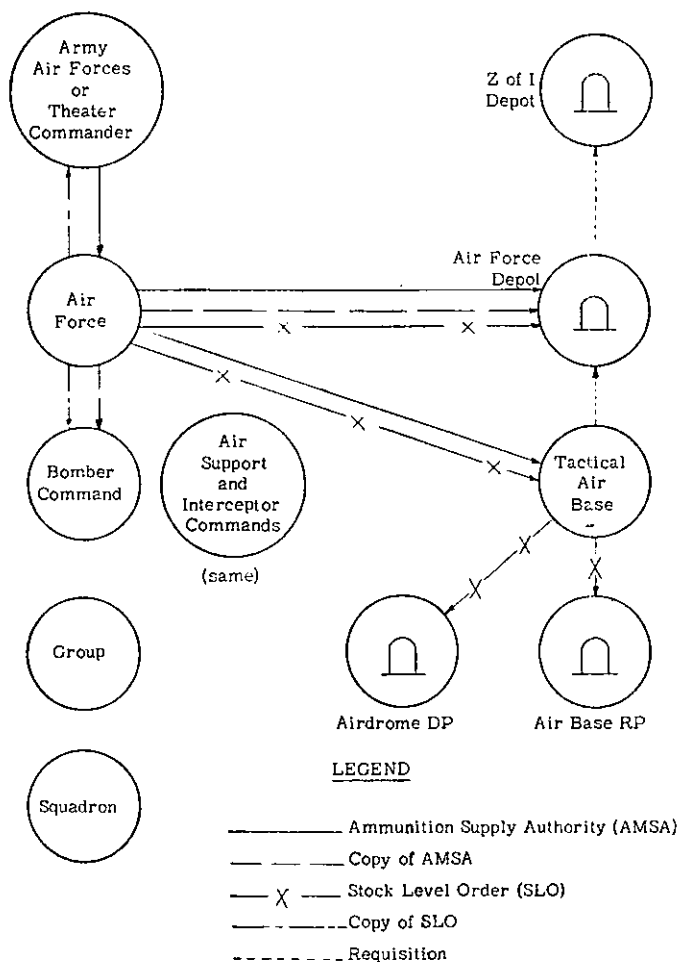
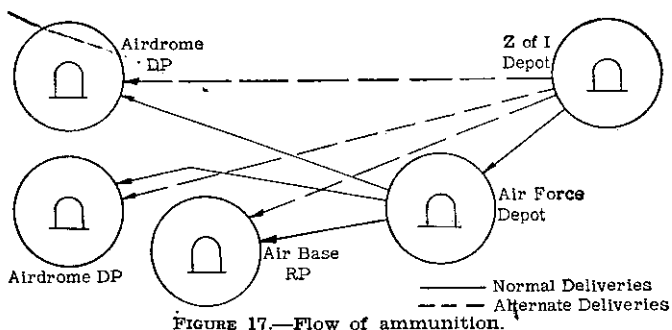

FIGURE 16.—Ammunition supply.

stocks reports (OFM Form No. 313) to the air base. The air base uses these reports as the basis for requisitions for ammunition to resupply these agencies as described in b(2) above. The air base consolidates these reports and submits the consolidation to the air force ordnance officer. This officer also receives a status of stocks report from the air force depot. These reports form the basis for requesting additional supply authorities from the Army Air Forces if the need is indicated.



(2) *Expenditure reports.*—Expenditure reports are submitted by each squadron through the various echelons of command to the air force. These are for the information of tactical commanders concerning operations and the status of expenditure authorities, and to check the suballotment of expenditure authorities by subordinate commanders.

■ **91.—MAINTENANCE.**—The responsibility for maintenance and technical inspection of ordnance matériel in the Army Air Forces is delegated to the air forces and commands. The Army Air Forces, when required, arranges for evacuation of unserviceable matériel from the air forces and commands.

(SECTION II)

IN AN AIR FORCE

■ **92. GENERAL.**—The ordnance officer of an air force is charged with the normal duties of a special staff officer. He

coordinates ordnance activities in the air force base command, bomber command, interceptor command, and air support command. An air force headquarters may be required to function as a theater air headquarters.

■ 93. ORDNANCE SERVICE IN AIR FORCE BASE COMMAND.—*a. General.*—The detailed control and operation of ordnance

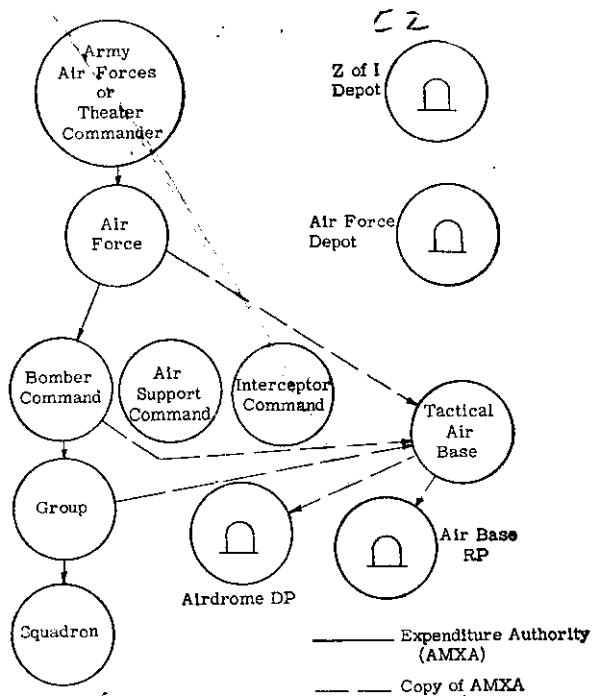

(FIGURE 18.—Ammunition expenditure.)

service activities in the air forces are delegated to the ordnance officer, air force base command. The ordnance officer, air force base command, has an adequate ordnance section to maintain the necessary control and supervision of ordnance service activities in the air force. Ordnance troops in this echelon are—

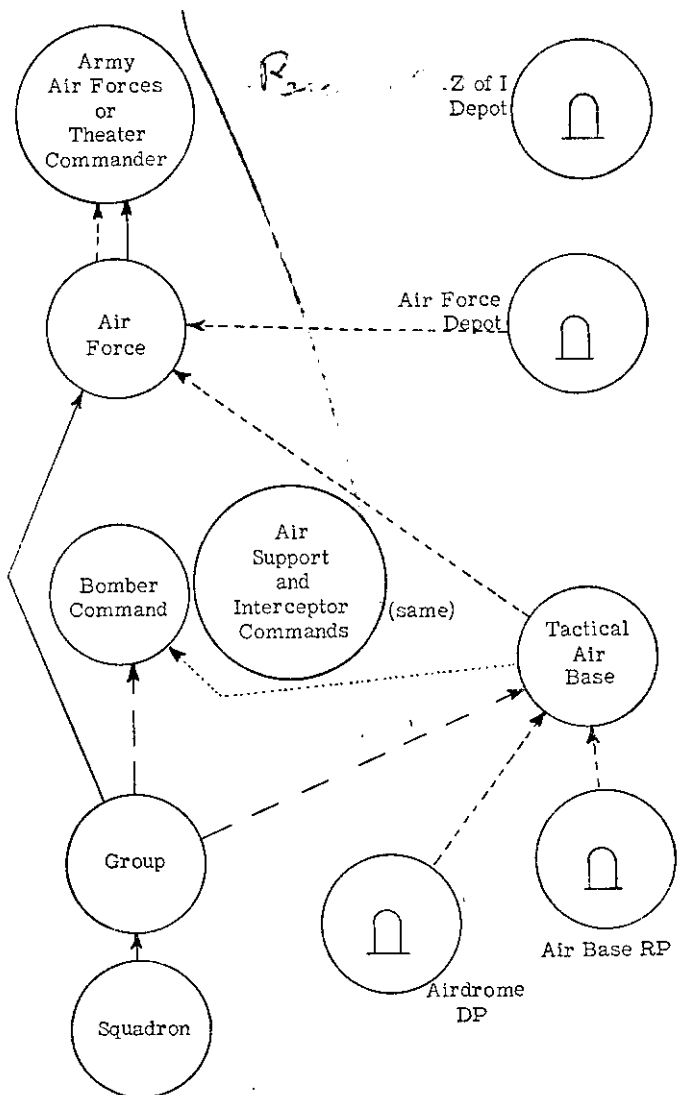

- Expenditure Report
- - - - - Copy of Expenditure Report
- Status of Stocks Report
- . - . - Copy of Status of Stocks Report

(FIGURE 19.—Ammunition reports.)

(1) One or more ordnance companies, depot, for operating the air force ordnance depot.

(2) One or more ordnance companies, ammunition, for operating the air force ammunition depot.

(3) One or more ordnance companies, medium maintenance, primarily for service to the antiaircraft artillery in the interceptor command.

(4) A small station complement normally consisting of one warrant officer and six enlisted men. This section operates directly under the control of the Army Air Forces. It is included among the base troops who remain at the base when it is evacuated by one air force and occupied by another. The station complements within an air force are organized into an ordnance service company, the headquarters of which is in the office of the ordnance officer of the air base service command.

b. Supply.—(1) *General.*—Credit items of general supply allocated to the air forces are controlled by reallocation to air bases. A complete record on the status of credit and controlled items in all echelons of the air force are maintained by the ordnance section, air force base command.

(2) *Ammunition.*—Ammunition is controlled as outlined in paragraph 89. Complete records on the status of ammunition in all echelons of the air force are maintained by the ordnance section, air force base command. For a complete discussion of ammunition supply in the air forces, see FM 9-6.

c. Maintenance.—Ordnance service in the air force base command provides technical information and guidance on the maintenance matters to all echelons of the air force. It maintains required records on maintenance and inspection in the air force. It employs the ordnance company, medium maintenance, to provide maintenance facilities for work that cannot be performed within the air bases. It arranges for the evacuation of ordnance matériel from the air force area.

■ 94. **ORDNANCE SERVICE IN BOMBER, INTERCEPTOR, AND AIR SUPPORT COMMANDS.**—The ordnance officer of these commands has the normal duties of a special staff officer, with the exception of the control and supervision of supply and maintenance. The technical phases of these staff duties are particularly important. There is an ordnance section in the headquarters

of each of these commands. The ordnance troop units serving these commands operate under the control of the air base service command.

SECTION III

IN AN AIR BASE AREA

■ 95. DEFINITION.—*a. Air base.*—An air base is a command which is equipped and organized for sustaining the operations of one or more tactical air units. The base comprises the personnel, supplies, equipment, airdromes, and all other facilities necessary to support the operations of tactical air units currently using its facilities. (See FM 1-5.)

b. Air base service area.—The air base service area is a territorial area within which is located the air base headquarters, airdrome, and all other establishments comprising the facilities of the air base. Its boundaries need not conform to those of other territorial divisions; it may extend into the army service areas, the communications zone, and into the zone of the interior. (See FM 1-5 and FM 100-10.)

■ 96. GENERAL.—Ordnance service in the air base service area comprises—

a. Supply and maintenance of ordnance matériel in the units of the air force within the air base service area.

b. Supply of completely assembled bombs, pyrotechnics, and belted aircraft ammunition to the combat airplanes. This supply is effected at any time as desired by the combat unit.

■ 97. ORDNANCE TROOPS.—*a. General.*—To provide the prescribed ordnance service, ordnance troops are furnished to the air base commander as follows:

(1) Ordnance company, air base (T/O 9-167) one per air base.

(2) Ordnance company, aviation, bombardment (T/O 9-157) one per bombardment group.

(3) Ordnance company, aviation, pursuit (T/O 9-157) one per pursuit group.

For a discussion of the operations of these companies, see FM 9-30.

b. Function.—The ordnance company, aviation (bombardment and pursuit), furnishes airdrome platoons for the service of combat squadrons at dispersed airdromes. The commanders of the ordnance companies (pursuit and bombardment) are assistants to the air base ordnance officer in carrying out the mission of ordnance service in the air base service area.

c. Air base ordnance officer.—The senior ordnance officer on duty in an air base (usually the company commander of the ordnance company, aviation, air base), is the air base ordnance officer, and has in addition to his command functions the normal duties of a special staff officer. He controls and supervises ordnance service in the air base service area.

■ 98. SUPPLY.—*a. General supply.*—A base refilling point for ordnance general supply is established to supply DP's and units at the air base. Complete records on all items of general supply are maintained by the ordnance section, air base headquarters.

b. Ammunition supply.—A base refilling point for ammunition is established. This refilling point provides ammunition required at the air base, and provides a reserve of ammunition for the air base area. The air base ordnance officer provides for automatic supply of ammunition to the RP's and DP's in the air base service area. The ordnance section, air base headquarters, maintains a complete record on the status of the ammunition in the air base area. For details concerning ammunition supply see FM 9-6.

■ 99. MAINTENANCE.—An air base ordnance maintenance center is established to supplement the maintenance facilities in the dispersed airdromes. Inspections of ordnance matériel are made as directed by the air base or higher commanders. The ordnance section, air base headquarters, maintains complete records on the status of maintenance and inspection in the air base area.

(SECTION IV)

AT A DISPERSED AIRDROME

■ 100. GENERAL.—The organization of ordnance companies, aviation (bombardment and pursuit), permits the assign-

ment of an airdrome platoon to provide ordnance service to a combat squadron at a dispersed airdrome. The service echelon at such a dispersed airdrome is known as the airdrome distributing point. See figure 20 for a schematic diagram of the organization of ordnance service at a dispersed airdrome. The ordnance airdrome platoon is the ordnance section of the distributing point, and is charged with providing prescribed ordnance service. The distributing point operates directly under the air base commander.

■ 101. SUPPLY.—*a. General supply.*—The ordnance maintenance set for an airdrome platoon of an ordnance company, aviation (bombardment or pursuit), provides the required stock of ordnance general supplies for the dispersed airdrome. This set is normally carried on the emergency repair truck of the platoon. It is replenished from the air base RP. Complete records on the status of general supplies at the airdrome are maintained by platoon headquarters.

b. Ammunition supply.—An ammunition distributing point is established to provide ammunition for the combat squadron and other troops at the dispersed airdrome. A complete record of the status of ammunition at the distributing point is maintained by platoon headquarters.

(SECTION V)

AIR SERVICE COMMAND

■ 102. GENERAL.—In its relation to air forces, the air service command is analogous to the installation and facilities normally found in the communications zone for ground forces. However, the installations of this command are not limited in location to the communications zone. They may be located in either the theater of operations, the zone of the interior, or both. The air service command operates under the control of the Commanding General, Army Air Forces.

■ 103. FUNCTIONS.—The air service command operates as a supporting agency for the several air forces. It receives newly procured equipment from manufacturing sources in the zone of the interior, and stores and issues such equipment to the air forces as required. It receives for repair, from field units and other sources, damaged equipment and

such repair work as is beyond the capabilities of the facilities of the air forces or separate commands.

■ 104. ORGANIZATION.—The air service command is organized in the United States into the headquarters and the air service area commands each of which is coincident geographically with the air forces in the United States. These air service

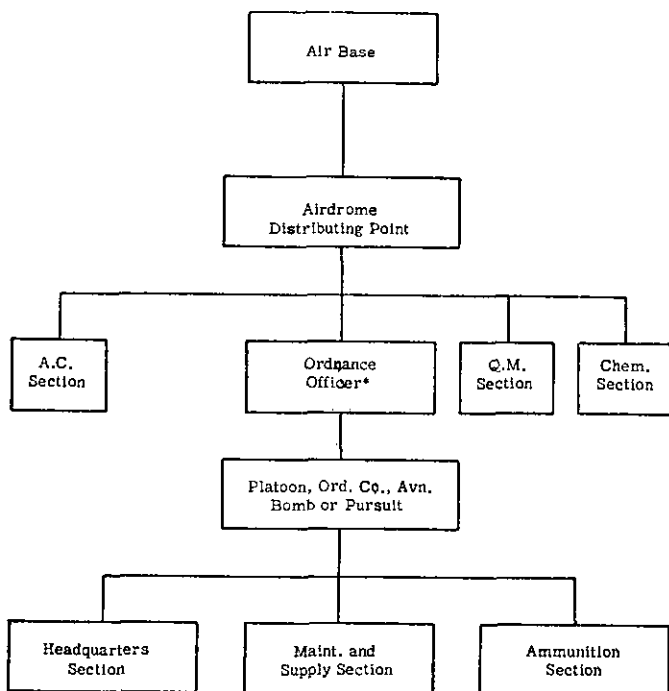

* Note: Normally the Ordnance Officer is the Ordnance Platoon Commander

FIGURE 20.—Organization of ordnance service, dispersed airdrome.

area commands consist of a number of depots and subdepots.

a. *Control air depots* are air service command depots within the continental limits of the United States and are of permanent character for major overhaul of aircraft.

b. *Mobile air depot groups* are air service command units which organize depots to be moved into a theater of operations to provide necessary air depot facilities in rear or port areas. Upon arrival in the theater of operations, these units pass to the control of the air officer on the theater commander's staff.

c. *Subdepots* are air service command installations which perform first and second echelon maintenance on aircraft at stations of the air force. (See par. 105d.)

■ 105. ORGANIZATION OF ORDNANCE SERVICE IN AIR SERVICE COMMAND.—The organization of the ordnance service in the air service command includes—

a. The ordnance section on the staff of the Commanding General, air service command, and of the air service area commanders.

b. One ordnance company (air base) (less airdrome and ammunition section) for each mobile air depot group.

c. One aviation company (service) consisting of a small section of approximately six men for each of the control air depots. The company commander is located at headquarters of the air service command.

d. There is no ordnance personnel at any of the subdepots. Repairs to ordnance matériel at subdepots are normally made by ordnance tactical organizations at the station.

■ 106. FUNCTIONS OF ORDNANCE SERVICE IN AIR SERVICE COMMAND.—a. *Responsibilities of ordnance officer, air service command.*—In addition to the usual responsibilities and duties of ordnance staff officers, the ordnance officer, air service command, is responsible for—

(1) Supply of aircraft machine guns and cannon for *initial* equipment of new airplanes.

(2) Supply of aircraft machine guns and cannon to control air depots.

(3) Supply of ammunition, including pyrotechnics, at control depots.

(4) Supervision of credits set up by the Commanding General, Army Air Forces, for items of supplies which pertain to aircraft armament in the various depots of the Ordnance Department in the United States.

b. Functions of ordnance troops in air service command depots.—(1) *Control depots.*—The receipt, storage, and issue of ordnance matériel and the accomplishment of some minor repairs. Since fixed depots are located only in the United States, complete overhaul can be performed at regular ordnance arsenals and similar installations.

(2) *Mobile depots.*—The complete overhaul of ordnance equipment installed on airplanes which are sent to the depot for overhaul. In addition, these depots have responsibility for the receipt, storage, and issue of ordnance matériel.

CHAPTER 9
BASIC DATA

■ 107. GENERAL SUPPLY AND AMMUNITION DEPOTS.—*a. Lay-out for general supply depot.*—The following basic data will be of assistance in planning lay-outs for ordnance depots in the communications zone:

(1) *Receipts and issues.*—From 0.75 pound to 1 pound per day per man in the area served by the depot.

(2) *Covered storage space.*—0.0168 square foot per day per man in the area served by the depot. It is also possible to compute the covered storage space required by dividing the total weight of the matériel to be stored by the average floor load which is approximately 80 pounds per square foot (aisles not included), or 50 pounds per square foot (aisles included).

(3) *Open storage space.*—Approximately twice the covered storage space.

(4) *Total area.*—Approximately four times the total storage space.

(5) *Total storage space.*—To obtain the cubic feet of storage space for ordnance general supplies, divide the number of pounds by 20.

(6) *Operating personnel.*—From 0.31 ton to 0.46 ton per man of operating personnel per day.

(7) *Storage buildings.*—Portable, sectionalized, light steel or wood construction with cinder floor or equivalent. Size, 50 feet by multiples of 14 feet.

(8) *Miscellaneous.*—Plans for ordnance depots must include information relative to the following requirements:

Operating equipment.

Trackage.

Roads.

Barrack accommodations.

Maintenance items to support establishment.

b. Lay-out for ammunition depot.—The following basic data will be of assistance in planning lay-outs for ammunition depots in the communications zone:

(1) *Receipts and issues.*—Computed from days of supply of ammunition fixed by proper authority for the weapons served.

(2) *Floor load.*—This varies with the type of ammunition stored from 163 pounds per square foot, to 250 pounds per square foot.

(3) *Covered storage space.*—Computed by dividing the total weight of ammunition to be stored by the floor load.

(4) *Total area.*—Approximately 70 times the total storage space.

(5) *Operating personnel.*—From 1.2 tons to 1.45 tons per man of operating personnel per day.

(6) *Miscellaneous.*—Plans for ammunition depots must include information relative to items listed in a(8) above.

■ 108. UNIT OF FIRE.—For a definition of the term, see paragraph 19*d*. For a complete discussion, including tabular data, see FM 101-10.

■ 109. AMMUNITION SUPPLY.—A complete discussion of this subject will be found in FM 9-6.

■ 110. GENERAL SUPPLY.—Extensive data on general supply will be found in Standard Nomenclature Lists.

■ 111. MISCELLANEOUS ESTIMATING FACTORS.—*a. General.*—The factors listed herein are approximations that have been derived after years of experience and study. It must be borne in mind that since these factors are approximations, they may be modified by responsible ordnance officers in accordance with local conditions.

b. Maintenance data.—The following table lists the quantity of ordnance items that an ordnance mechanic who is part of an organization may be expected to *maintain* under normal conditions. It is assumed that the organization will provide administrative personnel and general service personnel such as supply workers, welders, machinists, etc.

MAINTENANCE DATA

<i>Item</i>	<i>Item per man</i>
Gun, 37-mm, AT-----	10
Gun, 37-mm, AA-----	3
Gun, 3-inch, AA-----	2
Gun, howitzer, 75-mm, 105-mm-----	4
Howitzer, 155-mm-----	3
Gun, 155-mm-----	3
Mortar, 60-mm-----	100
Mortar, 81-mm-----	100
Tanks-----	4

Item	Item per man
Tractors.....	6
Scout cars.....	7
Personnel carriers.....	6
1- and 2½-ton trucks.....	8
Rifles M1.....	900
Rifles M1903.....	2,000
Pistols.....	3,000
Machine guns.....	300
B. A. R.....	800
Ordnance technical vehicles.....	10
Car, half track.....	6
Car, armored.....	6
Gun, 37-mm, aircraft.....	6
Gun, 37-mm, tank.....	10
Gun, 57-mm, tank.....	6

c. Ammunition supply handling data.—(1) *Average handling rates.*—In unloading from a railroad car to a truck or to the ground, or from a truck to the ground, one man can unload at the rate of $\frac{5}{6}$ ton per hour for 4 continuous hours (with at least 4 hours rest thereafter). A man can average this rate for 8 hours out of 24, or can unload $6\frac{2}{3}$ tons in 24 hours. In loading from the ground to a truck, one man can load at the rate of $\frac{3}{4}$ ton per hour, or, as computed for unloading, 6 tons in 24 hours.

(2) *Unloading railroad trains.*—(a) Not more than 11 men may be used advantageously in unloading a 30-ton car from one side, and not more than 18 men, if it is possible to unload from both sides.

(b) One truck only can be loaded from a side of a car at a time.

(c) Average time required to unload a train of 30-ton cars is $3\frac{1}{2}$ hours.

(d) An allowance of 30 minutes should be made for clearance.

(e) Minimum time between trains on the same siding averages 4 hours.

(3) *Miscellaneous.*—(a) An ordnance company, ammunition (T/O 9-17), may be expected to handle 500 tons of ammunition in a 24-hour period.

(b) Minimum overall covered storage in the theater of operations is 0.030 square feet per man in theater.

(c) Operating personnel: 1.2 tons to 1.45 tons per man of operating personnel per day; or 387 square feet to 536 square feet per man of operating personnel per day.

APPENDIX I

CHECK LIST FOR ORDNANCE PLANS

The following check list for ordnance plans is suggested as a guide to army, corps, and division ordnance officers. It is not intended that every item is applicable in a specific situation, nor is inclusion of every appropriate item any guarantee that a given ordnance plan is complete. Although the list is arranged largely for the army ordnance officer, the information is pertinent to corps and division ordnance officers.

■ 1. INFORMATION TO BE OBTAINED BY ORDNANCE OFFICER BEFORE FORMULATION OF PLAN.—*a.* Plan for tactical employment of the command.

b. Administrative orders or approved plans of higher echelons, or both.

c. Administrative decisions of the commander and G-4.

d. Tentative plans of other supply services.

■ 2. ORDNANCE UNITS.—*a.* Assignment of ordnance companies to establishments or other tasks, or to lower or higher echelons.

b. Assignment of ordnance companies attached from higher echelons (from par. 1*b*) or detached from lower echelons (from par. 1*c*).

c. Instruction concerning inspections:

(1) Assignment of inspecting parties to units to be inspected.

(2) General instructions concerning inspections in all echelons, including—

(*a*) Form and routing of reports.

(*b*) Authority for action by inspectors.

d. Location of ordnance office (from par. 1*c*).

■ 3. ORDNANCE GENERAL SUPPLIES.—*a.* Computation of the weight of the unit of supply for the command.

b. Requirements:

(1) Based on paragraph 1*a* and *c*.

(2) Stated in terms of—

(*a*) Units of supply.

(*b*) Tons.

c. Available (from par. 1*b*) in terms of days of supply.

d. Supply points: number and location of ordnance depots and other supply points in accordance with—

(1) Paragraph 1*a*, *c*, and *d*.

(2) Railway and highway nets (as shown by maps and checked by reconnaissance).

(3) Units to be supplied by each.

(4) Shelter and concealment.

e. Stock at each supply point (stock levels):

(1) Including—

(*a*) Basic sets of spare parts and replacement articles.

(*b*) Replacement articles not included in (*a*) above.

c

(c) Cleaning and preserving materials.

(2) In terms of—

(a) Tons.

(b) Open and covered storage space required.

f. Issue and replenishment:

(1) Method of obtaining initial stocks (from par. 1b).

(2) Method for lower echelons obtaining supplies from supply points.

(3) Special methods of delivery, such as at railhead, or by other than unit transportation.

(4) Method of replenishment of stocks of supply points.

g. Transportation of initial or replenishment stock, including special methods of delivery.

(1) Means of transportation and amount required.

(2) Transportation schedules:

(a) Times of arrival and departure of railway trains at supply points or railheads.

(b) Itineraries and times of arrival and departure of motor transportation employed.

* (3) Time of opening of each supply point, based on (2) above.

h. Additional labor above that available to army ordnance service required at each supply point—

(1) For unloading, storing, and issuing.

(2) For roads, shelter, and camouflage.

i. Number and location of salvage and repair establishments in accordance with—

(1) Paragraph 1a, c, and d.

(2) Location of supply points (d(1) above).

(3) Location and employment of artillery (from par. 1a and chief of artillery).

(4) Location and employment of tanks and other combat vehicles (from par. 1a).

j. Instruction concerning evacuation of unserviceable and captured enemy matériel:

(1) Inspections to be made and reports to be rendered.

(2) Transportation to be employed.

■ 4. AMMUNITION SUPPLY.—a. Computation of the weight of, and items included in, the unit of fire for the command.

b. Requirements:

(1) Based on paragraph 1a and c and statement of the artillery or the artillery commander.

(2) Stated in terms of—

(a) Units of fire.

(b) Tons.

c. Ammunition available (from par. 1b) ⁽¹⁾ in terms of units of fire.

d. Supply points: number and location of depots and other supply points in accordance with—

(1) Paragraph 1a, c, and d.

(2) Location and employment of artillery (from 1a and chief of artillery).

(3) Railroad and highway nets (as shown by maps and checked by reconnaissance).

(4) Units to be supplied by each.

* Usually included in administrative orders.

ORDNANCE DEPARTMENT

* (e) Hours of issue or schedule for issue.

(f) Shelter and concealment.

e. Stock at each supply point in terms of—

(1) Units of fire for units supplied by each.

(2) Tons.

(3) Complete rounds.

f. Issue and replenishment:

(1) Original credits (from par. 1b).

(2) Allocation to lower echelons.

(3) Situation and status of stock reports (how and when rendered).

(4) Replenishments required based on probable issues from each supply point in terms of—

(a) Units of fire for units supplied from each.

(b) Tons.

(c) Complete rounds.

g. Transportation of initial or replenishment stock to each supply point, including transportation required for mobile reserves:

(1) Means of transportation and amount required.

(2) Schedule of shipments to depots and other supply points.

(a) Time of arrival and departure of railway trains at each supply point.

(b) Itineraries and times of arrival and departure of motor transportation.

* (3) Time of opening of each supply point based on (2) above.

h. Additional labor, above that available to army ordnance service, required at each supply point—

(1) For unloading, storing, and issuing.

(2) For roads, shelter, traverses, and camouflage.

■ 5. DISPOSITION OF STORES.—a. During an advance.

(1) Movement to new location.

(2) Transfer of responsibility to other unit.

b. During a withdrawal.

(1) Movement to new location.

(2) Destruction.

* Usually included in administrative orders.

ORDNANCE SERVICE IN THE FIELD

APPENDIX II

PUBLICATIONS APPLICABLE TO ORDNANCE ACTIVITIES

■ 1. ABBREVIATIONS USED IN THIS TABLE.

AR.....	Army Regulations
BFM.....	Basic Field Manual
EM.....	Enlisted Men
FSMWO.....	Field Service Modification Work Order
FM.....	Field Manual
ICC.....	Interstate Commerce Commission
OEC.....	Ordnance Equipment Charts
OFBS.....	Ordnance Field Service Bulletin
OFSC.....	Ordnance Field Service Circular
OPSI.....	Ordnance Publications for Supply Index
OPSR.....	Ordnance Provision System Regulations
OSM.....	Ordnance Safety Manual
OSSC.....	Ordnance Shipment and Storage Chart
SNL.....	Standard Nomenclature List
T/A.....	Table of Allowances
T/BA.....	Table of Basic Allowances
T/O.....	Table of Organization
TM.....	Technical Manual

■ 2. INDEXES AVAILABLE.

AR 1-10	
FM 21-6	SNL's (OPSI)
FSMWO, subject index	T/O subject index
OFBS, 1-1, 1-2	TR 1-10
OFSC, serial list	

■ 3. ORDNANCE FIELD MANUALS.

- FM 9-5, Ordnance Service in the Field.
- 9-6, Ammunition Supply.
- 9-10, Ordnance Field Maintenance.
- 9-20, The Ordnance Company, Battalion, Ammunition.
- 9-25, The Ordnance Company, Depot.
- 9-30, Ordnance Service in the Air Force.

■ 4. SUBJECTS WITH PUBLICATIONS APPLICABLE THERETO.

Ammunition:

Allowances, organizational.....	T/BA
Allowances, training, ammunition.....	AR 775-10
Company and battalion.....	FM 9-20
Description of types.....	TR 1350-A to 1370-G, inclusive
General.....	TM 9-2010, TM 9-900
Identification code.....	FM 9-6, OFSB 3-14
Maintenance, general.....	TM 9-1900
Nomenclature and complete round.....	SNL, groups P, R, S, T
Nomenclature and shipping names.....	OFSB 3-12
Packing and marking.....	TR 1350-A, TR 1370-B, TM 9-1900

ORDNANCE DEPARTMENT

Small arms, maintenance.....	TM 9-1990, AR 100-10, OSM
Storage, care, and maintenance.....	OFSB series No. 3, TM 9-1900
Supply.....	FM 9-6
Transportation, motortruck.....	TM 9-1900
Artillery:	
Handbook of, general.....	TM 9-2300
Explosives, military.....	TM 9-2900
Instruction guides and texts.....	TM 9-200 to 9-2999, inclusive
Maintenance:	
Ammunition, general.....	TM 9-1900
Ammunition, small arms.....	TM 9-1990
Field ordnance.....	FM 9-10
Ordnance matériel, by individual soldier.....	TM 9-200 to 9-999
Ordnance matériel, by ordnance maintenance personnel.....	TM 9-1000 to 9-1999
Ordnance matériel, inspection, and repair.....	TM 9-1100
Ordnance matériel.....	OFSB series No. 4
Railway rolling stock.....	AR 100-50
Fortifications.....	AR 100-20
Military instructions, EM.....	BFM (See FM 21-6.)
Military units, organization.....	T/O
Ordnance Department, organization and functions.....	TM 9-2000
Ordnance matériel:	
General.....	TM 9-2005
Maintenance, inspection, and repair.....	TM 9-1100
Use of.....	FM 23-series
Ordnance provision system.....	OPSR
Property:	
Accounting for.....	AR 35-6520, 45-80, OFSB 2-1, FM 9-25
Disposition and sale of serviceable.....	AR 35-780, 35-6520, 45-30, 45-75, 45-80
Expendable.....	AR 35-6620
Issues.....	AR 35-6560, 45-80, 310-60, 350-3300
Lost, damaged, and unserviceable.....	AR 20-35, 30-955, 30-2145, 35-6640, 45-80, 210-70, 345-300
Procurement of.....	AR 5-series, AR 35-6540
Receipt, shipment, and issue.....	AR 30-955, 30-1105, 35-6560, 45-80
Requisitioning.....	AR 35-6540
Storage.....	AR 35-6520, 700-10
Supplies, ordnance:	
Authorized allowances.....	T/A, T/BA 9, SNL, equipment section, OEC
Classification and groupment.....	Introduction to ordnance catalog
Cleaning, preserving, and lubricating materials.....	TM 9-850

ORDNANCE SERVICE IN THE FIELD

Description and operation.....	TR series 1300 to 1330, inclusive
Initial allowances, organization's...	Ordnance war planning equipment chart
Procurement.....	AR 5-100, 5-140, 5-160, 5-200, OFSB 2-1, 2-2
Repairing, modifying, or maintaining.....	OFSB series 4, TR series 1400 to 1410, inclusive
Storage.....	AR 700-10, TM 9-850, OFSB 2-2, OSSC
Transportation.....	AR 30-955, OSSC
Target and target accessories:	
Authorized allowances.....	T/A
Nomenclature and listing.....	SNL, group L
Targets, target materials, and range construction.....	TM 9-855
Transportation:	
Commercial means.....	AR 30-905
Explosives (See Ammunition.)	
Preparation for shipment.....	AR 30-940, FM 9-25, TM 9-865, 9-870
Supplies (See Supplies, ordnance.)	
Troops.....	AR 30-945

ORDNANCE DEPARTMENT

APPENDIX III

ORDNANCE TROOP ASSIGNMENTS

Organization	T/O	Ordnance service	T/O
Air Corps headquarters & headquarters squadron bomber command.	1-100-1 7/1/41	Ordnance section, 2 officers, 5 enlisted men.	-----
Air Corps headquarters & headquarters, squadron interceptor command.	1-200-1 7/1/41	Ordnance section, 1 officer, 2 enlisted men.	-----
Air Corps headquarters, & headquarters squadron, air support command.	1-500-1 9/10/41	Ordnance section, 2 officers, 5 enlisted men.	-----
Air Corps headquarters & headquarters, squadron, technical training command.	1-700-1 7/16/41	Ordnance section, 1 officer, 1 enlisted man.	-----
Air Corps headquarters & headquarters, squadron air force.	1-800-1 1/7/41	Ordnance section, 3 officers, 17 enlisted men.	-----
Air force, air base		Ordnance company, air base	9-167)
		Ordnance company, bombardment or pursuit. (Number of bombardment or pursuit companies depends on the Air Corps strength).	9-157) 12/16/40
Air depot, mobile		1 ordnance company, aviation air base less ammunition and airdrome sections.	-----
Air force, airdrome		1 ordnance platoon, bombardment or pursuit, per squadron.	9-157 12/16/40
Task air force		Ordnance company, medium maintenance.	9-7
		Ordnance company, ammunition	9-17
		Ordnance company, depot. (Number of each type depends on strength and location of task air force.)	11/1/40
Cavalry division, horse	2 11/1/40	Ordnance company, medium maintenance.	9-7
Cavalry division headquarters, horse	2-1 11/1/40	Ordnance section 1 officer, 4 enlisted men.	-----
Cavalry Corps, headquarters.	150-1 11/1/40	Ordnance section, 2 officers, 3 enlisted men.	-----
Coast Artillery headquarters, coastal frontler.	4-222 11/1/40	Ordnance section, 3 officers, 5 enlisted men.	-----
Infantry division headquarters.	7-1 4/1/42	Ordnance section, 3 officers, 22 enlisted men.	-----
Motorized division		Ordnance battalion, maintenance, motorized.	-----
Mountain division, quartermaster company salvage collecting.	10-187 4/1/42	1 ordnance company, maintenance (mountain division) attached ordnance, 7 enlisted men.	-----

ORDNANCE SERVICE IN THE FIELD

<i>Organization</i>	<i>T/O</i>	<i>Ordnance service</i>	<i>T/O</i>
Port headquarters	10-260-1	Ordnance section, 1 officer, 8 enlisted men.	
Armored division	11/1/40 17 3/1/42	Ordnance battalion 1 battalion headquarters and headquarters company. 3 ordnance companies, maintenance, armored division.	9-65 9-66 9-67
Armored corps headquarters.	170-1	Ordnance section, 3 officers, 8 enlisted men.	
Army Corps headquarters.	11/15/40	1 ordnance officer (also battalion commander).	
Army Corps troops	100-1	Ordnance battalion, maintenance 1 headquarters and headquarters detachment. 3 ordnance companies, medium maintenance.	9-75 9-7
Field army troops		1 ordnance battalion, maintenance and supply. 1 headquarters and headquarters detachment. 2 ordnance companies, heavy maintenance (field army). 1 ordnance company, medium maintenance. 2 ordnance companies, depot 2 ordnance battalions, ammunition, each. 1 headquarters and headquarters detachment. 6 ordnance companies, ammunition.	9-115 9-9 9-7 9-18 9-15 9-17
Field army headquarters.	200-1 1/1/41	Ordnance section, 11 officers, 26 enlisted men.	
Regulating station			
Communications zone headquarters.			
Communications zone		Ordnance company, ammunition, (2 per 15 days of supply per army). Ordnance company, depot (1 per 15 days of supply per army). Ordnance company, medium maintenance (4 or 5 per army). Ordnance company, heavy maintenance (2 per army).	9-17 9-18 9-7 9-9
GHQ, headquarters	300-1 5/1/40	Ordnance section. 4 officers, 16 enlisted men.	
Theater reserve		Ordnance company, medium maintenance (1 per AA brigade) (1 per 6 FA regiment). Ordnance company, maintenance railway artillery (1 per regiment, railway artillery). Ordnance company, heavy maintenance (tank) (1 per 3 separate tank battalions). Ordnance company, ammunition (1 per 500 tons of ammunition handled per day). Ordnance company, depot (1 per 216,000 men in the area served).	9-7 9-47 9-9 9-17 9-18

INDEX

	Paragraph	Page
Administration ammunition supply-----	23	23
Air base:		
Ammunition supply-----	98	88
Definition-----	95	87
General supply-----	98	88
Maintenance-----	99	88
Ordnance officer-----	97	87
Service area, definition-----	95	87
Service area, ordnance service-----	96, 97	87
Airdrome, dispersed:		
Ammunition supply-----	101	8
General supply-----	101	8
Ordnance service-----	100	88
Air force, mission of ordnance service-----	86	77
Air force base command:		
Ammunition supply-----	92	83
General supply-----	92	83
Maintenance-----	92	83
Ordnance service-----	92	83
Air service command:		
Functions-----	103	89
Ordnance service-----	105, 106	91
Organization-----	104	90
Air support command, ordnance service-----	94	86
Allocations of credits-----	25, 26	24, 26
Ammunition:		
Credits-----	24	24
Definitions-----	19	19
Distribution-----	22	22
Flow-----	21	22
Procurement by combat troops-----	78	71
Reports-----	23, 27, 63	23, 27, 62
Supply:		
Administration-----	23	23
Administrative details, army-----	63	62
Air base-----	98	88
Airdrome, dispersed-----	101	89
Air force base command-----	92	83
Army Air Forces-----	89, 90	8
Corps-----	71	6
Division-----	76	70
Special characteristics-----	20	20
Supply point, definition-----	19	19
Ammunition battalion-----	62	59
Army Air Forces:		
Ammunition supply-----	89, 90	80
General supply-----	88	79
Maintenance-----	91	83
Ordnance section-----	87	79
Army ordnance officer, duties-----	59, 60	55
Army ordnance service:		
Organization and facilities-----	58, 62	55, 59
Operations-----	63	62

INDEX

	Paragraph	Page
Aviation ordnance:		
Companies	40	38
Sections	39	38
Battalion, ordnance:		
Ammunition	37, 62	37, 59
Corps maintenance	37, 69	37, 66
Maintenance and supply	37, 62	37, 59
Bomber command, ordnance service	100	88
Classes of supply	15	15
Combat zone:		
Definition	2, 42	1, 40
Ordnance service in	58, 84	55, 76
Command channel	6	7
Communication channel	6	7
Communications zone:		
Definition	2, 42	1, 40
Establishment and functions of	48	45
Ordnance establishments	49	45
Ordnance officer	50	46
Organization	49	45
Contact parties, maintenance operations	22	22
Corps maintenance battalion	69	66
Corps ordnance officer, functions	65, 68	64, 65
Corps ordnance service:		
Mission of	64	64
Organization and facilities	66	64
Credits:		
Allocation of	25, 26	24, 26
Ammunition	24	24
Requests for	25	24
Depots, operation of	52	49
Diary, staff officer	5	6
Distribution of ammunition	22	22
Division:		
Ammunition office	80	73
Ammunition supply	76	70
Maintenance and supply	81	74
Ordnance officer, functions of	73, 79	68, 72
Ordnance service	72, 75	68, 69
Factors affecting stock levels	12	14
Flow of ammunition	21	22
Flow of supplies	16	15
General supply:		
Air base	98	88
Airdrome, dispersed	101	89
Air force base command	92	83
Army Air Forces	88	79
Army	63	62
Corps	70	66
Division	81	74
Ordnance	18	18

INDEX

	Paragraph	Page
Inspection:		
Ordnance.....	8, 10	9, 10
Reports.....	10	10
Interceptor command, ordnance service.....	94	86
Maintenance:		
Air base.....	99	88
Air force base command.....	92	83
Army Air Forces.....	91	83
Army.....	63	62
Division.....	81	74
Operations, contact party.....	82	75
Principles.....	31	32
Purpose of.....	28	3
Responsibility.....	29	3
Scope of.....	29	31
Types.....	30	31
Maintenance and supply battalion, army.....	62	59
Maintenance battalion, corps.....	69	66
Military training, troop units.....	34	34
Operation of depots.....	52	49
Ordnance:		
Battalions.....	37	37
Companies.....	36	35
Companies, aviation.....	40	38
Department, responsibility of.....	1	1
Establishments, duties of commanders.....	51	47
General supplies.....	18	18
Inspections.....	8, 10	9, 10
Mission.....	1	1
Officer:		
Army, duties of.....	59, 60	55
Communications zone.....	50	46
Corps.....	65, 63	64, 65
Division.....	73, 79	68, 72
Regulating station.....	55	52
Theater of operations.....	44, 45	42, 43
Operations.....	8	9
Plans.....	8, 9	9
Sections.....	35, 39	35, 38
Service:		
Air base command.....	94	86
Air base service area.....	96, 97	87
Airdrome, dispersed.....	100	88
Air force base command.....	92	83
Army Air Forces.....	87	79
Air service command.....	105, 106	91
Air support command.....	94	86
Bomber command.....	94	86
Infantry division (square).....	83	75
Interceptor command.....	94	86
In zone of interior.....	3	2
Organization of.....	2	1
Responsibility for.....	7	8
Plan, ordnance.....	9	9
Planning.....	8, 61	9, 57

INDEX

	Paragraph	Page
Priorities of supplies.....	17	16
Procurement:		
Ammunition, by combat troops.....	78	71
Local supplies.....	15	15
Regulating station:		
Duties of commander.....	53	52
Duties of ordnance officer.....	55	52
Operations.....	56	53
Reports:		
Ammunition.....	23, 27	23, 27
Inspection.....	10	10
Requests for ammunition credits.....	24	24
Requirements, supply.....	13	14
Responsibility of the ordnance department.....	1	1
Safeguarding of information.....	5	6
Square division, infantry, ordnance service.....	83	75
Staff officer, ordnance, duties.....	4, 5	5, 6
Stock levels:		
Factors affecting.....	12	14
Maintenance of.....	16	15
Supplies, general (<i>See also</i> General supply):		
Local procurement of.....	15	15
Transportation of.....	17	16
Supply, ammunition (<i>See also</i> Ammunition supply):		
Classes of.....	15	15
Flow of.....	16	15
General principles of.....	11	12
Priorities.....	17	16
Requirements.....	13	14
Technical channel.....	6	7
Technical functions, ordnance staff officer.....	5	6
Technical training, troop units.....	34	34
Theater of operations.....	42	40
Theater of war, definition.....	2	1
Transportation of supplies.....	17	16
Unit of fire.....	19	19
Units, Ordnance troops:		
Organization and equipment.....	33	33
Training.....	34	34
Types of.....	32	33
Zone of the interior:		
Definition.....	2	1
Facilities of.....	3	2
Ordnance service.....	3	2