

# **MG-42 SA**

## **Owner's Manual** **Belt-Fed Semi-Automatic Rifle**



# The Essentials of Running The MG-42 SA:

Following these steps will help you use this complex system reliably, prevent malfunctions, dangerous operation, and damage.

- 1) Training:** All current or prospective customers are encouraged to make an appointment to come to our shop in Maryland for training. We will show you how to properly use and care for the MG-42 SA. To make an appointment call (301)807-5234.
- 2) Correct Ammo:** *(See pages 41 & 42 of this manual)* There have been a wide variety of 8mm weapons produced in the 20th Century by numerous countries. Much of this ammunition is not suitable to run in an automatic belt-fed firearm.
- 3) Correct Belts:** During the 20th Century there were dozens of belt-fed machinegun designs that have been produced by numerous countries. Belts designed for one type of machinegun often look a lot like those of another. Many companies in the US sell belts for the MG-34, MG-42, and M-53 that are not actually belts designed for use in these weapons. We have seen numerous VZ, MG-3, and Swiss MG belts in the US market that will not function in firearms designed to run with the German-type MG-34/42 belt. Running an incorrect belt will likely result in damage to the feed mechanism.
- 4) Lubrication:** Use plenty of lubricant such as Ballistol or Break Free on the rails, bolt, feed mechanism, and belts during use. Unless you are in the desert, run the MG-42 SA 'wet.' Avoid using WD-40 because it is flammable and may result in excessive chamber pressures.
- 5) Cleaning:** *(See pages 38, 39, and 40 of this manual)* When cleaning the MG-42 SA, pay special attention to cleaning the bolt head, barrel, entire booster assembly and surrounding receiver area. Pay special attention to the front of the MG-42 SA. This is the exit point for all of the gasses and residue. This includes the flash-hider, booster cone, barrel sleeve, barrel crown, and receiver bushing. These parts must be thoroughly and aggressively cleaned after extended used because the corrosive residue becomes 'baked-on.'
- 6) Inspection:** *(See page 43 of this manual)* After cleaning, fully inspect and reassemble the MG-42 SA. Once fully reassembled, load and cycle some dummy rounds through the system to check for proper function.

# MG-42 Semi-Auto (SA) Manual

The MG-42 SA is a highly complex and sophisticated system that requires knowledgeable operators. Full and complete adherence to the following instructions is an absolute necessity for safe and responsible use of the MG-42 SA. This system is NOT meant for anyone other than individuals knowledgeable in the safe operation of belt fed systems and who have a thorough understanding of semiautomatic and automatic firearms. If you are not such an individual you pose a danger to yourself and those around you by using this system.

The following MG-42 parts and accessories will not work with the MG-42 SA:

- Bolt Carrier
- Trigger Housing and Internal Trigger Housing Parts
- Short Recoil Assembly
- Firing Pin and Guide
- Cocking Handle
- Mainspring

The following MG-42 parts and accessories will work with the MG-42 SA:

- Belts and Belt Drums
- Slings
- Sights
- Ejector
- Ejector Rod
- Complete Bolt Head Assembly
- Bipod
- Barrel
- Buttstock
- Buffer
- Feed Cover and Feed Tray

## The Differences Between the Original MG-42 and the MG-42 SA

The MG-42 SA fires from the closed-bolt position using a conventional Hammer/Trigger/Disconnecter setup similar to AR, AK, and HK rifles. The double-torsion spring setup is taken directly from an AR. The trigger housing has been modified accordingly to house these parts. It is slightly longer and wider than the original and mounts differently to the receiver. An original MG-42 trigger housing cannot mount to the MG-42 SA receiver.

The firing pin is a floating type with a spring positioned to the front to prevent slam-fire. When the bolt is fully locked into the barrel collar, the firing pin can be struck from the rear by the hammer to ignite the round. To accommodate the hammer-strike the bolt carrier is longer than the original MG-42 bolt carrier, and the mainspring is shorter than the original MG-42 mainspring. Also, the bolt carrier has a smooth bottom to allow the hammer to cock and rub the underside of the bolt carrier during cycle. An original bolt carrier will not fit into the MG-42 SA receiver. Since the bolt carrier does not have the same cocking surface as the original, the cocking handle has been modified to accommodate the cocking surface on the MG-42 SA bolt carrier.

## **Safety – Your Responsibility**

SAFETY MUST BE THE FIRST AND CONSTANT CONSIDERATION OF EVERY PERSON WHO HANDLES FIREARMS AND AMMUNITION. This manual is designed to assist you in learning how to use and care for this system properly.

Only when you are certain you fully understand the manual and can properly carry out its instructions should you practice loading, unloading, etc. with live ammunition.

If you have doubts about your ability to handle or use this particular system safely, then you should seek supervised instruction. Such personalized instruction is often available from gun dealers, gun clubs or police departments. If none of these sources can help you contact the National Rifle Association. You are also encouraged to contact BRP CORP for assistance.

The person with a gun in his possession has a full-time job. He cannot guess; he cannot forget. He must know how to use his firearm safely. Do not use any firearm without having a complete understanding of its particular characteristics and safe use. Remember: There is NO such thing as a foolproof gun.

### **Basic Safety List**

- A loaded firearm has the potential to kill. Intelligently handled it is safe.
- An accident is always the result of basic safety rules neglect.
- Accident prevention is user responsibility.
- Never point a firearm at anything you don't want to shoot.
- Before handling a firearm be sure to use correct and undamaged ammunition.
- Be sure your firearm is clean – before loading inspect the barrel to insure it is perfectly clean and free of foreign objects. Shooting with an obstruction in the barrel such as dirt, mud, grease, lodged bullet or jacket, residues, etc, can cause barrel bulging and/or rupture.
- Never assume that the chamber is empty, visually inspect it every time you handle the gun.
- Avoid alcoholic beverages or drugs before and during shooting.
- Avoid hard hitting or dropping of a loaded firearm.
- Store firearms and ammunition separately, beyond the reach of children. Be sure cartridge chamber is empty.
- Thoroughly clean the firearm to prevent corrosion.
- Wear eye and ear protection.
- Firearms Safety Course is recommended.
- Handle it with respect not fear.



# Design of the Weapon

- |                                     |  |
|-------------------------------------|--|
| 1. Housing                          | 8. Rear Covers   |
| 2. Barrel                           | 9. Butt  |
| 3. Bolt                             | 10. Bipod  |
| 5. Feed Mechanism                   | 11. Sling  |
| 6. Pistol Grip with Trigger Housing | 12. Recoil Booster, Recoil Nozzle, and Barrel-Guide Sleeve |
| 7. Cocking Slide                    | 13. Recoil Spring  |

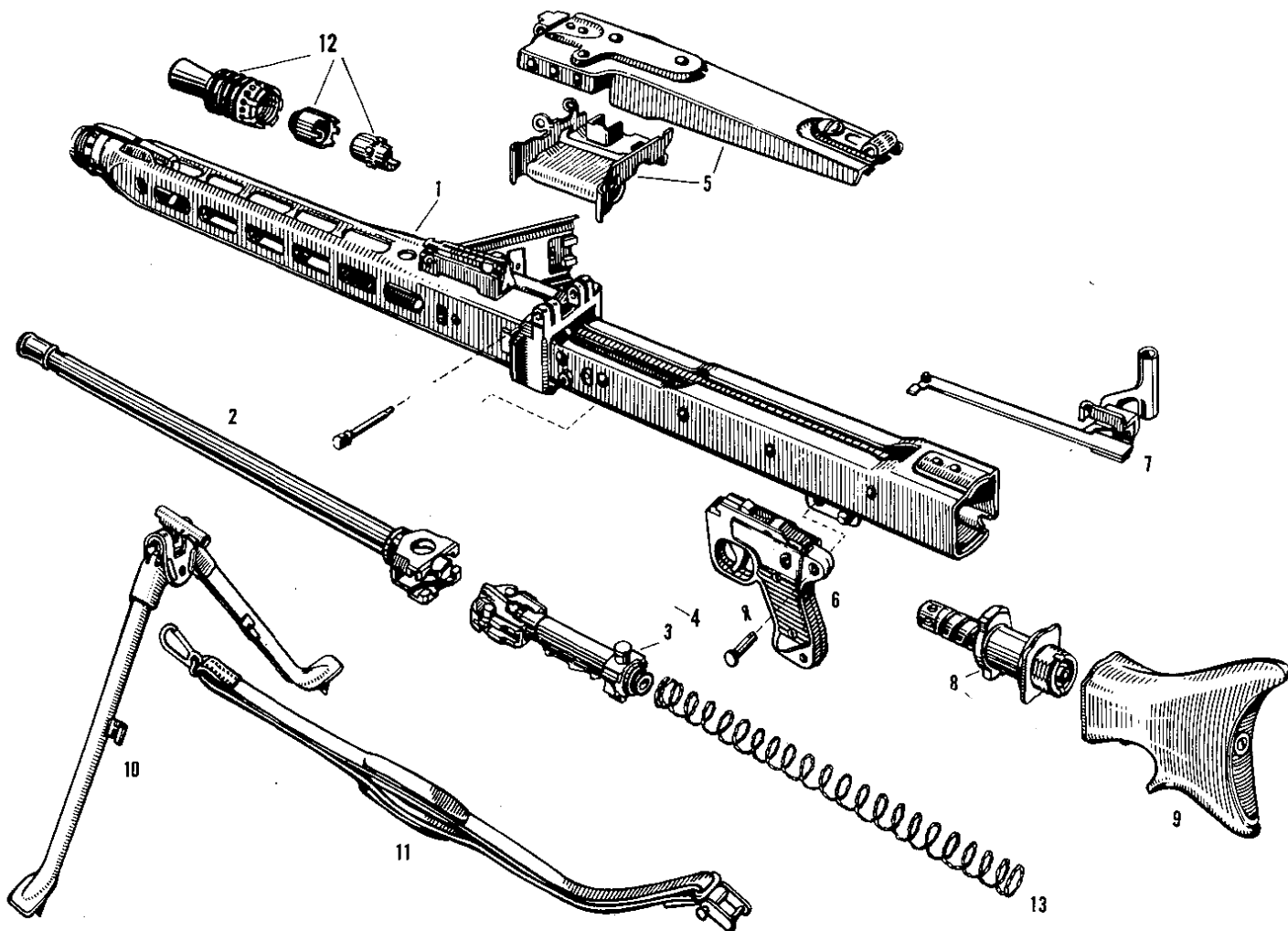

## Preliminary Remarks

The terms "righthand" and "lefthand" used in the following description of the assemblies and of the functioning apply to the position of the weapon in firing direction (seen from the gunner).

# Bolt Assembly

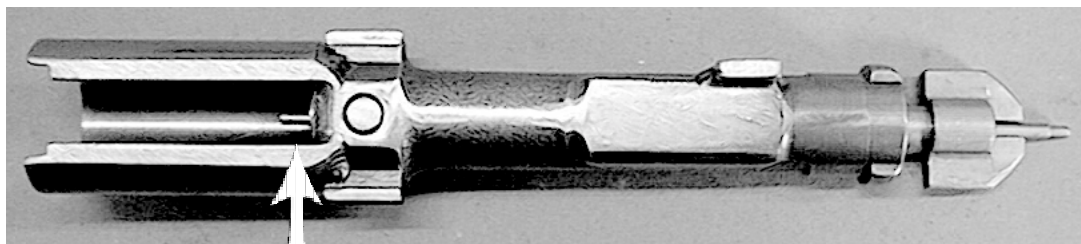
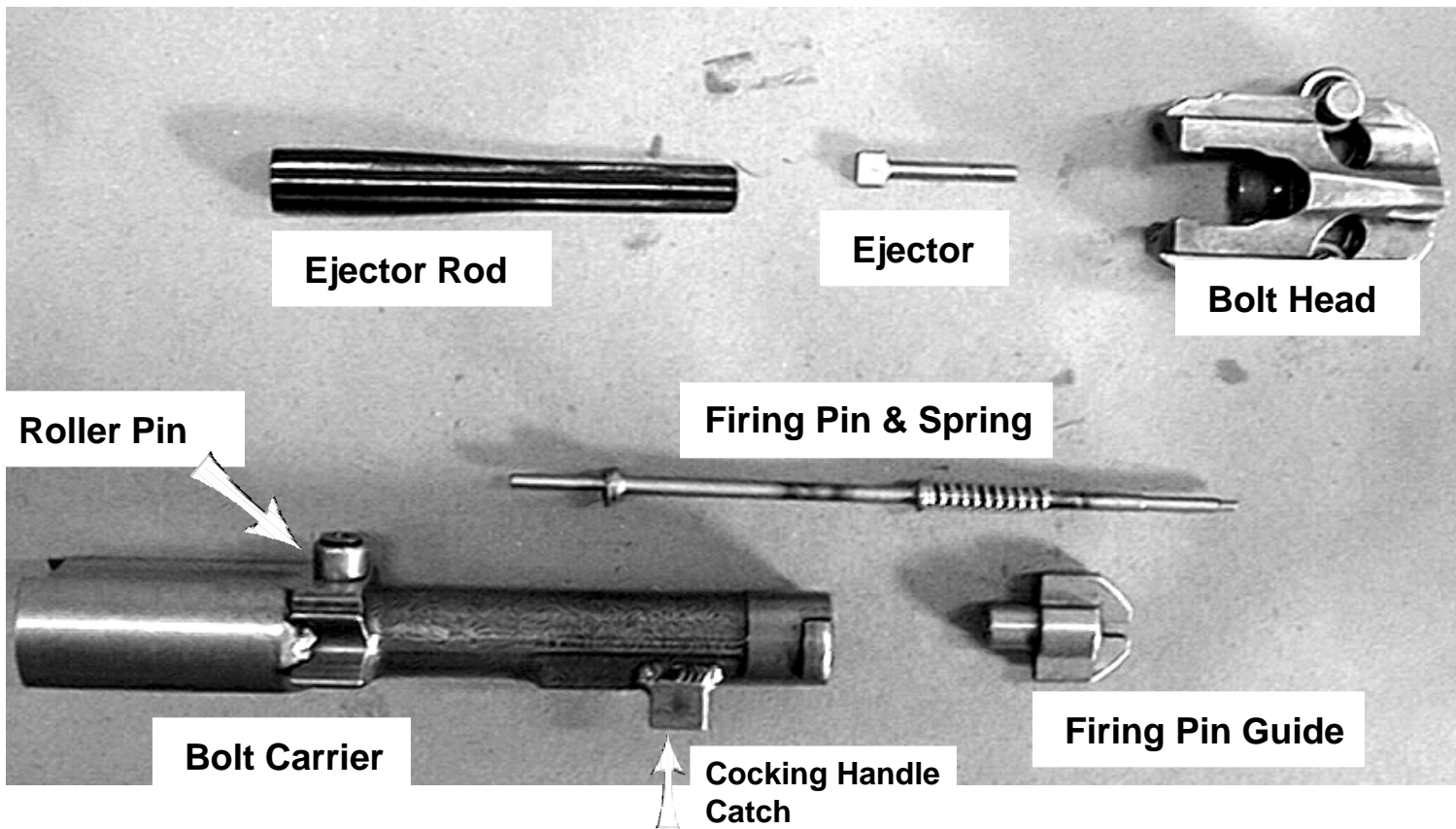
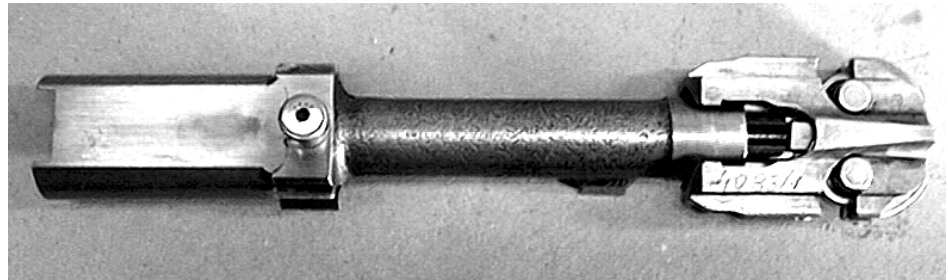

Proper firing pin placement

# Recuperator Assembly

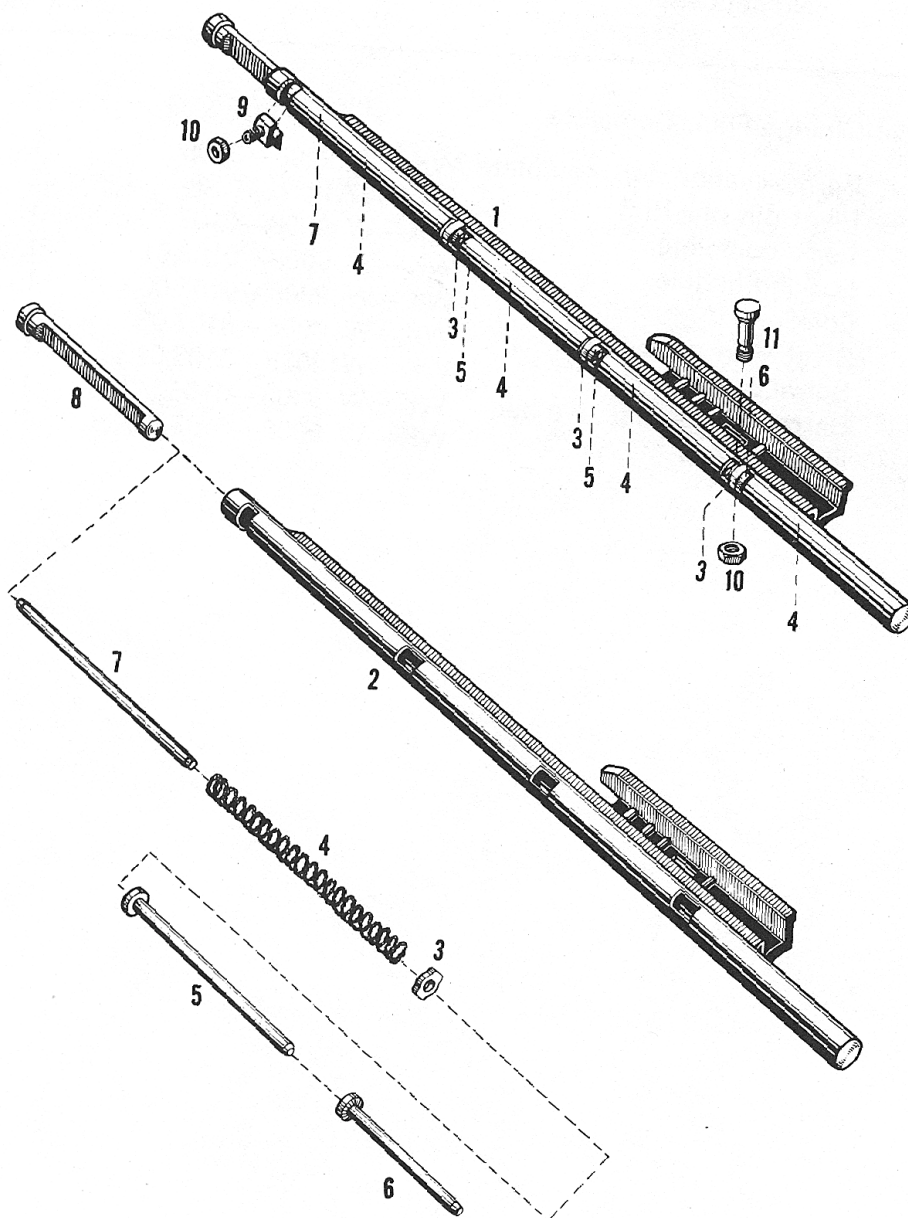

# Description

## 1. Housing

The front part of the housing guides the barrel and contains the recoil booster and nozzle as well as the barrel-guide sleeve. The lock for the recoil booster is located on top of the front part of the housing, and front-sight holder and front-sight are placed behind it. The front-sight holder can be folded to the housing. The front part of the housing is provided with openings permitting the barrel to cool. The long opening on the righthand side of the housing and the barrel-change flap enable the gunner to change the barrel. There are slots in the housing below the front-sight holder and a bit further towards the rear end where the bipod can be inserted, thus serving as front or center support.

The back-sight is located on top of the housing, halfway down the casing. The upper- and undersides of the sight leaf are provided with one graduation each. The graduation on the underside is used by the gunner in lying position after having folded up the sight leaf.

The front mounting support for mounting the gun on the tripod is situated underneath the housing at the height of the back-sight.

The trunion is located behind the back-sight. It serves as rear guide of the barrel and its worked-in curves unlock the bolt. The feed mechanism is fixed to the upper part of the trunion by swivel connection.

Underneath the feed mechanism the left- and righthand side of the housing are provided with one U-shaped slide rail each, in order to guide the bolt. The recuperator mechanism is mounted under the lefthand slide rail and pushes the recoiling barrel back into its front position when the round is being fired.

The pistol grip is fixed in the short U-shaped sheet part located at the underside of the housing. The pin behind the pistol grip, i.e. the rear mounting bolt, is used to fix the weapon on the tripod.

There is an opening for the ejection of the empty cartridge cases in front of the pistol grip.

The rear of the lower righthand side of the housing is slotted for the guidance of the cocking slide. There is a lock for the rear cover fixed outside, at the rear end, and at the underside of the housing. It prevents the rear cover from rotating. The rear cover is attached to the gun by a bayonet catch.

## 2. Barrel

The barrel consists of the proper barrel and the locking piece. The cartridge is ignited in the chamber of the barrel. The spiral grooves in the bore produce the righthand twist of the bullet. The locking piece is screwed on the barrel. It is provided with four rectangular cams for the rigid locking of the barrel with the bolt and has curves which accelerate the unlocked bolt. The locking piece has been designed symmetrically so that the barrel can be fitted into the housing in two positions, if turned by 180°.

## 3. Bolt

It consists of two principal assemblies: bolt head and bolt housing.

The extractor, connecting piece, and extractor spring are inserted in the lower part of the bolt head and one locking roll is located at each side of it, to the left and to the right,

During the forward motion of the barrel the firing-pin guide pushes the rolls apart and into locking position. During the backward motion of the barrel it accelerates the travel of the bolt housing. Both actions result from the different angular surfaces at the top edges of the firing pin guide. The bore-hole in the middle serves for the mounting of the firing pin.

The ejector is mounted from the rear, above the firing-pin guide, into the bolt.

The bolt housing contains firing pin, ejector rod, ejector stop, and roller pin with its spring. The ejector stop is retained by the roller pin which must be aligned to the transport lever of the feed mechanism.

## **5. Feed Mechanism / Cover**

The feed mechanism consists of feed cover and feed tray. Both parts are pivoted by the pivot on the curved piece of the housing. The feed mechanism which forces the filled cartridge belt into the weapon is situated in the cover. The forward and backward running bolt forces the transport lever to operate this mechanism. The transmission levers for the belt-feed pawl in the left front-part of the cover are supported by a spring bearing and push the cartridges into the runway of the bolt. The feed tray eases the insertion of the filled cartridge belt into the weapon and serves as slide support.

## **6. Pistol Grip**

The pistol grip contains trigger and safety device. The trigger mechanism allows semi-automatic fire. The trigger operates the sear and disconnecter for the hammer. The safety device consists of a pusher. The front of the pistol grip is inserted into the opening of the housing and its rear part is fastened by a pin.

## **7. Cocking Slide/Handle**

The cocking slide is inserted from the rear into the slot of the housing and pushed forward to the stop. It is used for cocking the weapon. The front catch of the cocking rail of the slide engages the bolt carrying it along while moving backwards. By pulling back the cocking slide the bolt unlocks and the recoil spring is cocked. The bolt and the barrel recoil together in locked position, against the pressure of the recuperator mechanism and of the recoil spring, until the unlocking curves of the curved piece will have forced the locking rolls into the bolt head in order to clear the locking. The barrel is immediately pushed forward again by the recuperator mechanism while the bolt is further pulled to its rear position overcoming the pressure of the recoil spring. The cocking handle on the cocking slide is capable of swinging out by approx. 90°, thus forming a prolonged lever arm which has to overcome the above-mentioned spring pressures and facilitates cocking. The catch is connected to the swinging cocking handle which keeps the cocking slide behind the lug of the housing thus preventing it from unwanted backward motion.

## **8. Rear Cover / Buffer**

The rear cover, which is inserted into the housing from the rear, contains the bolt buffer. The lock on the housing prevents the rear cover, locked by 90° by a bayonet catch, from self-loosening.

## **9. Butt**

If the weapon is used as a light machine gun, the butt serves as support of the gun on the shoulder of the gunner. It is attached to the rear cover and secured by rotation of 45° until the catch snaps in. When used from the tripod, most gunners prefer to remove the butt.

## **10. Bipod**

The bipod is used for front and center support if the weapon is employed as a light machine gun. The bipod with its saddle support is inserted in the front or center holder of the housing. The gunner must take care that the bar of the saddle support always points to the rear.

## **11. Sling**

The sling is used by the gunner in the following ways: for carrying the weapon while marching, for holding the weapon while advancing by bounds in combat, and for regulating the position of the weapon while firing from the hip. It is attached to the front of the housing by a spring safety hook and to the pistol grip by a clamp.

## **12. Recoil Booster, Recoil Nozzle, and Barrel-Guide Sleeve**

The recoil booster is the foremost part of the weapon. It is screwed on the thread of the housing, and a lock on the housing prevents the recoil booster from rotating. The recoil nozzle is located in the recoil booster.

The barrel-guide sleeve is inserted from the rear into the housing securing the front guide of the barrel.

## **13. Recoil Spring**

The recoil spring is located in the housing, between bolt and rear cover. It pushes the bolt, which has been thrown back by the recoil, forward again.



# How it Works

By pulling the cocking handle back, then releasing it such that the bolt strips and chambers the first round with significant force. The cartridge lying in the feed tray above the runway of the bolt is forced by the nose of the bolt head from the belt into the chamber of the barrel. The extractor engages in the extractor groove of the cartridge.

The slide rails in the housing prevent the locking rolls during the forward motion of the bolt from lateral evading until the bolt head has entered the locking piece. Then the locking rolls are able to follow the curve-shaped slots of the locking piece and lock the mechanism. The pressure of the recoil spring causes the bolt housing to press on the firing-pin guide with the firing pin. Moreover, the inclined planes of the firing-pin guide press the locking rolls outwards.

The firing pin ignites the cartridge when struck from the rear by the hammer.

During the second half of the forward motion of the bolt, the transport lever in the cover is pressed to the left by the roller pin of the bolt housing. During this operation, the second cartridge is pressed by the outside belt-feed levers to the righthand side, thus travelling in the feed way halfway towards the runway of the bolt. There, it is picked up by the inside belt-feed lever.

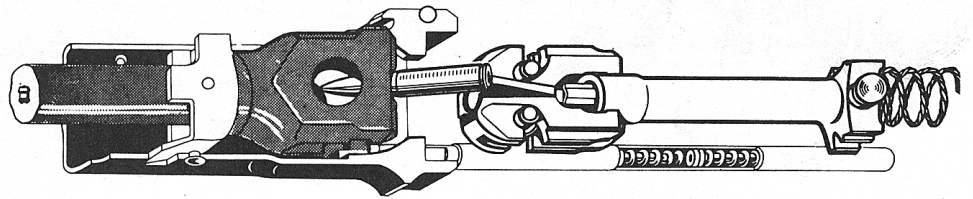

Fig. 4 Chambering of the cartridge

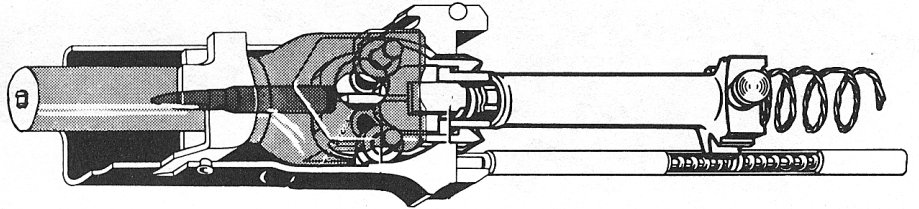

Fig. 5 Locking seen from above

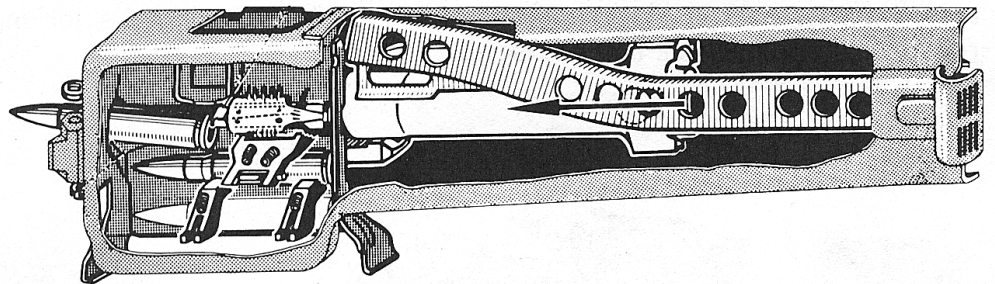

Fig. 6 Feeding of the cartridge

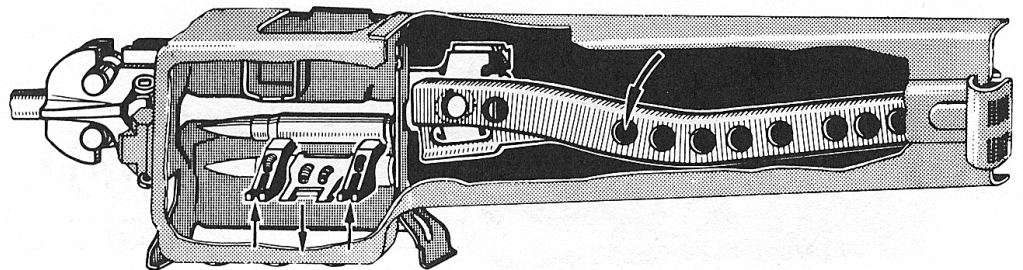
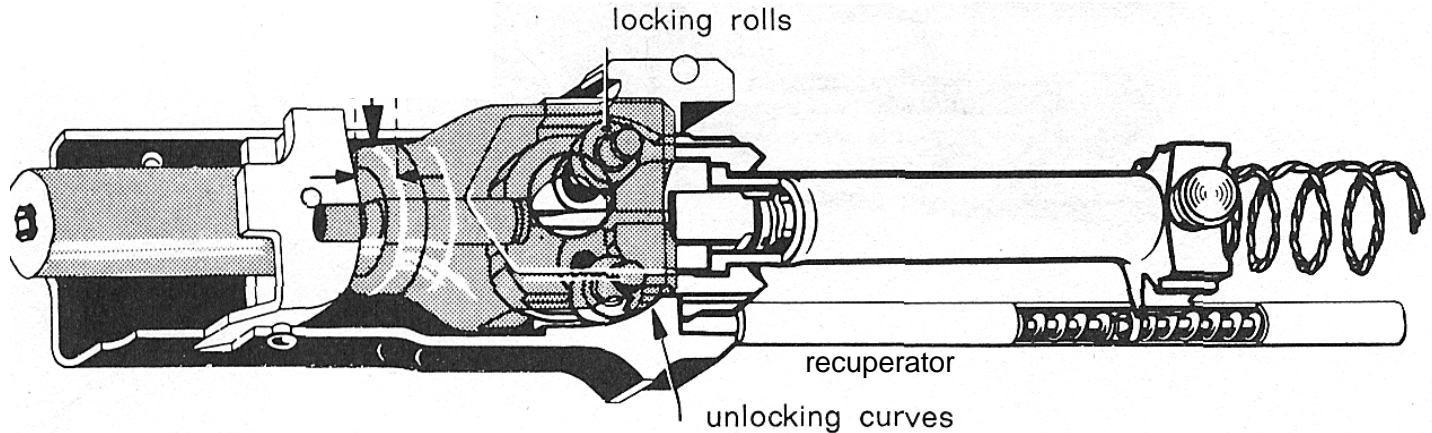
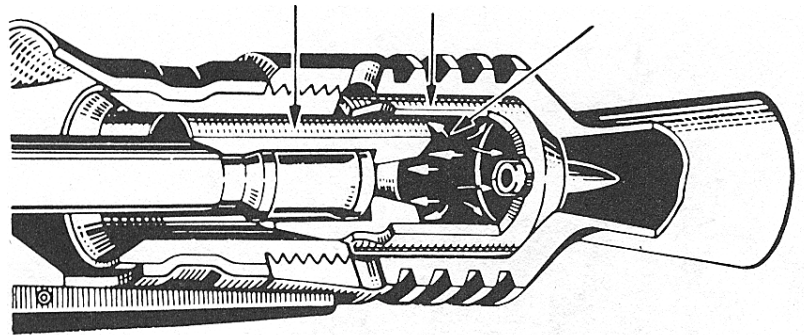

Fig. 7 The transport lever is pressed to the left by the roller pin.

The recoil forces the locked barrel backwards, assisted by the recoil booster. As soon as the bullet has left the barrel, gas stows in front of the nozzle bore causing a pressure on the front face of the barrel-guide sleeve and, by these means, on the barrel as well.



The locking rolls are only pressed inside by the unlocking curves of the curved piece after the bullet has passed the recoil nozzle. The barrel and the bolt continue their backward motion and unlock. During this operation, the speed of bolt head and bolt housing is higher than that of the barrel because of the locking rolls and differing curves. Now the bolt trips the barrel and moves to the rear. The barrel is pushed forward again by the recuperator mechanism. The bolt moves to the rear overcoming the pressure of the recoil spring and is finally stopped by the buffer spring. The rearward motion of the bolt causes the following reactions :

The extractor extracts the empty case from the chamber.

The second stroke of the feed mechanism pushes the cartridge into the feed tray slot and, by these means, into the runway of the bolt

Then the bolt strikes the buffer, the ejector, which is pushed forward by the rod and the bush, ejects the cartridge case from the underside of the housing.

The operations are repeated for each pull of the trigger.

# Disassembly Procedure

Opening and removal of feed cover

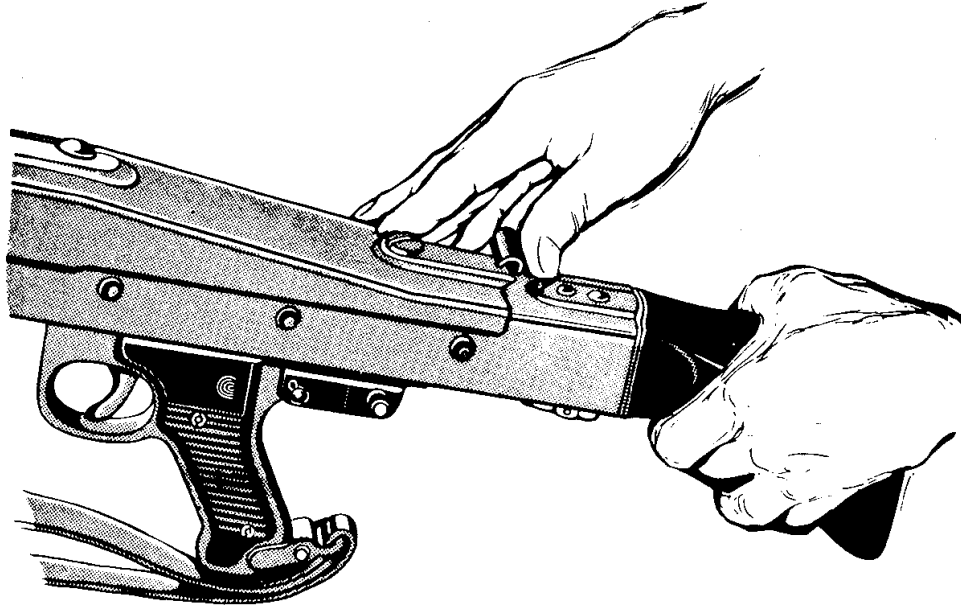

Fig. 10 Push cover catch forward

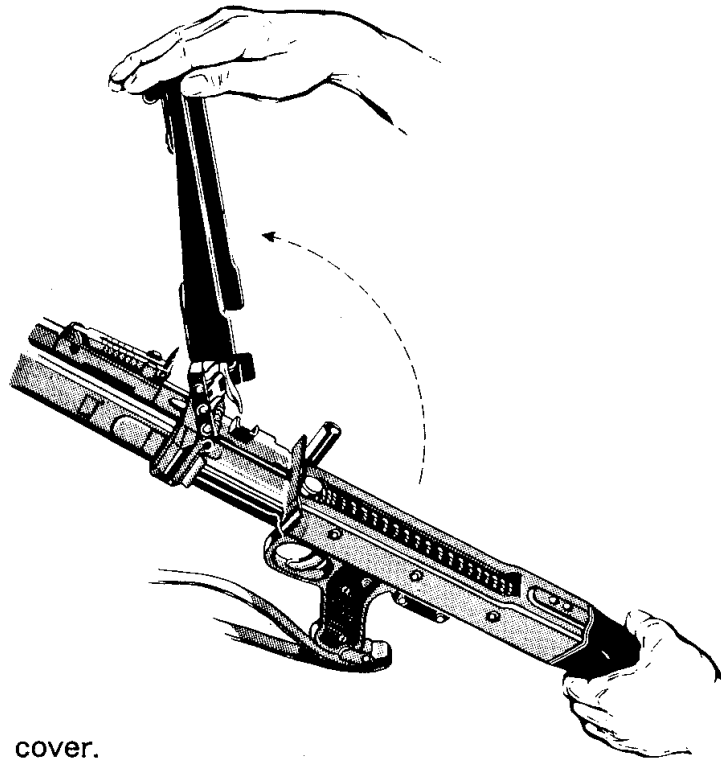

Fig. 11 Raise cover.



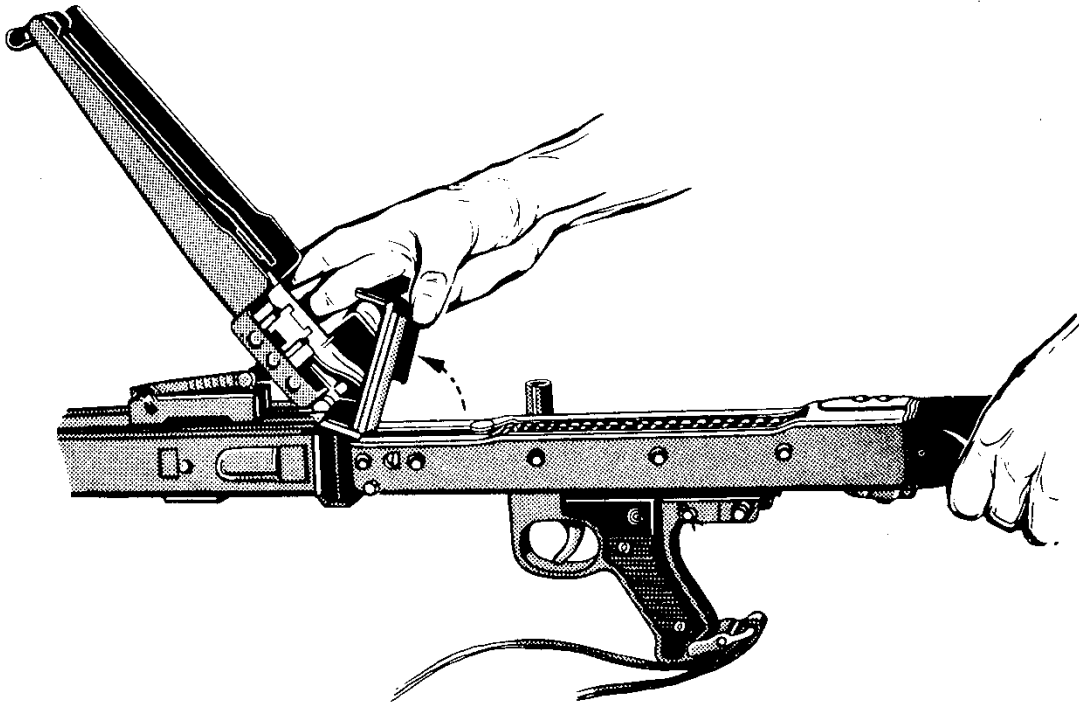

Fig. 12 Lift feed tray.

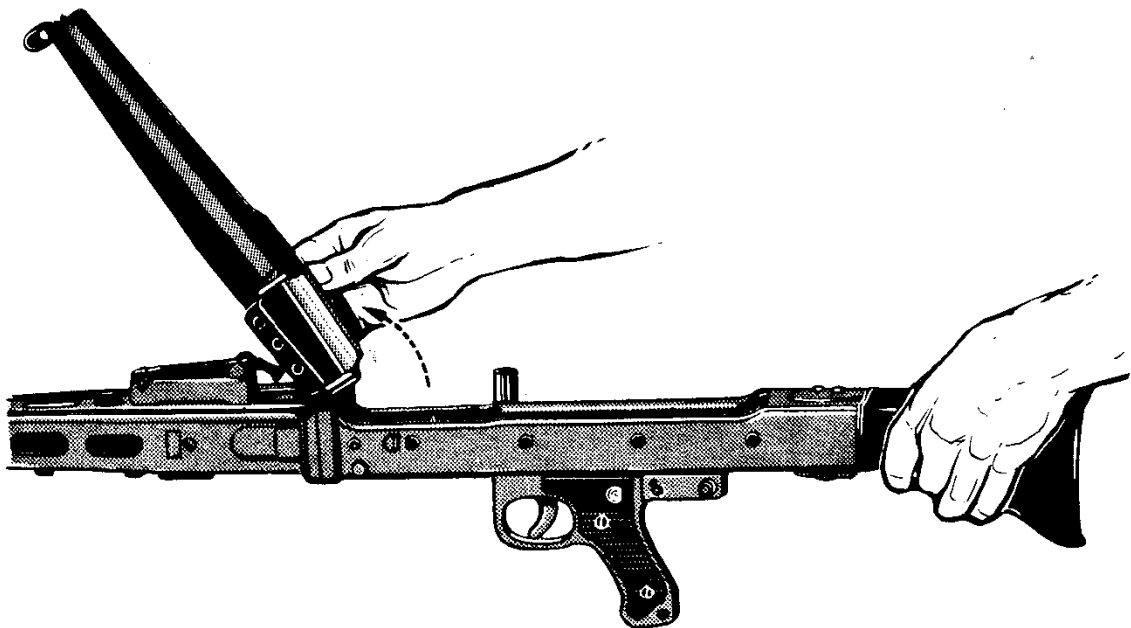

Fig.13 Press feed tray against cover.

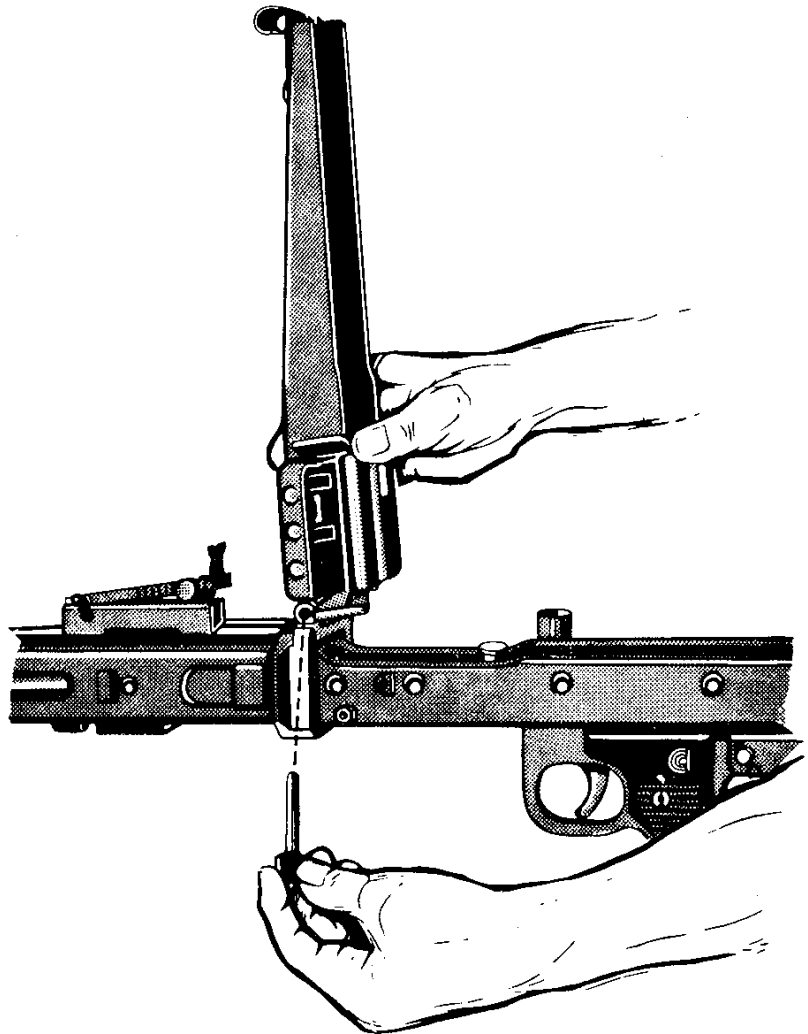

Fig. 14 Put feed cover and tray in vertical position to the axis of the bore and extract the pivot pin from the lefthand side. Take off feed cover and tray.

## Removal of rear cover and butt

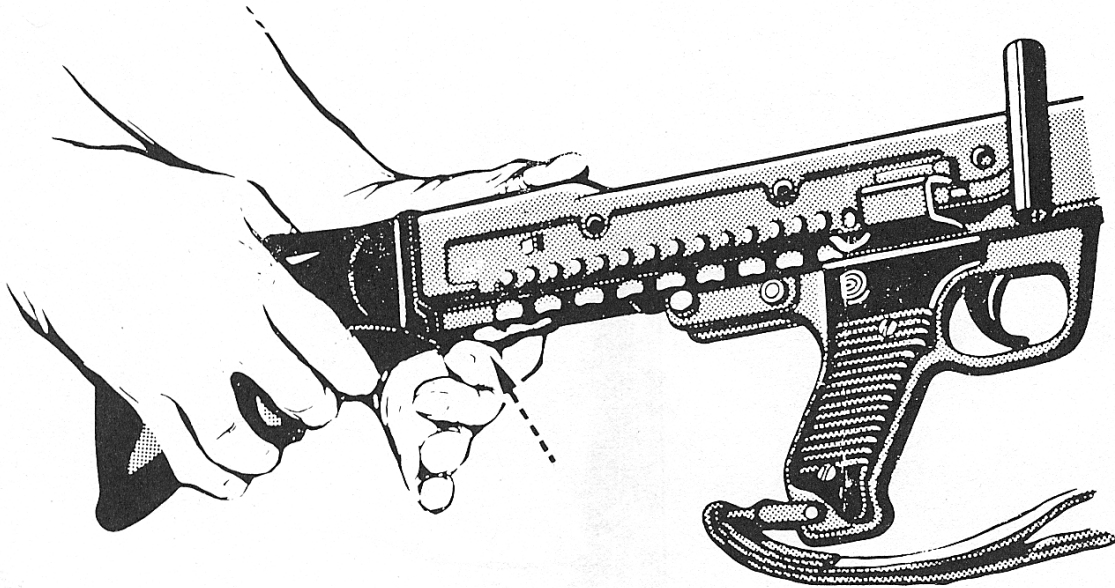

Fig. 15 Press lock of rear cover.

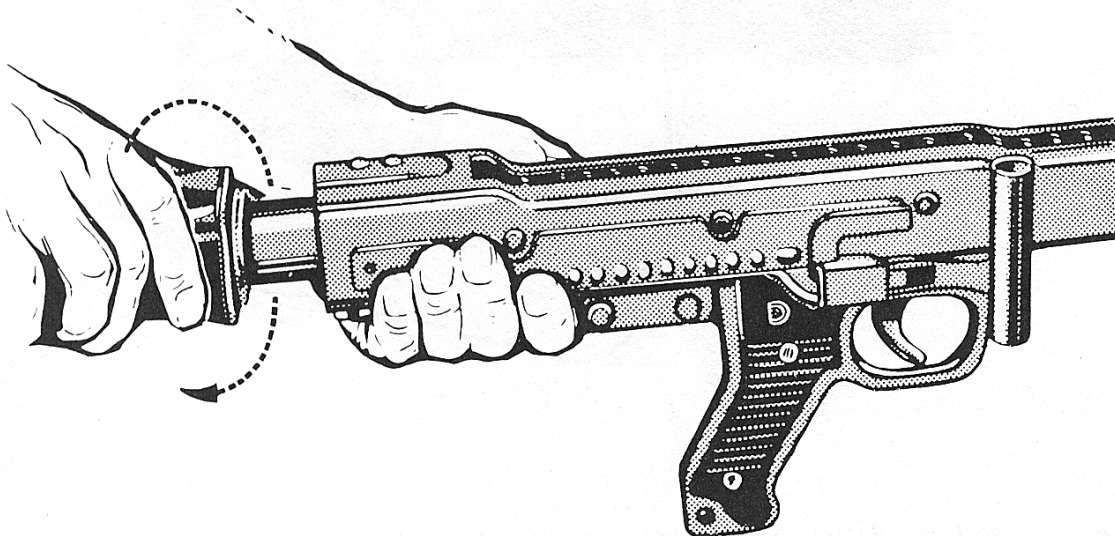

Fig. 16 Turn butt. Press slightly against reacting recoil spring. Now butt and rear cover are free to be removed from the housing.

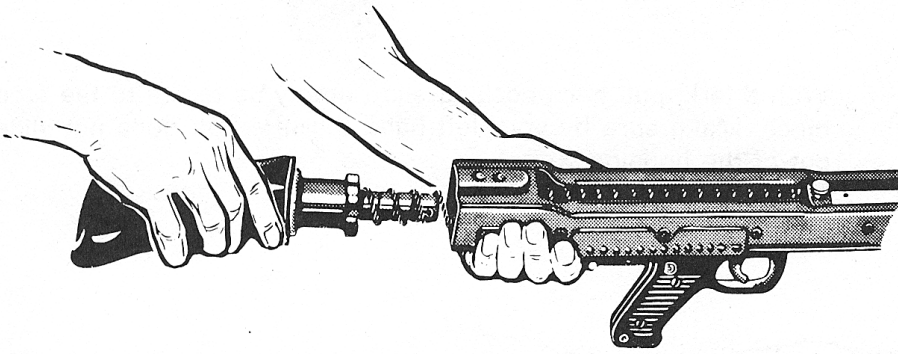

Fig. 17 Withdraw butt together with recoil spring towards the rear.

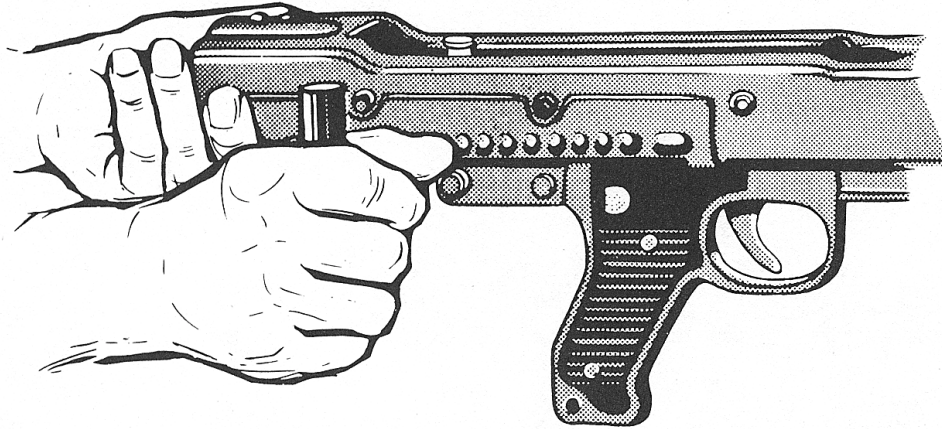

Fig. 18 With a jerk, pull back cocking slide nearly as far as to the stop piece. Make sure by your left hand that the bolt does not slide out of the housing.

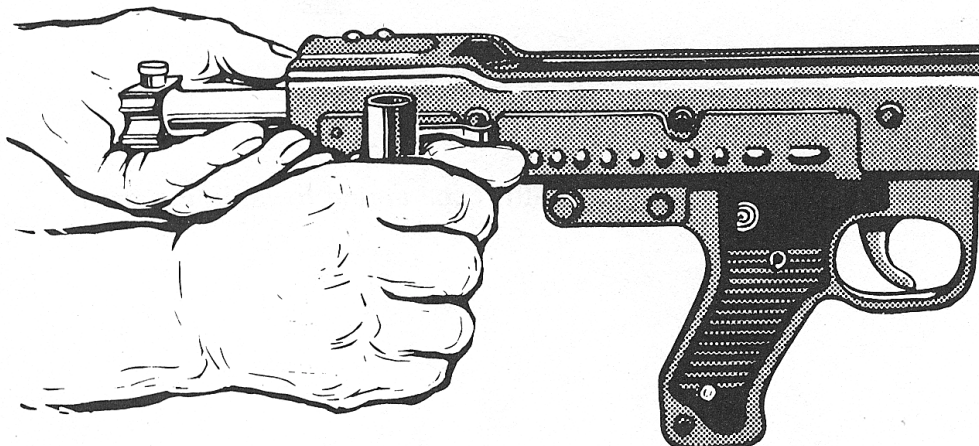
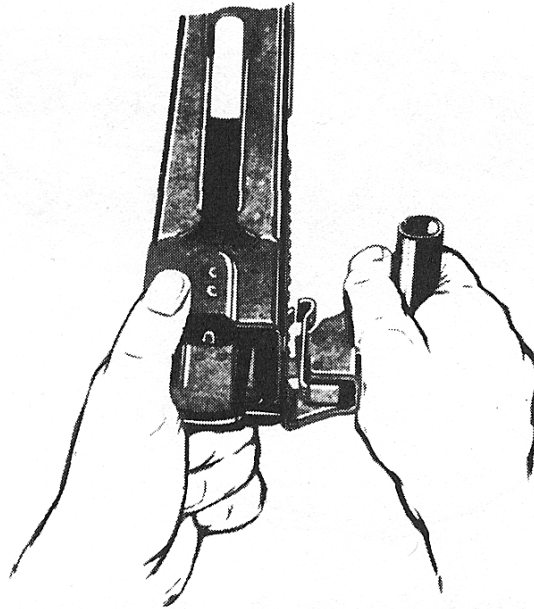
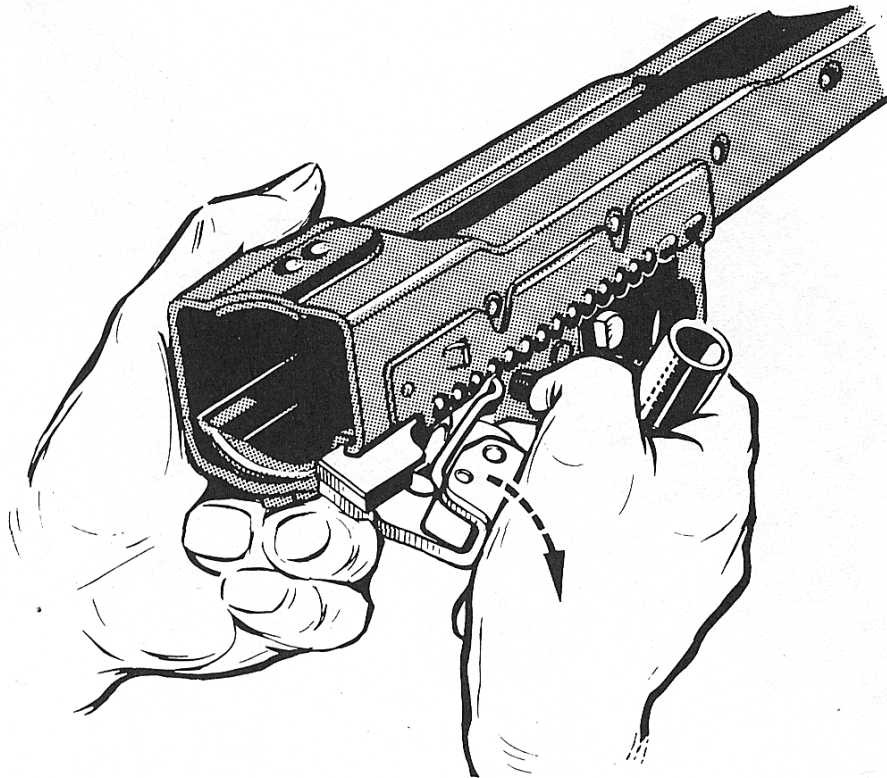

Fig. 19 Get hold of the bolt and take it out.





- 20 Pull back cocking slide to the stop piece. Traverse cocking handle towards the front until the catch is released.



- 21 Continue pulling back cocking slide, tilt it to the right, and take it out.

## Removal of barrel

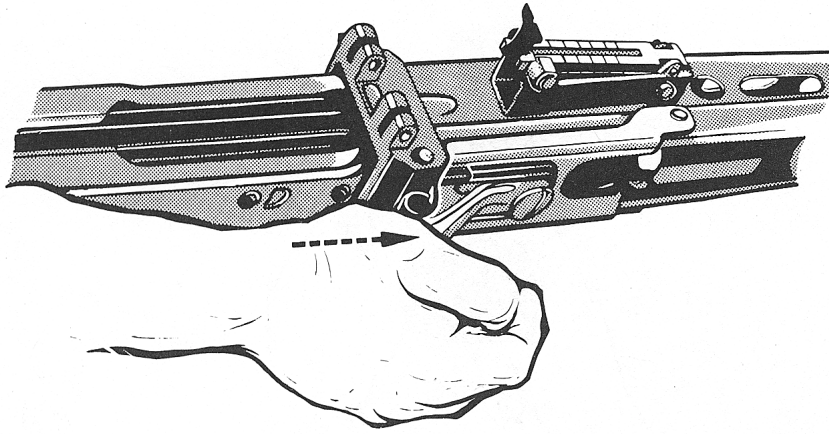

Fig. 22 Push locking handle of barrel-change flap with the ball of your right hand to the front.

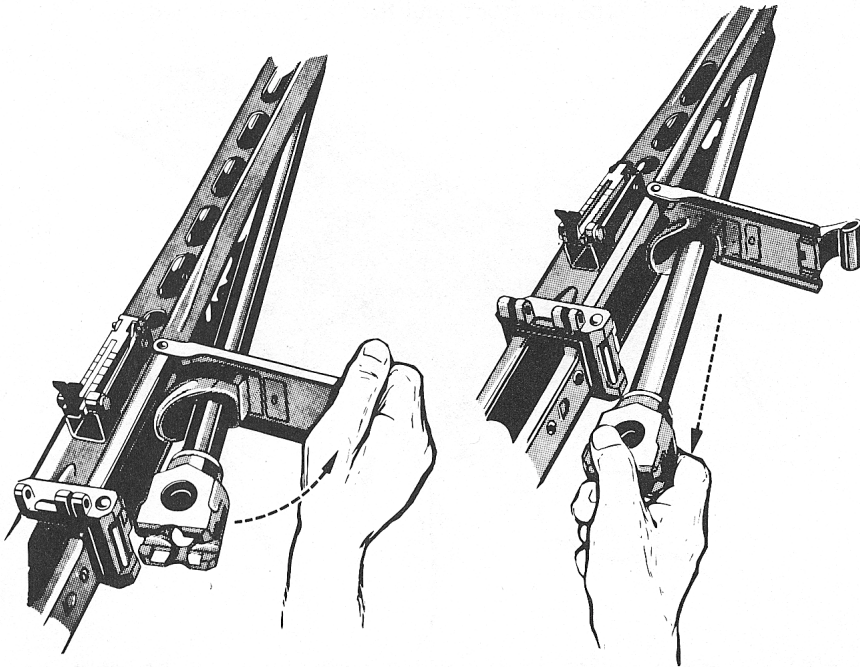

Fig. 23 Swing barrel-change flap fully out. Fig. 24 Remove barrel.

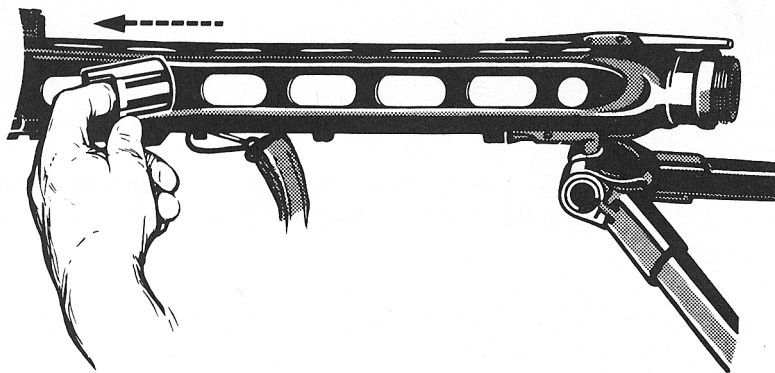
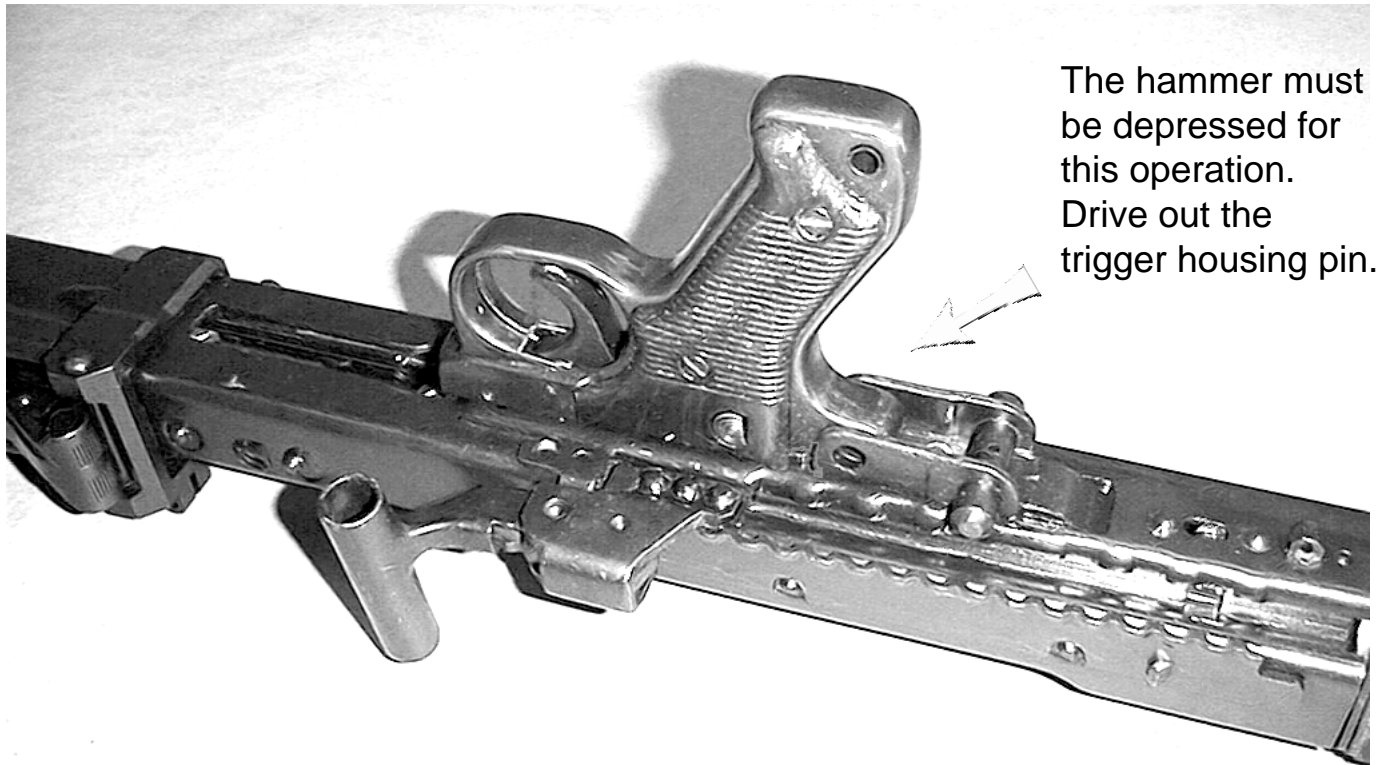

Fig. 29 Remove barrel-guide sleeve.



## Remove Trigger Housing



The hammer must be depressed for this operation. Drive out the trigger housing pin.

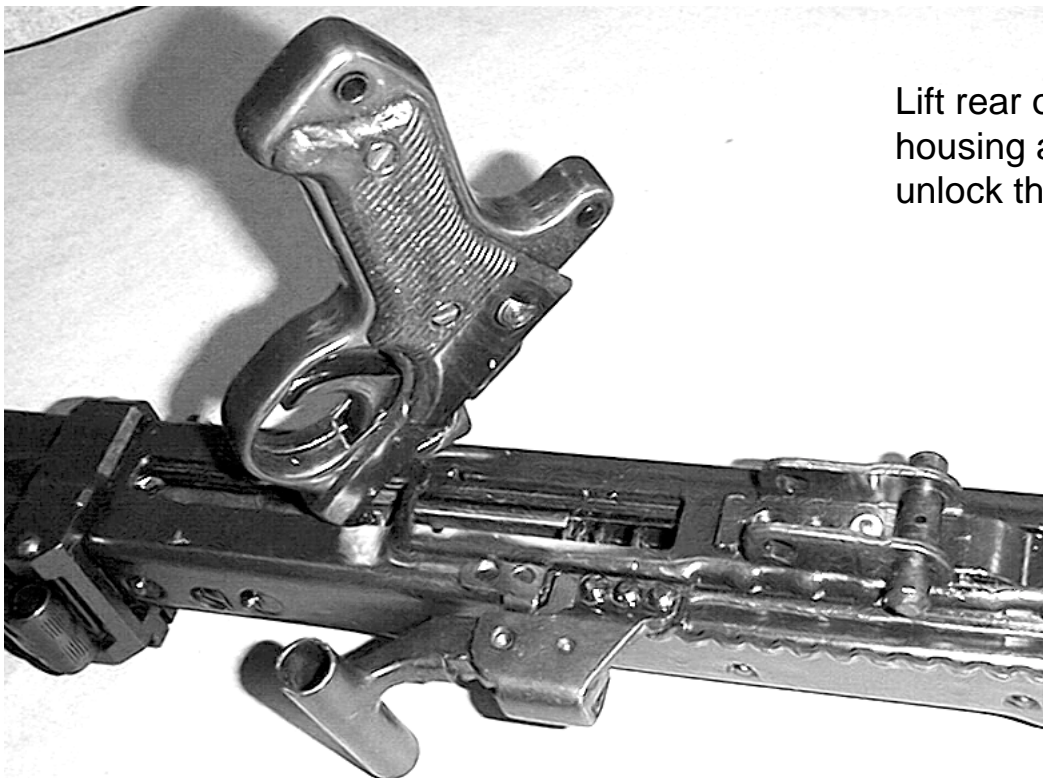

Lift rear of trigger housing and twist to unlock the front catch.

## Stripping of feed mechanism

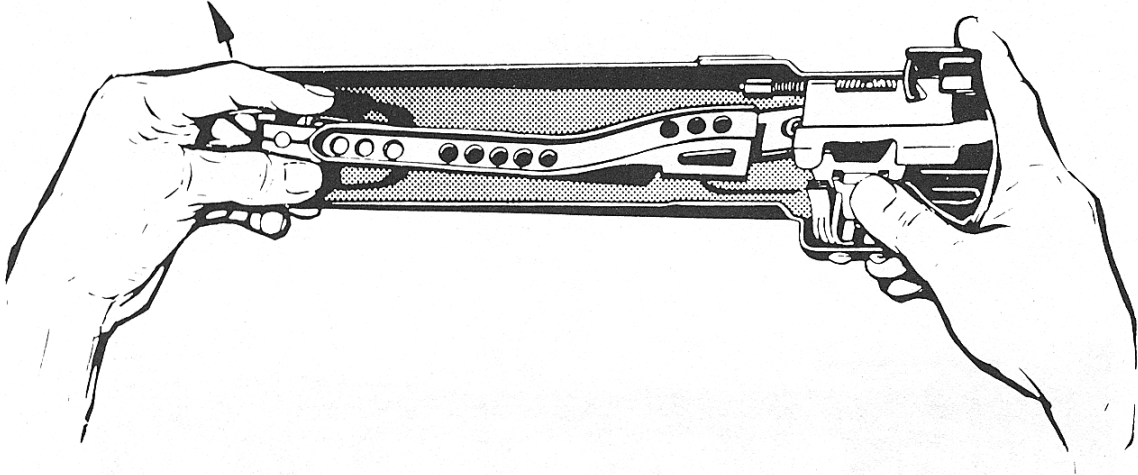

Fig. 30 Put feed cover upside down. Compress retaining spring at the rear end of the transport lever and lift this lever.

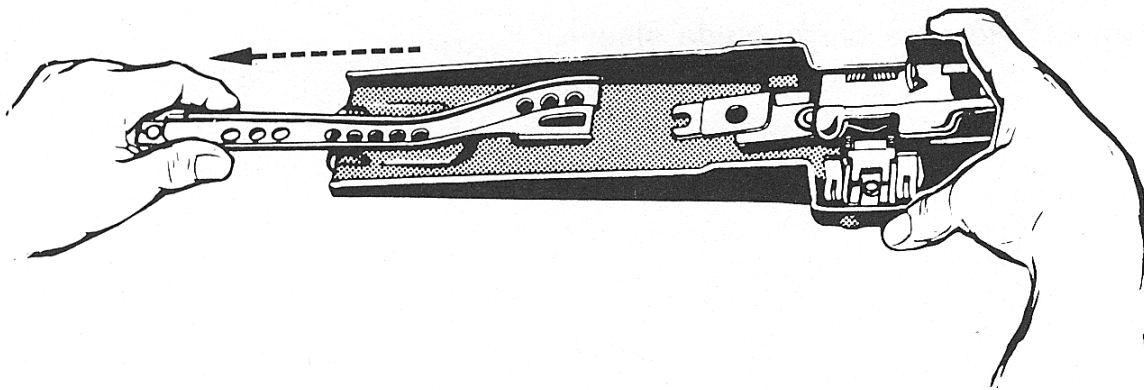

Fig. 31 Remove transport lever.



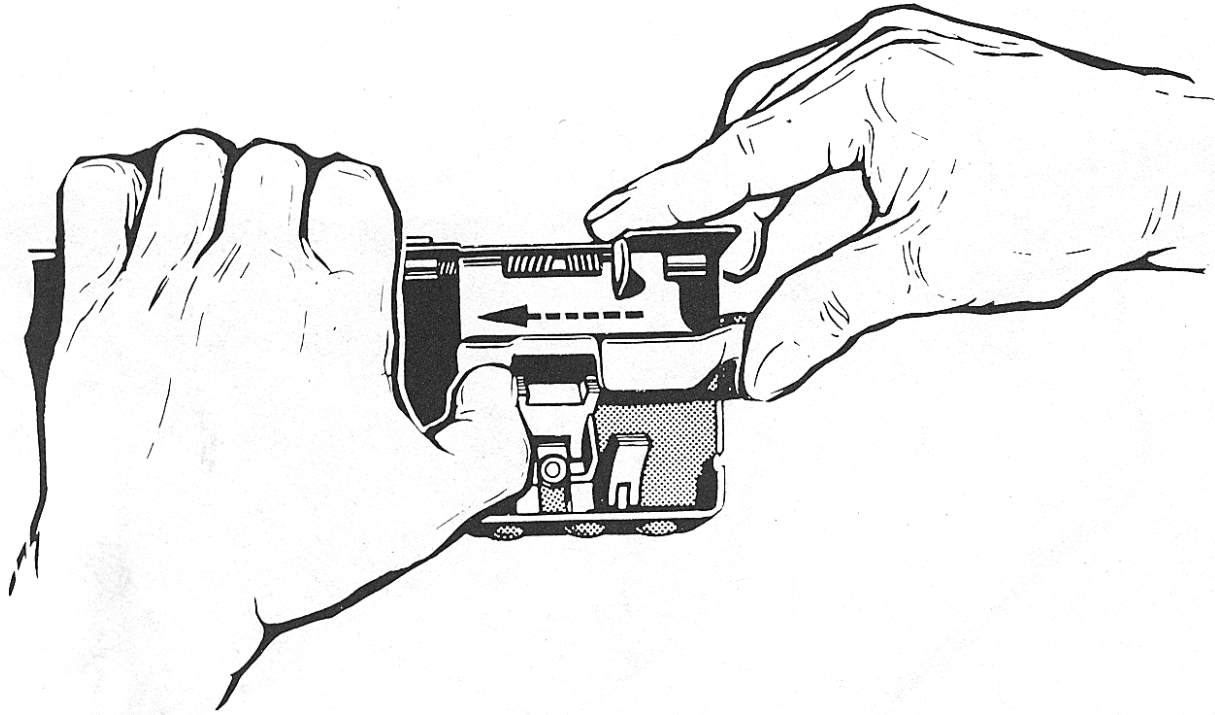

Fig. 32 Depress pressure plate overcoming the spring resistance. Push plate to the rear and fold it up.

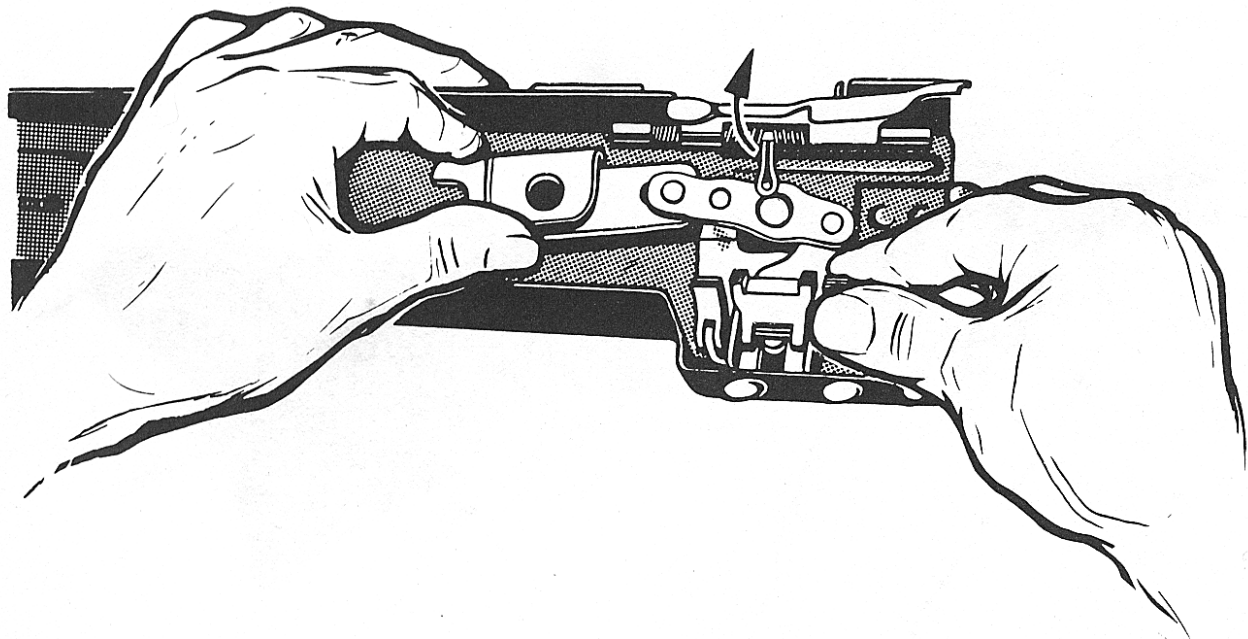

Fig. 33 Remove connection lever and belt-feed pawl by lifting them both at the same time.

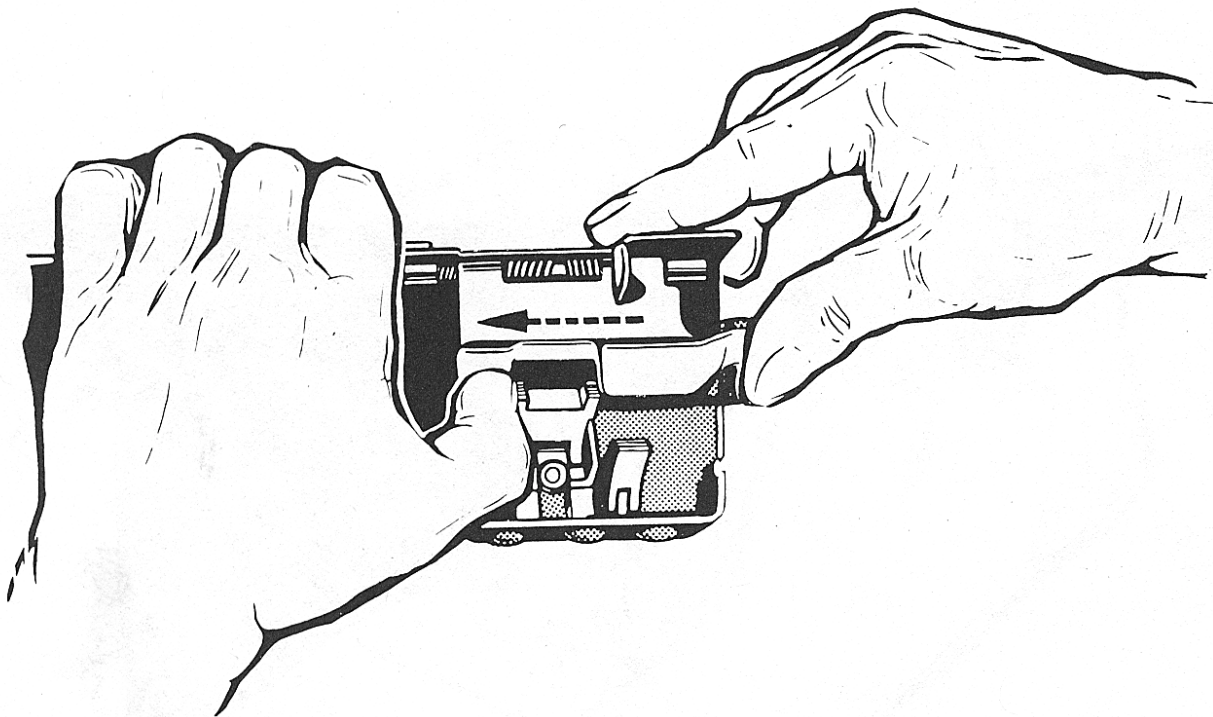

Fig. 32 Depress pressure plate overcoming the spring resistance. Push plate to the rear and fold it up.

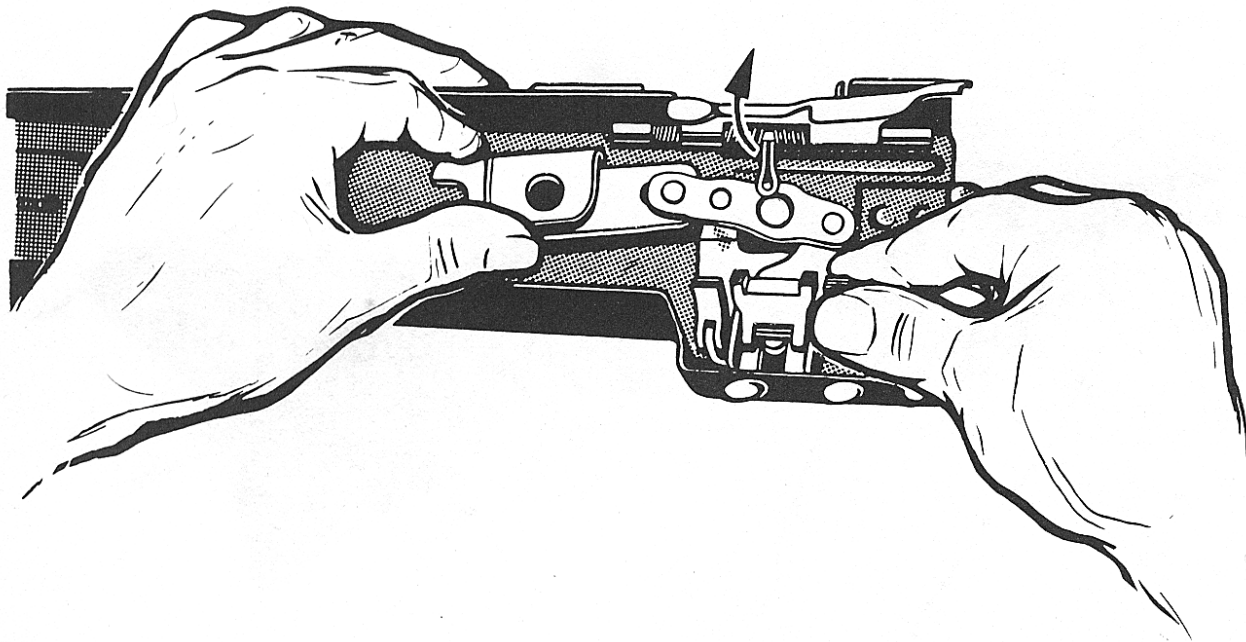
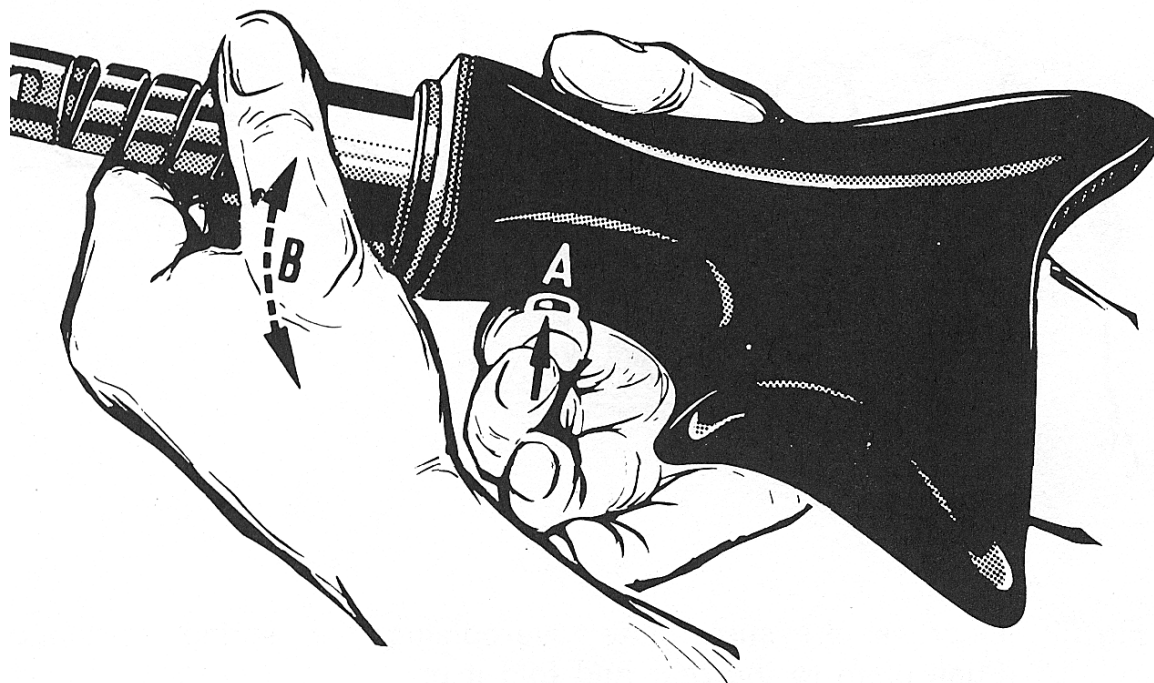
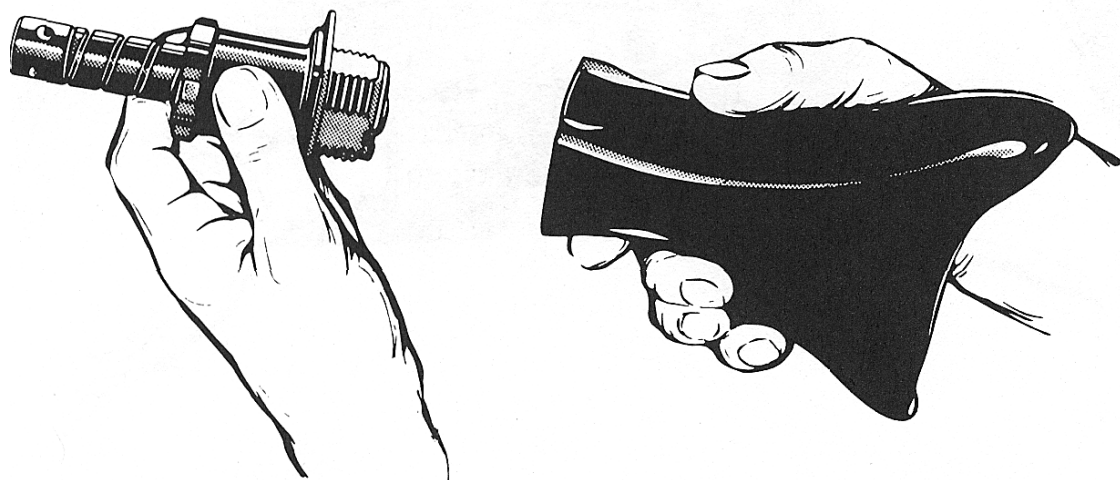

Fig. 33 Remove connection lever and belt-feed pawl by lifting them both at the same time.





g. 34 Press butt catch (A) and turn rear cover in clockwise or anti-clockwise rotation.



g. 35 Remove rear cover.

# Assembly Procedure

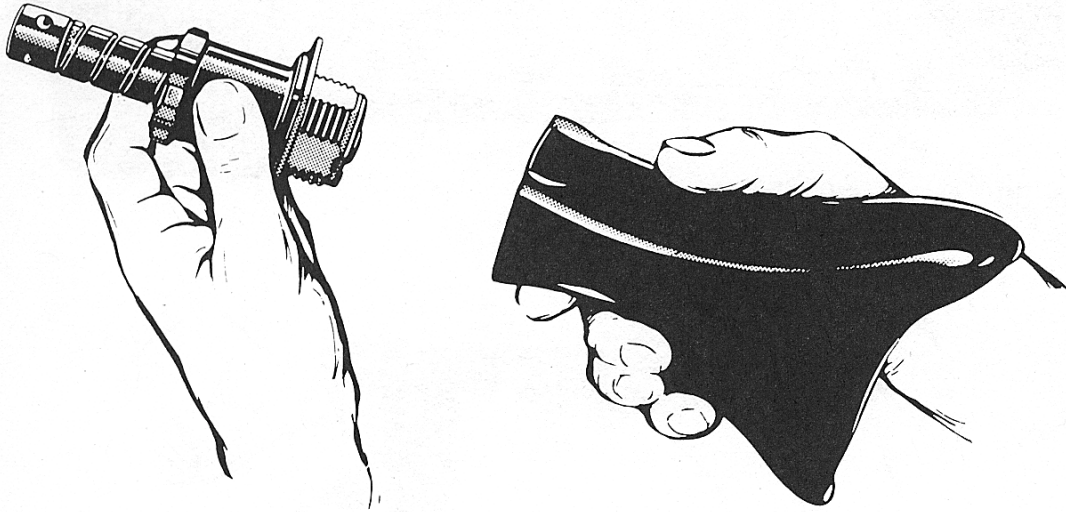

Fig. 56 Hold rear cover with the large recess of the rear face pointing to the floor.

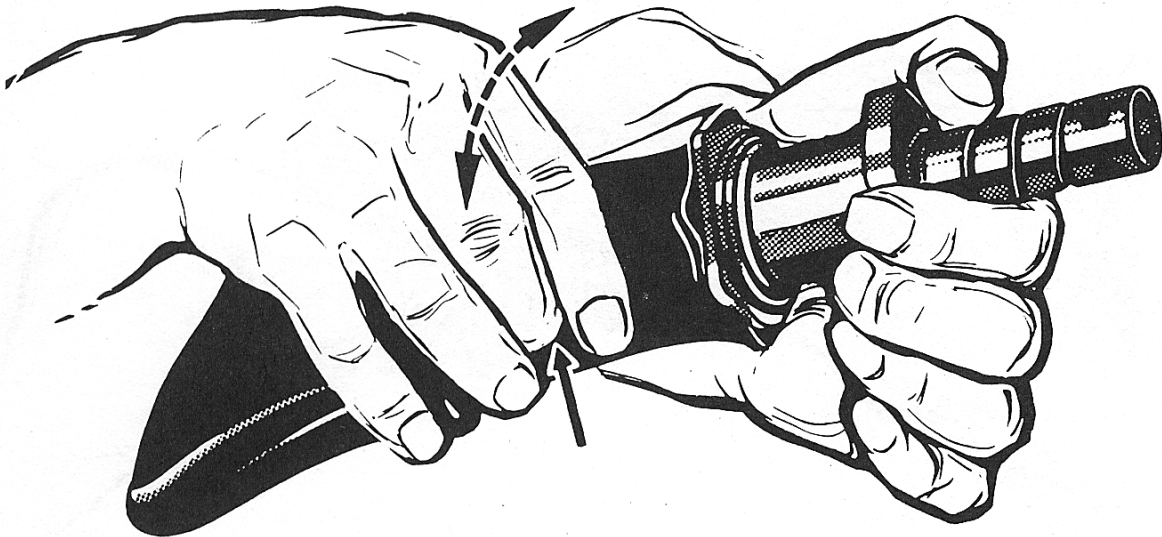

Fig. 57 Press butt catch and let butt slide over the rear cover. Turn butt in clockwise or anticlockwise rotation until the catch snaps in.



## Assembly of feed cover

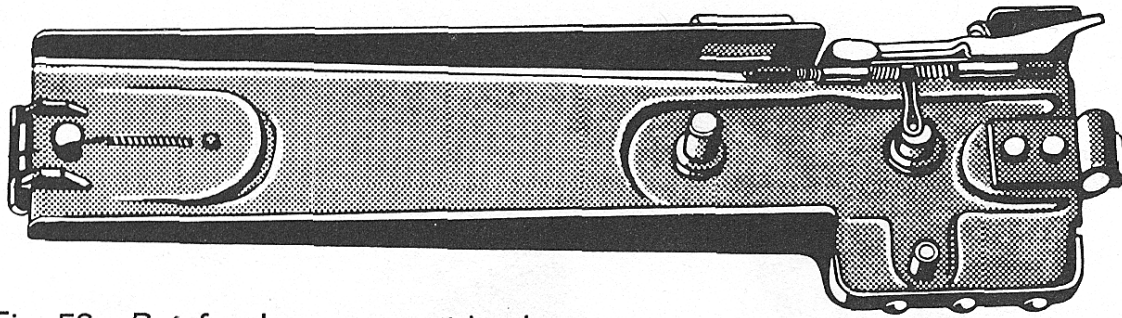

Fig. 58 Put feed cover upside down.

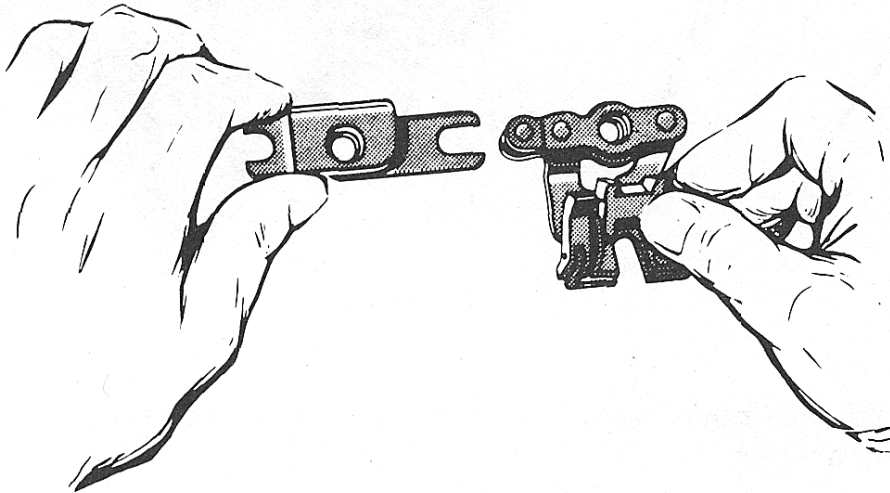

Fig. 59 Connect belt-feed pawl with connection lever, the cranked part of the connection lever pointing upwards.

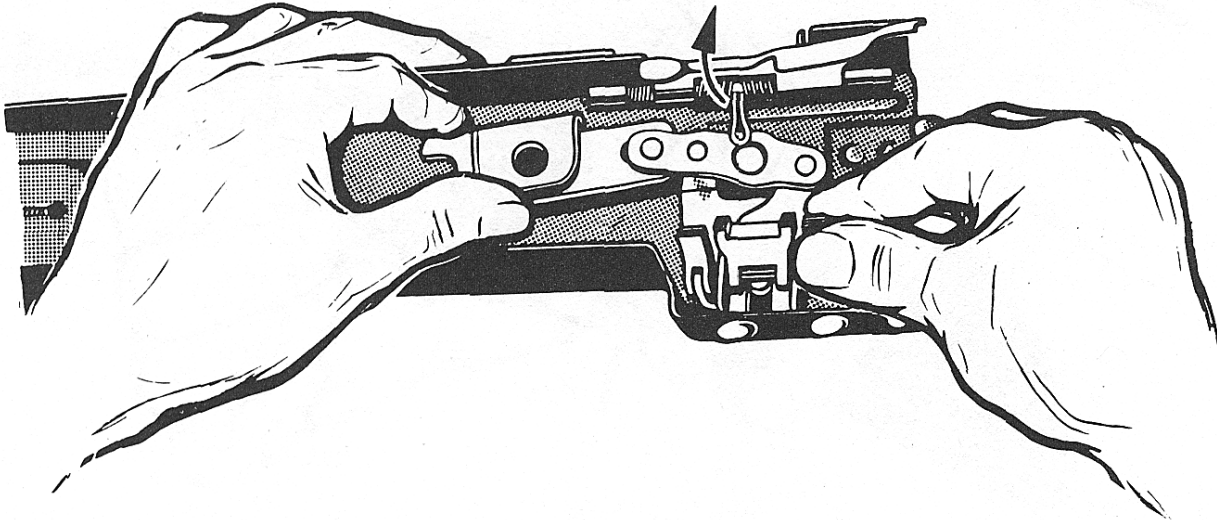

Fig. 60 Lift pressure-plate spring and put it together with the pressure plate on the pivot pins in the cover. Check whether parts work smoothly.

## Assembly of barrel-guide sleeve

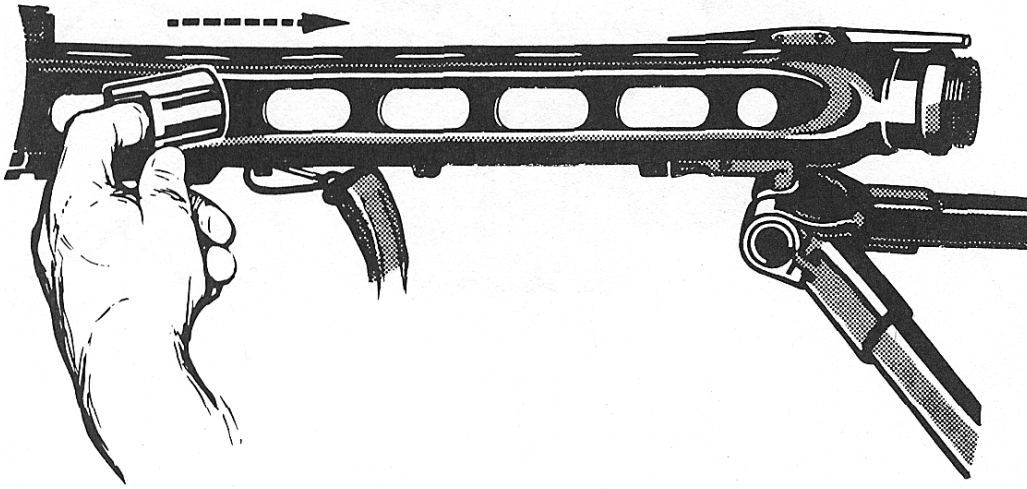

Fig. 63 Insert barrel-guide sleeve with the milled-out part pointing to the rear and to the righthand side (in firing direction).

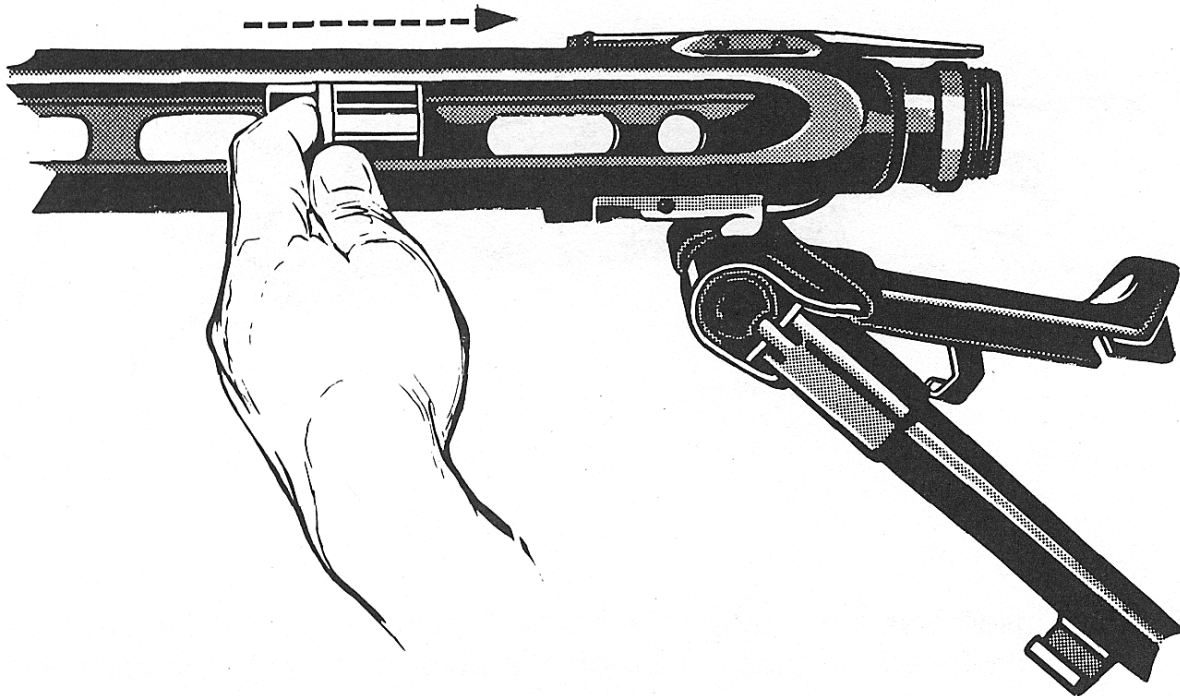

Fig. 64 Push barrel-guide sleeve forward.



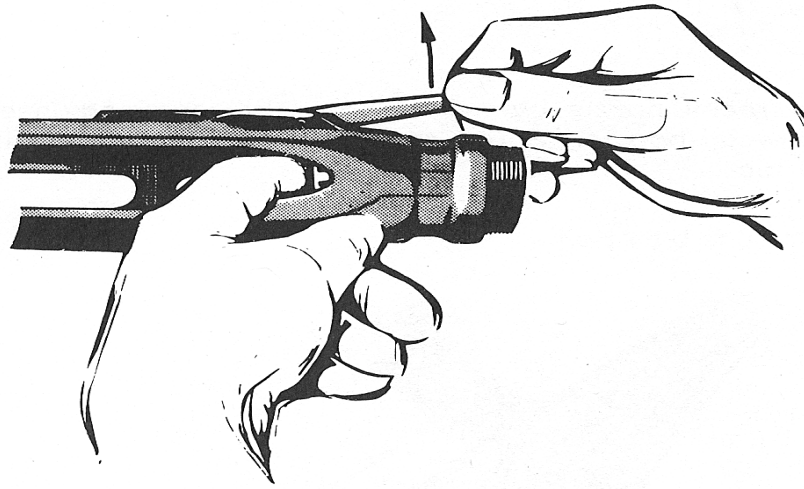

Fig. 65 Raise lock and check whether barrel-guide sleeve moves smoothly inside the guide groove.

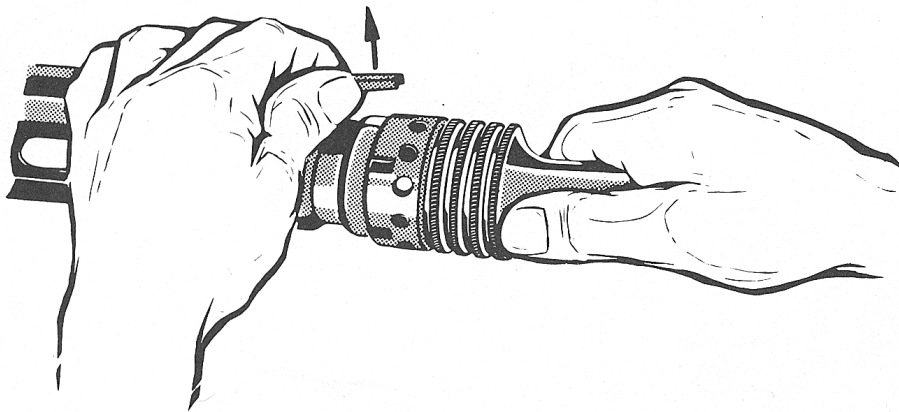

Fig. 66 Slip recoil nozzle over barrel-guide sleeve and insert it into the recoil booster. Screw the latter onto the stop while raising the lock.

#### Insertion of barrel

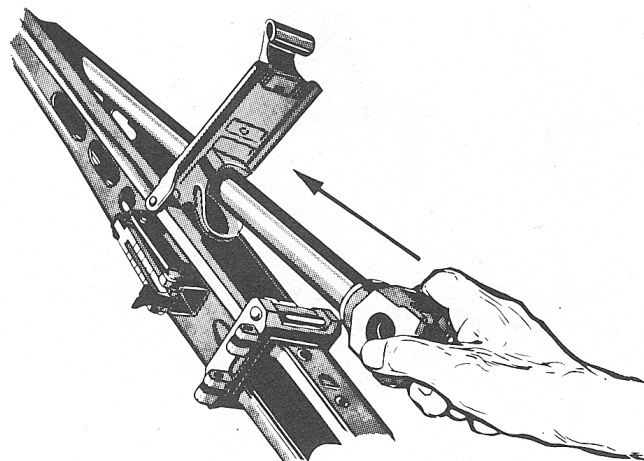

Fig. 67 Push barrel inside until it reaches the stop and insert locking piece towards the left into the housing. Close barrel-change flap.

## Insertion, of cocking slide

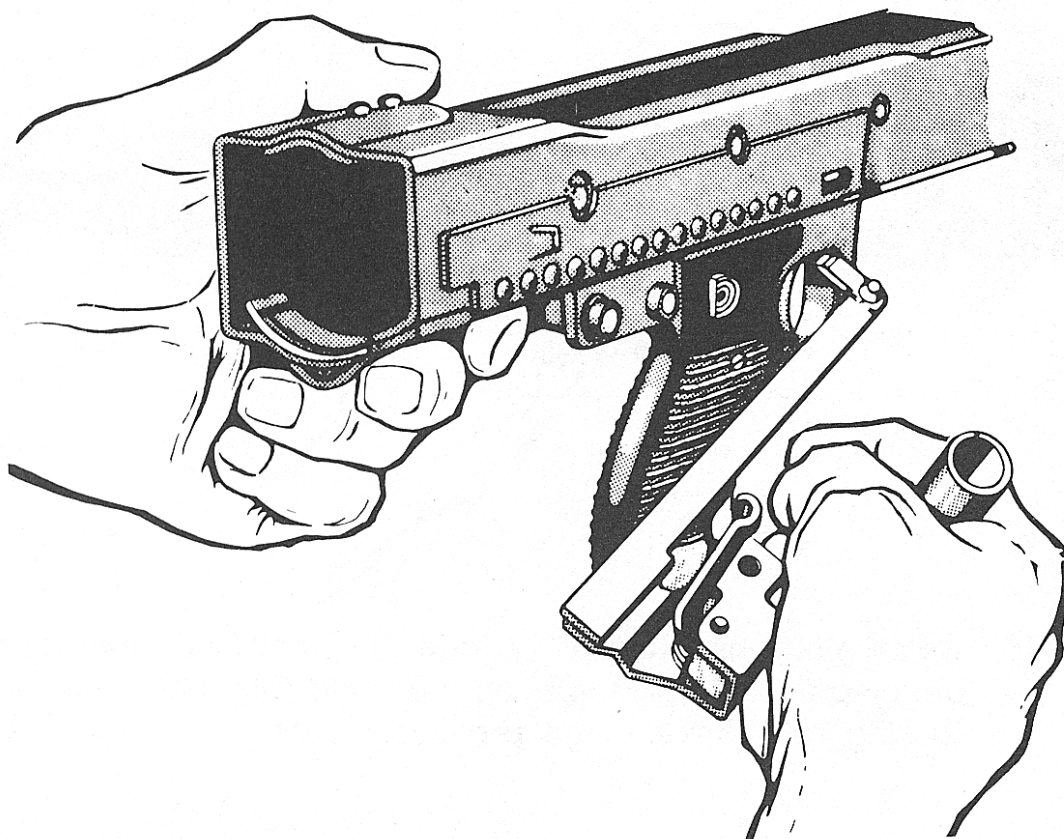

Fig. 68 Insert cocking slide obliquely from the righthand side into the opening at the bottom edge of the housing.

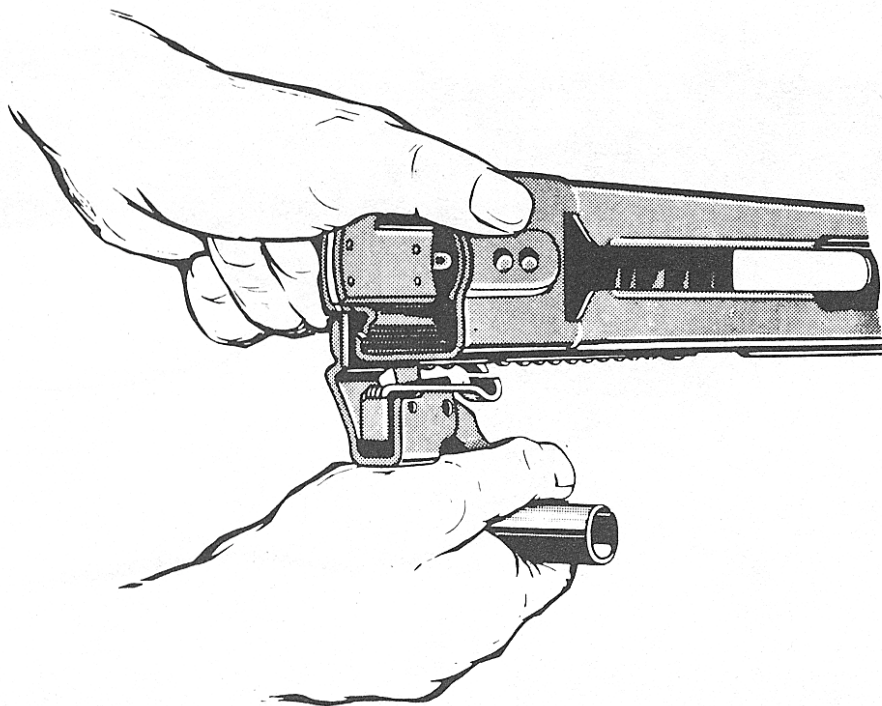
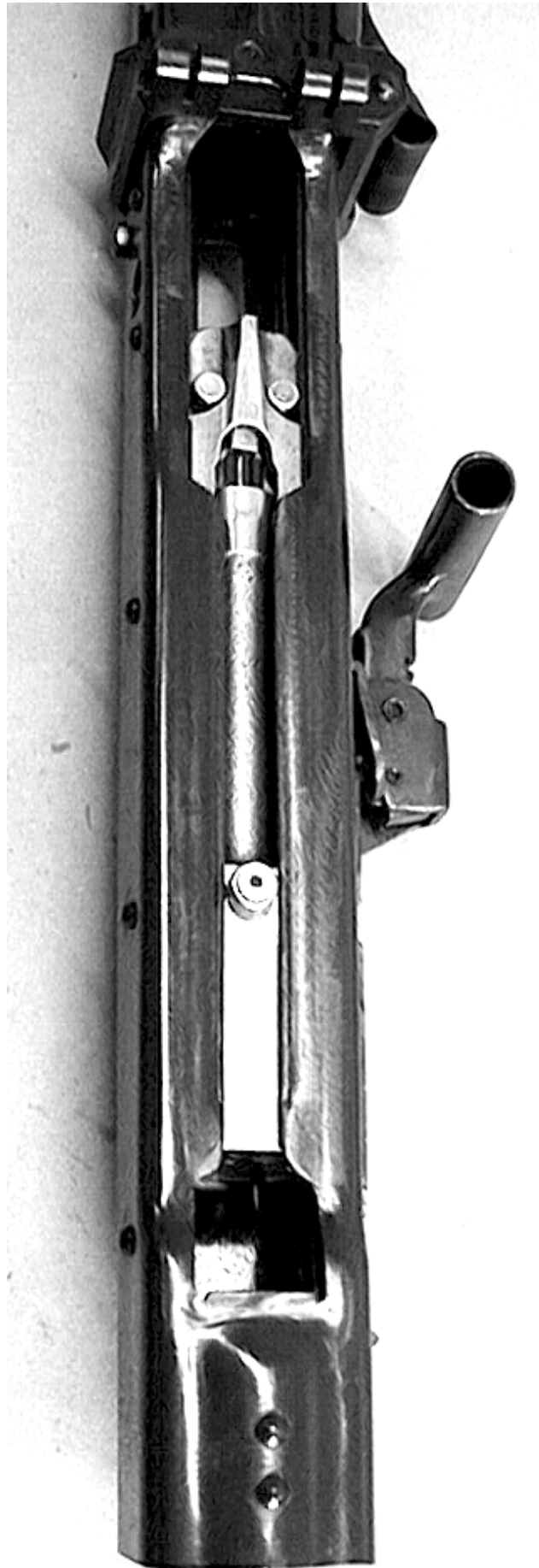

Fig. 69 Adjust cocking handle and cocking slide and push them forward.



## Insert the Bolt

Make sure the bolt slides freely in the receiver body.



## Attach the Trigger Housing

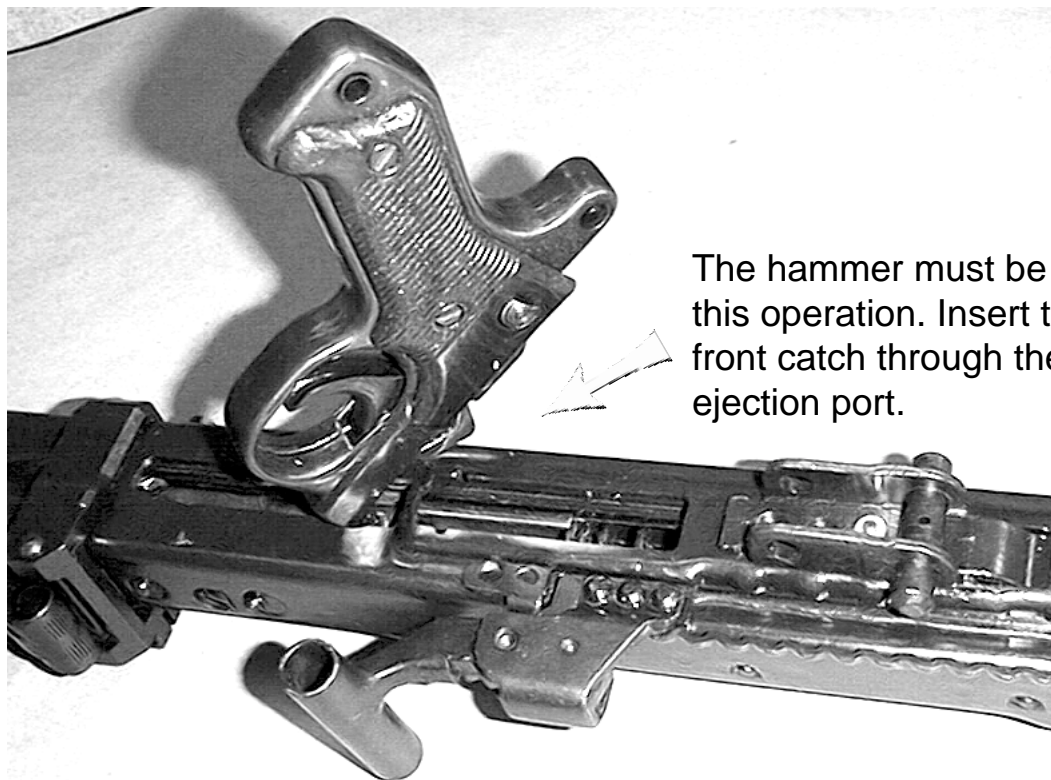

The hammer must be depressed for this operation. Insert the trigger housing front catch through the back of the ejection port.

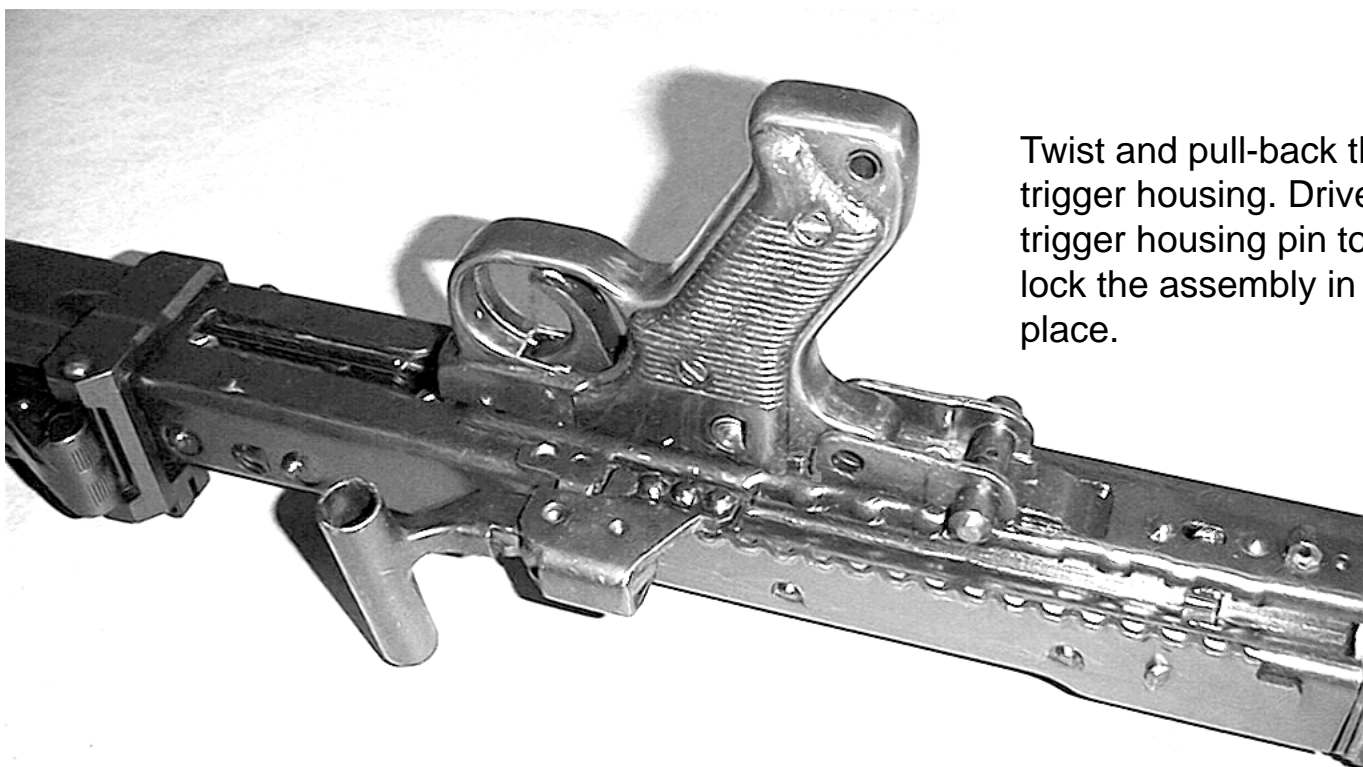

Twist and pull-back the trigger housing. Drive the trigger housing pin to lock the assembly in place.

## Buffer and Mainspring Insert

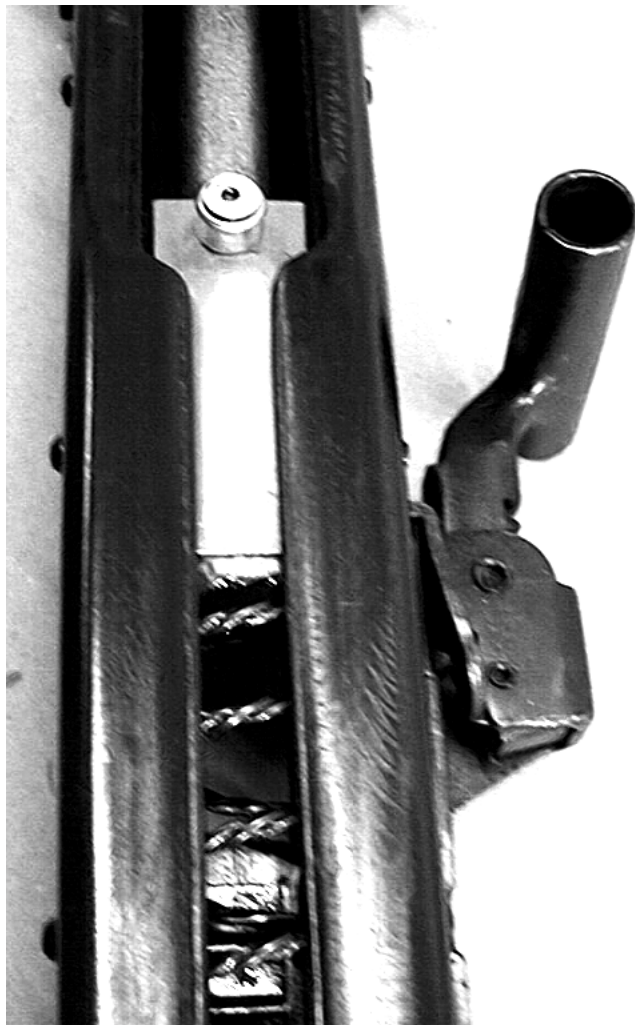

Insert the closed end of the mainspring into the receiver making sure that it is properly seated in the rear of the bolt carrier and the open end is seated at the base of the buffer.

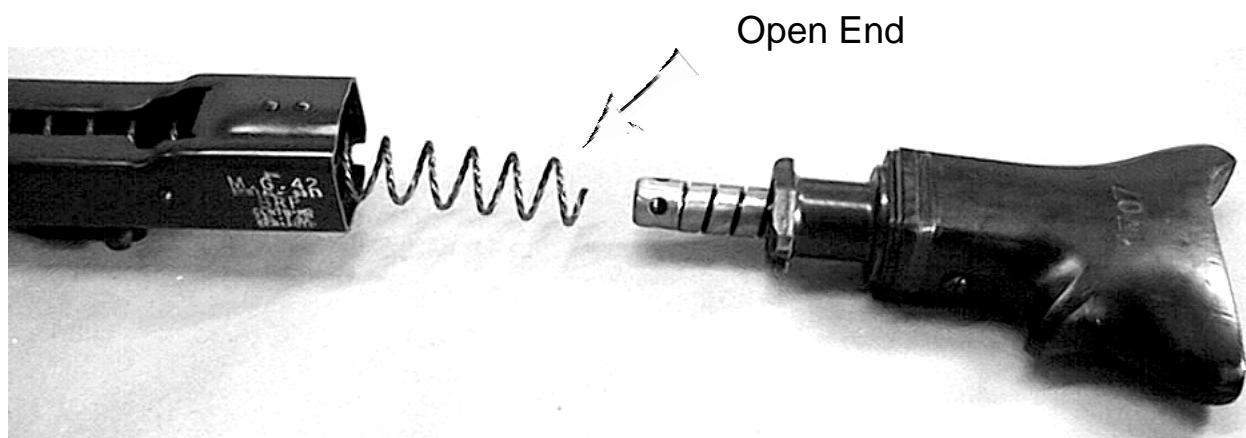



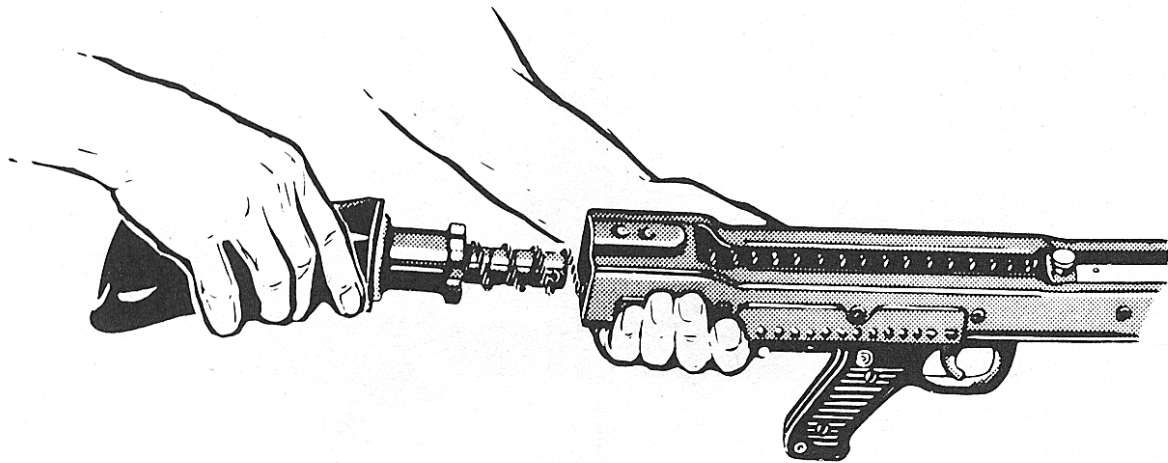

Fig. 72 Slip recoil spring over buffer spring and insert butt with rear cover into the housing.

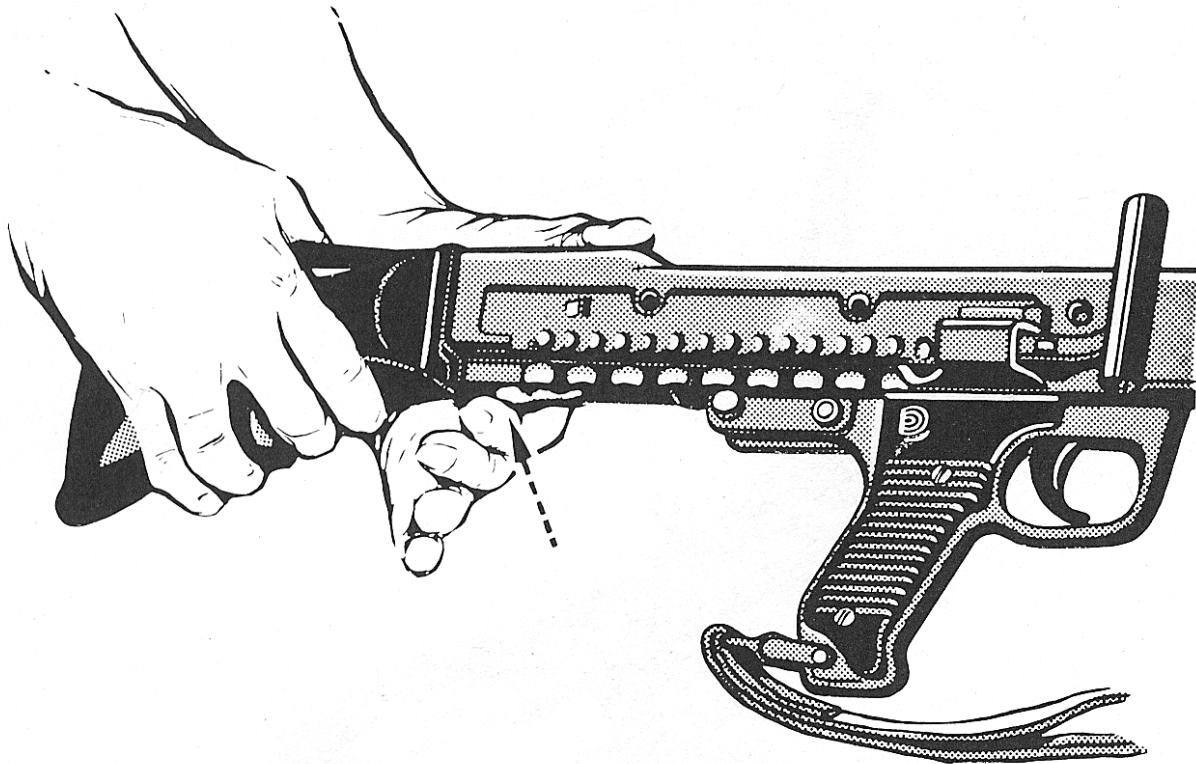

Fig. 73 By pressing the rear cover catch turn butt with rear cover by 90° in clockwise rotation until the catch snaps in.

## Fixing of feed cover and feed tray

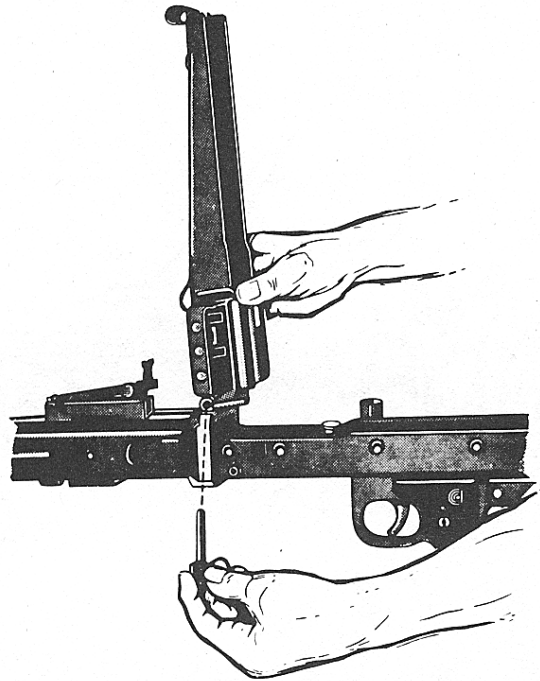

Fig. 74 Insert cover together with tray vertically to the bore axis into the hinge of the curved piece. Insert pivot pin from the left-hand side.

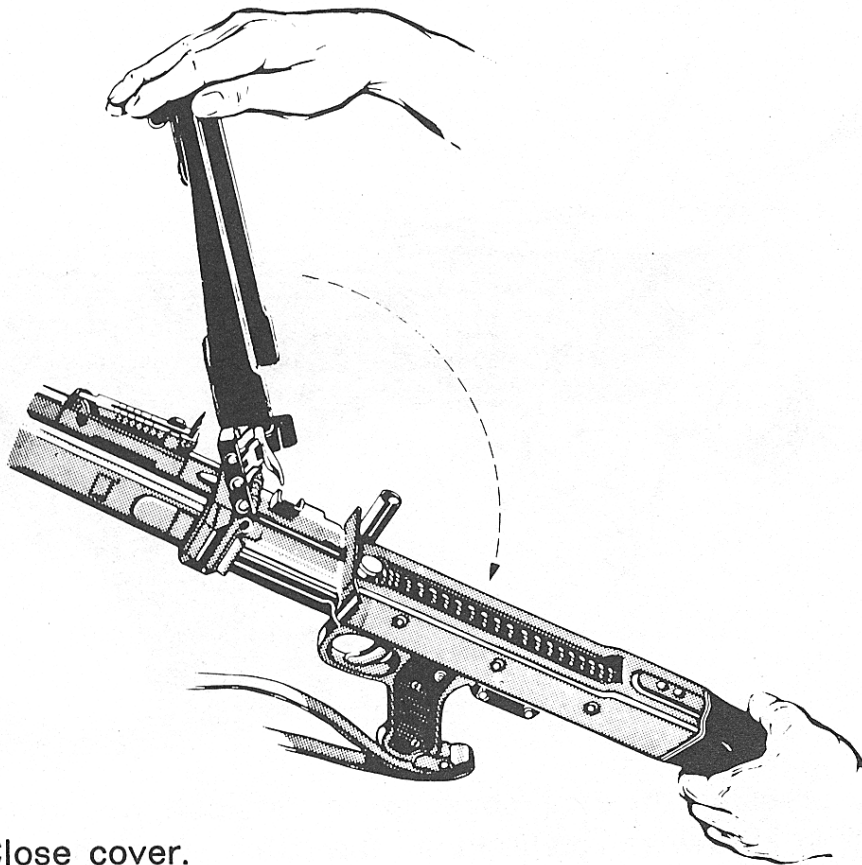

Fig. 75 Close cover.

# Operation

## 1. Filling the Belts and Magazines

### a. Belts

1. Place a 50-round on a flat surface, with the leading tab to the right and the tongues up. Insert a round into each link, and push it forward until the tongue snaps into the groove at the rear of the cartridge case. NOTE: Do not insert a round into the first five links unless you are using a short leading belt (e.g. starter tab). This is a precaution to prevent the belt from falling from the feed assembly. Always load the belt from left to right; the bolt head will likely crush and empty belt loop.
2. The 50-round belt can be extended by joining it to 50-round extension belts. Fill a 50-round extension belt, but do not fill the first link. Insert the tongue at the end of the leading belt into the rectangular opening in the first link of the leading belt into the rectangular opening in the first link of the extension belt, and join belts by inserting a round. It is common practice to join as many as four extension belts to a 50-round leading belt.
3. Instead of a 50-round leading belt, it is possible to join five 50-round extension belts to a short leading belt (e.g. starter tab).
4. If a starter tab is not available, and extension belt (or belts) can still be used. However, when loading the belt do not insert rounds in the first five links.

### b. 50-round Belt Drum Magazine

1. Fill an extension belt and turn it over with tongues on the bottom and empty link to the right. Roll up the belt from the left end and insert it into the belt drum magazine with the empty link on the outside.
2. If the magazine is to be used immediately or within a short time, fill a short leading belt and attach it. If the magazine is not to be used for some time, do not join a short leading belt. Instead, close the magazine slide and the cover, to keep the dust out.
3. The magazines are transported in carriers.

## 2. Loading the Gun

- a. **General.** The double lever feeding arrangement on the MG-42 feed cover is extremely strong and complex. Follow the instructions below and be sure to practice with dummy rounds.

### Loading with the Bolt Hold-Back Accessory

Retract the bolt by using the cocking handle. Insert the **Bolt Hold-Back** through the ejection port. This will hold the bolt back by creating a wedge between the bolt and the front of the ejection port. Raise the top cover and place the loaded belt on the feed block, so that the first round is on the feed block slot, and the leading tab is to the right. Close the feed cover making certain that the roller pin on the bolt carrier is aligned with the transport lever in the feed cover. You must pull the cocking handle back, wait for the **Bolt Hold-Back** to fall from the ejection port, then release the cocking handle such that the bolt strips and chambers the first round with significant force.

After the operator has become proficient in loading the gun, he may keep the feed cover closed while loading. In that case, make certain the bolt is fully home. Then, insert the leading tab into the feed opening on the left side of the gun, and pull it to the right until the three paws on the underside of the feed cover engage the first round. Never allow the bolt to jerk forward without having inserted the barrel because the cocking slide could be damaged.

**(The bolt must ALWAYS be to the rear when the belt is placed on the feed block)**

### 3. Firing the Gun

- a. Before carrying out the following instructions, make certain that the gun has been loaded with the belt
- b. Make sure that you keep your off-hand away from the moving parts and be sure to utilize the off-hand hook on the buttstock. NOTE: The rounds will eject from the underside of the gun directly in front of the lower receiver.
- c. Press the safety lever to the right until the letter " F", i.e. Fire, appears. Pull the trigger and the gun fires 1 round. Upon release of the trigger firing is interrupted the hammer will disconnect. When the trigger is pulled again, the gun will fire another 1 round.
- d. Always have your selector set to SAFE during lulls in firing.
- e. After firing, pull the bolt by means of the cocking slide to its rear position, put the safety lever on "Safe", remove the barrel from the gun, and check whether the barrel is clear. Reinsert the barrel. Insert the **Bolt Hold-Back** to indicate that the gun is clear or to reload the gun.

#### Firing the Gun on the Tripod Mount.

4. Elevation and Traverse (T&E)
  - a. The front end of the cradle is carried on a swivel mounting at the junction of the three tripod legs, while the rear end is supported by the elevating gear. The front leg is telescopically adjustable, and is provided with a clamping lever for fixing the telescopic parts after they have been adjusted. A traversing arc, on which the elevating gear is carried by a traversing slide, acts as a brace between the two rear legs which are jointed, each joint being fitted with a clamping lever.
  - b. Elevation is adjusted by a handwheel centered along the elevation screw, while adjustments for line are made by shifting the traversing slide along the traversing arc by means of the handle on the T&E gear. A wing nut is provided for clamping the elevating gear and a lever for locking the traversing slide. Adjustable elevating and traversing stops are also provided to enable the gun to be elevated and traversed between predetermined limits. The traversing stops are arranged for the traversing arc, which is graduated to facilitate adjustment of the stops.

### 4. Unloading the Gun

- a. **Removal of the Belt.** Set the selector is set to SAFE. Push the feed cover catch forward and raise the feed cover. Lift out the belt. Cock the gun to dechamber the round.
  - b. **Removal of the 50-round Belt Drum Magazine.** Set the selector is set to SAFE. Push the feed cover catch forward and raise the feed cover. Lift out the belt and disconnect the magazine from the gun. Cock the gun to dechamber the round and set the bolt catch to retain the bolt. Inspect to see that there is no round in the chamber.
- \*\* You should make use of the *Bolt Hold-Back* as a safety device to indicate a 'cleared' weapon.**

### 5. Changing Barrels

- a. **General.** The barrel must be changed after about 250 rounds have been fired continuously or with only short intervals between bursts.
  1. Unload the gun (par. 4). Retract the bolt and use **Bolt Hold-Back** to retain the bolt in a rearward position disengaged from the barrel.
  2. Depress and push the barrel change door forward.
  3. Remove the barrel with the leading tab or any other convenient tool.
  4. Insert a fresh barrel and close the barrel change door.
  5. Load the gun (par. 2).

# Dealing with Malfunctions

## 1. Immediate Action

- a. Immediate action is the immediate and automatic application of a remedy. It is to be applied immediately and automatically to a gun that jams, or otherwise malfunctions. When stoppage occurs during firing, perform the immediate action described below, or such portions thereof as are required to remedy the stoppage.
- b. **Failure of the Gun to Fire.** If the loaded gun fails to fire when the trigger is squeezed, proceed immediately as follows:
  1. Wait 30 seconds before opening the chamber.
  2. Cock the gun by a quick pull on the cocking handle.
  3. If a round is ejected, squeeze the trigger and fire.
  4. If the round is not ejected, set the selector at SAFE, and unload the gun (par. 4).
  5. Inspect the gun to determine the source of the malfunction was other than a defective round. Also, recheck that you followed correct loading and firing procedures (par. 2 & par. 3)
  6. Load the gun and resume firing.

## 2. Malfunctions and Corrections

- a. Proper care of the gun before, during, and after firing will usually eliminate most stoppages. Stoppages or other malfunctions which cannot be remedied by the application of immediate action should be dealt with in accordance with instructions described in the following paragraphs.
- b. **Feed Stoppage or Malfunction.** It is dangerous to investigate a feed stoppage or malfunction by raising the feed cover without first cocking the gun or retaining a hold on the cocking handle, insert the **Bolt Hold-Back**. Should a live round remain in the chamber, the raising of the feed cover would allow the bolt to continue forward and increase the chance of an accidental discharge, thus endangering the operator and damaging the gun. Should a stoppage occur during firing set the selector to SAFE, cock the gun and retain hold on the cocking handle. Notice if a round ejected. While maintaining hold of the cocking handle with your right hand use your left hand to open the feed cover and lift out the belt. Inspect the chamber to make sure no round is present. If the gun cannot be cocked, set the selector to SAFE and apply a backward pull on the cocking handle and, at the same time, raise the feed cover and remove the belt. The gun can then be cocked.
- c. **Failure to Fire.**
  1. CAUSES. Failure to fire is generally caused by:
    - a. Defective ammunition.
    - b. Defective firing pin or lower receiver problem
    - c. Bolt not fully closed
  2. REMEDIES.
    - a. If the primer of the round is deeply indented, the round is defective and must be discarded
    - b. If the primer is not indented or only slightly indented, the firing pin or hammer portion of your trigger housing may be worn, broken, or too weak to set off the round; or the bolt may not have been fully home. Check for dirt or any other obstruction on the bolt and receiver, and in the breech end of the barrel. Check for a ruptured case in the chamber. Remove all obstructions.

**With a slightly indented primer you may want to replace the firing pin spring with the lighter type and the hammer spring with the heavier type. This enables a stronger strike from the hammer with less resistance from the firing pin spring.** Given the extreme variance in primer hardness, each MG-42 SA comes with a heavy-strike setup. This includes a weaker firing pin spring and a heavier hammer spring. Only use this setup if the MG-42 SA is unable to consistently ignite the ammo you are using. This is often necessary for hard-primer military surplus ammo. Be aware that over-striking soft-primer commercial ammo may cause the primers to unseat and foul the gun.



**d. Failure to Feed.**

1. CAUSES. Failure to feed may be caused by:
  - a. Defective belt.
  - b. Insufficient recoil of bolt to pick up new round
  - c. Broken feed piece on top of belt.
2. REMEDIES.
  - a. If the belt does not feed cartridges into gun because it is deformed or broken, it should be fixed by a skilled individual or discarded.
  - b. Insufficient recoil may be due to reduce blast boosting or to obstruction in receiver or bolt.

**e. Failure to Extract.**

1. CAUSES. Failure to extract is generally caused by:
  - a. Dirty chamber
  - b. Dirty ammunition
  - c. Broken extractor.
2. ACTION.
  - a. When a failure to extract occurs, the bolt may be found fully home with a spent case in the chamber. Generally, most failures to extract can be remedied by pulling the cocking handle smartly to the rear. If this does not remove the case, use a cleaning rod.
  - b. Sometimes the empty case will be left in the chamber, the extractor ripping through the base of the cartridge. When this occurs, the bolt generally will attempt to feed a fresh cartridge into the chamber. It will then be necessary to remove this round before the spent case can be removed.
  - c. Where a dirty chamber or dirty ammunition is indicated, clean the chamber and discard or clean the dirty ammunition. The presence of even invisible particles of dust or sand in the chamber or on ammunition will cause failure to extract. It is advisable to oil the belt with paraffin wax if cartridges are to be left in it for more than a short period. A belt once oiled can be used 10 times before oiling again.

# Care and Preservation

## 1. General

- a. Proper functioning and accuracy of firing depend largely on care, cleaning, and oiling. The weapon should be always checked for cleanliness and lubrication before use. The following instructions should be carefully observed. Every gunner should be conscious of the fact that care, proper treatment, and cleaning are the necessary requirements for safe functioning of the weapon.

Never knock or put the gun violently on the ground. Before firing remove the oil from the barrel; after firing immediately re-oil it. This preventive measure will considerably facilitate cleaning later on.

## 2. Cleaning of Gun Received from Storage

- a. Guns and mounts which have been stored in accordance with instructions given in paragraph 20, will be coated with either OIL, lubricating, preservative, light, or COMPOUND, rust-preventative, light. Guns received from storage will usually be coated with heavy, rust-preventative compound. Use SOLVENT, dry-cleaning, to remove all traces of compound. Apply the solvent with rag swabs to large parts, and as a bath for small parts. Take care to remove the compound from all recesses in which springs or plungers operate. After removing all traces of the compound, allow the parts to dry and then wipe with a clean, dry rag.
- b. Persons handling parts after such cleaning should wear gloves to avoid leaving finger marks which are acid and usually start corrosion. SOLVENT, dry-cleaning will attack and discolor rubber gloves.

## 3. Normal Care

- a. Normal care includes care of the gun necessary to preserve its appearance and condition during periods when no firing is being done. Anytime after the gun is handled it should be inspected for proper condition and cleanliness.
- b. **Bore.**
  1. Remove the barrel.
  2. Assemble a cloth patch to a cleaning rod and insert the rod into the bore through the breech end. Run the patch back and forth several times through the entire length of the bore and chamber. Repeat with several patches until the patch comes out clean. **DO NOT USE A BRUSH IF THE BORE IS CHROME LINED – ONLY USE PATCHES.**
  3. Impregnate a patch with OIL, lubricating, preservative, light. Run the patch through the bore several times.
- c. **Wood and Metal Surfaces.** Use a small cleaning brush to clean screwheads and crevices. With a clean dry cloth, remove all moisture, perspiration, and dirt from the metal surfaces, and then wipe with a cloth slightly oiled with OIL, lubricating, preservative, light. This protective oil film should be maintained at all times. To clean the outer wood surfaces, wipe a cloth lightly oiled with OIL, lubricating, preservative, light. Then clean with a soft dry cloth.
- d. After cleaning and protecting the gun as described above store the gun. Muzzle covers gun covers, plugs, and rack covers should not be used because they collect moisture and promote rusting.

## 4. Care Preparatory to Firing.

- a. Before firing, the following instructions should be carefully observed in order to assure proper functioning of the gun.
- b. Disassemble the gun into its main groups.
- c. Run clean patches through the bore and chamber to remove all dirt and oil.
- d. Thoroughly clean all metal parts and lightly oil with OIL, lubricating, preservative, light. **CAUTION:** Do not oil the bore and chamber before firing because dangerous pressures may develop.

- e. Lubricate the following with a drop of oil from an oiler.
  1. Ejector groove on bolt.
  2. Plunger at rear of extractor.
  3. Firing pin shaft.
  4. Crevices around feed piece.
  5. Underside of the 3 belt feed pawls.
  6. Groove for cocking handle on receiver.
- f. Lubricant should be applied lightly because oil has a tendency to collect dirt which may act as an abrasive on the operating parts.
- g. After gun groups have been oiled as described above, assemble the gun and wipe all outer surfaces with a lightly oiled rag.

### 5. Care on the Range and in the Field

- a. The gun must be kept free from dirt and well lubricated to obtain proper efficiency during firing. The following instructions should be followed carefully.
- b. Before Firing.**
  1. See the bore is free from dust, dirt, mud, or snow.
  2. See the chamber is clean and free from oil.
  3. Test the trigger mechanisms at SAFE and FIRE.
  4. Work the bolt back and forth to see that it is clean and well oiled, and that it works freely.
  5. Examine the belts to see that they are free from dirt and properly loaded.
- c. During Fire.** In general, it should not be necessary to disassemble the machine gun in the field for cleaning. However, if the mechanism becomes very dirty or functions sluggishly, disassemble the gun into its groups, and clean as instructed in paragraph 17.

### 6. Care After Firing

- a. The weapon should be clean cleaned after each session of firing and not later than the evening of the day on which it was fired.
- b. Immediately after firing or as soon as possible, remove the barrel and run several wet patches impregnated with CLEANER, rifle bore, through the bore. If CLEANER, rifle bore is not available, use warm soapy water or warm water alone in the absence of these, cold water. Remove the patch from the cleaning rod and attach a cleaning brush. Run the brush through the bore several times. **DO NOT USE A BRUSH IF THE BORE IS CHROME LINED – ONLY USE PATCHES.** Make certain the brush goes all the way through the bore before reversing the direction. Remove the brush and run several patches wet with clean water through the bore and chamber again. Follow this with dry patches until they come out clean and dry. Finally, run a patch impregnated with OIL, lubricating, preservative, light, through the bore and chamber.
- c. Soak and wipe the flash hider, booster cone and barrel sleeve in OIL, lubricating, preservative, light, through the bore and chamber until free of all residue.
- d. After the bore and chamber have been cleaned, disassemble the gun. Clean all the metal parts with a clean dry rag, then wipe with a lightly oiled rag before assembling. After assembling, wipe the exterior surface with a rag lightly oiled with OIL, lubricating, preservative, light.

### 7. Preparation for Storage

- a. OIL, lubrication, preservative, light, is the most satisfactory oil for preserving the mechanism of this gun. This oil is satisfactory for preserving the polished surfaces, bore, and chamber for from 2 to 6 weeks, depending on climatic and storage condition. Guns in short term storage should be inspected every 5 days. If necessary, the preservative film should be renewed.
- b. COMPOUND, rust-preventative, light, is satisfactory for preserving polished surfaces, bore, and chamber for a period of up to one year, depending on climatic and storage conditions.

- c. Thoroughly clean all parts of the mechanism and the exterior of the weapon with SOLVENT, dry-cleaning. Dry with clean rags. After drying a metal part, do not touch with the bare hands. Then coat all metal parts with either OIL, lubricating, preservative, light, or COMPOUND, rust-preventative, light, depending on the probable length of storage. The bore is best coated with rust-preventative compound by dipping a cleaning brush in the compound and then running the brush through the bore two or three times. DO NOT USE A BRUSH IF THE BORE IS CHROME LINED. Then see that the bolt is fully home, and, handling the weapon only by the but and sling loop, place it in its storage location.

## Cleaning After Shooting Corrosive Ammo

Most surplus 8mm ammo is corrosive. This means that the primers and/or powder leave a corrosive (salt) residue on the weapon after firing. These salts mix with other residue and moisture and begin to attack the metal and form rust. However, prompt and thorough cleaning immediately after shooting this ammo makes it no different than shooting non-corrosive ammo.

Oils or solvents will not neutralize the corrosive residue and most shooters do not want to run home to make a warm soapy bath for their gun, especially one as large as the MG-42 SA. Diluted ammonia as found in Windex (with ammonia) and other window cleaners will breakdown and neutralize the corrosive residue.

The window clean with ammonia is your first line of cleaning for the bolt head, chamber, bore, barrel crown, barrel sleeve, booster cone, flash hider, and receiver bushing. Immediately after firing the barrel and booster assemblies will be too hot to clean.

- Remove the bolt from the MG-42 SA, disassemble, and spray the bolt head and internal parts thoroughly. Wipe down until dry, then oil with CLP.
- Remove the barrel and booster assembly with hot barrel mitt.
- Spray and clean the barrel bushing and inside of the forward portion of the receiver, wipe down, and oil with CLP.
- Spray and clean the booster assembly (barrel sleeve, booster cone, and flash hider), wipe down, and oil with CLP. After extended use the corrosive residue will be 'baked' on to the booster assembly and barrel crown so you will need to be aggressive with a soft brush when cleaning these parts.
- (Make sure the barrel is not hot). Spray and clean the chamber and bore using a cleaning rod and patch. Run a dry patch through the barrel followed by one impregnated with oil. Spray and clean the barrel crown, wipe down, and oil with CLP.

The rest of the MG-42 SA can be cleaned as specified on pages 38, 39, and 40 of the manual.



# Ammunition

## General

- a. The common commercial designation for the round used in this gun is 8mm Mauser. However, the exact dimensions are 7.92mm X 57mm. Be certain that the ammo you purchase have the exact dimensions because there are many ammunition configurations that look and sound similar to 8mm Mauser ammunition. **ABSOLUTELY NO OTHER TYPE OF AMMUNITION IS TO BE USED WITH THIS SYSTEM. EXPERIMENTS TO ASCERTAIN INTERCHANGEABILITY ARE FORBIDDEN.**
- b. The following is a list of common ammunition:
  - 7.92 X 57mm German Military
  - 7.92X57JSGerman Military, European hunting ammo
  - 7.90X57 Portugal, Spain, Middle East, South America
  - 8X57JS European hunting/sporting ammo
  - 8mm Mauser Common commercial designation
  - 8X57 Mauser Common commercial designation
  - 7.92 Mauser Yugoslav designation
  - 7.92mm BESA British manufactured
  - 7.92-mm Chinese
- c. When purchasing surplus ammunition make sure that the ammo is clean, not deformed, and not “life expired.” Any ammo suspected of being dangerous should not be used. Much of the 8mm ammunition is made for rifle only with thin brass and weakly seated bullets. They are not suitable for this system. **Recommended ammo includes Romanian Steel Case, Olympic, and Sellier and Bellot. DO NOT use Turkish mfg. ammo.**

## Special note on ammo in this system:

Given the extreme variance in primer hardness, each MG-42 SA comes with a heavy-strike setup. This includes a weaker firing pin spring and a heavier hammer spring. Only use this setup if the MG-42 SA is unable to consistently ignite the ammo you are using. This is often necessary for hard-primer military surplus ammo. Be aware that over-striking soft-primer commercial ammo may cause the primers to unseat and foul the gun.

# 8mm AMMO in the MG-42 SA

**The best surplus ammo to run is Romanian Steel Cased 155 gr. The best commercial ammo to run is Olympic 196 gr. FMJ.**

That being said, we have used Portuguese, Yugoslavian, and FN with very good reliability and consistency. One special note: the Yugoslavian Ammo tends to have harder primers usually requiring a heavier firing-pin strike.

ONLY RUN FMJ AMMO. The MG-42 SA, MG-42, MG-34, and XMG will not cycle soft point ammo reliably.

Improper, aged, defective, or weak ammo will not work in the MG-42 SA as well as most other 8mm automatics, and should be considered unsafe to use in all firearms, especially automatics. However, you can get away with running just about anything through a bolt action rifle. The M-48 is certainly the most rugged 8mm bolt action rifle on the market.

## Specific Ammo to Avoid:

- Anything made prior to 1950
- Turkish
- German WWII (steel case) - The cases are corroded ON THE INSIDE from the powder. Brass is usually OK but has hard primers. Collect this ammo, DON'T shoot it!
- Ecuadorian
- Nigerian
- Anything south of the border or from a 'third-world' nation

## Reasons to avoid these types of ammunition:

**Primers** - Primers harden as ammo ages. Excessive primer hardness will lead to dangerous misfires and hang-fires.

**Strength** - Much of the 8mm ammo currently available was made for bolt-action rifles. This ammo suffers from thin brass and loosely fitted bullets. Simply, the rounds just fall apart or deform during the harsh chambering and extraction in automatics.

**Damage** - The last batch of Ecuadorian 8mm we received was green due to corrosion. Don't trust anything from a 'third-world' nation. Most never had to make ammo strong enough to deal with the harsh chambering and extraction of an automatic, especially a 'pusher-type' MG-42 versus the 'puller-type' 1919.

**Corrosion** - If the ammo is steel cased, it has a much shorter shelf-life due to the corroding of the INSIDE of the case caused by corrosive powder.

**Pressure** - All automatic weapons rely on the pressure generated from the round to cycle the weapon. In aged, defective, or poorly made ammo the pressures are often inconsistent and will lead to an unreliable cycle. It will result in jamming, case head separations, primer blowouts, and lots of other nasty malfunctions that can significantly damage the gun and the shooter. Just because the sales person says that it 'runs in my 1919,' does not mean it's good and safe ammo.

**Dimensions** - There's a lot of poorly made ammo that will not seat properly in the standard 8mm chamber. Headspace is critical in the MG-42 SA. You will notice this in a bolt action where you sometimes have to force the round into the chamber. Poorly dimensioned ammo results in major headspace issues yielding pressures malfunctions listed above.

**Bottom line: If you just bought a Ferrari, don't expect it to run like Ferrari if you fill it with bad gas.**

If you've stockpiled some 8mm ammo and want to know if it is going to work in an MG-34, XMG, MG-42, or MG-42 SA, please call 301-807-5234.

# Inspection

## 1. General

- a. Inspect the gun at interval for operation and functioning. In all such inspections, use dummy ammunition. The use of live ammunition is **prohibited**. Ammunition must not be present during inspection.

## 2. Gun as a Unit

- a. Note if the butt is firmly secured.
- b. Retract the bolt and note any sluggish movement or binding. Remove the feed cover and feed block and see that the chamber is clear. Grasp the cocking handle and pull it to the retracted position and slowly let it forward on an empty chamber. Note any binding or sluggish movement.
- c. Check the functioning of the belt feed pawls, using dummy rounds in a belt. **DO NOT** use live ammo.
- d. With one hand, grasp the cocking handle in its most forward position and retract it until the bolt is in its most rearward position. Then release the cocking handle to send the bolt forward with significant force to chamber the dummy round. Set the selector to **SAFE**, then pull the trigger to check the safety mechanism. Set the selector to **FIRE**, then pull the trigger and make sure the hammer falls. Raise the top cover to make sure the bolt is fully home. The roller stud on the bolt carrier should be up against the feed tray.
- e. Retract the bolt and note any difficulty or failure to extract or eject.

## 3. Barrel Jacket and Barrel

- a. Note whether front sight is properly secured. Check whether the bipod catch springs at the front and rear of barrel jacket are set or broken.
- b. Note if recoil booster is properly secured to the jacket. If loose, tighten (the threads are right-hand).
- c. Remove the barrel, hold it up to the light, and inspect the chamber and bore for wear, pits, or bulges. To facilitate inspection, place a piece of white paper in the breech end of the barrel slowly so that the light follows the circumference of the bore. If the barrel has pits or bulges, it should be examined by a gunsmith or replaced.

## 4. Bolt and Spring

- a. Examine the bolt surface for rust, roughness, or foreign matter. Inspect all notches, edges, corners and grooves for burrs and wear.
- b. Inspect firing pin point and rear surface for wear and deformation.
- c. Inspect the extractor and ejector for deformation or breakage.
- d. Check the driving spring for kinks, fracture, and lost tension.

## 5. Belts and Magazines

- a. **Belts.** Examine the belts for deformation or torn links. Note whether the belts are clean and free from rust.
- b. **Belt Feed Drum Magazines.** Examine the 50-round belt feed drum magazines for deformation and for malfunction of the slide and cover. Deformed magazines should be repaired or replaced.

## 6. Mounts

- a. **Bipod.** Examine the bipod for rigidity of connections. Check the functioning of the thumbscrew nut between the bipod legs.
- b. **Antiaircraft Tripod.** Check the elevation adjustment of the tripod by means of the leg clamps and wing nuts. Check the functioning of adjustable support at the top of the tripod. Test rigidity of connections with tripod in any firing position.
- c. **Tripod Mount.**
  1. Examine the erected tripod mount for rigidity of connections in any given firing position. Check functioning of the elevation mechanism and elevation stops. Check functioning of the traversing mechanism and traverse stops.
  2. Push the cradle to the rear several times to simulate recoiling.

# Maintenance Under Unusual Condition

## 1. General

- a. When operating under unusual conditions such as tropical or arctic climates, severe dust or sand conditions, and near salt water, the precautions list below should be scrupulously observed.

## 2. Care in Arctic Climates

- a. In temperatures below freezing, and particularly in arctic climates, it is essential that all moving parts be kept absolutely free from moisture. It has also been found that excess oil on the working parts may solidify to such an extent as to cause sluggish operation or even complete failure.
- b. The gun should be disassembled and the chief components cleaned with SOLVENT, dry-cleaning, before use in temperatures below zero F. The working surfaces of parts which show signs of wear may be lubricated by rubbing with a cloth that has been lightly oiled with OIL, lubricating, preservative, light, and wrung out. At temperatures above zero F, the gun may be oiled lightly after cleaning by wiping with a lightly oiled cloth, using OIL, lubricating, preservative, light.
- c. The gun should be left exposed to the cold whenever possible because, upon bringing it into a warm room, moisture will condense on the cold metal and cause rusting. Immediately upon bringing indoors, the gun should be thoroughly oiled with OIL, lubricating, preservative, light. After the gun has reached room temperature, it should be wiped off to remove the condensed water vapor and oiled again.
- d. If the gun has been fired, it should be thoroughly cleaned and oiled. The bore may be swabbed with an oiled patch and, when the weapon reaches room temperature, thoroughly cleaned and oiled as prescribed in paragraph 19.
- e. Before firing, the gun should be cleaned and oil removed as prescribed in paragraph 17. The bore and chamber should be entirely free from oil before firing.

## 3. Care in Tropical Climates

### a. Tropical Climates.

1. In tropical climates where the temperature and humidity are high, or where salt air is present, and during rainy seasons, the gun should be thoroughly inspected at frequent intervals and kept lightly oiled when not in use. The gun should be disassembled at regular intervals to enable the drying and oiling of parts.
2. Care should be taken to see that the unexposed parts and surfaces are kept clean and oiled.
3. In low climates, use OIL, lubricating, preservative, light.

### b. Hot, Dry Climates.

1. In hot, dry climates where sand and dust are apt to get into the mechanism and bore, the gun should be wiped clean daily, or more often, if necessary. The gun should be disassembled as far as necessary to facilitate thorough cleaning.
2. Oiling and lubrication should be kept at a minimum, as oil collects dust which acts as an abrasive on the working parts and may foul the bore and chamber. OIL, lubricating, preservative, light, is best for lubrication where temperatures are high, and should be lightly applied only to the surfaces or working parts showing signs of wear.
3. Perspiration from the hand is usually acid and causes rust. Metal parts should therefore be wiped dry frequently.
4. During sand and dust storms the breech, muzzle and, ejection port should be kept covered.



# Accessories

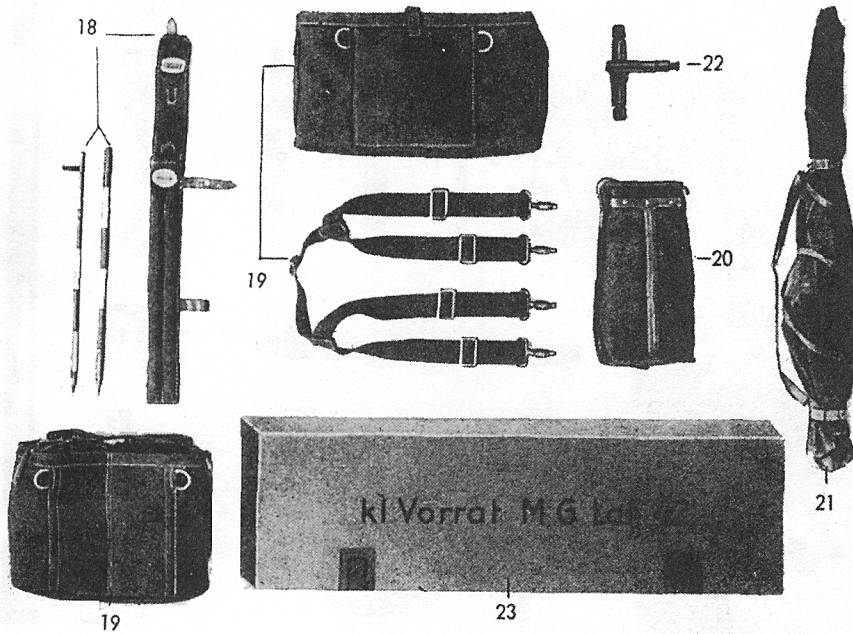

- 18- aiming stakes
- 19- shoulder straps for ammo boxes
- 20- vehicle attachment for belt in cradle
- 21- gun cover
- 22- cradle adapter
- 23- barrel crate

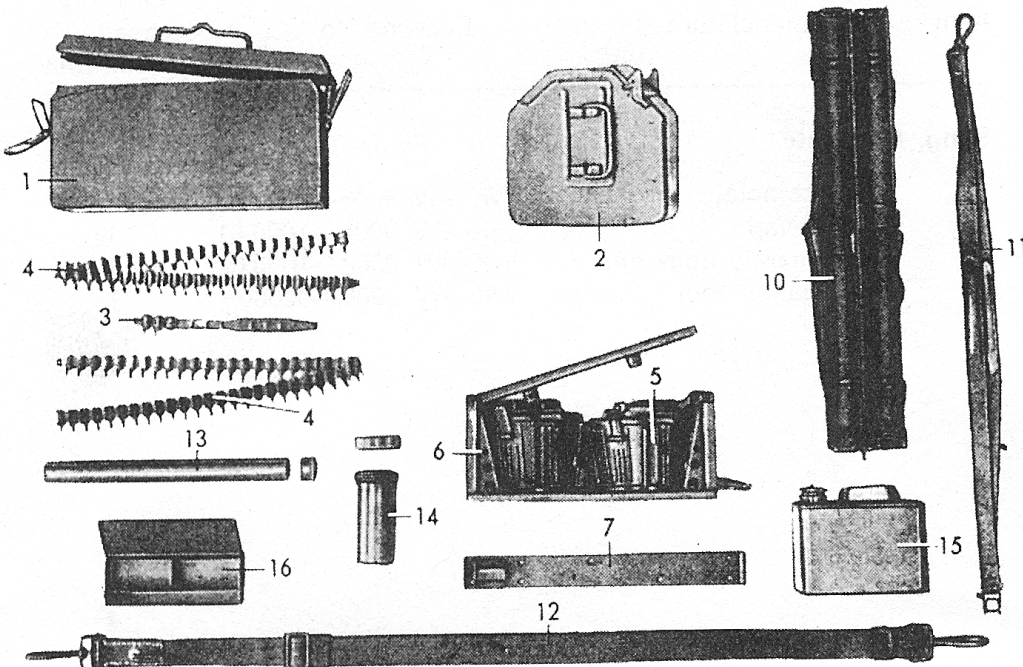

- 1-ammunition can
- 2-vehicle ammunition can
- 3-belt starter tab
- 4-50 round metallic belt
- 5-50 round basket drum
- 6-two basket carrier
- 7-belt case
- 10- spare barrel case
- 11- MG42 sling
- 12- ammo can sling
- 13- spare spring tube
- 14- booster/flash hider case
- 15- oil can
- 16- spare parts box

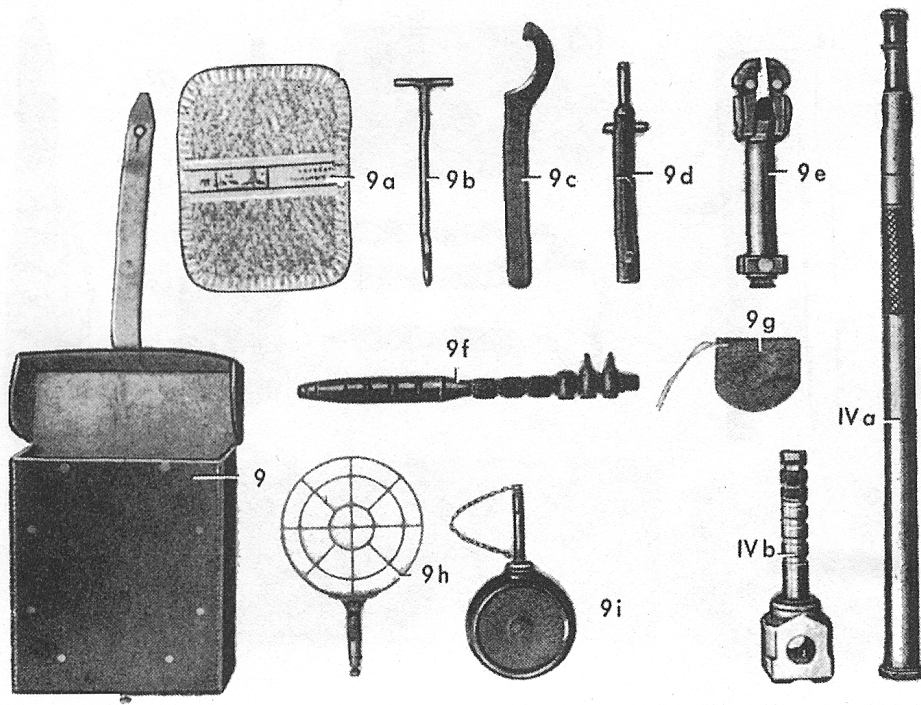

- 9- MG-42 gunner's leather wallet
- 9a-hot barrel mitten
- 9b-broken case tool
- 9c- muzzle brake spanner wrench
- 9d-ruptured cartridge extractor
- 9e- spare bolt
- 9f- belt starter tab
- 9g-blow away muzzle cover
- 9h-Anti aircraft sight
- 9i- oil can

IVa and IVb are the two piece blank firing barrel





U.S. Department of Justice

Bureau of Alcohol, Tobacco,  
Firearms and Explosives

APR 01 2004

903050:RV  
3311/2004-382

www.atf.gov

Mr. Brian Poling  
BRP Corporation

Dear Mr. Poling:

This is in reply to your recent letter, as well as subsequent facsimile message, to the Firearms Technology Branch (FTB), Bureau of Alcohol, Tobacco, Firearms and Explosives (ATF). Accompanying the letter was a prototype of a semiautomatic version of German MG42 that you wish have classified as a semiautomatic rifle. You also submitted an incomplete rifle receiver to demonstrate how your rifle receiver is made.

The upper receiver you have provided has been manufactured from four sections (see attached photographs).

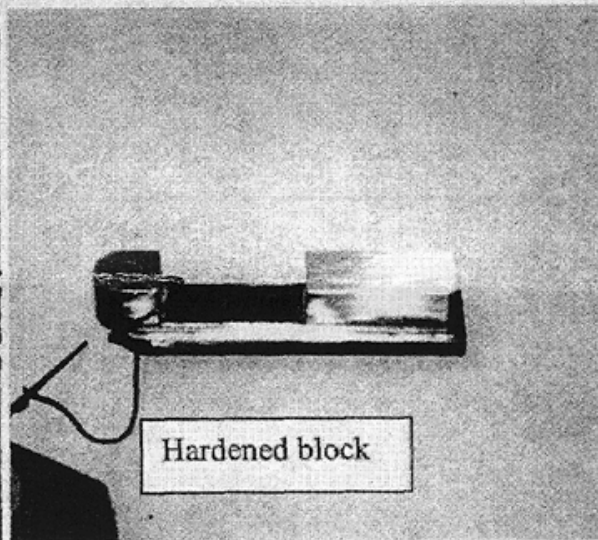
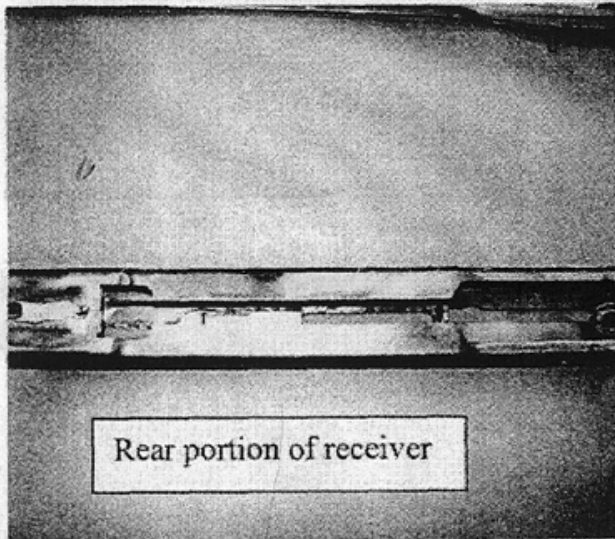





In addition, as evidenced <sup>↙</sup> is the photograph below, the underside of this section of the receiver has been modified to accept only the modified firing mechanism that is attached to the receiver and will no longer accept a MG42 firing mechanism.

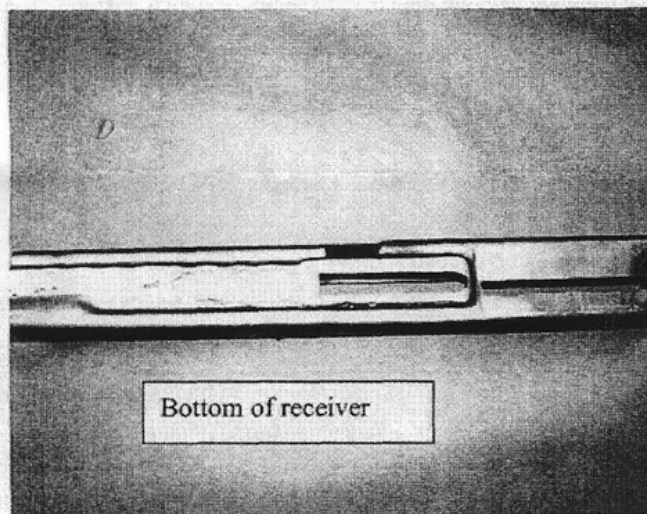

This firing mechanism has been modified  and will no longer accept MG42 machinegun components. (See below.)





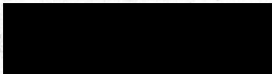

Furthermore, the bolt assembly

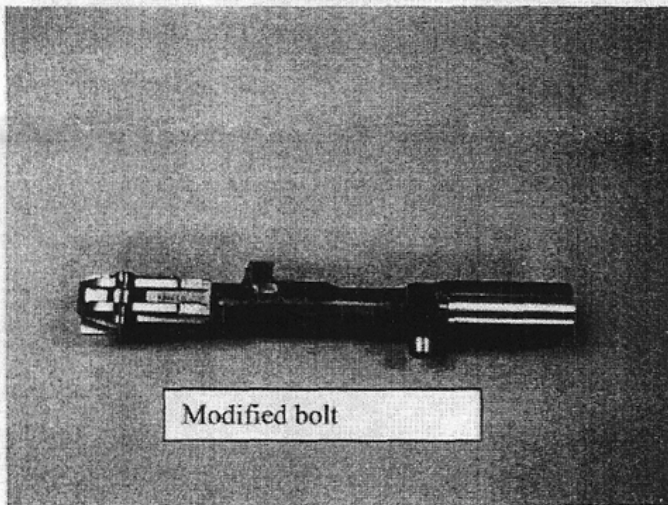

Modified bolt

The two forward sections of the receiver, which serve as the barrel shroud and house the barrel, have been welded together, and the resulting section is welded to the lower portion of the receiver. (See photos below.)

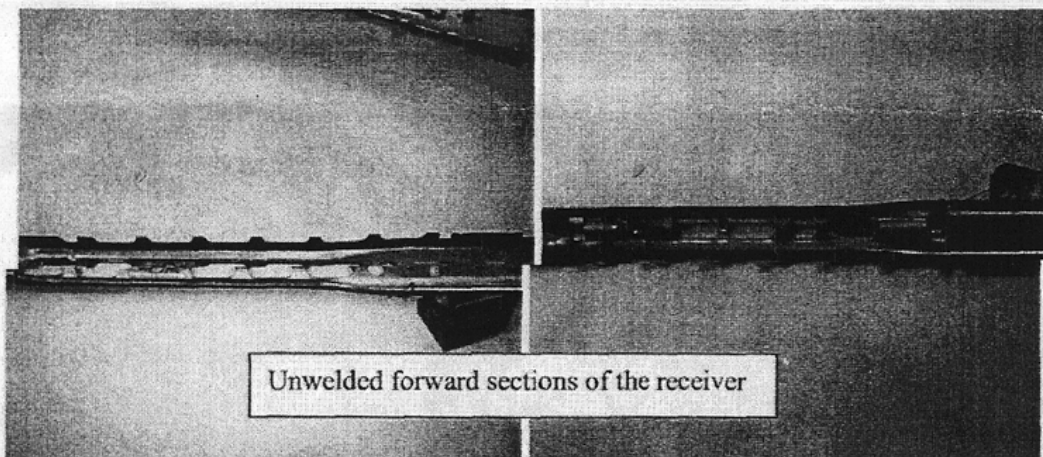

Unwelded forward sections of the receiver



[REDACTED]

Based on the foregoing, FTB has determined that the semiautomatic MG 42 firearm, as received, is not a machinegun as defined and, further, that it cannot be readily converted to a machinegun. Any modification to the prototype or any deviation in the manner in which the receiver is constructed could change our classification.

We thank you for your inquiry and submitted items and trust that the foregoing has been responsive to your request.

Sincerely yours,

A handwritten signature in black ink, appearing to read 'S. Nixon', with a stylized flourish extending from the end.

Sterling Nixon  
Firearms Technology Branch