

RESTRICTED

# PILOT TRAINING MANUAL

FOR THE LIBERATOR

# B-24

Published for Headquarters, AAF

Office of Assistant Chief of Air Staff, Training

By Headquarters, AAF, Office of Flying Safety

Revised 1 May, 1945

ADDITIONAL COPIES OF THIS MANUAL MAY BE OBTAINED UPON REQUEST TO HQ AAF,  
OFFICE OF FLYING SAFETY, SAFETY EDUCATION DIVISION, WINSTON-SALEM 1, N. C.

RESTRICTED







## Foreword

THIS MANUAL is the text for your training as a B-24 pilot and airplane commander.

The Air Forces' most experienced training and supervisory personnel have collaborated to make it a complete exposition of what your pilot duties are, how each duty will be performed, and why it must be performed in the manner prescribed.

The techniques and procedures described in this book are standard and mandatory. In this respect the manual serves the dual purpose of a training checklist and a working handbook. Use it to make sure that you learn everything described herein. Use it to study and review the essential facts concerning everything taught. Such additional self-study and review will not only advance your training, but will alleviate the burden of your already overburdened instructors.

This training manual does not replace the Technical Orders for the airplane, which will always be your primary source of information concerning the B-24 so long as you fly it. This is essentially the textbook of the B-24. Used properly, it will enable you to utilize the pertinent Technical Orders to even greater advantage.

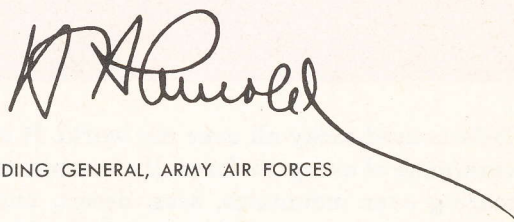

COMMANDING GENERAL, ARMY AIR FORCES



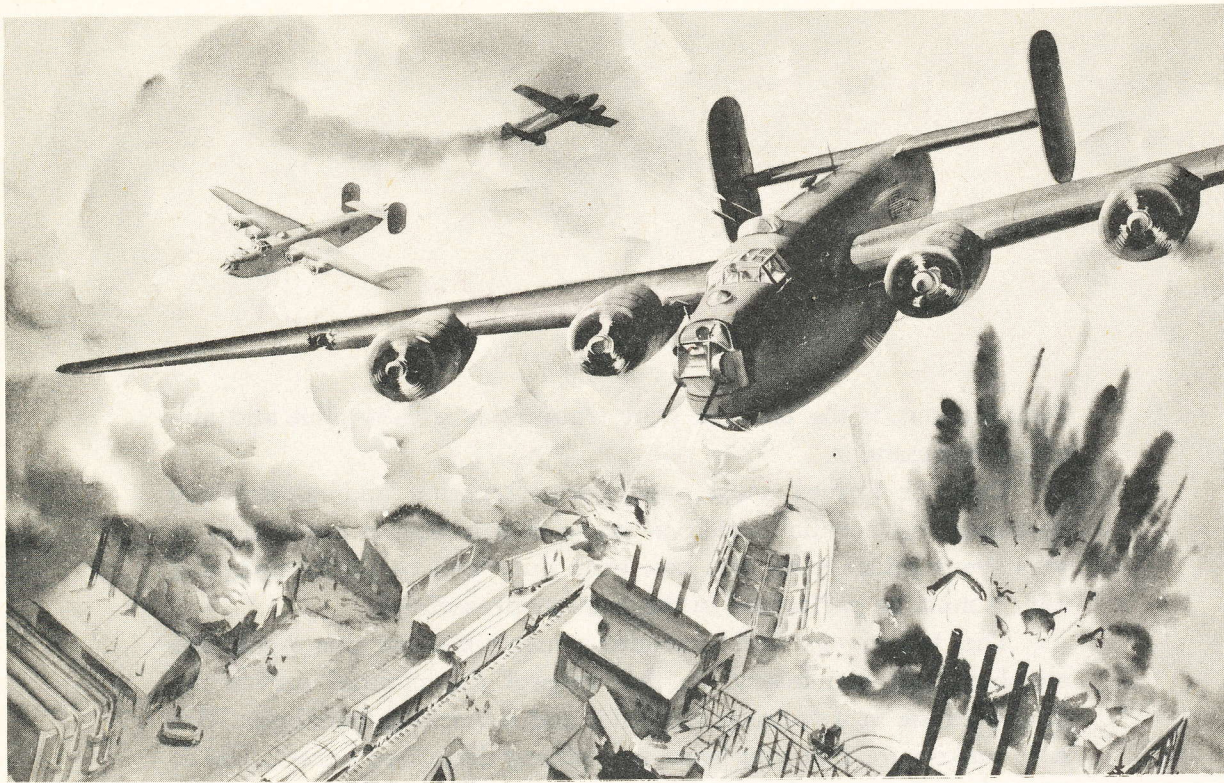

## THE B-24 IN COMBAT

The B-24 is used today all over the world. It is the workhorse of every air force. Its formations are roaring over mountains, seas, desert, and arctic, laden with tons of destruction for the enemy.

Liberators are being used more and more in combat for one conclusive reason: The B-24 has everything—speed, climbing power, carrying ability, and above all, **guts**. The B-24 can take it and dish it out. The B-24's combat rec-

ord is best told by those who have flown it through flak and swarming fighters, in mission after mission, and know first hand what it can do.

### WHAT COMBAT LEADERS SAY:

"The B-24 has proved itself capable of delivering tremendous blows against the enemy over extremely long ranges, under unfavorable weather conditions and against heavy enemy opposition. If the gunners are properly trained, they can create havoc among enemy fighters. I have seen formations of B-24's penetrate heavily defended battle zones, completely destroy their target, fight off twice their number of enemy fighters and, through their maneuverability and firepower, destroy over 50% of all attacking enemy fighters without loss to themselves."

### There and Back

"In the words of the old-time pilots, 'She'll take you there and bring you back.' I have seen B-24's shot up by 88-mm. anti-aircraft so badly



it seemed impossible that the airplane could stay in the air. One pilot brought his B-24 back to base with half the rudder control completely shot away. We have had airplanes come back under almost unbelievable handicaps: with propellers shot off; with direct hits in gasoline cells by 20, 40 and 88-mm. explosive shells; with the 2 lower engine supports knocked completely off; with both ailerons gone; after complete loss of rudder control; after loss of elevator control. Airplanes have returned with controls so badly damaged they were landed on autopilot."

#### **Maneuverability**

"A good gunner will conserve his ammunition and make every bullet count. I was caught once, separated from a formation, with no guns working and 500 miles behind enemy front lines, by an enemy plane which had a full load of ammunition. We successfully evaded his attacks and forced him to expend all his ammunition. Maneuverability alone enabled us to return to base. One B-24 was separated from formation over the target and attacked by 15 ME 109's. Through skillful maneuvering and use of firepower this crew shot down 8 of the enemy fighters in a running battle of 100 miles and returned safely to base. In another instance a B-24 with the tail turret out was attacked in a running battle. Enemy fighters knew the vulnerable spot and, as they approached from the rear, the airplane was maneuvered so that the top turret gunner could fire at them. Nine enemy planes were shot down in this manner."

#### **Instrument Flying**

"The B-24 is a good instrument airplane. About 80% of our flying was instrument or formation or a combination of the two. It is a good indication of your flying ability and of the flight characteristics of the airplane when you can fly formation for 5 or 6 hours and do it well and then go back on instruments and fly a good compass course for 3 or 4 hours. The ability to get your plane back sometimes depends on this. I know that during training in the U. S. it is pretty hard to sit under a hood and fly instruments when you could just be cruising around. It's hard to sit in a Link trainer for hours at a time and work out your procedure. But it pays

off when you get out where you **have to be good** in formation and instrument flying."

#### **Guts**

"The housing around the propeller and 3 cylinders of our No. 4 engine were shot out. Two feet of prop on No. 1 engine was smashed, tearing a foot-and-a-half hole in the left aileron. The engine was vibrating like a bucking bronco. And we had a wing cell leak in No. 3. We were both flying that airplane with every ounce of skill we possessed. We put on 10° of flaps to get the best lift without too much drag, and kept our wings straight by using rudder. We muddled through the fighter attack and staggered away from the target on 2½ engines. To gain altitude to cross a mountain range, we threw out everything that was movable, including oxygen bottles, gas masks, ammunition, radio equipment, and everything a screwdriver could get loose. Somehow she brought us back. We had to crash-land the plane but nobody was hurt. The first thing I did after we got away from the plane was to kiss the navigator."

#### **Come-Back**

"One of the B-24's was hit on the left wing, just outside the outboard engine. I thought the wing would fall off, since the shot went right through the main structure. You could have dropped a barrel through the hole, but the airplane continued to fly formation. A few seconds later a direct hit ripped a big hole in the bomb bay, severed the aileron cable, knocked out the hydraulic and electric systems and the oxygen system. We escorted it 800 miles to the base. It landed without ailerons and without brakes and was back in service in about 3 weeks."

#### **Range**

A fully loaded Liberator crossed the Atlantic in 6 hours and 12 minutes. The raid on the Rumanian oil refineries was a round trip of 2500 miles. Raids from Midway Island on Jap-held Wake Island involved a round trip of 2400 miles. British Air Chief Marshal Sir Christopher Courtney termed the Liberator the "most successful of all anti-submarine aircraft now used by the United Nations." The combat record of the B-24 speaks for itself.



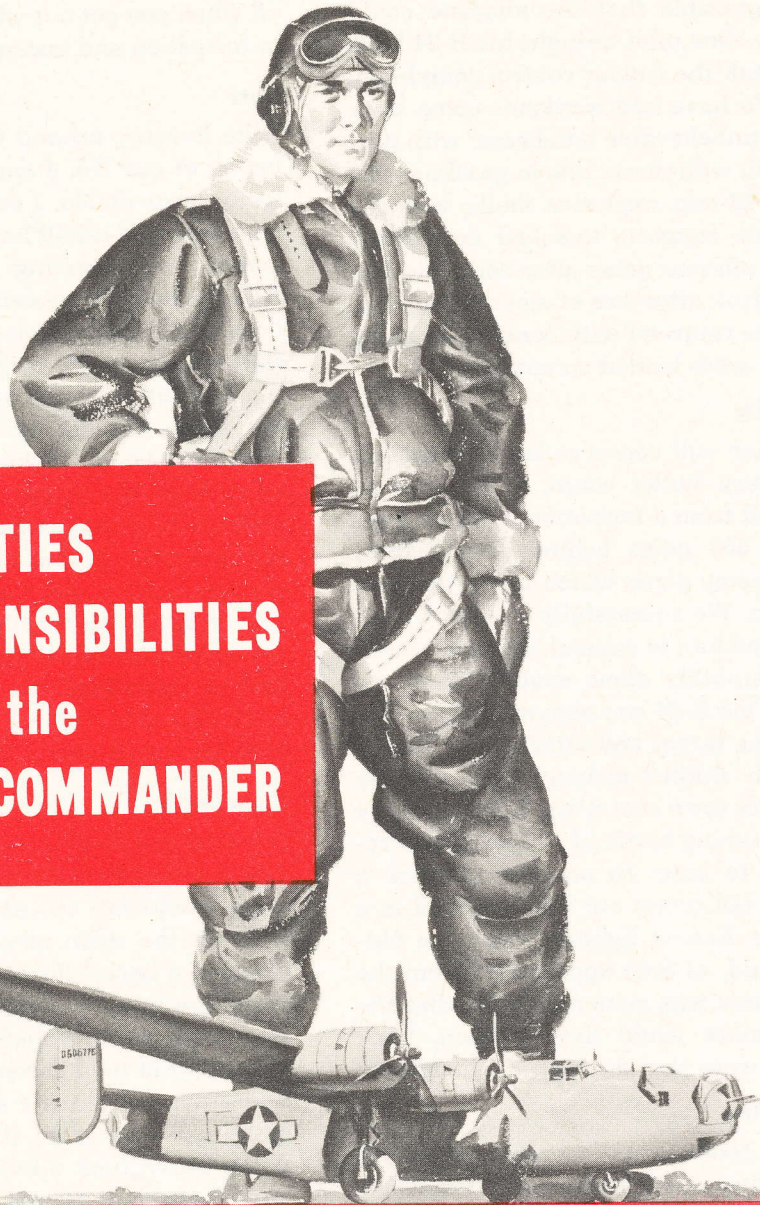

**DUTIES  
AND RESPONSIBILITIES  
of the  
AIRPLANE COMMANDER**

Here's where they separate the men from the boys. You can be one of the best B-24 pilots ever trained and still fail as an airplane commander. In addition to qualifying yourself as a top-flight pilot, you have the job of building a fighting team that you can rely on in any emergency. Failure of any member of the crew to do the right thing at the right time may mean failure of your mission, unnecessary loss of life and possible loss of your airplane.

**You Can't Pass the Buck**

Your authority as airplane commander carries with it responsibility that you can not shirk. Your engineer is a trained specialist, but his training is incomplete. He knows how to transfer fuel, but does he know how to transfer it in the particular airplane you are flying? It isn't enough that he **thinks** so. You must **know** what he knows. It is up to you to perfect the basic training he has been given. An oversight



of this kind cost a B-24 and 2 lives in the Pacific.

You are now flying a 10-man weapon. It is your airplane, and your crew. You are responsible for the safety and efficiency of the crew at all times—not just when you are flying, but for the full 24 hours of every day while you are in command.

Your crew is made up of specialists. Each man—whether he is the navigator, bombardier, engineer, radio operator, or one of the gunners—is an expert in his line. But how well he does his job, and how efficiently he plays his part as a member of your combat team, will depend to a great extent on how well you play your own part as the airplane commander.

#### **Know Your Crew**

Learn all you can about each member of your crew just as soon after he joins your outfit as possible. Where is his home? What is his education? Is he married? What jobs has he had? Where did he get his flight training? How does he like the idea of being assigned to a B-24?

Your job is to learn all you can about each crew member so you can evaluate his qualifications, initiative, proficiency and reliability.

#### **Know His Personal Habits**

It is no business of yours whether a crew member spends his free hours in prayer, gambling, or hunting turtle's eggs unless these habits interfere with the proper performance of his duty. Then his business is your business. You can't afford to see a mission jeopardized because a crew member doesn't get enough sleep, comes to duty with a hangover, starts on a high-altitude mission with gas-producing food in his stomach, or is so distracted by worry that he cannot concentrate on the task at hand.

See that your men are properly quartered, clothed, and fed. There will be many times, when your airplane and crew are away from the home base, when you may even have to carry your interest to the extent of financing them yourself. Remember always that you are the commanding officer of a miniature army—a specialized army; and that morale is one of the biggest problems for the commander of any army, large or small.

RESTRICTED

#### **Crew Discipline**

Your success as the airplane commander will depend in a large measure on the respect, confidence, and trust which the crew feels for you. It will depend also on how well you maintain crew discipline.

Your position commands obedience and respect. This does not mean that you have to be stiff-necked, overbearing, or aloof. Such characteristics certainly will defeat your purpose.

Be friendly, understanding, but firm. Know your job, and, by the way you perform your duties daily, impress upon the crew that you do know your job. Keep close to your men, and let them realize that their interests are uppermost in your mind. Make fair decisions, after due consideration of all the facts involved; but make them in such a way as to impress upon your crew that your decisions are made to stick.

Crew discipline is vitally important, but it need not be as difficult a problem as it sounds. Good discipline in an air crew breeds comradeship and high morale. And the combination is unbeatable.

You can be a good CO and still be a regular guy. You can command respect from your men, and still be one of them.

"To associate discipline with informality, comradeship, a leveling of rank, and at times a shift in actual command away from the leader, may seem paradoxical," says a former combat group commander. "Certainly, it isn't down the military groove. But it is discipline just the same—and the kind of discipline that brings success in the air."

#### **Crew Training**

Train your crew as a team. Keep abreast of their training. It won't be possible for you to follow each man's courses of instruction, but you can keep a close check on his record and progress.

Get to know each man's duties and problems. Know his job, and try to devise ways and means of helping him to perform it more efficiently.

Each crew member naturally feels great pride in the importance of his particular specialty. You can help him to develop this pride



## RESTRICTED

to include the manner in which he performs that duty. To do that you must possess and maintain a very thorough knowledge of each man's job and the problems he has to deal with in the performance of his duties.

### Are You Ready to Fight?

Are your guns working? The only way you can be sure is to know how competent and reliable your gunners are. It is uncomfortable to get caught by a swarm of enemy fighters and find that your guns won't function.

What about your navigator? You can't do his job for him throughout training in the states and expect him to guide you safely over a thousand miles of water to a speck on the map. Remember that there aren't any check points in the ocean and you have to rely on your navigator.

Your bombs miss the target. Long hours of flying wasted . . . why? It may be because the bombsight gyro was not turned on long enough in advance or because the bombsight was not kept warm by means of the heater so that when the bombardier put his warm face to the eyepiece, it fogged up and was unusable. Who is at fault? The bombardier is, of course, primarily to blame, but in the background there is usually lack of leadership, guidance and inspiration. No crew is ever any more on the ball than its airplane commander.

### Practical Questions

1. Are you the airplane commander, qualifying yourself to do justice to your crew?
2. Can all of your crew fly at high altitudes without discomfort or physical handicap?
3. Does anyone in your crew get airsick?
4. Are the turret gunners too big for their turrets?
5. Can the copilot take over in emergency?
6. Does the radio operator understand DF aids?
7. Do the gunners know how to unload and stow their guns?
8. Do the engineer and the copilot (and you) know how to use the load adjuster and how to load the airplane properly?
9. Do the engineer and copilot (and you) use

the control charts on every flight to check your knowledge of power settings and the efficient performance of your airplane?

10. Does your crew know emergency procedures and signals?
11. Is each member of your crew properly equipped?
12. What can you do to prevent or relieve anoxia, air sickness, fatigue?
13. Who is qualified to render first aid?
14. How's the morale of your outfit? Are they eager or do they sluff off?
15. How will your crew react in emergency?

These are just a few of the practical questions you as airplane commander must be able to answer to your own satisfaction.

---

## RULES TO BE ENFORCED ON EVERY FLIGHT BY THE AIRPLANE COMMANDER

### 1. Smoking

- a. No smoking in airplane at an altitude of less than 1000 feet.
- b. No smoking during fuel transfer.
- c. Never carry lighted cigarette through bomb bays.
- d. Never attempt to throw a lighted cigarette from the airplane. Put it out first.

### 2. Parachutes

- a. All persons aboard will wear parachute harness at all times from takeoff to landing.
- b. Each person aboard will have a parachute on every flight.

### 3. Propellers

- a. No person will walk through propellers at any time whether they are turning or not.
- b. No person will leave the airplane when propellers are turning unless personally ordered to do so by the airplane commander.

### 4. Oxygen Masks

- a. Oxygen masks will be carried on all day flights where altitude may exceed 10,000 feet



and on all night flights, regardless of altitude.

b. Day: All persons will use oxygen starting at 7000 to 10,000 feet on all day flights where altitude at any time will exceed 10,000 feet.

c. Night: All persons will use oxygen from the ground up on all flights during which altitude may exceed 10,000 feet.

#### 5. Training

a. Tell your crew the purpose of each mission and what you expect each to accomplish.

b. Keep the crew busy throughout the flight. Get position reports from the navigator; send them out through the radio operator. Put the engineer to work in the cruise control and maximum range charts. Require the copilot to keep a record of engine performance. Give them a workout. Encourage them to use their skill. Let them sleep in their own bunks—not

in a B-24. A team is an active outfit. Make the most of every practice mission.

c. Practice all emergency procedures at least once a week; bailout, ditching and fire drill.

#### 6. Inspections

a. Check your airplane with reference to the particular mission you are undertaking. **Check everything.**

b. Check your crew for equipment, preparedness and understanding.

#### 7. Interphone

a. Keep the interphone chattering. Ask for immediate reports of aircraft, trains, and ships just as you would expect them in combat—with proper identification.

b. Require interphone reports every 15 minutes from all crew men when on oxygen.

---

## SUGGESTED COMBAT CREW DUTY ASSIGNMENTS

#### PILOT

Principal duty : Airplane Commander  
 Secondary duty: Pilot  
 Added duty : Navigation Specialist

#### COPILOT

Principal duty : Assistant Airplane Commander  
 Secondary duty: Airplane Engineering Officer and Assistant Pilot  
 Added duty : Fire Officer  
 Added duty : Navigational Specialist  
 Added duty : Gunfire Control Officer

#### NAVIGATOR

Principal duty : Navigator  
 Secondary duty: Qualified as Nose Turret Gunner  
 Added duty : Assistant Bombardier  
 Added duty : Oxygen and Equipment Officer  
 Added duty : First Aid Specialist

#### BOMBARDIER

Principal duty : Bombardier  
 Secondary duty: Qualified as Nose Turret Gunner  
 Added duty : Airplane Armament Officer  
 Added duty : Navigation Specialist



## RESTRICTED

### AERIAL ENGINEER

Principal duty : Aerial Engineer  
Secondary duty: Top Turret Gunner  
Added duty : Qualified for Copilot Duties  
Added duty : Parachute Officer  
Added duty : First Aid Specialist  
Added duty : Assistant Radio Operator

### RADIO OPERATOR

Principal duty : Radio Operator  
Secondary duty: Waist Gunner  
Added duty : Assistant Airplane Engineer  
Added duty : First Aid Specialist  
Added duty : Qualified as Top Turret Gunner

### NOSE TURRET GUNNER

Principal duty : Nose Turret Gunner  
Secondary duty: Turret Specialist  
Added duty : Assistant to Armament Officer

### BELLY TURRET GUNNER

Principal duty : Belly Turret Gunner  
Secondary duty: Turret Specialist

### TAIL TURRET GUNNER

Principal duty : Tail Turret Gunner  
Secondary duty: Turret Specialist  
Added duty : Assistant to Parachute Officer

---

### Purpose of Assigning Added Duties

These assignments are not just so many titles. Each duty represents a specific job to be done. As airplane commander, you are **responsible** for everything but you can't **do** everything. These assignments, properly explained, will arouse the enthusiasm, energy and initiative of your crew. You have the right to demand that each crew member become an expert and maintain expert status in the particular duties assigned to him. There is nothing ironclad about the added duty assignments. These can be shifted around if there is a clear-cut advantage in doing so. For example, the suggested added

duty of the crew oxygen and equipment officer can be shifted from the navigator to the bombardier or to one of the other crew members if he is better qualified or indicates a greater interest in the problem. The main thing is to **spread** the duties, encourage the individual to become an expert and then require him to educate and supervise the rest of the crew regarding his particular specialty. Ask the crew member to read all he can and learn all he can about his specific duties; to be prepared to conduct and aid in inspections and drills, and to give the crew periodic instruction in his



specialty. You, as airplane commander, are the sparkplug of this plan. You will assign duties, call drills, and give your specialists as much opportunity as possible to spread their knowledge. To aid you, here are definitions of some of the less understood added duties.

#### Definitions of Added Duties

**Airplane Engineering Officer**—It is the duty of this officer (almost always the copilot) to know more about the airplane than any member of the crew and to see that all other crew members are instructed in all procedures pertaining to the airplane. The engineering officer should be able, by judicious questioning, to size up a new flight engineer in a few minutes' time. He should be able to perform any of the flight engineer's duties. It is his job to see that all crew members are instructed in the proper methods of transferring fuel. He is charged with the duty of seeing that proper records of engine operations are kept from flight to flight so that faulty operation will be detected before it becomes serious. He should be intimately familiar with the cruise control, climb, and maximum range charts and should educate the engineer in their use.

**Gunfire Control Officer**—It has been found that the copilot is in the best position to serve as gunfire control officer. He has the best view of developing attacks, although he cannot possibly see all enemy fighters. Although he does not attempt to actively direct the fire from all guns, he does supervise the calling of attacks, maintains strict interphone discipline, and sees that the plan and procedure for controlling fire is strictly followed. He is responsible for seeing that the crew is properly indoctrinated in the use of the throat microphone and established practice-mission procedures which will simulate as nearly as possible the interphone conversations that would be necessary in combat. In the heat of battle, crew members tend to talk too fast, speak in too high a tone, or allow the microphone to be improperly placed. The gunfire control officer will develop the interphone proficiency to a point where absolute cooperation between gun stations can be maintained on interphone.

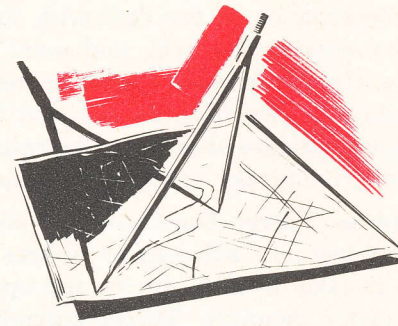

**Navigation Specialist**—Individuals with this assignment should understand all aids to navigation, understand how the navigator's log is kept, and be able in emergency to ascertain the location of the airplane and help to bring it back to base. Obviously, these men cannot be fully qualified navigators, but should know everything possible about navigation procedures that may be of aid in case the navigator is incapacitated.

**Oxygen and Equipment Officer**—This job requires a detailed understanding of the equipment and its operation. This officer confers with the personal equipment officer of the squadron regarding the use of all equipment, precautions to be taken, proper fit and care, and sees that all crew members are properly instructed. He makes periodic inspections of the crew as directed by the pilot to see that oxygen equipment is properly fitted and used. He checks all crew members on the use of walk-around bottles and sees that correct procedures are followed on high-altitude missions.

**First-Aid Specialist**—This assignment should be given, as far as possible, to individuals who already have a good knowledge of first aid. However, there should be one specialist in the nose, one in the rear compartment and one on the flight deck. If individuals in these compartments are not familiar with first aid, pilot should see that they receive adequate instruction. Combat reports reveal that lack of knowledge of first aid has cost lives on combat missions.

**Fire Officer**—This officer, usually the copilot, should know the location of all fire-fighting apparatus and know specifically when and how to use it. He should instruct the entire crew on their exact duties in case of fires. He will



arrange a program of fire drill with the pilot, aid in conducting the drill, and point out all mistakes. He will conduct a periodic inspection of the ship for fire hazards, see that the fire prevention rules are obeyed and be responsible to the pilot for proper precautions against fire.

**Qualified as Turret Gunner**—Crew members whose stations are adjacent to turrets should be able to take over the turret and operate it if emergency requires. Turret specialists instruct such crew members in the operation of the turret and use spare time in flight and on the ground to qualify such crew members as emergency turret gunners. Then they can give assistance in case of trouble with the turret or if the turret specialist is incapacitated.

**Airplane Armament Officer**—The armament officer must be familiar with all armament the airplane carries, the protection it provides and how it can best be used. In addition to his duties in connection with the loading, arming and dropping of bombs, he aids the pilot in enforcing the safety regulations regarding practice bombing, practice gunnery, and proper loading, unloading, and stowing of guns. In case of accidental discharge of a gun, he, with the gunner and pilot, will usually be considered at fault, on the ground that he has insufficiently instructed the gunner in procedures and precautions.

**Parachute Officer**—This officer will see that each crew member has his own properly fitted parachute, that he knows how to use it, that he knows how and where to leave the plane and how to open the chute and descend. (See PIF.) He will plan a drill schedule with the pilot and aid in parachute drill. Through the pilot he will see that rules regarding the care, inspection, fitting and wearing of parachutes

are observed in accordance with AAF regulations and requirements.

**Turret Specialist**—The turret specialist must know not only how to operate his turret but how to repair it and put it back in operation if necessary. He will give instruction at every opportunity to crew members near his station to qualify them as assistant turret gunners.

**Assistant Assignments**—An assistant is one who can take over a job and do it as well as the regularly assigned individual if necessary. The assistant radio operator, for example, should be able to take over and operate the radio as well (or almost as well) as the regular radio operator, etc. The most valuable man on a team is the one who can take over other jobs than his own if and when required to do so.

The above is by no means a complete statement of this problem but it should give the airplane commander the idea of what it means to “**train your crew,**” for every man to “know every other man’s job,” and what is meant by teamwork. These are not empty phrases. Every 15 minutes wasted on a mission means your crew is 15 minutes less well prepared for combat. There is no reason for your radio equipment to be idle. Your engineer has no time to sleep or sit and vegetate if he is carrying out his job of teaching all crew members to transfer fuel, working the cruise control charts, really keeping on the ball. You **have** to fly a practice mission . . . so why not run it so that your crew will get all they can out of it? It is real pleasure to develop topnotch proficiency and teamwork, and your crew will actually enjoy missions more if they feel that their skills are being utilized to the fullest extent, if only in practice.

It is worth while to discuss here also the principal duties of each of the crew members to aid the commander in judging their ability.





### COPILOT

The copilot is the executive officer: your chief assistant, understudy, and strong right arm. He must be familiar enough with every one of your duties—both as pilot and airplane commander—and be able to take over and act in your place at any time.

He must be able to fly the airplane under all conditions as well as you would fly it yourself.

He must be extremely proficient in engine operation, and know instinctively what to do to keep the airplane flying smoothly even though he is not handling the controls.

He must have a thorough knowledge of cruising control data, and know how to apply it at the proper time.

He is also the engineering officer aboard the airplane, and maintains a complete log of performance data.

He must be a qualified instrument pilot.

He must be qualified to navigate during day or night by pilotage, dead reckoning, and by use of radio aids.

He must be proficient in the operation of all radio equipment located in the pilot's compartment.

In formation flying, he must be able to make engine adjustments almost automatically.

He must be prepared to take over on instruments when the formation is climbing through an overcast, thus enabling you to watch the rest of the formation.

Always remember that the copilot is a fully trained, rated pilot just like yourself. He is subordinate to you only by virtue of your position as the airplane commander. But the B-24 is a lot of airplane; more airplane than any one pilot can handle alone over a long period of time. Therefore, you have been provided with

a second pilot who will share the duties of flight operation.

Treat your copilot as a brother pilot. Remember that the more proficient he is as a pilot, the more efficiently he will be able to perform the duties of the vital post he holds as your second in command.

Be sure that he is always allowed to do his share of the flying, in the copilot's seat, on take-offs, landings, and on instruments.

The importance of the copilot is eloquently testified by airplane commanders overseas. There have been numerous cases in which the pilot has been disabled or killed in flight and the copilot has taken full command of both airplane and crew, completed the mission, and returned safely to the home base. Usually, the copilots who have distinguished themselves under such conditions have been copilots who have been respected and trained by the airplane commander as pilots.

Bear in mind that the pilot in the right-hand seat of your airplane is preparing himself for an airplane commander's post too. Allow him every chance to develop his ability and to profit by your experience.



### NAVIGATOR

The navigator's job is to direct your flight from departure to destination and return. He must know the exact position of the airplane at all times. In order for you to understand fully how best to get most reliable service from your navigator, you must know as much about his job as possible.

Navigation is the art of determining geographic positions by means of (a) pilotage, (b) dead reckoning, (c) radio, or (d) celestial navigation, or any combination of these 4 methods. By any one or combination of methods the navigator determines the position of the airplane in relation to the earth.



### Pilotage

Pilotage is the method of determining the airplane's position by visual reference to the ground. The importance of accurate pilotage cannot be overstressed. In combat navigation, all bombing targets are approached by pilotage, and in many theaters the route is maintained by pilotage. This requires not merely the vicinity type, but **pin-point pilotage**. The exact position of the airplane must be known not within 5 miles, but within  $\frac{1}{4}$  of a mile.

The navigator does this by constant reference to groundspeeds, the ground, and to his maps and charts. ETA's are established for points ahead. During the mission, as long as he can maintain visual contact with the ground, the navigator can establish these pin-point positions so that the exact track of the airplane will be known when the mission is completed.

### Dead Reckoning

Dead reckoning is the basis of all other types of navigation. For instance, if the navigator is doing pilotage, and computes ETA's for points ahead, he is using dead reckoning.

Dead reckoning determines the position of the airplane at any given time by keeping an account of the track and distance flown over the earth's surface from the point of departure or the last known position.

Dead reckoning can be subdivided into two classes:

1. **Dead reckoning based on a series of known positions.** For example, you, as pilot, start on a mission at 25,000 feet. For the first hour your navigator keeps track by pilotage, at the same time recording the heading and airspeed which you are holding. According to plan at the end of the first hour the airplane goes above the clouds, thus losing contact with the ground. By means of dead reckoning from his last pilotage point, the navigator is able to tell the position of the aircraft at any time. The first hour's travel has given him the wind prevalent at the altitude, and the track and groundspeed being made. By computing track and distance from the last pilotage point, he can always tell the position of the airplane. When your airplane

comes out of the clouds near the target, the navigator will have a very close approximation of his exact position, and will be able to pick up pilotage points very quickly.

2. **Dead reckoning as a result of visual references other than pilotage.** When flying over water, desert, or barren land, where no reliable pilotage points are available, very accurate DR navigation still can be performed. By means of the drift meter the navigator is able to determine drift, the angle between the heading of the aircraft and the track of the aircraft over the ground. The true heading of the aircraft is obtained by application of compass error to the compass reading. The true heading plus or minus the drift (as read on the drift meter) gives the track of the airplane. At a constant airspeed, drift on 2 or more headings will give the navigator information necessary to obtain the wind by use of his computer. Groundspeed is computed easily once the wind, heading, and airspeed are known. So by constant recording of true heading, true airspeed, drift, and groundspeed, the navigator is able to determine accurately the position of the aircraft at any given time. For greatest accuracy, constant courses and airspeeds must be maintained by the pilot. If course or airspeed is changed, notify the navigator so he can record these changes.

### Radio

Radio navigation makes use of various radio aids to determine position. The development of many new radio devices has increased the use of radio in combat zones. However, the ease with which radio aids can be jammed, or bent, limits the use of radio to that of a check on DR and pilotage. The navigator, in conjunction with the radioman, is responsible for all radio procedures, approaches, etc., that are in effect in the theater.

### Celestial

Celestial navigation is the science of determining position by reference to 2 or more celestial bodies. The navigator uses a sextant accurate time and numerous tables to obtain what



he calls a line of position. Actually this line is part of a circle on which the altitude of the particular body is constant for that instant of time. An intersection of 2 or more of these lines gives the navigator a fix. These fixes can be relied on as being accurate within approximately 10 miles. The reason for inaccuracy is the instability of the airplane as it moves through space, causing acceleration of the sextant bubble (a level denoting the horizontal). Because of this acceleration, the navigator takes observations over a period of time so that the acceleration error will cancel out to some extent. If the navigator tells the pilot when he wishes to take an observation, extremely careful flying on the part of the pilot during the few minutes it takes to make the observations will result in much greater accuracy. Generally speaking, the only celestial navigation used by a combat crew is during the delivering flight to the theater. But in all cases celestial navigation is used as a check on dead reckoning and pilotage except where celestial is the only method available, such as on long over-water flights, etc.

#### Instrument Calibration

Instrument calibration is an important duty of the navigator. All navigation depends directly on the accuracy of his instruments. Correct calibration requires close cooperation and extremely careful flying by the pilot. Instruments to be calibrated include the altimeter, all compasses, airspeed indicators, alignment of the astrocompass, astrograph, and drift meter, and checks on the navigator's sextant and watch.

#### Pilot-Navigator Preflight Planning

1. Pilot and navigator must study flight plan of the route to be flown, and select alternate airports.
2. Study the weather **with** the navigator. Know what weather you are likely to encounter. Decide what action is to be taken. Know the weather conditions at the alternate airports.
3. Inform your navigator of what airspeed and altitude you wish to fly so that he can prepare his flight plan.
4. Learn what type of navigation the navigator intends to use: pilotage, dead reckoning,

radio, celestial, or a combination of all methods.

5. Determine check points; plan to make radio fixes.

6. Work out an effective communication method with your navigator to be used in flight.

7. Synchronize your watch with your navigator's.

#### Pilot-Navigator in Flight

1. **Constant course**—For accurate navigation you, the pilot, must fly a constant course. The navigator has many computations and notations to make in his log. Constantly changing course makes his job more difficult. A good navigator is supposed to be able to follow the pilot, but he cannot be taking compass readings all the time.

2. **Constant airspeed** must be held as nearly as possible. This is as important to the navigator as is a constant course in determining position.

3. **Precision flying** by the pilot greatly affects the accuracy of the navigator's instrument readings, particularly celestial readings. A slight error in celestial reading can cause considerable error in determining positions. You can help the navigator by providing as steady a platform as possible from which he can take readings. The navigator should notify you when he intends to take readings so that the airplane can be leveled off and flown as smoothly as possible preferably by using the automatic pilot. Do not allow your navigator to be disturbed while he is taking celestial readings.

4. **Notify the navigator in advance of any change in flight** such as change in altitude, course, or airspeed. If change in flight plan is to be made, consult the navigator. Talk over the proposed change so that he can plan the flight and advise you concerning it.

5. In the event there is doubt as to the position of the airplane, pilot and navigator should work together, refer to the navigator's flight log, talk the problem over and decide together the best course of action to take.

6. Check your compasses at intervals with those of the navigator, noting any deviation.

7. Require your navigator to give position reports at regular intervals.



## RESTRICTED

8. You are ultimately responsible for getting the airplane to its destination. Therefore, it is your duty to know your position at all times.

9. Encourage your navigator to use as many of the methods of navigation as possible as a means of double-checking and for practice.

### Post-flight Critique

After every flight get together with the navigator and discuss the flight and compare notes. Go over the navigator's log. If there have been serious navigational errors, discuss them with the navigator and determine their cause. If the navigator has been at fault, caution him that it is his job to see that the same mistake does not occur again. If the error has been caused by faulty instruments, see that they are corrected before another navigation mission is attempted. If your flying has contributed to the inaccuracy of the navigation, try to fly a better course the next mission.

### Miscellaneous Duties

The navigator's primary duty is navigating your airplane with a high degree of accuracy. But as a member of the team, he must also have a general knowledge of the entire operation of the airplane.

He has a .50-cal. machine gun at his station, and he must be able to use it skillfully and to service it in emergencies.

He must be familiar with the oxygen system, know how to operate the turrets, radio equipment, and fuel transfer system.

He must know the location of all fuses and spare fuses, lights and spare lights, affecting navigation.

He must be familiar with emergency procedures, such as the manual operation of landing gear, bomb bay doors, and flaps, and the proper procedures for crash landings, ditching, bailout, etc.

## THE BOMBARDIER

Accurate and effective bombing is the ultimate purpose of your entire airplane and crew. Every other function is preparatory to hitting and destroying the target.

That's your bombardier's job. The success or failure of the mission depends upon what



he accomplishes in the short interval of the bombing run.

When the bombardier takes over the airplane for the run on the target, he is in command. He will tell you what he wants done, and until he gives you the word "Bombs away," his word is virtually law.

A great deal, therefore depends on the understanding between bombardier and pilot. You expect your bombardier to know his job when he takes over. He expects you to understand the problems involved in his job, and to give him full cooperation. Teamwork between pilot and bombardier is essential.

Under any given set of conditions, ground speed, altitude, direction, etc., there is only one point in space where a bomb may be released from the airplane to hit a predetermined object on the ground.

There are many things with which a bombardier must be thoroughly familiar in order to release his bombs at the right point to hit this predetermined target.

He must know and understand his bomb-sight, what it does, and how it does it.

He must thoroughly understand the operation and upkeep of his bombing instruments and equipment.

He must know that his racks, switches, controls, releases, doors, linkage, etc., are in first-class operating condition.

He must understand the automatic pilot as it pertains to bombing.

He must know how to set it up, make air adjustments and minor repairs while in flight.

He must know how to operate all gun positions in the airplane.

He must know how to load and how to clear simple stoppages and jams of guns in flight.

He must be able to load and fuse his own bombs.



He must understand the destruction power of bombs and must know the vulnerable spots on various types of targets.

He must understand the bombing problem, bombing probabilities, bombing errors, etc.

He must be thoroughly versed in target identification and in aircraft identification.

The bombardier should be familiar with the duties of all members of the crew and should be able to assist the navigator in case the navigator becomes incapacitated.

For the bombardier to be able to do his job, the pilot of the aircraft must place the aircraft in the proper position to arrive at a point on a circle about the target from which the bombs can be released to hit the target.

Unless the pilot performs his part of the bombing run correctly, even the best bombardier in the world will be unable to bomb accurately. The pilot's failure to hold airspeed and altitude will cause the following bombing errors:

1. Flying too high: bomb will hit over.
2. Flying too low: bomb will fall short.
3. Flying too fast: bomb will fall short.
4. Flying too slow: bomb will hit over.



### THE RADIO OPERATOR

There is a lot of radio equipment in today's B-24's. There is one special man who is supposed to know all there is to know about this equipment. Sometimes he does but often he doesn't. His deficiencies often do not become apparent until the crew is in the combat zone, when it is too late. Too often the lives of pilots and crew are lost because the radio operator has accepted his responsibility indifferently.

Radio is a subject that cannot be learned in a day. It cannot be mastered in 6 weeks, but sufficient knowledge can be imparted to the radio man during his period of training in the United States providing he is willing to study.

RESTRICTED

It is imperative that you check your radio operator's ability to handle his job before taking him overseas as part of your crew. To do this you may have to check the various instructor-departments to find out any weakness in the radio operator's training and proficiency and to aid the instructors in overcoming such weaknesses.

Training in the various phases of the heavy bomber program is designed to fit each member of the crew for the handling of his jobs. The radio operator will be required to:

1. Render position reports every 30 minutes.
2. Assist the navigator in taking fixes.
3. Keep the liaison and command sets properly tuned and in good operating order.
4. Understand from an operational point of view:
  - (a) Instrument landing
  - (b) IFF
  - (c) VHF

and other navigational aids equipment in your airplane.

5. Maintain a log.

In addition to being radio operator, the radio man is also a gunner. During periods of combat he will be required to leave his watch at the radio and take up his guns. He is often required to learn photography. Some of the best pictures taken in the Southwest Pacific were taken by radio operators. The radio operator who cannot perform his job properly may be the weakest member of your crew. And the crew is no stronger than its weakest member.



### THE ENGINEER

Size up the man who is to be your engineer. This man is supposed to know more about the mechanical features of the airplane you are to fly than any other member of the crew.



## RESTRICTED

He has been trained in the Air Forces' highly specialized technical schools. Probably he has served some time as a crew chief. Nevertheless there may be some blank spots in his training which you, as a pilot and airplane commander, must fill in.

Think back on your own training. In many courses of instruction, you had a lot of things thrown at you from right and left. You had to concentrate on how to fly; and where your equipment was concerned you learned to rely more and more on the enlisted personnel, particularly the crew chief and the engineer, to advise you about things that were not taught to you because of lack of time and the arrangement of the training program.

Both pilot and engineer have a responsibility to work closely together to supplement and fill in the blank spots in each other's education.

To be a qualified combat engineer a man must know his airplane, his engines, and his armament equipment thoroughly and know how to strip, clean and re-assemble the guns. This is a big responsibility: the lives of the entire crew, the safety of the equipment, the success of the mission depend squarely upon it.

He must work closely with the copilot, checking engine operation, fuel consumption, and the operation of all equipment.

He must be able to work with the bombardier, and know how to cock, lock, and load the bomb racks.

It is up to you, the airplane commander, to see that he is familiar with these duties, and, if he is hazy concerning them, to have the bombardier give him special help and instruction.

He should have a general knowledge of radio equipment and be able to assist in tuning transmitters and receivers.

Your engineer should be your chief source of information concerning the airplane. He should know more about the equipment than anyone, yourself included.

You, in turn, are his source of information concerning flying. Bear this in mind in all your discussions with the engineer. The more complete you can make his knowledge of the reasons behind every function of the equipment,

the more valuable he will be as a member of the crew. Who knows? Some day that little bit of extra knowledge in the engineer's mind may save the day in an emergency.

Generally, in emergencies, the engineer will be the man to whom you turn first. Build up his pride, his confidence, his knowledge. Know him personally; check on the extent of his knowledge. Make him a man upon whom you can rely.



## THE GUNNERS

The B-24 is a most effective gun platform, but its effectiveness can be either amplified or defeated by the way the gunners in your crew perform their duties in action.

Your gunners belong to one of two distinct categories: turret gunners and flexible gunners.

The power turret gunners require many mental and physical qualities similar to what we know as inherent flying ability, since the operation of the power turret and gunsight are much like airplane operation.

While the flexible gunner does not require the same delicate touch as the turret gunner, he must have a fine sense of timing and be familiar with the rudiments of exterior ballistics.

All gunners should be familiar with the coverage area of all gun positions, and be prepared to bring the proper gun to bear as the condition may warrant.

They should be experts in aircraft identification.

Where the Sperry turret is used, failure to set the target dimension dial properly on the K-type sight will result in miscalculation of range.

They must be familiar thoroughly with the Browning aircraft machine gun. They should know how to maintain the guns, how to clear



jams and stoppages, and how to harmonize the sights with the guns.

While participating in training flights, the gunners should be operating their turrets constantly, tracking with the flexible guns even when actual firing is not practical. Other airplanes flying in the vicinity offer excellent tracking targets. Automobiles, houses, and other ground objects afford excellent tracking targets during low-altitude flights.

The importance of teamwork cannot be over-

emphasized. One poorly trained gunner, or one man not on the alert, can be the weak link that destroys the entire crew.

Keep the interest of your gunners alive at all times. Any form of competition among the gunners themselves will stimulate interest to a high degree.

Finally, each gunner should fire the guns at each station to familiarize himself with the other man's position and to insure knowledge of operation in the event of an emergency.



# GENERAL SPECIFICATIONS

## DIMENSIONS

### A. AIRPLANE—GENERAL

Fuselage Height	10' 5"
Over-all Span	110' 0"
Over-all Length	67' 2"
Over-all Height	17' 11"
Clearance, Inboard Propeller Tip to Ground	2' 10 1/2"
Clearance, Outboard Propeller Tip to Ground	3' 3 1/2"
Clearance, Propeller Tip to Fuselage	1' 9"
Clearance, Inboard to Outboard Propeller Tips	2' 6"
Clearance, Propeller to Wing Leading Edge	6' 2 1/16"
Clearance, Bottom of Fuselage to Ground	1' 8"

### B. WINGS

Root Chord	14' 0"
Dihedral	3° 26'
Incidence	3° 0'
Sweep—Leading Edge	3° 30'
Total Wing Area (Including Ailerons)	1048 sq. ft.

### C. FLAPS

Area (Total)	144.1 sq. ft.
Chord (Maximum)	2' 7 7/16"
Movement of Flaps (Maximum Down)	40°

### D. AILERONS

Total Area (each)	41.55 sq. ft.
Movement of Aileron, Up	20°
Down	20°
Area of Aileron Tab (Right Aileron)	2.52 sq. ft.
Movement of Tab, Up	10°
Down	10°

### E. TAIL GROUP

(1) Horizontal Stabilizer	
Over-all Span	26' 0"
Total Area	140.54 sq. ft.
(2) Elevators	
Total Area	60.06 sq. ft.
Movement of Elevator, Up	30°
Down	20°
Area of Elevator Tab (Both)	2.40 sq. ft.
Movement of Tab, Up	10°
Down	10°
(3) Vertical Fins	
Area (Both)	139.0 sq. ft.
(4) Rudders	
Total Area (Both)	65.0 sq. ft.
Movement (To Each Side)	20°
Area of Rudder Tabs (Both)	1.92 sq. ft.
Movement of Tab (Each Side)	10°

### F. LANDING GEAR

Tread	25' 7 1/2"
Wheel Base (Fore and Aft)	16' 0"

### NOTE:

It is impractical to include in a manual of this kind all data for all series. The object is to give the pilot a general picture of the B-24 airplane. It is your obligation to note and investigate the

individual differences in the particular airplane you are flying. Refer to the technical orders available in the airplane and at your base. Remember that you can never know too much about your airplane.



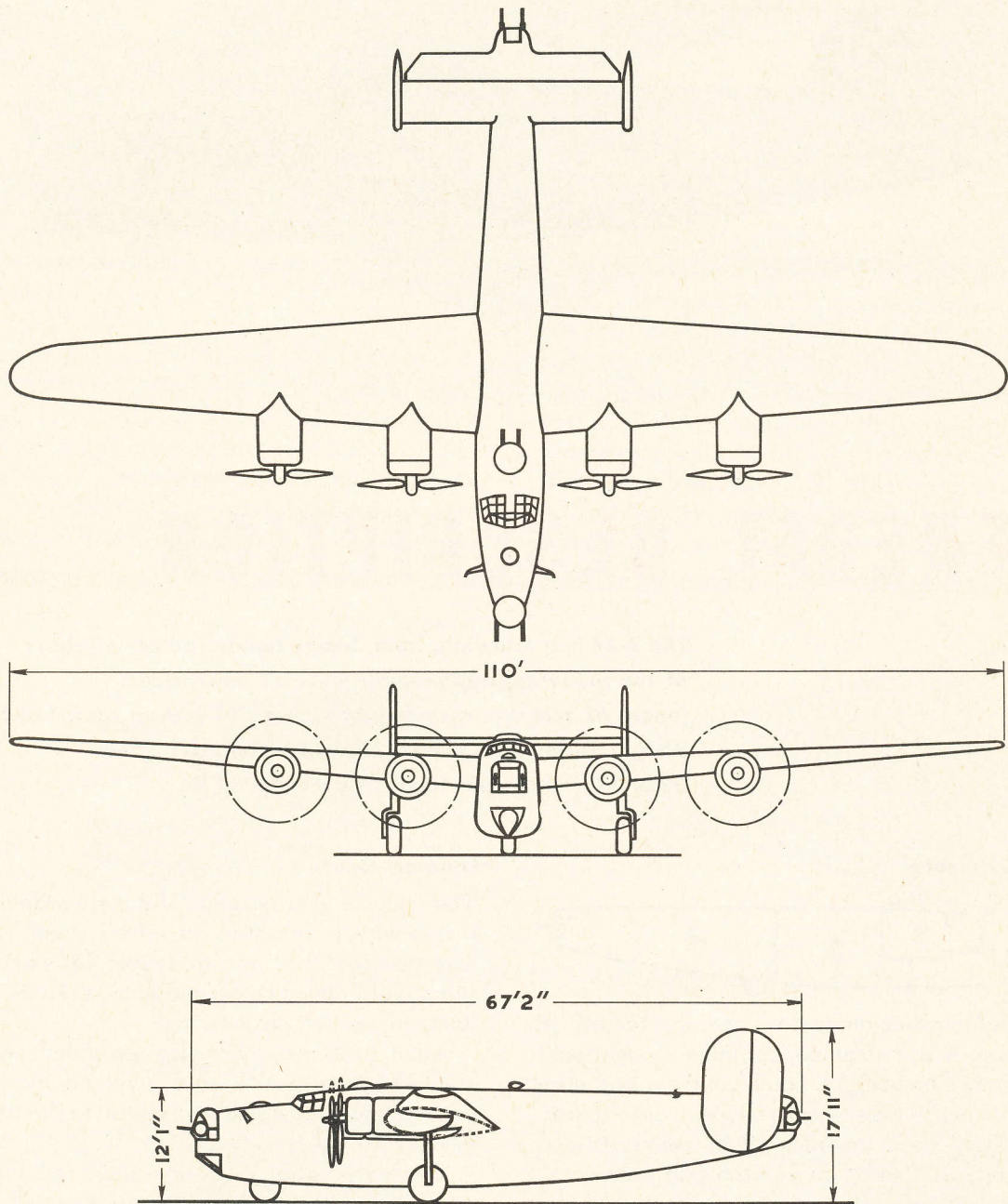



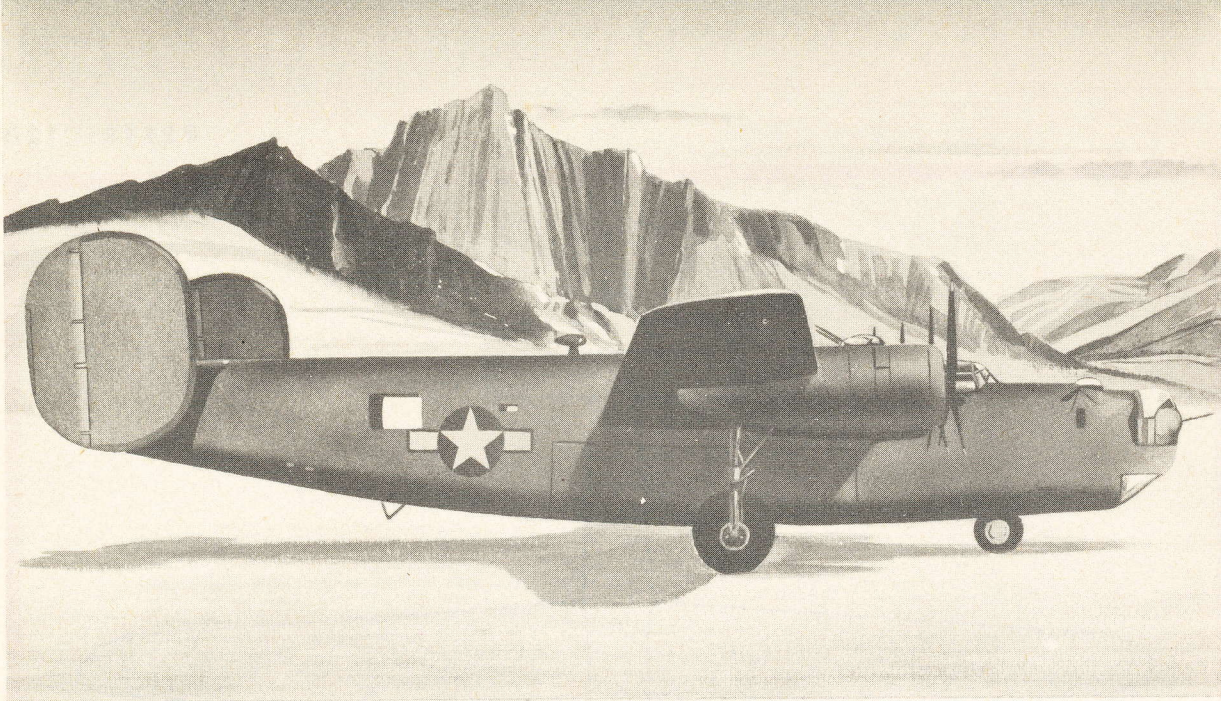

## GENERAL DESCRIPTION

The B-24 is a midwing, land, heavy bombardment airplane of the following approximate over-all dimensions: length 67 feet, 2 inches; height 17 feet, 11 inches; span 110 feet. Weight varies from a basic weight of approximately 38,000 lb. to combat loads of over 60,000 lb.

### Compartments

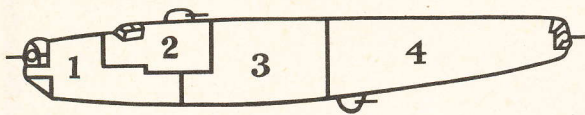

1. Bombardier-navigator's compartment, in the nose of the airplane, contains navigational equipment, bombsight, bomb controls, and nose guns, or in the case of later models, nose turret.
2. Flight deck includes pilots' compartment, radio operator's station and top gun turret.
3. Two bomb bays are in the center of the fuselage under the center wing section. Half deck is located above the rear bomb bay.
4. Rear fuselage compartment contains lower gun turret, waist guns, bottom camera hatch, and photographic equipment. Tail gun turret is in the extreme rear of the fuselage.

### Landing Gear

The tricycle gear consists of 2 main wheels and a nosewheel, mounted on air-oil shock struts. The nosewheel is free to swivel 45° each way but should never be turned more than 30°; it is damped against shimmying.

All 3 units are normally extended and retracted hydraulically by a lever on the pilot's control pedestal which also operates the landing gear locking mechanism.

The retractable shock-mounted tail bumper (or tailskid) is operated simultaneously with the landing gear (B-24 C's and early B-24 D's have non-retractable tail bumpers).

The inherent directional stability of the tricycle gear is an important aid to the pilot during taxiing, takeoff, landing operation in crosswinds, and with blown tires.



**Equipment and Systems**

The various types of equipment and systems such as the fuel, oil, hydraulic, and other systems are described in detail in separate sections of this manual. Specific and complete practical understanding of these systems is imperative for the pilot because of the emergencies which arise in combat operations.

**Armament**

Protective armor plate and guns are provided at crew stations as shown in the accompanying illustrations.

**Davis Wing**

The B-24 wing is an internally braced, skin-stressed type, tapered, with a high aspect ratio. It is considered one of the most efficient airfoils ever developed and was a radical departure from airfoils in use when the Liberator was designed. Its unusual efficiency accounts

for the combination of high speed, long range and great load-carrying qualities of the airplane. Flaps greatly vary the lift-drag characteristics of the wing, as is evidenced by the fact that normal takeoffs are made with 20° of flaps, that maximum lift and stability at slow cruising speeds can be obtained with 5° to 9° of flaps, and that 10°, 20°, and 40° of flaps effect successively larger reductions in stalling speeds.

**Propellers**

The 3-bladed propellers are Hamilton-Standard, hydromatic, full-feathering, controllable pitch, constant-speed. Toggle switches on the pilot's pedestal electrically control the governors which maintain the constant-speed feature. To operate the B-24 safely it is imperative that pilots fully understand the principle of the constant-speed propeller, its relationship to engine pressures (manifold pressure and brake mean effective pressure) and know when and when not to use the feathering feature.

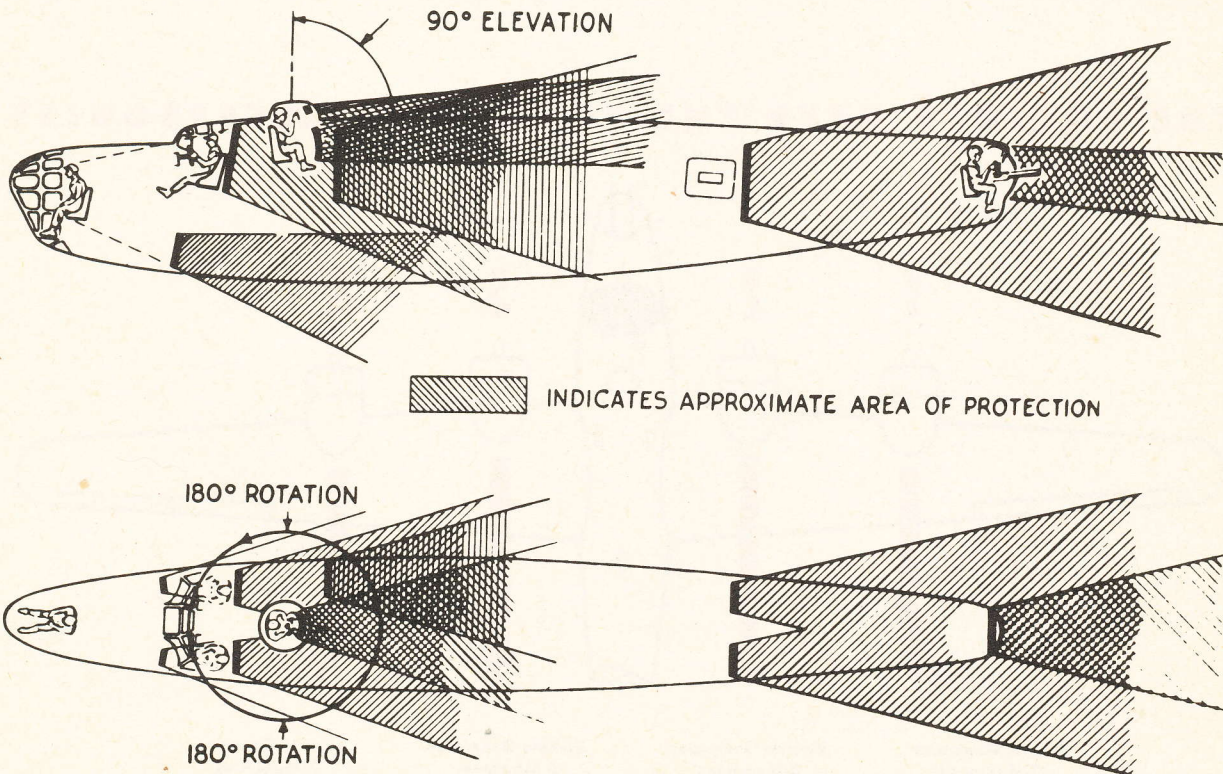

Armament and Angles of Armor Protection Diagram B-24D



## RESTRICTED

### Ignition

Engine ignition is provided by 2 American Bosch magnetos, mounted on the rear section of each engine. Separate switches permit either one or both magnetos to be operated on the engine. Battery switches are on the copilot's auxiliary switch panel. A master switch bar located just above the magneto switches is available for simultaneously shorting the primaries of all magnetos and for opening the battery circuit of the main electrical system.

### Cowl Flaps

Engine cooling is regulated by means of adjustable cowl flaps which are controlled electrically from the pilot's pedestal. The range of cowl flap control is from closed to  $12\frac{1}{4}^{\circ}$  to  $30^{\circ}$  open, depending on the model airplane.

### Carburetors

On No. 42-41115 and subsequent aircraft the Bendix Stromberg carburetor is replaced by the Chandler Evans Co. (Ceco) carburetor.

### Engines

The B-24 is equipped with 4 Pratt & Whitney 14-cylinder, twin-row radial, air-cooled engines with internal single-stage, single-speed, engine-driven integral superchargers. Engines are rated to produce up to a total of 4800 horsepower using Grade 100 fuel and takeoff power settings.

Each of the 4 engines is equipped with a turbo-supercharger to furnish compressed air to the fuel induction system at sea-level pressure.

### Control Surfaces

Rudders, elevators and ailerons are equipped with trim tabs (except left aileron) and are fabric covered; all other surfaces are metal covered.

### Wing Flaps

The all-metal, Fowler-type wing flaps retract into the wing center section trailing edge wells. Maximum down travel is  $40^{\circ}$ .

## THE ENGINES HAVE THE FOLLOWING ACCESSORIES

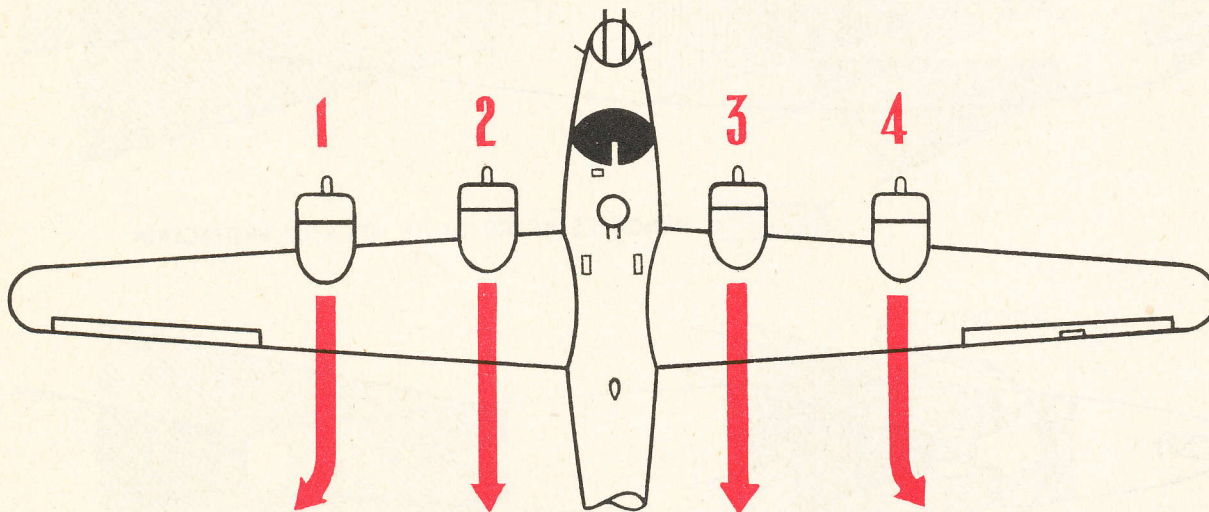

Electric Generator  
2 Magnetos  
Fuel Pump  
Turbo-supercharger  
Vacuum Pump

Electric Generator  
2 Magnetos  
Fuel Pump  
Turbo-supercharger  
Vacuum Pump

Electric Generator  
2 Magnetos  
Fuel Pump  
Turbo-supercharger  
Hydraulic Pump

Electric Generator  
2 Magnetos  
Fuel Pump  
Turbo-supercharger



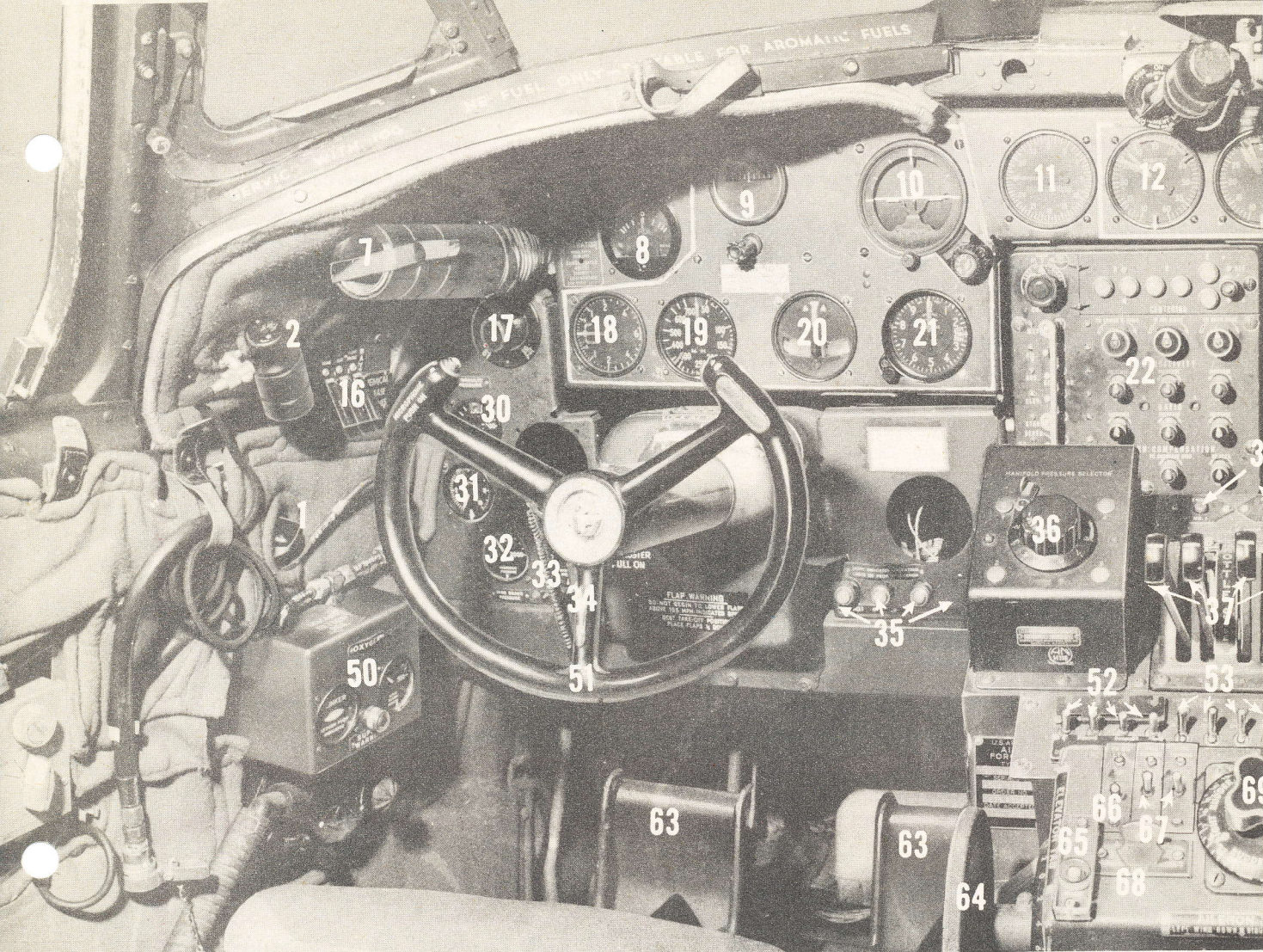

## *Cockpit of the Liberator...* B-24 PI

- |                                    |  |
|------------------------------------|--|
| 1. Fluorescent Light Switches      | 19. Airspeed Indicator                 |
| 2. 24 Volt DC Fluorescent Light    | 20. Turn and Bank Indicator            |
| 3. Magnetic Compass Light Rheostat | 21. Altimeter                          |
| 4. IFF Radio Destroyer Switch      | 22. C-1 Automatic Pilot                |
| 5. Bomb Doors Indicator            | 23. Marker Beacon Indicator            |
| 6. Bomb Release Indicator          | 24. Landing Gear Indicator Test Button |
| 7. Defroster Ducts                 | 25. Flap Position Indicator            |
| 8. Pilot Director Indicator        | 26. Landing Gear Indicator             |
| 9. Directional Gyro                | 27. Free Air Temperature Gage          |
| 10. Gyro Horizon                   | 28. Oil Pressure Gages                 |
| 11. Radio Compass Indicator        | 29. Oil Temperature Gages              |
| 12. Manifold Pressure Gages        | 30. Hydraulic Pressure Gages           |
| 13. Tachometers                    | 31. Suction Gage                       |
| 14. Fuel Pressure Gages            | 32. Inboard Brake Pressure Gage        |
| 15. Cylinder Temperature Gages     | 33. Outboard Brake Pressure Gage       |
| 16. Chemical Release Switches      | 34. Defroster Controls                 |
| 17. Ventilators                    | 35. Propeller Governor Limit Lights    |
| 18. Rate-of-climb Indicator        | 36. Turbo Boost Selector               |

RESTRICTED



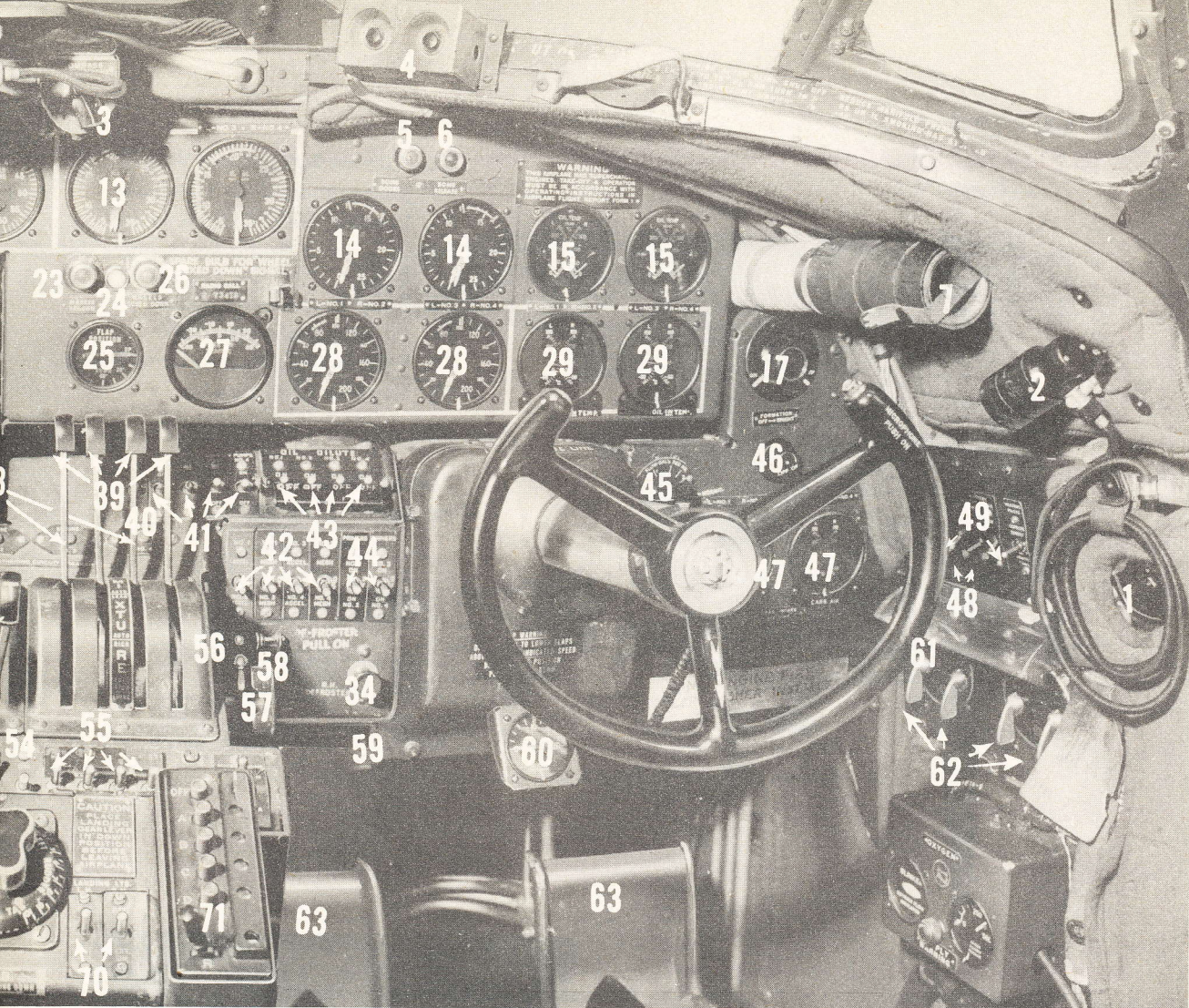

## PILOT'S INSTRUMENTS AND CONTROLS

- |   |                                   |
|---|-----------------------------------|
| 37. Throttles                             | 55. Cowl Flap Switches            |
| 38. Propeller Feathering Circuit Breakers | 56. SCR 535 Power Switch          |
| 39. Mixture Controls                      | 57. Throttle Friction Lock        |
| 40. Bomb Bay Fuel Transfer Switch         | 58. SCR 535 Emergency Switch      |
| 41. Booster Pump Switches                 | 59. De-icer Control               |
| 42. Engine Starter Switches               | 60. De-icer Pressure Gage         |
| 43. Oil Dilution Switches                 | 61. Emergency Ignition Switch Bar |
| 44. Primer Switches                       | 62. Ignition Switches             |
| 45. Anti-icer Control                     | 63. Brake Pedals                  |
| 46. Formation Lights Rheostat             | 64. Elevator Tab Control Wheel    |
| 47. Carburetor Air Temperature Gages      | 65. Alarm Button                  |
| 48. Main Storage Battery Switches         | 66. Passing Light Switch          |
| 49. Heater and Defroster Switches         | 67. Navigation Light Switches     |
| 50. Oxygen Panels                         | 68. A C Inverter Switch           |
| 51. Pilot's Wheel                         | 69. Rudder Tab Control Knob       |
| 52. Propeller Switches                    | 70. Landing Light Switches        |
| 53. Intercooler Shutter Switches          | 71. SCR 522 Control Box           |
| 54. Pitot Heater Switch                   |                                   |



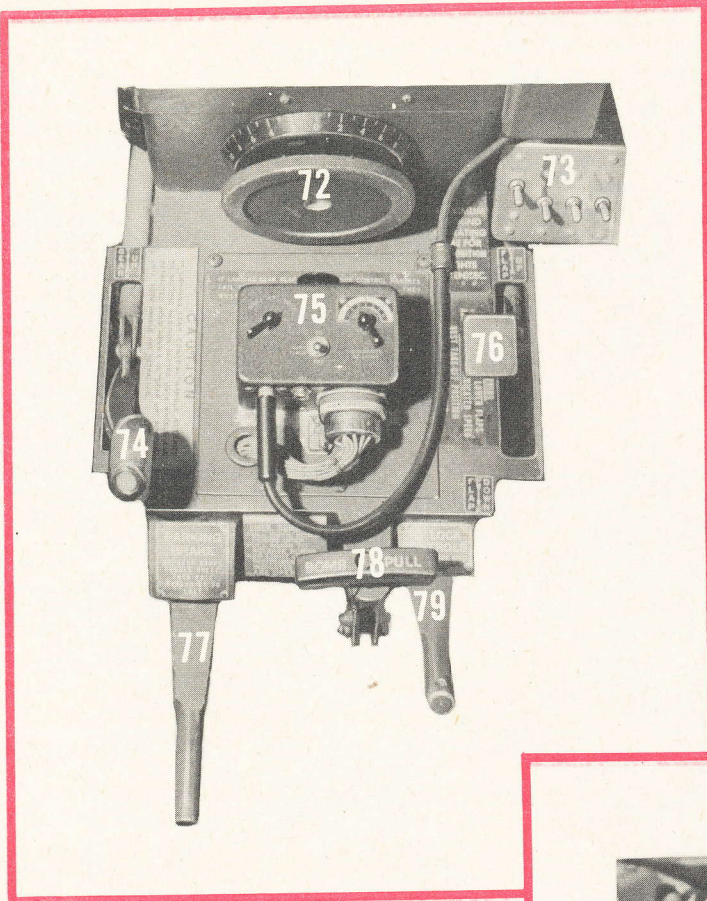

- 72. Aileron Tab Control Wheel
- 73. Recognition Light Switches
- 74. Landing Gear Control Lever
- 75. Command Radio Transmitter Control Box
- 76. Wing Flap Control Lever
- 77. Parking Brake Handle
- 78. Emergency Bomb Release Handle
- 79. Controls Lock Handle

**BASE OF  
CONTROL PEDESTAL**

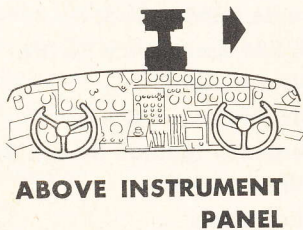
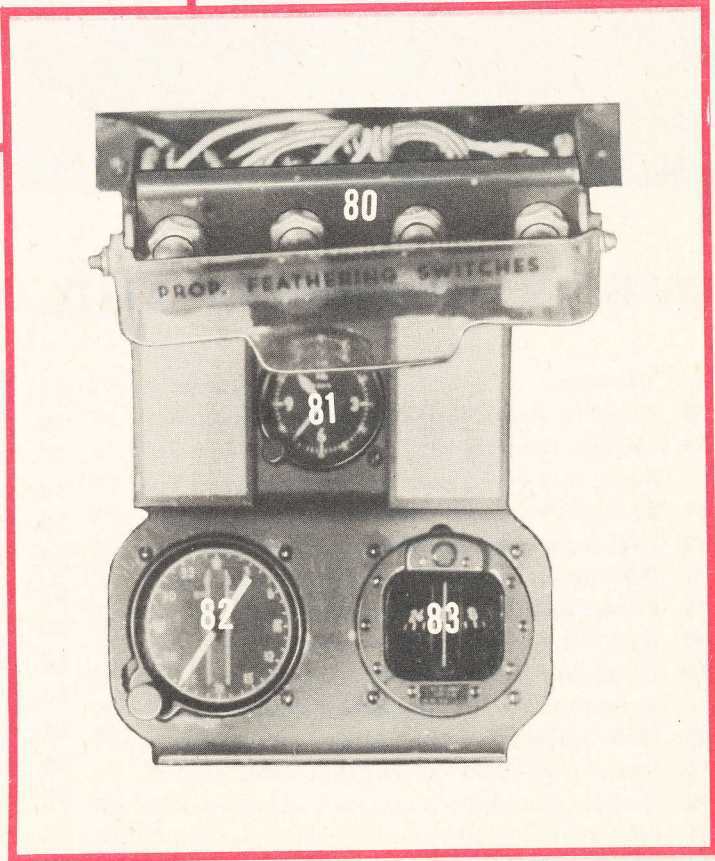
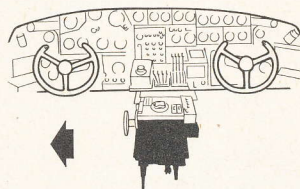

**ABOVE INSTRUMENT  
PANEL**

- 80. Propeller Feathering Switches
- 81. Clock
- 82. Remote Indicating Compass
- 83. Magnetic Compass



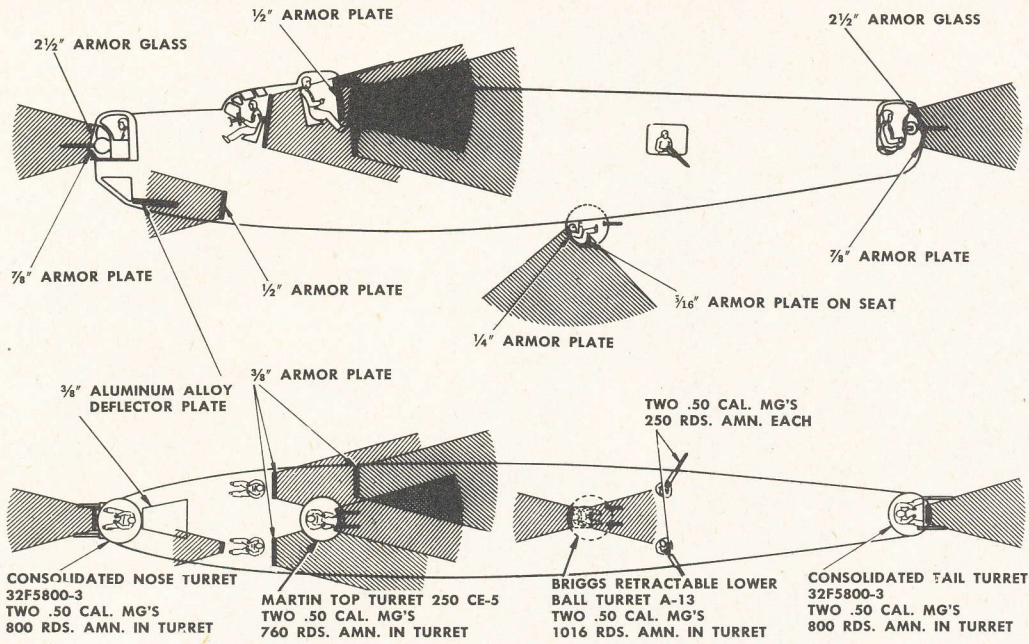

**Defensive Armament and Angles of Armor Protection—B24J**

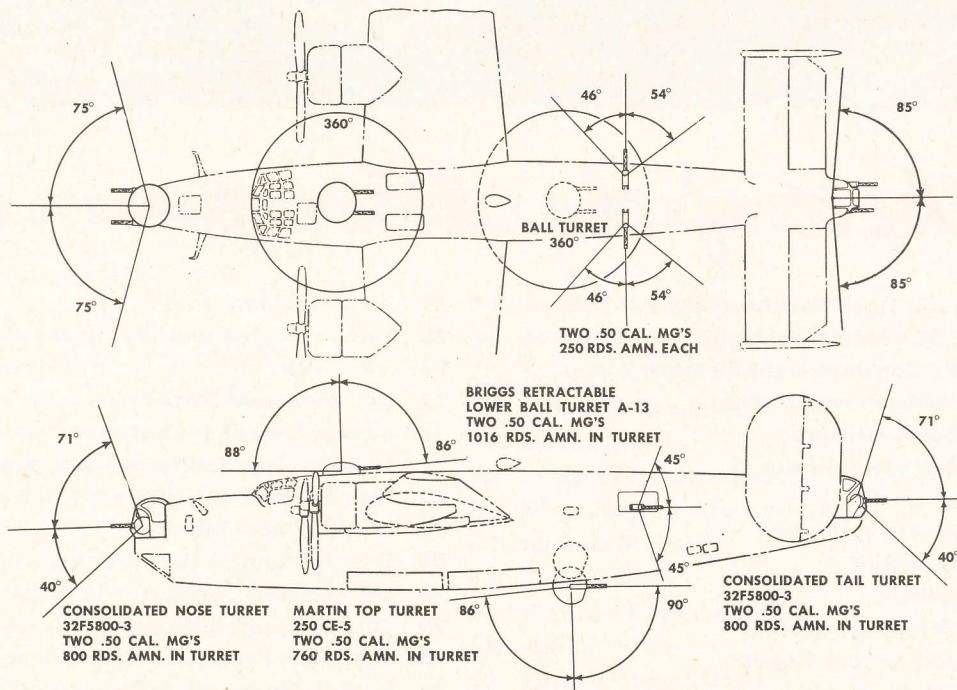

**Angles of Fire—B24J**

**RESTRICTED**



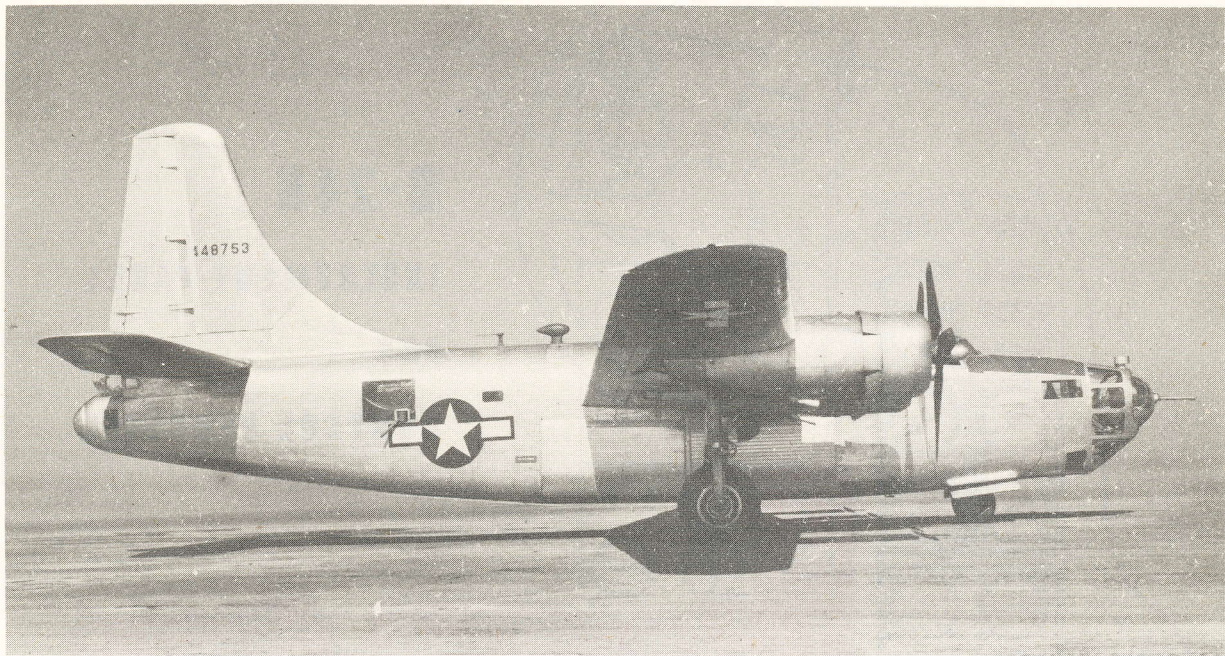

## PRESENTING THE B-24N

The new B-24N will soon be in operation in many bases in the continental United States. It incorporates a number of changes and new features developed as a result of the airplane's extensive combat experience.

The major difference in the exterior appearance of the B-24N is the single vertical stabilizer. Also, the new nose turret installation is ball type. This change has cleaned up the nose and greatly increased the pilot's forward visibility.

The most important change in the inside, as far as the pilot is concerned, is the relocation of many of the switches. Also, some of the instruments and other equipment have been moved.

The general flight characteristics of the B-24N are basically the same as those of other series, and stalling speeds are the same. The principal difference is that in earlier B-24 airplanes the rudder does not give enough directional control at low airspeeds (around 130 mph) with an outboard engine not working. In the B-24N, however, rudder control is good enough to maintain straight flight with

no yaw under these conditions. You can cruise with two engines out on one side at airspeeds of 150 to 155 mph and trim the airplane to fly "hands off." This condition has been tested, with No. 1 and No. 2 feathered and No. 3 and No. 4 pulling nearly rated power.

The control pressures have been improved making it much easier to hold the airplane under unbalanced power conditions. The rudder pressures are now considerably lighter, and aileron and elevator pressures have been lightened to a point where they are very satisfactory.

The B-24N is powered with four Pratt-Whitney, Model R-1830-75 engines, which allow more horsepower for takeoff.

The takeoff, or turbo bypass, valve has been added to the engines on the B-24N. The operation of this valve will require some study by the pilot before he becomes proficient in its use.

Generally speaking, the B-24N is much more of a pilot's airplane and the average pilot will find much less difficulty when flying under unbalanced power conditions.



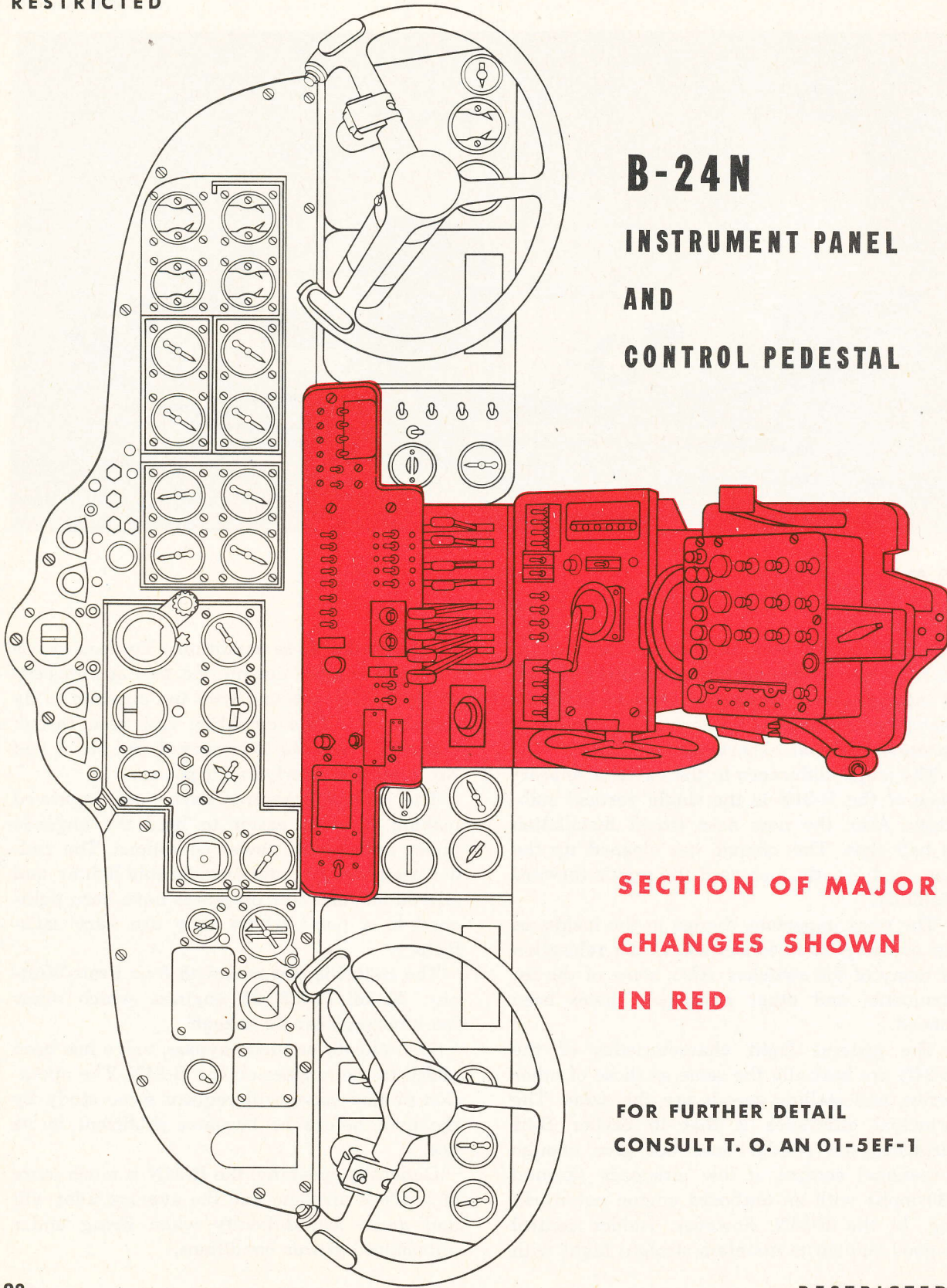

**B-24N**  
**INSTRUMENT PANEL**  
**AND**  
**CONTROL PEDESTAL**

**SECTION OF MAJOR**  
**CHANGES SHOWN**  
**IN RED**

**FOR FURTHER DETAIL**  
**CONSULT T. O. AN 01-5EF-1**



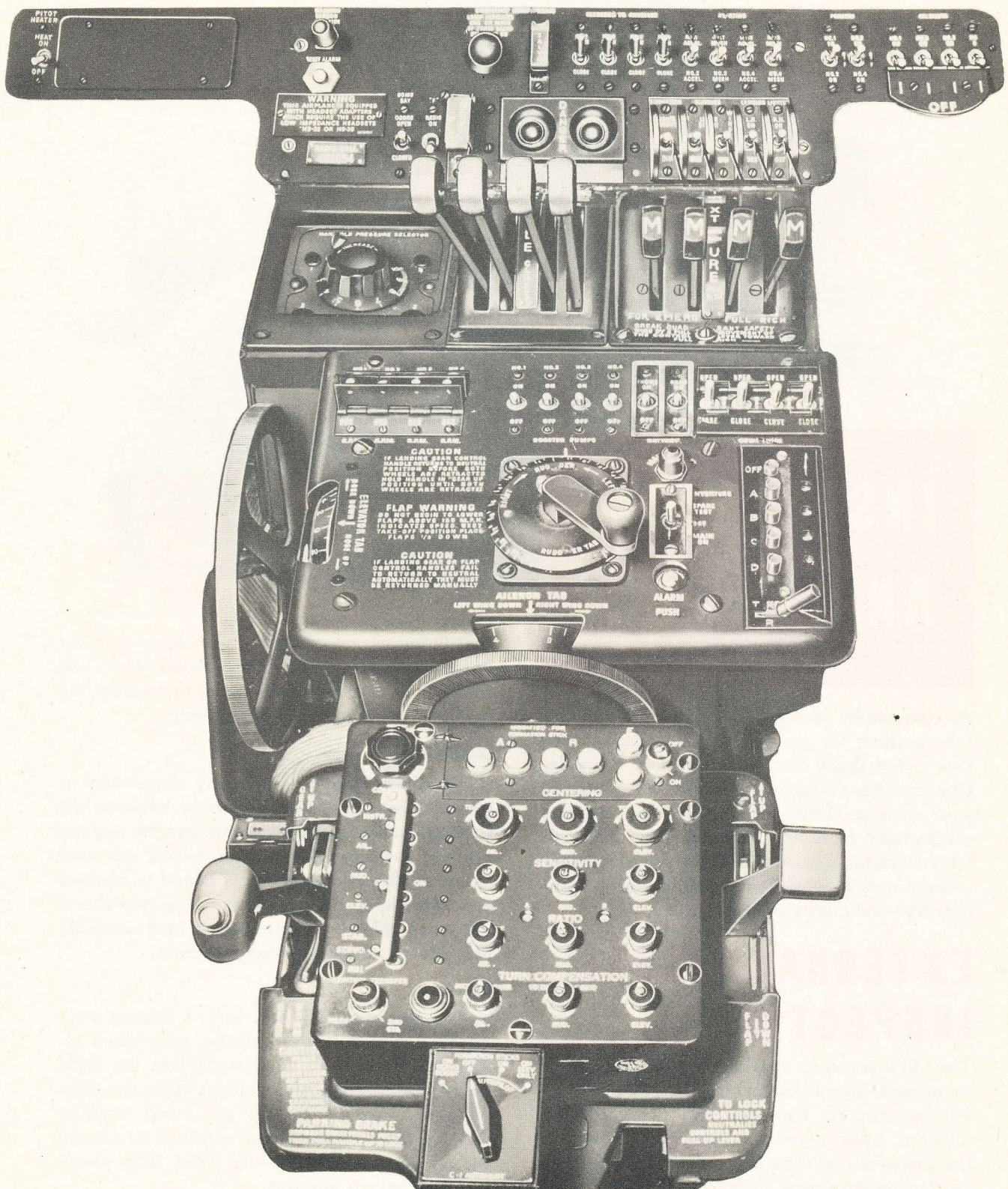





## INSPECTIONS AND CHECKS

As commander of a \$250,000 airplane, you can take nothing for granted. Satisfy yourself before every flight that your airplane is ready. One careless oversight can mean the failure of your mission. Think and act like an airplane commander from the moment you approach your airplane. This will inspire every member of your crew to work that much harder to demonstrate proficiency at his station.

### EXTERNAL VISUAL INSPECTION

Your first act upon approaching the airplane is to inspect the crew, making sure that every man is properly equipped and ready for the mission. After depositing your equipment in the airplane, execute the external inspection. Be businesslike and thorough. Keep in mind

that flying gravel, a passing vehicle or that last hard landing may have weakened your airplane. You are double-checking to see that the engineer has done his job properly.

#### **DANGER**

**Never allow anyone, under any circumstances, to walk through the propellers or between the fuselage and propellers even though the engines are not running. This is an ironclad rule that every airplane commander is bound to observe and enforce. If you are lax and set a bad example when there is no danger, it may someday cost you an absent-minded crewman.**

#### **Sequence**

The fastest, most efficient way to inspect your airplane is to follow a definite, prescribed sequence every time. Always start at the right side of the fuselage, proceed out along the right wing and around its tip (to avoid walking through the propellers) and continue on around the airplane to the starting point. **This check requires only 5 minutes.**



# SEQUENCE FOR EXTERNAL CHECK

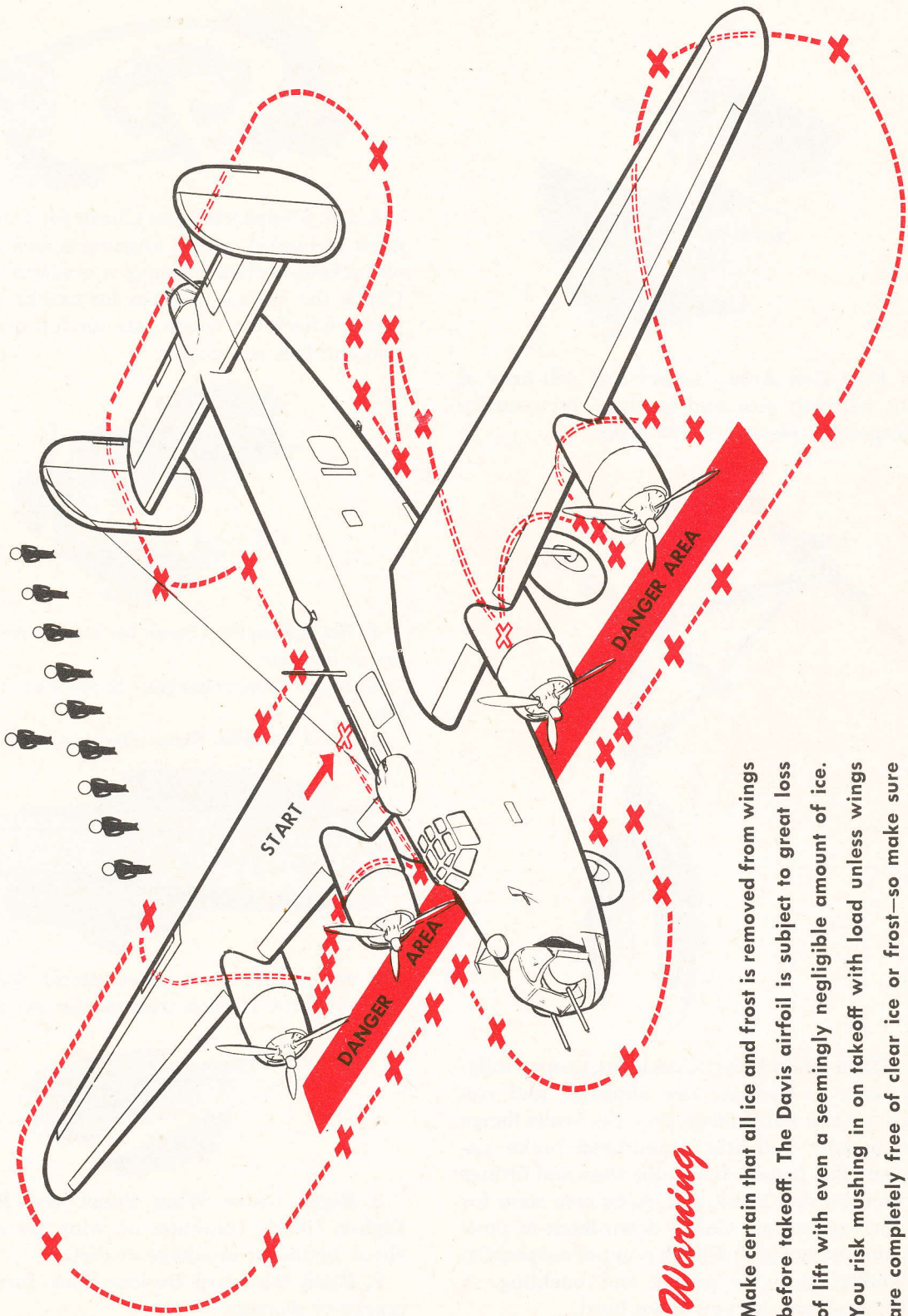

## *Warning*

Make certain that all ice and frost is removed from wings before takeoff. The Davis airfoil is subject to great loss of lift with even a seemingly negligible amount of ice. You risk mushing in on takeoff with load unless wings are completely free of clear ice or frost—so make sure they are clean!



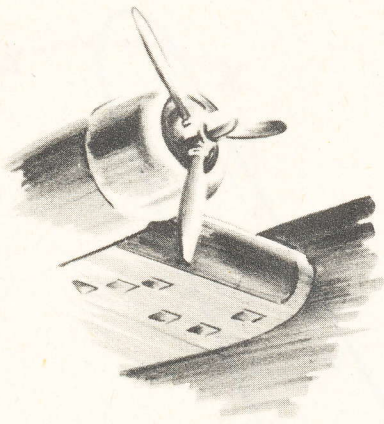

1. **Fuel Cell Area:** Inspect fuel cell area of wing, between gear and fuselage, for security of inspection plates and for leaks.

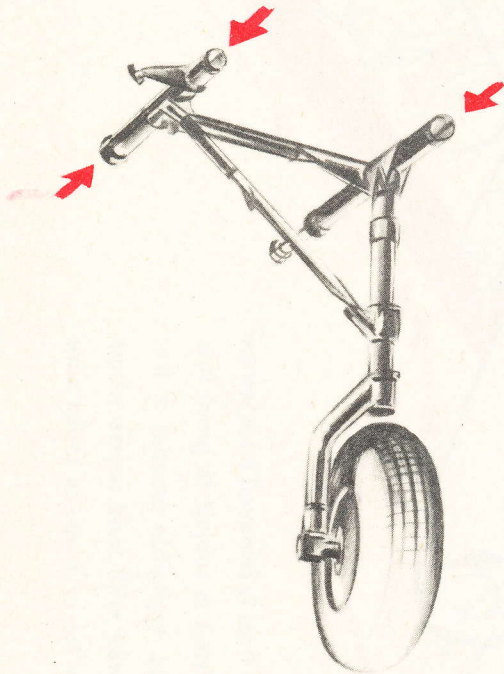

2. **Right Main Gear:** Check for proper inflation, cuts or bruises, tire slippage, and rim flange cracks. Oil leakage from the brake flange area usually indicates a ruptured brake expander tube. Inspect hydraulic lines and fittings for security and leaks, and check oleo strut for 3½-inch extension. Check down-latch in position and undamaged. Check point of suspension of landing gear for cracks and buckling. A faulty gear may let you down hard.

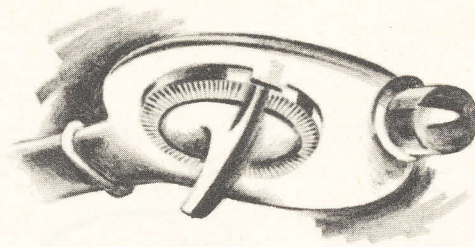

3. **No. 3 Supercharger:** Check for free movement of bucket wheel, alignment and warping of buckets, and for missing or cracked buckets. Check the exhaust section for cracks or loose joints. Check the waste gate for full open position and free movement.

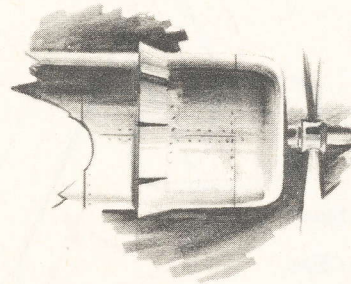

4. **No. 3 Nacelle:** Check for loose cowl fasteners or damage.

5. **No. 4 Supercharger:** Same check as for No. 3.

6. **No. 4 Nacelle:** Same check as for No. 3.

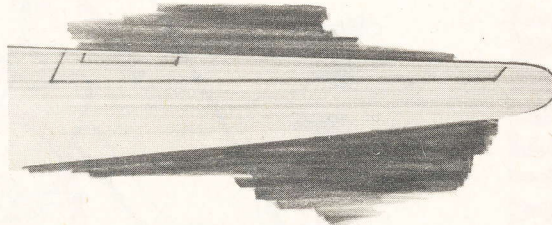

7. **Right Aileron:** Inspect aileron for condition of fabric. (Check trim tab for damage.)

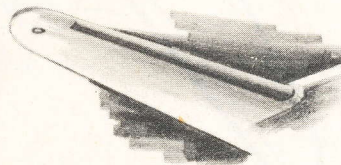

8. **Right Outer Wing Panel and Running Lights:** Check condition of wing panels, and check lights for breakage or dirt.

9. **Right Outboard De-icer Boot:** Inspect for cracks or damage.



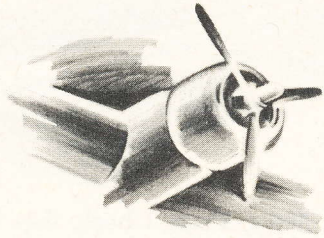

10. **No. 4 Engine:** Inspect nose section for oil leaks or foreign matter wedged between cylinders. Check propeller for cracks, and anti-icer slinger ring for security. Inspect propeller governor connections.

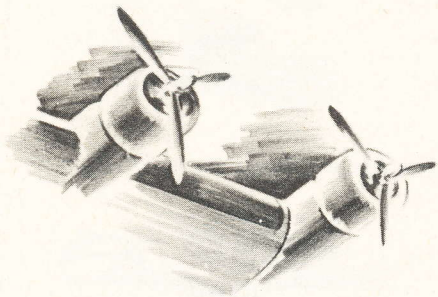

11. **De-icer Boot Between Engines:** Check for cracks or damage.

12. **No. 3 Engine:** Same check as for No. 4.

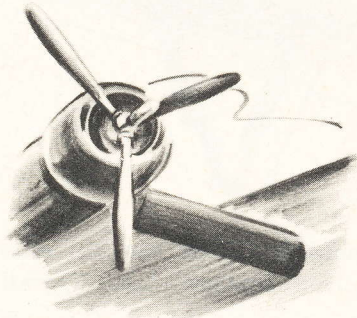

13. **Right Inboard De-icer Boot:** Check for cracks or damage.

14. **Right Pitot Tube:** Check pitot head cover; if it is not removed your bombardier's airspeed indicator won't work. (New G-2 pitot-static system has only one pitot tube, on lower left side of the nose.)

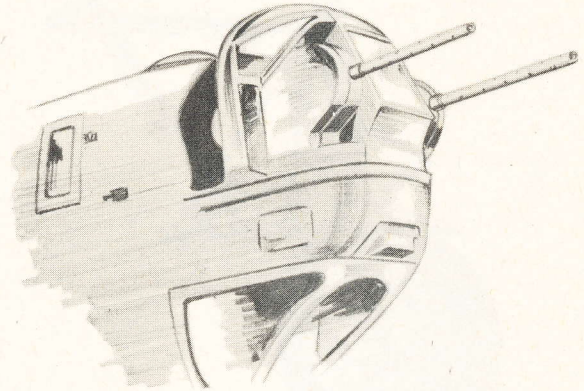

15. **Nose Turret:** Make sure that nose turret is locked in forward position and free from damage.

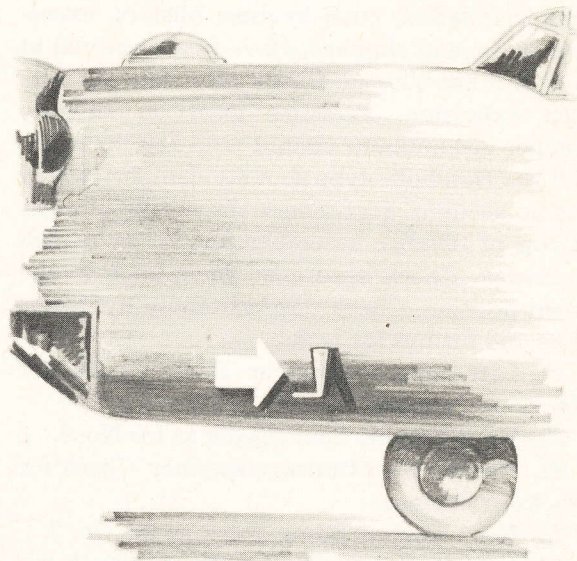

16. **Left Pitot Tube:** Same check as for right tube, to insure operation of pilot's airspeed indicator.

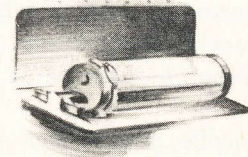

17. **Fire Extinguisher:** Open small access door in fuselage on left side of nose and check fire extinguisher for proper stowage. Reclose door securely.



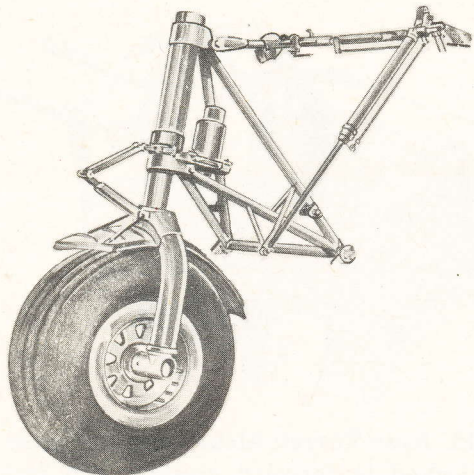

18. **Nosewheel Assembly:** Check tire for proper inflation, cuts, bruises, blisters, excessive wear, and slippage. Have tire inspected at once if it has slipped. Check oleo strut for  $4\frac{3}{4}$ -inch extension. Pressure gage on shimmy damper accumulator should read 250 lb. sq. in. If it is a Houdaille type shimmy damper (which has no accumulator), check the needle plunger at top of damper assembly for  $\frac{3}{8}$  to  $\frac{5}{8}$ -inch extension. Check nose gear down-latch in the down position. Check nose assembly hydraulic lines and fittings for leaks.

19. **Left Inboard De-icer Boot:** Check for cracks or damage.

20. **No. 2 Engine:** Same check as for No. 3.

21. **De-icer Boot Between Engines:** Check for cracks or damage.

22. **No. 1 Engine:** Same check as for No. 2.

23. **Left Outboard De-icer Boot:** Check for cracks or damage.

24. **Left Outer Wing Panels and Running Lights:** Same check as for right wing—panels for condition, lights for breakage or dirt.

25. **Left Aileron:** Inspect for fabric condition.

26. **No. 1 Nacelle:** Same check as for No. 4.

27. **No. 1 Supercharger:** Same check as for No. 4.

28. **No. 2 Nacelle:** Same check as for No. 1.

29. **No. 2 Supercharger:** Same check as for No. 1.

30. **Left Main Gear:** Same check as for right main gear.

31. **Fuel Cell Area:** Same check as for right side.

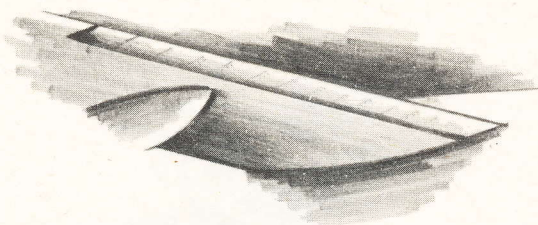

32. **Left Wing Flap:** Check flap for proper alignment with trailing edge of wing, in full up position and free from skin damage, holes, or dents.

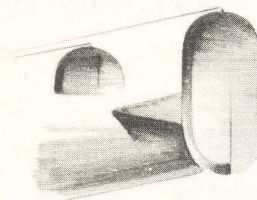

33. **Antenna:** Check for security.



34. **Ball Turret:** Make sure turret is locked in up position.

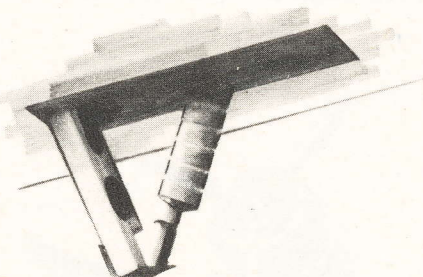

35. **Tailskid:** Check for full extension and freedom from damage; check hydraulic fittings.

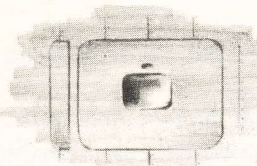

36. **Left Waist Door Wind Deflector:** Check—securely closed.



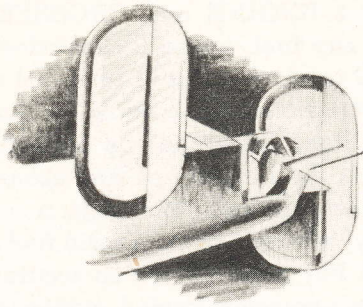

37. **Left Tail Section:** Check de-icer surfaces. Check stabilizer surfaces for loose rivets and buckling of plates. Check left fin, rudder, elevator, and trim tab for alignment and condition of fabric.

38. **Tail Turret:** Check for alignment and security.

39. **Right Tail Section:** Same check as for left side.

40. **Right Waist Door Wind Deflector:** Check—securely closed.

41. **Fire Extinguisher:** Check stowage of fire extinguisher in fuselage position just aft of rear bomb bay.

42. **Right Wing Flap:** Same check as for left wing flap.

---

Reject the airplane if you discover unsafe defects, and list all defects on Form 1A. Also report all defects to your crew chief.

---

You should have made a complete circuit of the airplane without once walking through the propellers. You are now ready to enter the bomb bay for the internal inspection. Before you do, however, check one final item:

**Pulling Through Engines:** Check that each engine has been pulled through 6 blades to assure free turning of the engine and to detect any oil or fuel in the combustion chambers which would damage the engine.

## *Danger*

Before the engineer approaches engines, check the ignition switches and the master ignition switch "OFF." See that the engineer stays clear of the propeller plane of rotation. A broken wire or a hot plug might cause a kickback and serious injury.

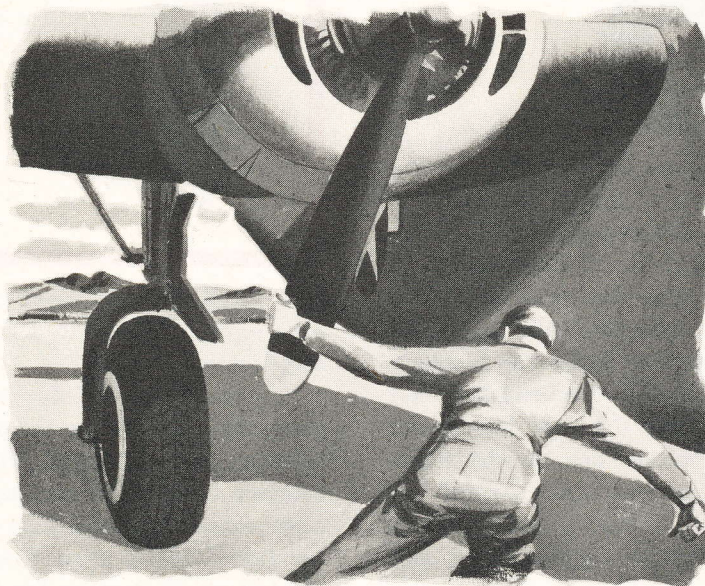



# INTERNAL VISUAL INSPECTION

The internal visual inspection is just as important as the external inspection. Keep your crew conscious of the fact that you are vitally interested in the condition of every part of the airplane. Don't tolerate rubbish or improperly stowed cargo or equipment. But be quick to praise the well-kept airplane. Execute the interior inspection in the following sequence:

1. **Rear Section of Fuselage:** Upon entering the bomb bay doors proceed to the rear and inspect location and anchoring of cargo, gear, guns, and ammunition.

2. **Hydraulic Reservoir:** Check for leakage. Should be filled to within 1/2 inch of red line on reservoir gage, provided the accumulators are properly charged. Check hydraulic reservoir emergency suction valve in horizontal position.

3. **Emergency Hydraulic Star Valve:** Check in the closed position and safety wired.

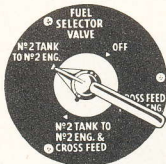

4. **Fuel Selector Valves:** On your way to the flight deck check each of the 4 fuel selector valves set in tank-to-engine positions, i.e., No. 4 tank to No. 4 engine, No. 3 tank to No. 3 engine, etc., to make sure that each engine is receiving fuel from its main fuel cells only. Two of these valves are mounted inside the fuselage on each side of the bomb bay overhead between the wing spar and Station 4.2. (On late-model planes, fuel selector valves are on the flight deck.) The 2 valves on the right control the flow to engines No. 3 and No. 4, and those on the left control the flow to engines No. 1 and No. 2, as numbered.

**Caution:** Should the 4 main tank selector valves be set at "1, 2, 3, and 4 TANK to No. 1,

2, 3, and 4 ENGINE and CROSSFEED," a failure of any fuel line or the crossfeed manifold would result in a loss of both fuel and fuel pressure. On takeoff this would be disastrous.

5. **Fuel Sight Gages:** As you enter the flight deck, check the quantity of fuel aboard using the gages on your left. Each gage is connected by a 2-way valve to 2 of the 4 main fuel systems as labeled. For gages to give an accurate reading, the inclinometer located outboard of the gages must be centered.

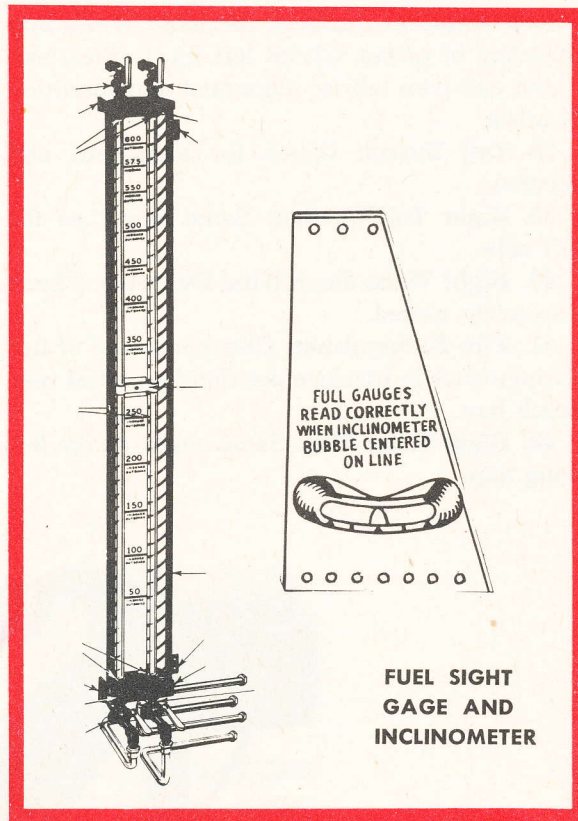

6. **Flight Deck:** Check placing of gear, movable equipment secured in proper places, windows clean, etc.

7. **Personnel:** Satisfy yourself that all persons are aboard, are properly clothed for the mission, are equipped with a parachute and oxygen mask, and understand their use. Be sure sealed first-aid kits are in their proper locations. Make sure there is ample oxygen aboard at all stations for the mission planned. Check to see that all personnel know the emergency warning signals for bailout and ditching



and the procedures to be followed, and that they know their stations for takeoffs, flight and landings. See that a loading or passenger list has been sent to Operations if required.

8. **Maps and Navigational Aids:** Make sure that necessary up-to-date maps, copies of instrument procedures, radio facility charts, radio aids to navigation and direction-finding charts are aboard.

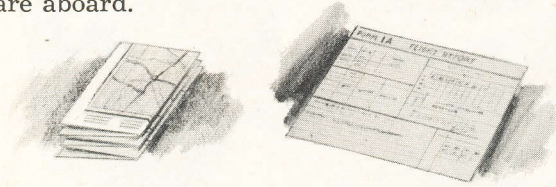

9. **Form 1A:** Before you accept the airplane, study Form 1A and note all defects, comments of pilots and notations by crew chief of work done on the airplane since the last flight.

10. **Loading:** Ascertain that the airplane is properly loaded within the allowable center of gravity (CG) limits by checking Form F in "Weight and Balance Data" in the airplane.

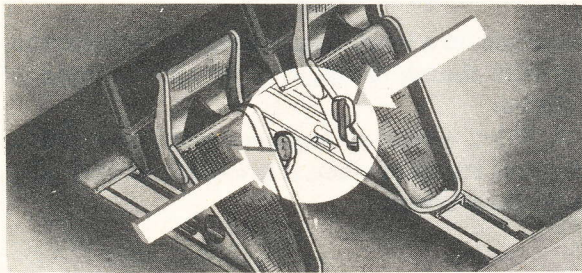

11. **Seating:** After these things have been accomplished, the pilot and copilot are ready to get into their seats, fasten safety belts, and adjust the seats and foot pedals to permit full

rudder and brake control. The levers on the seat permit adjustment fore and aft, up and down, and tilt. To adjust rudder pedals, push the pedal adjustment lever away from the pedal with the toe and move the pedal fore or aft. **Be sure the catch relocks properly.**

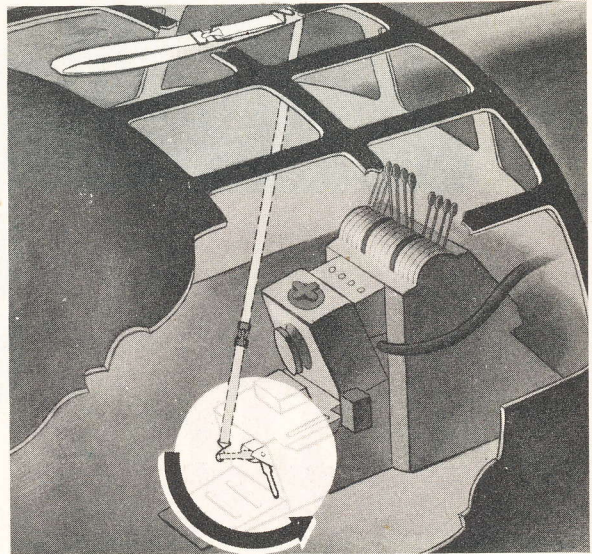

12. **Unlocking Controls:** Copilot unlocks controls, securely stows the strap overhead so it won't bang the pilot in the face, and checks the locking lever in the full down position to make sure the lock is released. Then you are ready to start the checklist procedure.

**Wait:** Is everyone aboard? Is all equipment aboard? Is the fuel supply ample? It is always embarrassing to have to return to the line, to bail out without a parachute, or to arrive over the target without your bomb load.





# THE CHECKLIST

No pilot (in his right mind) neglects the checklist in a 4-engine airplane. Your mission, your airplane and your crew are too important for half-measures. No pilot can ignore the checklist on flight after flight without getting into serious trouble. A big-shot attitude toward the checklist is risky and sets a bad example for your copilot and your crew. To old-time B-24 pilots, who have been through the mill, the checklist is as vital a piece of equipment as the rudders or the flaps.

### Approved Checklist Technique

Develop a professional teamwork technique in using the checklist so that you and your copilot are double-checking each other all the time. Require complete cooperation from your copilot and engineer. Sloppy crew work is usually a direct reflection of the attitude of the airplane commander. Following is approved checklist technique:

1. Pilot calls, "Checklist!"
2. Copilot picks up the checklist and holds it throughout the procedure.
3. Copilot calls out each checklist item in

sequence, in a loud, clear voice, and indexes the list with thumb or finger to be sure nothing is omitted.

4. Pilot, copilot or engineer makes a positive check of the item when it is called out and calls back the answer.

## *Caution*

Never start on the next checklist point until the preceding one is completed, or the result will be confusion and omissions. **Believe and practice this.** Don't wait for bitter experience to prove it. Never say "Okay" without checking. Sloppy use of the checklist is responsible for more emergencies than almost any other form of pilot error.

### Snap Into It

Get some snap into the checklist procedures. Alert, professional cockpit work with items called off and answered in clear, ringing tones will lift the spirits of your crew and get them on the ball just as a good quarterback's signals bring his team to life.



# BEFORE STARTING ENGINES

Following are the cockpit duties and checklist points for the before-starting check.

## Amplified Checklist

### 1. Copilot: "FORM 1A?"

Pilot: "Form 1A checked!"

Pilot's reply indicates that he has completed the required preflight inspection of Form 1A.

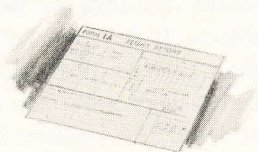

### 2. Copilot: "LOADING?"

Pilot: "Loading checked!"

Pilot's reply indicates that he has completed the preflight requirements for proper loading.

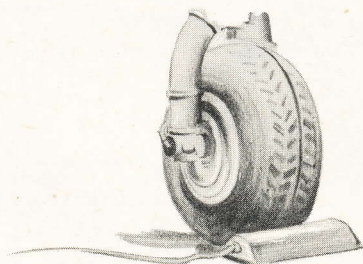

### 3. Copilot: "WHEEL CHOCKS?"

Each pilot checks the chock on his side. Chocks should not be against the tire but should be 2 to 6 inches forward of the wheel. Parking brakes will normally hold the airplane. Chocks may become jammed under the tires if placed against them.

Pilot: "Wheel chock in place left!"

Copilot: "Wheel chock in place right!"

### 4. Copilot: "PITOT COVERS?"

Each pilot looks at the pitot head on his side of the airplane to be sure the pitot covers have been removed.

Pilot: "Removed left!"

Copilot: "Removed right!"

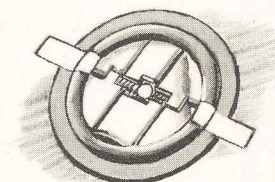

### 5. Copilot: "GAS TANK CAPS?"

Security of caps is vitally important. If a gas tank cap isn't properly seated, gas may be syphoned out by the suction on top of the wing, rapidly emptying your tanks. Some of this gas will usually run back through the wing into the bomb bay, creating a dangerous fire hazard.

Engineer: "Gas tank caps checked!"



### 6. Copilot: "FLIGHT CONTROLS?"

Pilot and engineer check all controls. Engineer puts his head out the flight deck escape hatch to watch control surfaces. The pilot moves controls to extreme positions calling out each set as he operates them.

Pilot: "Controls checked visually!"

Example: As the pilot moves the wheel full back he calls out, "Elevators," and the engineer replies, "Elevators up." As the pilot moves the wheel full forward the engineer calls out, "Elevators down." The check continues: "Rudders"—"Rudders right," . . . "Rudders left," . . . "Rudders neutral,"—"Ailerons"—"Right aileron down, Left aileron up," . . . "Right aileron up, left aileron down."



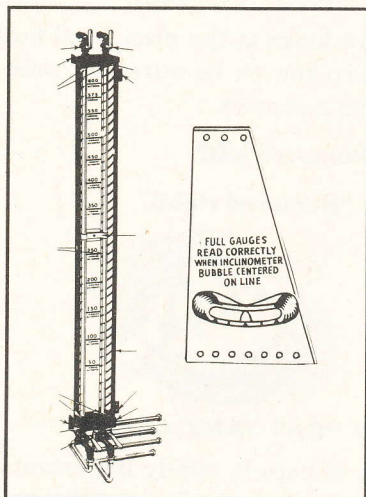

**7. Copilot: "FUEL TANK VALVES AND AMOUNT?"**

**Engineer: "Checked . . . (number) gallons of gas and . . . (number) gallons of oil aboard."**

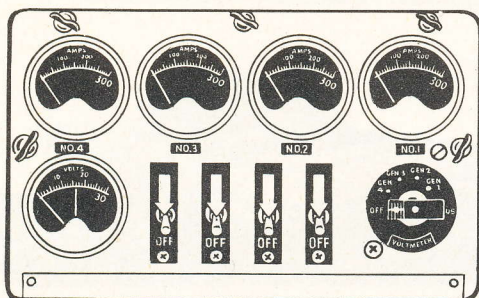

**8. Copilot: "GENERATORS?"**

Copilot and engineer look back to check generators in "OFF" position. Generators are kept off until just before takeoff to prevent drain of battery current back to generator in case of faulty reverse current relay and because generators will not charge unless rpm is 1700 or more.

**Engineer: "Generators off!"**

**9. Copilot: "CARBURETOR AIR FILTERS?"**

In absence of dust and blowing sand, carburetor air filters are always kept closed. Engineer sets them as directed for local conditions.

**Engineer: "Carburetor filters (as required)."**

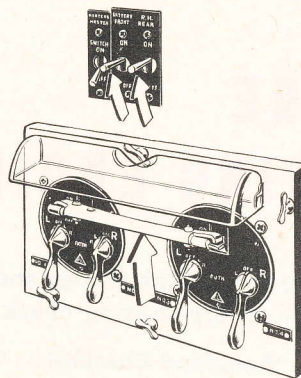

**10. Copilot: "MAIN LINE AND BATTERY SELECTORS?"**

Copilot turns on these switches and checks each battery selector separately by referring to the voltmeter reading to determine the battery condition. If the battery cart is used to start engines, turn on the main line switch but leave the battery selectors off. This directs current from the battery cart through the main line bus and prevents drain of the plane's batteries.

**Copilot: "Main line and battery selectors on!"**

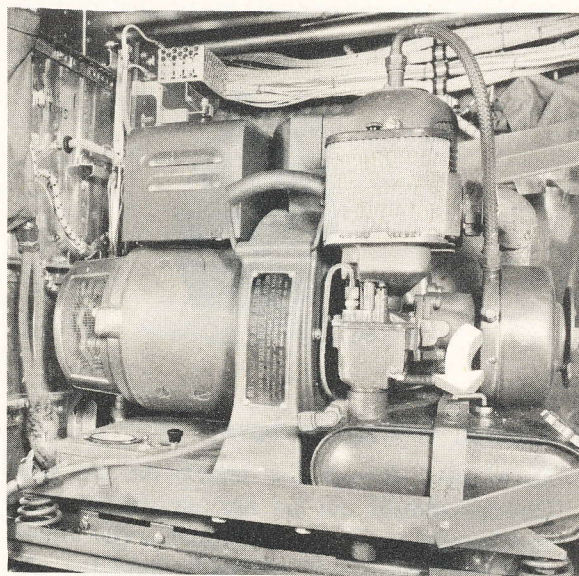

**11. Copilot: "AUXILIARY POWER UNIT AND HYDRAULIC PUMP?"**

The engineer starts the auxiliary power unit and turns on the hydraulic pump. The pump



cuts in to charge accumulators when the pressure drops below 975 lb. and cuts out at 1180 lb. When No. 3 engine is operating, the engine-driven pump charges accumulators through the unloading valve when pressure drops below 850 lb., and cuts out at 1050 lb.

Engineer: "Auxiliary power unit and hydraulic pump on."

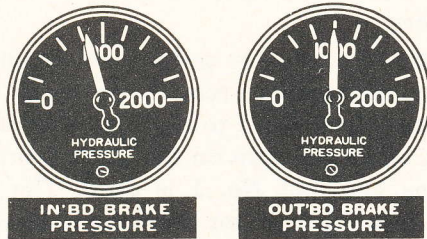

12. Copilot: "BRAKE PRESSURE AND PARKING BRAKE?"

The pilot applies the brakes, checks the in-board and outboard brake pressure gages at 975 lb. to 1180 lb. and sets the parking brake.

Pilot: "Pressure checked and parking brake on!"

To set the brake, hold the brake pedals down, raise the parking brake handle and then release the brake pedals. Never force the handle either up or down or you will snap the locking pin.

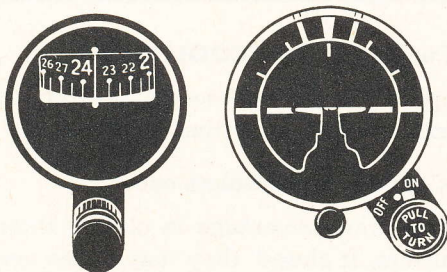

13. Copilot: "GYROS?"

Pilot uncages the directional gyro and the flight indicator. Then, when the engine that provides suction is started (No. 1 or 2), the speed with which the flight indicator rights itself indicates its reliability. (Note: Jack and

Heintz indicators must be uncaged and manually righted after engines are started.)

Pilot: "Gyros uncaged."

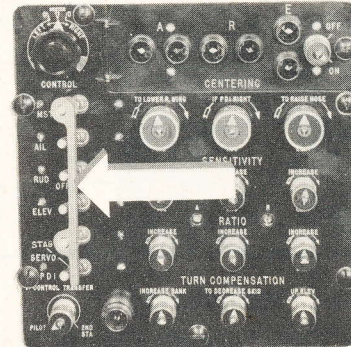

14. Copilot: "AUTOMATIC PILOT?"

Pilot checks all switches on the automatic pilot in "OFF" position. If you attempt a take-off with this unit connected, it is extremely difficult to overpower it.

Pilot: "Automatic pilot off!"

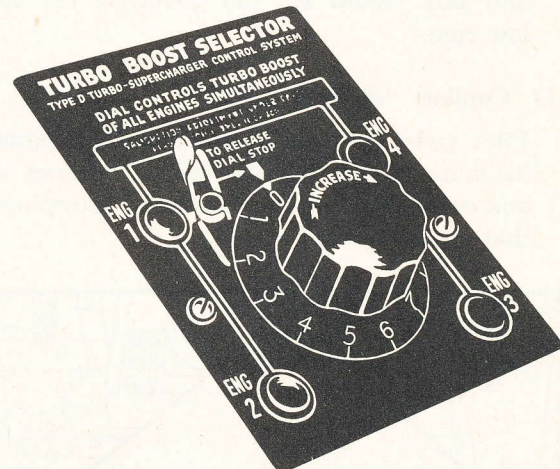

15. Copilot: "SUPERCHARGERS?"

Pilot checks all superchargers in "OFF" position. Superchargers should have been left off when the engines were last stopped so that waste gates are open. If waste gates are closed when you start the engines, the exhaust system or the turbo may be damaged by the excessive exhaust pressure. With electronic turbo control, set dial at zero.

Pilot: "Superchargers off!"



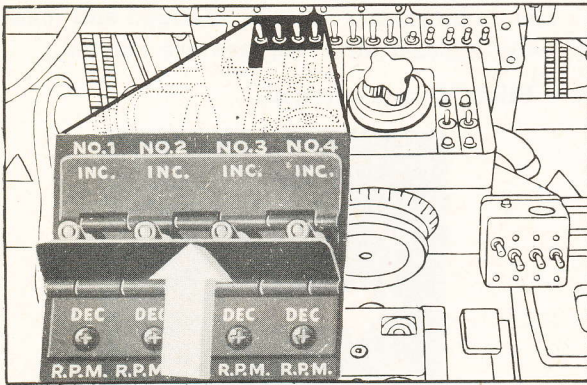

**16. Copilot: "PROPELLERS?"**

Copilot holds propeller toggle switches forward to "INCREASE" rpm. If governor limit lights come on, propeller governors are set for full high rpm.

**Copilot: "Props in high rpm!"**

**Caution:** Be sure to move toggle switches forward; governor limit lights will also come on when toggle switches are moved back, and this would set the governor for full low rpm.

**17. Copilot: "ALARM BELL?"**

Pilot gives the normal abandon-ship signal, listening for the bell himself as he does so, and each crew member replies by interphone that he has heard the bell.

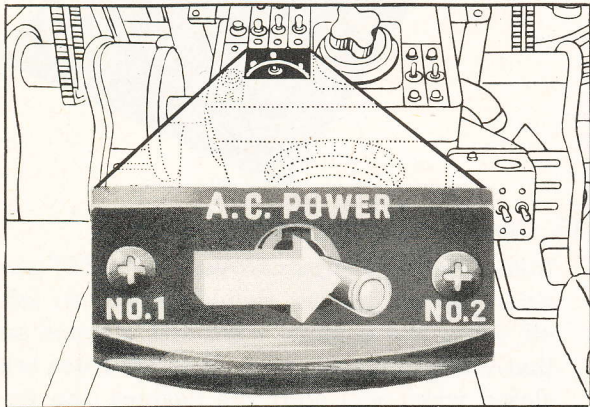

**18. Copilot: "AC POWER SWITCH"**

Copilot moves this switch to No. 2 inverter and checks it by switching on one booster

pump and noting a rise in fuel pressure on the corresponding fuel pressure gage. He then flicks off the booster pump, moves the AC switch to neutral, switches to No. 1 inverter and again uses the booster pump check.

**Copilot: "AC power on and checked!"**

Use the No. 1 inverter and save No. 2 as an alternate, emergency position. It is bad practice to switch back and forth between inverters.

**Note:** On some late series aircraft an automatic change-over relay is installed which switches from No. 1 to No. 2 inverter if No. 1 fails, and a red light on the instrument panel warns you that No. 1 is dead. The toggle switch is still used for checking inverters.

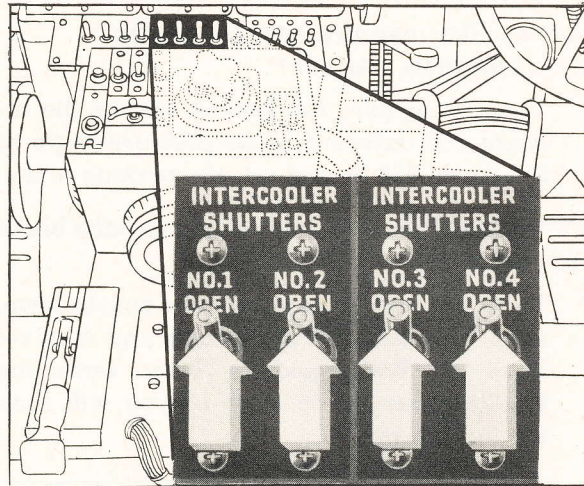

**19. Copilot: "INTERCOOLERS?"**

Copilot checks intercooler shutters in open position which is normal.

**Copilot: "Intercoolers open."**

There is no advantage in closing intercooler shutters. If closed, they may cause overheating and detonation on takeoff. Check the proper operation of shutters by listening to each motor while moving switches to closed and back to open positions. If the motors cannot be heard, the engineer or a member of the ground crew should check shutters in operation, checking them in the open position.



**20. Copilot: "PITOT HEATER?"**

Copilot flicks switch on and off while looking back at voltmeter for a flicker indicating current drain. The only accurate check is for the engineer to feel the pitot tube heat during his preflight.

**Engineer: "Pitot heaters checked!"**

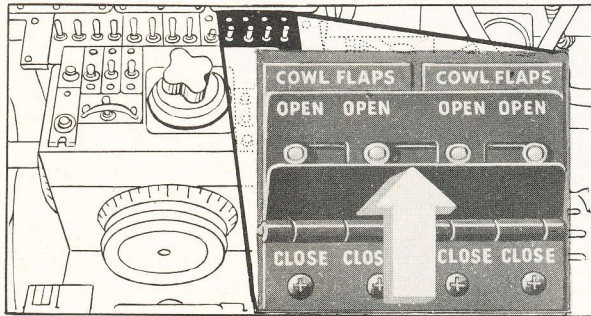

**21. Copilot: "COWL FLAPS?"**

Copilot opens them and checks them on the **right** while the pilot checks them on the **left**. Cowl flaps are open while starting to help keep the engine cool and to facilitate putting out fires from the outside.

Caution: Never close cowl flaps to hurry warm-up because this will damage the ignition harness, especially at the spark plug elbows, by excessive heating.

**Pilot: "Cowl flaps open left!"**

**Copilot: "Cowl flaps open right!"**

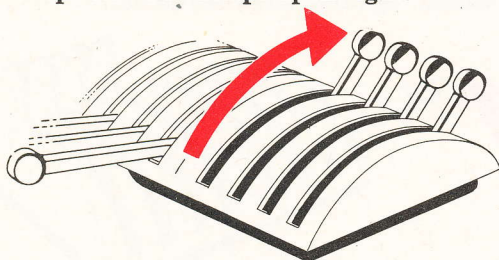

**22. Copilot: "MIXTURE CONTROLS?"**

Copilot checks mixture controls forward in "IDLE CUT-OFF." Otherwise blower section will be flooded when booster pumps are turned on, creating a fire hazard and making starting difficult.

**Copilot: "Mixtures in idle cut-off!"**

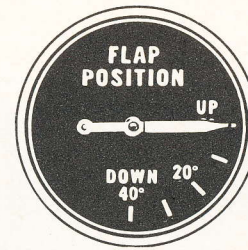

**23. Copilot: "WING FLAPS?"**

Copilot checks that the flap control handle is in the neutral position and that the flap indicator shows flaps are up.

**Copilot: "Wing flaps up!"**

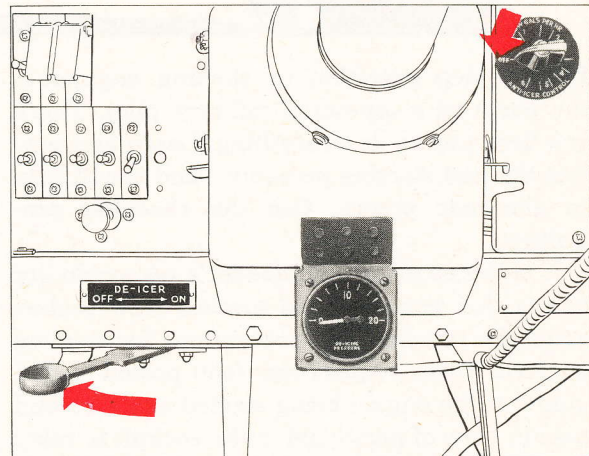

**24. Copilot: "WING DE-ICERS; PROPELLER AND CARBURETOR ANTI-ICERS?"**

Copilot checks each in "OFF" position. This is vital. Even partial inflation of the wing de-icer boots reduces lift and increases the stalling speed. When on, propeller anti-icers will pump fluid on the ground and carburetor anti-icers (if so equipped) will pump fluid into the carburetors, enriching the mixture.

**Note**—If exhaust heat anti-icing is installed, the cabin heat or anti-icing switches may be on if desired.

**Copilot: "All de-icers and anti-icers off!"**

**As soon as the before-starting check is completed, you are ready to start engines.**



# STARTING ENGINES

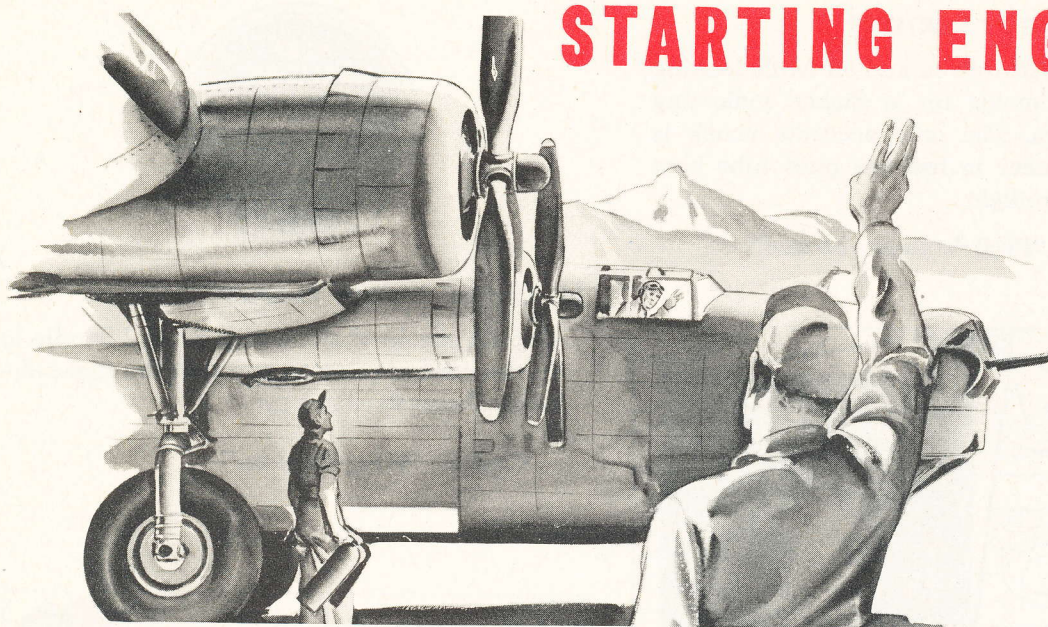

Step-by-step precision in starting engines is the mark of a top-notch military pilot. There is a **best** way to do everything. Learn and perfect the **best** starting procedure and it will help to eliminate errors. Use the **checklist procedure**.

It is the airplane commander's responsibility to see that engineer and ground crew understand the standardized precautions for starting engines. These require one man posted as fire guard at the engine being started and a second man in view of personnel in the cockpit to relay signals to the fire guard.

## Amplified Checklist

### 1. Copilot: Call "CLEAR!" Fire Guard Posted

Copilot and pilot stick their heads out of their windows to check personnel and shout, "Clear!" Copilot checks that a fire guard is posted and holds up three fingers to indicate that he will start No. 3 engine first.

**Copilot: "All clear and guard posted!"**

Start engines in sequence 3, 4, 2, 1, to keep guard from running through an outboard prop in case of fire and because the engine-driven hydraulic pump operates off No. 3 engine. When engines are energized exter-

nally, start in sequence 1, 2, 3, 4, to keep the ground-crew man safely clear of propellers.

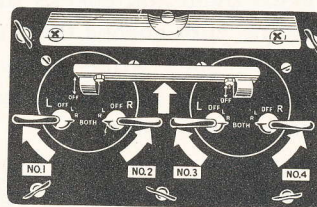

### 2. Copilot: "IGNITION SWITCHES?"

Copilot turns on the ignition switches for all 4 engines.

**Copilot: "Ignition switches all on!"**

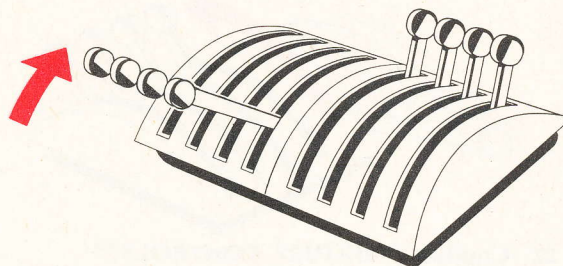

### 3. Copilot: "THROTTLES?"

Pilot moves all throttles to cracked position, approximately  $\frac{1}{3}$  open. This prevents excessive backfiring and overspeeding of engine on starting.

**Pilot: "Throttles cracked!"**



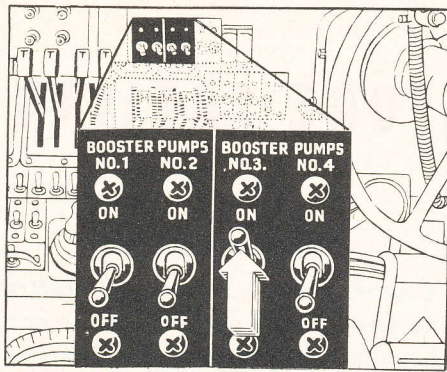

**4. Copilot: "BOOSTER PUMP?"**

Copilot turns the booster pump on for the engine to be started to supply fuel pressure for priming and notes pressure, usually about 8 lb.

**Copilot: "Booster pump on!"**

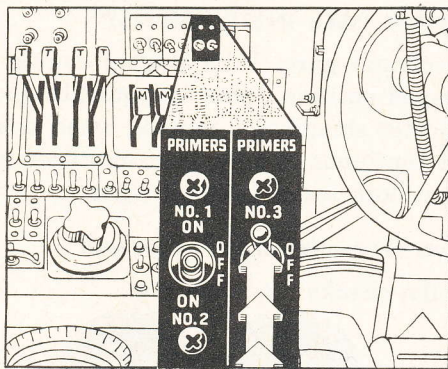

**Priming**

Engine may be primed when fuel pressure is above 4 lb. Copilot primes by pressing the primer switch for one second and then releasing it. The number of one-second shots will normally be not less than 3 nor more than 6 depending on the temperature of the engine and the outside air. This drives the fuel into the engine intake in spurts. Do the priming while you are energizing.

**Two Types of Starters**

Energizing time will vary with the 2 types of starters in use on B-24's. The old type requires 30 seconds. Switch is moved up to "START" for energizing and down to "MESH." Energizing stops when the switch is on "MESH." In the new-type starter there are separate

switches for energizing and meshing. Move first switch up to "ACCEL" to energize for 12 seconds and keep it there while you move the second switch to "MESH." Thus the energizing continues during the cranking or meshing. Some nameplates are marked "CRANK" instead of "MESH."

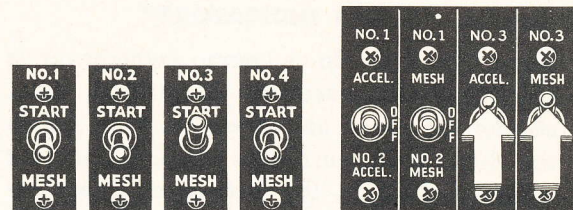

Old Type

New Type

**5. Copilot: "START ENGINES."**

- a. While priming with one hand, copilot energizes starter with the other hand for required number of seconds.
- b. Copilot meshes starter and holds it meshed until the engine is definitely started because the booster coil or induction vibrator is hooked up to the meshing switch. If the engine doesn't start immediately, use more priming.
- c. As soon as the engine fires, the pilot brings mixture control back to "AUTO-RICH" and leaves it there.
- d. Copilot turns the booster pump off.
- e. Copilot watches the oil pressure gage and calls out, "Oil pressure coming up," if it is. If oil pressure does not rise within 30 seconds, copilot puts mixture control in "IDLE CUT-OFF" and stops the engine. During the first 30 seconds of firing hold rpm as low as possible.

**Copilot: "No. 3 started."**

(Successive engines are started in the same manner.)

**Warm-Up**

Throughout the warm-up and other ground operations, when not actually taxiing, idle the engines at 1000 rpm. Warm-up should continue until the oil temperature indicators for all engines reach 40°C, minimum, and until cylinder-head temperatures reach 120°C.



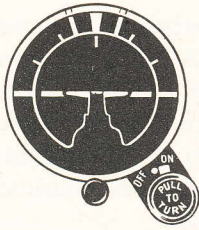

**6. Copilot: "FLIGHT INDICATOR?"**

When No. 2 or No. 1 engine (whichever is supplying the vacuum) is started, pilot checks the speed and precision with which the flight indicator rights itself. If righting action is sluggish, the instrument needs repair. (Note: Jack and Heintz Flight Indicators Model JH 6500 must be left caged until the engine has been running for 5 minutes to allow rotor to gain full speed. Then uncage and check to see that it does not spill.)

**If an Engine Stops**

If an engine stops, immediately put mixture control in "IDLE CUT-OFF" and repeat entire starting procedure. If the propeller starts turning when you re-energize, release the energizing switch and cut the ignition switch "OFF." Then have a crew member rock the propeller to disengage the starter dogs.

**If an Engine Is Flooded**

If an engine becomes flooded, put the mixture control in "IDLE CUT-OFF" and open throttle fully until excess gasoline is cleared out and the engine begins to fire. Then immediately retard the throttle to 1/3 open and move mixture control to "AUTO-RICH."

**If an Engine Won't Mesh**

If an engine won't mesh or crank, and you want manual meshing, notify the man in front of the airplane by raising a clenched fist and pulling sharply downward. He will use the same signal to notify the fire guard who will then pull the manual meshing handle. The mesh switch on the copilot's panel should be used when meshing manually, even though it is apparently not working, since it also completes the circuit to the booster coil or induction vibrator.

When all engines are started and warmed up, you are ready to begin the before-taxiing check.

**BEFORE TAXIING**

**Amplified Checklist**

Make a careful check before you start taxiing to make sure your engines, instruments, and radio are operating properly. All of the readings given below are maximum and minimum limits based on rpm of 1000.



**1. Copilot: "ALL INSTRUMENTS?"**

Directional gyro. Pilot pushes caging knob to caged position, spins and quickly uncages. Indicator should stop moving when uncaged. If it continues to spin, gyro requires repair. Try it both ways, left and right.

**Pilot: "Directional gyro checked!"**

Copilot checks the following:

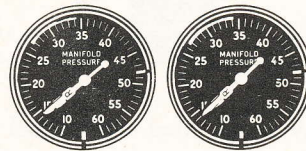

**a. Manifold Pressure.** Check for steady indication. Erratic reading indicates defective instrument.

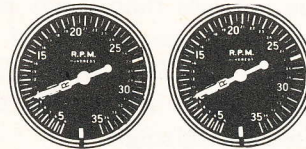

**b. Tachometer.** Check for steady indication at 1000 rpm.

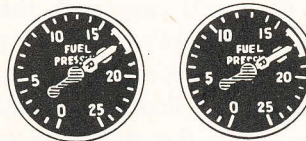

**c. Fuel Pressure.** Should read 16 to 18 lb.



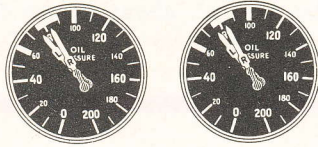

**d. Oil Pressure.** Should read 45 to 100 lb. Low reading may indicate oil shortage or pump failure.

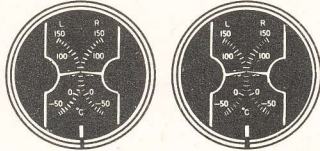

**e. Oil Temperature.** Limits are 40° to 100°C. Desired range is 60° to 75°C.

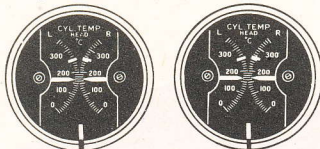

**f. Cylinder-Head Temperature.** Limits are 120° to 232°C for ground operation. Do not operate above 1000 rpm until head temperature is 120°C or more.

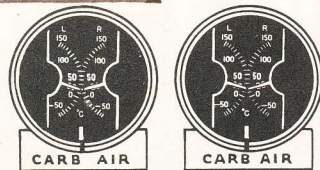

**g. Carburetor Air Temperature.** If there is high humidity, ice may form during ground operation if carburetor air temperature is below 15°C. Best operating limits are between 15°C and 35°C. Above 35°C there is likely to be detonation.



**h. Hydraulic Brake Accumulator Pressure.** Check inboard and outboard gages indicating between 975 to 1180 lb. **Don't start taxiing if either gage falls below 950 lb.**

For an additional check on the hydraulic system, put the flap control handle in the "UP"

position; if it kicks out, the free-flow system is operating properly.



**i. Gear Warning Light.** Should be lighted.

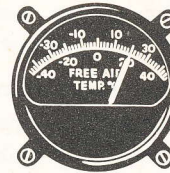

**j. Free Air Temperature.** Check against temperature you obtained in the weather office. You'll need this gage to anticipate icing conditions.

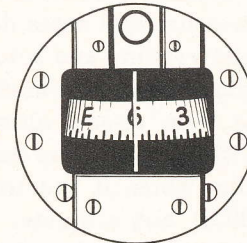

**k. Compass.** Check deviation card—in place and up to date.

Copilot: "All instruments checked!"

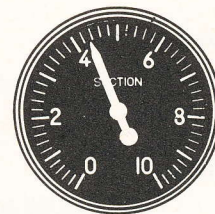

**2. Copilot: "VACUUM?"**

Engineer calls out No. 1 or No. 2 engine, (whichever is supplying vacuum). Pilot checks his gage and, if gage registers between 3.75 and 4.25, calls "Checked." Engineer turns the vacuum selector valve to the other engine and the procedure is repeated. Valve should be turned to No. 2 after the check is completed.

Pilot: "Vacuum checked on Nos. 1 and 2!"





Note: If the airplane is equipped with electronic turbo control, always keep the dial set at zero for taxiing.

**ALWAYS USE AUTO-RICH FOR ALL  
GROUND OPERATION**

## TAXIING

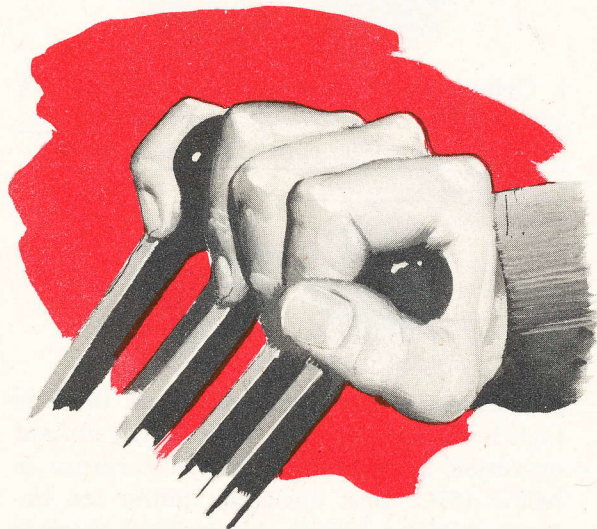

Nothing makes a pilot and his crew feel more foolish than a taxiing accident that does several thousand dollars worth of damage. Clumsy taxiing imposes severe strains on the nose gear, main gear, tires and other parts of the airplane, and negligence in taxiing will not be tolerated. Smooth, skillful taxiing technique is a must for 4-engine aircraft. When all checklist items through "Before Taxiing" are completed, and you have radio approval from the tower, you are ready to start taxiing. Check to make certain that your seat is well forward so that you are in a position for full rudder and brake control.

### 3. Copilot: "RADIO, ALTIMETER, TIME."

Copilot calls the tower for radio check, altimeter setting and correct time.

a. Radio check has three elements: (1) Frequency: on frequency, or one or more kilocycles low or high; (2) Readability, R . . . 1 to 5; (3) Signal strength, S . . . 1 to 5. Desired check is "On frequency, R5, S5."

Copilot: "Radio checked!"

b. Altimeter setting. Pilot sets altimeter at barometric pressure and notes difference between altimeter reading and actual field altitude. Maximum error permissible is 50 to 75 feet. Pilot then re-sets altimeter at actual field elevation and notes error in barometric reading. Thus, if the tower gives a reading of 29.20 but altimeter reads 29.25 when set at correct field elevation, .05 should be added to any barometric reading obtained during the flight. As a rule-of-thumb guide only, .01 difference in barometric reading equals 10 feet altitude.

Pilot: "Altimeter set."

c. Time. Copilot checks cockpit clock time against tower report.

Copilot: "Time checked."

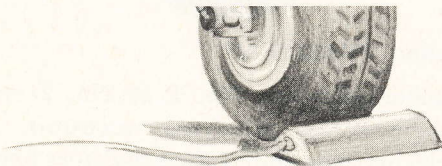

### 4. Copilot: "WHEEL CHOCKS?"

Pilot and copilot look out their windows to check chocks removed.

Pilot: "Wheel chock removed left!"

Copilot: "Wheel chock removed right!"



### Position of Feet

The position of your feet is important. Set your heels on the rudder pedals with your toes well up above the brake pedals. **Always keep your toes off the brake pedals when not using the brakes.** Only slight pressure will build up tremendous friction and heat. Save your brakes for emergencies when you'll need them!

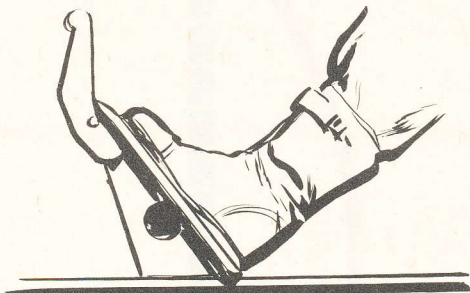

POSITION OF FEET WHEN USING RUDDER



POSITION OF FEET WHEN USING BRAKES

### Use of Rudder

When learning to taxi, hold rudders neutral because rudder control is ineffective except at excessive speeds. Also, when you are holding full rudder, right or left, it is difficult to use the brakes effectively. Ask your copilot to help hold rudders neutral and to check the neutral position as you taxi.

### Safety Observer

Post the engineer as observer with his head out the flight deck escape hatch to observe obstructions and signal "Clear left" and "Clear right." See that a ground-crew man is at each wingtip when taxiing in congested areas.

Be sure the nosewheel is straight. If turned more than 30°, it should be straightened with a bar. If you start taxiing with the nosewheel

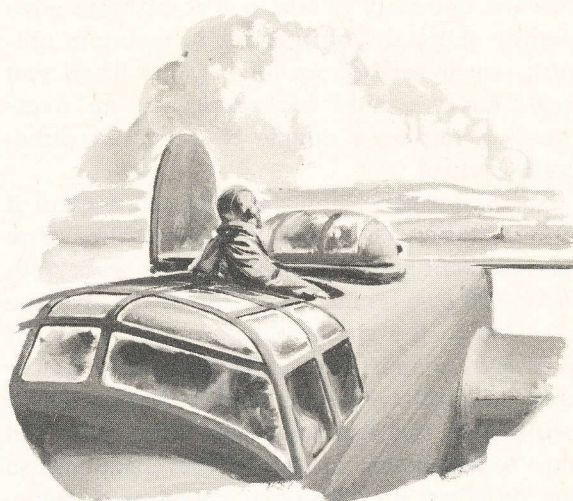

turned, allow the airplane to roll a short distance in the direction it is turned and it will tend to straighten itself out. **Don't force the airplane straight ahead with power and brake against a turned nosewheel.**

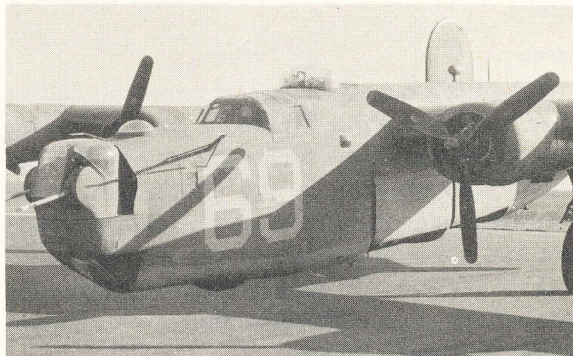

Results of Taxiing into Turned Nosewheel

### To Start Moving

Reduce power to idling, fully depress the brake pedals and release the parking brake handle. Then follow it up by hand to make sure it is released. Advance all throttles slowly and evenly until the airplane starts to roll. Don't use excessive power, and, as soon as the airplane is in motion, reduce the power.

### Use of Throttles

All 4 throttles are spring loaded, tending to hold higher rpm than idling. It is usually necessary to hold back pressure on the throttles to



## RESTRICTED

keep from overspeeding. Throttles tend to creep forward unevenly at low power settings. Frequently check the tachometer to maintain uniform power settings on all engines. Then you won't have to hold brakes against an overspeeding outboard engine to maintain directional control.

An expert at taxiing the B-24 can control it with throttles alone and without brakes. You can maintain speed equal to a brisk walk with 700 to 800 rpm on hard surfaces. If the airplane is easing to the right, add power to the right outboard engine but don't hold this power until the airplane swings back in line or it will swing past the desired point. Then you will have to add power on the left outboard and so on, building up excessive speed and S-ing. Develop an expert throttle touch.

The best way to hold throttles is palm down with the throttle knobs against the padded part of the palm, third finger-joints on top of throttles and fingers curled over them. The object is to be able to control any throttle separately.

### Turns

The B-24 is a big airplane. Get a mental picture of its radius of turn. The main gear at the inside of the turn is the turning point and it is far aft of your position in the pilot's seat. Your natural tendency is to turn too soon because you feel yourself going past the turning point.

On a left turn the pilot should watch the inside wheel; on a right turn the copilot should watch the inside wheel.

Note: You are controlling 20 to 30 tons of airplane and there is a delay between the application of power and the reaction of the airplane. Think and act ahead of the airplane and anticipate its delayed reactions.

### How to Turn

If the airplane is rolling at proper taxiing speed, no brakes are necessary to start the turn. Smoothly apply power to the outside engine to start the turn and remove power as soon as the airplane responds. Don't use excessive power. It is better to use too little throttle and then add more than to start too fast a turn and have to correct with the opposite outboard engine.

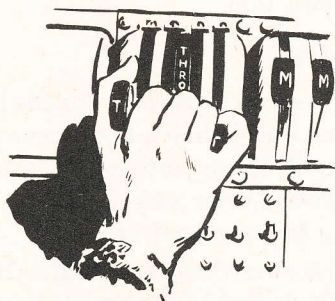
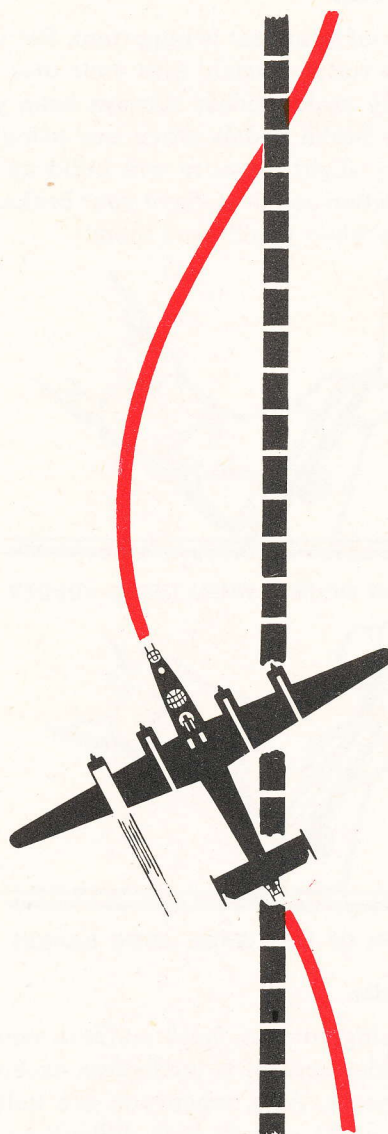



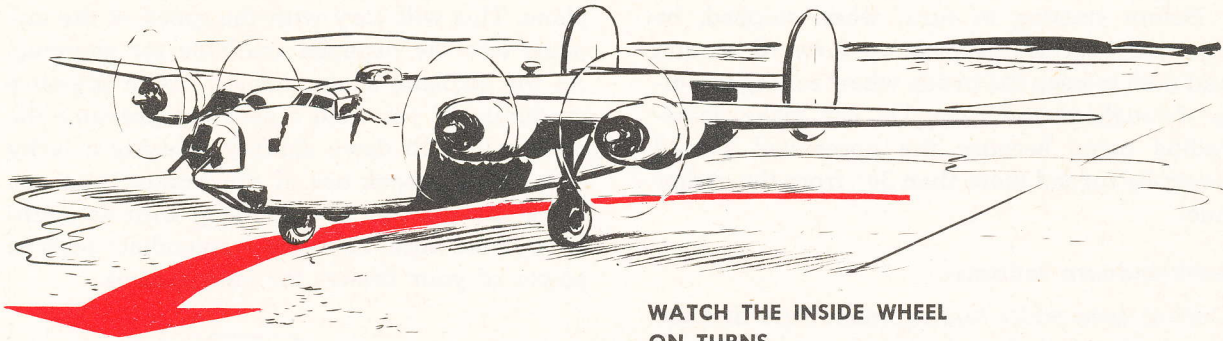

**WATCH THE INSIDE WHEEL  
ON TURNS**

This produces a seesawing action. If you build up excessive speed or turning action, throttle back, get control with the brakes and start over. Don't take a chance on dropping your airplane in a mudhole.

**Don't Pivot**

The most common error in turning is to pivot the airplane sharply. Don't brake the inside wheel to a stop and then pivot around it. This grinds the tire against the ground or cement, twisting the ply and weakening the tire.

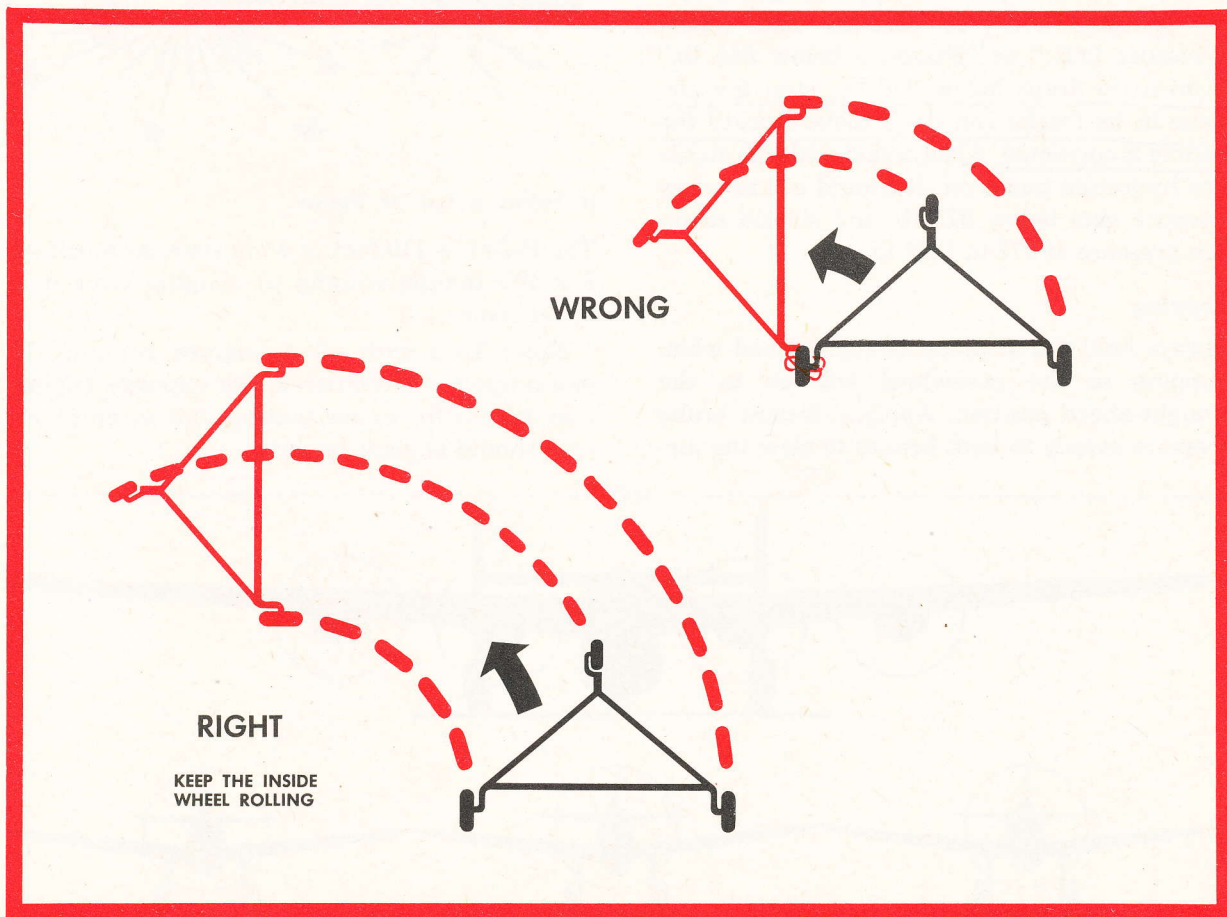



## RESTRICTED

Before starting to turn, when stopped, be especially careful to pick up forward motion and then to keep the inside wheel rolling steadily throughout the turn. Do not make short-radius turns because the nosewheel should never be turned more than 30° from the center line.

### Bank-and-turn Indicator

During turns while taxiing, make sure that the turn indicator is functioning properly, returns to neutral when the turn is completed and is not sluggish.

### Use of Brakes

Brakes should be applied with a smooth, steady build-up of toe pressure. Sudden application of the brakes slams the nose down, puts heavy strain on the nose and main gear assemblies, and may damage the brake expander tubes.

Require your copilot to check the accumulator pressure every 30 seconds and report "Pressure O.K." or "Pressure below 800 lb." If pressure drops below 800 lb., stop the airplane in its tracks and don't move it until the trouble is corrected. Always taxi with the auxiliary hydraulic pump on. It should cut in when pressure gets below 975 lb. and should maintain pressure at 975 to 1180 lb.

### Stopping

Always hold the airplane straight ahead when stopping so the nosewheel will be in the straight-ahead position. Apply sufficient brake pressure evenly to both brakes to slow the air-

plane. This will vary with the speed of the airplane and the distance available for stopping. As the airplane slows, release brake pressure gradually. If you hold a constant pressure the nose will snub down sharply, causing a jerky stop. With proper use of the brakes, you can bring the airplane to a full stop with no snubbing of the nose. Save the tremendous reserve power of your brakes for emergencies.

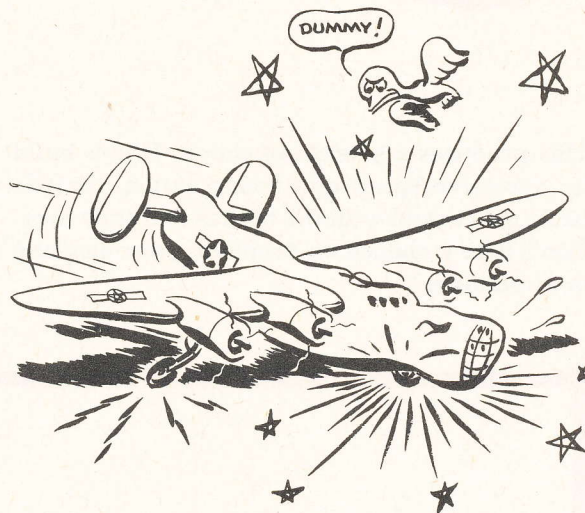

### It Takes a Lot of Room

The B-24 has 110 feet of wing span, as much as 3 P-40's taxiing wingtip to wingtip. Give it a lot of room.

Note: Taxi with all 4 engines running. If one propeller is feathered, the opposite engine may be cut for easier taxiing—but in no other case should engines be cut.

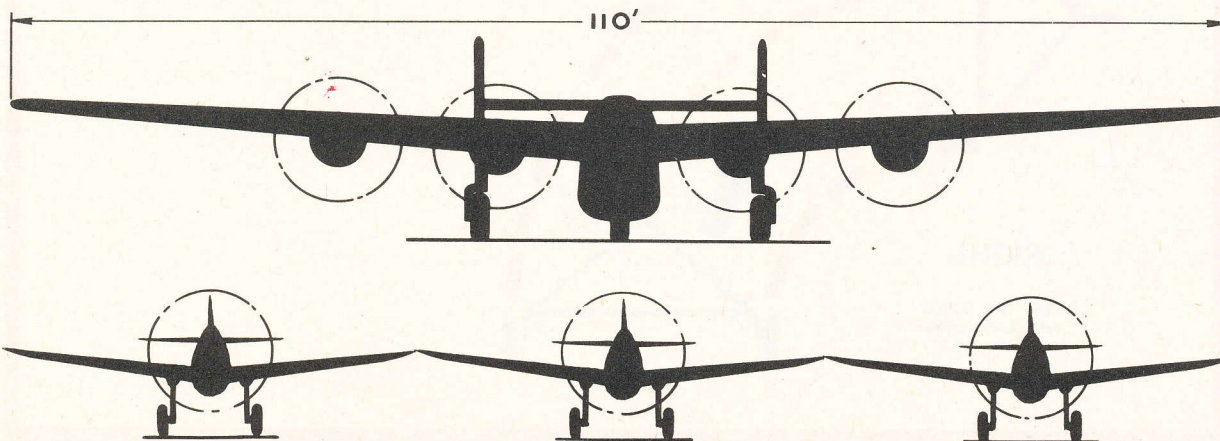



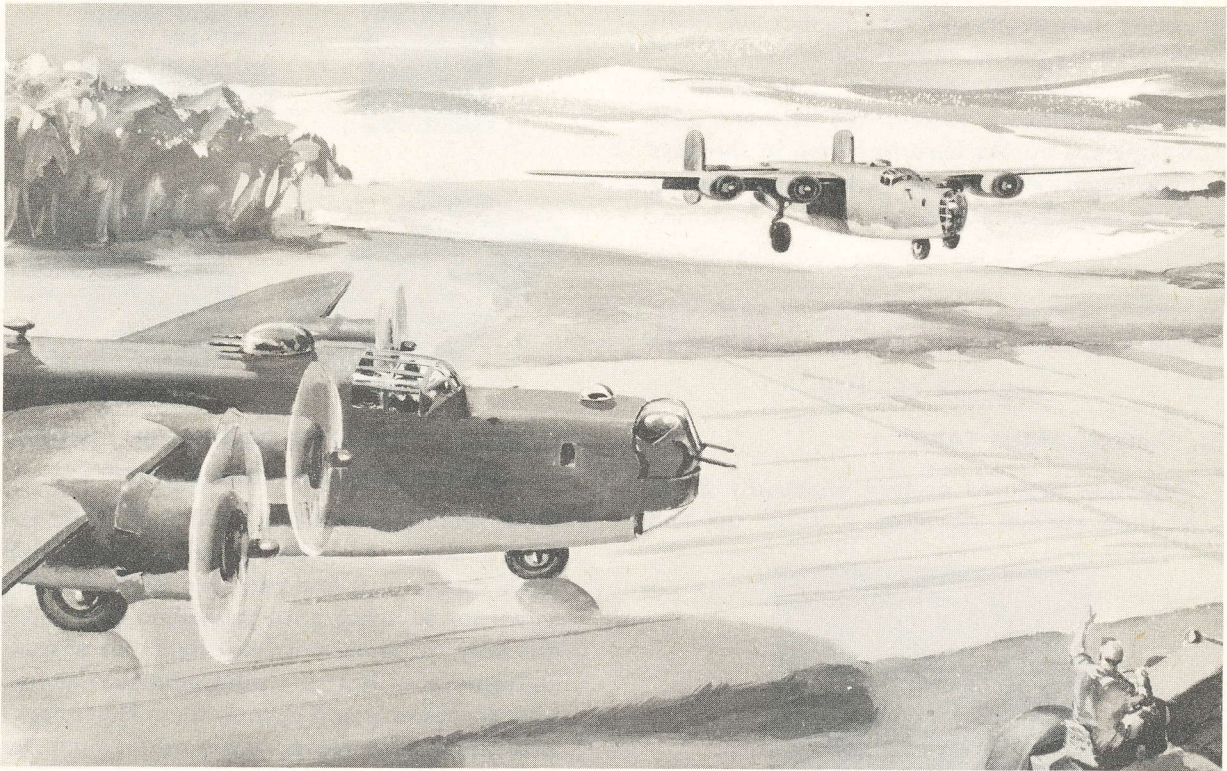

## ENGINE RUN-UP BEFORE TAKEOFF

Every airplane has its own peculiarities and its own personality. This is especially true in time of war when series, equipment, and number of hours in the air vary widely from plane to plane. The engine run-up before takeoff is your opportunity to feel out your airplane, judge its condition and note its peculiarities.

The B-24 blows a big breeze. Don't run up on the line unless local rules require it. Taxi to a point well clear of the takeoff runway (from which you can observe incoming traffic), and stop with the nosewheel lined up straight ahead. Fully depress the brake pedals, lift the parking brake handle to the locked position (do not force it), and release the brake pedals. This should lock the parking brakes. Set all throttles at 1000 rpm and faithfully follow checklist procedures during run-up.

RESTRICTED

### Crew Positions For Takeoff and Landing

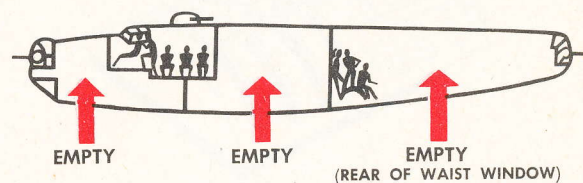

Be sure your crew know their positions for takeoff. No one should be in the nose compartment because of the danger of injury if the nosewheel should collapse. No one should be aft of the waist gunner positions because this materially changes the center of gravity and causes tail heaviness. No one should be in the bomb bay.



## RESTRICTED

Usual positions: Pilot, copilot, engineer, radio operator, navigator and bombardier on flight deck; gunners just aft of bulkhead No. 6.

Crew should not shift from their positions until the airplane is clear of the field and gear and flaps are up. **At least one man in the rear compartment will be on interphone during taxiing, takeoffs and landings.**

# BEFORE-TAKEOFF CHECK

## Amplified Checklist

### \*1. Copilot: "TRIM TABS?"

Pilot sets these as desired (normally 2° to 3° right rudder, elevators 1° to 2° up, and

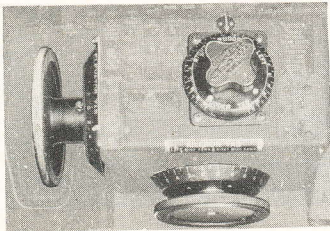

ailerons at 0°. The right rudder trim corrects for torque during takeoff.

Pilot: "Trimmed for takeoff!"

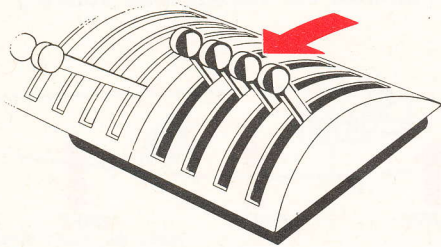

### \*2. Copilot: "MIXTURES?"

Copilot checks to see that all are in "AUTO-RICH." **Danger:** Don't take off in "AUTO-LEAN" because there is danger of detonation or engine failure.

Copilot: "Mixtures in auto-rich!"

\*ITEMS WITH ASTERISK FOR SUBSEQUENT TAKEOFF.

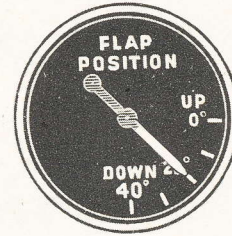
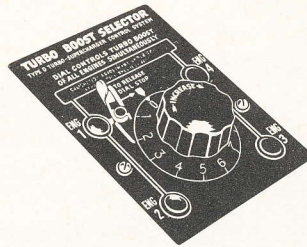

### 3. Copilot: "EXERCISE PROPELLERS, TURBO-SUPERCHARGERS AND FLAPS!"

Pilot sets all throttles at 1500 rpm. Then copilot changes propeller governors from full high rpm to full low rpm and back, holding governor switches until propellers change all the way (all governor limit lights on at each extreme position); the pilot advances superchargers slowly and retards them slowly several times. This moves warm oil through the propeller dome assembly and to the supercharger regulators, assures adequate lubrication of the turbo wheel shaft bearings, and clears the balance lines for proper waste gate operation. At the same time the copilot runs the flaps all the way down and back up, checking against the flap indicator. Then the pilot retards throttles to 1000 rpm.

Pilot: "Turbo-superchargers exercised!"

Copilot: "Propellers and flaps exercised!"

## IT IS NOT NECESSARY TO EXERCISE ELECTRONIC SUPERCHARGERS

### \*4. Copilot: "PROPELLERS?"

Copilot double checks to see that propellers are left in high rpm because governor limit lights also come on when propellers are in low rpm.

Copilot: "Propellers in high rpm!"

RESTRICTED



### 5. Copilot: "RUN UP ENGINES!"

Run up engines in the following order: 4, 3, 2, 1. Pilot advances No. 4 throttle until the propellers reach 2000 rpm and copilot checks all engine instruments. Copilot checks magnetos at signal from the pilot. Technique: (a) Check tachometer for steady reading on "BOTH." (b) Turn ignition switch to "LEFT MAGNETO" and hold 3 to 5 seconds. Note any drop in rpm (maximum allowable drop is 100 rpm). (c) Switch back to "BOTH" and hold until rpm is steady. (d) Switch to "RIGHT MAGNETO" and check same as right. (e) Switch back to "BOTH" and leave there.

During magneto check pilot should watch engine nacelle for excessive vibration.

**Note:** Where takeoffs are being made frequently, clearing out the engines may be substituted for the full run-up procedure on subsequent checks. If takeoffs are infrequent, make a complete run-up each time. In either case, make the magneto check for **all** subsequent takeoffs.

**Copilot: "Magnetos checked!"**

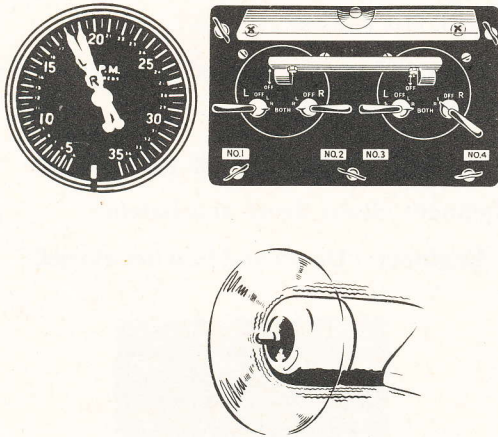

## Double Check

**DON'T INADVERTENTLY LEAVE THE IGNITION SWITCH ON LEFT OR RIGHT MAGNETOS.**

### Run-up Procedure With Electronic Turbo Control

When using the electronic turbo control, set the propeller governors in high rpm, and check the manifold pressure on each engine sepa-

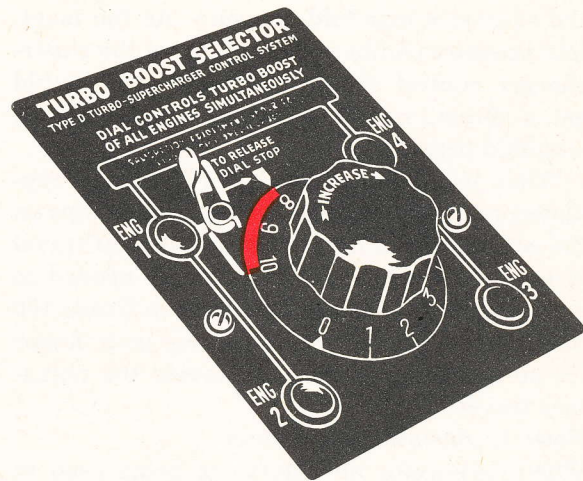

rately by advancing throttle to full open position. Then turn dial of turbo boost selector clockwise to the desired position ("8" with Grade 100 fuel). If the manifold pressure on any engine fails to come up to within 1" of takeoff pressure, with full high rpm, turn dial to zero and check engine rpm and manifold pressure without turbo boost. This will show whether the low manifold pressure is caused by faulty engine operation or by insufficient turbo boost. Also check the voltage with generators on. If batteries are low, leave the generator of the engine you are checking on during run-up to insure proper turbo operation.

After checking an engine, return the dial to zero before retarding the throttle. After you have checked all engines, set the dial to desired position for takeoff ("8" with Grade 100).

**Caution:** When using electronic supercharger control, always be sure generators are on and operating for takeoff.

**Pilot: "NO. 4 RUN-UP COMPLETED!"**

(Repeat the run-up operation for engines 3, 2, and 1.)

### Run-up With Oil Regulated Turbo Control

Pilot advances throttle fully open, holding it there with his right hand while he advances the supercharger control with his left hand until manifold pressure starts to increase. Precaution: This is the most sensitive point in supercharger regulation. Hesitate briefly to allow the turbo surge to balance out and to avoid ini-



tial excessive manifold pressure. As the manifold pressure climbs and stops, move the supercharger control slowly open and you should get a direct, smooth increase to the desired manifold pressure.

When using Grade 91 fuel with the oil regulated turbo control, the spring-loaded stops on the control levers do not allow sufficient travel to give the extra manifold pressure needed in an emergency. (This is in contrast to Grade 100 fuel.) To be on the safe side, use your finger for an additional spacer to provide the necessary travel.

**Note: Carburetor Air Filters**

When carburetor air filters are being used to overcome dust conditions, air normally taken in through the air scoop in the engine cowl is blocked off and air is taken through the filter, at the back of the nacelle. Friction and the elimination of ram pressure lowers the pressure of filtered air going to the superchargers. When not using filters, set superchargers 1.5" Hg. below desired manifold pressure to allow for intake ram as speed increases during takeoff. When using the filter, use desired takeoff setting with no allowance for ram.

The turbo wheels have to turn faster to offset the loss of pressure through the filters. Turn the filters off as soon as you are out of the dust area (never leave them on above 12,000 feet) because there is a possibility of exceeding turbo wheel speed limits.

**\*6. Copilot: "LOCK SUPERCHARGERS!"**

Pilot sets friction lock so that levers may be readily moved but will not creep back from vibration. Remember that the throttle and supercharger locks are in reality friction brakes and should be treated as such. Friction lock applies to oil regulated turbo control only.

**Pilot: "Superchargers set and locked!"**

**\*7. Copilot: "GYROS?"**

Pilot makes a final check, noting any precession since taxiing from the line, and re-sets for takeoff.

**Pilot: "Gyros uncaged and set!"**

**\*ITEMS WITH ASTERISK FOR SUBSEQUENT TAKEOFF.**

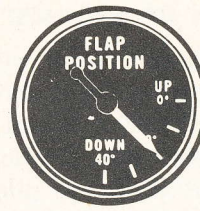

**\*8. Copilot: "WING FLAPS?"**

Copilot runs wing flaps down to 20° position.

**Copilot: "Wing flaps 20°!"**

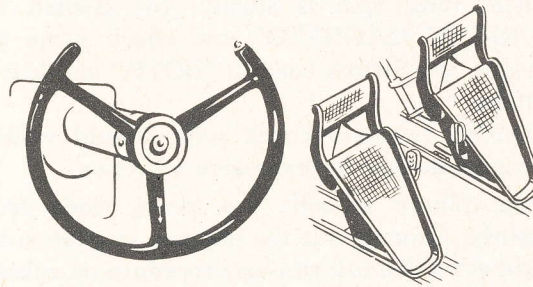

**\*9. Copilot: "FLIGHT CONTROLS?"**

To check full travel and freedom of movement, pilot moves controls to full forward and right on the wheel, right rudder; then moves them to full back and left on the wheel, left rudder.

**Pilot: "Controls checked for full travel and free movement!"**

**\*10. Copilot: "DOORS AND HATCHES?"**

Engineer closes doors and hatches.

**Engineer: "Doors and hatches closed!"**

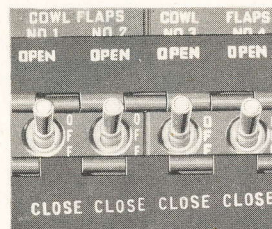

**\*11. Copilot: "COWL FLAPS?"**

Copilot closes them to trail position.

**Copilot: "Cowl flaps at trail!"**



See that cowl flaps are all closed the same. If open too much, they will cause loss of lift, increased drag, and severe flutter of the tail surfaces. It is better to have cowl flaps completely closed than too far open. Engines may idle at 1000 rpm for a reasonable time with cowl flaps closed and not heat up. Don't take off if a head temperature is less than 150°C or more than 232°C. Desired level is 205°C. Note: Each degree of cowl flap opening produces .8 mph loss of speed.

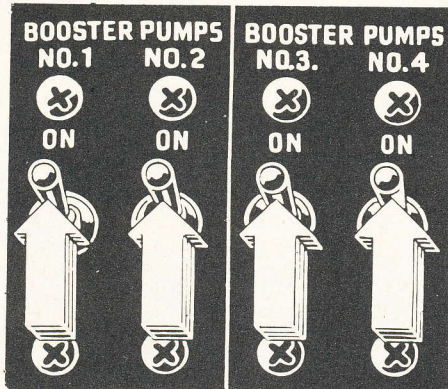

**\*12. Copilot: "BOOSTER PUMPS?"**

Copilot turns all fuel booster pumps on. This builds up a differential of 8 lb. in the rubber lines to the engine to keep them from collapsing. It is also a safety precaution in case of engine pump failure.

**Copilot: "Booster pumps on!"**

**\*13. Copilot: "AUXILIARY HYDRAULIC PUMP AND POWER UNIT?"**

Engineer shuts these off to eliminate a fire hazard on takeoff. The auxiliary hydraulic pump is the only open-brush motor in the bomb bay and the cooling fan tends to draw any gas fumes into the motor.

**Engineer: "Auxiliary hydraulic pump and power unit off!"**

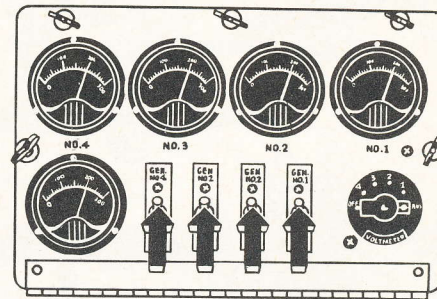

**\*14. Copilot: "GENERATORS?"**

Engineer responds "Standing by" and switches on all 4 generators while takeoff power is being applied. He stands by the panel to turn off any generator indicating excessive load. If this is necessary, he waits until the other generators show signs of sharing the load before returning the off generator to the line, and switches it off again if it fails to equalize.

**Engineer: "Generators on!"**