

EQUIPMENT AND SYSTEMS

Systems Described in This Section

HYDRAULIC SYSTEM

ELECTRICAL SYSTEM

OIL SYSTEM

FUEL SYSTEM

HEATING SYSTEM

ANTI-ICERS, DE-ICERS AND DEFROSTERS

OXYGEN SYSTEM

VENTILATING SYSTEM

AUTOMATIC PILOT, PDI AND FORMATION STICK

GYRO FLUX GATE COMPASS

RADIO EQUIPMENT

Know your airplane! That's the only way you can qualify yourself to fly it with maximum effectiveness. Which instruments are autosyn? Where are the fuse boxes? How do you transfer fuel in your particular airplane? What is the layout of the oil system? This is just a start on the questions every pilot will want to be able to answer in detail to be prepared to meet emergencies that can jeopardize his airplane and his crew.

Here's what a B-24 combat pilot says:

"What you know about the airplane will determine whether you can bring one back that is badly shot up. If we had it to do all over, we would dig in twice as hard to know that airplane from one end to the other. You may be able to get by the minor things, such as engine trouble, but when you run into damage

to systems from AA and fighter fire, you must know a lot about the airplane to fly it home."

The following sections give brief, basic information about the airplane. Don't be satisfied with what you learn here. Query your instructor, your engineer, read the P.I.F., dig into technical orders and study the airplane from nose to tail repeatedly.



HYDRAULIC SYSTEMS

The principle of hydraulic power is the actuating of a piston within a cylinder, usually double acting. Pressure may be applied to either side of the piston for power in either direction, by means of hydraulic pressure supplied by a power pump. Oils and liquids are not compressible; therefore, the power delivery of any hydraulic system is directly proportional to the applied pressure.

Hydraulic Equipment in the B-24

1. The main hydraulic system operates the tricycle landing gear (including retractable tailskid), wing flaps, bomb bay doors, power brake, Sperry automatic pilot (when supplied), and the nose turret.

2. The hydraulic shock absorber units cushion the landing impact and taxiing loads on the tricycle landing gear.

3. The hydraulic nosewheel shimmy damper unit dampens the tendency of the nosewheel to shimmy from side to side.

4. The hydraulic tail and nose turret units control the rotation of the turrets, the elevation of the guns, and the charging mechanisms.

Main Hydraulic System

The hydraulic system consists of a main open center system and a secondary accumulator system. It uses hydraulic fluid of specification AN-VV-O-366a. The capacity of the entire system is approximately 18 U.S. gallons, while the reservoir capacity is 3.8 gallons from bottom of reservoir to center suction outlet, plus 3 gallons from center suction outlet to filler neck.

1. In the open center system the fluid circulates freely in a completely closed circuit when no hydraulic mechanisms other than the engine-driven pump are operating. The open cen-

ter system operates the bomb bay doors, wing flaps and landing gear.

2. In the accumulator system fluid is under constant high pressure built up in two accumulators. This system is the sole source of pressure for operation of brakes, nose turret, Sperry

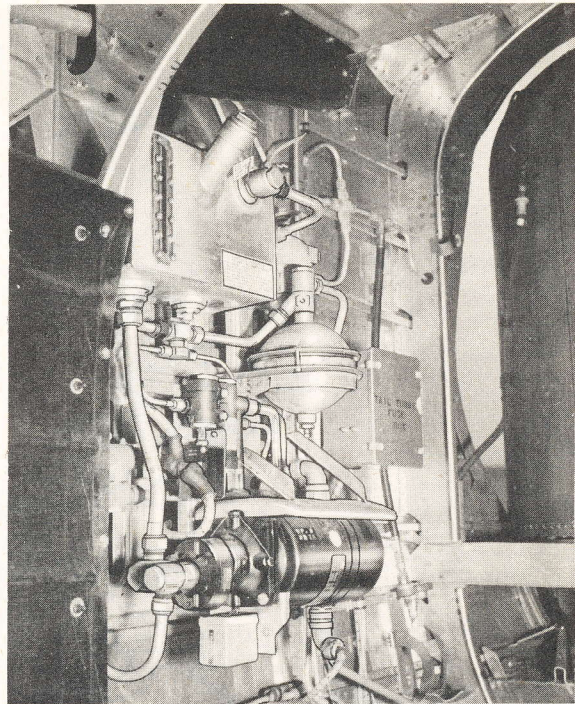

TAIL TURRET HYDRAULIC SYSTEM

automatic pilot (when provided), and auxiliary and emergency (hydraulic) control of bomb bay doors.

Hydraulic Pumps

1. Engine-Driven Hydraulic Pump

The main, or Vickers positive displacement, pump (19), driven by No. 3 engine, supplies pressure for the main system. The pump normally floats on the line. When the flow is diverted by closing any selector valve to operate an hydraulic mechanism, pressure builds up to an amount required to operate the mechanism.

The pump's secondary function is to maintain pressure in the accumulator system. An automatic unloading valve (9) in the engine-

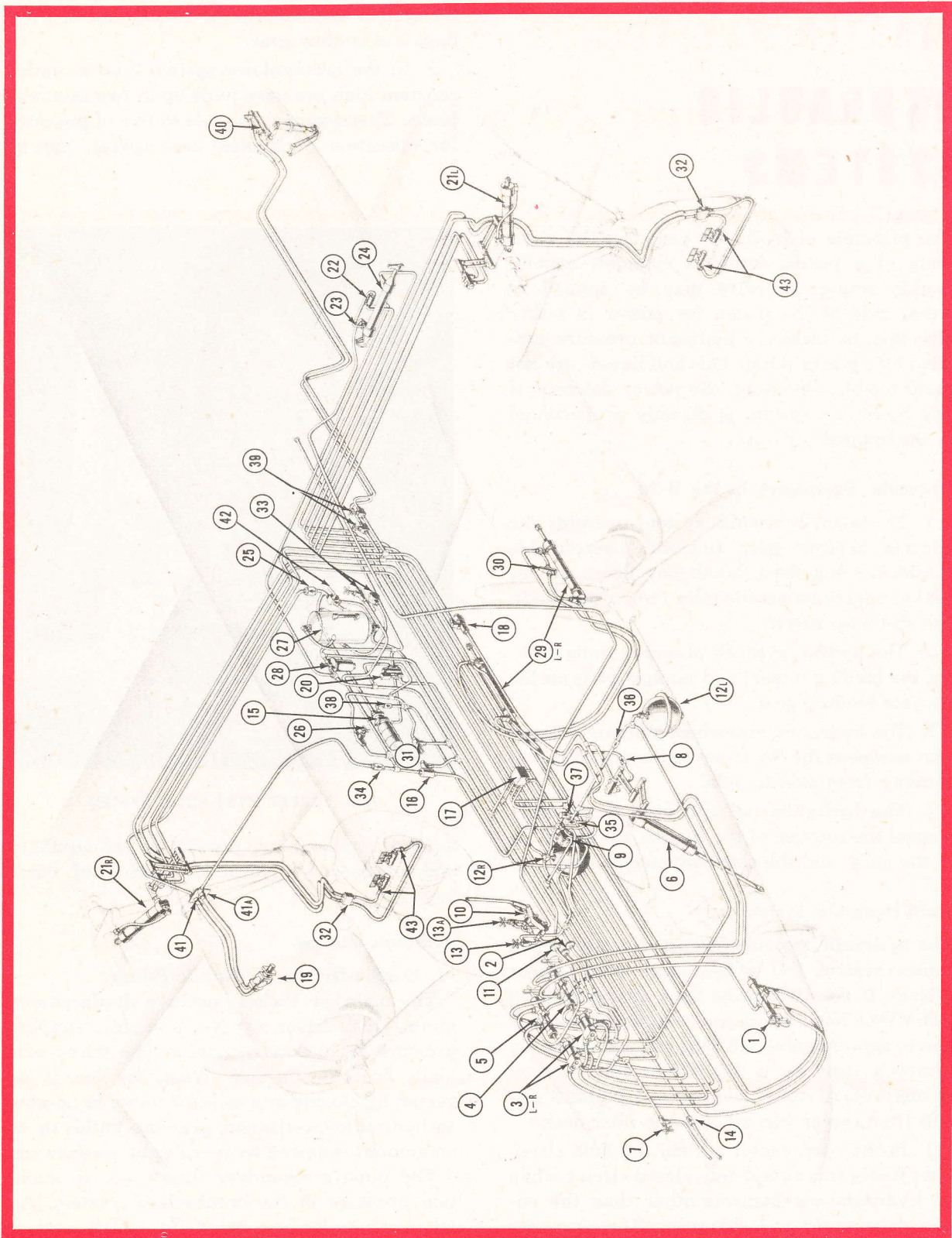

MASTER KEY LIST OF HYDRAULIC UNITS

FOR HYDRAULIC SYSTEM DIAGRAMS

- 
1. Bomb Bay Door Selector Valve
 2. Brake Pressure Gages
 3. (L & R) Brake Control Valves
 4. Landing Gear Selector Valve
 5. Flap Selector Valve
 6. Nosewheel Actuating Cylinder
 7. Nose Turret Shut-Off Valve
 8. Nosewheel Restrictor
 9. Unloading Valve
 10. Hand Pump
 11. Hydraulic System Pressure Gage
 12. (L & R) Accumulators
 13. Hand Pump System Valve
 - 13A Hand Pump Flap Valve
 14. Nose Turret Check Valve
 15. Auxiliary Electric Pump
 16. Relief Valve
 17. Bomb Door Emergency and Utility Control Valve
 18. Main Landing Gear Restrictor
 19. Engine Driven Pump
 20. Pressure Switch
 21. (L & R) Main Landing Gear Actuating Cylinder
 22. Relief Valve
 23. Shuttle Valve
 24. Flap Actuating Cylinder
 25. Suction Line Check Valve
 26. Auxiliary Star Valve
 27. Fluid Reservoir
 28. Filter
 29. (L & R) Bomb Bay Doors Actuating Cylinder
 30. Bomb Door Cylinder Relief Valve
 31. Auxiliary System Relief Valve
 32. (L & R) Brake Bleeder Valve
 33. Test Stand Connections
 34. Check Valve
 35. Check Valve
 36. Left Accumulator Check Valve (Spring Removed)
 37. Right Accumulator Check Valve
 38. Auxiliary Pump Check Valve
 39. Tail Bumper Shut-Off Valves
 40. Tail Bumper Actuating Cylinder
 41. Automatic Seal Coupling
 - 41A Automatic Seal Coupling
 42. Emergency Suction Valve
 43. Brake Disconnect Coupling
-

RESTRICTED

driven pump pressure line regulates this operation. When the accumulators are charging, all the fluid flow in the open center line is diverted by the unloading valve to the accumulators.

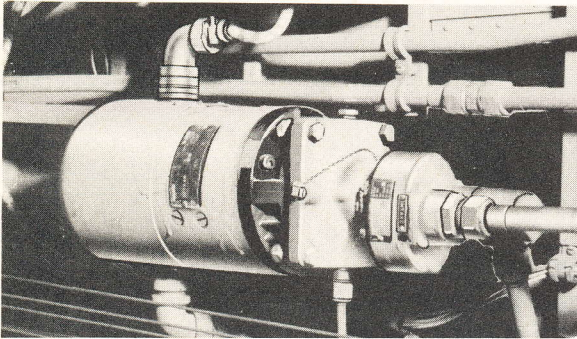

2. Auxiliary Hydraulic Pump

An electrically driven gear-type pump (15), located on the right side of the fuselage in the forward bomb bay, maintains accumulator pressure when the engine driven pump is not operating. An automatic pressure switch (20) and a manual master switch control the pump motor.

When the engine-driven pump fails, an emergency hydraulic (star) valve (26) just above and forward of the auxiliary hydraulic pump may be turned on to connect the pump into the main system.

The auxiliary hydraulic pump receives power from the right hand power bus—normal load 95 to 98 amperes—and has 2 functions:

a. Accumulator charging function—The auxiliary hydraulic pump is turned on before taxiing and off before takeoff, and turned on again just before landing. When turned on (emergency hydraulic star valve (26) closed) this pump maintains the pressure in both accumulators (12L) and (12R) between the limits 975 lb. sq. in. and 1180 lb. sq. in. while the engine pump supplies fluid only to the open center system selector valves. This is made possible by the relative pressure adjustments of unloading valve (9) and pressure switch (20).

b. Emergency function—In the event of failure of engine-driven pump (19) or engine No. 3 to which it is attached, the auxiliary hydraulic pump is turned on and interconnected to the

open center pressure line by opening emergency hydraulic (star) valve (26). Then the auxiliary hydraulic pump performs exactly the functions of the engine driven pump.

3. Hydraulic Hand Pump

The hydraulic hand pump (10) is located outboard of the copilot's seat. This pump delivers pressure to the line and can be used for operation of the entire hydraulic system by pumping fluid into the open center line through forward valve (13) on hand pump; or it can be used independently for lowering of the wing flaps by pumping fluid through aft valve (13A) to the flap cylinder.

Fluid for the hand pump (10), which is not part of the open center system, is drawn from the bottom of the reservoir through a separate line. The hand pump is used only for emergency operation.

Reserve Fluid—In the event of low fluid level in the reservoir (27) the engine-driven pump and the electrically driven pump may be connected to the bottom of the reservoir by closing the suction valve (42) provided in the reservoir outlet. This should be done only after steps have been taken to insure that no further loss of fluid can take place, or the reserve supply will be wasted through the same outlet.

Caution: The landing gear, bomb bay doors, and flaps retracting mechanisms cannot be operated simultaneously.

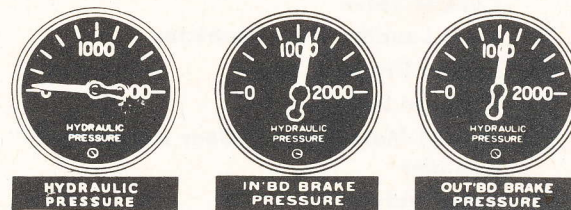

Operating Pressures

The main system pressure gage on the instrument panel should indicate approximately 50 lb. with no controls operating. With any system being used, this pressure should rise to between 100 and 1100 lb.

The wing flaps should be operated before flight to allow the pilot to check the system and the operating pressures built up at the gage. The brake pressure gage should always show a pressure of approximately 850 to 1180 lb. sq. in.

PRESSURE SETTINGS

Engine pump relief valve	1250 lb. sq. in.
Auxiliary electric pump relief valve	1250 lb. sq. in.
Bomb doors open relief valve	750 lb. sq. in.
Wing flaps down relief valve	500 lb. sq. in.
Auxiliary pump pressure switch	975-1180 lb. sq. in.
Accumulator unloading valve	850-1050 lb. sq. in.

SELECTOR VALVE RELIEF

Landing gear Up	1100 lb. sq. in.	Down	850 lb. sq. in.
Wing flaps Up	750 lb. sq. in.	Down	450 lb. sq. in.
Bomb bay doors Open	600 lb. sq. in.	Close	1000 lb. sq. in.

LANDING GEAR AND TAIL BUMPER HYDRAULIC CONTROL

The landing gear (2 main wheels, nosewheel) and the tail bumper gear are operated simultaneously under hydraulic control. The main control (4) for extending and retracting the gear is located on the left side of the pilot's pedestal. Movement of the operating lever is restrained by an electric solenoid, which is controlled by 2 switches in series. The operating switch is a push button in the operating handle itself; the other, a safety switch, is located on the left landing gear fairing. Extension of the landing gear strut on takeoff closes the safety switch and allows the circuit to be completed by pressing the operating switch button on the valve operating lever. The locking solenoid is located back of the instrument panel, and restrains the lever from "UP" position only.

Movement of selector valve (4) to the "UP" position applies hydraulic pressure simultaneously to the side gear restrictor (18) and to the nosewheel actuating cylinder (6). The side gear restrictor restricts the flow of fluid to the main landing gear until the pressure reaches 800 lb. sq. in. This pressure is sufficient to house the

nose gear. When pressure exceeds 800 lb. sq. in. the restrictor opens and allows fluid to go to the side gear cylinders.

On the lowering operation, pressure is applied to all 3 gear cylinders simultaneously. In case of insufficient pressure in the hydraulic system, the hand pump may be used.

In case of complete failure of the hydraulic system, the tricycle landing gear may be lowered manually. No means of manual control is provided for the tail bumper.

Main Landing Gear

Each main landing gear mechanism, operated by the main retracting cylinders through overrides, is equipped with 2 latches.

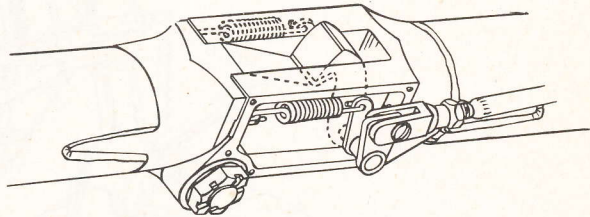

Down-Latch on Drag Strut Knuckle

When the main gear is fully extended, a spring-loaded latch on the side brace knee holds the side brace rigid and locks the gear in place.

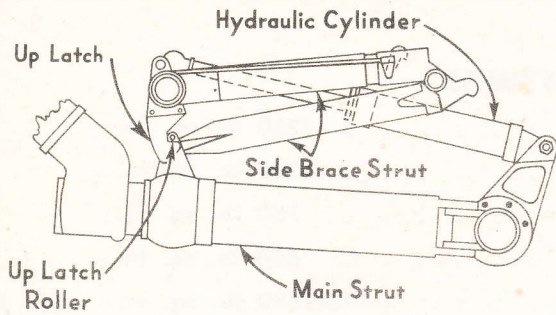

Another latch, on the side brace pivot in the wing, locks the gear in the retracted position.

The main gear down-latch is painted yellow and can be seen for down-latch check from the side window. It cannot be seen if flaps are lowered.

Nosewheel Gear

The nosewheel retracts into the nose of the fuselage under the pilot's floor. The nosewheel doors are mechanically connected to the gear mechanism so that they open automatically before the gear is extended and close after the gear is retracted.

The nosewheel is designed to turn 45° either side of the center line for free ground maneuverability but should never be turned more

than 30°. A hydraulic shimmy damper tends to restrain any oscillation of the gear about its vertical axis. An internal centering cam in the oleo returns the wheel to its straight-ahead position when the oleo is fully extended. A single latch on the drag link, actuated by the hydraulic jack over-ride, locks the nosewheel gear in both the retracted and extended positions.

Tailskid and Tail Bumper Gear

A retractable tailskid and bumper is installed on aircraft beginning with Serial No. 41-23640. It may be used within certain limits on tail-low landings. Do not land skid first.

The tail bumper protects the bottom of the fuselage in case the airplane should accidentally tilt back.

Warning Signal Light

A green light on pilot's instrument panel is lighted whenever the landing gear is down and locked.

Further warning that the gear has not been extended is given by an electric horn (on some aircraft) connected to the throttle controls. When the throttles are moved backward to approximately 3/4 closed, and all landing wheels are not extended and locked, the horn will blow

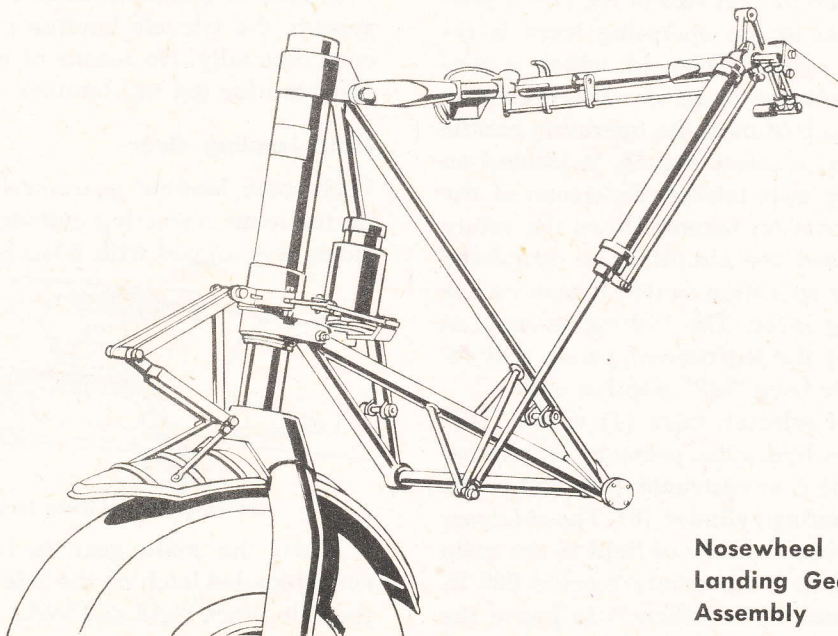

**Nosewheel
Landing Gear
Assembly**

until the gear has been extended and locked or until the throttles are opened to higher engine speed. The horn may be silenced by pressing the pilot's interruption switch on the pilot's pedestal. The horn will then remain silent until the throttles are moved again. This re-sets the horn relay so that another closing of the throttles would again actuate the horn. The horn interruption switch is provided in the event it is necessary to continue flight with one or more engines throttled.

The green light is wired through switches on all 3 landing gear units. On aircraft equipped with bottom turrets, this warning is also given when the turret has not been fully retracted and when the guns have not been completely housed.

Note: On recent aircraft, there is a push-to-test button for the warning light. This button tests only the operation of the light itself; it is **not a check on whether the gear is down and locked**. The green light should go on when you push the button, even if the gear is up. If it doesn't go on, the bulb may be burned out. If you lower the gear and the light does not indicate down and locked, don't assume that the gear is down and locked if the light goes on when you push the test button.

WING FLAP HYDRAULIC CONTROL

General

The Fowler-type wing flaps are operated by a single hydraulic jack (24) which lies along the left rear wing spar at Wing Station 3.0. The flaps move along tracks in the trailing edge and

are extended and retracted by a lever on the right side of the pilot's pedestal. To raise flaps, move lever forward; to lower flaps, pull lever aft.

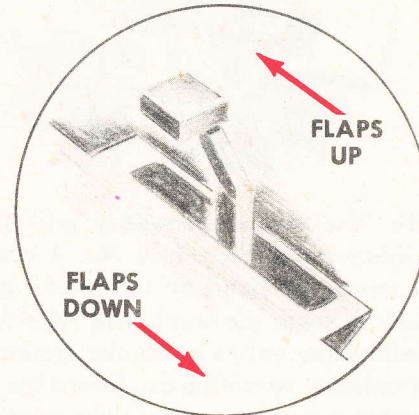

With full flaps extended, speeds in excess of 155 mph will create a sufficient pressure on the flaps to open a relief valve (22) at the operating cylinder and allow the flaps to retract automatically.

Caution: This relief valve is a safety precaution only. Do not test during flight as the excessive pressures required for this operation might damage the mechanism.

In case of **partial failure** of the main hydraulic system, the hand pump (10) outboard of the copilot's seat may be used through an independent direct line to the flap cylinder to **extend only**.

In case of complete failure of the hydraulic system, no manually controlled system is provided for the wing flaps.

BOMB BAY DOORS HYDRAULIC CONTROL

Two individual hydraulic jacks, one on each side of the fuselage, operate the bomb bay doors.

The operation of the bomb bay doors is controlled from any one of 4 positions:

1. Bombardier's compartment
2. Under radio operator's floor at hatch opening
3. On the ground from access door on right side forward of bomb bay door
4. Pilot's compartment

Main control valve
Auxiliary control valve

Auxiliary control valve

Emergency operation of auxiliary valve. Doors may be opened but not closed until pull line is re-set

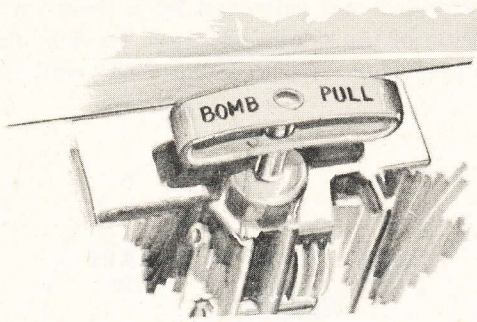

CAUTION: The pilot's emergency pull line to the auxiliary valve cam (see No. 4 control) must be re-set by hand or hydraulic system will bypass through the bomb jack relief valve, thus affecting the entire hydraulic system.

Under military operating conditions the main control valve is used to control the operation of the doors.

The auxiliary valve, in the accumulator system, is generally used for local flight operations.

In case of complete failure of the hydraulic system, the doors may be operated manually by hand cranks accessible from the catwalk at the center of the bomb bay.

Bomb Bay Door Position Indicators

When these doors are fully open the following lights are illuminated:

1. A red light on the bombardier's panel.
2. An amber light on the pilot's panel.
3. A white light on the tail to notify other airplanes in the formation.

POWER BRAKE HYDRAULIC CONTROL

Two completely separate units operate the hydraulic brakes. Each unit contains 2 brake cylinders which control one of the dual Hayes expanding-bladder-type brakes on each main landing wheel. One cylinder of each unit is mechanically interconnected to the right brake pedal of both pilot and copilot; the other cylinder of each unit is similarly connected to both left brake pedals.

Each unit takes its pressure directly from a different one of the 2 main accumulators which are isolated from each other by check valves so that failure of one accumulator does not affect the other. Failure of one complete unit leaves 1/2 braking power available.

NOSEWHEEL HYDRAULIC SHIMMY DAMPER

In landing or takeoff the nosewheel has a tendency to shimmy. A shimmy damper installed on the oleo strut dampens out this vibration without restricting any of the normal functions of the nosewheel. Two types of shimmy dampers are installed on B-24 aircraft. One type utilizes 2 hydraulic cylinders which act in opposite directions and are connected to an accumulator. Vibration is absorbed by the combined action of fluid passing through a restricted orifice and by the compressed air in the accumulator.

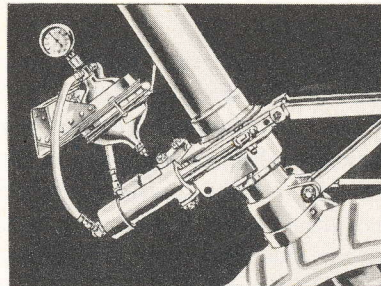

Accumulator Type Damper

The other type of shimmy damper is a single self-contained unit which dampens vibration by causing hydraulic fluid to flow through restricted orifices.

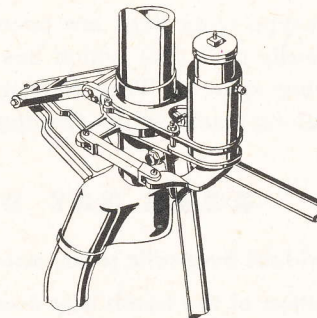

Houdaille Type Damper

In case of failure of the early accumulator type of shimmy damper, provision was made for locking it in a straight-travel, non-steerable position. This procedure was covered by an instruction chart at Station 1.2 on the right of the fuselage. No locking procedure is provided for the later type of Houdaille shimmy damper.

ELECTRICAL SYSTEM

Power Supply

1. When the engines are operating, power is generated by four 24-volt, 200-ampere, type P-1 generators, one on each engine. The voltage of each generator may be adjusted at the voltage regulator under the flight deck on each side of the centerline.

2. Main battery power is supplied by two 24-volt, 34-ampere-hour batteries connected in parallel.

3. Auxiliary power is supplied by a type C-10 auxiliary generator, with a capacity of 2.0 kilowatts and powered by an independent gasoline engine (Homelite unit). This auxiliary generator must be run for starting engines, or in the case of main generator failure in flight. The auxiliary power unit is not supercharged and power generation from the auxiliary unit, therefore, ceases at high altitudes.

4. For ground operation a provision is made for an external (battery cart) connection. Always use battery cart for first starts, where available, or have auxiliary power unit in operation. The excessive loads incident to initial start will shorten the life of the main batteries.

Note: The battery switches must be left off when using battery cart.

Electrical Systems

1. Direct current, 24-volt, single-wire system. Most of the electric equipment in the airplane, including late design of fluorescent lighting, is supplied through this system.

2. Alternating current 26-volt system for the autosyn indicator system.

3. Alternating current 115-volt system for the fluorescent lighting on some airplanes and the radio compass. Two independent inverters controlled by a selector switch on the pilot's pedestal permit use of either unit.

4. Alternating current 3-volt system for compass lighting, on some airplanes.

5. Miscellaneous systems for the gun turrets, automatic flight controls and radio.

Fuse Boxes and Circuits

From the various fuse boxes to which the above power is delivered, the following 16 DC and AC primary circuits distribute power to the mechanisms those circuits operate:

- Heating and ventilating controls
- Bomb release and signals
- Propeller controls
- Ice elimination controls, fuel and hydraulic pumps
- Exterior lights
- Instruments
- Ignition
- High tension
- Automatic flight controls and turrets
- Interior and recognition lights
- Landing gear signals and flap position indicator
- Power
- Radio and communication
- Engine starter
- Engine controls
- Misc. (camera, alarm bell, etc.)

Lights

Location and purpose of interior lights is given in the section on night flying.

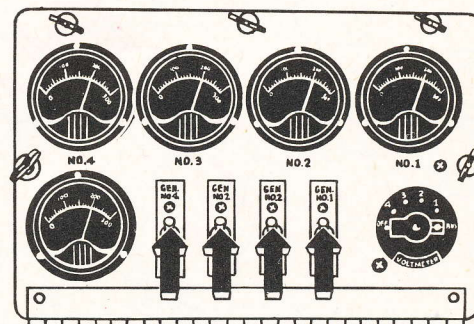

Panels and Switchboards

Generator control panel is on forward face of bulkhead at Station 4.1, left side of flight deck,

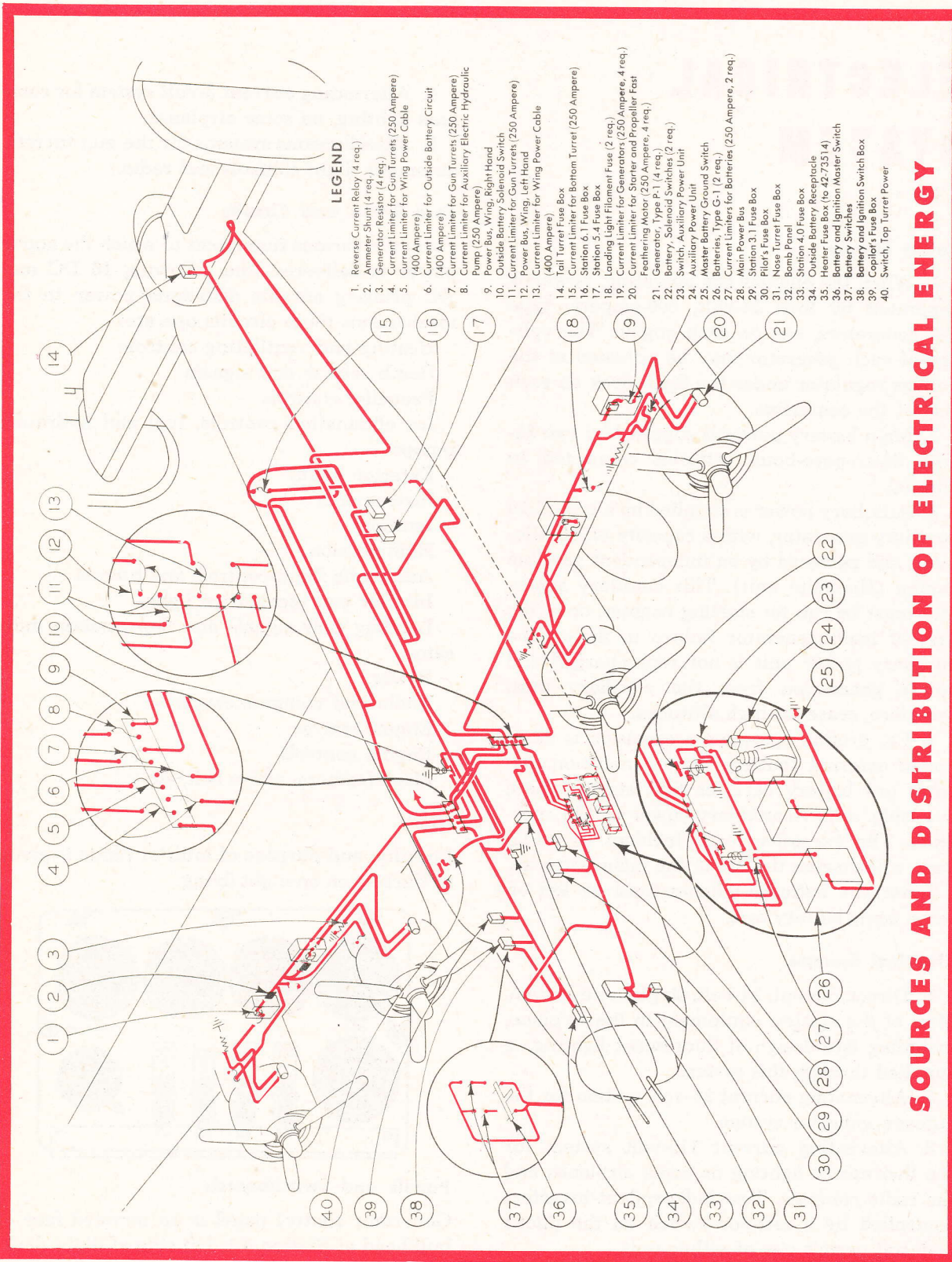

LEGEND

1. Reverse Current Relay, (4 req.)
2. Ammeter Shunt (4 req.)
3. Generator Resistor (4 req.)
4. Current Limiter for Gun Turrets (250 Ampere)
5. Current Limiter for Wing Power Cable (400 Ampere)
6. Current Limiter for Outside Battery Circuit (400 Ampere)
7. Current Limiter for Gun Turrets (250 Ampere)
8. Current Limiter for Auxiliary Electric Hydraulic Pump (250 Ampere)
9. Power Bus, Wing, Right Hand
10. Outside Battery Solenoid Switch
11. Current Limiter for Gun Turrets (250 Ampere)
12. Power Bus, Wing, Left Hand
13. Current Limiter for Wing Power Cable (400 Ampere)
14. Tail Turret Fuse Box
15. Current Limiter for Bottom Turret (250 Ampere)
16. Station 6.1 Fuse Box
17. Station 5.4 Fuse Box
18. Landing Light Filament Fuse (2 req.)
19. Current Limiter for Generators (250 Ampere, 4 req.)
20. Current Limiter for Starter and Propeller Fast Feathering Motor (250 Ampere, 4 req.)
21. Generator, Type P-1 (4 req.)
22. Battery, Solenoid Switches (2 req.)
23. Switch, Auxiliary Power Unit
24. Auxiliary Power Unit
25. Main Power Control Switch
26. Batteries, Type G-1 (2 req.)
27. Current Limiters for Batteries (250 Ampere, 2 req.)
28. Main Power Bus
29. Station 3.1 Fuse Box
30. Pilot's Fuse Box
31. Nose Turret Fuse Box
32. Bomb Panel
33. Station 4.0 Fuse Box
34. Outside Battery Receptacle
35. Heater Fuse Box (to 42-73514)
36. Battery and Ignition Master Switch
37. Battery Switches
38. Battery and Ignition Switch Box
39. Copilot's Fuse Box
40. Switch, Top Turret Power

SOURCES AND DISTRIBUTION OF ELECTRICAL ENERGY

and carries 4 field switches to cut generators in or out of main system. One voltmeter with multi-point selector switch indicates voltage output of each generator or main bus, and the 4 ammeters, one for each generator, indicate current flow.

Voltage regulators, 2 on each side forward of bulkhead at Station 4.0 under flight deck, provide generator voltage adjustment for balance of load.

Five main electric switch panels control the distribution of power to the 16 primary circuits. One of these is at the left of the bombardier; the other 4 are in the pilot's compartment.

Spare Current Limiters, Fuses and Lamps

The fusible links for the 4 main generators are not accessible in flight; neither are the landing light filament circuit fuses nor the nacelle power circuit limiters in the nacelle junction boxes.

Fuses and interior limiters are replaceable in flight and are located as follows:

1. Spare fusible links are located in the limiter boxes which are located as follows: 2 on left accumulator bracket; 4 on the left and 6 on the right rear face of the bulkhead at Station 4.1. All limiters require a 1/2-inch wrench to remove and install.
2. Spare fuses are provided in each fuse box.
3. A spare bulb for the landing gear down-position indicator is clipped to the instrument panel.
4. A spare bulb assortment is located aft of bulkhead at Station 4.0 on the left side. No spare bulbs for exterior lights are carried.

Note: Fuse boxes in general are located near places where fuses are used. Open these boxes and study the chart to see what fuses are provided and where they are used. This will save a hurried hunt in emergencies.

OIL SYSTEM

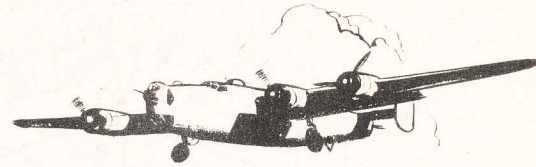

Each engine nacelle contains its independent oil system, consisting of a hopper-type self-sealing tank 32.9 U.S. (27.3 Imperial) gallons, temperature regulator, engine pump, and propeller feathering pump.

Engine oil systems provide oil for lubrication of the turbo-supercharger impellers and for operation of the propeller feathering system. The supercharger waste gate regulator, Eclipse type A-13, which is installed on early B-24G, H, and J aircraft, is also actuated by engine oil pressure.

The oil dilution valve for each engine is controlled by a switch located on the copilot's switch panel. Engine oil may be heated by externally powered neck-type immersion heaters.

An oil temperature indicator located on the copilot's instrument panel indicates the oil temperature as determined by a resistance bulb in the Y drain valves.

An oil pressure indicator located on the copilot's instrument panel measures the oil pressure at a restricted fitting in the rear crank case section as determined by an autosyn transmitter.

Oil Dilution

Oil dilution is necessary when ground temperatures reach 4°C or lower, in order to keep the oil from congealing so much that starting will be difficult.

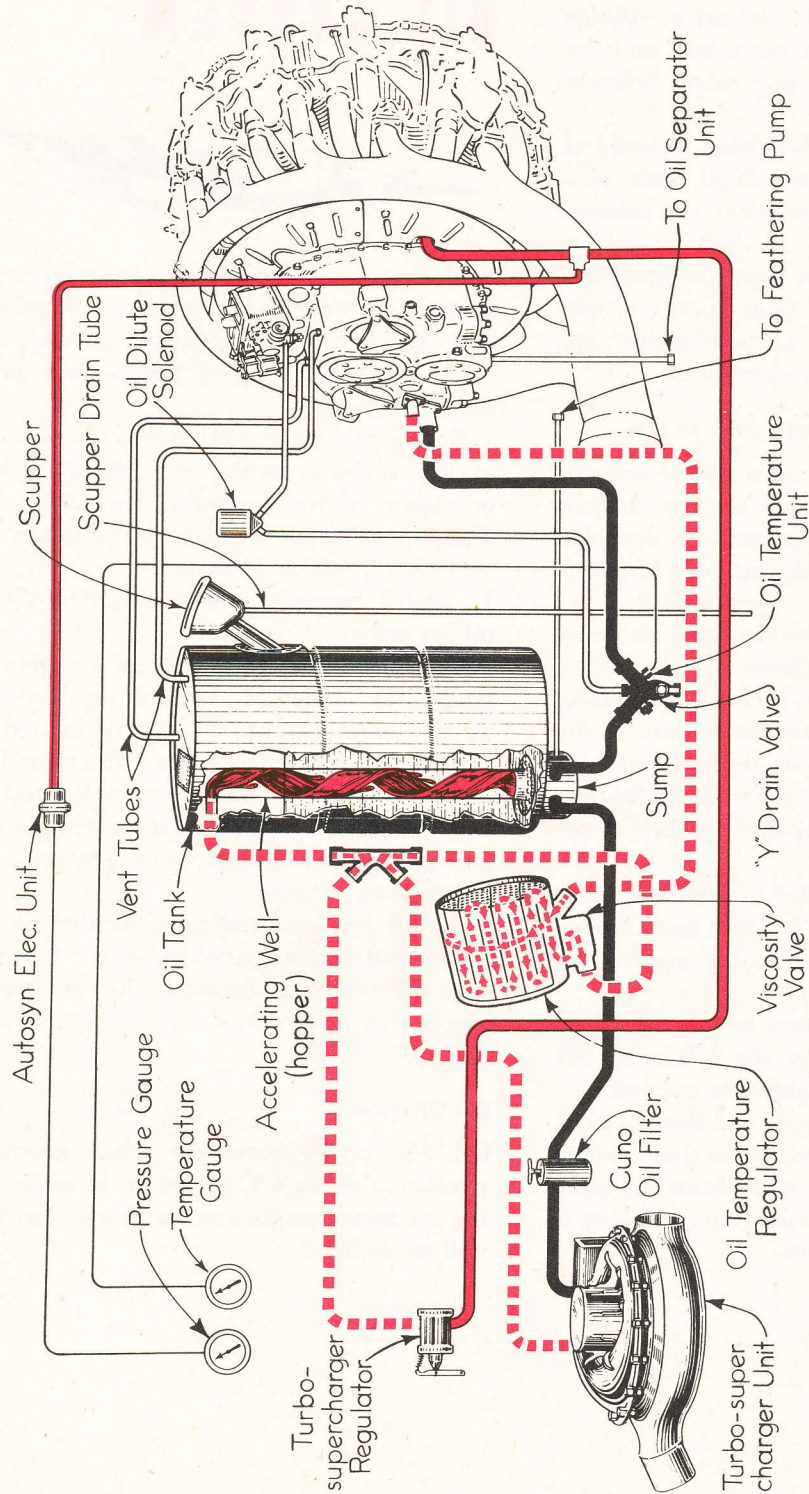

LEGEND
 Line from Tank
 Return to Tank
 Pressure

TURBO REGULATOR OIL LINE OMITTED WHEN ELECTRONIC CONTROL IS USED.

DIAGRAM OF OIL SYSTEM

OIL DILUTION PROCEDURE

CAUTION:

1. Operate engines at 800 to 1000 rpm.
2. Dilute all engines simultaneously with gang bar if indicated oil pressures do not exceed a 10-lb. variation. If this tolerance is exceeded, dilute each engine separately.
3. Maintain oil temperature below 40°C (104°F).
4. Before diluting all engines simultaneously, establish the average indicated pressure. If engines are diluted individually, oil pressure of each must be noted before dilution.
5. Dilute engine oil as follows, for ground temperature as shown:
 +4° to -26°C (+40° to -15°F) depress dilution switch until a 35% oil pressure reduction is accomplished.
 -26° to -40°C (-15° to -40°F) depress dilution switch until a 50% pressure reduction is accomplished.
6. It is important to leave dilution switches engaged until propellers cease rotating, so undiluted oil will not be drawn into the engine.
7. Under extremely low temperatures, locally recommended procedure should be followed.
8. On airplanes having oil-operated turbo regulators, operate turbo controls over complete range from low to high blower and return at the minimum rate of 8 seconds per cycle (at least 14 complete movements from low to high blower and return) during the last 2 minutes of the dilution period.
9. During the last 2 minutes of the dilution period depress propeller feathering switch until drop of 400 rpm is observed. Pull out feathering switch and allow rpm to return to normal. Repeat this operation 3 times.

NOTE: Overdilution causes sludge and carbon to be loosened in the engine, causing oil screens to collapse and oil lines to clog. This constitutes a fire hazard, and may cause engine failure as well.

FUEL SYSTEM

The following fuel capacity is provided in the B-24.

Main system—4 sets of 3 cells each; total 12 cells; total capacity 2344 U. S. gallons:

- No. 1 tank—616 U. S. Gallons
- No. 2 tank—556 U. S. Gallons
- No. 3 tank—556 U. S. Gallons
- No. 4 tank—616 U. S. Gallons

Auxiliary wing system—2 sets of 3 cells each; total 6 cells; total capacity 450 U. S. Gallons:

- Left-hand tank—225 U. S. Gallons
- Right-hand tank—225 U. S. Gallons

Auxiliary bomb bay system—2 separate cells with a total capacity of 782 U. S. gallons:

- Left-hand tank—391 U. S. Gallons
- Right-hand tank—391 U. S. Gallons

Fuel System Indicators

Pressure—Gages measuring fuel pressure at the carburetors are mounted on the copilot's instrument panel.

Quantity—Sight gages, mounted on the forward face of bulkhead at Station 4.1, left side,

RESTRICTED

show the quantity of fuel in each of the main systems. In case of damage to the gage vent or supply lines, shut-off valves are provided on top of the gages and at the supply takeoff under the center section, to prevent the loss of fuel.

No fuel quantity gages are provided in either auxiliary system. A glass tube between the wing auxiliary selector valve and the transfer pump shows flow of fuel being transferred.

Note: Inclinator on outboard side of fuel gages must read neutral when gages are read.

Warning: Aromatic Fuel—Do not use aromatic fuel in the system unless all units carry the markings which designate them as suitable for aromatic fuel.

Aromatic-resistant, self-sealing fuel hose can be identified by a single red stripe and correct part number in red. Part number and name of manufacturer are stamped every 12 inches: AR-145, or G-145 Goodyear; AR-184 Goodrich or Boston Woven Hose; AR-250 U. S. Rubber.

Aromatic-resistant fuel hose, not self-sealing, can be identified by a white stripe and a broken red line. This hose is used only for connection of aluminum alloy tubing to fuel system lines (engine-driven fuel pump to carburetor line and fuel cell vent system lines.)

All other parts of the systems are marked with an A if suitable for aromatic fuels. Units made of aluminum alloy carry an A painted in red or stamped on the aluminum body.

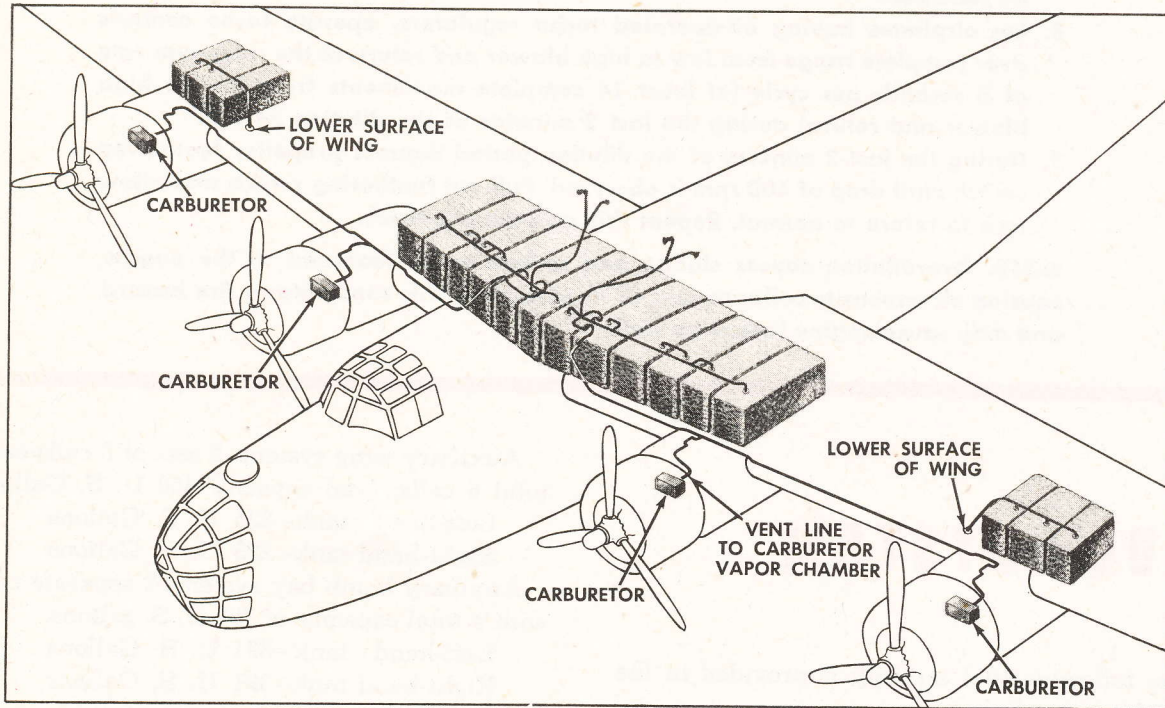

Fuel System

Main Fuel System

1. Twelve self-sealing fuel cells in the wing center section. There are 4 sets of 3 cells each. In normal operation each engine is served by one set.

2. Four electrically-driven booster pumps with strainers (one for each set of cells). They are usually located in the bomb bay just under the cells.

3. Four triple-port shut-off valves. On each valve: One port leads to an engine; one port leads to a set of cells; and one port interconnects to the other 3 valves by way of the cross-feed connection which allows fuel from any set of cells to serve any engine in an emergency, and permits equalizing flow between systems. These valves are under the front spar in the bomb bay.

4. Four engine-driven pumps with strainers are located one in each nacelle.

5. Four electrically controlled primers are located one on each carburetor.

6. Two vent systems for the main fuel systems. One of these vents the fuel system serving Engines 1 and 2; namely, the left bank of main fuel cells; the left fuel gauge; and the carburetors on the left wing. In the same manner the other vent system vents the fuel system serving Engines 3 and 4 on the right wing.

7. Two vent systems for the wing auxiliary fuel system. One of these vents the 3 cells in the left wing; similarly, the other vents the 3 auxiliary cells in the right wing.

8. One electrically driven transfer pump above the center wing section allows transfer of fuel to a main system through the transfer panel.

9. Drain lines for the wing fuel cell compartments and for the 4 fuel booster pumps empty overboard under the bulkhead at Station 5.0. The 2 shut-off valves are normally open, but must be closed during combat.

10. Main fuel system supply lines and cell interconnecting, or manifold, lines are self-sealing.

Fuel Transfer From One Main System to Another

Procedure for transferring fuel from one main system to another is vital information. Illustrations give examples of fuel transfer methods which are typical of the 3 different arrangements in the main systems. Airplane serial numbers, recorded on the nameplate on the left of the pilots' pedestal, are an index to the selection of the proper illustration of fuel transfer.

Wing Auxiliary Fuel System

1. Six self-sealing fuel cells, 3 in each wing, are located outboard of the wheel wells.

2. Transfer of fuel from the wing auxiliary systems is controlled at 2 panels located above the wing center section. The aft or auxiliary selector valve panel contains one 2-way selector shut-off valve and strainer. This valve selects the auxiliary system, left or right, from which fuel is to be transferred. In later installations the forward or auxiliary transfer panel contains two 2-way selector shut-off valves, the transfer pump, and switch. These valves select the main system, 1, 2, 3, or 4, or any combination thereof, into which fuel is to be transferred.

3. Two venting systems, one for each auxiliary set of 3 cells, right and left.

4. Auxiliary wing cell fuel supply lines are self-sealing.

Fuel Transfer—Wing Auxiliary System to Main System

Illustrations give examples of fuel transfer methods which are typical of the 2 different arrangements to be found in wing auxiliary systems.

The rate of fuel transfer in this system is approximately 5 U.S. gallons per minute, or 300 gallons per hour. In case of emergency, should the pump fail, fuel transfer from either auxiliary set of wing cells to the main system can be effected by lowering the opposite wing from 3° to 5°. The rate of fuel flow under this condition is approximately 3 gallons per minute, or 180 gallons per hour.

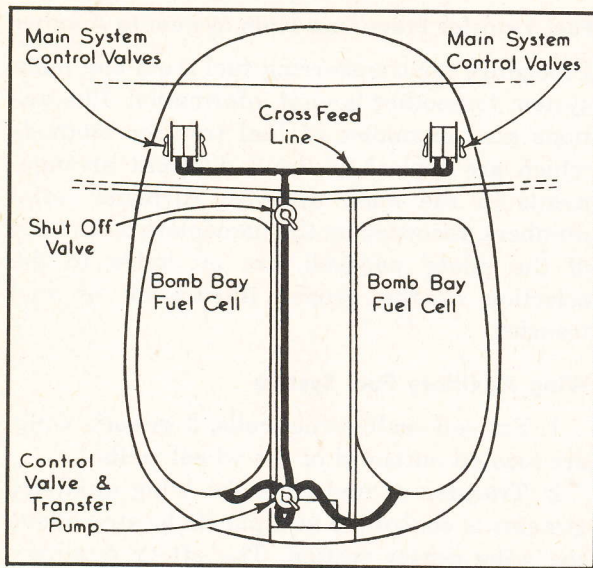

Bomb Bay Auxiliary Fuel System

Bomb Bay Auxiliary Fuel System

1. Two self-sealing fuel cells are provided, one on each side of the catwalk in the forward bomb bay.

2. In later installations a 2-way selector valve and transfer pump are mounted on the catwalk at Station 5.0, and another 2-way shutoff drain valve is connected to a T fitting in the cross-feed line.

Fuel Transfer—Bomb Bay Auxiliary System to Main System

Illustrations on the following pages give examples of fuel transfer methods which are typical of the 3 different arrangements to be found in bomb bay auxiliary systems.

The rate of fuel transfer in this system is approximately 10 U.S. gallons per minute, or 600 gallons per hour.

PRECAUTIONS WHEN TRANSFERRING FUEL

1. Know the system for transferring fuel in the particular airplane you are flying.
2. Start transfer as soon as fuel in main tank is consumed to a point where transfer can be accomplished. This assures you sufficient fuel to return to your base in case of failure of transfer system, improves loading, and reduces fire hazards.
3. Radio equipment and auxiliary hydraulic pumps off during transfer.
4. Warn crew that fuel will be transferred—no smoking.
5. At the end of 10 minutes, turn the transfer pump off, shut off all transfer valves, and determine that fuel is being properly transferred before continuing.

6. If transferring fuel from bomb bay tanks:
 - a. Remove bomb bay tank cap for inspection. Return cap to proper place before resuming transfer operation.
 - b. One crew member should be on watch in bomb bay at all times when transfer is in progress. At any indication of overflow, bomb bay transfer pump should be stopped and thorough inspection conducted.
7. Bomb bay doors should be open slightly (6 to 8 inches) before and during transfer.
8. Don't attempt to fill more than one main tank at a time as all engines connected to the crossfeed manifold will stop running when the bomb bay tanks are empty and air is introduced into crossfeed manifold.
9. Do not turn on fuel pump switch until selector valves are set; do not change setting of selector valves while fuel pump is on.
10. Do not leave selector valves "ON" or "BOTH ON" after transfer is completed.

FILLING ONE MAIN SYSTEM FROM ANOTHER USING U HOSES WHILE FEEDING FOUR ENGINES ON B-24 AIRPLANES, THROUGH No. 41-11938
EXAMPLE: FUEL TRANSFER FROM No. 4 MAIN SYSTEM TO No. 2 MAIN SYSTEM

GENERAL INSTRUCTIONS

When system being filled is within 50 gallons of full, turn main transfer pump OFF and disconnect U hoses.

Turn pump ON after U hoses are connected

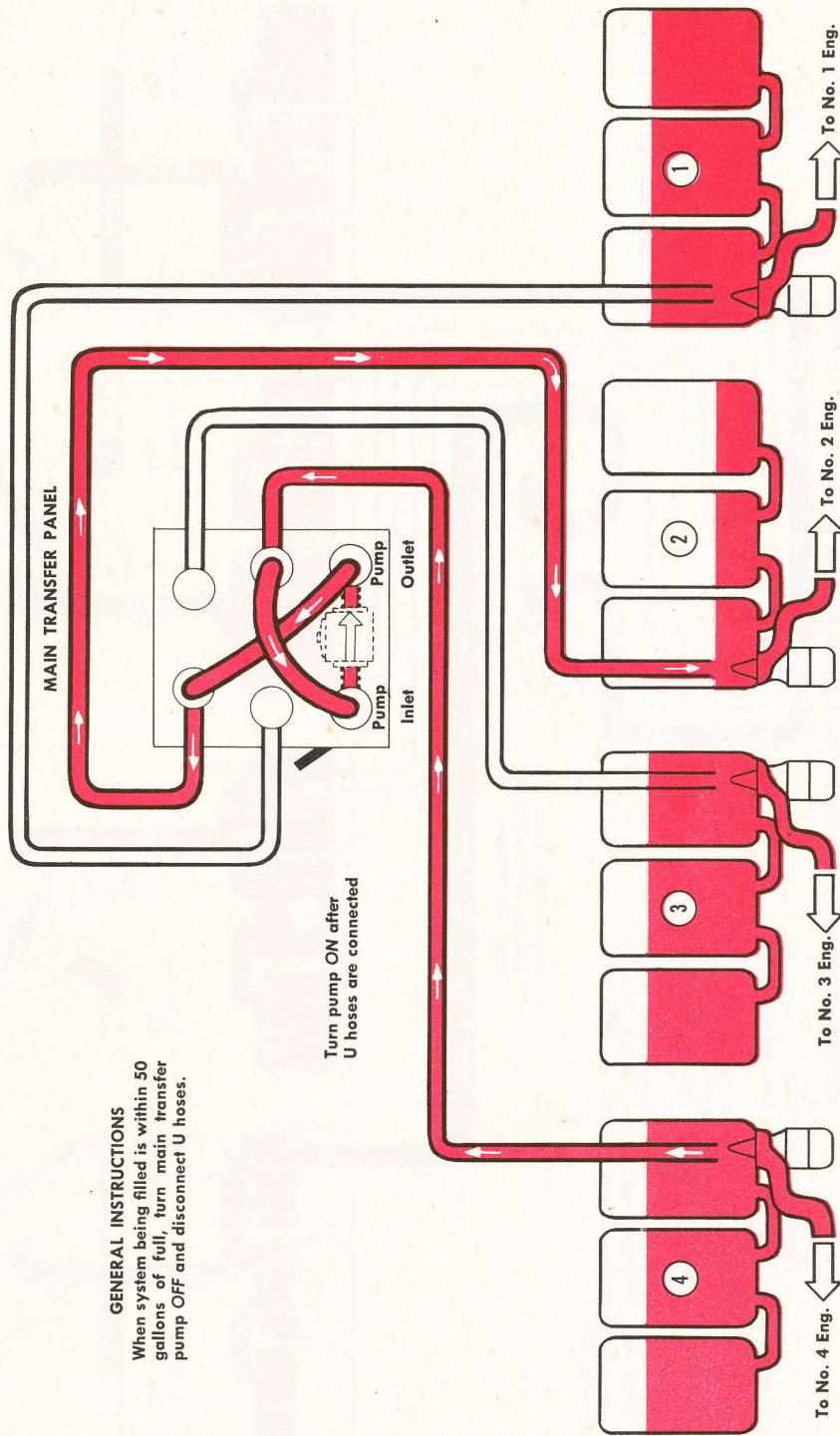

FILLING ONE MAIN SYSTEM FROM ANOTHER WHILE FEEDING FOUR ENGINES ON B-24 AIRPLANES
FROM No. 41-23640 TO 42-40917

EXAMPLE: FUEL TRANSFER FROM No. 1 MAIN SYSTEM TO No. 4 MAIN SYSTEM

GENERAL INSTRUCTIONS

To speed transfer use booster pumps and cross-feed line in conjunction with U hoses. When system being filled is within 50 gallons of full, turn main transfer pump OFF and disconnect hoses. Reset selector valves of system being filled and system being drained to TANK TO ENGINE. When any main system is emptied set its selector valve to CROSS FEED TO ENGINE and set the selector valves of the three remaining systems to TANK TO ENGINE AND CROSS FEED.

CAUTION: Do not fill more than one system at a time and have radio OFF.

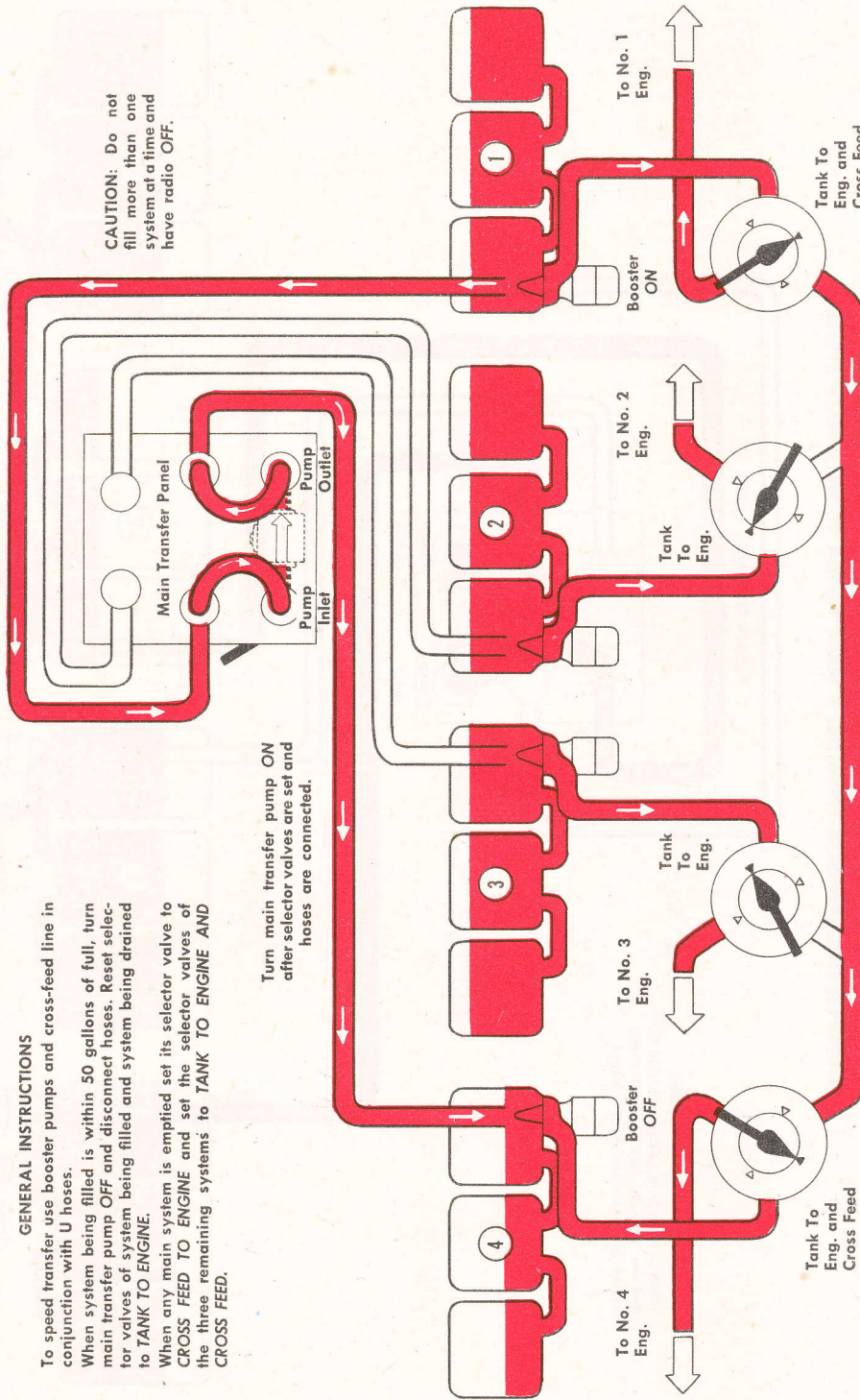

Turn main transfer pump ON after selector valves are set and hoses are connected.

When fuel is low in all systems and it is desired to level tanks, set selector valves of all main systems to TANK TO ENGINE AND CROSSFEED, with booster pumps OFF. As soon as tanks are leveled, turn selectors back to TANK TO ENGINE.

**FILLING ONE MAIN SYSTEM FROM ANOTHER USING CROSS FEED WHILE FEEDING FOUR ENGINES
ON B-24 AIRPLANES, ON AND AFTER No. 42-40918
EXAMPLE: FUEL TRANSFER FROM No. 1 MAIN SYSTEM TO No. 3 MAIN SYSTEM**

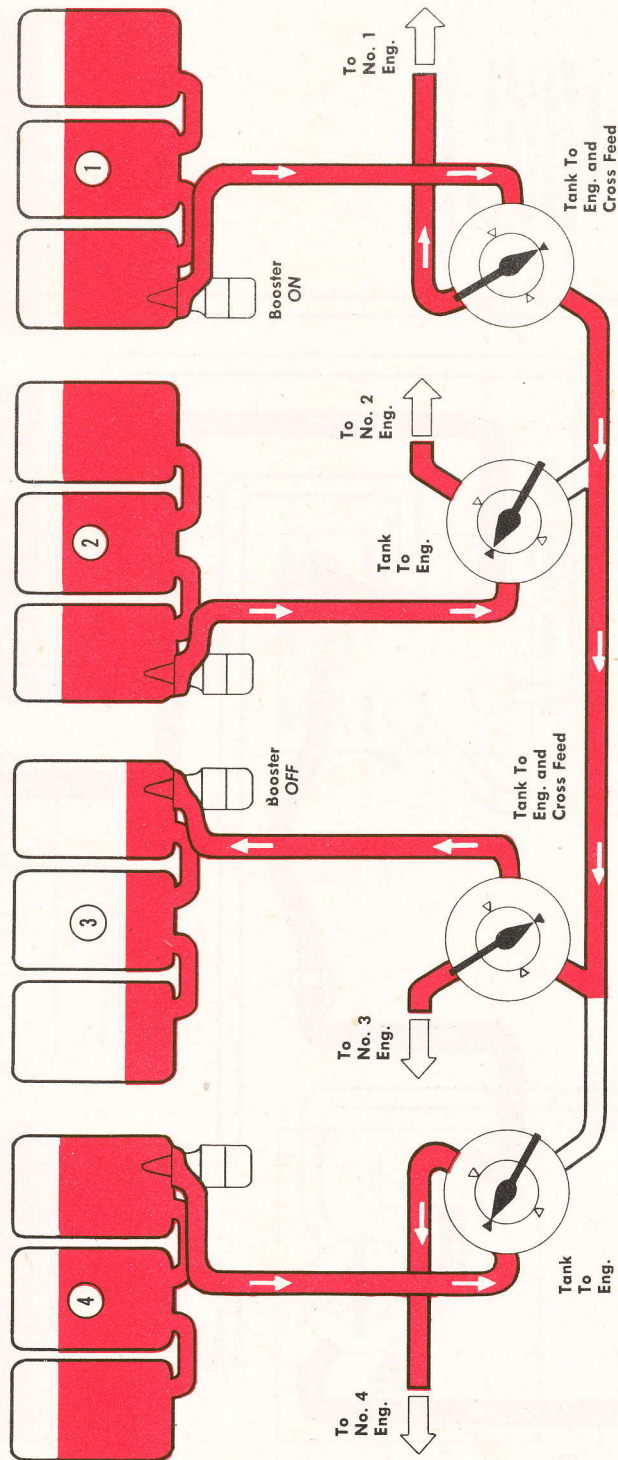

GENERAL INSTRUCTIONS

When system being filled is within 50 gallons of full, reset selector valves of system being filled and system being drained to **TANK TO ENGINE**.

When any main system is emptied set its selector valve to **CROSS FEED TO ENGINE** and set the selector valves of three remaining systems to **TANK TO ENGINE AND CROSS FEED**.

When fuel is low in all systems and it is desired to level tanks, set selector valves of all main systems to **TANK TO ENGINE AND CROSSFEED**, with booster pumps OFF. As soon as tanks are leveled, turn selectors back to **TANK TO ENGINE**.

CAUTION: Do not fill more than one system at a time and have radio OFF.

FILLING ONE MAIN SYSTEM FROM THE AUXILIARY WING SYSTEMS USING U CONNECTORS WHILE FEEDING FOUR ENGINES ON B-24 AIRPLANES, FROM No. 41-23640 TO No. 42-40917
EXAMPLE: FUEL TRANSFER FROM L. H. AUXILIARY WING SYSTEM TO No. 3 MAIN SYSTEM

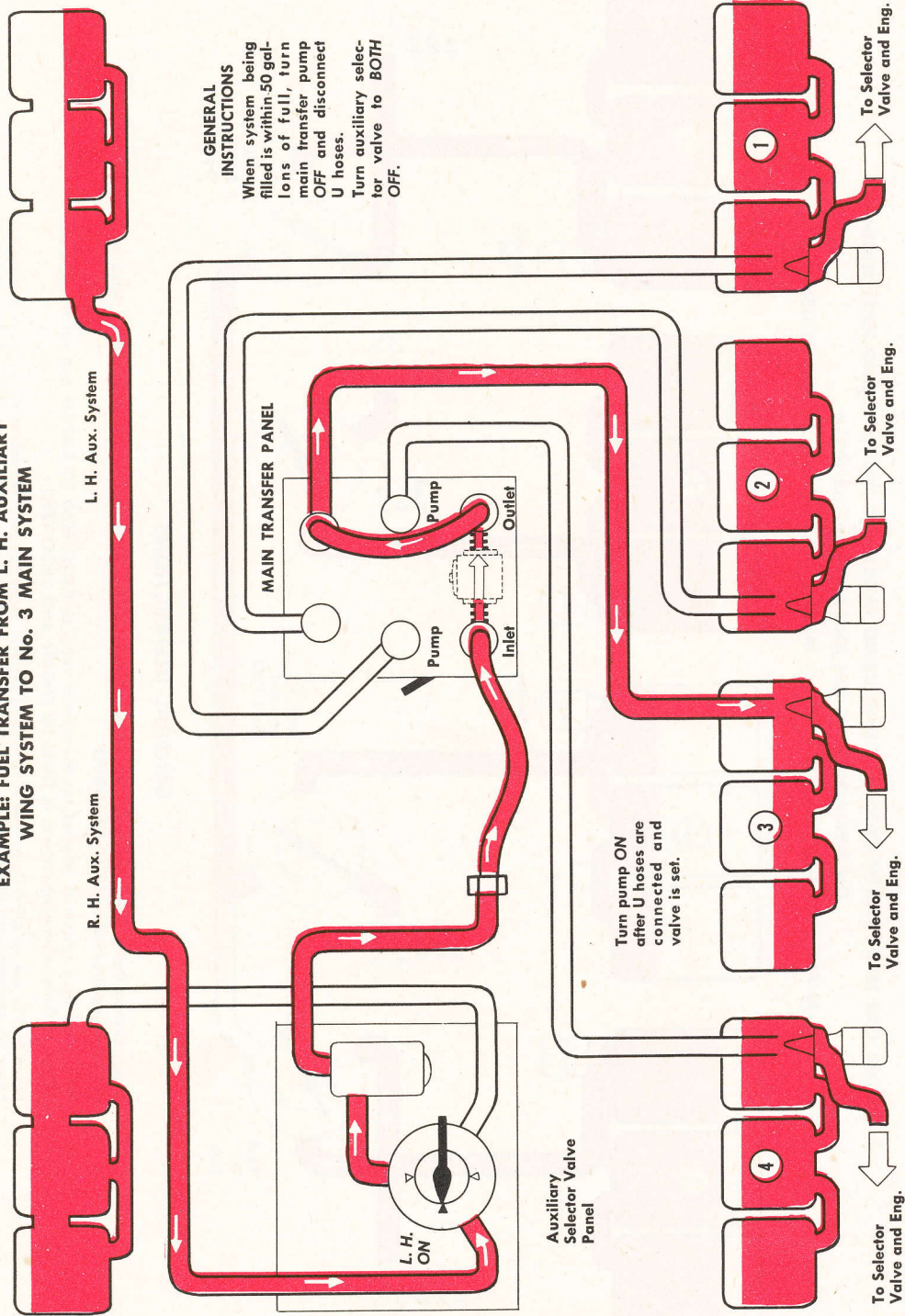

GENERAL INSTRUCTIONS
 When system being filled is within 50 gallons of full, turn main transfer pump OFF and disconnect U hoses.
 Turn auxiliary selector valve to BOTH OFF.

Turn pump ON after U hoses are connected and valve is set.

Auxiliary Selector Valve Panel

L. H. ON

R. H. Aux. System

L. H. Aux. System

MAIN TRANSFER PANEL

Pump

Pump

Outlet

Inlet

1

2

3

4

To Selector Valve and Eng.

To Selector Valve and Eng.

To Selector Valve and Eng.

To Selector Valve and Eng.

FILLING THE MAIN SYSTEMS FROM THE AUXILIARY WING SYSTEMS WHILE FEEDING FOUR ENGINES ON

B-24 AIRPLANES, ON AND AFTER No. 42-40918

EXAMPLE: FUEL TRANSFER FROM BOTH AUXILIARY WING SYSTEMS TO No. 3 AND No. 4 MAIN SYSTEMS

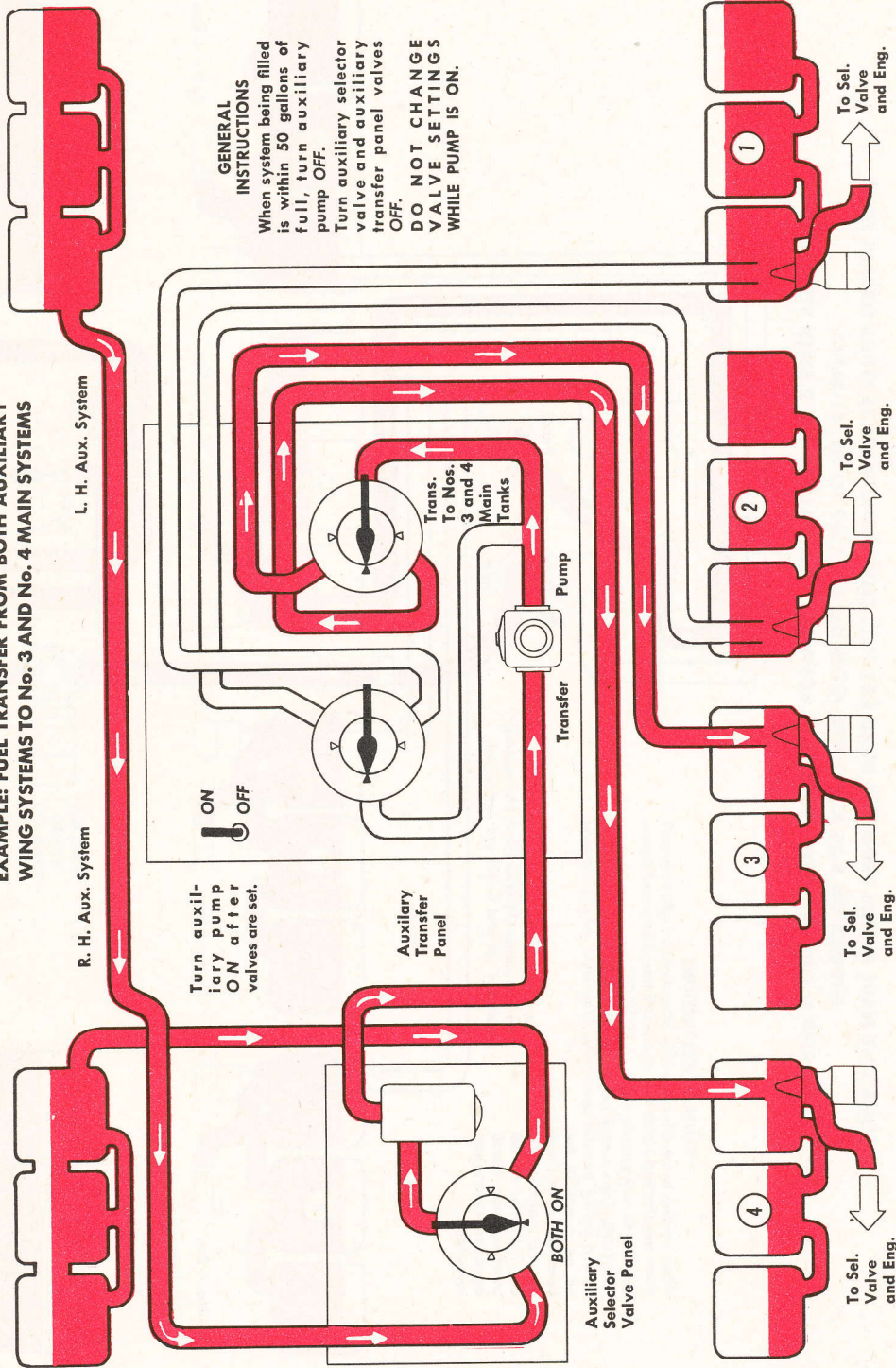

GENERAL INSTRUCTIONS
 When system being filled is within 50 gallons of full, turn auxiliary pump OFF.
 Turn auxiliary selector valve and auxiliary transfer panel valves OFF.
DO NOT CHANGE VALVE SETTINGS WHILE PUMP IS ON.

Turn auxiliary pump ON after valves are set.

BOTH ON

Auxiliary Selector Valve Panel

Auxiliary Transfer Panel

Pump

Transfer

Trans. To Nos. 3 and 4 Main Tanks

L. H. Aux. System

R. H. Aux. System

To Sel. Valve and Eng.

To Sel. Valve and Eng.

To Sel. Valve and Eng.

To Sel. Valve and Eng.

FILLING ONE MAIN SYSTEM FROM THE BOMB BAY FUEL CELLS USING U HOSES WHILE FEEDING FOUR ENGINES ON B-24 AIRPLANES, FROM No. 41-11587 TO No. 41-24175
EXAMPLE: FUEL TRANSFER FROM BOTH BOMB BAY FUEL CELLS TO No. 2 MAIN SYSTEM

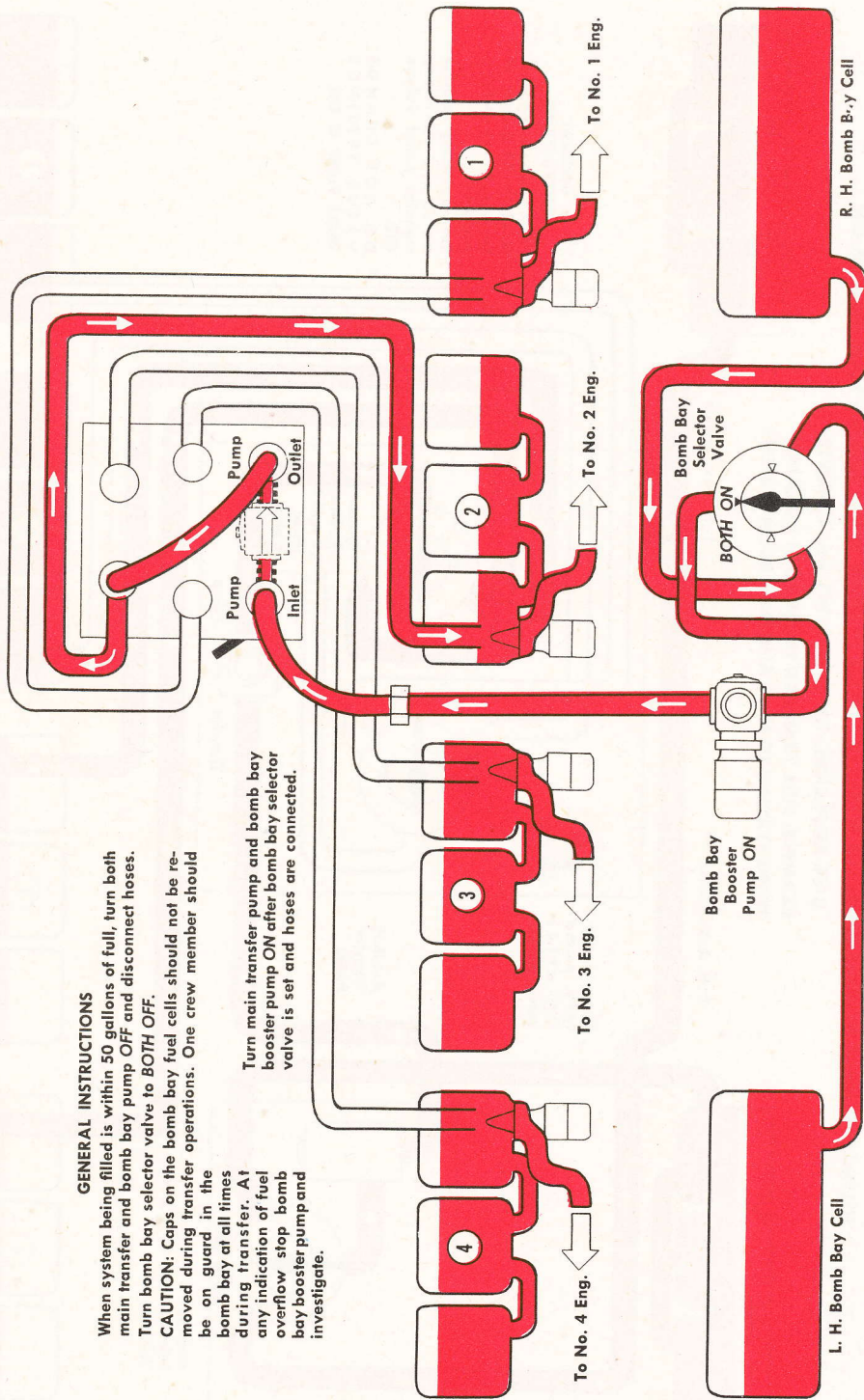

GENERAL INSTRUCTIONS

When system being filled is within 50 gallons of full, turn both main transfer and bomb bay pump OFF and disconnect hoses. Turn bomb bay selector valve to BOTH OFF.

CAUTION: Caps on the bomb bay fuel cells should not be removed during transfer operations. One crew member should be on guard in the bomb bay at all times during transfer. At any indication of fuel overflow stop bomb bay booster pump and investigate.

Turn main transfer pump and bomb bay booster pump ON after bomb bay selector valve is set and hoses are connected.

FILLING ONE MAIN SYSTEM FROM A BOMB BAY FUEL CELL WHILE FEEDING FOUR ENGINES ON

B-24 AIRPLANES, ON AND AFTER No. 42-40918

EXAMPLE: FUEL TRANSFER FROM L. H. BOMB BAY FUEL CELL TO NO. 4 MAIN SYSTEM

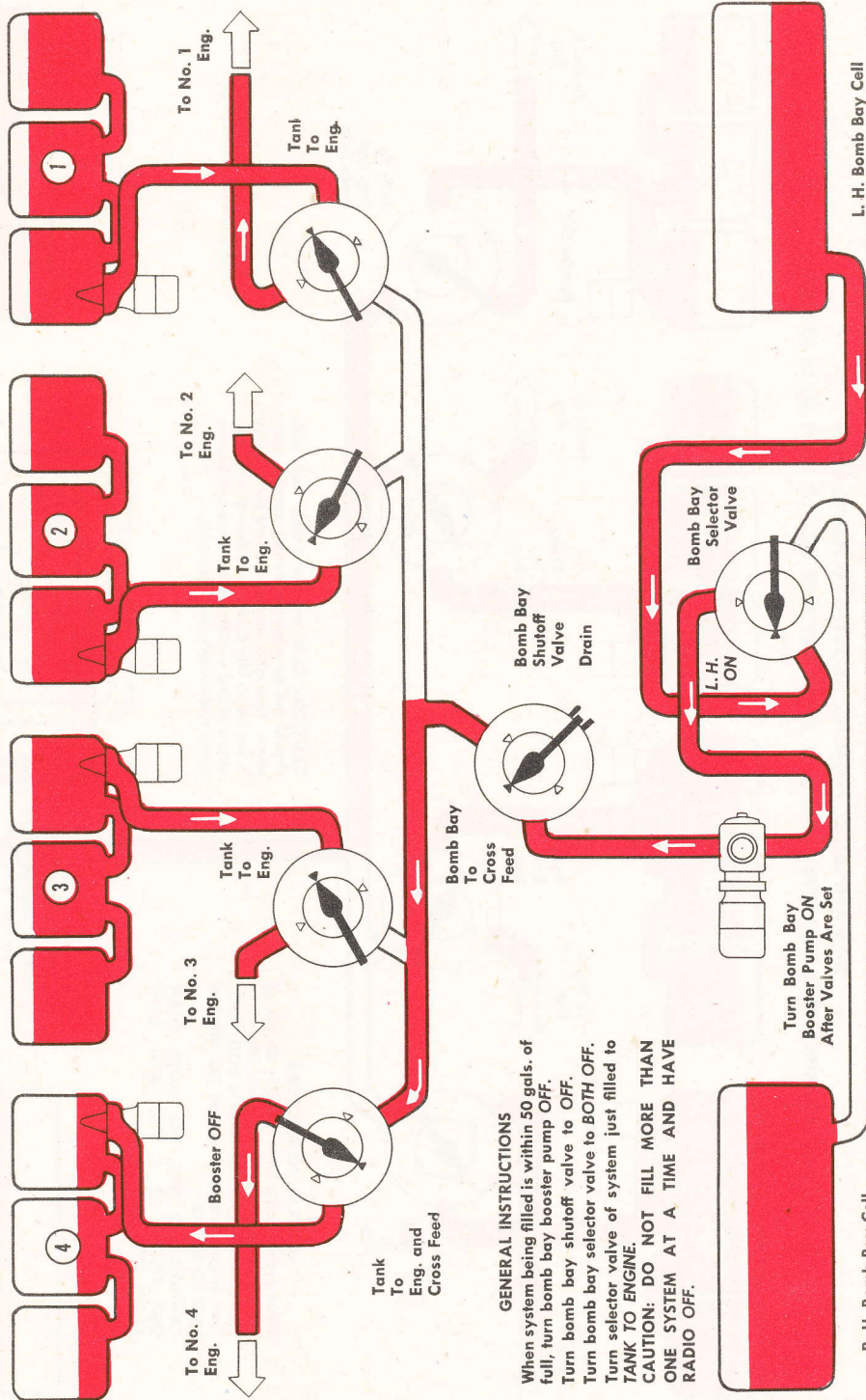

GENERAL INSTRUCTIONS
 When system being filled is within 50 gals. of full, turn bomb bay booster pump OFF.
 Turn bomb bay shutoff valve to OFF.
 Turn bomb bay selector valve to BOTH OFF.
 Turn selector valve of system just filled to TANK TO ENGINE.
CAUTION: DO NOT FILL MORE THAN ONE SYSTEM AT A TIME AND HAVE RADIO OFF.

Turn Bomb Bay Booster Pump ON After Valves Are Set

FILLING ONE MAIN SYSTEM FROM A BOMB BAY FUEL CELL WHILE FEEDING FOUR ENGINES ON B-24 AIRPLANES, FROM No. 41-24176 TO No. 42-40917
 EXAMPLE: FUEL TRANSFER FROM R. H. BOMB BAY FUEL CELL TO No. 1 MAIN SYSTEM

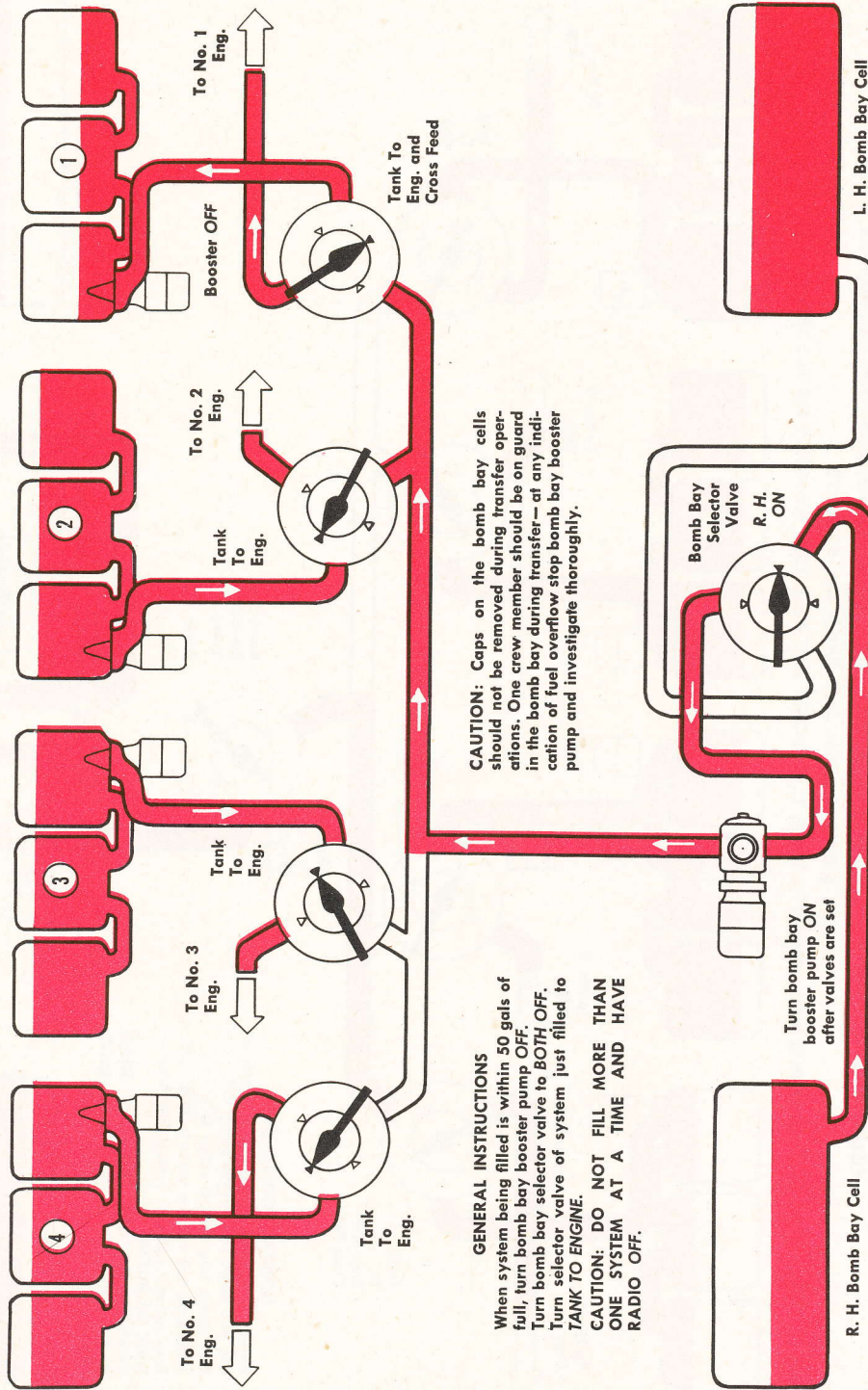

CAUTION: Caps on the bomb bay cells should not be removed during transfer operations. One crew member should be on guard in the bomb bay during transfer—at any indication of fuel overflow stop bomb bay booster pump and investigate thoroughly.

GENERAL INSTRUCTIONS
 When system being filled is within 50 gals of full, turn bomb bay booster pump OFF.
 Turn bomb bay selector valve to BOTH OFF.
 Turn selector valve of system just filled to TANK TO ENGINE.
CAUTION: DO NOT FILL MORE THAN ONE SYSTEM AT A TIME AND HAVE RADIO OFF.

Turn bomb bay booster pump ON after valves are set

HEATING SYSTEMS

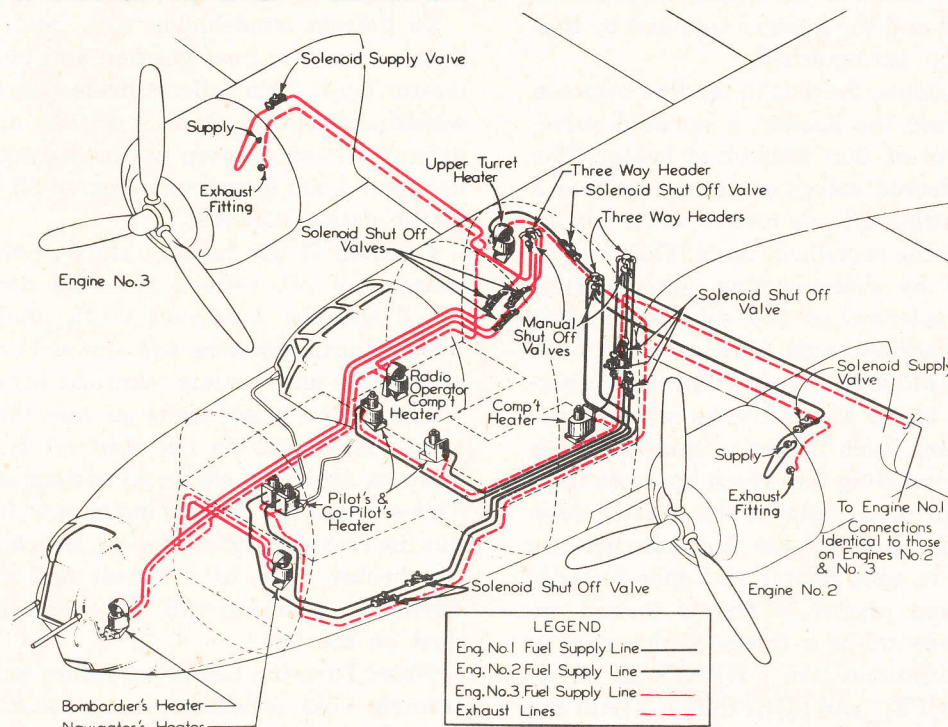

General

Two methods of supplying warmth are provided in the airplane: fuel-fired heaters and electrically heated clothing. (Also see section on exhaust heat system for late series B-24's -pp. 149-150.)

Heaters

Stewart-Warner circulating air heaters are provided for pilot, copilot, radio operator, bombardier, and navigator, and are arranged in

separate systems of source of supply, control, and heater grouping in most aircraft, as shown in the table below.

A switch, at the right of the copilot, operates a master solenoid valve which controls Group No. 1. A switch at the bombardier's panel serves similarly for Group No. 2.

Manually controlled shut-off valves attached to the 3-way headers are just forward of the front spar, right and left, to permit shutting off fuel supply to heaters in case of master solenoid valve failure.

ENGINE NO. 2

SOLENOID SUPPLY VALVE (MAIN)

- 3-way header (Aux.)
- Indiv. shut-off valve
- Indiv. shut-off valve
- Indiv. shut-off valve

GROUP 1

- Pilot
- Copilot
- Top Gunner

ENGINE NO. 3

SOLENOID SUPPLY VALVE (MAIN)

- 3-way header (Aux.)
- Indiv. shut-off valve
- Indiv. shut-off valve
- Indiv. shut-off valve

GROUP 2

- Radio Operator
- Bombardier
- Navigator

If the manifold pressure is reduced below 15" on an engine, there is not sufficient pressure to supply fuel and the heaters supplied by that engine will be extinguished.

On later systems, there is in the line between each heater and the header, a solenoid valve, for the control of that individual heater. The individual solenoid valves are useful only as a means of shutting off one heater while retaining the use of the remaining units. This may be accomplished by disconnecting the electrical plug at the solenoid of any selected heating unit. Combustion exhaust fumes are led back to the engine induction systems through asbestos-protected tubes. There are no valves in the exhaust system. Each heater is equipped with an electric circulating fan which operates from the same control circuits as the master solenoids. Igniters to ignite the fuel mixture are incorporated in each heater and operate automatically when master switch is turned on. The copilot's switch is a three-position switch; the three positions are "HEATERS ON," "HEATERS OFF," and "DEFROST." With the switch in position to defrost only, the circulations fans will operate and no heat will be generated. The bombardier's switch has only two positions, "ON" and "OFF."

To defrost windshields, without heat, turn on the heater switch to defrost and pull out defroster knobs. This deflects air blast into windshield duct system. Pull out and attach de-

froster hose with the strap clamp mounted at the bottom of the windshield.

To defrost windshields with heat, turn the heater switch to heat position and pull out defroster knob. This deflects heated air blast into windshield duct system. Pull out and attach defroster hose. To stop defrosting action, push defroster knob in and turn heated off by means of the copilot's switch.

Caution: If the heaters start smoking after being shut off, reduce manifold pressure on No. 2 and No. 3 engines to 15" and turn on heaters until smoking has stopped. Then turn off heaters and resume manifold pressure.

This action is necessary in case the solenoid valves stick and do not shut off the fuel-air mixture after the electrical system is shut off. This permits the fuel-air mixture to burn without the fans circulating the air, which will cause the heater oven to overheat and eventually burn out. Smoking will also occur if there is dust on the fins.

Note: Turn the heater on before entering extremely cold conditions to prevent solenoids from freezing up.

If the fan stops, check fuses immediately or heating element will overheat and burn out.

Heated Clothing

Electrically heated flying suits may be plugged in at all crew stations and in the bomb bay. Individual rheostats control temperature.

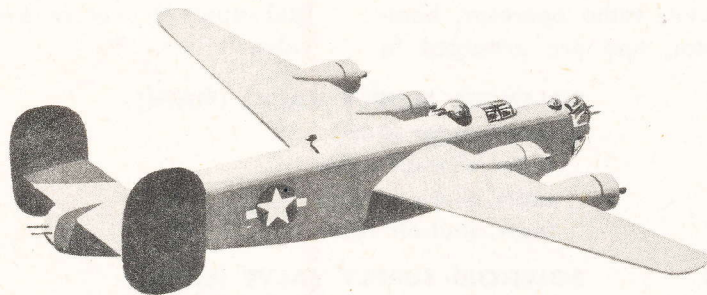

EXHAUST HEAT SYSTEM IN LATE B-24'S

In some late series B-24's, heat exchangers in the engine exhausts provide heat for the cabin, for anti-icing of the wing and empennage leading edges, and for defrosting the windshields, nose turret, and top turret.

Cabin heat comes from the exhausts of the 2 inboard engines. Air temperature in the system is regulated automatically by a valve which admits cold air to the ducts when the temperature rises above pre-set limits. Controls for this heating system include switches on the pilot's control pedestal, manually operated registers in the duct outlets, and manually operated damper valves in the ducts themselves.

Heat for anti-icing the leading edges of the wing center section and the empennage also comes from the inboard engines; the outboard engines provide heat for anti-icing the outer panel leading edges and wingtips. Control switches are on the same panel as the cabin heat switches.

Aircraft with this heating system have double plate glass windshields. Warm air for defrosting, supplied through ducts from the main cabin system, is introduced between the 2 panes. The inner panes are removable, and there is stowage space for them on the left side of the radio compartment.

Operation

Usually only one cabin heat switch needs to be turned on. With either No. 2 or No. 3 switch on, you can increase heat for the cabin by turning the empennage anti-icing switch off if no icing conditions exist, thereby cutting off hot air flow to the tail and directing more heat to the cabin. **Caution:** Don't turn empennage switch off if **both** No. 2 and No. 3 switches are on.

To prevent formation of ice on wings, tail and windshields, turn on all cabin heat and anti-icing switches, including the empennage switch,

as soon as icing conditions are anticipated and before ice starts to form.

Use of Manually Operated Dampers

The damper controlling the 2 windshield ducts is over the forward end of the radio operator's table on the aft face of the armor plate behind the copilot's seat. Open this damper only to prevent formation of ice on the windshields.

The damper controlling the main heater duct on the lower left hand side of the cabin is on the forward bulkhead of the left hand bomb bay, near the top. The damper for the right hand main cabin heater duct is on the aft bulkhead of the radio operator's compartment near the floor on the right side. Don't close these dampers except to divert more hot air to windshield defrosters. Control cabin heat exclusively with the outlet registers and with No. 2 and No. 3 switches.

The damper which regulates the top turret defroster is on the aft bulkhead of the radio operator's compartment, above the right hand main duct damper. Don't open the defroster damper except to defrost top turret or compartment side windows.

Dampers for the ducts in the bombardier's compartment are on the forward end of the copilot's duct, in the nose compartment near navigator's table. Don't open these dampers except when necessary.

Important

A warning light on the pilot's pedestal will indicate the presence of carbon monoxide in the cabin air if one of the heat exchangers should leak. A button near the warning light re-sets the warning light relay when the danger of carbon monoxide is ended. Turn off cabin heat switches (either No. 2 or No. 3) immediately if the warning light goes on. Don't use the cabin heat system unless the monoxide detector is installed and known to be working properly.

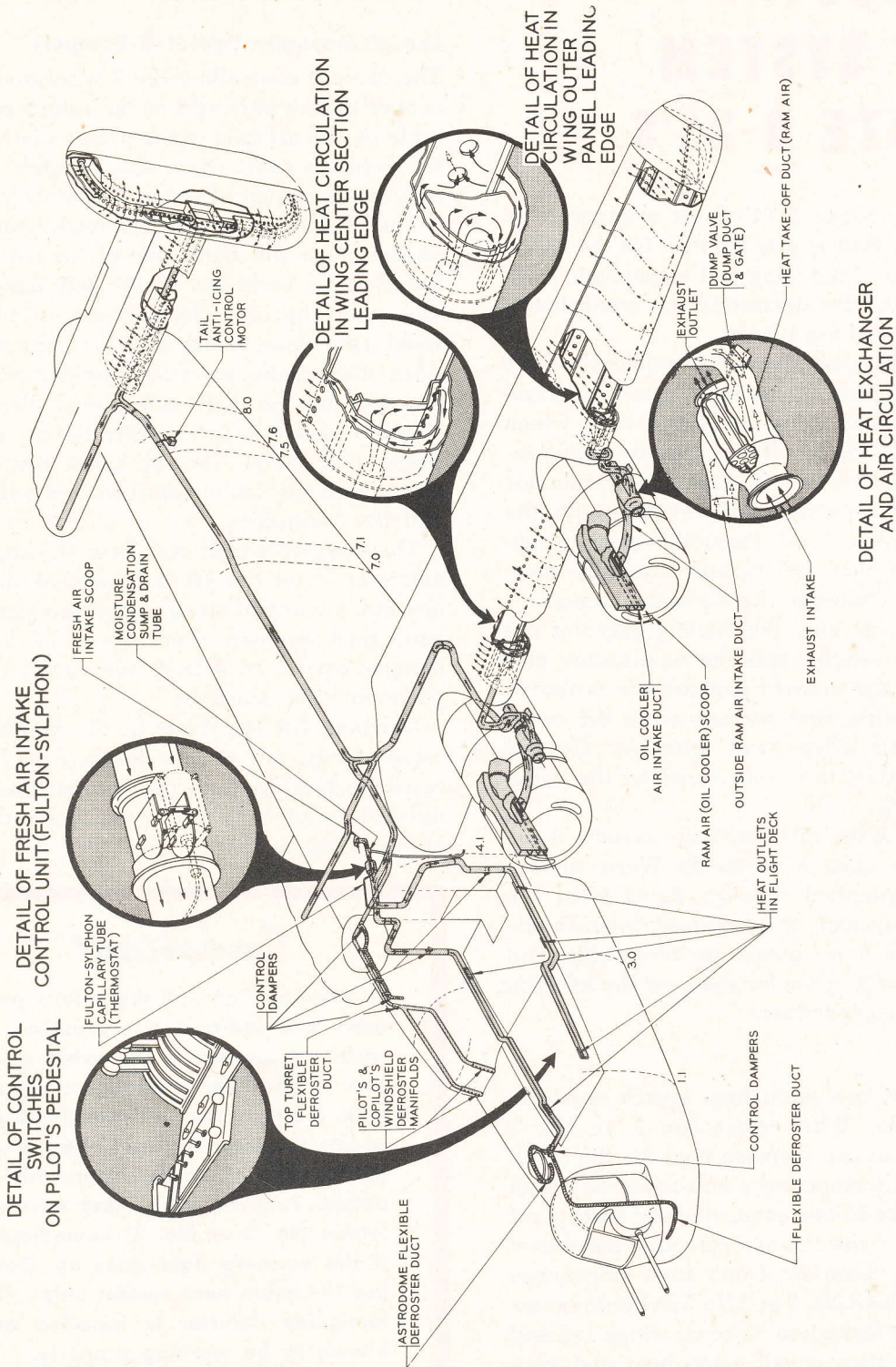

EXHAUST HEAT SYSTEM IN SOME LATE B-24'S

DETAIL OF HEAT EXCHANGER AND AIR CIRCULATION

ANTI-ICERS, DE-ICERS AND DEFROSTERS

The problem of icing and weather flying is too big a subject for this book, which is restricted in its scope to specific problems of the B-24. That does not relieve the B-24 pilot of the obligation to know weather flying and to know icing problems before attempting flights in which he may have to use his anti-icing and de-icing equipment. Intelligent use of anti-icing and de-icing equipment requires knowledge of the various kinds of ice, when to stay at your altitude, when to ascend and when to descend, and the circumstances under which your plane is likely to ice up. You'll find information on this subject in P. I. F., under "Cold Weather Operation" in the T. O. for the B-24, in "Instrument Flying in Weather," and in training films. Don't miss an opportunity to learn all you can about icing and weather flying. In certain theaters much larger losses are charged to weather than to enemy action. Your gunners can't drive off the weather.

Warning: The pilot who takes off without complete information on icing levels, relative saturation, and the probability of encountering ice is his own worst enemy. The sky makes no allowances for incompetence. If you can't read the weather charts, ask the weather officer. The government pays him a salary for answering your questions.

Remember that the weather that usually comes with ice brings other distraction: static noises, strong possibility of intermittent radio failure, increased fuel consumption under an icing load, and instrument flying conditions. You get uneasy and want to descend or mill around and lose your way. Usually it is better either to do a 180° turn or fly out your ETA if you have adequate fuel. Don't get panicky. Know your weather and know your icing equipment.

RESTRICTED

Anti-icers and De-icers Distinguished

Distinguish between these 2 types of equipment. One will prevent icing but has very limited or no effect in removing ice. The other will remove ice. Anti-icers should be started **before** ice forms. De-icers are more effective **after** ice has formed hard enough so it will crack off.

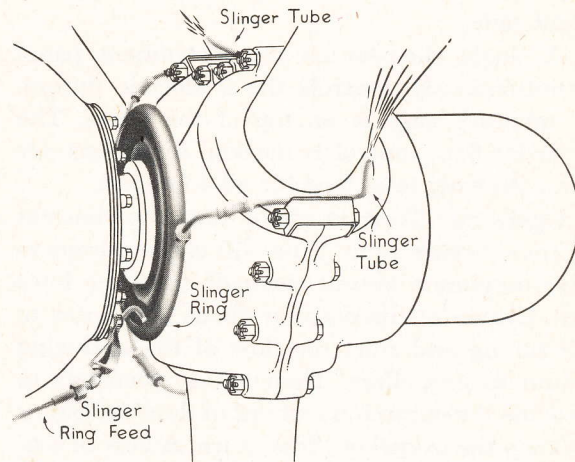

SLINGER RING DETAIL

Propeller Anti-Icing System

It is most important to anticipate propeller icing by knowing the condition of the atmosphere you are flying through. Remember this is anti-icing equipment. Slinger rings distribute fluid to spread a protective film over the blades so ice won't form. The film will keep ice off when it won't take it off. Therefore, anticipate ice.

You can tell the propellers are icing up if you note spotty discoloration on them or if small pieces of ice are thrown off against the fuselage. Immediately increase the flow of fluid enough to stop further icing. But keep in mind the probable length of time you will need propeller anti-icing and conserve fluid accordingly.

Equipment

Ice prevention fluid, isopropyl alcohol, is supplied to the slinger rings on each propeller by 2 pumps taking suction from a reservoir tank. On early airplanes this is a 6-gallon tank located

under the flight deck and can be filled in flight. On later airplanes it is a 21-gallon tank located on the half deck, refillable only from outside the fuselage. Plug valves, normally safetied open, permit shut-off from tank to either pump. Valves are located directly under the 6-gallon tank, and on the 21-gallon tank installation shut-off valves are located on the aft face of bulkhead at Station 4.1 high in the bomb bay, right side.

A single rheostat on the instrument panel simultaneously controls the 2 electric pumps. A quantity gage is on top of the tanks. The rheostat flow control is marked in gallons per hour showing total flow for all 4 engines.

Operation: To start motor turn the rheostat to the extreme right. This will cause pumps to give maximum output and will clean the lines out. Leave in this position about 2 minutes to fill tubing and start the flow of the anti-icing liquid to propellers. Then adjust rheostats to provide the minimum amount of fluid necessary to keep the propellers free of ice. A flow of 1 to 2 gallons per hour will take care of light to moderate ice.

Wing and Empennage De-icing: You can see the ice forming on wing leading edges. Usually it will start as a narrow white line along the center of the de-icing boot and gradually widen. Avoid using boots until ice is hard enough to crack off as the boots inflate. Don't allow ice to build back beyond the effective boot area, or when boots crack it loose a sharp edge of ice will remain at the edge of the boot. Then additional ice will build on this, creating burble and destroying lift. The B-24 will carry a good load of ice if necessary, but remember you are supported by a highly efficient wing. Anything that disturbs its normal lift characteristics is not good.

Normally rime ice and clear ice will crack off immediately when the de-icer boots start to operate. However, you may encounter ice which seems rubber-like; it will appear to stretch instead of crack when the boot starts to operate. Watch closely. If the ice doesn't crack as the boots start to operate, turn de-icers off and wait for the ice to harden; otherwise a hollow space will be formed beneath the ice and

boots will inflate without removing it. It is important to know exactly how de-icing equipment works.

Equipment: De-icing is accomplished by rubber shoes on leading edges of wings and stabilizer. The pressure side of engine-operated vacuum pumps on engine No. 1 and engine No. 2 furnish air for inflation. The suction side of either pump furnishes suction for deflation; the suction side of the other pump furnishes suction for the vacuum-operated instruments.

In case of failure of either pump, the remaining pump will furnish sufficient pressure for inflation. In such an emergency, be sure that the vacuum selector valve handle, on the forward face of Station 4.1, is set so that the instruments receive the vacuum from the pump which is operating. This means that the boots will have to depend on external air pressure for deflation.

A horizontal lever on the copilot's panel is cable-connected to a control valve high on the front spar in the bomb bay. Until this valve is opened, the pressure from both pumps escapes overboard and the suction from one engine pump keeps the boots deflated. When the valve is opened, pressure is distributed to and inflates the boots in a set order of sequence. In case the cable between the control lever and the valve in the bomb bay should break or become disconnected, valve in the bomb bay can be moved by hand to operate boots. A suction gage on pilot's panel shows vacuum level in system for instruments only. It gives no indication of de-icer suction.

Windshield Anti-icing System: Some B-24 airplanes are equipped with hand pumps which force a spray of isopropyl alcohol on the windshields to prevent ice formation. On these installations, 2 separate tubes from the reservoir deliver fluid, one to the copilot's hand pump, outboard of his seat, and the other to the bombardier's hand pump on the right side of his windshield. Two positions, **left** and **right**, are indicated on the copilot's hand pump to direct the fluid, as desired, to either pilot's windshield. This selection is made by pressing the handle **down**. Note that this is an anti-icing fluid. Use as the first suspicion of windshield icing when

ice starts to form in the corners of windshield. It is lots easier to keep ice from forming than to get rid of it. The film deposited by the fluid keeps ice from forming.

Defrosters: The bombardier's and pilots' heaters are fitted with flexible defroster ducts to direct warm air to bombardier's sighting window and to pilots' windshields. On some aircraft the navigator's heater is similarly equipped for defrosting the astrodome. On the pilots' heaters, push-pull Ahrens controls on instrument panel; and on the bombardier's and navigator's heaters, hand operated shutters, permit use of heaters for heating or for defrosting.

Pitot Heater: Your airspeed indicator reacts to the pressure of incoming air in the pitot tubes. If moisture gets in the tube and freezes, or forms over the outside, your airspeed will appear to be falling off rapidly when in reality it is the same as before.

Your first thought before entering clouds

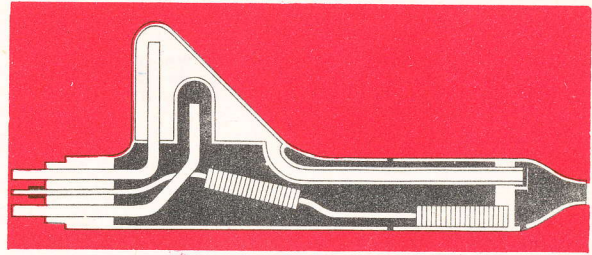

DIAGRAM OF PITOT TUBE HEATER

should be to turn on your pitot heaters, especially when the temperature is near 0°C . This will keep ice from forming. Warm, wet air can also block off your airspeed indication during a heavy rain. Use the pitot heater. Pilots have been known to keep adding more and more power trying to maintain altitude and airspeed, flying for several hours at dangerously high power, when nothing was wrong except a little ice in the pitot head.

OXYGEN SYSTEM

There are 2 types of oxygen supply systems in use: The constant flow and the demand system.

Constant Flow—On ships up to 42-40217 inclusive.

This type uses either A8 or A8-A masks. The mask connects to the regulator with a long, slender hose. Small leaks around the mask are relatively unimportant in this type because of the constant flow of oxygen from the tank through the regulator. With this steady flow the length of the hose is immaterial, as no air cushion can back up in the hose to the regulator.

Demand System—On No. 42-40218 and subsequent airplanes.

This type uses either A9, A10, A10-R, or B14 masks. The mask connects to the regulator by a short, stubby hose. This system provides the proper amount of oxygen at any altitude.

Operational Precautions

Before Flight:

1. Check pressure in oxygen cylinders. Cylinders should be filled to 450 lb. sq. in.; their pressure will drop to approximately 400 lb. sq. in. when they cool.
2. Check flow of oxygen through regulators and masks. Wherever possible, have oxygen officer on ground check equipment.
3. Be certain hose is tight at regulator outlet collar.
4. Be certain male end of rapid disconnect fitting rubber gasket is in place.
5. Mask should fit airtight, and when so fitted it should be worn only by the individual for whom it was adjusted.
6. Clip hose, by means of the spring clip, to

clothing or to parachute harness, not too far below chin.

7. Check pressure gage.

During Flight:

1. To check oxygen flow to mask from regulator in the constant-flow type pinch hose lightly several times. A hiss will indicate that oxygen is flowing.

2. At altitudes over 34,000 feet the reservoir bag in the constant flow should not collapse. This can be checked by holding hand loosely around reservoir bag while **breathing normally**. Quick or deep breaths will collapse bag. Be careful not to collapse bag while making this check.

3. Type A8 and A8-A masks can be freed of ice formation by squeezing air outlets on cheeks in mask.

4. In **demand system**, watch the flow indicator to make sure you are getting oxygen.

After Flight:

1. Wipe mask dry, or if possible, wash with soap and water and dry thoroughly.
2. Do not lend your mask, as strap adjustments may be altered by someone else.
3. Inspect for cracks and leaks in face piece.

Safety Measures:

1. Normally, **keep** the regulator on the demand system with the auto-mix turned "ON."
2. Use oxygen on all flights above 10,000 feet.
3. Each crew member should have available one **walk-around** bottle. The bottle should be tested before the airplane leaves the ground. If it is necessary for a crew member to leave his station the bottle can be quickly attached to the oxygen mask. The bottle can be refilled from the ship's regular supply.
4. Memorize location of bailout bottles. These bottles are used, when abandoning ship, as an oxygen supply until reaching an altitude where oxygen is not necessary.
5. In night flying use oxygen all the time to preserve maximum efficiency of night vision.

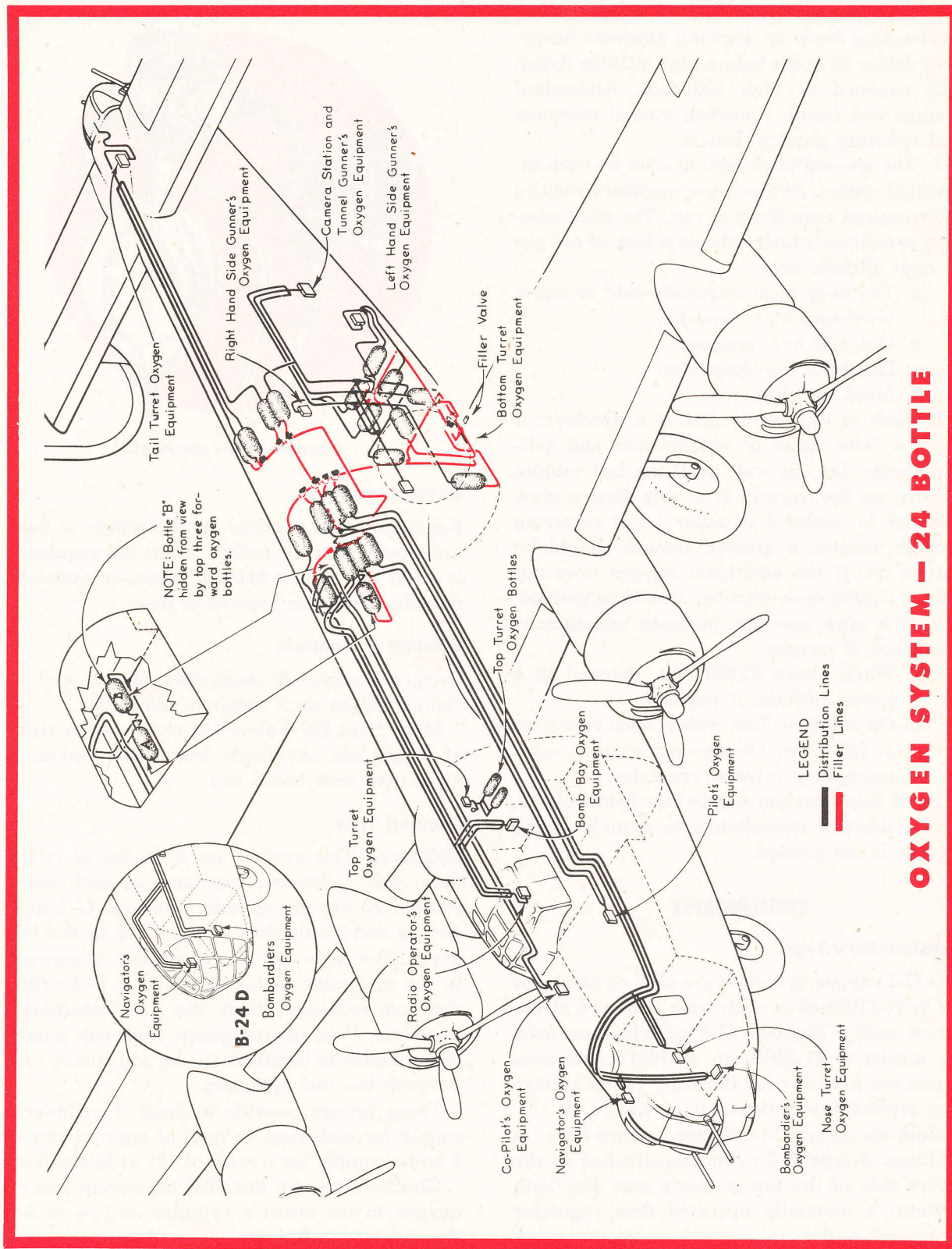

OXYGEN SYSTEM - 24 BOTTLE

RESTRICTED

6. Crew members are warned against eating gas-forming foods or drinking alcoholic beverages within 24 hours before high altitude flying. Gas expands at high altitudes. Abdominal cramps will result, retarding mental alertness and reducing physical fitness.

7. The amount of oxygen needed by each individual varies. Active crew members require more oxygen than those at rest. The most common symptoms which indicate a lack of oxygen at high altitude are:

- a. The body feels extremely cold or warm (sweating may occur).
- b. Unusual exhilaration.
- c. Lassitude and sleepiness.
- d. Mind not alert.

8. Lack of oxygen at first is a deceiver; it gives a false sense of exhilaration and self-confidence. Do not wait until the last minute to turn on the oxygen. If at any time a crew member is doubtful whether he is receiving enough oxygen, a greater amount should be turned on. If the additional oxygen does not help, a nearby crew member should be notified.

9. If a crew member becomes unconscious from lack of oxygen:

- a. When above 25,000 feet, descend to a lower altitude, if possible.
- b. On constant-flow system open regulator to full flow. On demand system, open emergency valve on regulator.

10. If ship's oxygen supply falls below 100 lb. sq. in., descend immediately to altitude where oxygen is not needed.

EQUIPMENT

Constant-Flow Type

Ten G-1 oxygen cylinders are used on airplanes up to 41-11938 (5 in each wing outboard of the wheel wells). Eighteen G-1 cylinders are used on airplanes 41-23640 to 42-40217 inclusive. These are located over the wing center section and around the bottom turret well.

Both the 10 and 18-cylinder systems have, in addition, 2 type D-2 cylinders attached to the under side of the top gunner's seat. For both systems a manually operated flow regulator is at each outlet.

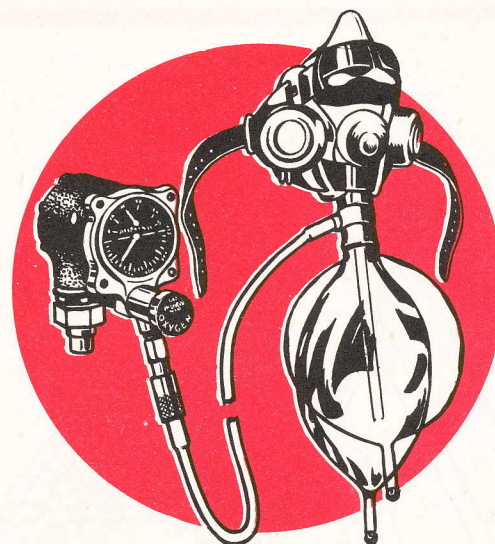

Constant-flow Type Mask

Oxygen Indicators

Regulator dials marked in thousands of feet are located at each outlet. When the regulator is set at the correct flying altitude, an attached flow dial indicates amount of flow.

Location of Controls

Oxygen Outlets—At each crew station and at right of flight deck hatch in bomb bay.

Main Shut-Off Valve—On rear spar to right of center line. Available from radio compartment over rear bomb bay.

Demand Type

Cylinders—This system has 9 groups of cylinders with a demand regulator at each crew station: 22 oxygen cylinders of type G-1 in 8 groups and 2 cylinders of type D-2 in the 9th group. The latter, for the top gunner, is secured to the underside of his seat. The 2 D-2 cylinders are recharged from the radio operator's main line, or in an emergency, from any group. One adapter is installed on the top turret line between the two cylinders.

These groups provide at least 2 cylinders' supply for each man (a total of approximately 9 hours' supply for a crew of 10) at 30,000 feet.

Check valves are installed to prevent loss of oxygen in the event a cylinder or line is destroyed by gunfire.

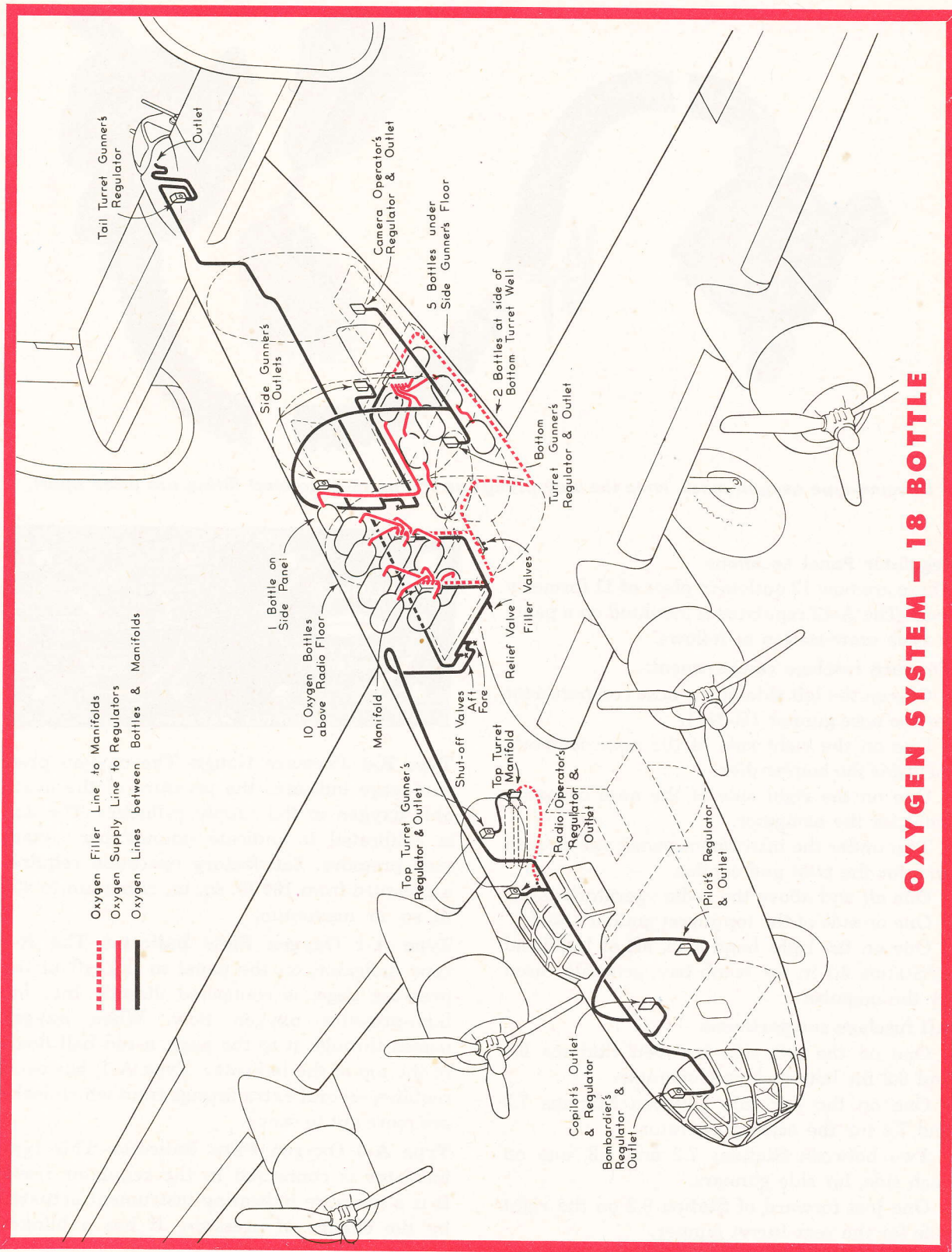

OXYGEN SYSTEM — 18 BOTTLE

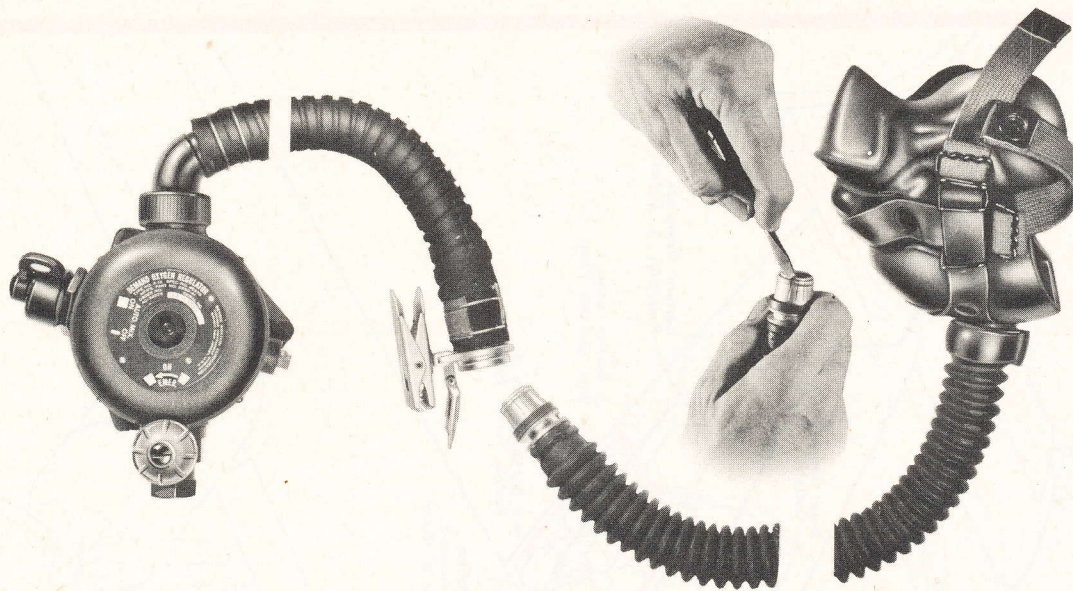

Demand-type oxygen mask. Note the way prongs on the quick-disconnect fitting are pried apart.

Regulator Panel Locations

There are now 13 outlets in place of 11 formerly used. The A-12 regulator is mounted on a panel at each crew station as follows:

Forward fuselage compartment:

- One on the left side of the nose compartment for the nose gunner (B-24J).
- One on the right side of the nose compartment for the bombardier.
- One on the right side of the nose compartment for the navigator.
- Two under the instrument panel, one at each end, for the pilot and copilot.
- One aft and above the radio operator's table.
- One on side of the top turret gunner's seat.
- One on the right hand side, aft of bulkhead at Station 4.1 in the bomb bay, generally used by the engineer.

Aft fuselage compartment:

- One on the left side between Stations 6.1 and 6.2 for bottom turret operator.
- One on the left side between Stations 7.3 and 7.4 for the camera operator.
- Two between Stations 7.2 and 7.3, one on each side, for side gunners.
- One just forward of Station 9.2 on the right side for the rear turret gunner.



Type K-1 Pressure Gauge—The oxygen pressure gage indicates the pressure of the available oxygen in the supply cylinders. The dial is calibrated to indicate pounds per square inch pressure. Satisfactory operation requires a pressure from 100 lb. sq. in. minimum to 450 lb. sq. in. maximum.

Type A-1 Oxygen Flow Indicator—The A-1 type indicator, on the panel to the left of the pressure gage, is connected directly into the high-pressure oxygen flow. When oxygen passes through it to the gage, a red ball floats to the top of the indicator. Type A-1, however, requires several extra fittings from which leaks are more apt to occur.

Type A-3 Oxygen Flow Indicator—This type indicator is connected to the regulator itself. It is a pressure indicating instrument actuated by the change of pressure. It has a blinker

which opens when the person wearing the mask inhales. The A-3 indicator is in use on airplane 42-72765 and subsequent ships.

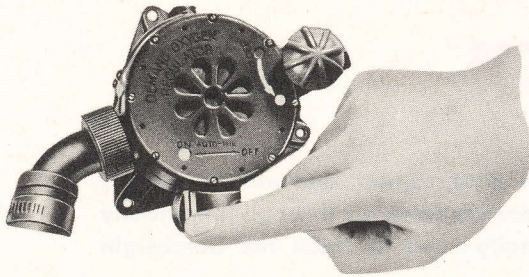

Moving the valve lever to the Auto-Mix "ON" position.

Type A-12 Regulator—The A-12 regulator (Pioneer Type 2850-A1) has been developed for use in high altitude flying and automatically delivers the proper mixture of air and oxygen to sustain life in the sub-stratosphere. It conserves the available supply of oxygen by furnishing only the amount of oxygen needed at any altitude. The regulator consists of the following mechanisms:

A manual valve shuts off the air when a flow of pure oxygen is required. The valve is operated by a lever on the side of the case and is marked Auto-Mix "ON" and "OFF." (Regulators of recent issue may be marked "NORMAL OXYGEN" instead of "ON," and "100% OXYGEN" instead of "OFF.")

Note: The "ON" ("NORMAL OXYGEN") position is used for normal flying operation.

A bypass manually operated emergency valve on the oxygen intake, at the bottom of the regulator, permits a steady flow of oxygen when needed.

A pressure reducer controls the oxygen tank pressure to about 40-60 lb. sq. in. so that the action of the demand valve is unaffected by changes of the tank pressure. A check valve on the air inlet prevents the escape of oxygen when exhaling.

System Filler Valve—The system filler valve is located on the outside of the airplane (left lower side) between Stations 6.1 and 6.2, and the whole system can be filled through this intake valve. It is in a closed box behind a cover plate door in the skin, free from contact with oil, grease, or foreign matter.

Caution: Because there is no oxygen system filler relief valve, under no circumstances should the A-12 regulator be installed on an oxygen cylinder of greater than 500 lb. sq. in. capacity.

Two adapters are installed in a stowage bag attached on the inside of the plate door. One adapter is used for charging the system with British equipment, the other when using American equipment. A card provides instructions for filling the system and for the correct use of the adapters.

Top Turret Filler Valve—A new shield has been installed over the filler valve of the top turret oxygen tanks. This shield is made of metal; a small plate giving filling instructions is on the end. The location of the turret guns above this valve constitutes a definite hazard unless protection against the possibility of excess oil and grease from the guns coming in contact with the valve is provided. This change took place on airplane No. 42-40786 and subsequent aircraft.

Warning

Under no conditions allow any oil or grease to come in contact with any oxygen equipment.

Carbon Monoxide

Some recent B-24's have a red warning light on the instrument panel to indicate the presence of carbon monoxide in the cabin. (See Exhaust Heating, Page 149.) If this warning light goes on, protection against the carbon monoxide can be gained in one of two ways: By turning off the heater, and thus removing the source of the gas, or by having all crew members don their oxygen masks, with the Auto-Mix turned to the "OFF" ("100% OXYGEN") position. Temperature or other factors may make turning off the heater inadvisable, but the use of pure oxygen is a sure safeguard against atmospheric contamination.

VENTILATING SYSTEM

Special ventilation is provided only for the pilot, copilot, and radio operator.

In early model airplanes the bombardier receives fresh air through a manually rotated slotted disc in the hand hole normally used to clean the bombsight window.

The pilot and copilot receive a direct blast of fresh air through ducts connected to the left and right pitot-static tubes respectively. Manually rotated ball and socket ventilators, at the outboard ends of the instrument panel, control fresh air supply.

The flight compartment receives fresh air through an intake duct through a "Y" to manually controlled anemostat diffusers high on the fuselage, right and left at Station 3.2.

