

*PILOT'S FLIGHT OPERATING  
INSTRUCTIONS*

FOR

ARMY MODELS

**B-26B-1 and -26C**

BRITISH MODEL

**MARAUDER II**

AIRPLANES

This publication contains specific instructions for pilots and should be available for Transition Flying Training as contemplated in AAF Reg. 50-16.

This publication shall not be carried in aircraft on combat missions or when there is a reasonable chance of its falling into the hands of the enemy.

*Published under joint authority of the Commanding General, Army Air Forces, the Chief of the Bureau of Aeronautics, and the Air Council of the United Kingdom.*

**NOTICE:** *This document contains information affecting the national defense of the United States within the meaning of the Espionage Act, 50 U. S. C., 31 and 32, as amended. Its transmission or the revelation of its contents in any manner to an unauthorized person is prohibited by law.*

## TABLE OF CONTENTS

<i>Section</i>	<i>Page</i>	<i>Section</i>	<i>Page</i>
I Description	1	III Flight Operating Data	53
1. Airplane	1	1. General	53
2. Movement of Flight Personnel	34	2. Airspeed Installation Correction Table	54
II Pilot Operating Instructions	35	3. Airspeed Limitations	54
1. Flight Restrictions	35	4. Weight and Balance Data	54
2. Before Entering Pilot's Compartment	35	5. Power Plant Chart	54
3. On Entering Pilot's Compartment	35	IV Emergency Operating Instructions	57
4. Fuel System Management	43	1. Pilot's Emergency Controls and Equipment	57
5. Auxiliary Power Plant	44	2. Pilot's Emergency Check List	58
6. Starting Engines	45	3. Emergency Exit in Flight	61
7. Engine Warm-up and Accessory Check	46	4. Ditching (Forced Landing at Sea)	63
8. Emergency Take-off	47	5. Emergency Exit on Ground	63
9. Engine and Accessories Operation Ground Test	47	V Operational Equipment	65
10. Taxiing Instructions	48	1. Radio Operator's Compartment	65
11. Take-off	49	2. Navigator's Compartment	67
12. Engine Failure	49	3. Bombardier's Compartment	68
13. After Take-off	49	4. Waist Gun and Camera Compartment	72
14. Climb	49	5. Pilot's Radio Equipment	72
15. During Flights	49	6. Co-Pilot's Radio Equipment	74
16. General Flying Characteristics	50	7. Pilot's Armament Controls	74
17. Stalls	50	8. Martin Power Turret	74
18. Spins	50	9. Tail Gun Compartment	77
19. Acrobatics	50	<i>Appendix</i>	<i>Page</i>
20. Diving	50	I Glossary of Nomenclature	79
21. Night Flying	50	II Flight Operating Charts, Tables, Curves and Diagrams	81
22. Approach and Landing	50	1. Introduction	81
23. Stopping of Engines	51	2. Take-off, Climb, and Landing Chart	81
24. Control Locks	51	3. Flight Operation Instruction Charts	81
25. Safety Precautions	52	4. More Miles Per Gallon	83
		5. Fuel Tank Calibration	94



RESTRICTED



RESTRICTED  
AN 01-35EB-1

Figure 1 —  $\frac{3}{4}$  Rear View of Airplane

## SECTION I DESCRIPTION

### 1. AIRPLANE. (See figure 1.)

*a. GENERAL.*—This twin-engine, high wing monoplane of all metal construction is called the B-26B-1 and C by the Army Air Forces. Also known as the Martin Marauder, it is a high speed medium bomber equipped with Pratt & Whitney 2000 horsepower radial engines. The electrically controlled four-bladed propellers are full-feathering and are fitted with cuffs to assist in the distribution of air to the cylinders. The tricycle landing gear is retracted snugly into the nose and engine nacelles during flight.

*b. ACCESS.*—Access to the forward compartments is gained through the pilot's entrance hatch in the nose wheel well. Occupants of the tail section enter through either of the side hatches in the waist compartment. A heavy girder connects the forward and aft compartments, serving as a support for the bomb racks, also as a catwalk for inter-communication.

*c. ARRANGEMENT.*—Places for a normal crew of five are afforded in the cigar-shaped fuselage. In combat the bombardier is stationed in the transparent nose; immediately aft sit the pilot and co-pilot, while in the compartment behind is space for the radio operator and navigator. Bombs are carried in the forward and aft bomb bays, which occupy the center portion of the fuselage. In the tail section are the Martin power turret, two waist gun positions, a tail gun station and a camera mount.

*d. CONTROLS AND EQUIPMENT.*—Controls for release of bombs carried in standard Air Corps shackles, centralized in the bombardier's compartment, are supplemented by an emergency salvo release from the pilot's compartment. Bomb bay doors, landing gear, brakes, wing flaps, cowl flaps, and oil cooler shutters, all hydraulically operated, are controlled by conveniently located levers. Electric power is used to operate the constant-speed propellers, the autosyn, and selsyn instruments. Crew members inter-communicate through an interphone system with 10 stations strategically located throughout the airplane. Standard rubber boots de-ice the leading edges and anti-icing fluid is pumped to the propellers, carburetors, and windshields by small electric pumps.

### *e. GUNNERY EQUIPMENT.*

(1) *GENERAL.*—The airplane is equipped with 12 .50-caliber M-2 machine guns. One flexible machine gun mounted in the nose, two in the waist compartment, and two in the tail gun compartment are aimed and fired locally. A two-gun upper turret is installed just forward of the fin. Four fixed belly guns and one fixed gun in the nose are fired by switches in the pilot's compartment.

(*a*) *FLEXIBLE NOSE GUN.*—The flexible nose gun, supported by a ball and socket, is balanced by a bungee support at the aft end. Ammunition, loaded points-up, is fed directly from a box in the transparent nose which contains 135 rounds. The spare ammunition box also holds 135 rounds. A canvas bag attached to the gun collects cases and links. The gun is stowed by hanging the spade grips on a bracket at the left side of the enclosure. The gun can be cleaned in position.

(*b*) *WAIST GUNS.* — Two flexible guns, mounted on specially designed yokes, are arranged to fire out of side windows in the waist compartment. Ammunition, loaded points-outboard, is fed through flexible track from two 240-round boxes above the guns. Cases and links fall through the window or on the floor. The guns are stowed by placing the barrels in clips at the aft side of each window.

(*c*) *TAIL GUNS.*—The flexible tail guns are mounted side by side in a special adapter. Collapsible charging handles permit a wider angle of fire. Ammunition is fed points-up through tracks from 800-round stowage boxes, one on each side aft of the bomb bay. Automatic electric booster motors, one for each gun, supply a constant stream of ammunition. A canvas bag on the aft bulkhead collects cases and links and carries them overboard. The guns can be cleaned in position. Some aircraft have the Bell ball tail turret. See section V, paragraph 9.

(*d*) *MARTIN POWER TURRET.*—Two guns are mounted in the specially designed Martin power turret. Description and operating instructions for the turret may be found in section V, paragraph 8.

(e) **FIXED GUNS.**—The four fixed belly guns and the single fixed nose gun are fired from the pilot's compartment. All five guns fire forward. The ammunition supply for the fixed nose gun is carried under the bombardier's seat in a 200-round box. The ammunition is loaded points-outboard and is fed to the left side of the gun over rollers. Cable controls for charging and emergency manual firing are carried back to the co-pilot's compartment. The four fixed belly guns installed under the radio operator's and navigator's compartment are enclosed in separate faired envelopes. The ammunition supply is carried under the radio operator's and navigator's tables and is fed to each gun through a short length of flexible track, 250 rounds are provided for each of the upper guns and 200 rounds each for the lower guns. Cases and links are ejected directly into the airstream. A charging cable for each gun is brought in to handles beside the radio operator's and navigator's seats. The guns can be cleaned in position after removing the charging cable pulley brackets.

(f) **GUN HEATERS.**—Outlets and wiring are provided for electric gun heaters for fixed nose gun, flexible nose gun, four side package guns, two side waist guns, two deck and two tail turret guns. Warm air heating is also provided for the two tail guns. These electric gun heaters operate on 24 volts ac or dc 100 to 108 watts.

*f. FUEL TRANSFER SYSTEM. (See figure 2.)*

(1) **GENERAL.**—Fuel is transferred through a selector valve from the auxiliary wing and bomb bay tanks to the main tanks by a reversible electric pump. Two selector handles with dial markings for each tank are mounted on the inboard side of the selector valve. (See figure 2.) It is possible to transfer fuel from any tank indicated on one dial to any tank indicated on the other, or to transfer fuel between two tanks indicated on the same dial by first pumping into an intermediate tank. The direction of fuel flow is determined by the setting of the three-piston transfer pump switch. The switch is pushed forward to pump from tanks indicated on the aft dial to tanks indicated on the forward dial, and pushed aft to reverse the flow. The switch must be turned "OFF" immediately when the warning light glows, denoting that the tank from which fuel is being pumped has been emptied. The pilot's fuel gage should also be constantly checked.

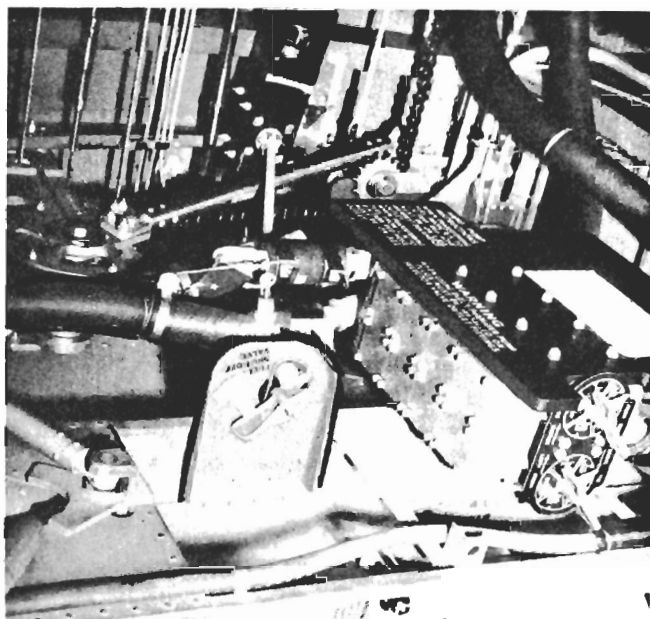

Figure 2 — Fuel Transfer System

(2) **EMERGENCY.**—If the electric transfer pump is inoperative, fuel may be transferred with the hand pump. Hose lines from the hand pump to the fuel selector valve, normally disconnected, are hung from outlet fittings under the selector valve. After connection of the hose lines to the hand pump, the selector handles are turned to the tank to be emptied and to the tank to be filled, and pressure is supplied by hand pumping.

*g. AUXILIARY POWER PLANT. (See figure 3.)*—The auxiliary power plant, stowed in the waist compartment, provides an output of 70 amperes to boost the electrical energy for starting the engines. It is a self-contained unit consisting of a 28.5-volt, 2000-watt dc generator, coupled to a one-cylinder, four-cycle magneto ignition internal combustion engine.

*b. BOMBING EQUIPMENT.*

(1) **GENERAL.**—Installed in separate forward and aft bomb bays, the vertical bomb racks are designed for a variety of bomb loadings. Controls and equipment for arming and releasing the bombs, operated from the bombardier's compartment, consist of the following items:

(a) **INTERVALOMETER.** — The intervalometer automatically releases a number of bombs at intervals determined by the dial settings. The "SELECTIVE—TRAIN" switch connects the intervalometer for train release and disconnects it for selective release.

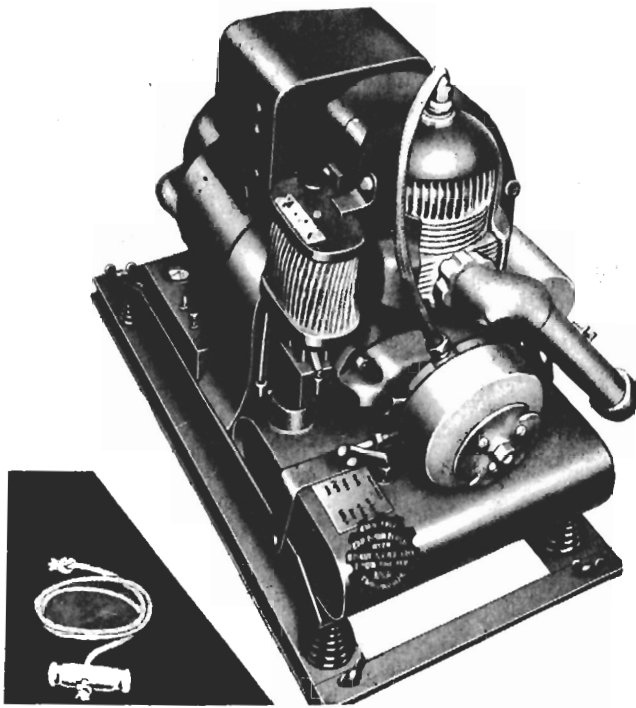

Figure 3 — Auxiliary Power Plant

(b) INDICATOR LIGHT PANEL.—The indicator light panel contains a small electric light for each pair of bomb bay doors and for each of the 30 bomb stations in the bomb bays. The nose fuse D4 switch is connected to the A-2 bomb arming units. The formation light switch controls the brilliancy of the red and white release formation lights.

(c) RACK SELECTOR UNIT.—The rack selector unit, controlled by two switches adjacent to the indicator light panel, determines the order in which bombs are released from the racks. The unit may be used in any desired combination.

(d) BOMBSIGHT.—The airplane is regularly equipped with the Estoppey D-8 bombsight, which is mounted on a bracket just aft of the sighting window. The bracket may also be adapted to mount the Norden M Series or the British Mark IX bombsights.

(e) BOMB BAY DOOR SELECTOR HANDLE.

—The bomb bay door selector handle has three separate functions. It is used to open the bomb bay doors hydraulically, to mechanically set the racks for electric release, or to mechanically salvo the bomb load.

(f) BOMB RELEASE TOGGLE SWITCHES.—

The bomb release toggle switches may be thrown in either direction to complete the electrical circuit direct to the release units for "SELECTIVE" release or through the intervalometer for "TRAIN" release.

(g) BOMB RACKS.—

Bombing equipment installed in the forward and aft bomb bays consists of six vertical racks containing a total of 30 bomb stations. Air Corps type B-7 shackles, A-2 release units and AX-2 auxiliary boxes make up a typical bomb station. The shackles incorporate release and arming arms which are enclosed by matching arms on the release units. The racks are marked with the size of bombs that can be carried at each station.

1. SELECTIVE FUSING.—To permit selective fusing, each of the 20 bomb stations in the forward bomb bay is equipped with an A-2 bomb arming unit, to which nose fusing wires may be attached.

2. ADAPTERS.—Special adapters for carrying 1600- or 2000-pound bombs in D-6 shackles are provided for installation in the forward bomb bay. When a load of heavy bombs is carried, the shackles should be removed and the release units either removed or uncocked at each unloaded bomb station. The AX-2 auxiliary boxes complete the electric circuit to the other bomb stations when the A-2 release units are removed.

3. SAFETY SWITCHES.—In order to prevent release of bombs until after the bomb bay doors have opened, safety switches are incorporated in the bomb bay door mechanism. The circuit from the bomb release toggle switches to the A-2 release units is completed only when the bomb bay doors are open.

(b) BOMB BAY DOOR NORMAL OPERATION. (See figure 4.)—The bomb bay doors are operated through a double unit hydraulic control valve connected by mechanical linkage to the bomb bay door selector handle in the bombardier's compartment. The bomb bay doors are opened together or independently by shifting the selector handle forward to "OPEN" position in either the "BOTH," "AFT," or "FORWARD" slots. The forward bomb bay doors are opened and closed by two double acting cylinders, one on each side of the airplane, which operate the door linkage through a chain and sprocket. The aft bomb

bay doors operate on the same principle but through only one double acting cylinder mounted on the centerline of the airplane. As the bomb bay doors open and close, the mechanical linkage passes over a dead center position. When "OPEN" or "CLOSED" position is reached, the doors are held in place by their own weight, as well as by the hydraulic pressure, and may be walked on safely. Later aircraft do not have aft bomb bays.

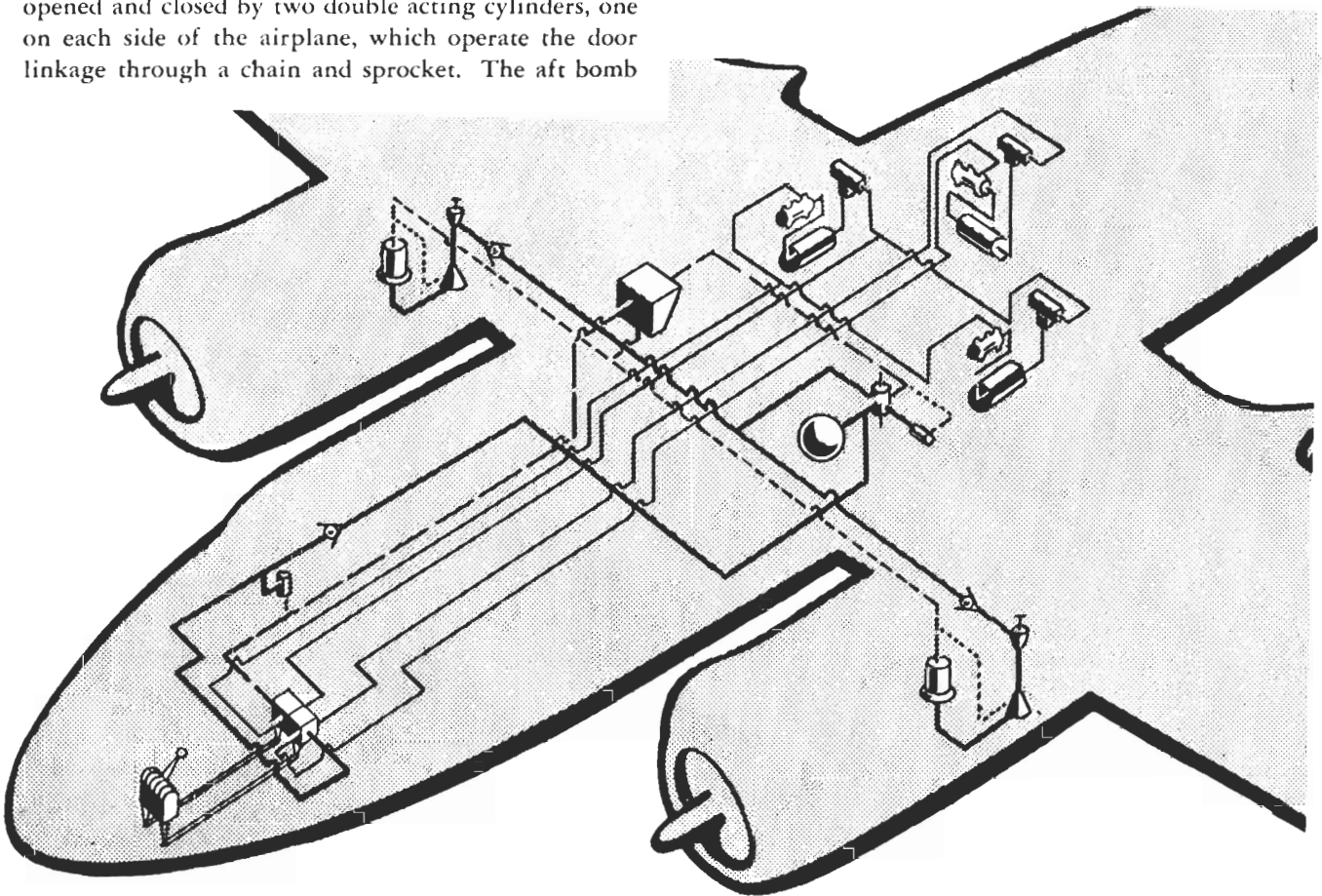



















 Reservoir 8.8 U.S. Gals.— 7.3 IMP. Gals.	 Accumulator	 Double Acting Cylinder
 Engine Driven Pump	 Pressure Relief Valve	 Control Head Valve
 Engine Pump Relief Valve	 Bomb Bay Door Selector Handle	 Push-Pull Rod
 Filter (Purolator)	 Double Unit Control Valve	 Main Pressure Line
 Check Valve	 Shuttle Valve	 Main Return Line
 Pressure Regulating Valve		 Suction Line
		 Relief Line
		 Operating Line

Figure 4 — Normal Operating System, Bomb Bay Doors

(i) BOMB BAY DOORS, EMERGENCY OPERATION. (See figure 5.)—The bomb bay doors may be operated by compressed air if there is insufficient pressure in the hydraulic lines. The emergency bomb release handle in the pilot's compartment is connected to an emergency air bottle in the aft bomb bay. When the release handle is pulled forward, air is released to the hydraulic bomb bay door operating cylinders at a pressure of 1000 pounds per square inch, for red stripe bottle and 1800 pounds per square inch for black stripe bottle, opening the doors. Cables attached to the doors open delayed action valves, by-passing the compressed

air to an air cylinder which salvoes the bombs through mechanical linkage with the racks. The bomb bay doors will stay open indefinitely if the release handle is hooked in open position or if the hydraulic pressure is low. Otherwise the air in the cylinders will be relieved and normal hydraulic pressure will close the doors. On some aircraft the bomb bay doors may be operated mechanically by a hand crank which raises the cables attached to the bomb hoist.



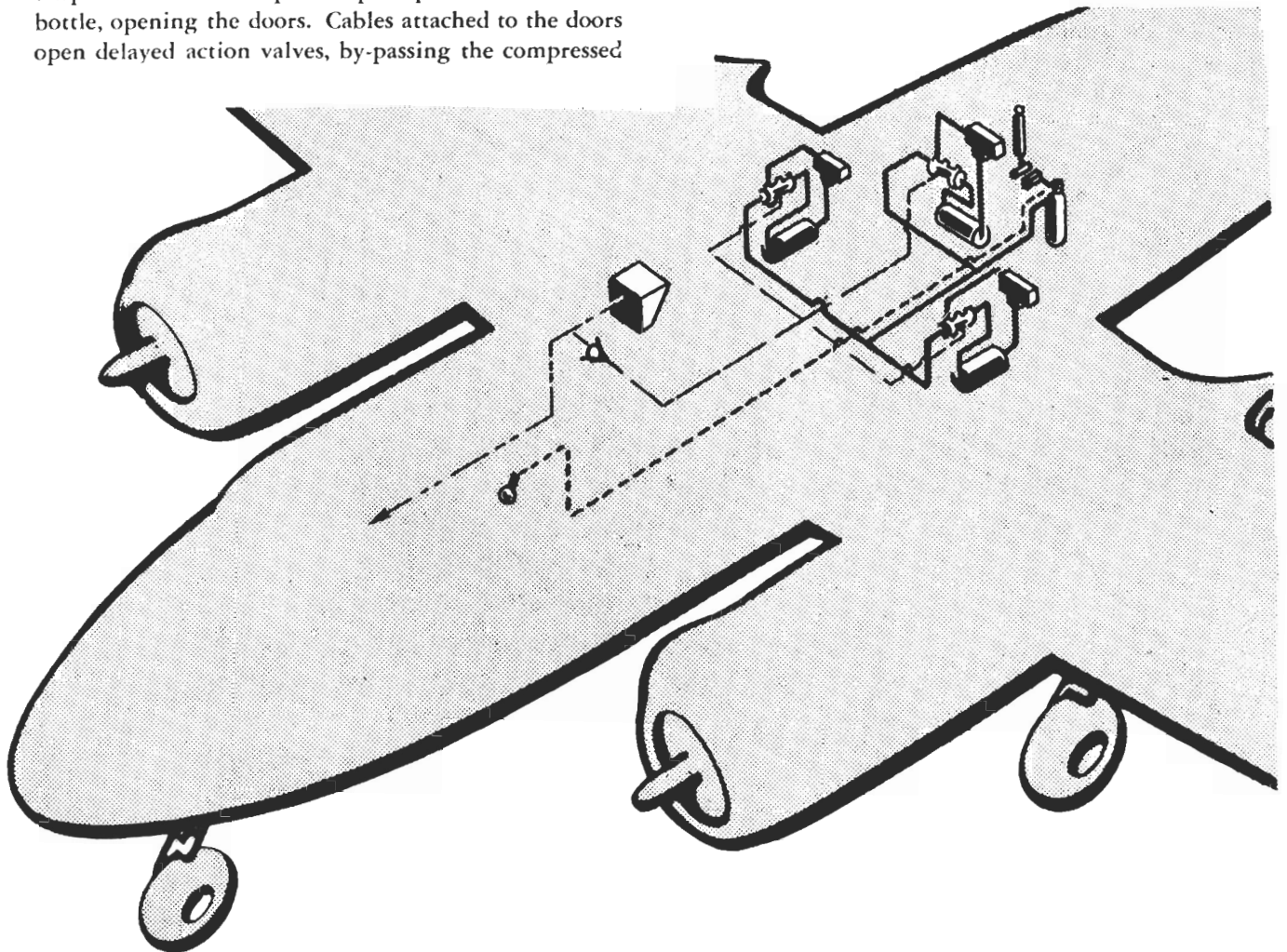













 Emergency Bomb Rel. Handle	 Double Acting Cylinder	 Air Vent Valve
 Air Bottle	 Check Valve	 Air Cylinder
 Control Head Valve	 Reservoir 8.8 U.S. Gals. 7.3 IMP. Gals.	 Control Cable
 Shuttle Valve	 Air-Disengaging Valve	 Operating Line
		 Main Return Line
		 Brake Return Line

Figure 5 — Emergency Operation, Bomb Bay Doors



(j) BOMB RELEASE. (See figures 6 and 7.)

1. GENERAL.—Bombs are released by pressing one of the bomb release toggle switches after the bomb bay door selector handle has been shifted forward from "OPEN" to "SELECTIVE" position. Movement of the selector handle from "OPEN" to "SELECTIVE" mechanically actuates slider bars on the bomb racks, setting the A-2 release units for "ARMED" release. When the bomb release toggle switches are pressed, the release arms open the bomb suspension hooks and the arming arms close the fuse wire hooks. The fuse wires are retained in the shackles and the bombs drop "ARMED."

a. SELECTIVE ARMING.—If nose fuse wires are attached to the A-2 bomb arming units, bombs may be selectively nose "ARMED" with the nose fuse D4 switch.

b. ADAPTERS.—1600- or 2000-pound bombs are released from the D-6 shackle by the bomb release toggle switches after the bomb bay door selector handle has been shifted forward from "OPEN" to "SELECTIVE" and the nose fuse D4 switch has

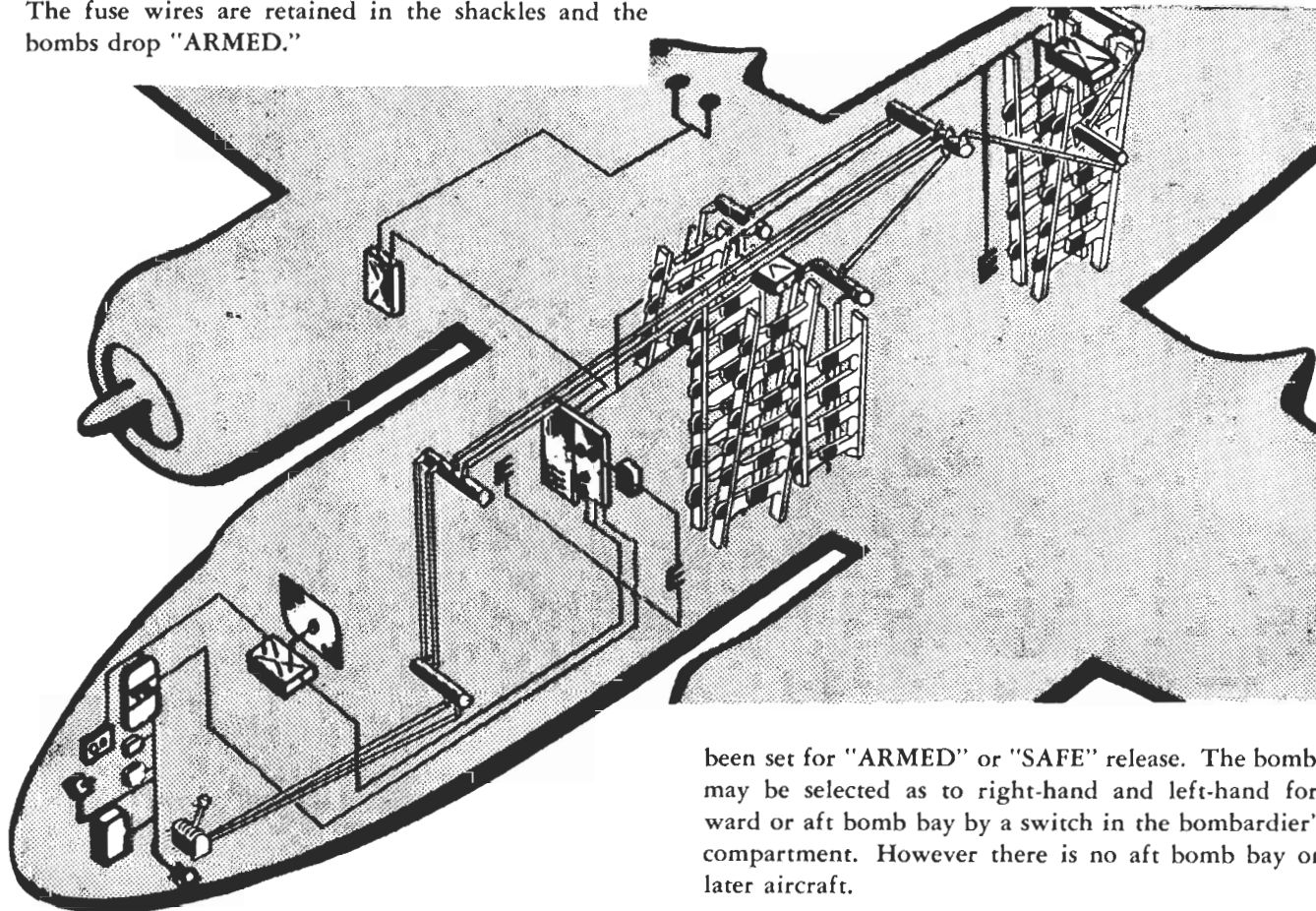

been set for "ARMED" or "SAFE" release. The bombs may be selected as to right-hand and left-hand forward or aft bomb bay by a switch in the bombardier's compartment. However there is no aft bomb bay on later aircraft.















 Bomb Sight	 Junction Box	 Safety Switch
 Bomb Release Toggle Switch	 Bomb Release Indicator Light —Pilot's Instrument Panel	 A-2 Release Unit
 Rack Selector Unit	 Generator Control Panel Main Distribution Box	 A-2 Arming Solenoid
 Indicator Light Panel	 Time Delay Relay	 Release Formation Light
 Intervalometer		 Bomb Bay Door Selector Handle

Figure 6 — Bomb Release, Armed

2. BOMBARDIER'S SALVO.—The bomb bay door selector handle is prevented from shifting further forward in the center (both bays) slot by a safety stud, and must be lifted and rotated 90 degrees before it can be pushed forward from "SELECTIVE" to "SALVO" position. Movement of the selector handle from "SELECTIVE" to "SALVO" position mechanically releases the release arms of the A-2 release units. The arming arms remain in position, leaving the fuse wire hooks open and permitting fuse wires to fall with the bombs. The entire contents of the forward and aft bomb bays are salvoed "SAFE." No provision is made for salvoing the forward and aft bomb bays separately.

3. PILOT'S SALVO.—The emergency bomb release handle in the pilot's compartment is connected by cable to a compressed air bottle in the aft bomb bay. When the release handle is pulled, compressed air is released to the bomb bay door operating cylinders, then to the mechanical bomb release linkage through a disengaging valve. The action of the mechanical linkage is identical with the action brought about by movement of the bomb bay door selector handle to "SALVO" position, the entire contents of the forward and aft bomb bays being salvoed "SAFE." Later aircraft do not have an aft bomb bay.

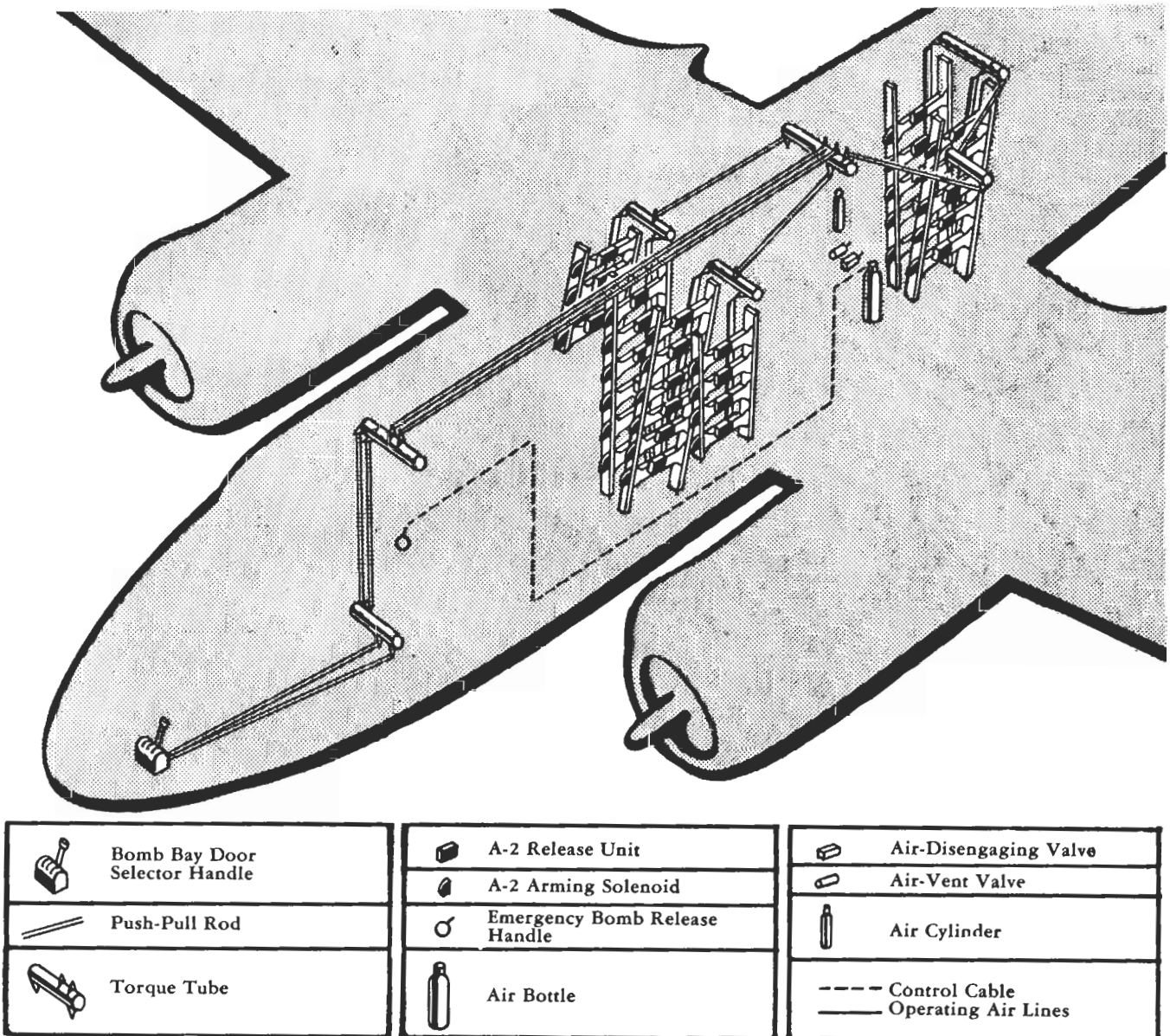

Figure 7 — Bomb Release, Safe



(k) TORPEDO RELEASE. (See figure 8.)

1. GENERAL.—The airplane is equipped to carry a Mark XIII Model 1 torpedo supported below the forward bomb bay by two heavy cables. One end of each cable is attached to the lowest shackle of the two inboard racks. Elastic retracting cords retract the cables through holes in the bomb bay doors to a taut position inside the bomb bay after the torpedo is released. The torpedo door switch completes the electric circuit from the firing trigger to the release units when the bomb bay doors are closed.

2. ARMED RELEASE.—The torpedo control handle in the pilot's compartment is connected by cable to a torque tube which operates a short section of the slider bars. The slider bars set the A-2 release units for electrical release. The torpedo is released electrically by the torpedo firing trigger after the torpedo control handle has been pulled out to "SELECTIVE" position and slipped into the lower portion of the keyhole. The nose arming cable and the starting lanyard are retained at the airplane and the torpedo drops "ARMED."

3. SAFE RELEASE. — The torpedo control handle is normally prevented from moving past the "SELECTIVE" position by a spring clip with an attached finger ring. In an emergency, the torpedo is released "SAFE" by pulling the finger ring down and the control handle full forward (approximately 4 inches). The last inch of travel of the release cable mechanically releases the shackles and engages a secondary cable running from the torque tube back to the starting lanyard hook. The spring loaded hook, which normally retains the starting lanyard, is opened and the lanyard falls with the torpedo.

4. EMERGENCY BOMB RELEASE HANDLE.—The emergency bomb release handle is connected to the torpedo release cable through a series of cams. When the emergency bomb release handle is pulled forward, the torpedo is released "SAFE," then both bomb bay doors are opened and the contents salvaged. The torpedo is no longer carried on later aircraft.

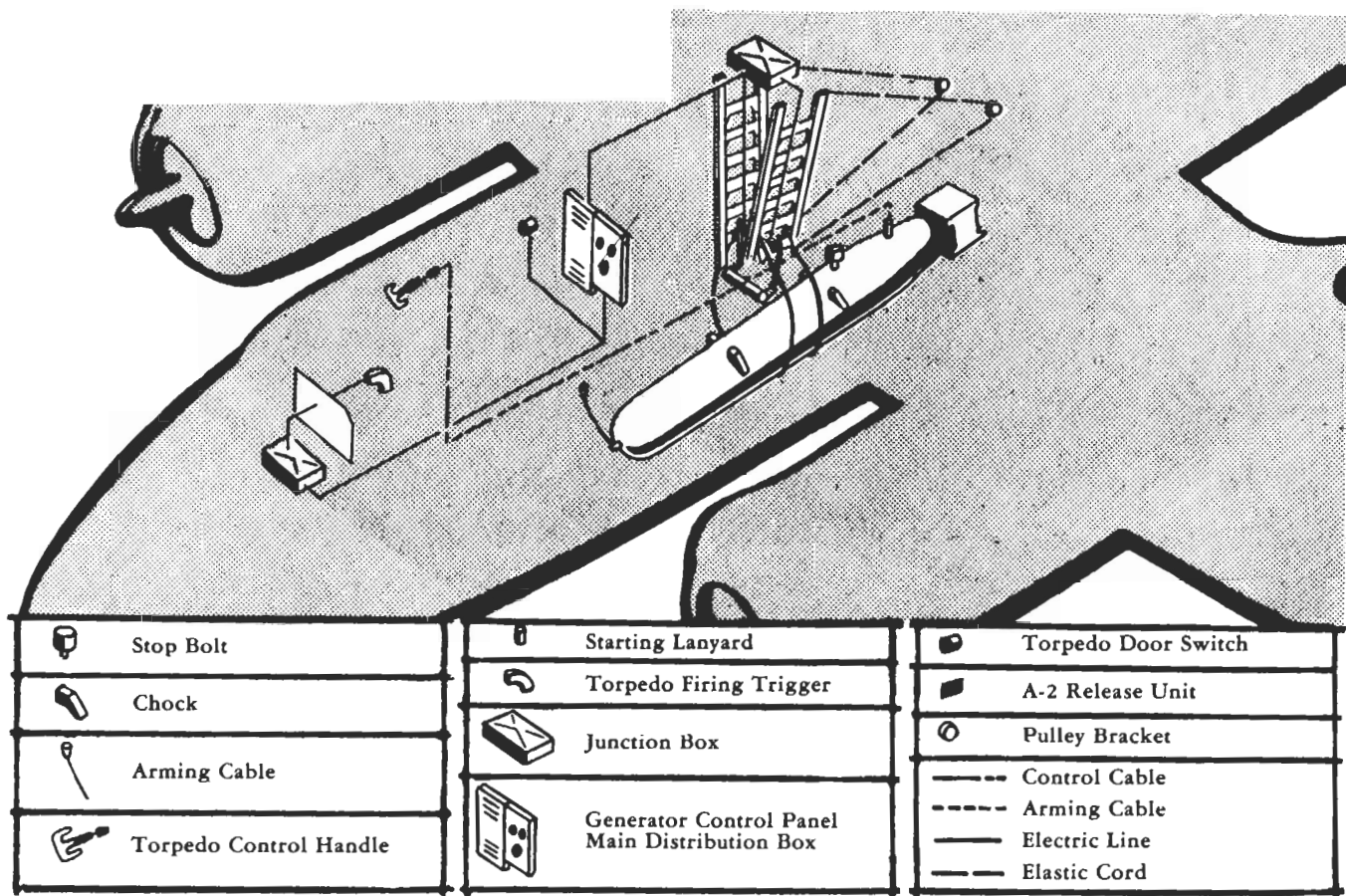
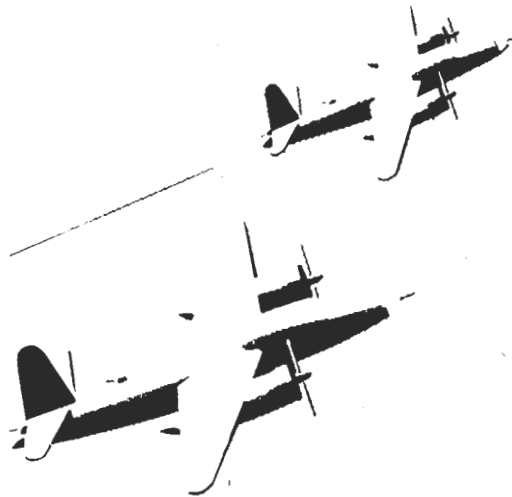

Figure 8 — Torpedo Release System



#### i. HYDRAULIC SYSTEM.

(1) GENERAL.—Hydraulic pressure is developed by two engine driven pumps, which have a capacity of 10 to 12 gallons per minute at normal flight speeds. The pumps discharge into a main pressure line which conveys the hydraulic fluid into a pressure regulating valve. Two lines extend from this valve, one to the reservoir and one to the main pressure line by way of an accumulator.

(a) THE ACCUMULATOR.—The accumulator maintains a steady pressure in the system and supplements the pumps as a source of energy. The accumulator is a steel walled sphere which is divided into two sections by a flexible diaphragm. The lower section is charged with air at a pressure of 400 pounds per square inch while the hydraulic pressure reading is at zero. When the hydraulic pressure is built up to 850 to 1050 pounds per square inch the air is compressed to 850 to 1050 pounds per square inch.

(b) PRESSURE REGULATOR. — Pressure in the system is maintained at 850 to 1050 pounds per square inch by the pressure regulator, which by-passes the flow of hydraulic fluid to the reservoir at pressures above 1050 pounds per square inch. When the operation of some unit reduces the pressure below 850 pounds per square inch, the pressure regulator cuts in the pumps which build the pressure back up to 1050 pounds per square inch.

(c) RELIEF VALVES.—Each pump is protected by an engine pump relief valve. Should the regulator

valve fail to function, pressure in excess of 1200 pounds per square inch in the pump line is relieved into the suction line. The entire system is protected from excessive pressure by two thermal expansion relief valves which relieve into the reservoir whenever the pressure exceeds 1200 pounds per square inch. These valves are arranged in the pressure line from the pumps so that the failure of one pump will not interfere with the continued operation of the other.

(d) UNIT CONTROL VALVES.—The pumping system discharges into the main pressure artery running through the airplane. Lines branch out to various unit control valves, operated by levers on the pilot's pedestal, which control the operation of landing gear, brakes, bomb bay doors, wing flaps, cowl flaps, and oil cooler shutters. Return lines pass through the unit control valves into a main return line to the reservoir. From the reservoir the pump suction line carries the fluid out to the pumps, thus completing the cycle.

(e) EMERGENCY HAND PUMP.—An emergency hand pump is provided to operate the hydraulic cylinders in the event of failure of the normal source of pressure. The hand pump is connected to the main pressure line and can be used to operate any hydraulic unit, using the normal control levers. Before any emergency operations are carried out, the quantity of fluid in the reservoir should be visually checked. Should the normal supply be exhausted, fluid is drawn from the emergency reservoir. The emergency supply is fed direct to the hand pump by the emergency hydraulic reservoir supply valve.

(f) LANDING GEAR. (See figure 9.)

1. GEAR OPERATION.—The landing gear is retracted or extended by moving the landing gear control lever to the "UP" or "DOWN" position. This diverts fluid from the main pressure line through a single unit control valve to the required end of the gear-operating cylinders. Fluid from the opposite end of the cylinders then flows through the single unit control valve and back to the reservoir. Spring loaded single action cylinders lock each gear in the "UP" or "DOWN" position.

2. DOOR OPERATION. — The main gear doors are opened and closed by rods connected to the main landing gear strut. The nose gear doors are opened and closed by the action of a separate double acting cylinder. The nose gear is unlocked and extended after the load and fire check valve has been fired by the opening of the doors. The nose gear doors are closed by the door cylinder when the sequence valve is opened by the retraction of the gear.

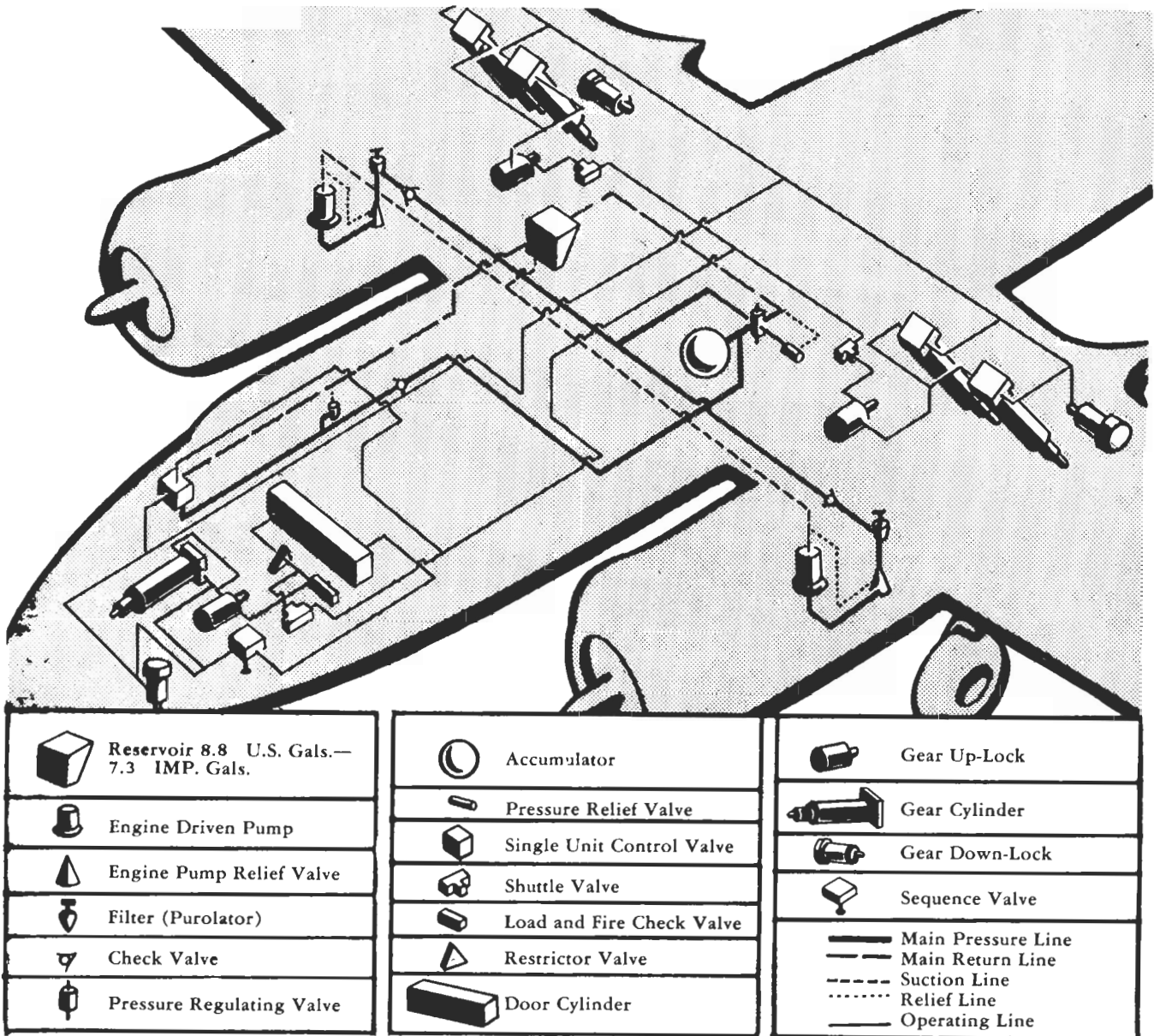
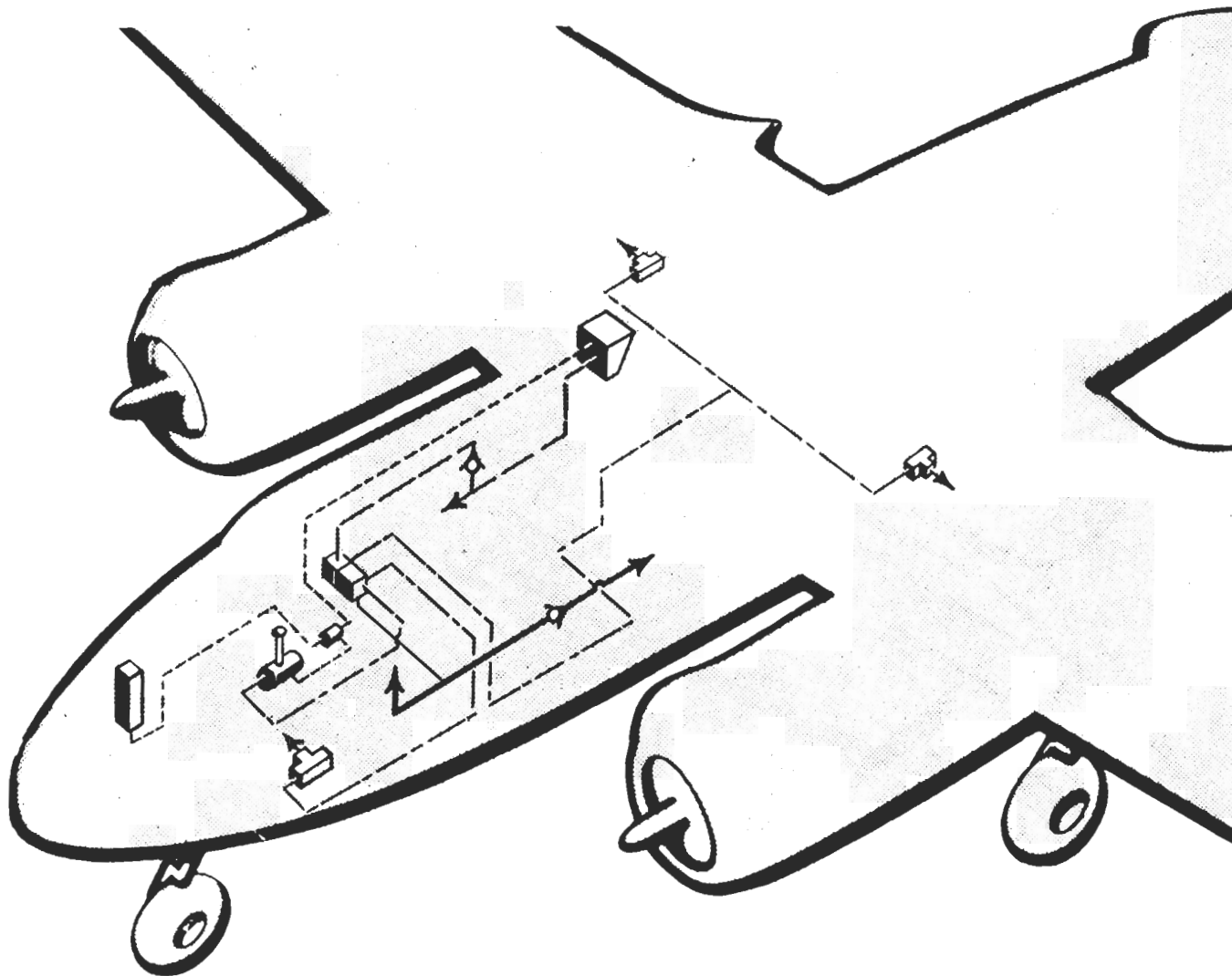

Figure 9 — Landing Gear, Normal Operation

3. EMERGENCY OPERATION. (See figure 10.)—Independent hydraulic lines extend direct from the main reservoir to the double unit control valve and from the control valve direct to the shuttle valves. The double unit control valve is operated by the nose and main gear emergency levers. The emergency reservoir supply valve is used to switch from the main

to the emergency reservoir. It is possible to operate the landing gear with the emergency hand pump in the event of breakdown or loss of fluid in the normal operating lines. The hand pump is operative after the emergency levers have been shifted to "EMERGENCY" and the landing gear lever shifted to the desired setting.















 Reservoir 8.8 U.S. Gals.— 7.3 IMP. Gals.	 Hand Pump	 Shuttle Valve
 Emergency Reservoir 3.5 U.S. Gals.—2.9 IMP. Gals.	 Double Unit Control Valve	 Main Pressure Line  Main Return Line  Suction Line
 Emerg. Res. Supply Valve	 Check Valve	 Hand Pump Pressure Line  Operating Line

Figure 10 — Landing Gear, Emergency Operation

(g) BRAKES.

1. NORMAL OPERATION. (See figure 11.)

—The service brakes are operated by depressing the pedals to the desired degree. The operating pressure varies from 0 to 400 pounds per square inch. The brakes are operated through a power brake control valve which reduces the system pressure of approximately 1000 pounds per square inch to 400 pounds per

square inch, which is the maximum pressure required by the brakes. The hydraulic pressure supplied to the brakes is directly proportional to the force exerted on the pedals, 5-1/4 pounds pressure being exerted on the brake pressure plates for each pound applied to the pedals. The service brakes are set for parking by pulling a hand lever back after the foot pedals are depressed. The lever operates a ratchet which holds the pedals down, thus locking the brakes.

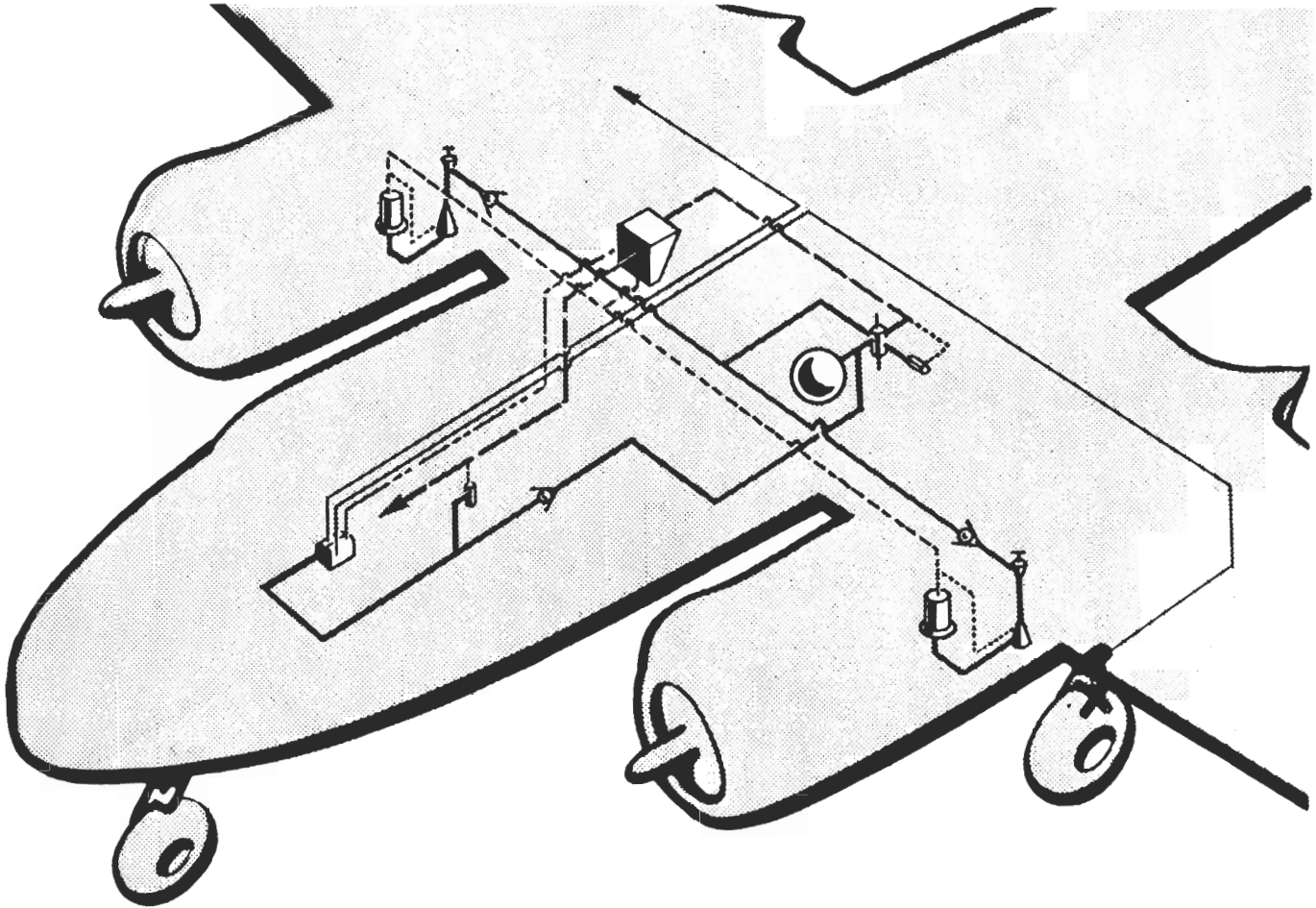

















 Reservoir 8.8 U.S. Gals.— 7.3 IMP. Gals.	 Pressure Regulating Valve	 Brake Shut-Off "Y" Valve
 Engine Driven Pump	 Accumulator	 Main Pressure Line
 Engine Pump Relief Valve	 Pressure Relief Valve	 Main Return Line
 Filter (Purolator)	 Power Brake Control Valve	 Suction Line
 Check Valve	 Shuttle Valve	 Relief Line
		 Operating Line
		 Brake Return Line

Figure 11 — Brake Operation, Normal



2. EMERGENCY OPERATION. (See figure 12.)—For extreme emergency use, the service brakes may be operated by compressed air. The emergency air brake handle in the pilot's compartment releases air at a pressure of 1000 pounds per square inch which flows through a shuttle valve into the hydraulic brake

operating cylinders. The emergency handle should be pulled slowly to apply pressure to the brakes in short surges. Should the brakes lock prematurely, the emergency air brake bleeder valve may be used to relieve the pressure. The compressed air bottle must be refilled after emergency use.

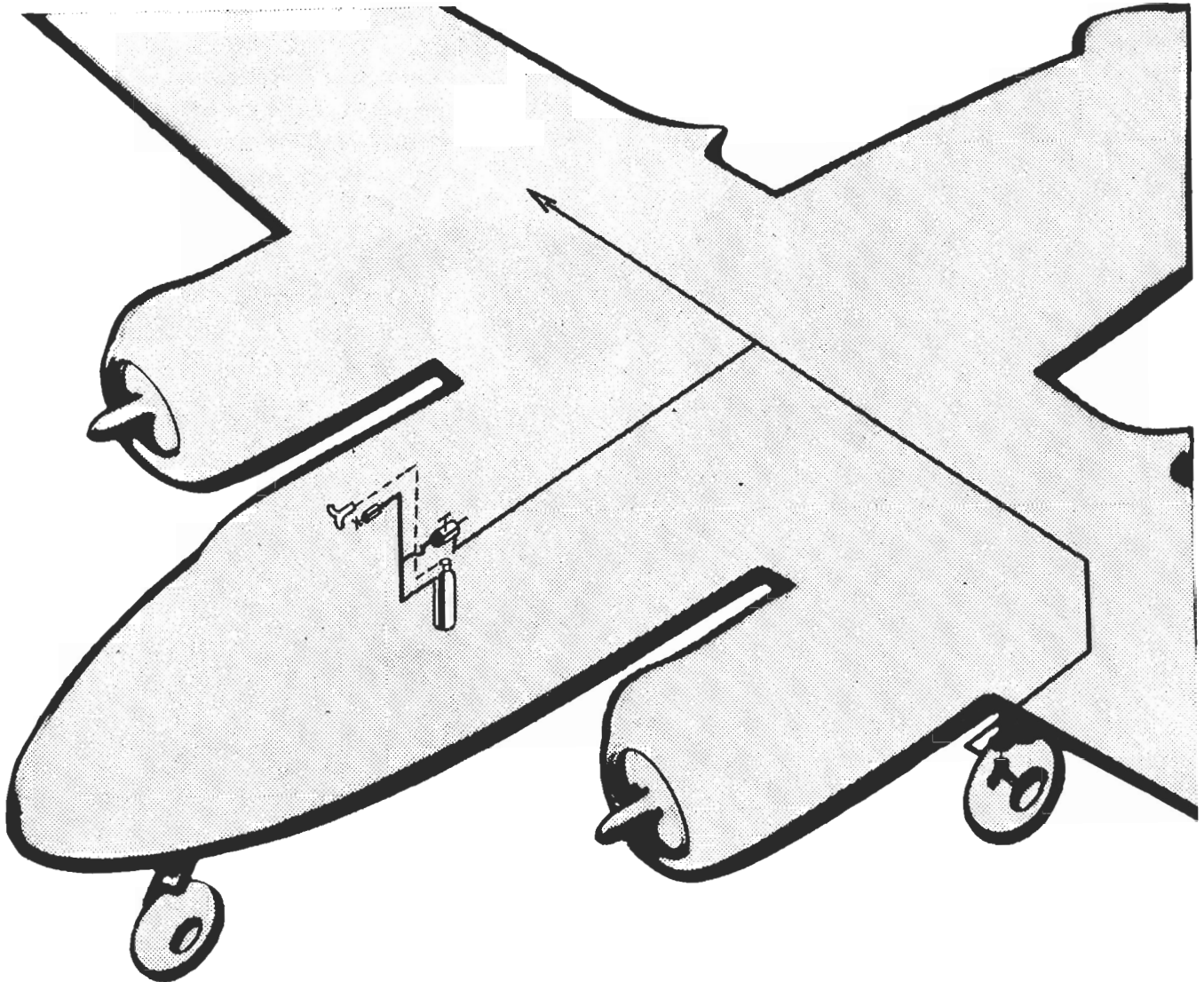









	Emerg. Air Brake Handle		Air Brake Shut-Off And Filler Valve		Shuttle Valve
	Air Bottle		Bleeder Valve		Brake Shut-Off "Y" Valve
					Emergency Cable
					Operating Air Line

Figure 12 — Brake Operation, Emergency

(b) WING AND COWL FLAPS.

1. NORMAL OPERATION. (See figure 13.)

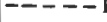
—Wing and cowl flaps are operated through a triple unit control valve by moving the required lever to the "UP" or "DOWN" position. When the position indicator on the instrument panel shows the desired setting, the lever should be returned to "NEUTRAL" immediately. Hydraulic fluid between the unit control valve and the operating cylinders holds the flaps in position.

a. RELIEF RESTRICTOR VALVE.—A relief restrictor valve, mounted in the wing flap operat-

ing line, regulates the speed of operation and protects the flap structure from excessive loads. Wing flaps are set to operate from closed to full down position or vice versa in 12 ( $\pm 2$ ) seconds at a speed of 160 mph. Should the wing flaps be lowered at too high an air speed (above 185 mph) this valve relieves into the return line from the flap cylinder to the unit control valve, permitting the flaps to retract.

b. RESTRICTOR VALVE.—A restrictor valve in the cowl flap operating line is set to govern the speed of operation of the cowl flaps. Cowl flaps will open or close in 7 to 10 seconds.

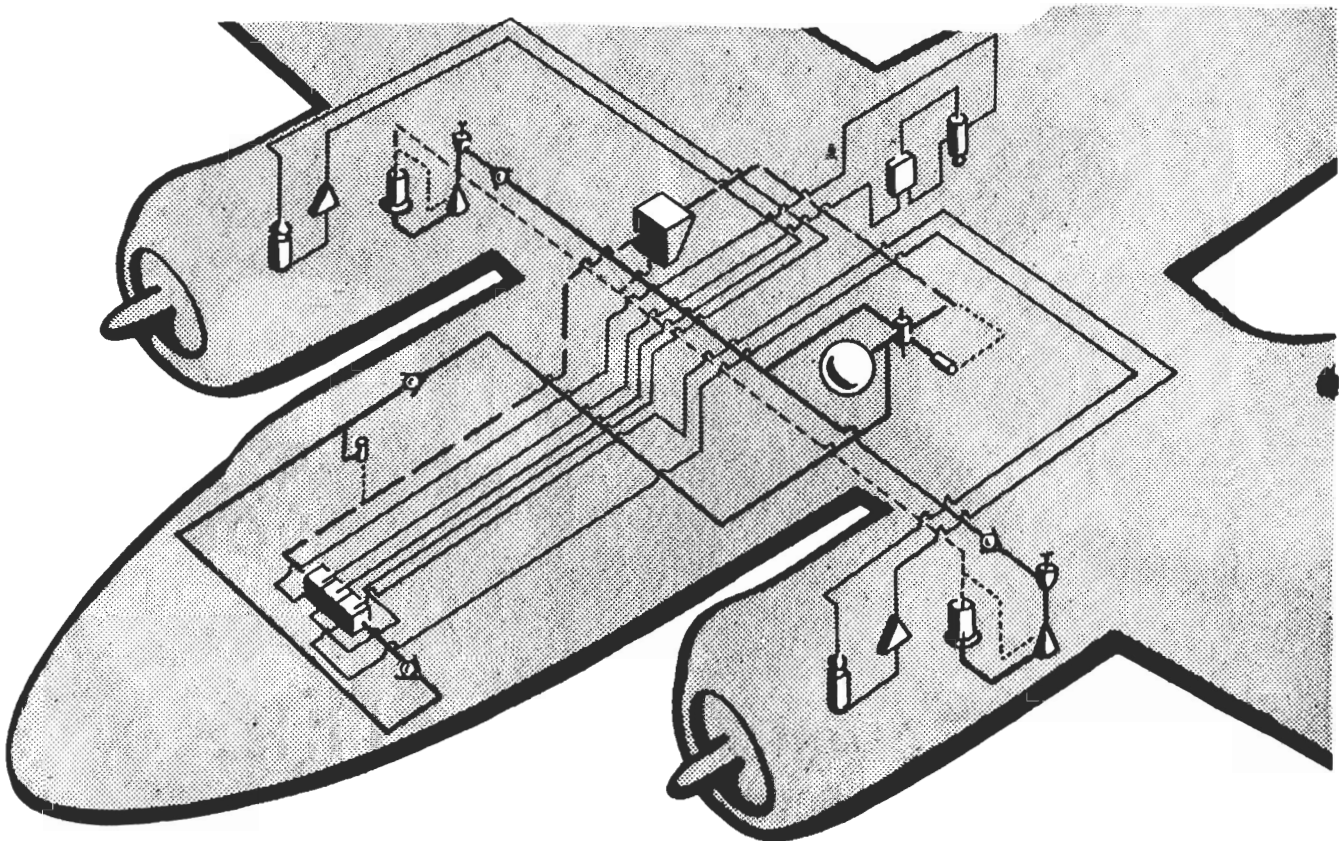



















 Reservoir 8.8 U.S. Gals.— 7.3 IMP. Gals.	 Pressure Regulating Valve	 Wing Flap Cylinder
 Engine Driven Pump	 Accumulator	 Restrictor Valve
 Engine Pump Relief Valve	 Pressure Relief Valve	 Cowl Flap Cylinder
 Filter (Purolator)	 Triple Unit Control Valve	 Main Pressure Line
 Check Valve	 Relief Restrictor Valve	 Main Return Line
		 Suction Line
		 Relief Line
		 Operating Line

Figure 13 — Wing and Cowl Flaps, Normal Operation

2. EMERGENCY OPERATION, WING FLAPS. (See figure 14.)—Provision is made for mechanical lowering of wing flaps in the event of complete failure of the hydraulic system. A hand crank, stowed in the forward bomb bay, is inserted in a hole just above the opening between the bomb bays. (See figure 14.) Counterclockwise rotation of the crank lowers the wing flaps. The flaps are locked in position by the crank, which cannot be removed until the flaps

are again retracted. The wing flap hydraulic control lever on the pilot's pedestal must be in "DOWN" position before the flaps can be operated mechanically. The wing flaps should never be lowered, mechanically or hydraulically at a speed of 185 mph or over.

3. EMERGENCY OPERATION, COWL FLAPS.—No provision is made for mechanical or emergency operation of the cowl flaps.



Figure 14 — Wing Flaps Operation, Emergency



(i) OIL COOLER SHUTTERS.

1. NORMAL OPERATION. (See figure 15.)

—Oil cooler shutters are operated through a double unit control valve by moving the control levers to the "UP" or "DOWN" position. When the indicator on the instrument panel shows the desired setting, the lever is returned to "NEUTRAL" immediately. Hydraulic fluid between the unit control valve and the

operating cylinder holds the shutters in position. A restrictor valve is set to govern the speed of operation. Oil cooler shutters will open or close in 7 to 10 seconds.

2. EMERGENCY OPERATION.—No provision is made for mechanical or emergency operation of the oil cooler shutters.

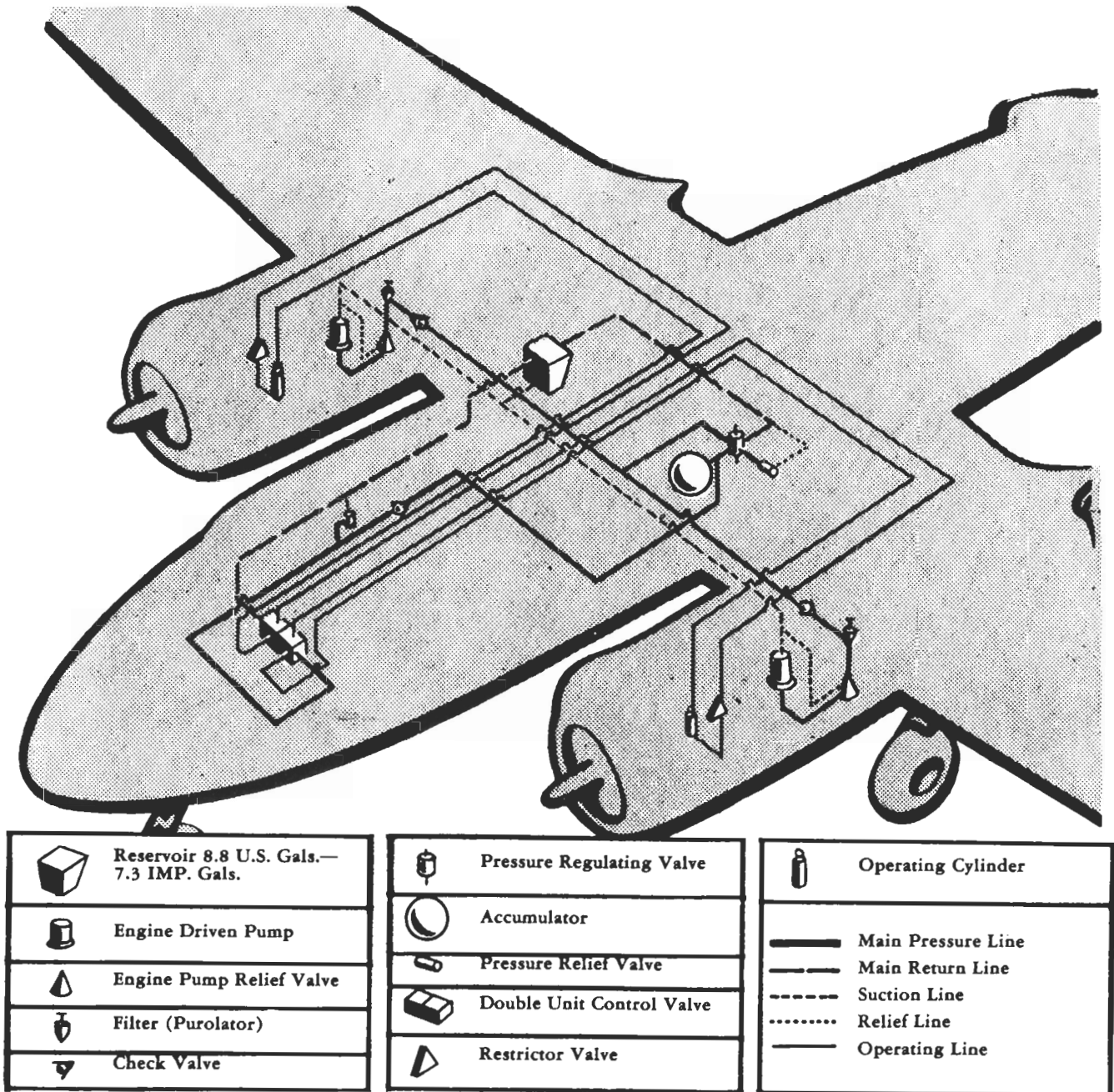
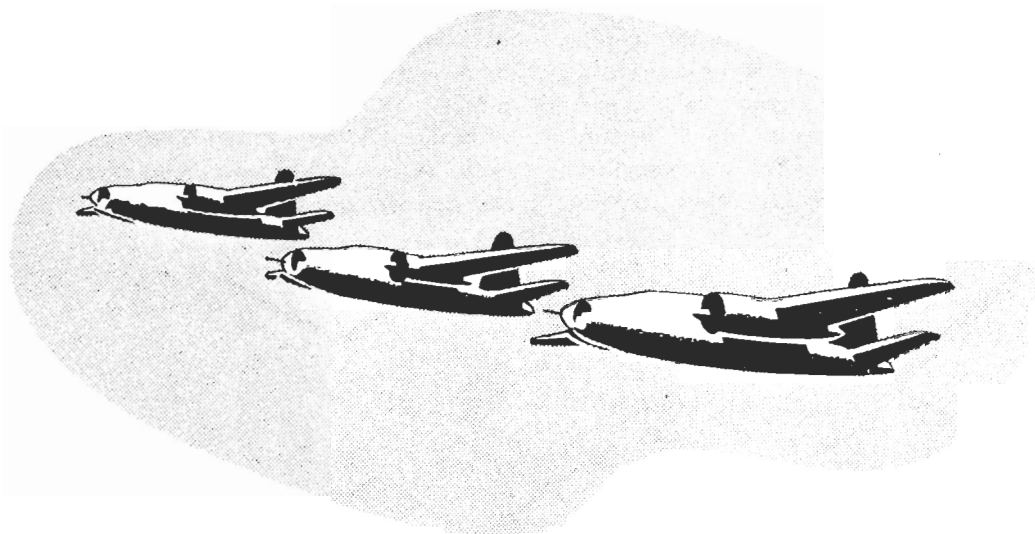

Figure 15 — Oil Cooler Shutters Operation



*j.* ELECTRICAL SYSTEM.

(1) GENERAL DESCRIPTION. — Electrical power is supplied by a 24 to 28 volt direct current one wire system. A storage battery and an engine driven generator in each nacelle are controlled by voltage regulators and reverse current cut-out relays. Two generators, connected in parallel with the batteries, carry a rating of 200 amperes each at 28 volts and are the primary source of electrical energy during flight.

(a) VOLTAGE REGULATORS. — Since the generators are driven at variable speeds and are subject to wide changes of load, automatic controls are necessary to maintain the voltage within the operating range of 24 to 28 volts. The voltage regulators, mounted in the waist compartment, stabilize the terminal voltage by varying the strength of the magnetic fields. The voltage regulators should be adjusted to maintain the output from each generator as close to 27 volts as possible, thus distributing the total load equally.

(b) BATTERIES.—Power for starting the engines and for necessary lighting and testing of equipment when the engines are idling or inoperative is obtained from the batteries, supplemented by the auxiliary power plant or an external power source. In flight, the batteries act as a ballast for the electrical system, either taking some of the generator output or assisting the generators to carry high short-duration loads.

(c) REVERSE CURRENT CUT-OUT RELAYS.—The reverse current cut-out relays, located in the nacelle junction boxes, automatically disconnect the generators when they are inoperative or have a terminal voltage less than the batteries. Thus any flow of current from batteries to generators, tending to operate the generators as motors, is prevented.

(d) MAIN DISTRIBUTION BOX.—The main distribution box is the central junction box for all wiring.

(e) GENERATOR CONTROL PANEL.—The generator control panel is the central distribution point for current from the generators. The voltmeters, two ammeters, the main inverter switch, and circuit breakers are mounted on the face of the panel. A two-position switch permits observation of the voltage of each generator on the voltmeter. Switches are located under each ammeter. Slight variations in line conditions usually cause one ammeter to read higher than the other. Such a difference is normal unless it is very pronounced.

(f) INVERTER.—An inverter, operating on 24 volt direct current from the battery-generator system, supplies alternating current for the operation of fluorescent lights, radio compass, and autosyn instruments. Provisions have been made for the installation of a spare inverter which may be connected to the inverter selector switch on the pilot's pedestal. The main inverter switch is located on the face of the generator control panel.

(2) IGNITION SYSTEM. (See figure 16.)—The ignition system furnishes sparks periodically in each cylinder at a predetermined position of piston travel. The essential elements of the system are the magnetos, which supply high voltage for ignition at normal operating speeds and the distributors which deliver the high voltage to the cylinders. The magnetos are supplied with 24 to 28 volt pulsating direct current

from the induction vibrator for starting. For safety and improved performance, two identical but independent ignition systems are simultaneously employed. The ignition switches, located on the pilot's pedestal, are turned "ON" individually for testing, or together for normal operation. All ignition system wiring is enclosed in metal shields to ground out electrical radiation emanating from the system.

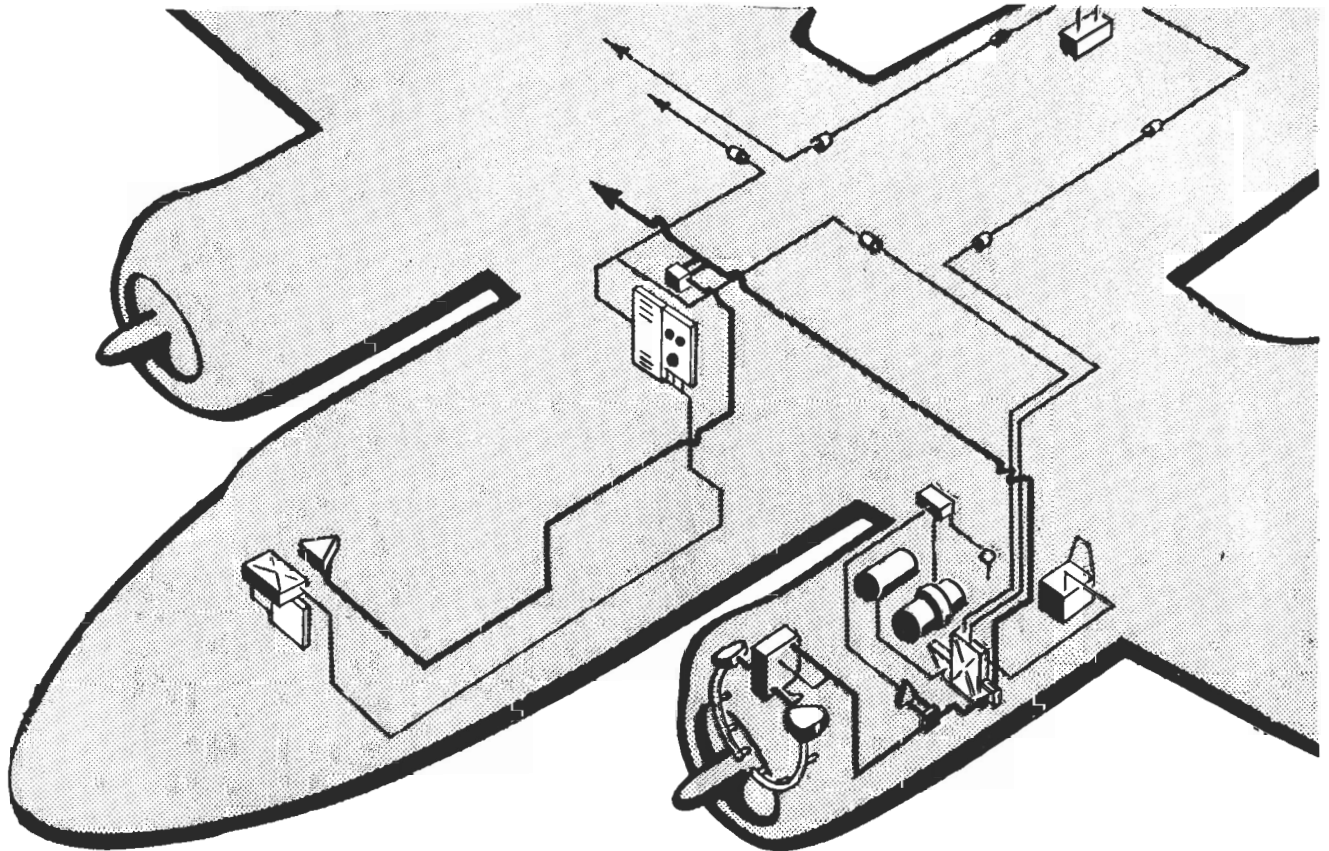

	Master and Ignition Switches		Distributor		Main Distribution Box
	Ignition Junction Box		Harness		Disconnect Fitting
	Magneto Junction Box		Junction Box		Generator Control Box
	Vibrator		Pedestal Disconnect Panel		Generator
	Engine Pull Box		Generator Control Panel		Storage Battery
	Starter				Voltage Regulator Box
	Oil Dilution Valve				Magneto Line
	Magneto				Electric Line

Figure 16 — Ignition System

(3) PROPELLER GOVERNOR SYSTEM.

(See figure 17.)

(a) DESCRIPTION.—The propeller blade angles are automatically adjusted to compensate for changes in airplane speed or engine power. Constant propeller speed is maintained by fly-weight type governors which automatically control the variable pitch propellers through reversible electric motors. Brakes attached to the front ends of the motors lock the blades in position and are released by solenoids connected in series with the electric motors. To keep the blade angles within effective operating limits, integral limit switches are installed in the hubs of the power units.

(b) GOVERNOR CONTROL SYSTEM.—The control system is composed of constant speed governors and relays. Control levers and switches are located on the pilot's pedestal. The governor control levers ad-

just the setting of the pitch change motors. Fly-weights driven by the engine energize the relays in the proper direction to increase or decrease pitch as required to maintain the engine speed selected with the governor control levers.

(c) PROPELLER TOGGLE SWITCHES.—The propeller toggle switches have four positions, "FIXED PITCH," "AUTO CONSTANT SPEED," "INC. RPM" and "DEC. RPM." The "INC. RPM" and "DEC. RPM" settings operate on 24-volt direct current and are used to adjust the pitch manually. The "DEC. RPM" setting will completely feather the propeller in 35 to 40 seconds.

(d) FEATHERING SWITCHES.—The feathering switches operate the propellers through a booster which supplies 96 volts to the pitch change motors. In an emergency the blades can be feathered in 8 to 10 seconds.

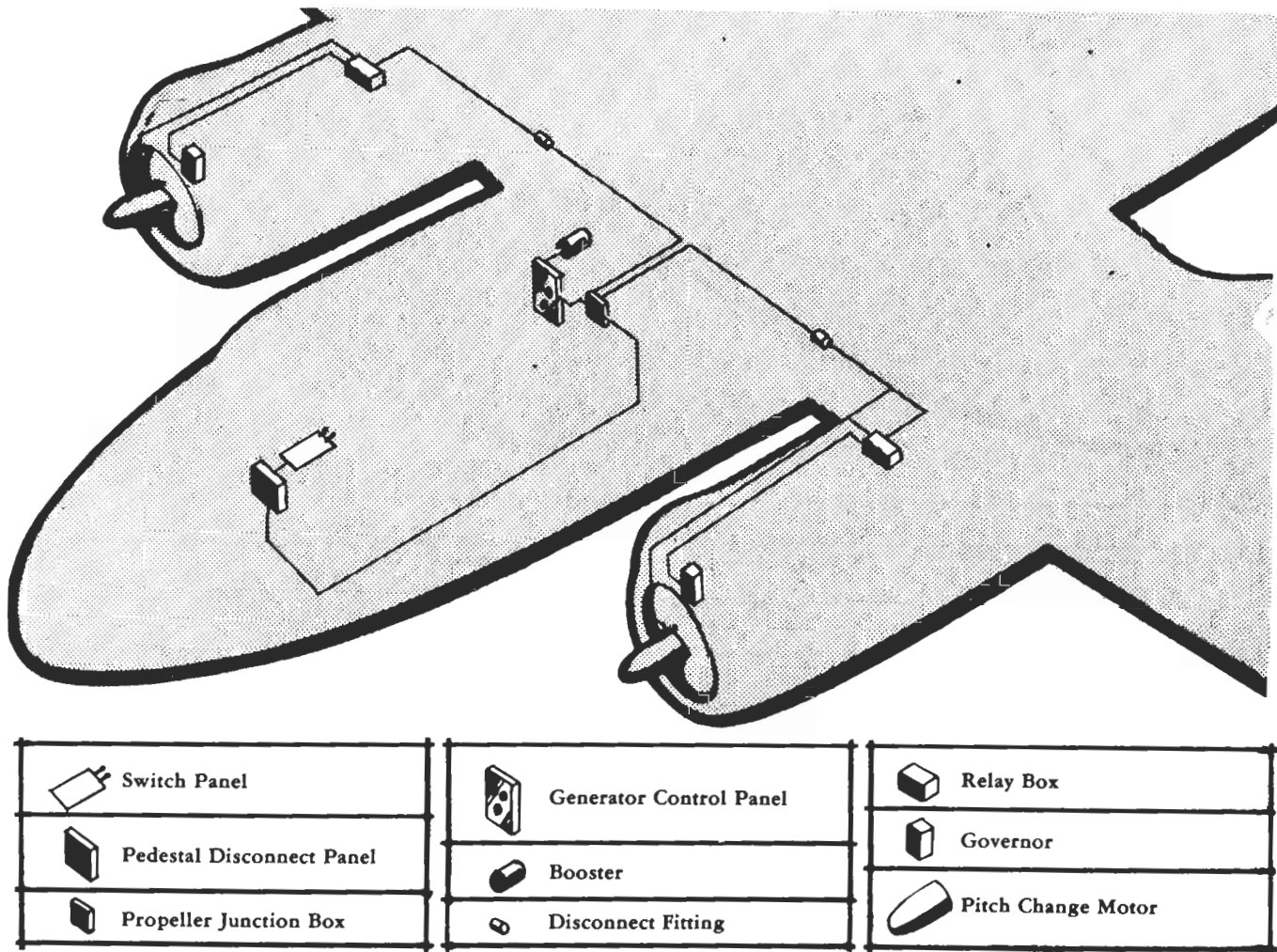

Figure 17 — Propeller Governor System



(4) INSTRUMENTS. (See figure 18.)

(a) AUTOSYN.—Fuel, oil, manifold pressure, and tachometer readings are electrically transmitted to the pilot's instruments by autosyn transmitters installed in each nacelle. The 28-volt, 400-cycle alternating current required for these instruments is supplied by the inverter. Fuses for both right- and left-hand instruments are located on the generator control panel.

(b) SELSYN.—The position of landing gear, wing and cowl flaps, and oil cooler shutters is relayed to the pilot's instruments by selsyn transmitters, which operate on 24-volt direct current.

**NOTE**

On later aircraft the fuel, oil, and manifold pressure readings are transmitted to the pilot's instruments by AN pressure-type transmitters.

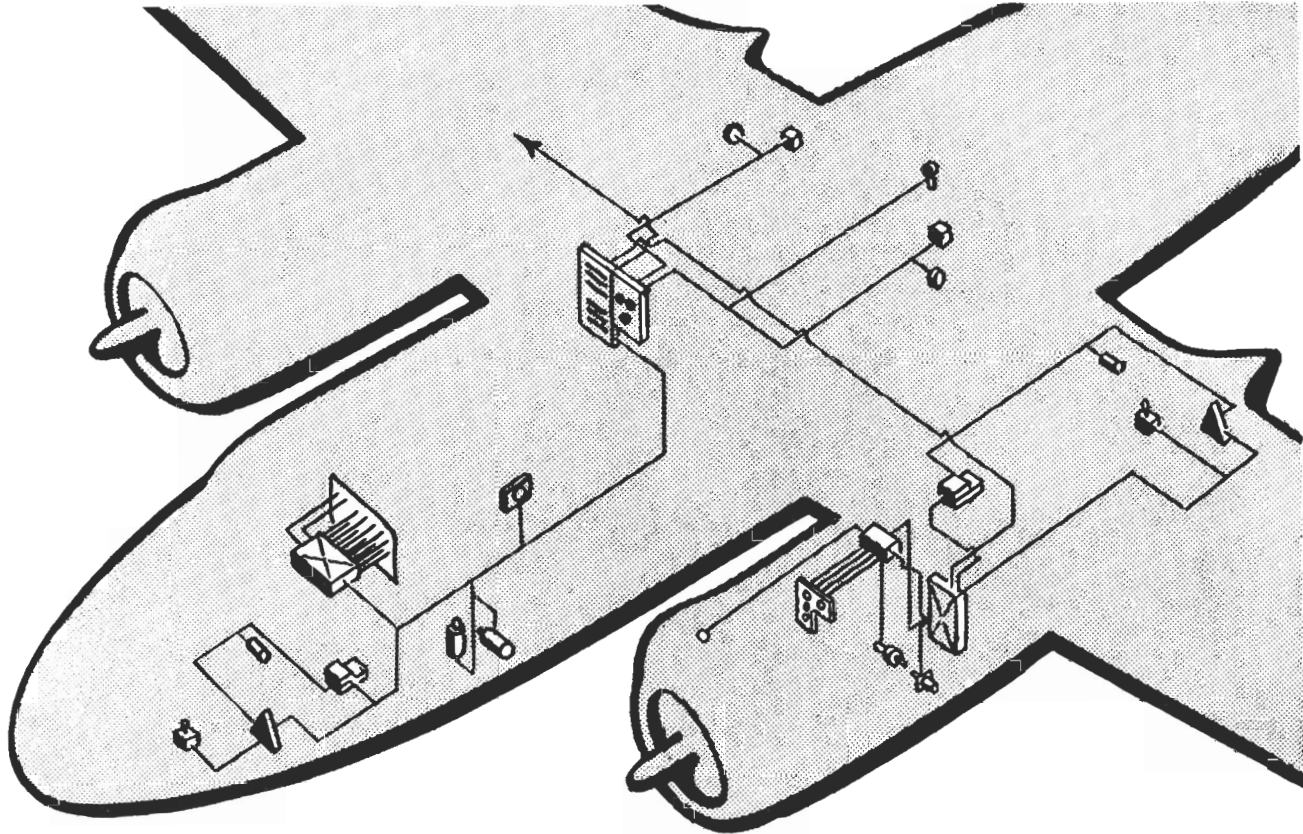

	Pilot's Instrument Panel		Fuel Liquidometer	<b>SELSYN TRANSMITTERS</b>	
	Junction Box		Jack Box		Up-Lock
	Inverter		Engine Pull Box		Wheel Position
	Warning Horn		Carb. Air Temp. Bulb		Down Position
	Main Distribution Box	<b>AUTOSYN TRANSMITTERS</b>			Down Lock
	Generator Control Panel		Tachometer Oil Pressure Manifold Pressure Fuel Pressure		Wing Flap Position
					Cowl Flap Position
					Oil Cooler Shutter Pos.

Figure 18 — Instruments Location

(5) LIGHTING SYSTEM. (See figure 19.)

(a) INCANDESCENT. — All interior and exterior incandescent lights operate on direct current as supplied by the batteries and generators. A master interior light switch, located on the pilot's pedestal, controls all interior lights and may be used for signaling crew members. When the master light switch is "ON," individual compartment lights may be turned "ON" or "OFF" with the local switches. The pedestal light alone is independently controlled. Landing lights, wing and tail positions lights, formation lights, and recognition lights are all controlled from the pilot's pedestal.

on the instrument dials in a soft glow. Alternating current required for fluorescent lamp operation is supplied by the inverter.

(c) INCANDESCENT FLUORESCENT LAMPS.—The incandescent fluorescent lamps are of the flexible cockpit lamp assembly type. They use a 28-volt direct current 4-watt blue fluorescent lamp, designated type C-5. All lights except the two in the navigator's compartment and the one in the bombardier's compartment are controlled by a row of switches on the right-hand side of the pilot's pedestal.

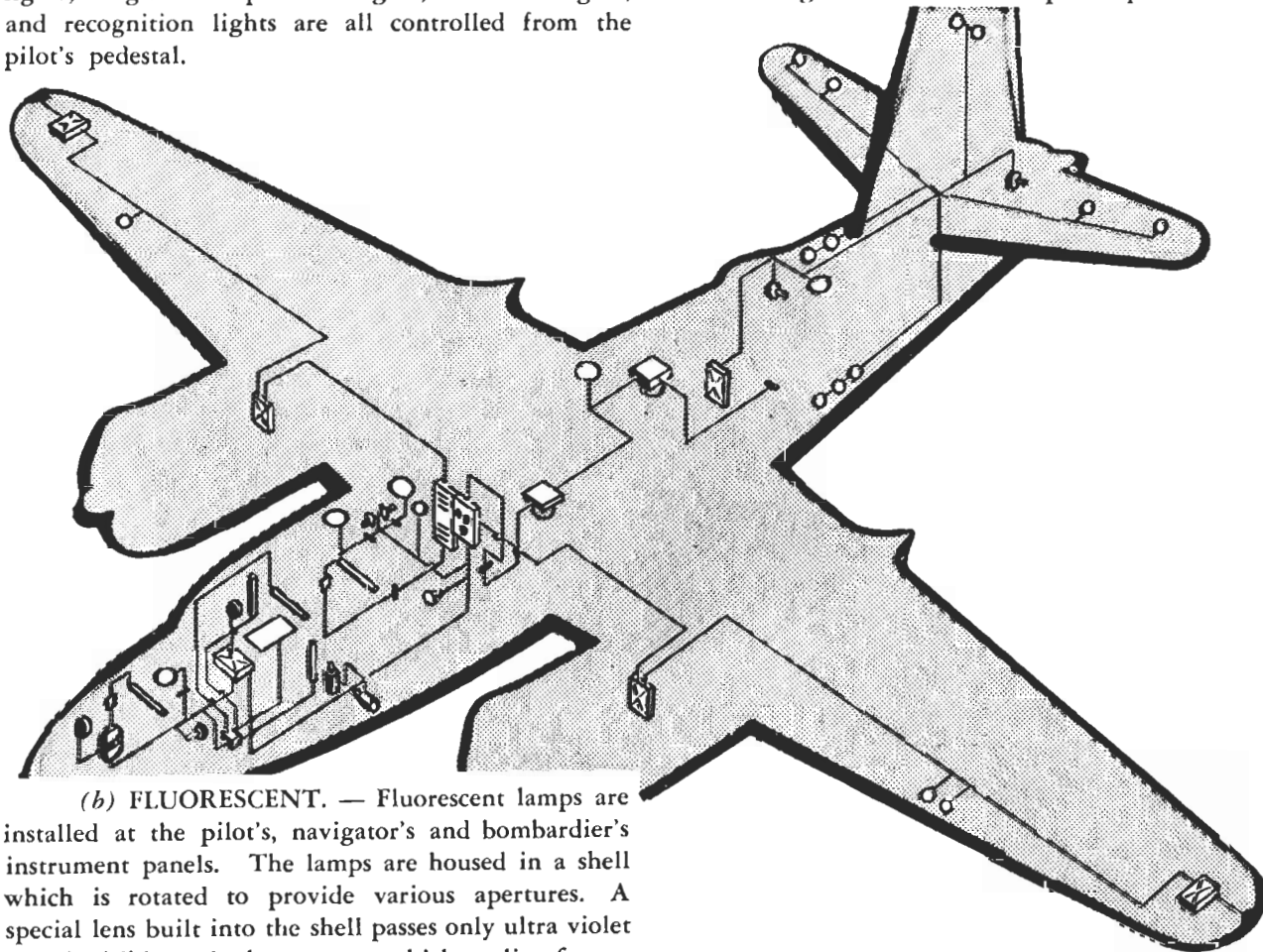

(b) FLUORESCENT. — Fluorescent lamps are installed at the pilot's, navigator's and bombardier's instrument panels. The lamps are housed in a shell which is rotated to provide various apertures. A special lens built into the shell passes only ultra violet rays, invisible to the human eye, which outline figures

















 Pilot's Switch Panel	 Radio Oper. Spotlight	 Inverter
 Exterior Light	 Indicator Light Panel	 Generator Control Panel
 Dome Light	 Magnetic Compass	 Main Distribution Box
 Dome Light Switch	 Fluorescent Light	 Junction Box
 Dome Light Junction Box	 Reactor Box	
 Extension Light	 Auxiliary Reactor Box	

Figure 19 — Lighting System

(6) COMMUNICATION EQUIPMENT.

(See figures 20, 21, 22, 23 and 24.)

(a) GENERAL.—Five radio sets are regularly installed in the airplane. The liaison receiver (BC-348) and transmitter (BC-375-D), operated from the radio operator's compartment, provide for long range communication from airplane-to-base. Interplane and short range airplane-to-ground communications is handled by the command set (SCR-274-N). The command receiver and transmitter are operated from the pilot's compartment through remote control boxes.

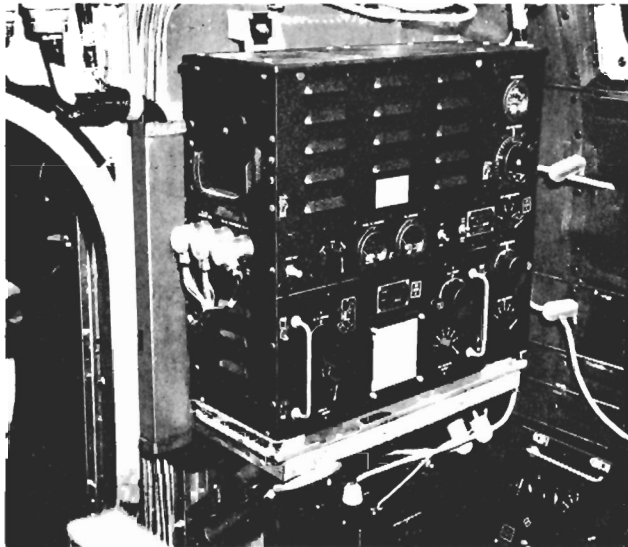

Figure 20 — Liaison Transmitter

Both radio operator and co-pilot are supplied with a remote control box for the radio compass (SCR-269). The recognition transmitter-receiver (SCR-535A or 595A) is controlled by a switch on the pilot's instrument panel.

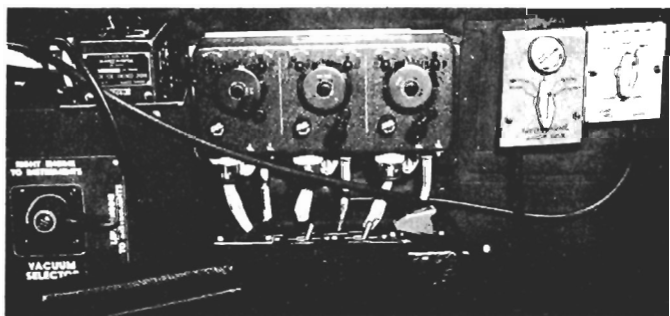

Figure 21 — Command Set

(b) INTERPHONE. — The interphone equipment (RC-36) is the connecting link in the communications system. By turning his interphone jack box selector to the required setting and using his microphone switch to operate the transmit-receive relay, any crew member may talk to any or all other crew members, may receive over the radio compass receiver,

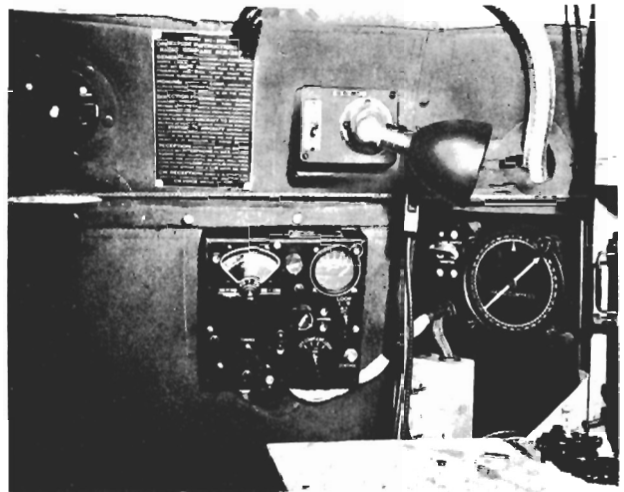

Figure 22 — Radio Compass Control Box

or may receive or transmit over the liaison or command sets. The increase output knob on the jack box controls volume to a limited extent when the selector is turned to "COMP," "LIAISON" or "COMMAND," but is inoperative when the selector is turned to "INTER" or "CALL." The selector may be turned to any one of five settings with the following results:

1. "COMP" connects the radio compass receiver.
2. "LIAISON" connects the liaison receiver. "LIAISON" connects the liaison transmitter (pilot and co-pilot only).
3. "COMMAND" connects the command receiver and transmitter.
4. "INTER" connects all other interphone stations which are also turned to "INTER."
5. "CALL" is used in an emergency to contact all other interphone stations, irrespective of setting. The selector is spring loaded at "CALL" and must be held in position for as long as necessary.

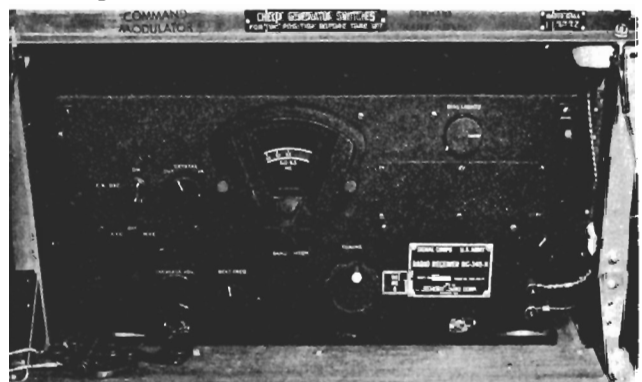

Figure 23 — Liaison Receiver

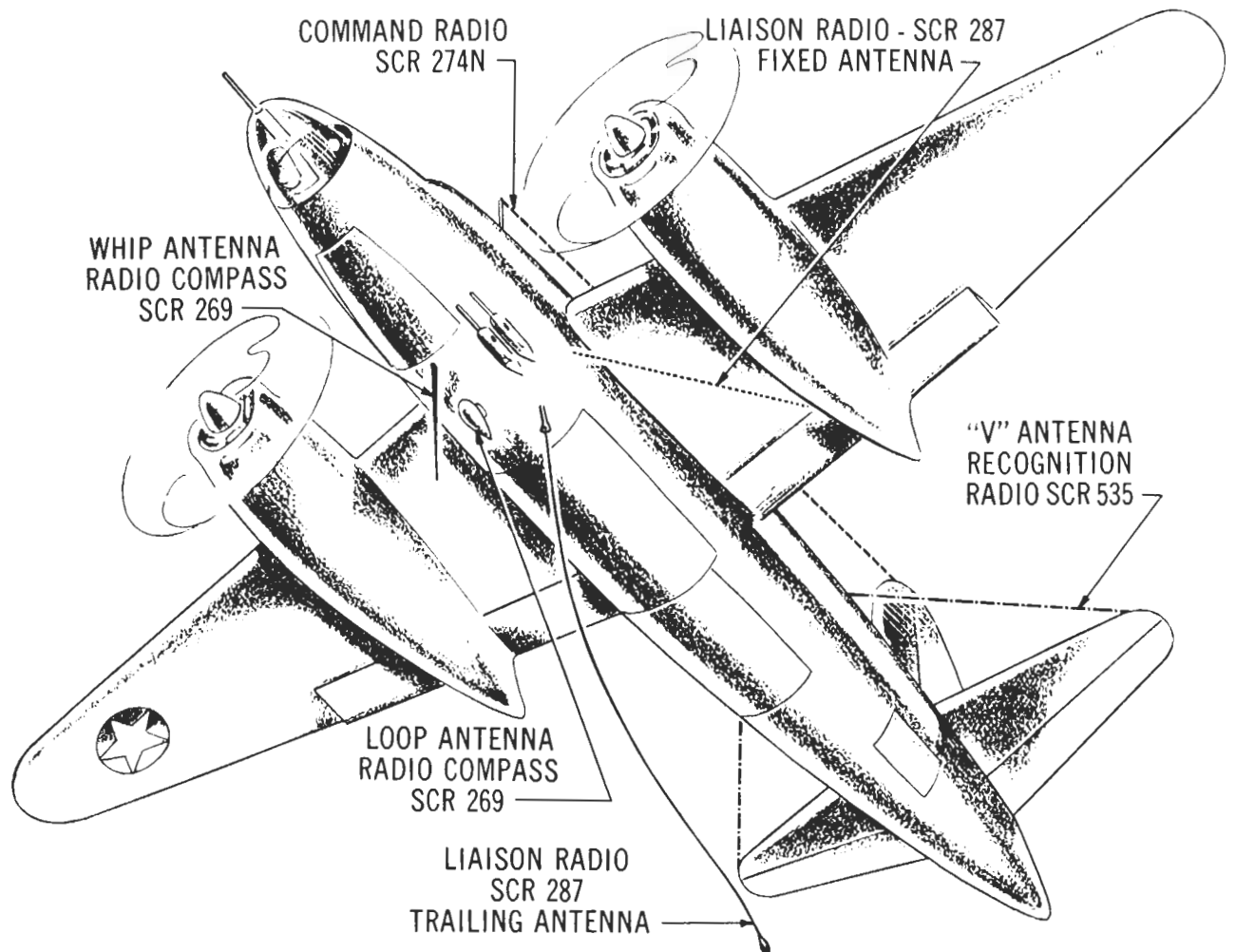

Figure 24 — Aerial Legend Diagram



k. OIL SYSTEM. (See figure 25.)

(1) GENERAL.—A hopper-type oil tank, protected by an envelope of armor plate, is installed just aft of each engine. Built into the welded aluminum alloy tank is a filler neck with a scupper drain. Two vent lines extend from the tops of the tanks to the engines. Oil level is checked by means of gage cocks on each tank. Oil is drawn from the tank outlet to the engine through a "Y" drain valve by a pressure pump built into the engine. The scavenger pump, also incorporated in the engine, returns the oil to the tank inlet through a temperature relief valve and a 14-inch oil cooler. A hydraulically operated oil cooler shutter is built into the outlet duct from the oil cooler. Oil

temperature is taken at the low pressure inlet just above the scavenger pump.

(2) COLD WEATHER PROVISIONS.—For cold weather operation an oil dilution system is provided. Fuel is supplied at the "Y" drain valve through a solenoid controlled by a switch on the pilot's pedestal. An automatic temperature control unit is built into the oil cooler which directs the flow of heated oil returning from the engine through either the warm-up jacket and hollow baffles or through the case of the cooler. The cooler is protected against high internal pressures by a pressure relief valve installed in the automatic temperature control unit. This valve opens at 30 to 35 pounds per square inch allowing oil to bypass directly into the oil tank without passing through the cooler. The engine oil pressure relief valve is thermostatically controlled to permit high oil pressure of 350 to 400 pounds to assure complete lubrication of all engine bearings during the warm-up period until the oil temperature reaches 40°C (104°F).

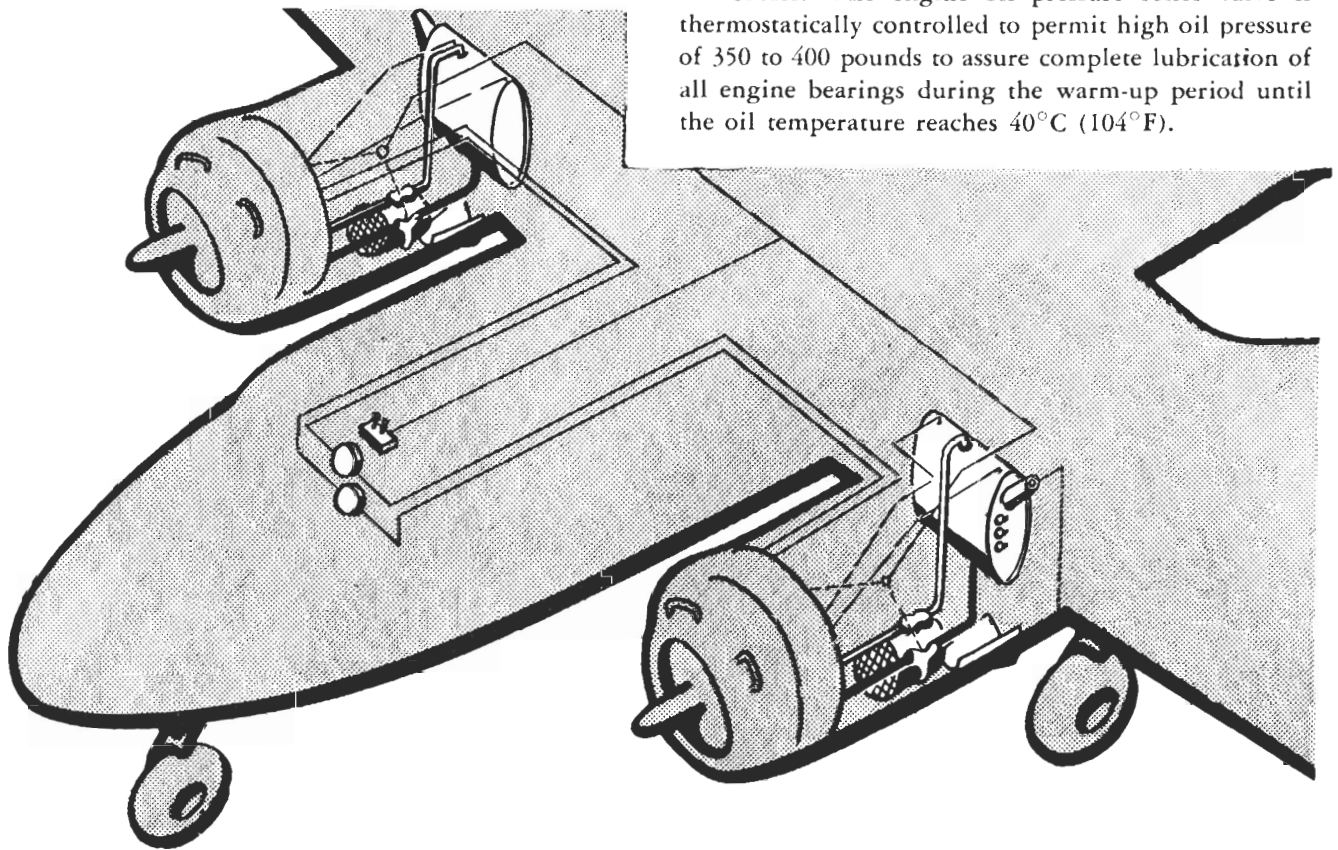













	Oil Dilution Switch		Gage Chocks		Oil Inlet
	Oil Dilution Solenoid		Automatic Temp. Control		Oil Outlet
	"Y" Drain Valve		Temp. and Press. Gages		Vent Line
		TANK CAPACITY 41.3 U.S. (34.3 IMP.) Gals.			Fuel Line
					Electric Line
					Scupper Drain

Figure 25 — Oil System Diagram

1. FUEL SYSTEM. (See figures 26 and 27.)

(1) DESCRIPTION.—The fuel system is a direct simplified type with no crossfeed. Each engine is supplied by a separate system consisting of a main wing tank, auxiliary wing tank, booster pump, strainer, engine driven pump, and connecting lines of self-sealing aromatic fuel-resistant hose. Fuel is transferred through a selector valve from auxiliary wing or bomb bay tanks to the main tanks by a fuel transfer pump. The pump, driven by a reversible electric motor, is controlled by a switch just above the selector valve. Fuel transfers may also be completed by means of the

emergency hand pump in case of failure of the electric pump.

(a) MAIN FUEL TANKS. — The main wing tanks are each made up of three self-sealing aromatic fuel-resistant Mareng cells interconnected at the forward and aft upper and lower corners. Each cell has a drain fitting in the bottom. The auxiliary wing tanks each consist of two interconnected self-sealing aromatic fuel-resistant Mareng cells with fittings similar to those installed on the main tanks. Fuel flows from the main tanks through forward and aft outlets directly to the booster pumps. The booster pumps should always be in operation during take-off and landing. Priming is effected through a solenoid valve which delivers fuel direct to the top eight cylinders through a primer distributor.

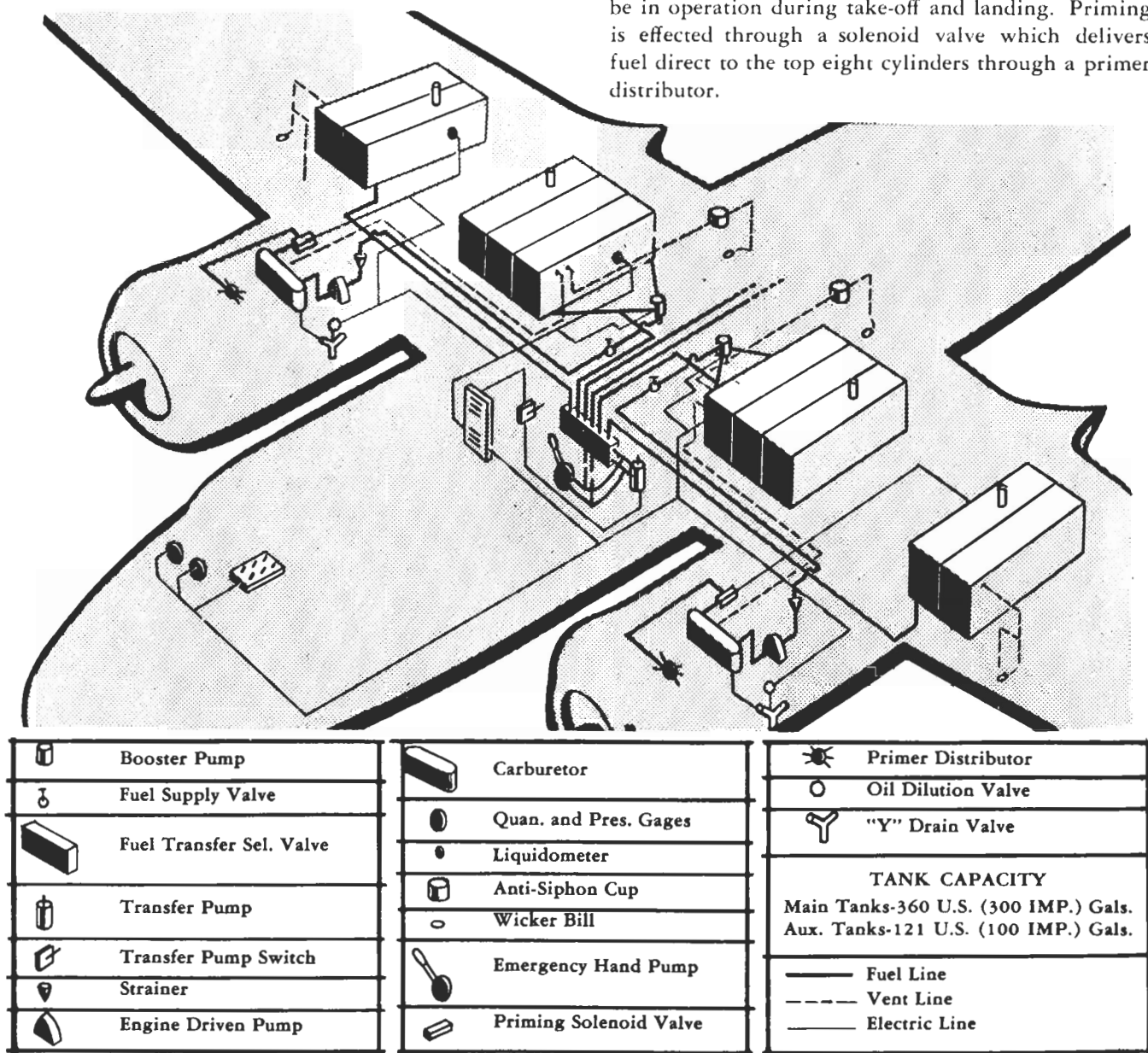

Figure 26 — Fuel System Diagram

(b) FUEL SYSTEM MANAGEMENT.

1. NORMAL OPERATION.

a. GENERAL.

(1) Fuel is transferred through a selector valve from the auxiliary wing and bomb bay tanks to the main tanks by a reversible electric pump. Two selector handles with dial markings for each tank are mounted on the inboard side of the selector valve.

(2) It is possible to transfer fuel from any tank indicated on one dial to any tank indicated on the other, or to transfer fuel between two tanks indicated on the same dial by first pumping into an intermediate tank.

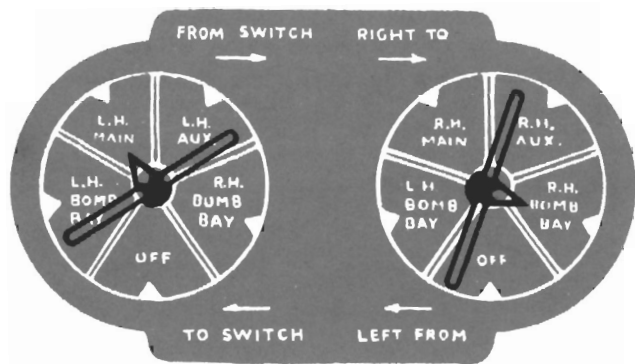

(a) Turn Aft Selector Handle to L.H. MAIN.

(b) Turn Forward Selector Handle to R.H. BOMB BAY.

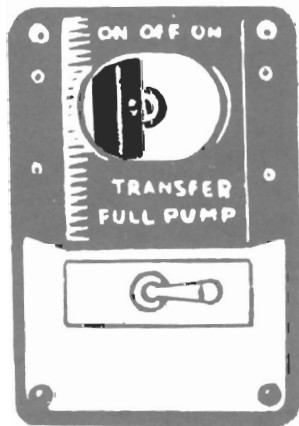

(c) Push Transfer Pump Switch AFT to "ON" position.

(3) The direction of fuel flow is determined by the setting of the three-position transfer pump switch. The switch is pushed forward to pump from tanks indicated on the aft dial to tanks indicated on the forward dial, and pushed aft to reverse the flow.

(4) The switch must be turned "OFF" immediately when the warning light glows, denoting that the tank from which fuel is being pumped has been emptied. The pilot's fuel gage should also be constantly checked.

(5) EXAMPLE.—To transfer fuel from the right hand forward bomb bay tank to the left hand main fuel tank.



(d) Check L.H. MAIN tank fuel level with Pilot's Fuel Gage.



(e) The WARNING LIGHT flashes when the R.H. BOMB BAY tank is empty.

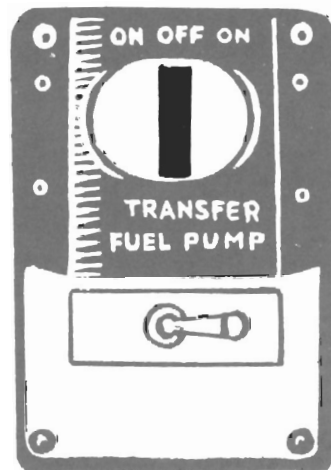

(f) Turn Transfer Pump Switch "OFF" immediately when the warning light flashes.

2. EMERGENCY OPERATION.

a. GENERAL.

(1) If the electric transfer pump fails, fuel may be transferred by connecting the hose lines from the emergency hand pump to the outlet fittings under the selector valve. The red hose on the forward outlet corresponds to SWITCH LEFT settings on select or valve dials, and the red hose on the aft outlet corresponds to SWITCH RIGHT selector valve settings.

(2) EXAMPLE.—To transfer fuel from the right hand forward bomb bay tank to the left hand main tank.

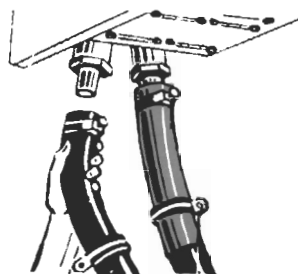

(d) Remove plugs and connect BLACK hand pump hose to aft outlet fitting.

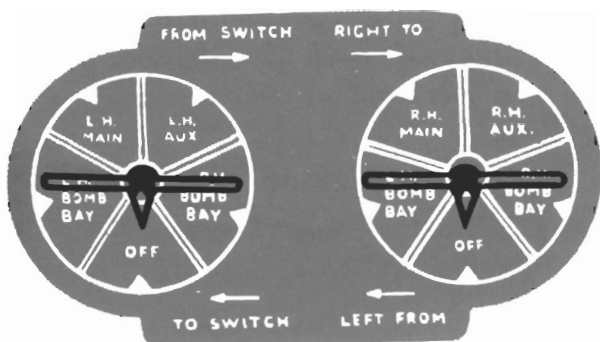

(a) Turn Selector Handles "OFF."

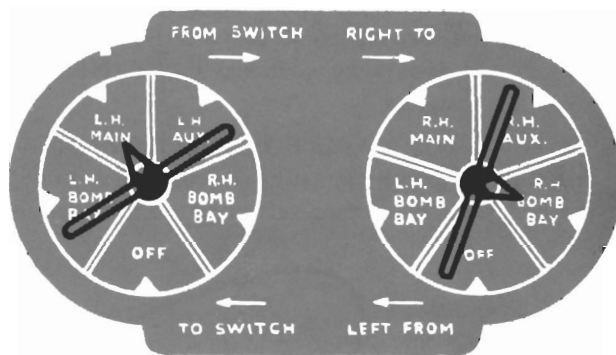

(e) Turn Aft Selector to L.H. Main.

(f) Turn Forward Selector to R.H. Bomb Bay.

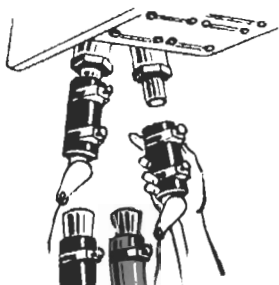

(b) Remove plug from FORWARD outlet fitting.

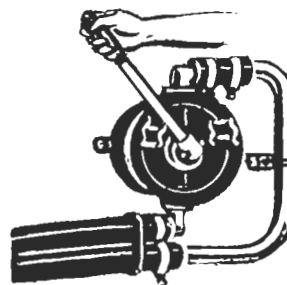

(g) Hand pump at a rate of approximately one stroke per second.

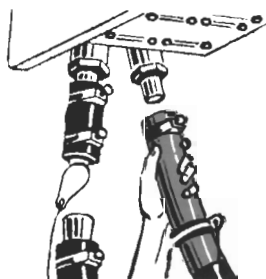

(c) Remove plug from RED hand pump hose and connect to forward outlet fitting.

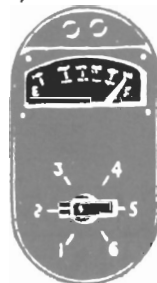

(h) Watch Warning Light and check Pilot's Fuel Gage constantly.

(c) BOMB BAY FUEL TANKS. (See figure 27.)—Additional fuel tanks may be installed in both the forward and aft bomb bays, increasing the fuel carrying capacity of the airplane by 1000 U.S. gallons (833 Imperial gallons). Forward bomb bay tanks are connected to the fuel system by self-sealing aromatic fuel-resistant hose, and aft bomb bay tanks are connected by metal tubing. Bomb bay tanks are connected through a breakable union and may be salvaged with the same controls which are used for bomb salvo. The switch on the forward bomb bay dome light box disconnects the forward bomb bay electric release circuit and should always be switched to "TANKS" when tanks are installed.

1. FORWARD BOMB BAY TANKS.—The two forward bomb bay tanks are connected directly to the fuel transfer selector valve and are included in the

normal fuel transfer system. The forward bomb bay tanks are filled directly through filler necks extending through the top of the fuselage and have liquidimeters which read on the pilot's instrument panel.

2. AFT BOMB BAY TANKS. — The aft bomb bay tanks are not furnished with filler necks or liquidimeters and are filled indirectly through the left forward bomb bay tank. Fuel is transferred from the aft bomb bay tanks by setting the aft bomb bay tank selector valve to the tank to be emptied. Both aft bomb bay tanks are connected to the fuel transfer selector valve through the same hose as the left forward bomb bay tank. All transfers from the aft tanks are made by setting the fuel transfer selector valve to the left forward bomb bay tank. Some aircraft do not contain aft bomb bay tanks.

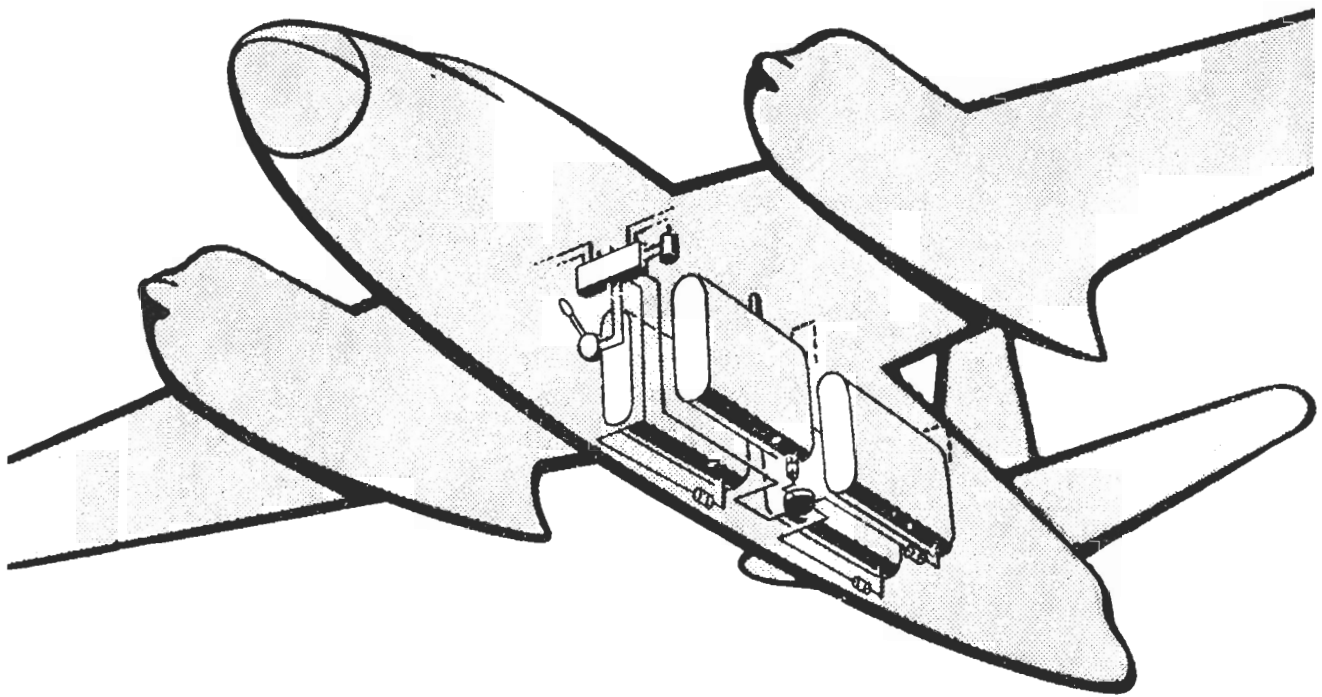









	Fuel Transfer Sel. Valve		Emergency Hand Pump	<b>TANK CAPACITY</b> Each Tank-250 U.S. (208 IMP.) Gals.   Fuel Line  Vent Line
	Fuel Transfer Pump		Breakable Union	
	Liquidimeter		Filler Neck	
	Bomb Bay Tank Sel. Valve			

Figure 27 — Bomb Bay Fuel Tanks

*m. DE-ICING SYSTEM. (See figure 28.)*

(1) DESCRIPTION. — Standard rubber de-icer boots, installed on the leading edge of the wing, fin, and horizontal stabilizer, are operated by a normal air pressure of 7.5 pounds per square inch. Air pressure lines radiate from the air distribution valve to air chambers in the rubber boots. Pressure is regulated by valves at each engine vacuum pump and one at the main oil separator and pressure regulator. A complete cycle of pulsation takes place every 40 seconds.

(2) CONTROLS.—Compressed air for the de-icer boots may be drawn from either the right or left engine compressor by turning the vacuum selector valve in the pilot's compartment to the desired position. The de-icer gage is mounted on the pilot's instrument panel and the distributor valve control lever is at the aft bulkhead of the radio operator's compartment.

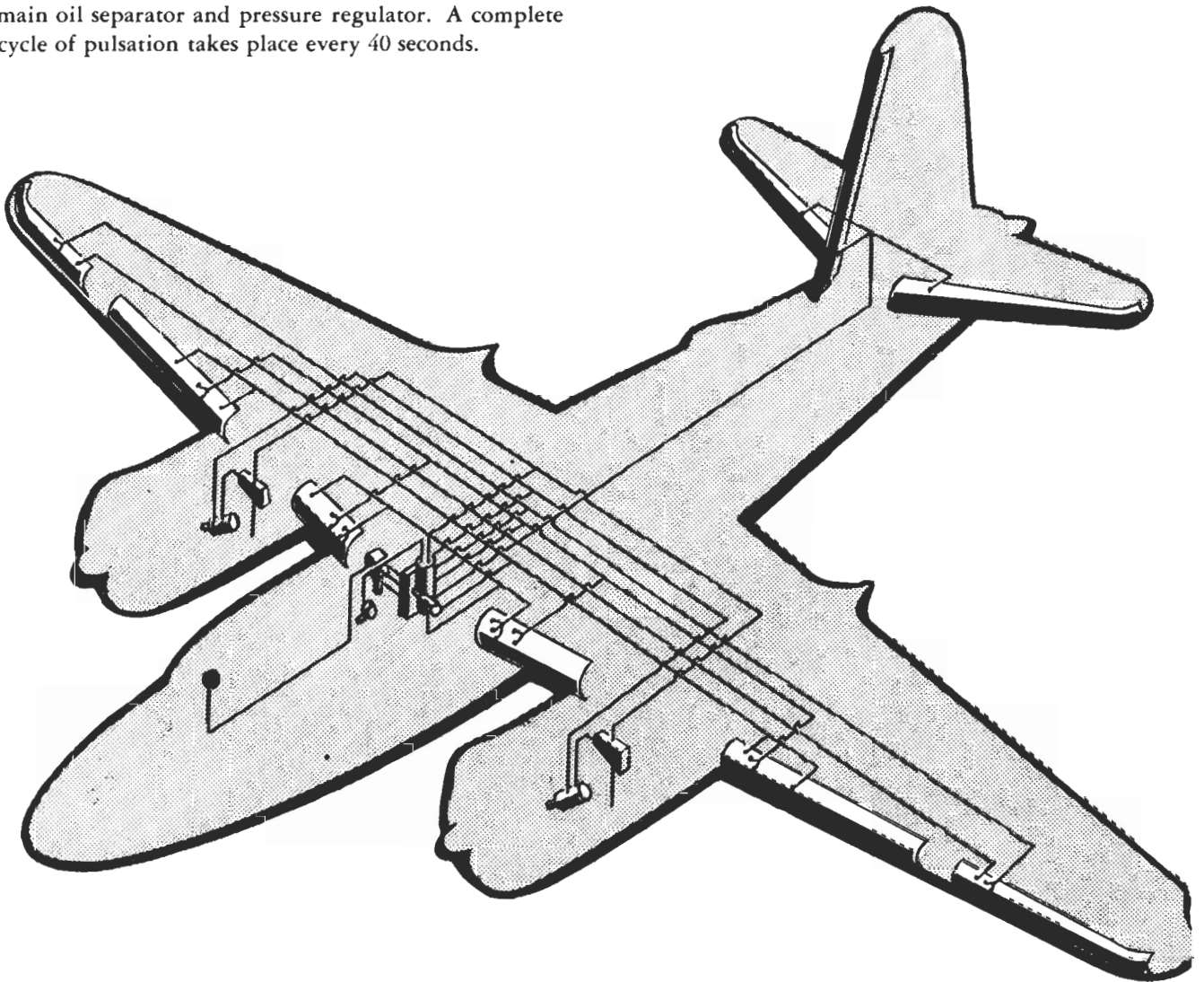







	De-Icer Control Lever		Oil Separator and Pressure Regulator		Vacuum Pump
	Air Distribution Valve		Pressure Gage		De-Icer Boot
			Oil Separator		

Figure 28 — De-Icing System Diagram



n. ANTI-ICING SYSTEM. (See figure 29.)

(1) DESCRIPTION.—Anti-icing fluid is delivered to the propellers, carburetors, and to the pilot's and bombardier's windshields by three separate systems. In some airplanes, there is no fluid windshield anti-icing nor fluid carburetor anti-icing.

(a) PROPELLER ANTI-ICING. — The propellers are equipped with standard slinger rings, to which liquid is fed from a tank in the forward bomb bay. An electric pump, controlled by a rheostat knob on the pilot's instrument panel, pumps fluid from the tank to the slinger rings. The slinger rings distribute fluid evenly over the propeller blades for anti-icing purposes.

(b) CARBURETOR ANTI-ICING.

1. Fluid is fed to the carburetors from tanks in each nacelle cone by electric pumps controlled from the pilot's compartment.

2. Some airplanes have carburetor heat anti-icing. This carburetor heat anti-icing unit consists of

a large aluminum duct, two shutters, and an air thermometer. A shutter has been provided at each air intake, operation of which provides hot air from the cylinders or cold air from the outside. These shutters are operated from the pilot's cockpit by hydraulic controls.

(c) WINDSHIELD ANTI-ICING.

1. Perforated tubes arranged on the pilot's and the bombardier's windshields distribute fluid evenly over the surface of the glass. Separate electric pumps, controlled by a switch on the pilot's instrument panel, pump fluid to each windshield from a single tank in the aft bomb bay. Conveniently located dispensing valves control the flow of anti-icing fluid through each line.

2. Some airplanes are provided with removable Raymond de-icer panels of Plexiglas, which are enclosed in a metal frame containing slotted openings for the delivery of hot air uniformly over the surface of the windshield or window, and which provide anti-icing for the pilot's and bombardier's windshields.

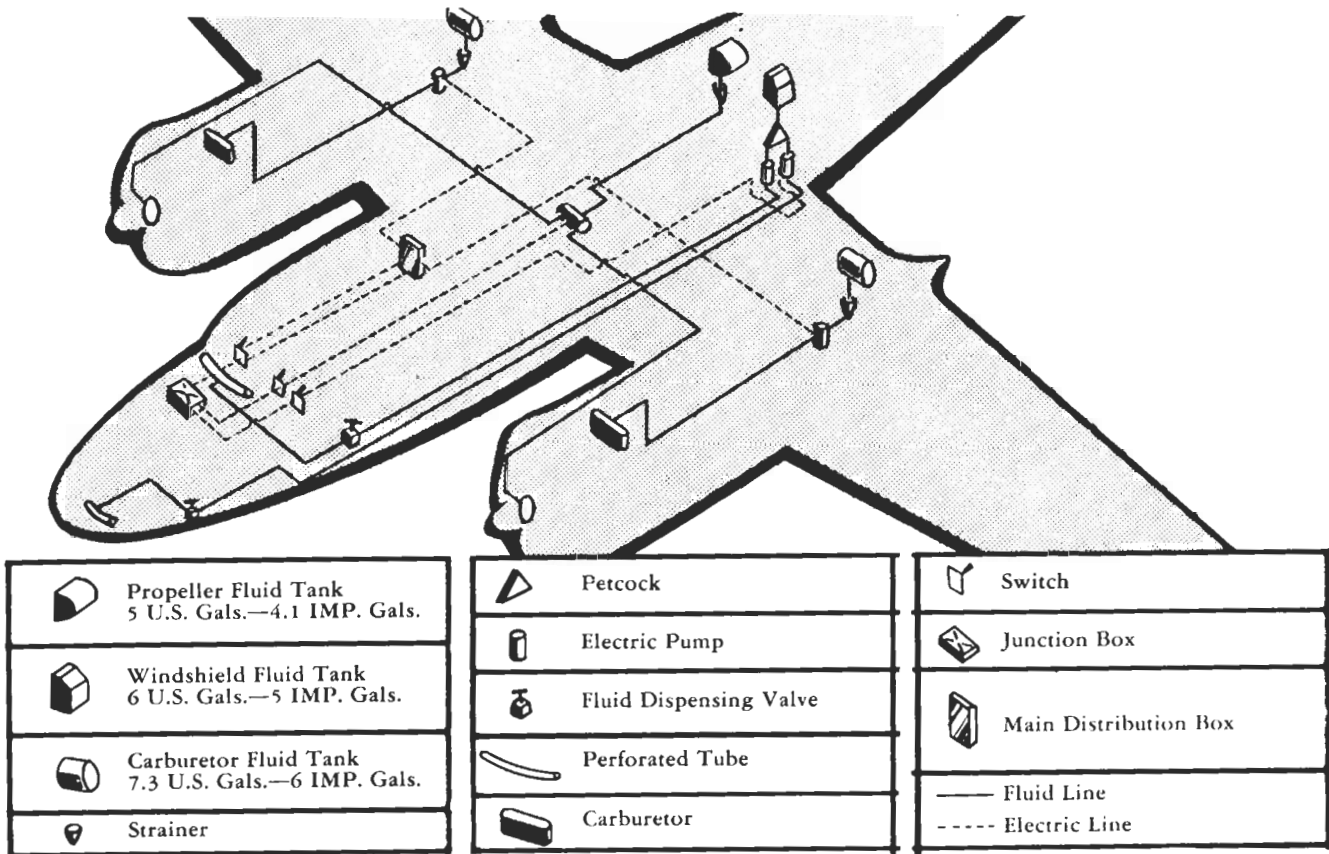

Figure 29 — Anti-Icing System Diagram

*o.* HEATING AND VENTILATING SYSTEM  
(See figure 30.)

(1) DESCRIPTION.—Heat is supplied to the airplane by exhaust manifold heaters installed on the in-board exhaust stack of each engine. Hot air supplied to the forward compartments from the right engine manifold heater may be tempered with cold air from an intake just inboard of the right nacelle. Heat for the aft compartments is supplied by the left engine manifold heater. Master control dampers are regulated by the three heat control-handles on the aft bulkhead of the navigator's compartment. The handles may be pulled out to any required setting and are held in place by friction locks. On some airplanes spill valves are provided on top of the cold air intake lines in the nacelle to regulate the temperature.

(a) FORWARD COMPARTMENTS.—Heat is supplied directly to the bombardier's and pilot's compartments through adjustable sliding grates. An adjustable sliding grate is also provided for the navigator's compartment on some aircraft. The radio operator's compartment is amply heated by overflow from

the forward compartments. Defroster tubes are installed at the pilot's and bombardier's windshields. Supplementary disc-type ventilators are provided for the pilot, co-pilot, radio operator and navigator.

(b) AFT COMPARTMENTS.—Heat for the aft compartments is delivered through two adjustable outlets. The waist compartment is supplied by an anemostat box which is replaced by a sliding grate on later aircraft, and the tail gun compartment by an adjustable sliding grate which is also replaced on later aircraft by a butterfly valve at the end of the main duct and two flexible defroster tubes which angle off the main line to each side window. Suit heater panels are installed at the turret, waist, and tail gun positions. A rheostat knob of the suit heater panel controls the current supplied to heated clothing. A master circuit breaker switch, located near the turret, controls the flow of current to the waist and tail gunner's heated clothing. To prevent over-loading the generators while the turret is in operation, this switch should be thrown "OFF."

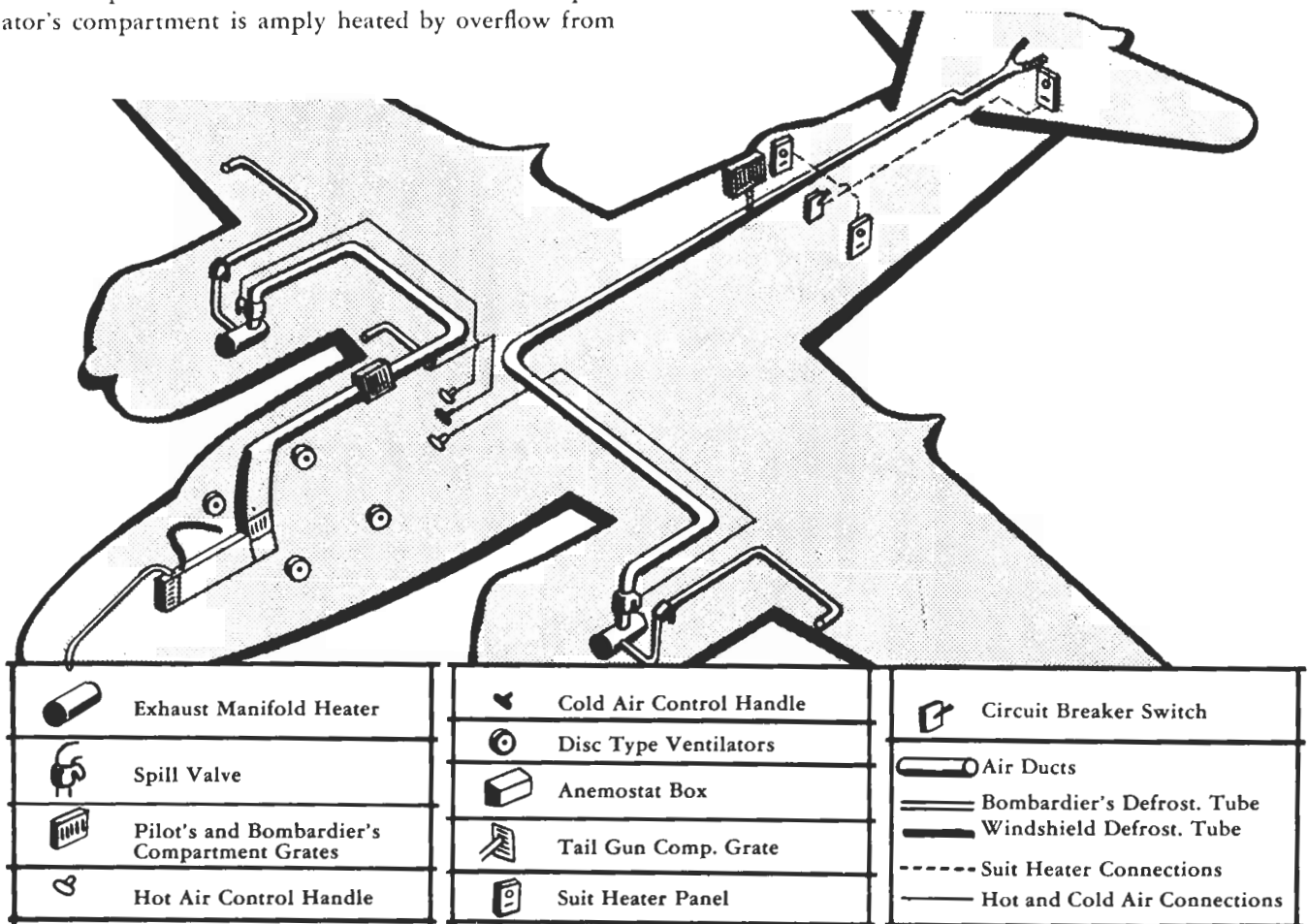

Figure 30 — Heating and Ventilating System Diagram



*p.* ARMOR PLATE PROTECTION.

(See figure 31. Sheet 1 and 2.)

(1) DECK TURRET GUNNER'S PROTECTION. (See figure 31.)—The deck turret gunner's armor plate is in two sections, the upper section and the lower section. The upper section of the armor plate is attached to the turntable casting, while the lower section of the armor plate serves as a support for the ammunition boxes.

(2) PILOT'S PROTECTION. (See figure 31.)—The pilot's strafing armor plate is attached to the frame immediately forward of the dividing bulkhead for the pilot's and bombardier's compartments. The pilot's seat armor plate is installed on the back of the seat.

(3) RADIO OPERATOR'S PROTECTION. (See figure 31.)—The radio operator's armor plate is installed on the back of the seat.

(4) CO-PILOT'S PROTECTION.—The co-pilot's armor plate is located to the rear of the co-pilot's seat.

(5) BOMBARDIER'S PROTECTION. (See figure 31.)—The bombardier's armor plate, double in thickness, is installed in the bombardier's compartment at the bulkhead just aft of the bombardier's seat.

(6) TAIL GUNNER'S PROTECTION. (See figure 31.)—The tail gunner's compartment armor plate consists of an upper section and a lower section (the lower section containing two doors, one on each side), installed vertically just aft of the tail gunner's seat.

(7) WAIST GUNNER'S PROTECTION.—The waist gunner's armor plate is in three sections which are attached to the provisions incorporated in the airplane floor.

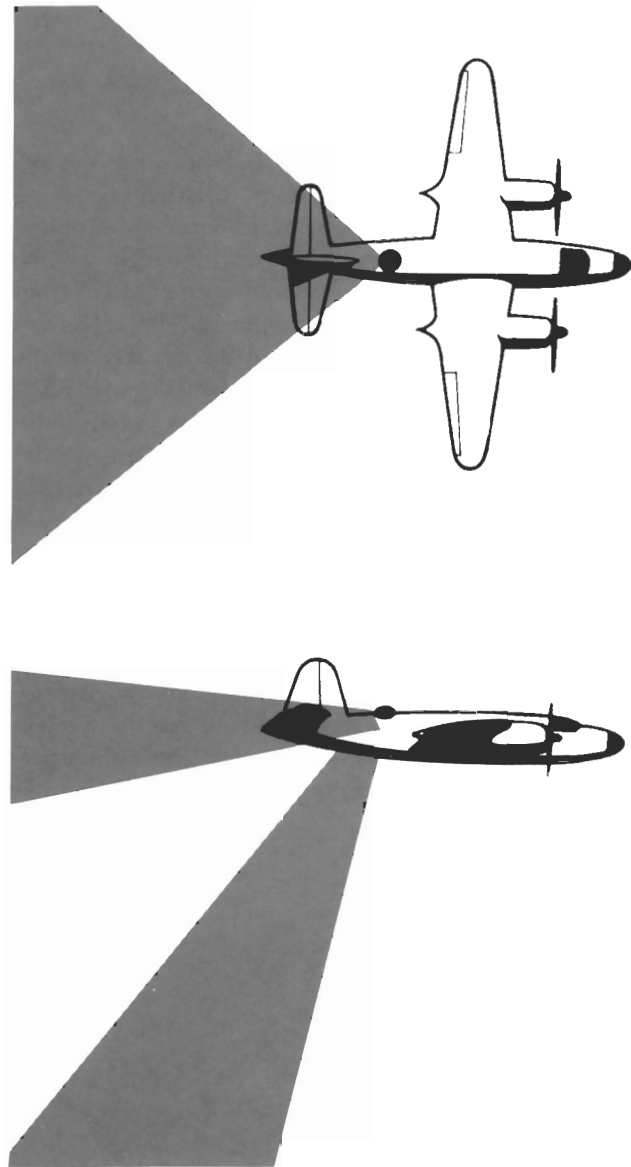

Deck Turret

Figure 31 — Armor Protection (Sheet 1 of 2 Sheets)

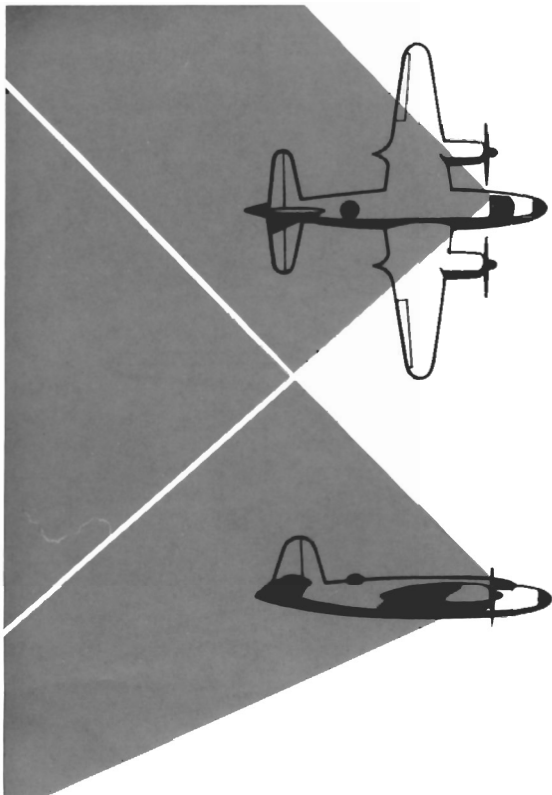

**Pilot's Armor Protection**

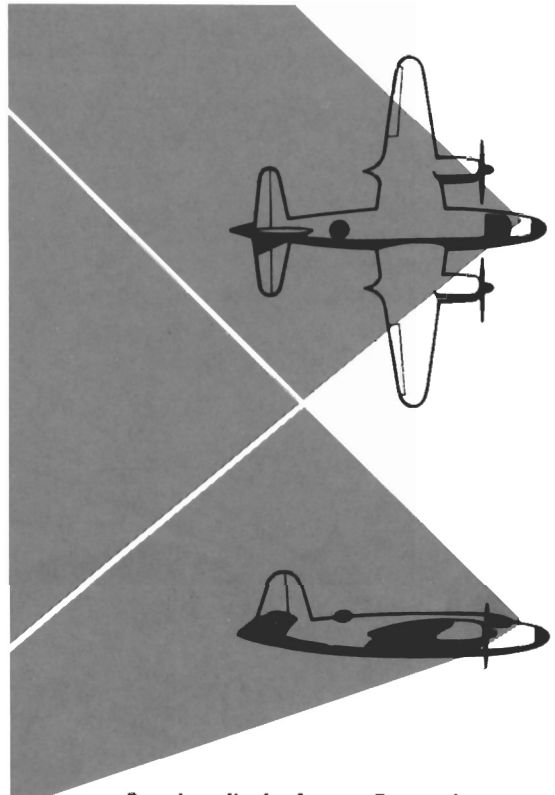

**Bombardier's Armor Protection**

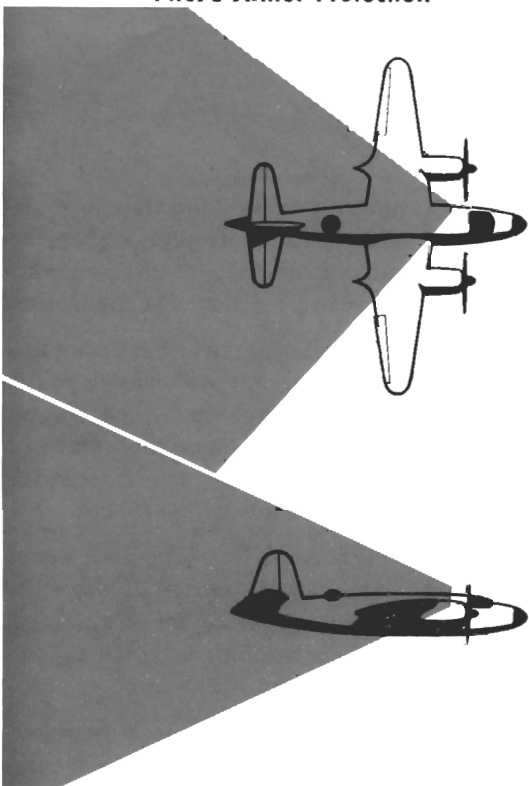

**Radio Operator's Armor Protection**

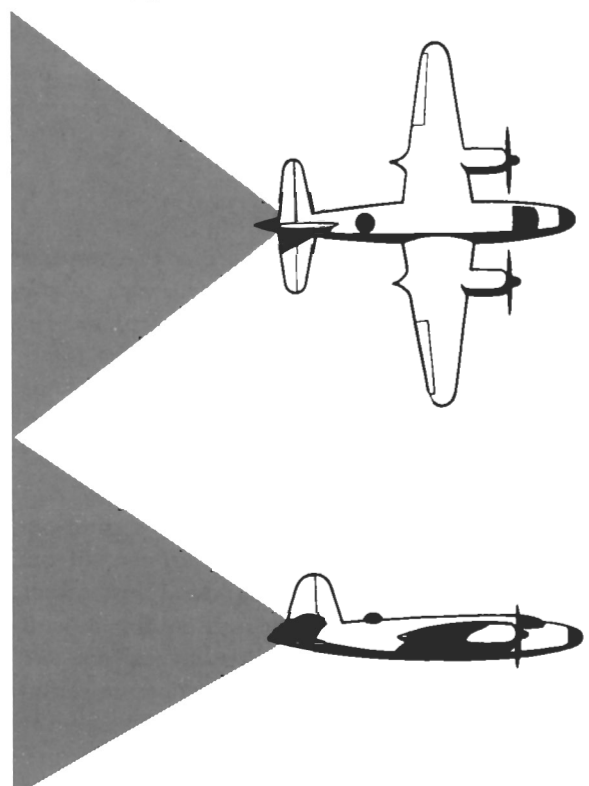

**Tail Gunner's Armor Protection**

**Figure 31 — Armor Protection (Sheet 2 of 2 Sheets)**

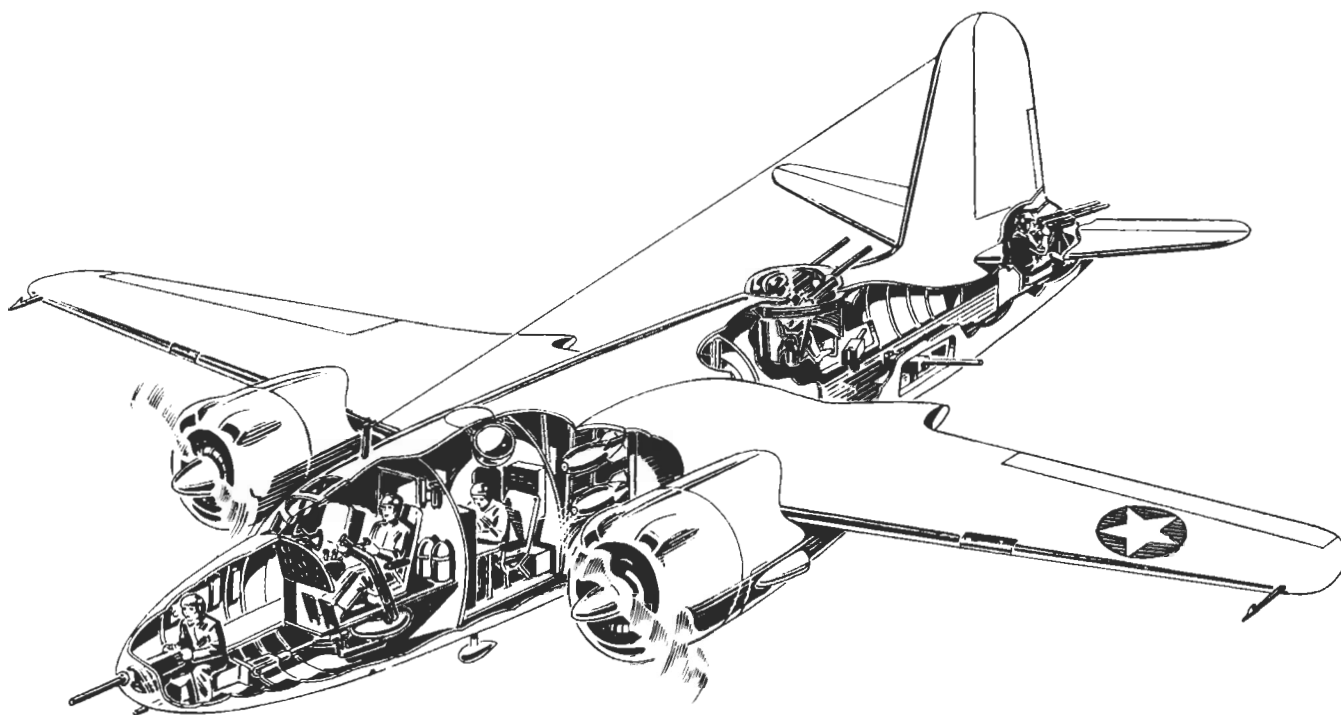

## 2. MOVEMENT OF FLIGHT PERSONNEL.

*a. BOMBARDIER.*—The bombardier's compartment extends from the bulkhead just forward of the pilot's instrument panel to the nose of the airplane. He can contact other crew members by use of the interphone or by hand signals to the pilot. Entrance is gained through the right-hand side of the pilot's compartment. Exit is through nose gear hatch or pilot's escape hatch.

*b. PILOT AND CO-PILOT.*—The pilot's compartment extends from the bulkhead just forward of the pilot's instrument panel to the bulkhead just aft of the pilot's and co-pilot's chairs. It is equipped with flight controls, engine controls, instruments, and two adjustable chairs. Interphone provides communication with the other crew members. Exit is through the pilot's escape hatch or the nose gear hatch.

*c. RADIO OPERATOR AND NAVIGATOR.*—The radio operator's and navigator's compartment is located directly behind the bulkhead aft of the pilot's and co-pilot's chairs and extends to the bomb bay bulkhead. It is equipped with two adjustable swivel chairs, a radio cabinet, all necessary radio equipment,

and a navigator's plotting table. Interphone communication is provided. Exit is through either the navigator's hatch located in the top of the compartment or the life raft stowage hatch or the bomb bay.

*d. WAIST GUNNER.*—The waist gun compartment is located aft of the bomb bay and extends to the tail compartment. Two hatches are provided one on each side for extension of the guns, which serve as escape hatches in case of an emergency. Interphone communication is provided in this compartment.

*e. DECK TURRET OPERATOR.*—The deck turret entrance is located in the forward section of the waist compartment. Interphone is provided for communication with other crew members. Exit is by waist compartment hatch or by bomb bay.

*f. TAIL GUNNER.*—The tail gunner's compartment extends from the aft bulkhead of the waist compartment to the tail of the airplane. Emergency exit, when airplane is on the ground, is through the hatch on the right-hand side of the forward tail section, while emergency exit in flight, is through either of the waist gun hatches. Interphone is provided for communication with other crew members.

## SECTION II PILOT OPERATING INSTRUCTIONS

### 1. FLIGHT RESTRICTIONS.

Any maneuvers such as intentional spins, loops, etc., or deviations from the conventional maneuvers, are strictly prohibited.

### 2. BEFORE ENTERING PILOT'S COMPARTMENT.

*a.* Work out flight plan with the flight operation instruction charts. Consult take-off, climb, and land-

ing chart. Check distribution of weight with the load adjuster.

*b.* Enter through the nose gear well and unlock the entrance hatch sliding doors to gain direct access to the pilot's compartment.

### 3. ON ENTERING PILOT'S COMPARTMENT.

Remove the pilot's list from the data case and proceed with the normal check for all flights.

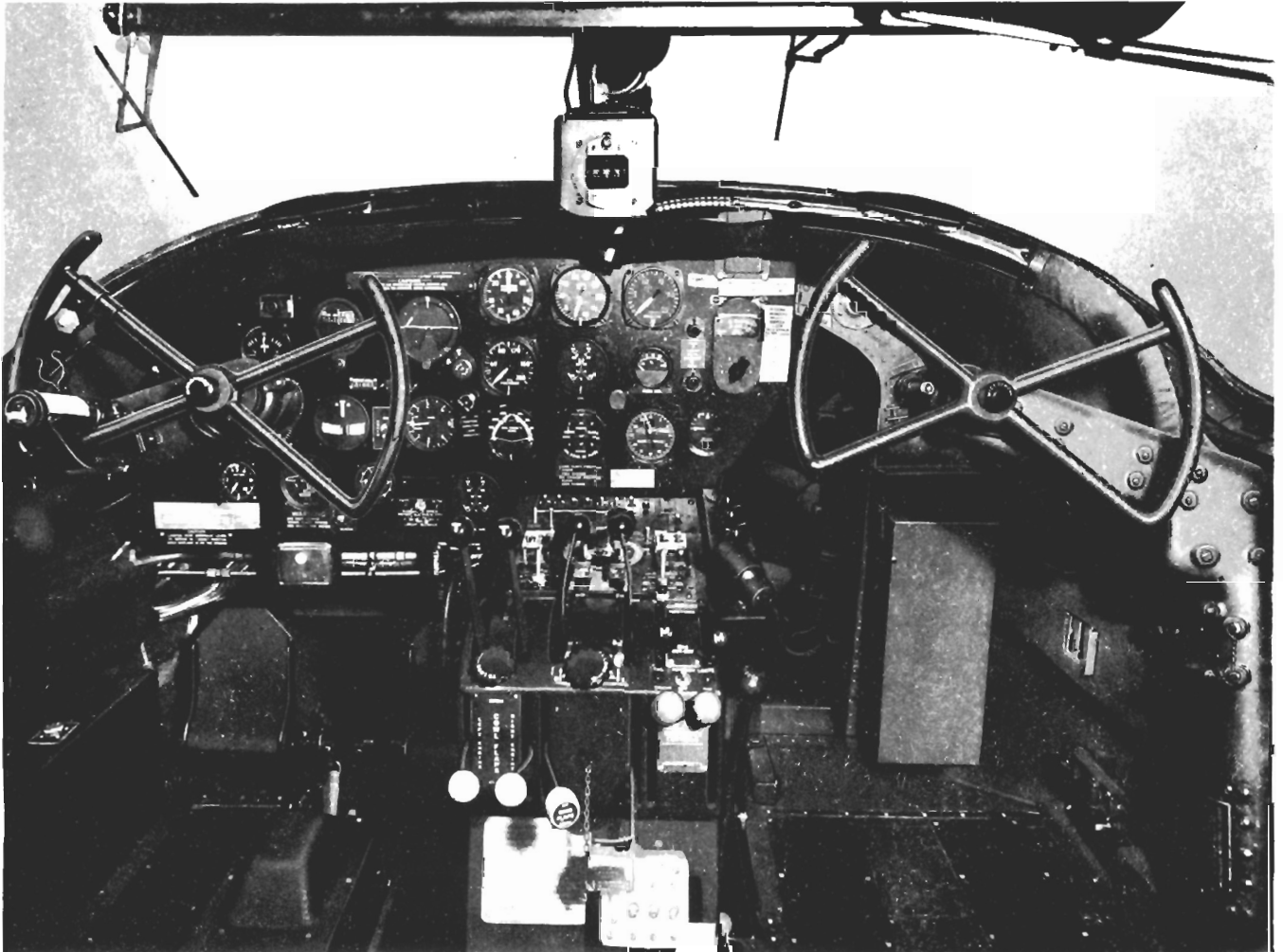
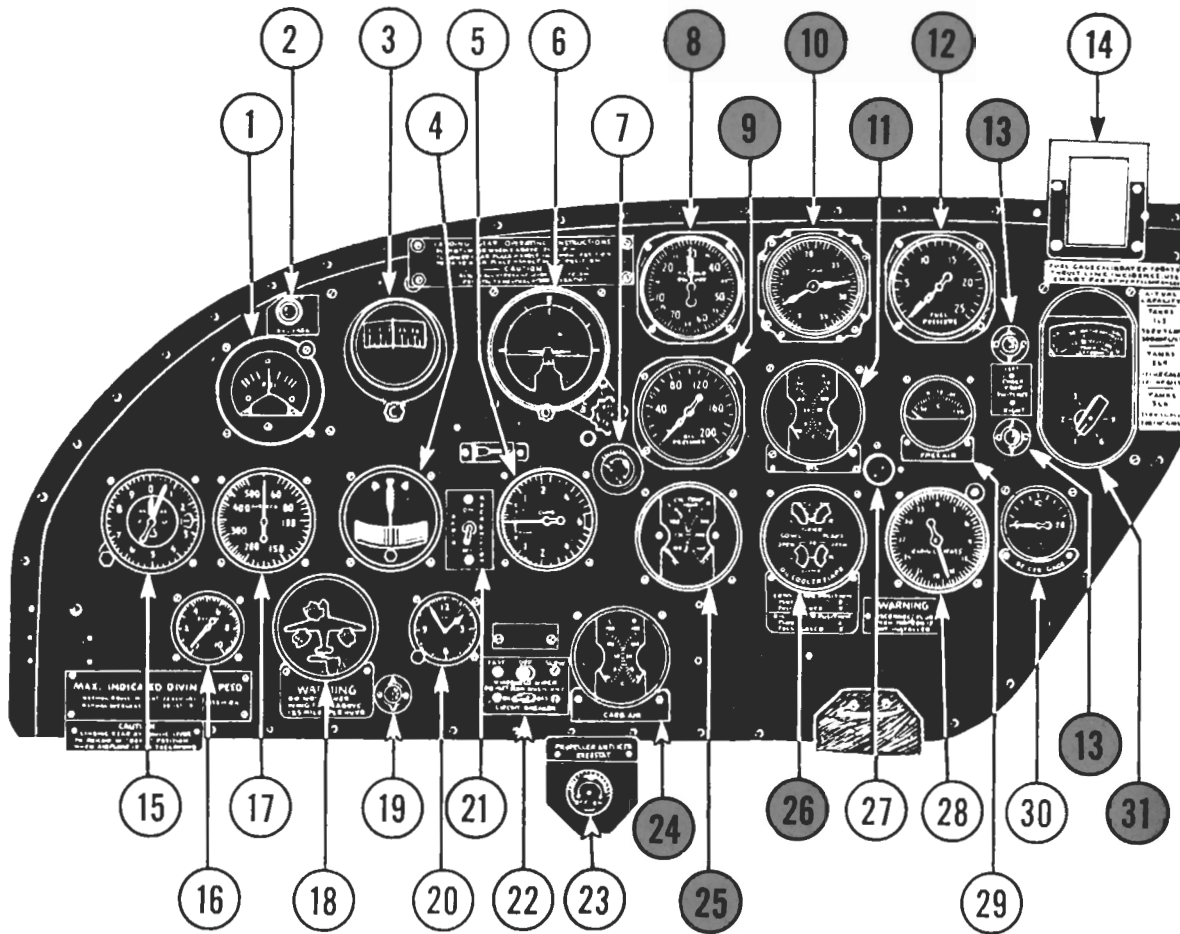
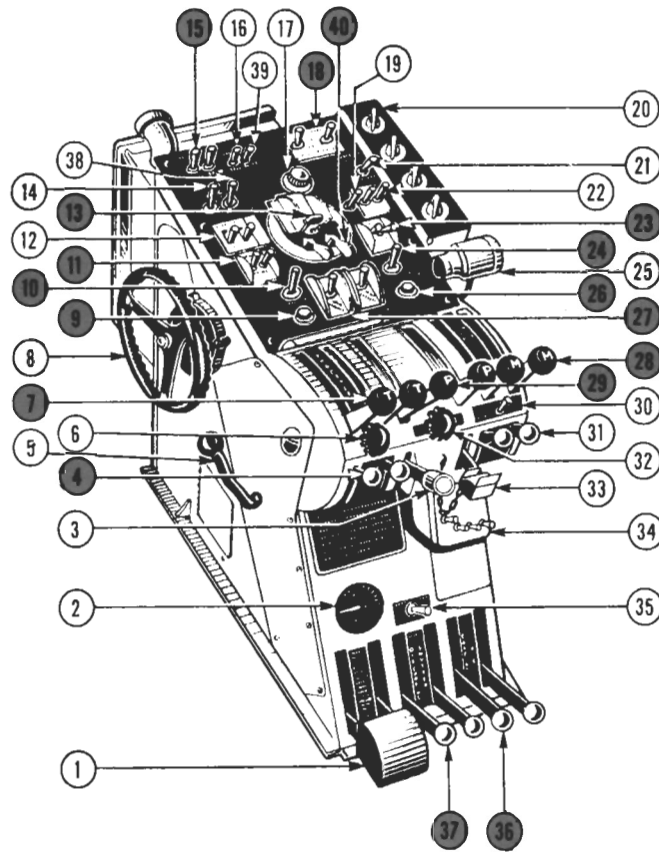

Figure 32 — Front View of Pilot's Compartment



Ref. No.	Nomenclature	Ref. No.	Nomenclature
1	<i>P.D.I. Gage</i>	17	<i>Airspeed Gage</i>
2	<i>Bomb Release Signal Light</i>	18	<i>Landing Gear and Wing Flap Indicator</i>
3	<i>Compass</i>	19	<i>Marker Beacon</i>
4	<i>Turn and Bank Indicator</i>	20	<i>Clock</i>
5	<i>Rate of Climb Gage</i>	21	<i>Radio Recognition Switch</i>
6	<i>Gyro Horizon</i>	22	<i>Windshield Wiper Switch</i>
7	<i>Torpedo Director Light Rheostat</i>	23	<i>Propeller Anti-Icer Rheostat</i>
8	<i>Manifold Pressure Gage</i>	24	<i>Carburetor Air Temperature Gage</i>
9	<i>Oil Pressure Gage</i>	25	<i>Cylinder Head Temperature Gage</i>
10	<i>R.P.M. Gage (Tachometer)</i>	26	<i>Oil Cooler and Cowl Flaps Gage</i>
11	<i>Oil Temperature Gage</i>	27	<i>Torpedo Plug-in</i>
12	<i>Fuel Pressure Gage</i>	28	<i>Radio Compass</i>
13	<i>Propeller Check Switches</i>	29	<i>Free Air Temperature Gage</i>
14	<i>Compass Correction Card Holder</i>	30	<i>De-Icer Gage</i>
15	<i>Altimeter</i>	31	<i>Fuel Gage</i>
16	<i>Suction Gage</i>		

Figure 33 — Pilot's Instrument Panel



Ref. No.	Nomenclature	Ref. No.	Nomenclature
1	Blowers and Guard	21	Inverter Switch
2	Hydraulic Pressure Gage	22	Left and Right Battery Switches
3	Wing Flaps Control Lever	23	Left and Right Oil Dilution Switches
4	Right and Left Cowl Flaps Control Levers	24	Right Hand Propeller Toggle Switch
5	Parking Brake Lock Lever	25	Fluorescent Light
6	Throttle Lock	26	Circuit Breaker Propeller
7	Right and Left Throttles	27	Left and Right Propeller Feathering Switches
8	Elevator Controls	28	Mixture Control Levers
9	Circuit Breaker—Propeller	29	Propeller Governor Control
10	Left hand Propeller Toggle Switch	30	Tail Position Lights Switch
11	Starter Energizing and Mesh Switches	31	Landing Gear Emergency Control Levers
12	Left and Right Landing Light Switches	32	Propeller Governor Control Lock
13	Master Switch—Ignition	33	Landing Gear Lever
14	Signal Lights Switch—Interior	34	Identification Lights—Switch Box
15	Left and Right Engine Primer Switches	35	Pedestal Light Switch
16	Alarm Bells Switch	36	Carburetor Air Control Levers
17	Formation Light Rheostat	37	Oil Cooler Shutter Control Levers
18	Left and Right Fuel Booster Switches	38	Compass Light Switch—Removed on later airplanes
19	Wing Position Light Switch	39	Pitot Heater Switch
20	Ultra Violet Instruments Light Switch Panel Pilot's Column Co-Pilot's Column Pedestal Switch Panel	40	Left and Right Magneto Switches

Figure 34 — Pilot's Pedestal



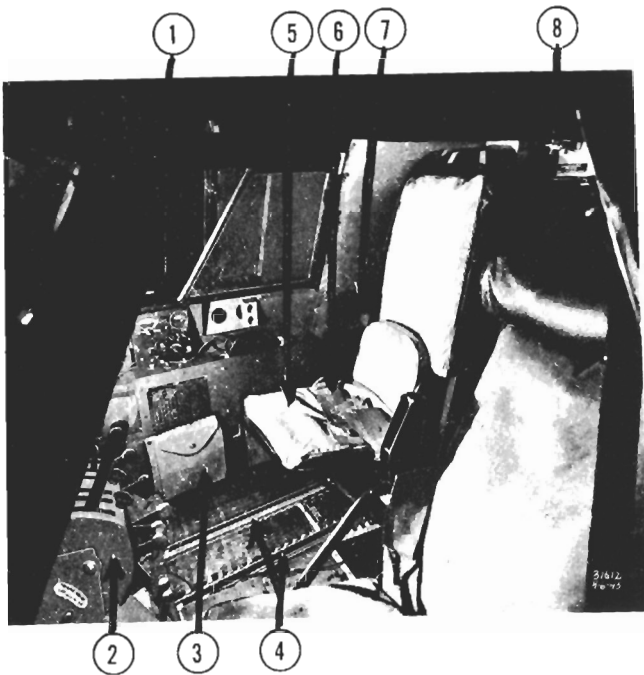

- | Ref. No. | Nomenclature                    |
|----------|---------------------------------|
| 1        | Radio Compass Control Box       |
| 2        | Pilot's Pedestal                |
| 3        | Blind Flying Hood Case          |
| 4        | Co-Pilot's Seat Track           |
| 5        | Co-Pilot's Seat                 |
| 6        | Co-Pilot's Safety Belt          |
| 7        | Air Duct Outlet                 |
| 8        | Emergency Air Brake Bleed Valve |

Right View



- | Ref. No. | Nomenclature                   |
|----------|--------------------------------|
| 1        | Water Bottle                   |
| 2        | Fire Extinguisher              |
| 3        | Data Case                      |
| 4        | Control Locks Stowage          |
| 5        | Torpedo Release Switch Stowage |
| 6        | Oxygen Bottle                  |
| 7        | Pressure Regulator             |
| 8        | Load Adjuster Stowage Clip     |
| 9        | Pressure Gage                  |
| 10       | Filler Valve                   |

Aft View

Figure 35 — Pilot's Compartment



Figure 36 — Left View of Pilot's Compartment

a. BEFORE STARTING ENGINES.

- (1) Unlock controls and check Forms 1 and 1A.
- (2) Check to see that pitot tube covers are removed.
- (3) Check fuel tanks visually.
- (4) Check to see that fuel tank caps are secured.
- (5) Check to see that fuel tank valves are turned "ON." (Forward bomb bay, each side of door.) (See figure 37.)

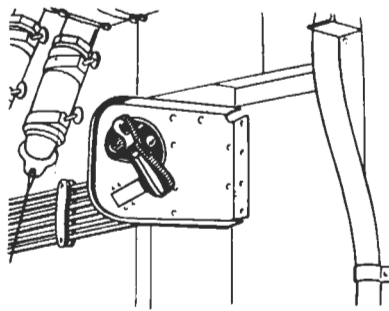

Figure 37 — Fuel Tank Valve

- (6) Check to see that generators are turned "ON." (See figure 38.)

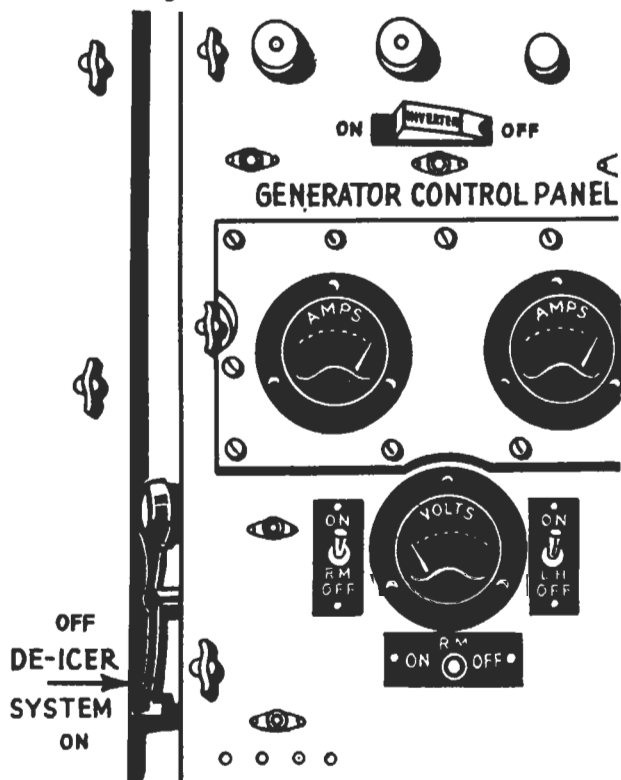

Figure 38 — Generator Control Panel

- (7) Check to see that main inverter cut-off switch has been turned "ON."

- (8) Check to see that de-icer lever is set to "OFF" position (navigator's compartment). (See figure 38.)

- (9) Check to see that the bomb bay door selector handle is in the "CLOSED" position (bombardier's compartment). (See figure 39.)

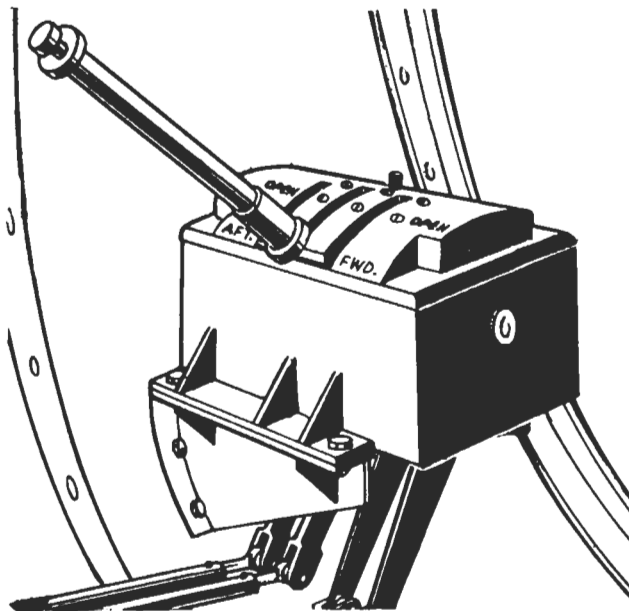

Figure 39 — Bomb Bay Door Selector Handle

- (10) Check flight controls and trim tabs, having co-pilot observe movement of surfaces.

- (11) Have co-pilot close and lock overhead hatches. (See figure 40.)

- (12) Check to see that landing gear lever is "DOWN" with safety lock installed. (See figure 41.)

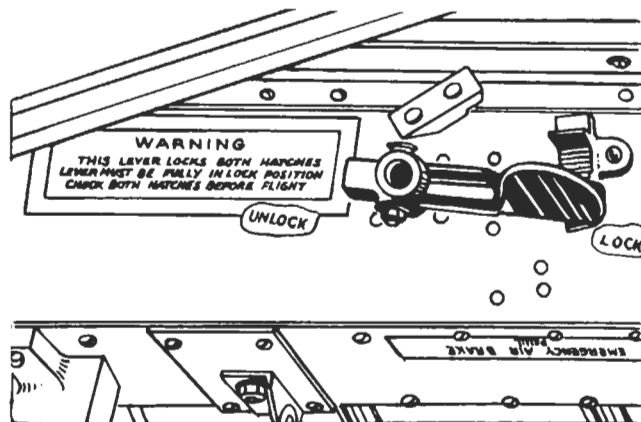

Figure 40 — Hatch Lock Lever

(13) Check to see that emergency landing gear levers are in "NORMAL" position. (See figure 41.)

pressure should read 850 to 1050 pounds per square inch. (See figure 44.)

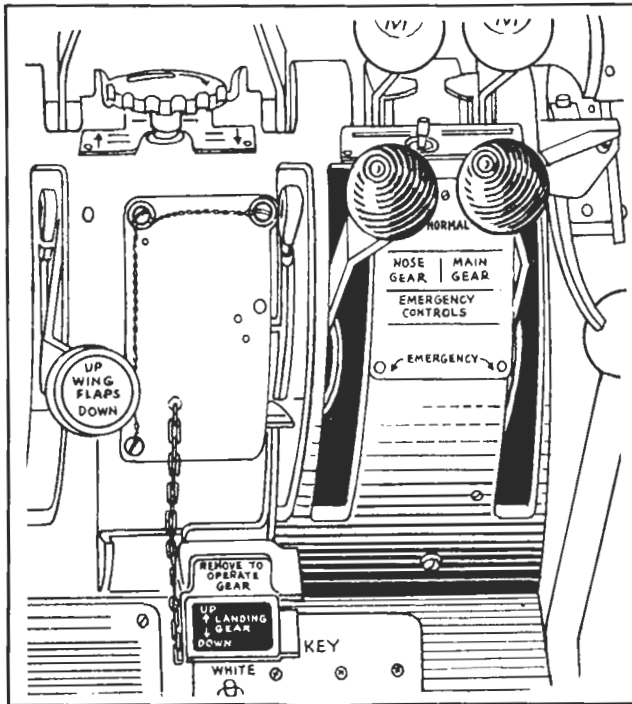

Figure 41—Landing Gear Lever

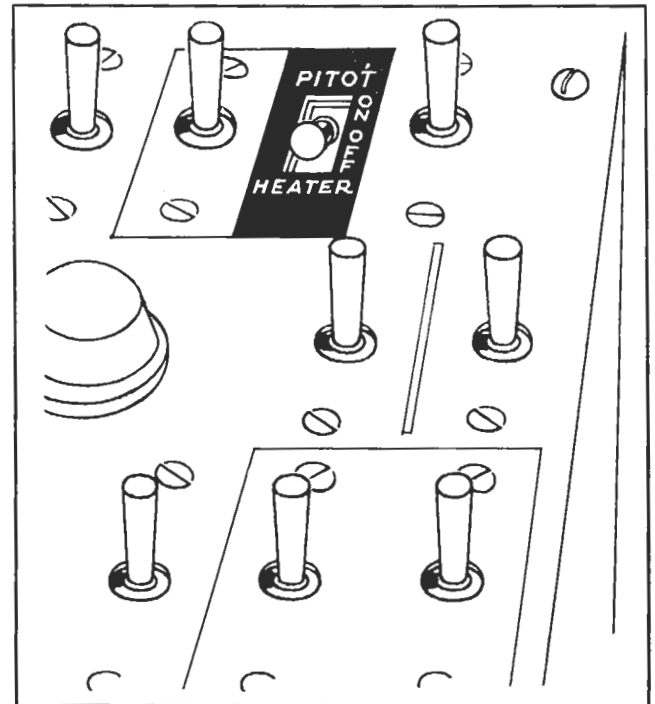

Figure 43—Pitot Heater Switch Location

(14) Check to see that propeller anti-icer rheostat is turned "OFF." (See figure 42.)

(17) Check the emergency air brake bleeder valve, located above the doorway directly back of the pilot and copilot and ascertain that this valve is closed.

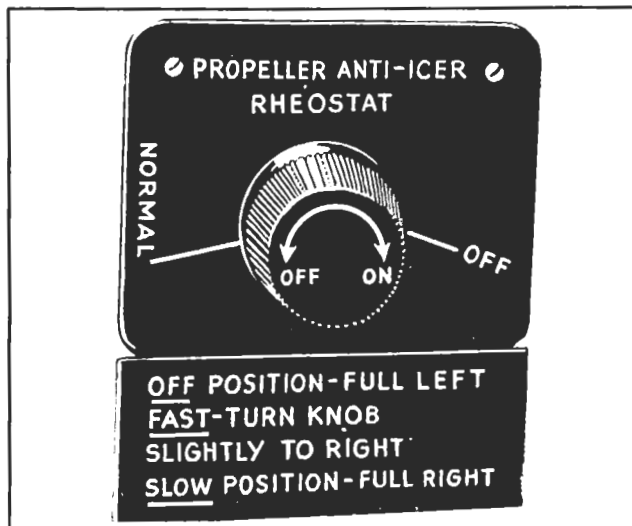

Figure 42—Propeller Anti-Icer Rheostat

(15) Check to see that pitot heater is turned "OFF." (See figure 43.)

(16) Set brakes for parking by depressing the brake pedals equally and fully. Pedals are locked in place by pulling parking brake lever "ON." Hydraulic

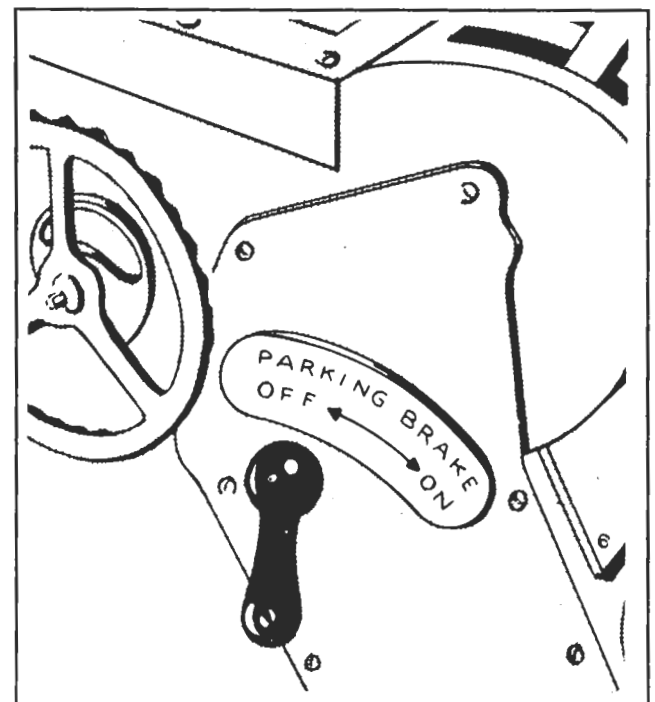

Figure 44—Parking Brake Lever

(18) Master, ignition, and battery switches "OFF."  
(See figure 45.)

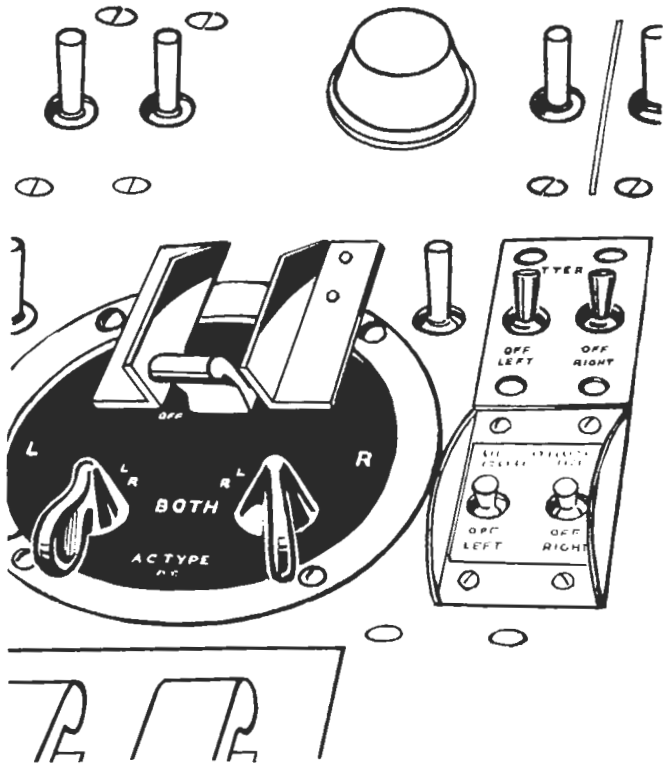

Figure 45—Master, Ignition, and Battery Switches

(19) If engines have been idle for more than 30 minutes, have same pulled through by hand 16 blades in the direction of normal engine rotation.

(20) Have outside power source or auxiliary power plant connected to outlet in left nacelle.

(21) Check that blowers are in "LOW" with safety cover in place.

(22) Adjust oil cooler shutters to suit outside temperature. (See figure 46.)

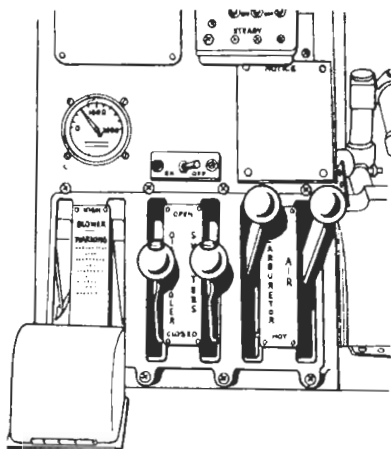

Figure 46—Oil Cooler Shutters Control Levers

(23) Set carburetor air control levers to "COLD" position. (See figure 46.)

**NOTE**

In airplanes which have the carburetor heat anti-icing system, the carburetor air control lever should be placed in the "COLD" position for approximately 10 seconds, and then returned to "Neutral."

(24) Mixture control levers "IDLE CUT-OFF."  
(See figure 47.)

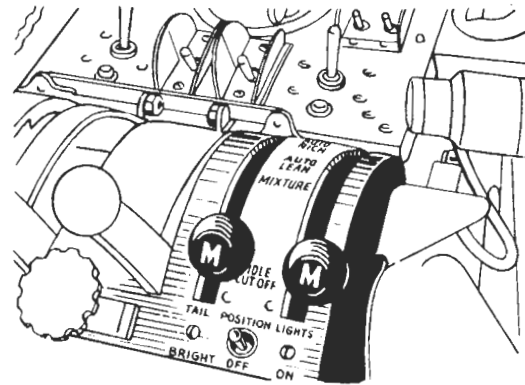

Figure 47—Mixture Control Levers and Propeller Control Levers

(25) Propeller governor control levers full forward to "INC. RPM." (See figure 48.)

(26) Propeller toggle switches "AUTO CONSTANT SPEED" and "FEATHER" switches "NORMAL." (See figure 48.)

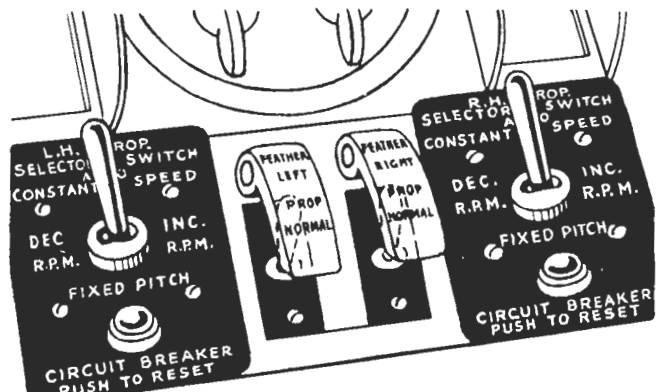

Figure 48—Propeller and Feathering Switches

(27) Cowl flap "OPEN," levers "NEUTRAL." Cowl flaps must be fully open during all ground operation. (See figure 49.)

(28) Pull inverter selector switch aft to "SPARE-OFF" to start main inverter. (See figure 50.)

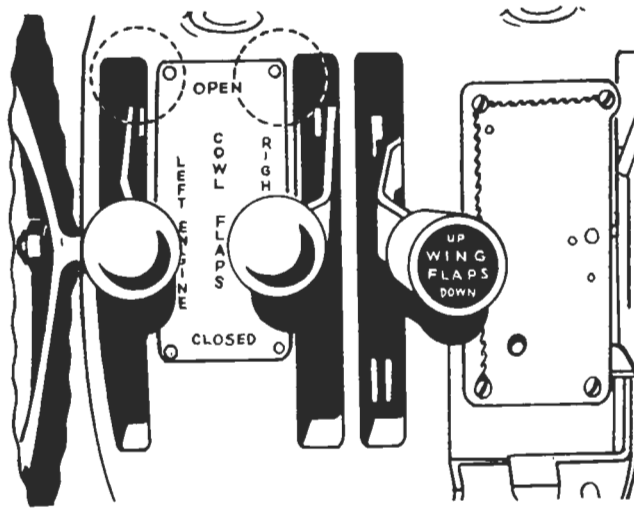

Figure 49 — Cowl Flaps Control Levers

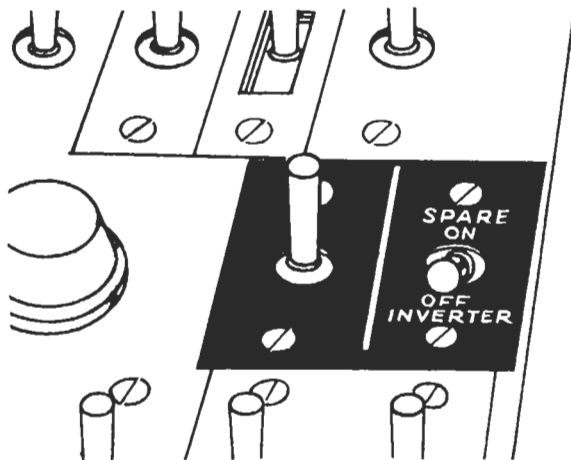

Figure 50 — Inverter Selector Switch

#### 4. FUEL SYSTEM MANAGEMENT.

##### a. NORMAL OPERATION.

###### (1) GENERAL.

(a) Fuel is transferred through a selector valve from the auxiliary wing and bomb bay tanks to the main tanks by a reversible electric pump. Two selector handles with dial markings for each tank are mounted on the inboard side of the selector valve.

(b) It is possible to transfer fuel from any tank indicated on one dial to any tank indicated on the other, or to transfer fuel between two tanks indicated on the same dial by first pumping into an intermediate tank.

(c) The direction of fuel flow is determined by the setting of the three-position transfer pump switch. The switch is pushed forward to pump from tanks indicated on the aft dial to tanks indicated on the forward dial, and pushed aft to reverse the flow.

(d) The switch must be turned "OFF" immediately when the warning light glows, denoting that the tank from which fuel is being pumped has been emptied. The pilot's fuel gage should also be constantly checked.

(2) EXAMPLE.—To transfer fuel from the right-hand forward bomb bay tank to the left-hand main fuel tank.

(a) Turn aft selector handle to the left-hand main.

(b) Turn forward selector handle to the right hand bomb bay.

(c) Push transfer pump switch aft to "ON" position.

(d) Check left-hand main tank fuel level with pilot's fuel gage.

(e) The warning light flashes when the right hand bomb bay tank is empty.

(f) Turn transfer pump switch "OFF" immediately when the warning light flashes.

##### b. EMERGENCY OPERATION.

(1) GENERAL.—If the electric transfer pump is inoperative, fuel may be transferred with the hand pump. Hose lines from the hand pump to the fuel selector valve, normally disconnected, are hung from

##### b. SPECIAL CHECK FOR NIGHT FLIGHTS.

(1) Turn master battery switch "ON."

(2) Test operate all fluorescent lights, dome lights and extension lights in the bombardier's compartment, pilot's and co-pilot's compartment, radio operator's and navigator's compartment, bomb bay, waist, and tail compartments.

(3) Test operate the compass light brilliancy.

(4) Test operate fuel gage lights.

(5) Test operate running lights.

(6) Test operate landing lights.

(7) Test operate gunsight lights.



outlet fittings under the selector valve. After connection of the hose lines to the hand pump, the selector handles are turned to the tank to be emptied and to the tank to be filled, and the pressure is supplied by hand pumping.

(2) EXAMPLE.—To transfer fuel from the right-hand forward bomb bay tank to the left-hand main tank.

(a) Turn selector handles "OFF."

(b) Remove plug from forward outlet fitting.

(c) Remove plug from red hand pump hose and connect to forward outlet fitting.

(d) Remove plugs and connect black hand pump hose to aft outlet fitting.

(e) Turn aft selector to "left-hand main."

(f) Turn forward selector to "right-hand bomb bay."

(g) Hand pump at a rate of approximately one stroke per second.

(b) Watch warning light and check pilot's fuel gage constantly.

#### 5. AUXILIARY POWER PLANT.

a. Before starting engines, the auxiliary power plant should be removed from the waist compartment and connected to the outlet in the left nacelle with the heavy extension cord provided. The engine operates on 90 to 100 octane gasoline mixed with  $\frac{1}{2}$  pint oil, AN9532, grade 1065, for each gallon.

#### NOTE

The above operation applies only if battery cart is not available.

#### (1) STARTING.

(a) Turn fuel tank supply valve "ON."

(b) Choke by pulling priming pump plunger full up, then release. Repeat two or three times.

(c) Wind starting rope in direction of arrow on starter plate.

(d) Pull rope sharply repeating as many times as necessary to start. (See figure 51.)

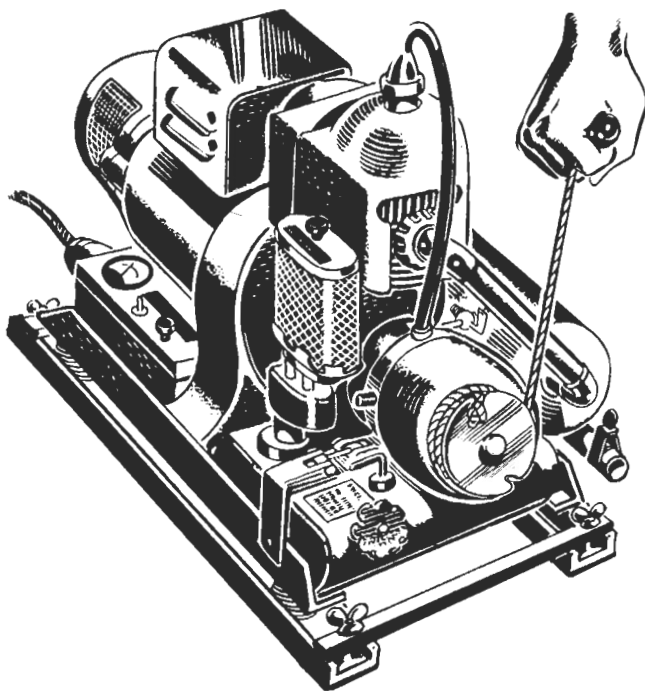

Figure 51 — Starting Auxiliary Power Plant

(e) In cold weather operate priming pump plunger at short intervals until engine warms up.

(f) If engine becomes flooded, expel some raw gasoline by opening the crank case drain cock while the engine is turned over once or twice.

(2) STOPPING.

(a) If engine is to be started again soon, press red button on magneto starter plate and hold firmly until engine stops.

(b) If unit is to be idle for some time, stop by turning fuel tank supply valve "OFF."

**6. STARTING ENGINES.**

In practice, engines may be started in the order desired. To start cold engines it is necessary to prime longer and to repeat the energize and mesh procedure until results are obtained.

a. Starting procedure for the left engine.

(1) Set throttles approximately 3/4 inch open for starting. (See figure 52.)

(2) See that propellers are clear, ground crew notified, and fire guard posted.

(3) Turn master switch "ON." (See figure 45.)

(4) Turn left ignition switch to "BOTH" magnetos. (See figure 45.)

(5) Check fuel gage operation at each setting. (See figure 53.)

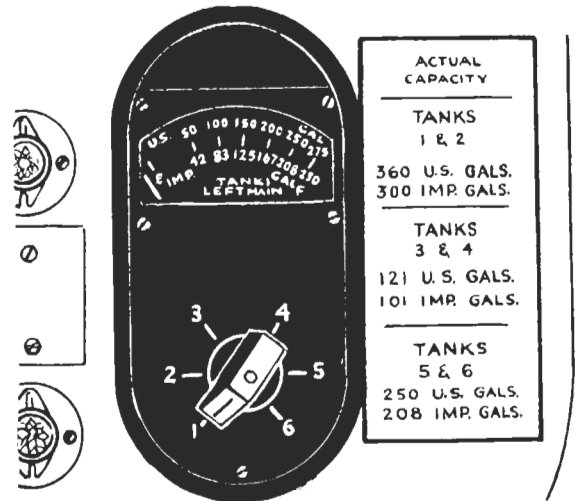

Figure 53 — Fuel Gage

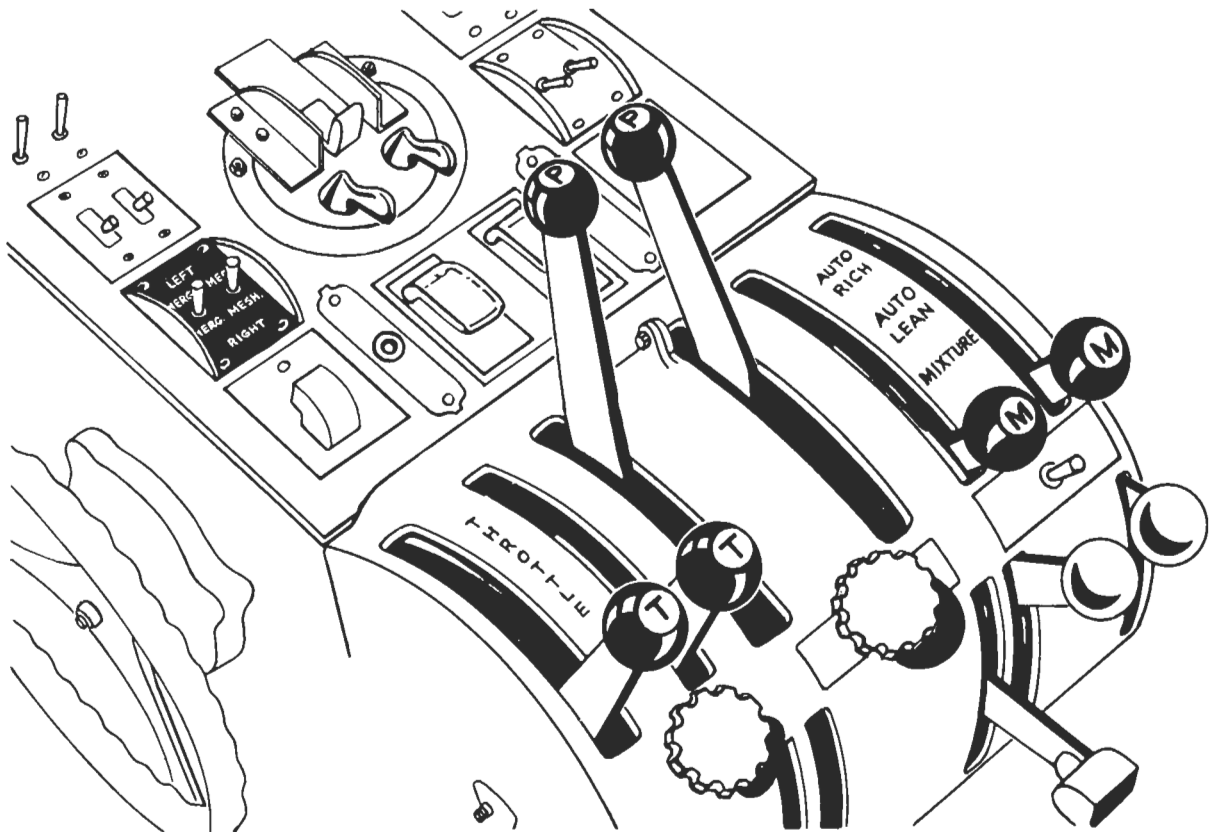

Figure 52—Pilot's Controls and Switches Before Starting Engine

(6) Switch left-hand booster pump "ON" and prime left engine. Priming time will vary from no prime for hot engines to approximately 10 seconds for cold engines. (See figure 54.)

engine starts release switches. When engine starts firing, move mixture control to the "AUTO RICH" position. Manipulate the throttle carefully and keep the engine down to 800 rpm for the first 30 seconds. If there is an indicated oil pressure, continue warm-up at 1000 rpm. Repeat procedure to start right-hand engine. (See figure 55.)

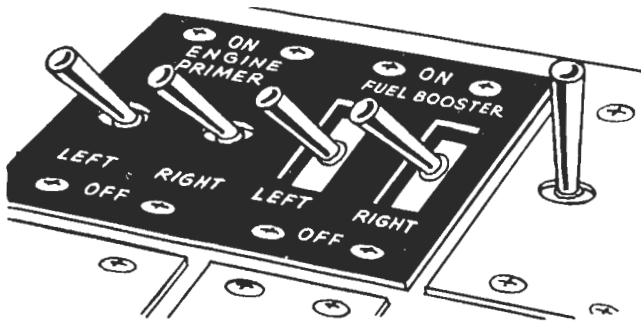

Figure 54—Primer and Booster Switches

(7) Hold energizer switch to "LEFT" position until the inertia flywheel reaches maximum rpm (approximately 30 seconds). Immediately before meshing the starter to the engine, turn primer switch to "ON" for 2 seconds. Engage the starter by holding the mesh switch to the "LEFT" position and at the same time turn primer switch "ON." Do not engage starter for more than 30 seconds in any one starting attempt. After

**NOTE**

If oil pressure is not indicated within 30 seconds, shut the engine down immediately and investigate the cause.

(8) Turn fuel booster pumps "OFF."

(9) Turn battery switches "ON" and have outside power source disconnected. (See figure 45.)

**7. ENGINE WARM-UP AND ACCESSORY CHECK.**

**NOTE**

Release and re-set parking brake immediately prior to warm-up.

a. Leave mixture levers in "AUTO RICH." (See figure 52.)

b. Run engines under 1000 rpm until cylinder head temperature reaches 120°C (248°F) and oil temperature reaches 50°C (122°F). (See figure 55.)

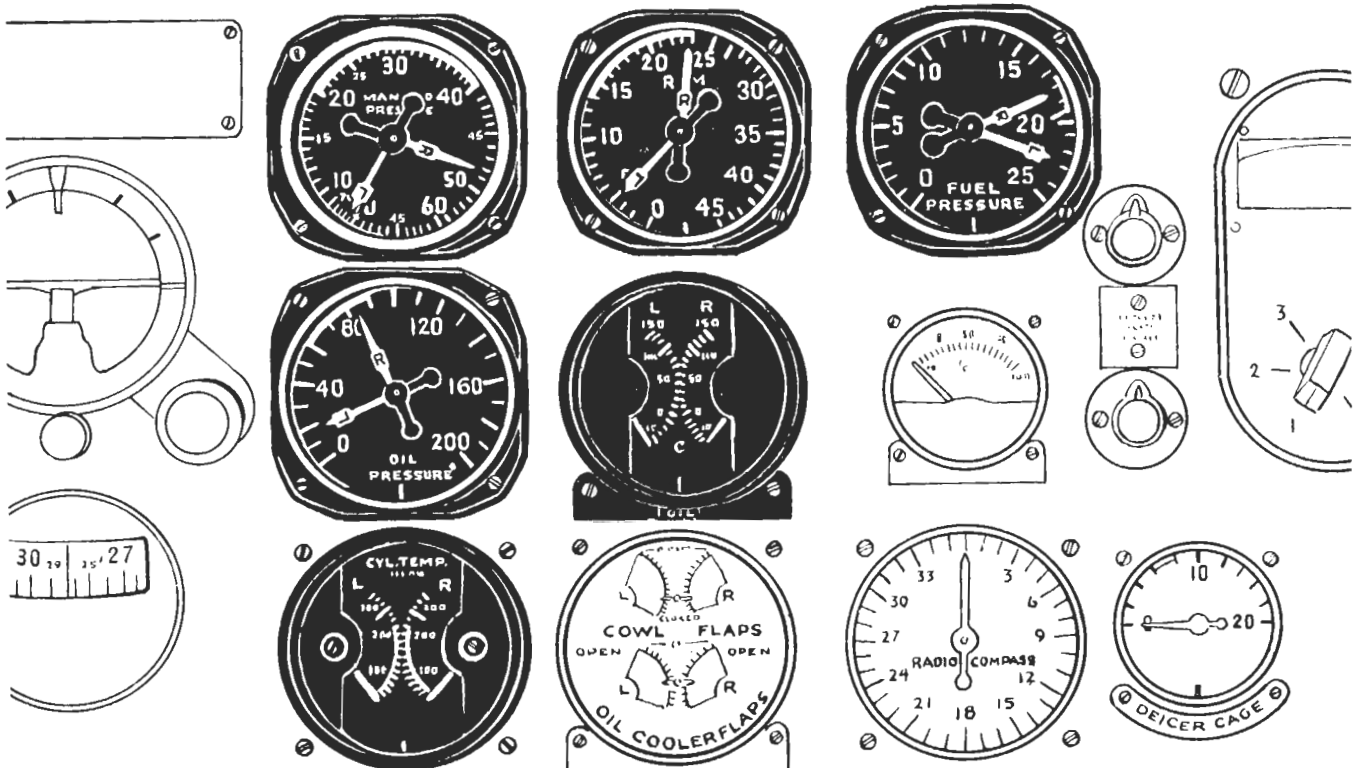

Figure 55—Temperature and Pressure Gages

**CAUTION**

Maximum allowable manifold pressure during the warmup is 32 in. Hg. and this will not be maintained for more than 30 seconds.

**NOTE**

Due to insufficient cooling on the ground when operating at high rpm, it is desirable to nose the airplane into the wind during warmup. Engines will be stopped rather than idled for prolonged periods after warmup has been accomplished.

- c. Hydraulic pressure should read 850 to 1050 pounds.
- d. Set oil cooler shutters as required after checking oil temperature. (See figure 46.)
- e. Carburetor air control levers remain in "COLD" position. (See figure 46.)
- f. Adjust seat and fasten safety belt (see figure 56.)

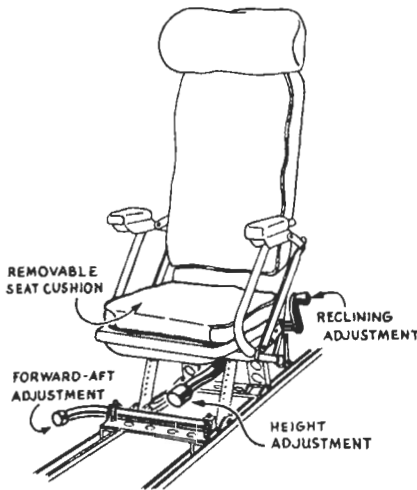

Figure 56 — Adjustable Seat

- g. Adjust radio and obtain taxi clearance.
- b. Set altimeter to station pressure and check time, resetting clock if necessary.
- i. Release parking brake by depressing pedals past lock position.

**8. EMERGENCY TAKE-OFF.**

a. If airplane has been on the alert, engines will be started, warm, and ready for take-off by the time the flight crew assembles within the plane. Proceed with normal take-off, being careful not to exceed 52 in. Hg. manifold pressure.

b. If an emergency take-off is required and a ground crew is not available, use the following procedure.

(1) Start engines, using oil dilution if necessary to maintain a minimum oil pressure of 60 pounds per square inch. (There is a possibility of over-dilution, so operate the system as little as possible to maintain minimum oil pressure.) Shut oil dilution valve when power is reduced but continue to watch oil pressure until oil temperatures are normal.

- (2) Fuel pressure 16 pounds minimum.
- (3) Taxi out as soon as engines will take the throttle.
- (4) Cowl flaps "FULL" open.
- (5) Set wing flaps 30 degrees for take-off.
- (6) Mixture "AUTO RICH" for take-off.
- (7) Take-off.

**9. ENGINE AND ACCESSORIES OPERATION GROUND TEST.**

a. Check overhead hatches and side windows to make sure that pins are in place. (See figure 40.)

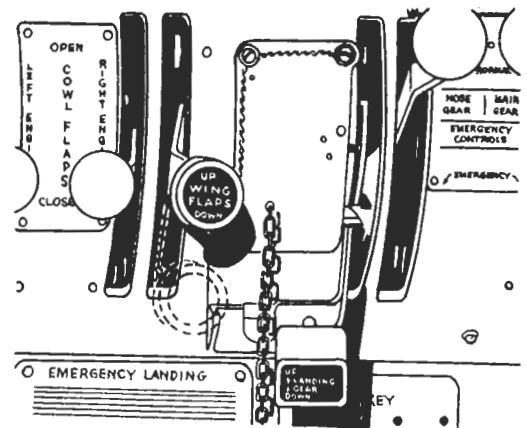

Figure 57 — Wing Flaps and Landing Gear Levers

- b. Remove safety lock from landing gear lever.
- c. Suction gage should read 3.75 to 4.25 in. Hg. (See figure 58.)

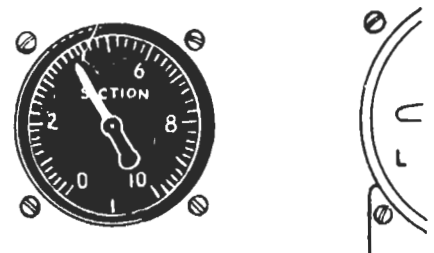

Figure 58 — Suction Gage Reading

**CAUTION**

The gyro indicators will be uncaged at all times except during maneuvers in the air which exceed the operating limits of the instruments. (See figure 59.)

**NOTE**

If the horizon bar of the gyro horizon is not level after the engines are started, cage and immediately uncage the gyro at least five minutes before take-off.

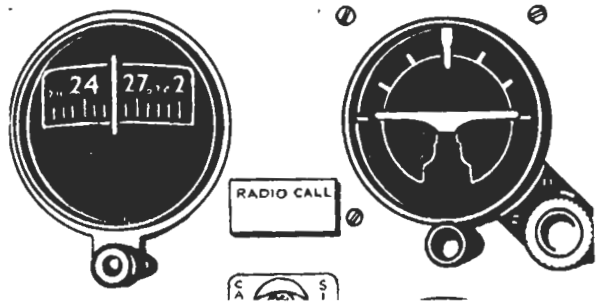

Figure 59 — Gyros Set

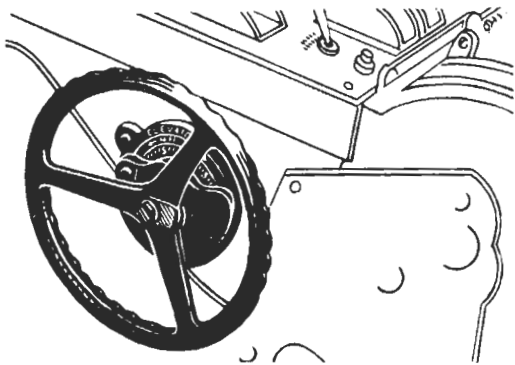

Figure 60 — Trim Tabs Set

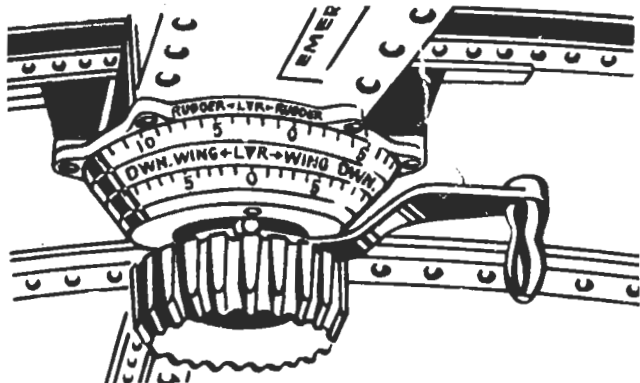

Figure 61 — Rudder and Aileron Set

d. Turn fuel booster pumps "ON." (THESE ARE TO BE LEFT ON UNTIL CRUISING ALTITUDE IS REACHED.) (See figure 54.)

e. Set trim tabs for take-off: tail heavy 5 degrees (for normal loads). (See figures 60 to 61.)

f. Check the magnetos and plugs of each engine individually at 30 inches manifold pressure. When engine reaches 2100 rpm, switch to "FIXED PITCH" and check magnetos for a maximum drop of 75 rpm.

g. Check operation of propeller governor levers in "INC." and "DEC. RPM" settings at 25 inches manifold pressure, and check magnetos for a maximum drop of 100 rpm.

b. Check manual switches.

i. Check feathering switches.

j. Check automatic decrease and increase.

k. Check blower clutches by shifting from one ratio to the other. Do not exceed 2000 rpm and 30 in. Hg. during this check, and have propeller control in "INC. RPM" position. Set engine speed at 1500 rpm and move blower control lever to "HIGH" position and lock. Open the throttle to obtain not over 30 in. Hg manifold pressure. When engine speed has stabilized, observe the manifold pressure and immediately shift to "LOW" blower position without moving the throttle. A sudden decrease in manifold pressure is an indication that the blower drive is operating properly.

**CAUTION**

When shifting from one position to another, be sure to make the shift quickly or at least without pausing between positions. This will avoid dragging and slipping the clutches.

**10. TAXIING INSTRUCTIONS.**

Taxiing is greatly facilitated by the tricycle landing gear. Below 35 mph the airplane is directionally controlled by gentle use of engines and brakes. With practice, taxi turns can be made with slow engines and no brakes, permitting the airplane to roll out of turns on course without effort. The nose wheel swivels 40 degrees each way, providing a minimum turning radius of 12-1/2 feet for inside main wheel. DO NOT ATTEMPT TO PIVOT THE AIRPLANE ON ONE WHEEL AS THIS WILL DAMAGE OR BREAK THE NOSE WHEEL STRUT.

a. Taxi to take-off position, making a smart run until airspeed indicates 50 to 60 mph, if possible.

**NOTE**

NEVER LET THE ENGINES IDLE BELOW 1000 RPM AFTER RUN UP.

- b. Check brakes for proper functioning.
- c. Check nose wheel for shimmy.
- d. Position airplane with nose wheel straight ahead for take-off.

(1) Clear engines advancing throttles, one at a time, to 2700 rpm, observing temperature and pressure instruments to be sure needles are within green arcs.

- (2) Flaps down.
- (3) Booster pumps "ON."
- (4) Gear downlock "OFF."
- (5) Release brakes.

(6) Advance throttle slowly to 52 in. Hg and 2700 rpm.

(7) During ground roll check engine instruments visually ("quick glance").

### 11. TAKE-OFF.

The airplane will accelerate rapidly during the take-off run. Wing flaps are lowered to increase lift and thus shorten the run necessary for take-off. A setting of 30 degrees will give the best lift-drag ratio. A setting greater than 30 degrees results in a large increase in drag with a correspondingly small increase in lift. In order to provide the final impetus for take-off, the nose wheel should be raised from the runway as soon as the airplane is well under way.

### NOTE

While the airplane is gaining momentum for take-off, maintain control by normal use of the throttles and rudder. As the nose wheel straightens out, open throttles smoothly to maximum take-off rpm. Hold control column back until nose wheel lifts clear of the ground, then ease forward to neutral.

### 12. ENGINE FAILURE.

a. DURING TAKE-OFF (under 140 mph).—If an engine fails during the take-off run or immediately after take-off before reaching a speed of 140 mph, it is impossible to continue the take-off. The other engine should be cut at once and a belly landing executed straight ahead. After minimum speed of 140 mph has been reached it is possible to regain control as outlined below. Single engine flight and landing are comparatively simple procedures to carry out successfully if the check list given below is followed.

b. AT TAKE-OFF (over 140 mph).

- (1) Counteract yaw with full opposite rudder and bank about 5 degrees toward operating engine.
- (2) Feather the windmilling propeller.
- (3) Reset rudder tab.

- (4) Make sure the landing gear is up.
- (5) Retract wing flaps as soon as possible, but slowly to prevent sinking.
- (6) If possible, close cowl flaps and oil cooler shutters on the dead engine.
- (7) Do not attempt turns or banks toward the dead engine unless absolutely necessary—then only at highest speeds.
- (8) Execute a single engine landing as soon as possible.

### 13. AFTER TAKE-OFF.

a. Pull landing gear lever "UP" to retract gear upon advice from pilot. When indicator shows full retraction, return lever to "NEUTRAL." (See figure 57.)

b. Pull wing flap lever "UP" to retract wing flaps after obtaining 500-foot altitude. When indicator shows full retraction, return lever to "NEUTRAL." Wing flaps should be retracted before reaching 185 mph. (See figure 57.)

c. Set cowl flaps as dictated by cylinder head temperature, then return levers to "NEUTRAL." (See figure 49.)

d. Switch fuel booster pumps "OFF," after reaching cruising altitude. (See figure 54.)

e. Consult "Power Plant Chart." (See figure 66.)

f. ATTEMPT NO ACROBATICS.

### 14. CLIMB.

The best climbing speed at full rated power will vary between 160 mph at sea level and 144 mph at 20,000 feet altitude with normal gross weight. Use low blower if below 9,000 feet and check cowl flaps and oil cooler shutters for proper adjustment.

### 15. DURING FLIGHTS.

a. The manifold pressures below the critical altitudes are regulated by manually operating the throttle. Maximum performance will be obtained by remaining in the low blower ratio until the critical altitude has been exceeded and the manifold pressure has dropped about 3 or 4 inches Hg before the high blower ratio is engaged.

b. Better engine efficiency is obtained at low altitudes by operating in low blower ratio.

c. During prolonged flight in either blower ratio, the clutches must be shifted at least every two hours and held in the opposite blower ratio for five minutes if tactical conditions permit. This periodic shifting is necessary to wash sludge accumulation out of the clutches. If any quantity of sludge is allowed to accumulate, improper clutch engagement or clutch failure is likely when a shift is attempted.



## 16. GENERAL FLYING CHARACTERISTICS.

With the C.G. as far aft as 26 percent MAC, longitudinal stability is satisfactory and there is adequate directional and lateral stability for turns. With the C.G. aft of 26 percent MAC, the airplane is not longitudinally stable. The airplane will no longer tend to fly itself, and the controls must be attended constantly.

## 17. STALLS.

Stalls at high power occur suddenly and are accompanied by a drop of one wing. Power-off stalls are preceded by a buffeting of the tail surfaces, a warning which decreases as the power is increased. In steep turns, stalls will occur at much higher speeds, the stalling speed in a 60-degree bank being 169 mph. Use of power in a steep turn will reduce stall speed slightly but also tends to stall the lower wing tip and roll the airplane over. For this reason, steep turns should not be executed at speeds below 200 mph.

### POWER OFF STALLING SPEEDS MODELS B-26B1 AND B-26C

	<i>Gross Weight</i> Pounds	<i>Calibrated</i> Airspeed MPH	<i>Indicated</i> Airspeed MPH
Flaps and	26,000	107	111
Landing	30,000	115	119
Gear Up	34,000	123	127
	38,000	130	134
Flaps and	26,000	89	93
Landing	30,000	96	100
Gear Full	34,000	102	106
Down	38,000	108	112

## 18. SPINS.

Never under any condition put the airplane in an intentional spin.

## 19. ACROBATICS.

All acrobatic maneuvers are strictly prohibited.

## 20. DIVING.

Maximum diving speed is 353 mph with any load up to 37,000 pounds, normal overload, and 300 mph between 37,000 and 38,200 pounds. It is important to observe this limiting speed at high altitudes. Dives should preferably be executed with power on since the propeller governor controls will keep the engines within operating limits. If the engines are kept at a minimum of 10 percent power, any tendency to cut out when full power is applied will be eliminated. Fuel is supplied to the engines in diving attitude by forward outlets in the fuel tanks.

## 21. NIGHT FLYING

Fluorescent light switches are located on the upper left-hand side of the pilot's pedestal. The switches for the new incandescent fluorescent lights are located in a row on the right-hand side of the pedestal. Lights should be test-operated before night flights with master switches and outside power source connected.

## 22. APPROACH AND LANDING.

a. During the preparation for landing, the center of gravity location should be checked by means of the "Load Adjuster" and the crew members should be called to stations.

(1) Have wing de-icers turned "OFF" (See figure 38.)

(2) Turn propeller anti-icer rheostat "OFF." (See figure 42.)

(3) Set altimeter to station pressure.

(4) Check right and left magnetos at low power.

(5) Make sure blowers are set in "LOW" with the safety cover in place. (See figure 46.)

(6) Adjust oil cooler shutters to suit oil temperature. (See figure 46.)

(7) Set carburetor air control levers to "COLD" except under carburetor icing conditions when the control lever will be adjusted to suit. (See figure 46.)

(8) Push mixture control levers forward to "AUTO RICH." (See figure 47.)

(9) Set propeller toggle switches to "AUTO CONSTANT SPEED" and governor levers to 2250 rpm. (See figure 48.)

(10) Turn fuel booster pumps "ON." (See figure 54.)

(11) While in the down wind leg, raise landing gear lever from the "NEUTRAL" to "UP" position. (See figure 57.)

(12) Reduce speed to approximately 165 mph.

(13) Place landing gear lever in the "DOWN" position and as gear drops, increase power or drop the nose of the ship or both to maintain a MINIMUM speed of 165 miles per hour. (See figure 57.)

(14) Check indicator for down and locked position of gear. Check wheels visually.

(15) Execute a turn into the approach with a normal bank, maintaining a MINIMUM speed of 165 miles per hour.

(16) As the ship levels out, lower the wing flaps while reducing speed to approximately 150 miles per hour and establish a uniform glide at approximately 140 miles per hour.

(5) Push propeller governor levers forward to "INC. RPM." (See figure 52.)

### 23. STOPPING OF ENGINES.

a. If necessary, operate engine at 1000 rpm to cool cylinder heads below 205°C (401°F).

b. Throttle—normal idling position.

c. Propeller control—high rpm (low pitch).

d. Stop engines by first idling at 800 to 1000 rpm. Set the mixture control lever to the "IDLE CUT OFF" position and simultaneously move the throttles to the "WIDE OPEN" position. When engine stops, turn ignition switches "OFF." (See figures 45 and 47.)

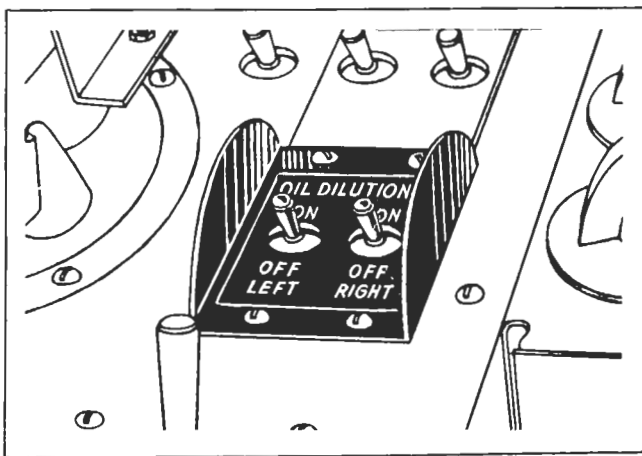

Figure 62—Oil Dilution Switches

e. Turn "OFF" master, battery, and all other electrical switches used during flight.

f. Set brakes for parking. Block the wheels if brakes are hot from excessive use.

g. Complete Forms 1 and 1A and lock controls.

b. Oil Dilution—If a cold weather start is anticipated, engines will be stopped in accordance with the following procedure.

(1) Stop engine and cool until engine oil temperature falls below 40°C (104°F).

(2) Start engines and operate at 1000 to 1200 rpm.

(3) Dilute each engine separately.

(4) Maintain oil temperature below 50°C (122°F) and oil pressure above 15 psi.

(5) Hold dilution switch for a length of time indicated after temperature expected.

4° to 12°C	( 40° to 10°F)	3 minutes
12° to 29°C	( 10° to 20°F)	5 minutes
29° to 46°C	( 20° to 50°F)	8 minutes

Add one minute dilution for each additional 5°C (9°F) below 46°C ( 50°F).

#### NOTE

If oil temperature tends to exceed 50°C (122°F) during dilution, stop engine and permit oil temperature to cool well below 40°C

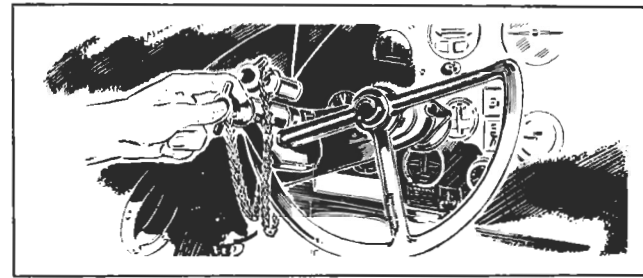

Figure 63—Locking Ailerons

(104°F). Then restart and continue dilution procedure. The total of the two or more dilution periods should equal the time mentioned above. If oil tank must be serviced, oil dilution time will be divided between before and after servicing. Again total of two dilution periods should equal the time mentioned in the preceding chart. Any deviation from these dilution periods found more satisfactory by experience may be used. Any recommended changes from these periods together with all pertinent data should be reported through established procedures.

(6) Stop engine in normal manner holding oil dilution switch down until engines stop.

(7) If 50 hours engine time has elapsed since the last oil dilution was accomplished, two or more dilutions will be used instead of one. On these occasions the engine will be given the full dilution period and, after each dilution, the engine will be shut down and the oil pressure screens will be removed and cleaned. This

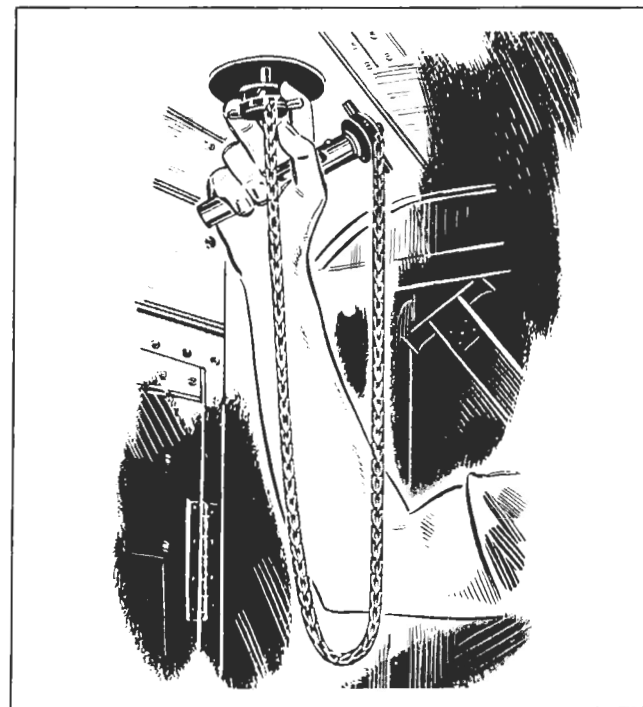

Figure 64—Locking Rudder



Figure 65—Locking Elevator

is necessary because the fuel in the oil tends to wash down any accumulated sludge within the engine. After reinstallation of the oil screens, the engine will be started and run for at least 20 minutes at 1000 to 1200 rpm to evaporate any fuel in the oil. The engine will then again be diluted for the usual period of time.

(8) The term "over-dilution" has been used to indicate any amount of dilution which causes the engine scavenging system to break down and discharge oil through the engine breathers. This condition is serious as it may be possible to completely lose all engine oil in a short period of time due to the breakdown in the scavenging system. Usually the oil discharge will occur on take-off or when high powers are used immediately after a heavy dilution. High percentages of dilution have no serious effect on engine bearings if the oil pressures remain normal. If oil discharge occurs under cold conditions, it may best be stopped by reducing power and rpm immediately.

#### 24. CONTROL LOCKS.

Ailerons, rudder, and elevators should be locked when parking or mooring the airplane. The locking devices consist of a yoke lock and two keys, one marked "RUDDER" and the other "ELEVATOR," which are stowed just aft of the pilot's seat.

*a.* **LOCKING AILERONS.**—Rotate the pilot's control wheel 20 degrees counterclockwise, place the yoke lock over the left-hand spoke, and press it firmly into the base plate. Remove the elevator key after turning it 90 degrees in the key hole of the yoke lock. (See figure 63.)

*b.* **LOCKING RUDDER.**—Take the rudder and elevator keys to the tail compartment. Open the rudder quadrant inspection door and line up the hole in the quadrant with the hole in the stabilizer rear spar lug. Push the rudder key through both holes until the snap spring engages. (See figure 64.)

*c.* **LOCKING ELEVATORS.**—The elevators are locked with the elevator key in the same manner after lining up the hole in the elevator quadrant with the hole in the fuselage frame. The gate in the tail gun ammunition track must be opened before the elevator key may be inserted. (See figure 65.)

*d.* **UNLOCKING CONTROLS.**—To disengage the locks, work in reverse order starting in the tail compartment with elevators, rudder and proceed forward to ailerons. The yoke lock on the control column must be unlocked with the elevator key. Severe damage will result from any attempt to force the yoke lock.

#### 25. SAFETY PRECAUTIONS.

##### *a.* GENERAL.

(1) ALL ACROBATIC MANEUVERS ARE PROHIBITED.

(2) Cowl flaps should be open for all ground operations except for warm-up in extremely cold weather.

(3) Avoid side slips. The fuel system will not supply adequate fuel to the engines when the airplane is in a side slip.

(4) Shut off heat control handles when going into combat.

##### *b.* HYDRAULIC.

(1) During flight return landing gear, wing flap, cowl flap and oil cooler shutter control levers to "NEUTRAL" after using.

(2) Leave landing gear control lever "DOWN" when gear is down in flight or on the ground.

##### *c.* ELECTRIC.

(1) Always connect outside power source for starting.

(2) Propeller toggle switches must be set to "AUTO CONSTANT SPEED" for starting, warm-up, take-off and landing, and in normal and combat flight.

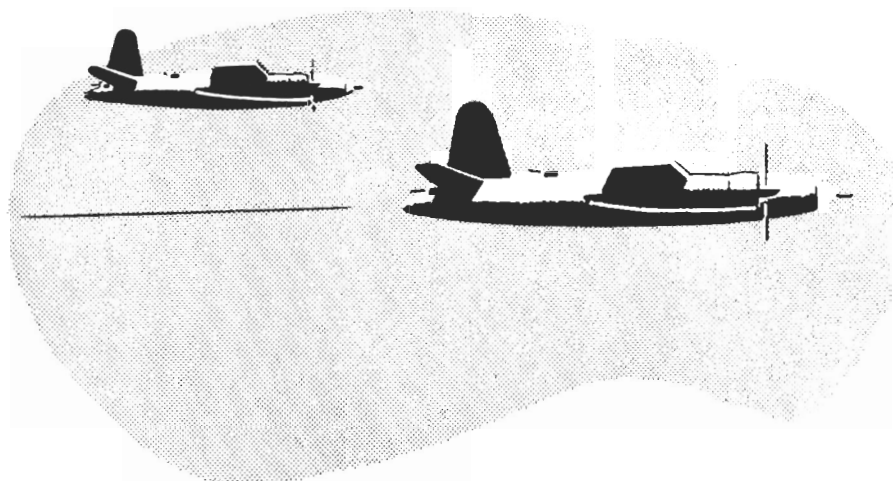

### SECTION III FLIGHT OPERATING DATA

#### I. GENERAL.

The following flight operating data is presented to acquaint the pilot with tested operating data for the airplane.

The charts apply to airplanes and engines which are in good operating condition. It is quite possible that some airplanes will show an improvement over the charted conditions and others will not equal

charted values. Small differences between particular airplanes are inevitably brought about by variations in age, condition, and manufacturing technique. Any differences in operating results between a particular airplane and the charted values should be noted for future reference. The performance of any airplane will taper off with age and will be changed noticeably by operational damage, overhauling, or structural repairs.

#### FLIGHT CONTROL DATA

<i>Item</i>	<i>Gross Weight</i>		
	<i>28,000 lb.</i>	<i>32,000 lb.</i>	<i>36,000 lb.</i>
Recommended take-off speeds (flaps 30°) (For normal take-off when optimum performance is not required)	111	119	126
Minimum speed for single engine operation (optimum speed for maintaining altitude and climbing)	145	154	163
Minimum safe speed for continuing flight assuming engine failure just after take-off			
Flaps, up, gear up	140	150	Do not continue flight
Flaps down, gear down	Do not continue flight. Cut remaining engine and land straight ahead.		

**2. AIRSPEED INSTALLATION CORRECTION TABLE.**

Since an airspeed system is not completely free from interference, airspeed indicated on the pilot's instrument contains a small error. The "Airspeed Installation Correction Table" gives calibrated readings of indicated airspeed corresponding to the pilot's instrument readings.

**NOTE**

There are two different types of pitot-static sources in use on Model B-26B1. It should be noted whether the pitot-static source is located on either the wing boom or the fuselage and the appropriate calibration should be used.

**PILOT'S AIRSPEED CALIBRATION TABLE  
MODELS B-26B1 AND C**

Indicated Airspeed	Calibrated Airspeed	
	For Wing Boom Pitot Static Source	For Fuselage Pitot- Static Plate Source
MPH	MPH	MPH
110	110	110
120	121	120
130	132	130
140	143	130
150	154	150
160	165	160
170	175	170
180	185	180
190	196	190
200	206	200
210	216	210
220	227	220
230	237	230
240	247	240
250	258	250
260	268	260
270	278	270
280	288	280
290	299	290
300	309	300

**3. AIRSPEED LIMITATIONS.**

Airspeed limitations are given for various flight conditions. Under certain circumstances it may be possible to exceed these limitations, but it is strongly recommended that the limits be observed.

**LIMITATIONS**

- Do not exceed:
- 353 mph IAS in a dive with gross weight up to 37,000 pounds.
- 300 mph IAS in a dive with gross weight from 37,000 to 38,200 pounds.
- 190 mph IAS while raising astro dome.
- 185 mph IAS with wing flaps extended.
- 165 mph IAS while lowering landing gear.

**4. WEIGHT AND BALANCE DATA.**

Great variations in loading are unavoidable in bombardment airplanes. The performance, stability, and control characteristics of the airplane are influenced by each change in weight and balance. In order to keep these variations within allowable limits, weight distribution must be checked frequently with the "Load Adjuster" as outlined in the "Handbook of Weight and Balance Data."

The "Handbook of Weight and Balance Data" (T.O. No. 01-1-40), conforming to AAF Regulation 55-3, is stowed in the pilot's data case. A "Load Adjuster," marked with a serial number for each particular airplane, is stowed on a clip just aft of the pilot's seat.

**5. POWER PLANT CHART.**

(See Figure 66.)

The "Power Plant Chart" gives, in tabular form, recommended engine operation for several conditions of flight. Although the engines are capable of exceeding the maximum values listed, any deviation from the charted values is dangerous and should be restored to only in an extreme emergency and then for as short a time as possible.

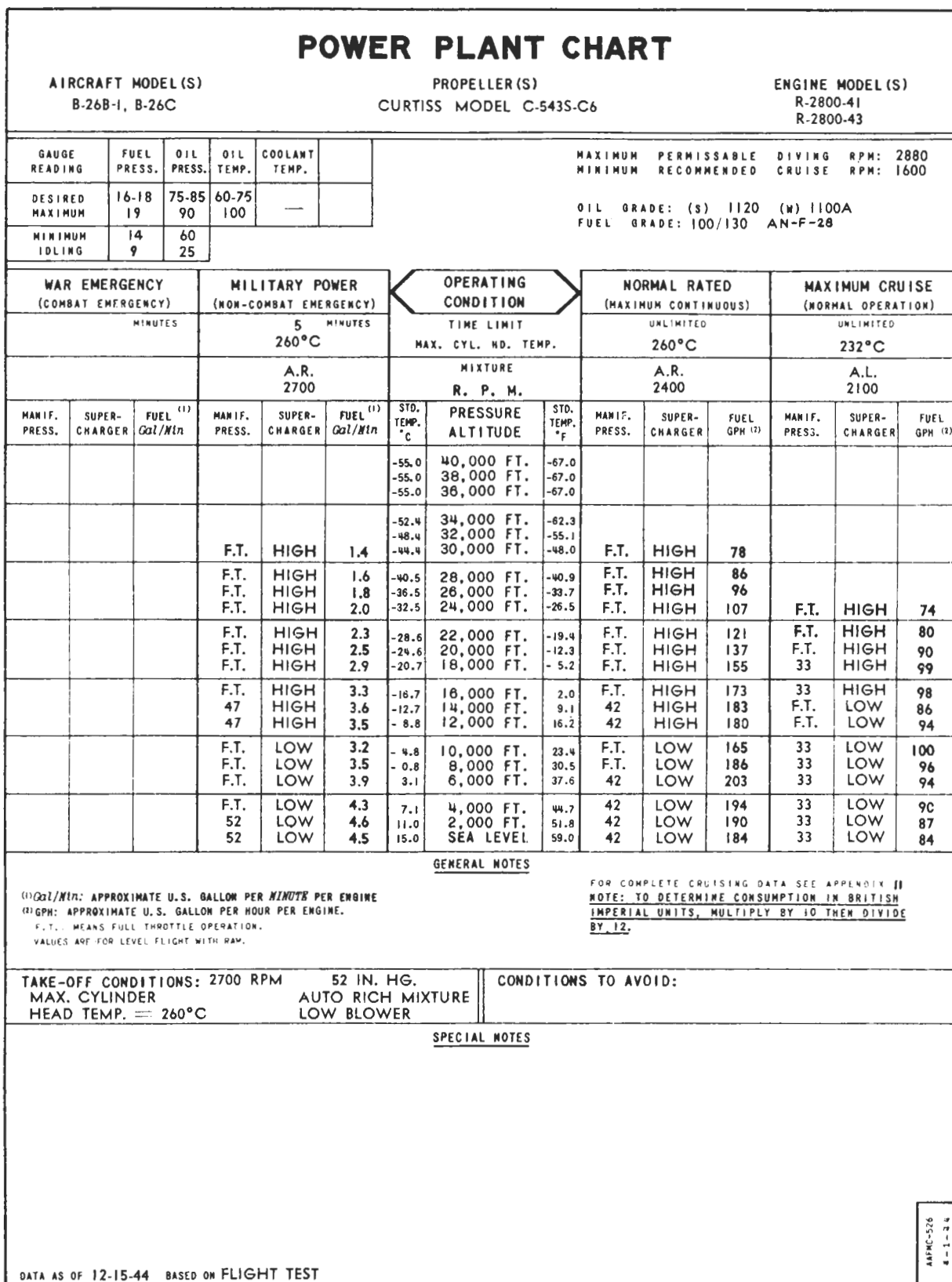

Figure 66 — Power Plant Chart



## SECTION IV EMERGENCY OPERATING INSTRUCTIONS

### 1. PILOT'S EMERGENCY CONTROLS AND EQUIPMENT.

a. The alarm bell switch controls bells located in each compartment of the airplane. (See figure 67.)

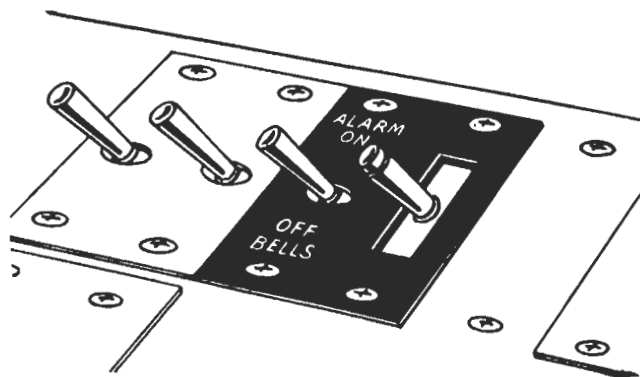

Figure 67 — Alarm Bell Switch

b. The propeller overload signal lights glow red if a propeller is left in fixed pitch, if a circuit breaker cuts out or if the propellers increase or decrease 30 rpm from the governor setting. (See figure 68.)

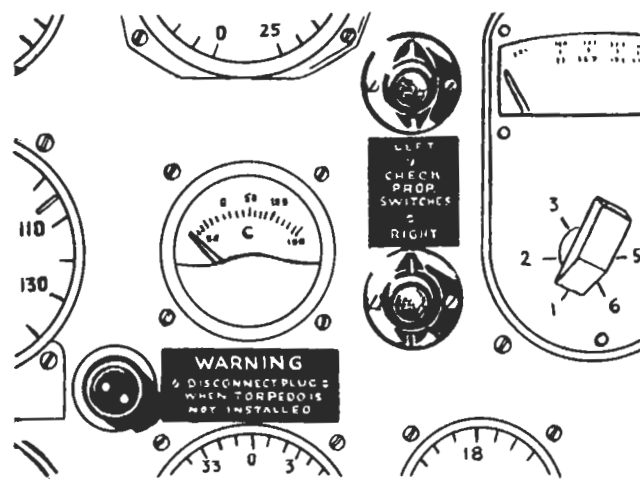

Figure 68 — Propeller Signal Lights

c. The detonator switches are connected to a charge of explosive in the SCR-535 radio set in the waist compartment. Press both buttons simultaneously to destroy the set. The resulting explosion is not dangerous to personnel, but contact with the set should be avoided at the time of the explosion. (See figure 69.)

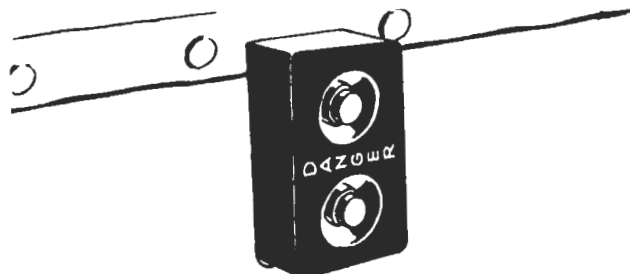

Figure 69 — Detonator Switches

d. The emergency bomb release handle is used to salvo the contents of both bomb bays in an emergency. The release handle is pulled full forward to open the bomb bay doors and release the contents of the racks. (See figure 70.)

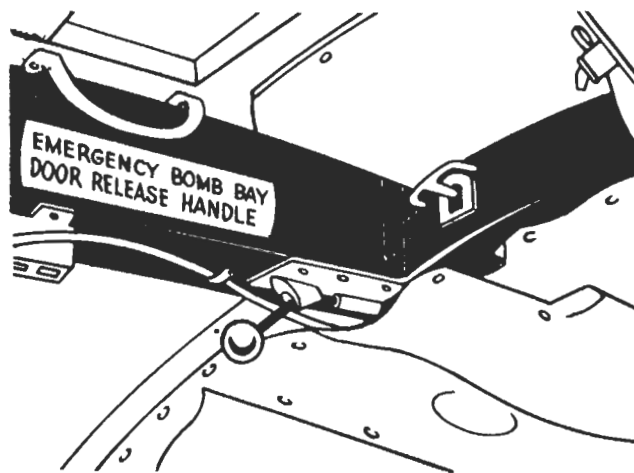

Figure 70 — Emergency Bomb Release Handle

e. The emergency air brake handle is pulled forward to release compressed air to the hydraulic brake operating cylinders in an emergency.

f. The emergency hydraulic hand pump is used to supply pressure to the operating cylinders in case of failure of the normal source of pressure. (See figure 71.)

g. The hydraulic reservoir supply valve is opened to supply fluid from the hydraulic emergency reservoir to the lines.

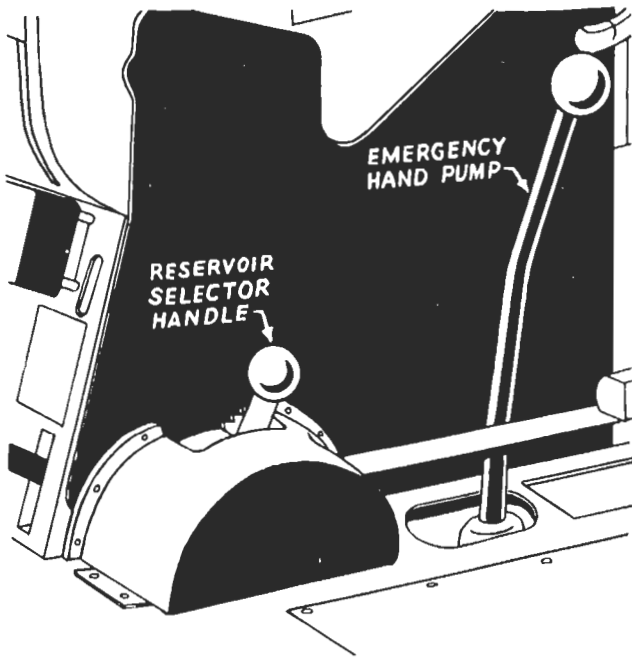

Figure 71 — Emergency Hand Pump and Reservoir Selector Handle

## 2. PILOT'S EMERGENCY CHECK LIST.

*a.* PROPELLER GOVERNOR FAILURE.—A propeller governor failure will result in loss of control over the propeller pitch. The blades will remain fixed in the position at which they were set when the failure occurred, even though the propeller toggle switch is left in "AUTO. CONSTANT SPEED." Changes in throttle setting or airspeed will immediately affect rpm. An airspeed increase or decrease of 20 mph, for example, would result in a change of 200 to 400 rpm.

Many supposed governor failures at take-off are caused by failure to set the propeller toggle switches to "AUTO. CONSTANT SPEED" or failure to switch the generators "ON." Also, the governor may have been set too high, permitting the engine to go to 2800 rpm or over. It is advisable to check the "INCREASE" and "DECREASE RPM" settings and to test the engines for a maximum of 2700 rpm at maximum governor setting before take-off. Such a procedure will uncover any malfunctioning of the governor before it can cause trouble. A propeller governor failure when cruising at medium or high altitudes is a relatively simple problem.

(1) BEFORE TAKE-OFF.—Discontinue take-off immediately.

(2) SHORTLY AFTER TAKE-OFF.

(a) Apply opposite rudder to counteract yaw.

(b) Reduce rpm by resetting governor control lever or by setting toggle switch to "DECREASE RPM."

(c) If propeller controls are inoperative, engine speed can be kept at a safe minimum by reducing power.

(d) Bank slightly toward good engine.

(e) Set trim tabs.

(f) Make all turns toward good engine.

(3) WHILE CRUISING AT ALTITUDE.

(a) Set toggle switch in "FIXED PITCH."

(b) Use "INC." and "DEC." RPM setting to reset propeller when necessary.

(4) LANDING IN FIXED PITCH.

(a) In case of failure of one governor it is advisable to land with propeller in "FIXED PITCH."

(b) Use "INC." or "DEC." RPM settings to maintain 2200 rpm and 150 mph at 25 inches Hg M. P.

(c) Hold airspeed constant by adjusting manifold pressure as the nose is dropped.

*b.* GENERATOR FAILURE.—Imminent failure of the generators is usually indicated by fluctuation of the autosyn and selsyn instruments. The most important units affected by electrical failure are the propeller governors. Emergency procedure is similar to that outlined under "Propeller Governor Failure." If the generator failure is detected before the batteries are discharged, it is possible to reserve some electrical energy for use when needed. Approximately 30 minutes operating time will remain if the batteries are fully charged.

The propeller toggle switches should immediately be set in "FIXED PITCH" and generator and battery switches turned "OFF." Placing the propeller toggle switches in "FIXED PITCH" prevents surge when the batteries are again switched "ON." With a known reserve of electrical energy in the batteries it is possible to use a small amount of current every 10 to 15 minutes to check instruments and reset propellers. By all means save enough electrical energy to make a normal landing with propeller toggle switches in "AUTO. CONSTANT SPEED."

(1) BEFORE TAKE-OFF.—Discontinue take-off immediately.

(2) SHORTLY AFTER TAKE-OFF.

(a) Maintain a safe minimum airspeed by reducing power and by climbing the airplane.

**Note**

Consult single engine flight operation instruction chart. (Appendix II.)

(b) Land as soon as possible.

(3) WHILE CRUISING AT ALTITUDE.

(a) Set propeller toggle switches in "FIXED PITCH."

(b) Turn generator and battery switches "OFF."

(c) Turn radio and light switches "OFF."

(d) If there is sufficient energy in the batteries, switch "ON" every 10 to 15 minutes to check instruments and reset propellers with the "INC." or "DEC." RPM settings.

(e) If possible, save sufficient energy for landing in "AUTO. CONSTANT SPEED."

(4) LANDING.

(a) Use "INC." or "DEC." RPM settings to maintain 2200 rpm and 150 mph at 25 inches Hg. M. P.

(b) Hold airspeed constant by reducing manifold pressure as the nose is dropped.

**c. HYDRAULIC SYSTEM FAILURE.**

(1) GENERAL.—Hydraulic failures are commonly caused by one of the following conditions: an air lock in the lines, failure of the pumps to build up normal pressure, or loss of fluid in the lines or in the reservoir. Since all hydraulically operated units might have to be used under any one of the above conditions, a list of emergency procedures for operating each unit follows.

(a) AIR LOCK.—An air lock in the system will prevent full retraction of the landing gear after take-off. To restore system to normal.

1. Return landing gear lever to "DOWN" position.

2. Bleed air out of system by holding nose gear emergency lever down to "EMERGENCY" for 2 to 3 minutes; then return to "NORMAL."

3. Check gage for normal pressure (850 to 1050 pounds per square inch).

4. Repeat several times if necessary.

(b) LOSS OF PRESSURE.—Failure of the engine pumps or one of the controlling valves will cause a sudden drop in pressure. If the reservoir contains a minimum of 3-1/2 gallons of fluid, any unit may be operated by supplying pressure with the hand pump.

(c) TO LOWER LANDING GEAR.

1. Push nose gear emergency lever down to "EMERGENCY."

2. Push landing gear lever to "DOWN" position.

3. Hand pump nose gear "DOWN" and "LOCKED."

4. Push main gear emergency lever down to "EMERGENCY."

5. Hand pump both main gears "DOWN" and "LOCKED."

6. Return both emergency levers to the "NORMAL" position.

(d) TO OPERATE FLAPS OR BOMB BAY DOORS.

1. Set nose gear emergency lever to "NORMAL."

2. Push the required control lever to desired position.

3. Set all other hydraulic levers in "NEUTRAL."

4. Pump to desired position with hand pump.

5. Return control lever to "NEUTRAL."

(e) TO OPERATE BRAKES.

1. Land normally with brakes released.

2. Immediately after all wheels touch the ground, depress both brake pedals and hold down.

3. Work hand pump to build up pressure in the brake cylinders. Sufficient pressure to stop the airplane can be built up during the landing run. It is impossible to build up pressure in the brake operating cylinders before the pedals are depressed.

4. As a last resort pull the emergency air brake handle.

(f) LOSS OF FLUID.—If the reservoir contains less than 3-1/2 gallons of fluid, make up the loss by drawing fluid from emergency reservoir. Proceed as follows:

1. Release safety wire and pull the emergency hydraulic reservoir supply valve back to "OPEN" position.

2. Proceed as listed under "Loss of Pressure."

(g) **LOAD AND FIRE VALVE FAILURE.**—Faulty adjustment of the striker arm which fires the nose gear load and fire valve will prevent release of the nose gear up-lock after the nose gear doors have opened, and the main gear has extended. The load and fire valve may be fired by prying the plunger closed with a screw driver.

To reach the valve it is necessary to remove approximately 10 or 12 screws from the forward edge of the plate between the pilot's seat tracks and gouge a hole in the floor just forward of the pilot's seat, 5 inches aft of the brake control cover and 1 inch to the left of the right-hand seat track. Be careful not to damage the control cables and hydraulic lines running under the floor at that point. The airplane must be flown from the co-pilot's seat during this procedure. When the load and fire valve has been exposed, proceed as follows:

1. Landing gear lever "UP."
2. Press load and fire valve plunger in and hold.
3. Landing gear lever "DOWN."
4. Hold plunger until nose gear is "DOWN" and "LOCKED." An instruction placard is located on the pilot's pedestal.

(b) **BREAKDOWN OF HYDRAULIC LINES.**—Supplementary emergency operation facilities are provided for the wing flaps, service brakes and bomb bay doors. In case of damage to the hydraulic operating lines leading to these units the following procedure is used:

(i) **MECHANICAL EXTENSION OF WING FLAPS.**—When no hydraulic pressure is available.

1. Push the wing flap control lever to the "DOWN" position to allow return of hydraulic fluid from the flap operating cylinders.
2. Place the wing flap crank in the opening between the two bomb bays.
3. Rotate the crank clockwise until the flaps reach the desired position. When movement of the crank is stopped the flaps will remain in that position.
4. In flight the air pressure will retract the flaps when the crank is removed (turned counterclockwise).

#### CAUTION

Do not attempt to retract the flaps hydraulically with the crank in place or damage to the control system will result.

(j) **EMERGENCY AIR BRAKE.**

1. Compressed air cannot be applied to the brakes selectively. Be prepared to counteract uneven action with throttles.
2. Warn crew to prepare for a sudden stop.
3. Pull emergency air brake handle slowly, releasing air pressure in short surges to keep brakes from locking.
4. Should brakes lock prematurely, bleeder valve may be cracked open slightly to relieve pressure.

(k) **EMERGENCY BOMB RELEASE.**

1. Pull emergency bomb release handle forward approximately 3 inches to release torpedo, open bomb bay doors, and salvo bombs.
2. To hold doors open for emergency exit, kill hydraulic pressure by depressing nose gear emergency lever to "EMERGENCY" or by fastening emergency release handle in extended position.
3. To close doors, release emergency release handle.

d. **LANDING GEAR FAILURE.**

(1) **GENERAL.**—Failure of either the main or nose gear to extend or to lock down will be evidenced by the instrument panel indicator when the throttles are retarded. Failure of the nose gear down-lock to engage after the main gear has locked down can be coped with successfully by building up enough hydraulic pressure to hold the nose gear in position. Landings with main gear down and nose gear up are advisable only if a hard-surfaced runway is available. If either the main or the nose gear fails to extend, however, and only soft ground is available, it is preferable to retract both gears and execute a belly landing.

(a) **LANDING WITH MAIN GEAR DOWN  
—NOSE GEAR UNLOCKED.**

1. Move the C.G. to the farthest aft allowable limit.
2. Use emergency hand pump to keep hydraulic pressure as high as possible (about 1200 pounds per square inch).
3. Execute a "nose-up" landing on the main wheels.
4. Operate hand pump steadily to sustain nose gear with hydraulic pressure during landing.
5. Try to jar the down lock into place by tapping the nose wheel lightly on the runway.
6. If the down lock does not engage, raise nose wheel and hold off as long as possible.
7. Apply brakes smoothly and sparingly. Do not taxi until down lock has been checked.

(b) LANDING WITH MAIN GEAR DOWN,  
NOSE GEAR RETRACTED. (ONLY IF  
MAIN GEAR CANNOT BE  
RETRACTED.)

1. Move the C.G. to the farthest aft allowable limit.
2. Turn off all unnecessary electrical equipment.
3. Feather both propellers just before landing, then cut off master and ignition switches.
4. Execute a "nose-up" landing on the main wheels.
5. Turn fuel supply valves "OFF" just after landing.

(c) LANDING WITH MAIN GEAR UP,  
NOSE GEAR DOWN.

1. Turn off all unnecessary electrical equipment.
2. Feather both propellers just before landing, then cut off master and ignition switches.
3. Execute a "nose-up" landing with the wing at a high angle of attack to take the load off the nose gear.
4. Turn fuel supply valves "OFF" just after landing.

(d) BELLY LANDING.

1. Turn off all unnecessary electrical equipment.
2. Just before landing, feather both propellers, then cut off master and ignition switches and fuel supply valves.
3. Land in normal attitude (allow for height of gear).

e. ENGINE FAILURE IN FLIGHT.  
(HEAVY GROSS WEIGHT.)

- (1) Feather the propeller of the dead engine.
- (2) Advance the good engine to full rated power.
- (3) Nose the airplane down slightly and pick up speed to 170 mph, then salvo bombs and tanks.
- (4) A slow loss of altitude is often the answer to successful single engine flight for as the airplane descends to denser air performance improves. An airplane that will not hold altitude at 5000 feet may do so at 2000 to 3000 feet.

(5) When a satisfactory altitude has been reached, throttle the operating engine back to approximately 2300 rpm at 34 inches Hg M. P.

f. STARTING DEAD ENGINE IN FLIGHT.

- (1) Set the feathering switch to "NORMAL" position.
- (2) Shift the mixture lever to "AUTO. RICH."
- (3) Hold the propeller toggle switch to "INC. RPM" until the engine turns fast enough to build up oil pressure; then shift to "AUTO. CONSTANT SPEED."
- (4) Do not increase power until the engine has warmed up.

g. SINGLE-ENGINE LANDING.

- (1) Keep airspeed above 140 mph during the approach.
- (2) Reduce trim tab as engine is throttled down.
- (3) Lose speed and altitude gradually and glide in with power off. Remember that the airplane will not hold altitude on one engine with landing gear extended.

3. EMERGENCY EXIT IN FLIGHT.

a. GENERAL. — Before the airplane is abandoned in flight the propellers should be feathered and master and battery switches and fuel supply valves turned off. The navigator should establish his position and the radio operator should transmit a distress signal, giving the position of the airplane.

b. SIGNALS. — The pilot will notify the crew by interphone, signal lamps or alarm bells of intention to abandon the airplane.

- (1) Stand by to abandon. . . . . 1 long flash or ring  
(6 seconds).
- (2) Emergency lifted. . . . . 2 long rings or flashes  
(4 seconds each).
- (3) Abandon. . . . . 3 short rings or flashes  
(2 seconds each, repeated).

c. EXIT FROM FORWARD COMPARTMENT. (See figure 72.) — The most direct exit from the pilot's or the bombardier's compartment is through the nose wheel well entrance hatch after the nose gear has been extended. Exit from the radio operator's and navigator's compartment is gained through the forward bomb bay doors which are opened from the bombardier's compartment with the bomb bay door selector handle or from the pilot's compartment with the emergency bomb release handle. The nose wheel

well hatch and the forward bomb bay are both accessible from the forward compartments of the airplane so that if either one should fail to operate the other may be used.

*d. EXIT FROM AFT COMPARTMENT.* (See figure 72.)— Either one of the two waist gun hatches or the aft bomb bay doors will furnish a safe

exit in flight. The waist gun hatches, opened by releasing the levers and pulling the cover up to the stowed position, are the surest and most positive avenue of escape from the waist compartment.

*e. SAFETY PRECAUTIONS.*

- (1) Never leave by upper hatches in flight.
- (2) Hold practice drill on the ground frequently.

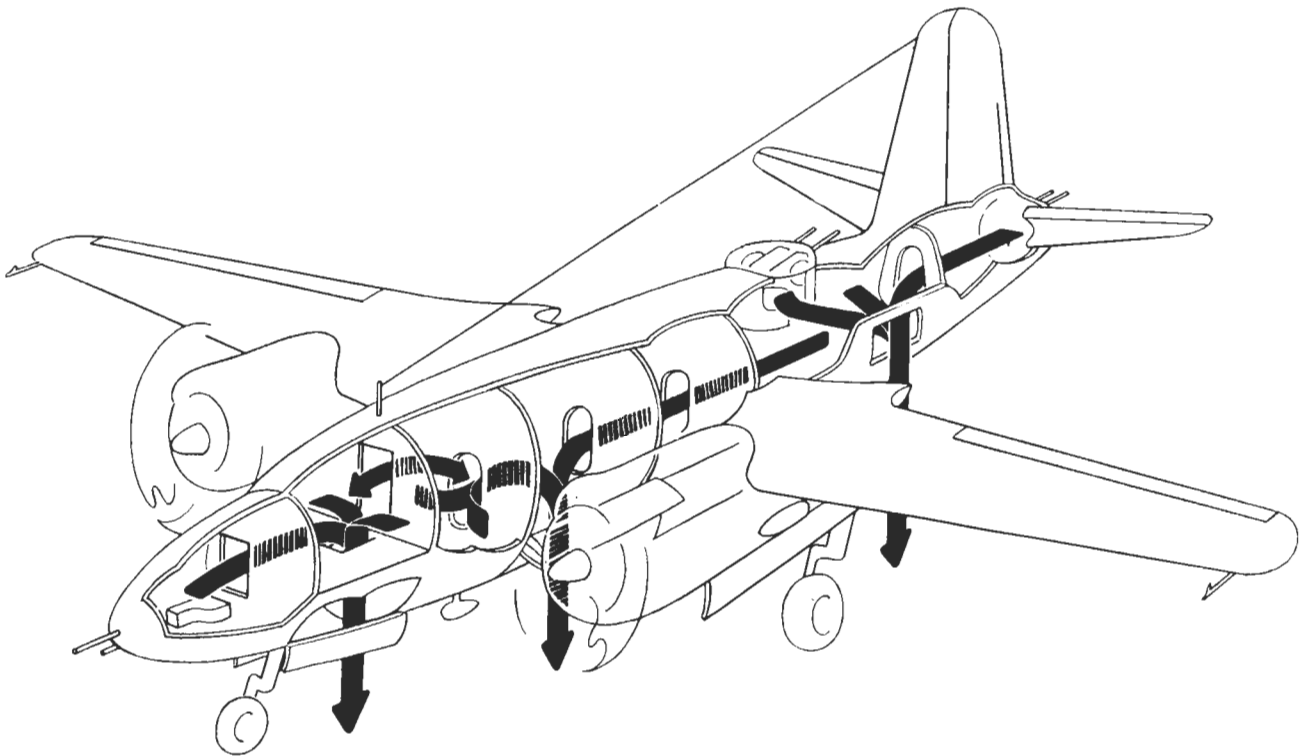

Figure 72 — Emergency Exits in Flight



#### 4. DITCHING. (FORCED LANDING AT SEA.)

##### a. PREPARATION.

- (1) Navigator determines position.
- (2) Radio operator sends distress call, giving position.
- (3) Salvo bomb load and tanks if full. If tanks are empty they should be retained for buoyancy.
- (4) Navigator opens his upper hatch.
- (5) Pilot orders crew to ditching stations. All members of the crew should be as far forward in the airplane as possible, as experience has proven that rear part of the airplane breaks in two at about the waist gunners position when it strikes the water.

##### b. DITCHING.

- (1) Approach with power on to flatten glide. Sea will be rougher than it appears.
- (2) Co-pilot opens upper hatch just prior to striking water.
- (3) Feather both propellers and turn master switch "OFF" just prior to striking water.
- (4) If the wind is blowing across the swells or if there is a light wind blowing with the swells, ditch in trough of swells.
- (5) If there is a high wind blowing with the swells, ditch into the wind toward the top of the swell.
- (6) Do not let nose get too high, but allow the tail of the airplane to strike the water first. As the airplane stops, the nose will bury.

##### c. LAUNCHING LIFE RAFT.

- (1) To launch life raft from inside the airplane:
  - (a) Pull red handle to release door.
  - (b) Continue pull to inflate and release raft.

#### NOTE

The life raft door can be used as an exit for personnel when the airplane has landed, by pushing up on the canvas bag from the inside, after the raft has been released.

- (2) To launch life raft from outside the airplane:
  - (a) Turn handle to release door.
  - (b) Remove door and pull cable attached to CO<sub>2</sub> bottle.

##### d. BOARDING LIFE RAFT.

- (1) Remove emergency transmitter, signal light, Very pistol, and flares.
- (2) Turn lights on if possible to aid rescue.

(3) Forward crew exits quickly through pilot's or navigator's upper hatch and life raft exit.

(4) Forward crew boards life raft and picks up aft crew.

(5) Aft crew exits quickly through navigator's hatch.

(6) Cast off lines and paddle a short distance from the airplane.

##### e. ASSISTING RESCUE.

(1) The self-contained portable transmitter (SCR-578-A) is operated from the life raft with a kite aerial. Complete operating instructions are printed on the set. The transmitter emits an MCW signal tuned to the international distress frequency of 500 kc. The manual sending key may also be used.

(2) Don yellow caps.

(3) Use signal equipment judiciously to attract rescuers.

(4) Observe instructions included with rations.

#### 5. EMERGENCY EXIT ON GROUND.

(See figure 73.)

a. GENERAL.—The pilot will notify the crew of his intention to make a belly landing. The bombardier, turret operator, and tail gunner should assume crash landing positions. All crew members remain seated with safety belts fastened securely until the airplane comes to a stop.

b. EXIT FROM FORWARD COMPARTMENTS. (See figure 73.)—Occupants of the forward compartments leave the airplane through either the pilot's upper escape hatch or through the navigator's hatch.

c. EXIT FROM AFT COMPARTMENTS. (See figure 73.)—Occupants of the aft compartments proceed forward through the bomb bays and exit through the navigator's hatch.

d. DESTRUCTION OF EQUIPMENT. — If the landing is made in hostile territory, the secret radio equipment should be destroyed by pressing simultaneously the two detonator switches located in a red box next to the co-pilot's seat.

Two hand grenades are stowed in the airplane one in the pilot's compartment and the other in the waist compartment, which are to be hurled at the airplane in case of a forced landing in enemy territory by any crew member when he is at a safe distance from the airplane.

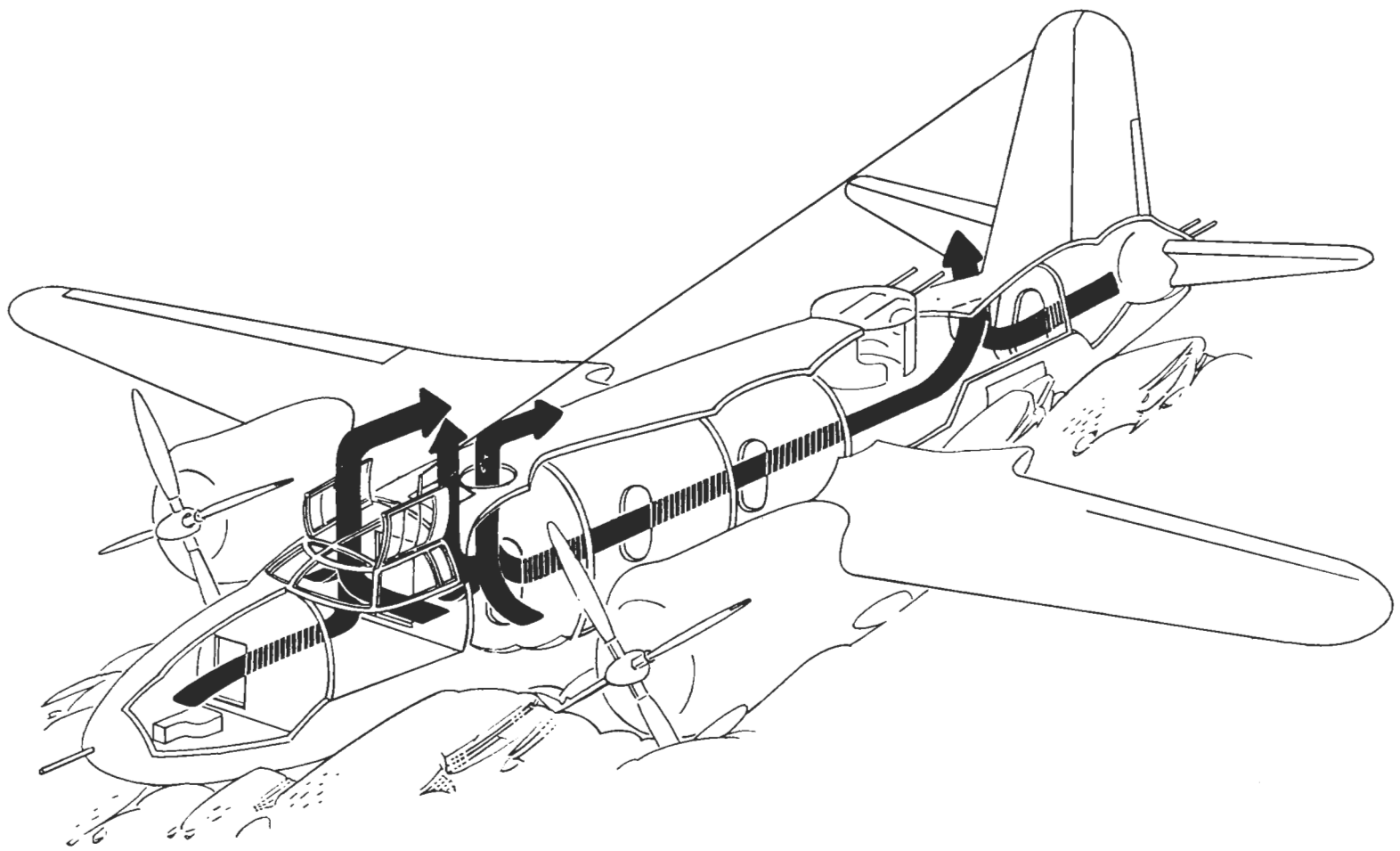

Figure 73 — Emergency Exits on Ground

## SECTION V OPERATIONAL EQUIPMENT

### 1. RADIO OPERATOR'S COMPARTMENT. (See figure 74.)

*a.* BEFORE ENTERING.—Make sure that an external power source is connected and that all antennas are at least 1 foot removed from the nearest object if radio equipment is to be tested. Enter the airplane

through the main entrance hatch in the nose wheel well or through the forward bomb bay.

*b.* UPON ENTERING.—Check for proper functioning of radio equipment and controls. The master switch on the pilot's pedestal should be left in "OFF" position.

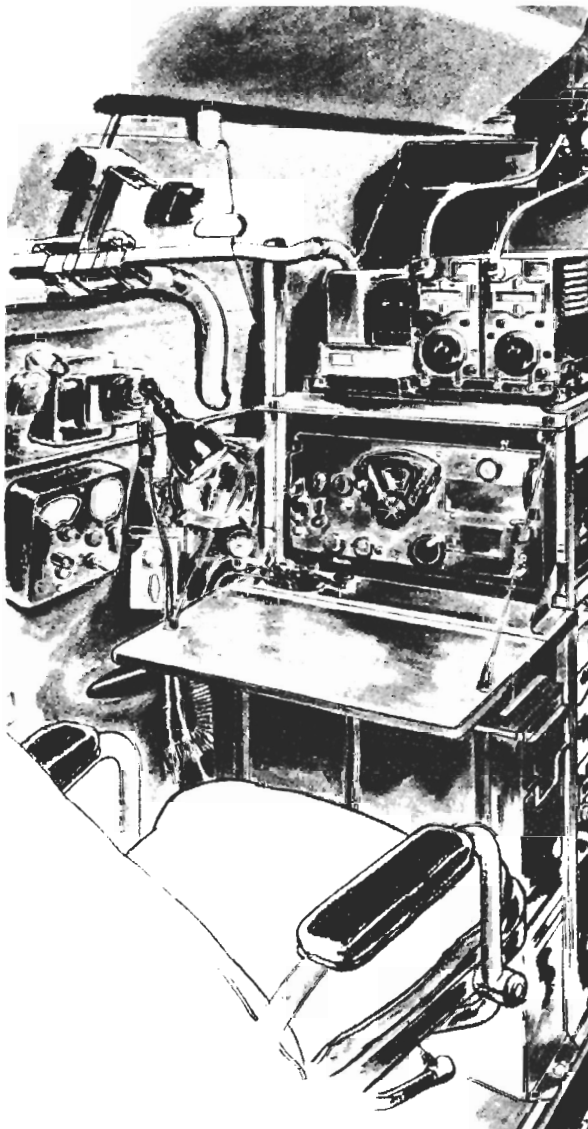

LOOKING FORWARD

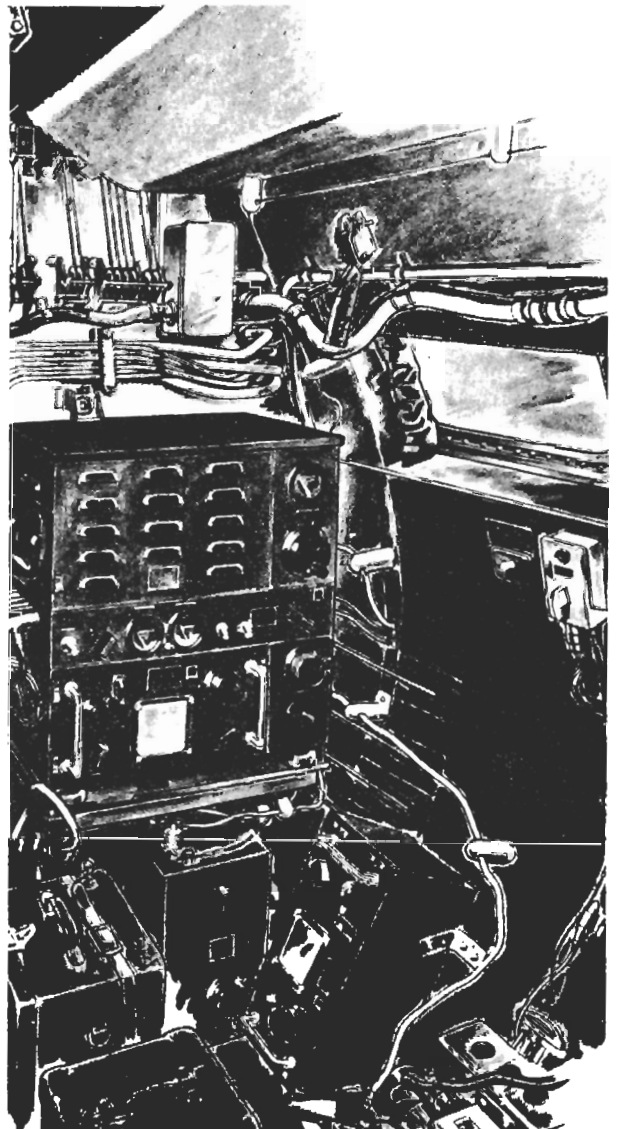

LOOKING AFT

Figure 74 — Radio Operator's Compartment

c. LIST OF EQUIPMENT.

(1) Liaison transmitter tuning unit (6200 to 7700 kilocycles).

(2) The antenna change-over relay, controlled by the microphone switches at each crew station, changes the command set from transmit to receive.

(3) Spare fluorescent lamp stowage.

(4) Extension light and switch.

(5) Dome light switch.

(6) Life raft stowage and placard.

(7) Spare whip antenna.

(8) The antenna current meter shows the output of the command transmitter. The switch is normally at "LOCAL" position. If a separate antenna current meter is installed in the pilot's compartment, it is connected by switching to "REMOTE."

(9) Spare lamp stowage.

(10) The command set modulator, used for voice transmissions, is connected when the selector switch on the command transmitter remote control box in the pilot's compartment is turned to "VOICE."

(11) The two command set transmitters (SCR-274-N) are connected to a remote control box in the pilot's compartment. Operating instructions are listed under "Pilot's Radio Equipment."

(12) Liaison transmitter key.

(13) The liaison receiver is fully explained in "Instruction Book for Radio Receiver BC-348."

(14) The three command set receivers (SCR-274-N) are connected to remote control boxes in the pilot's compartment. Operating instructions are listed under "Pilot's Radio Equipment."

(15) The radio compass receiver (SCR-269) is connected to two remote control boxes, one in the radio compartment and one in the co-pilot's compartment.

(16) The radio junction panel contains the radio compass relay unit and terminations for radio wiring. A wiring legend is stowed in the panel. Circuit breakers and fuses for the radio equipment are located on the inboard side of the panel.

(17) Ammunition boxes for left-hand belly guns.

(18) The adjustable desk lamp.

(19) Radio compass control box. The radio compass is operated from either the radio operator's or the co-pilot's compartment, each of which is provided with a remote control box. Operating instructions are listed under "Co-pilot's Radio Equipment." Tuning control is established at one position or the other by depressing the "CONTROL" button. A green light on the control box glows when that particular position has control of the radio. The set operates over three bands, the lowest for range stations and the two upper bands for broadcast stations, and is used for aural reception and aural-null or visual direction finding. The loop antenna, rotated by electric power, is controlled by the "LOOP" switch on the control box.

(20) The monitor switch is used to cut the liaison receiver in or out for monitoring the liaison transmitter.

(21) Radio compass bearing indicator.

(22) Interphone jack box.

(23) Oxygen regulator (type A-9A).

**NOTE**

The oxygen regulator is not installed in later model aircraft.

(24) The microphone switch and cord assembly incorporates jacks for earphones and microphone.

(25) Disc-type ventilator.

(26) Trailing antenna control box (liaison set).

(27) Charging handles for left-hand belly guns.

(28) The liaison transmitter is explained in "Instruction Book for Radio Transmitter BC-375-D."

(29) Loop antenna dehydrator.

(30) The frequency meter is used to check transmitter frequency. Operation is covered in "Instruction Book for Frequency Meter Set SCR-211-D."

(31) The antenna tuning unit, an integral part of the liaison transmitter, is used to balance the antenna.

(32) The signal light (C-3A) may be plugged in at receptacles in the bombardier's and radio operator's compartments or at any of the 24-volt receptacles provided on the suit heater panels in the aft compartments.

(33) Liaison transmitter tuning unit (7700 to 10,000 kilocycles). The frequency ranges and locations are as follows:

<i>Frequency Range</i>	<i>Location</i>
(a) 200 to 500 kilocycles—	Waist Compartment.
(b) 500 to 1500 kilocycles—	Aft Bomb Bay.
(c) 1500 to 3000 kilocycles—	Behind Navigator's Chair.
(d) 3000 to 4500 kilocycles—	Installed in Liaison Set.
(e) 4500 to 6200 kilocycles—	Under Navigator's Table.
(f) 6200 to 7700 kilocycles—	Ceiling Radio Operator's Compartment.
(g) 7700 to 10,000 kilocycles—	Behind Radio Operator's Chair.

(34) The liaison set dynamotor is installed in the forward bomb bay.

**d. SAFETY PRECAUTIONS.**

(1) Turn master switch on the pilot's pedestal "OFF" and have outside power source disconnected before making adjustments or changing tubes in the radio equipment. The high voltages required are very dangerous to human life.

(2) Replace all shields before operating radio equipment or completing any connection between radio transmitters and dynamotors.

(3) Trailing antenna must be fully retracted before bomb bay doors are operated in flight.

(4) Do not touch antennas while command or liaison transmitters are operating.

(5) While radio equipment is in operation, the antennas must be at least 1 foot removed from the nearest object.

(6) When ground testing radio equipment, the airplane should be moved at least 50 feet away from the nearest building or other airplane.

**2. NAVIGATOR'S COMPARTMENT.**

*(See figure 75.)*

*a. BEFORE ENTERING.*—Notify the pilot of the weight of any extra navigational equipment. Enter the airplane through the main entrance hatch in the nose wheel well or through the forward bomb bay.

*b. UPON ENTERING.*—Stow all loose equipment securely and make certain that all fixed equipment is in order.

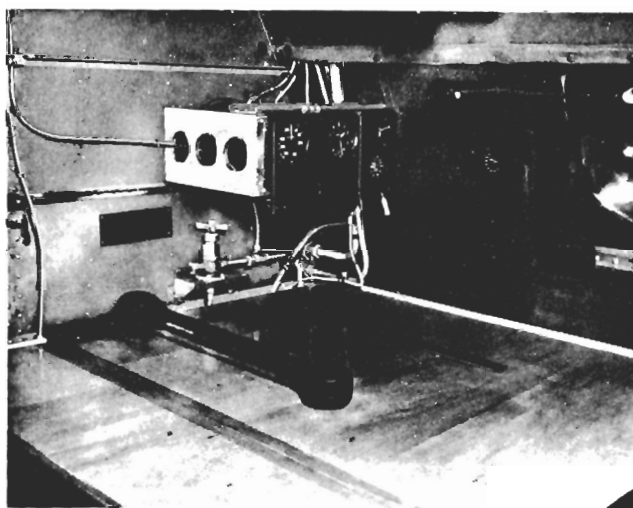

INSTRUMENTS



LOOKING AFT

Figure 75 — Navigator's Compartment

*c.* LIST OF EQUIPMENT.

- (1) Airspeed indicator.
- (2) Altimeter and altitude correction chart.
- (3) The static pressure selector valve is used to switch to an alternate source of static pressure.
- (4) Oxygen regulator (type A-9A).

**NOTE**

The oxygen regulator is not installed in later model aircraft.

(5) The fluorescent instrument panel light is operated by a switch on the reactor box. Rotation of the housing selects visible or invisible light for the instruments. A knob on the housing rotates an inner shutter, providing three degrees of intensity.

- (6) Free air temperature thermometer.
- (7) Emergency air brake shut-off and filler valve. The air bottle is installed just below the valve.
- (8) Protractor (Mark III-B).
- (9) Chart table.
- (10) Oxygen bottles.

(11) Ammunition boxes for right-hand belly guns.

(12) Liaison transmitter tuning unit (4500 to 6200 kilocycles).

(13) Drawer.

(14) The astrograph is designed to project the equal altitude curves of selected stars on standard plotting charts.

**NOTE**

The astrograph is not installed on later model aircraft.

(15) The B-5 driftmeter is used in conjunction with the bronze sea markers or the night drift flares stowed in the waist compartment.

**NOTE**

The B-5 driftmeter is not installed on later model aircraft.

- (16) Interphone jack box.
- (17) The microphone switch and cord assembly incorporates jacks for earphones and microphone.
- (18) Gun charging handles for right-hand fixed belly guns.

(19) The D-12 magnetic compass is used only when fixed belly guns are not installed.

(20) The astro-compass bracket stowed. The bracket is removed and installed in the astro-dome to provide a mount for the astro-compass.

(21) Junction box (gun sight and firing switch).

(22) Liaison transmitter tuning unit (1500 to 3000 kilocycles).

(23) Master heat control handles.

(24) The astro-compass, used to find the heading of the airplane or the bearing of a distant object, mounts in a special bracket on the astro-dome ring.

(25) Alarm bell.

(26) Main distribution panel.

(27) Wing de-icer control lever.

(28) Generator control box.

*d.* SAFETY PRECAUTIONS.

(1) Do not extend or retract the astro-dome at speeds above 190 mph.

**NOTE**

The astro-dome is replaced by a hatch on later model aircraft.

(2) Push heat control handles closed during take-off, landing, and before going into combat.

**3. BOMBARDIER'S COMPARTMENT.**

*(See figure 76.)*

*a.* BEFORE ENTERING.—Check bomb loading with the ground crew, making certain that release units, shackles, and fuse wires are properly installed. Be sure that chocks are installed when using the D-6 2000-pound bomb support. Enter the airplane through the main entrance hatch in the nose wheel well. Proceed forward through the pilot's compartment into the bombardier's compartment.

*b.* UPON ENTERING.—The master switch on the pilot's pedestal should be "OFF" if electric installations are to be checked. Check for proper functioning of instruments and controls. An external source of power should be connected when checking electric installations.

*c.* LIST OF EQUIPMENT.

(1) The emergency self-sealing hydraulic reservoir.



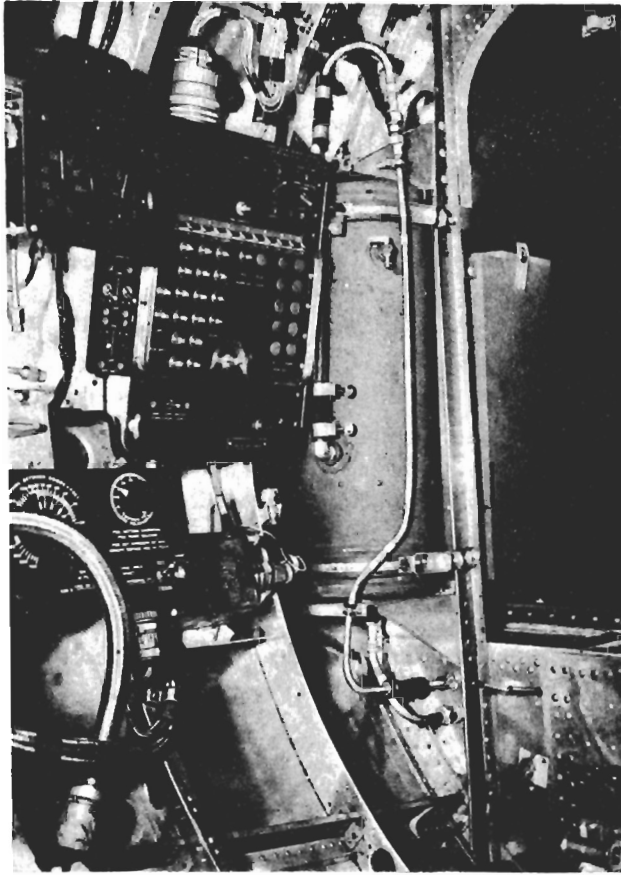

RIGHT SIDE VIEW

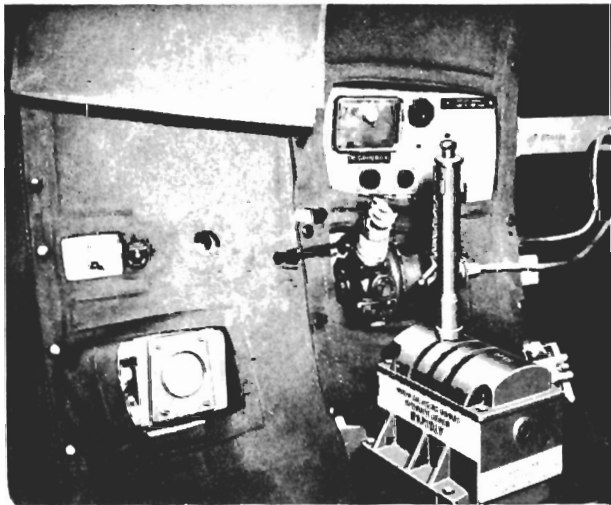

LEFT SIDE VIEW

Figure 76 — Bombardier's Compartment

(2) The dome light switch controls the bombardier's dome light.

(3) The spare ammunition box carries 135 rounds for use in the flexible nose gun.

(4) The magnetic compass is integrally lighted. The light is controlled by a rheostat knob on the indicator light panel.

**NOTE**

The magnetic compass is not installed in later model aircraft.

(5) The fluorescent instrument panel light is operated by the panel light switch on the indicator light panel. Rotation of the lamp housing selects visible or invisible illumination for the instruments. A knob on the housing rotates an inner shutter, providing three degrees of intensity.

**NOTE**

This instrument panel light has been replaced by incandescent fluorescent lights in later model aircraft.

(6) The reactor box for the fluorescent light.

(7) The instrument panel contains an airspeed indicator, an altimeter, and an altitude correction chart.

(8) The static pressure selector valve must always be in "ALTERNATE SOURCE" position when the glide bombing attachment is not installed.

**NOTE**

This valve is not installed in later model aircraft.

(9) The bomb rack selector switches control bomb rack selector units which automatically release the bombs in order from bottom to top, thus preventing collisions between bombs in the bomb bays. The units may be switched "ON" individually to control the right- or left-hand racks in either bomb bay or may be used in any desired combination.

(10) Interphone jack box.

(11) The intervalometer must be set for either "SELECTIVE" or "TRAIN" release of bombs. For "TRAIN" release, the dials must be pre-set for the number and the spacing between the bombs to be dropped.

(12) A bomb release toggle switch is installed at each side of the compartment. For "SELECTIVE" release, either the right or left switch is pressed to drop each bomb. For "TRAIN" release, either switch is pressed once, after which the intervalometer drops the selected train of bombs.

(13) The bomb rack selector units are operated by the bomb rack selector switches.

(14) The indicator light panel contains a small electric light for each of the 30 bomb stations in the bomb bays. When the indicator light switch is turned "ON," a panel light corresponding to each cocked bomb release unit will glow. The bomb bay door panel lights will glow when the corresponding bomb bay door is open. The bomb station indicator lights go out individually as the bombs are dropped, and the individual door indicator lights go out when the corresponding bomb bay doors are closed. Defective bulbs are discovered by holding the test switch momentarily "ON." The nose fuse D-4 switch is used when bombs are nose fused. Bombs are released with nose fuses ARMED or SAFE according to the position of the switch. The nose fuse D-4 switch is also used to arm 2000-pound bombs carried in D-6 adapters. The nose fuse D-4 switch should be in "SAFE" position except when bombs are being released. The formation light switch controls the brilliancy of the red and white release formation lights on the upper surface of the right nacelle cone. The white light is automatically switched on when the bomb bay doors open, and the red light when bombs are released. These lights are visible only from above and serve to warn friendly aircraft that bombs are being dropped. The panel light switch controls the fluorescent panel light. The compass light rheostat knob adjusts the brilliancy of the compass light.

(15) The microphone switch and cord assembly incorporates jacks for earphones and microphone.

(16) The flexible .50-caliber nose gun is supplied with ammunition from the 135-round box in the transparent nose.

(17) The bombsight window is provided with a windshield wiper and a perforated tube for dispensing anti-icing fluid. The small door at the left may be used for ventilation or for cleaning the glass.

(18) The defroster tube is used to defrost the bombsight or any part of the Plexiglas nose.

(19) The fixed .50-caliber nose gun, fired by the

pilot, is supplied with ammunition from a 200-round box under the bombardier's seat.

(20) Bomb release toggle switch.

(21) The bomb bay door selector handle is used to open the bomb bay doors together or individually by pushing the handle forward to "OPEN" position in either the "BOTH," the "AFT," or the "FWD" slot. To prepare the bomb shackles for electrical release, the handle is moved forward to "SELECTIVE" position. Before shifting from "OPEN" to "SELECTIVE," the bomb bay door indicator lights should be checked to be sure that the doors have opened.

(22) A bracket and base to receive the Estoppey D-8 bombsight head are regularly installed. The Norden M-series or the British Mark IX bombsight may be installed with special adapters.

(23) The windshield wiper and circuit breaker switches control operation of the electric wiper.

(24) The alcohol dispensing valve controls the flow of anti-icing fluid to the bombsight window.

(25) Ash tray.

(26) Electric receptacle for the C-3A signal light stowed in the radio operator's compartment.

(27) The camera intervalometer (B-4) is an automatic timing device used to operate the K-21 or K-24 cameras at regular predetermined intervals.

(28) The camera receptacle receives the camera intervalometer plug.

(29) The orientation receptacle receives a plug connection from the bomb release circuit.

(30) The camera switch is used to complete the circuit to the camera intervalometer.

(31) Free air temperature thermometer.

(32) Data case.

(33) Oxygen regulator (type A-9A).

#### NOTE

The oxygen regulator is not installed in later model aircraft.

(34) Bombardier's armor plate protection.

(35) Extension light and switch.

(36) Air cleaner for pilot's vacuum instruments.

(37) The alarm bell is controlled from the pilot's compartment.

d. SAFETY PRECAUTIONS.

(1) Before operating bomb bay door selector handle:

(a) Clear bomb bay of personnel.

(b) Warn radio operator to reel in trailing antenna.

(2) When operating bomb bay door selector handle:

(a) Do not push past "OPEN" position until bomb bay doors are open. Check the bomb bay door indicator lights, before pushing handle further forward to "SELECTIVE" or "SALVO" position.

(b) When salvoing bombs, push handle rapidly from "SELECTIVE" to "SALVO" position.

(3) Consult "Bomb Clearance Angle Chart" before releasing bombs in a glide or climb.

(4) Do not open bomb bay doors at a speed of 319 mph or over.

e. BOMB RELEASE.

(1) TRAIN RELEASE.

(a) Determine ground speed in mph.

(b) Push the toggle switch on the intervalometer down to "TRAIN" position.

(c) Adjust the interval dial, setting the applicable ground speed marking on the ground speed (miles per hour) dial, opposite the dropping interval desired on the interval between bombs dial (feet markings).

(d) Set the bombs to be released pointer opposite the dial number corresponding to the quantity of bombs to be dropped.

(e) Turn the indicator light toggle switch "ON." A panel light corresponding to each loaded bomb station will glow. Test for defective bulbs with test switch.

(f) If bombs are to be dropped nose armed, set the nose fuse D-4 switch to "ARM" position. The switch should be in "SAFE" position except when actually releasing bombs. Tail-fused bombs are armed automatically when released electrically.

(g) Set the formation light switch to "BRIGHT" or "DIM" as desired.

(b) Push the bomb bay door selector handle forward to "OPEN" position in either the "BOTH," "AFT" or "FORWARD" slot. When the bomb bay door indicator lights glow, indicating that the doors are open, push handle forward to "SELECTIVE" position to prepare the bombs for electrical release.

(i) Turn "ON" the bomb rack selector switches corresponding to the setting of the bomb bay door selector handle.

(j) When firing point is reached, lift safety cover on left bomb release toggle switch. Press and release, watching panel lights go out as the predetermined number of bombs is released by the intervalometer. As the bombs are released, the red release formation light on the right nacelle cone and the bomb release indicator light on the pilot's instrument panel will glow.

(k) Close bomb bay doors by pulling bomb bay door selector handle to extreme rear position.

(l) Turn the bomb rack selector switches "OFF."

(m) Turn nose fuse D-4 switch "OFF" if it has been used.

(n) Turn indicator light switch "OFF."

(2) SELECTIVE RELEASE.

(a) Pull the toggle switch on the intervalometer up to "SELECTIVE" position.

(b) Turn the indicator light toggle switch "ON." A panel light corresponding to each loaded bomb station will glow. Test for defective bulbs with the test switch.

(c) If bombs are to be dropped nose armed, set the nose fuse D-4 switch to "ARM" position. The nose fuse D-4 switch is also used for arming 1600- and 2000-pound bombs which are hung in the D-6 adapters. The 2000-pound bombs may be either nose or tail fused and are not automatically armed when released electrically. Whether nose or tail fusing is used, these heavy bombs must be armed before release by setting the nose fuse D-4 switch to "ARM."

(d) Set the formation light switch to "BRIGHT" or "DIM" as desired.

(e) Push the bomb bay door selector handle forward to "OPEN" position in either the "BOTH," "AFT," or "FORWARD" slot. When the bomb bay door indicator lights glow, indicating that the doors are open, push handle forward to "SELECTIVE" position to prepare the bombs for electrical release.

(f) Turn "ON" the bomb rack selector switches corresponding to the setting of the bomb bay door selector handle.

(g) When firing point is reached, lift safety cover on the right or left bomb release toggle switch. Press once for each bomb to be dropped, watching panel lights go out as bombs are released. As the bombs are released, the red release formation light on the right nacelle cone and the bomb release indicator light on the pilot's instrument panel will glow.

(h) Close bomb bay doors by pulling bomb bay door selector handle to extreme rear position.

(i) Turn the bomb rack selector switches "OFF."

(j) Turn nose fuse D-4 switch "OFF" if it has been used.

(k) Turn indicator light switch "OFF."

### (3) EMERGENCY RELEASE.

(a) BOMBARDIER'S SALVO (SAFE).—Shift bomb bay door selector handle forward to "SELECTIVE" position in the center slot, lift grip and rotate 90 degrees, then shift forward quickly to "SALVO" position. The contents of both bomb bays will be released "SAFE." Return selector handle to "CLOSED" position.

(b) PILOT'S SALVO (SAFE).—Pull the emergency bomb release handle full forward to SALVO bombs SAFE. Release handle to close doors. To hold the doors open for emergency exit, hook the release handle in forward position.

(c) RELEASE FROM BOMB BAY (SAFE).—Shift bomb bay door selector handle forward to "OPEN" position. Bombs may be released individually, proceeding from bottom to top, by prying the shackle release arm past the spring loaded ear of the release unit arm. Bombs will be released SAFE.

(d) RELEASE FROM BOMB BAY (ARMED).—Shift bomb bay door selector handle forward to "OPEN" position. Insert an offset head screw driver in the screw head on each release unit and turn to release bombs ARMED.

### CAUTION

Be sure the nose fuse D-4 switch is in "SAFE" position before attempting to SALVO bombs SAFE. If bombs are nose fused they will be released with nose fuses "ARMED" or "SAFE" according to the position of the nose fuse D-4 switch.

## 4. WAIST GUN AND CAMERA COMPARTMENT. (See figure 77.)

a. ENTERING COMPARTMENT.—Enter the waist compartment through either of the waist gun hatches.

### b. LIST OF EQUIPMENT.

- (1) Dome light switch.
- (2) Waist gunner's suit heater panel.
- (3) Interphone jack box.
- (4) Oxygen regulator.

### NOTE

The oxygen regulator is not installed in later model aircraft.

- (5) Camera junction box.
- (6) Mount for K-24, K-21, or F-24 camera.
- (7) Mount for electric tripper.

### NOTE

Mount for electric tripper is not installed in later model aircraft.

- (8) Liaison transmitter tuning unit (200 to 500 kilocycles).
- (9) Fire extinguisher.
- (10) Extension light.
- (11) Vacuum bottle.
- (12) Cup dispenser.
- (13) Alarm bell.
- (14) Waist gunner's safety belt stowage.
- (15) Interphone swivel connection.
- (16) Bronze sea marker stowage.
- (17) Night drift flare stowage.
- (18) Ammunition track to tail gun.

### NOTE

The auxiliary power plant is merely stowed in the waist gun and camera compartment.

## 5. PILOT'S RADIO EQUIPMENT.

a. COMMAND TRANSMITTER AND RECEIVER (SCR-274-N).

(1) GENERAL.—The command transmitter and receiver, located in the radio operator's compartment, is operated through remote control boxes in the pilot's compartment.

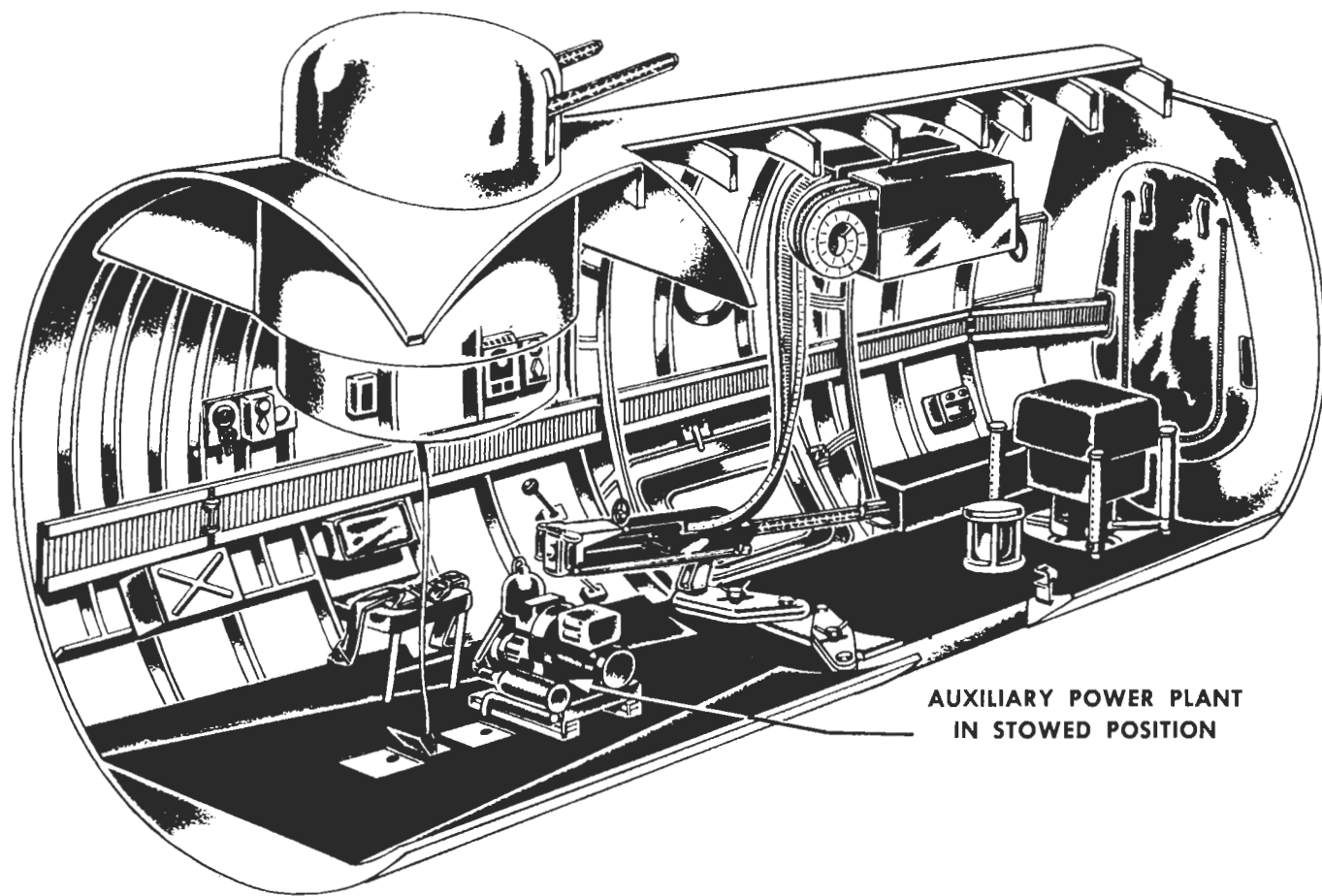

Figure 77 — Waist Gun and Camera Compartment

(2) COMMAND TRANSMITTER OPERATION. —Turn the transmitter selector lever to either "1" or "2," and switch transmitter power "ON." The selector switch may now be turned to either "TONE," "CW," or "VOICE." At "TONE" position the transmitter emits a signal practically 100 percent modulated at 1000 cycles. At "CW" position a continuous unmodulated signal is transmitted. "CW" is the most effective setting for long range communication. "CW" and "TONE" positions are used for code transmission by manipulating the key at the top of the transmitter control box. To transmit vocal messages, turn to "VOICE" position and depress the microphone switch. When transmitter power is "ON" and selector switch is at "VOICE," any crew member may transmit vocal messages by turning his jack box selector to "COMMAND" and closing his microphone switch.

(3) COMMAND RECEIVER OPERATION. — The command receiver control box is divided into three sections, each covering a different frequency band. The telephone channel selector switch (A-B) is always set from "OFF" to "A" position, since only one channel is provided in this set. For code reception turn the set to "CW" position and regulate tone to "RANGE" with the switch box selector. For voice reception turn to "MCW" position and regulate tone to "VOICE." Volume is controlled in either position by use of the increase output knob on the jack box. A tuning crank and dial are provided for each section of the receiver. After the receiver has been tuned, any crew member may listen in by turning his jack box selector to "COMMAND" position.

## 6. CO-PILOT'S RADIO EQUIPMENT.

### a. RADIO COMPASS (SCR-269).

(1) GENERAL.—The radio compass is operated from either the radio operator's or the co-pilot's compartment, each of which is provided with a remote control box. Tuning control is established at one position or the other by depressing the control button. A green light on the control box glows when that particular position has control of the radio. The set operates over three bands, the lowest for range stations and the two upper bands for broadcast stations, and is used for aural reception and aural-null or visual direction finding. The loop antenna is rotated by electric power and is controlled by the loop switch on the control box. The whip antenna is installed under the step to the pilot's compartment. The bearing indicator is located on the instrument panel.

### (2) OPERATING INSTRUCTIONS.

(a) GENERAL. — Switch to "COMP." Push control switch (hold if necessary) for green light. Set band switch. Tune to station frequency and rock tuning crank for maximum clockwise swing of tuning meter.

(b) HOMING.—Switch to "COMP." Airplane is always pointed toward received station when bearing indicator pointer is on the index.

(c) DIRECTION FINDING. — Switch to "COMP." Maintain aircraft heading. Turn outside bearing scale to magnetic heading of aircraft and correct for variation, using the variation knob. Allow time for bearing indicator pointer to come to rest. Read aircraft-to-station bearing at head of bearing indicator pointer and station-to-aircraft bearing at tail of bearing indicator pointer. To obtain fix, repeat on one or more stations and plot bearing. Airplane is at intersection of plotted bearing.

(d) RECEPTION. — Switch to "ANT." On range signals set interphone increase output knob to "MAX." and keep audio knob adjusted for lowest audible volume. For anti-static or aural-null operation switch to "LOOP" and use "L-R" switch for faster loop rotation. Push in "L-R" switch and turn.

## 7. PILOT'S ARMAMENT CONTROLS.

Switches for firing the five fixed guns and a control handle and firing switch for releasing the torpedo are located in the pilot's compartment.

a. The bomb release indicator light flashes each time a bomb is released.

b. The fixed gun safety switch closes the electrical circuit from the firing switch to the firing solenoids on the fixed nose gun and the four fixed belly guns.

c. The fixed gun firing switch.

d. The torpedo sight rheostat knob adjusts the brilliancy of the torpedo director sight.

e. The torpedo firing trigger is plugged into an electric receptacle on the instrument panel. The firing trigger is used for electric release of the torpedo ARMED.

f. The torpedo control handle is pulled out and slipped into the lower part of the keyhole to prepare for electric release of the torpedo ARMED. The torpedo control handle may also be used to drop the torpedo SAFE. The spring clip safety device is removed and the handle pulled quickly all the way out.

## 8. MARTIN POWER TURRET. (See figure 78.)

### a. DESCRIPTION.

(1) GENERAL.—The electrically powered upper gun turret is designed to rotate continuously in azimuth and to elevate the two .50-caliber M-2 machine guns from 5 degrees below to 85 degrees above the horizontal. Ammunition is fed to the guns by two automatic electric booster motors from two 400-round boxes at the forward part of the turret. The profile of the airplane is protected from gunfire by an interrupter which is interwired with the firing mechanism.

(2) CONTROLS.—Hand grips, with built-in gun triggers, control turret rotation and gun elevation. Conveniently located on the hand grips are a deadman, a microphone, and a high speed switch. Connections for heated clothing, oxygen, and interphone are carried into the turret through a swivel fitting. Master switches for azimuth and elevation power are under the seat. Camera, sight rheostat, and gun safety switches are installed at the right of the seat.

### (3) TURRET OPERATING INSTRUCTIONS.

#### (a) ENTERING TURRET.

1. Drop the seat bottom by pulling down on the wire at the front of the main junction box.



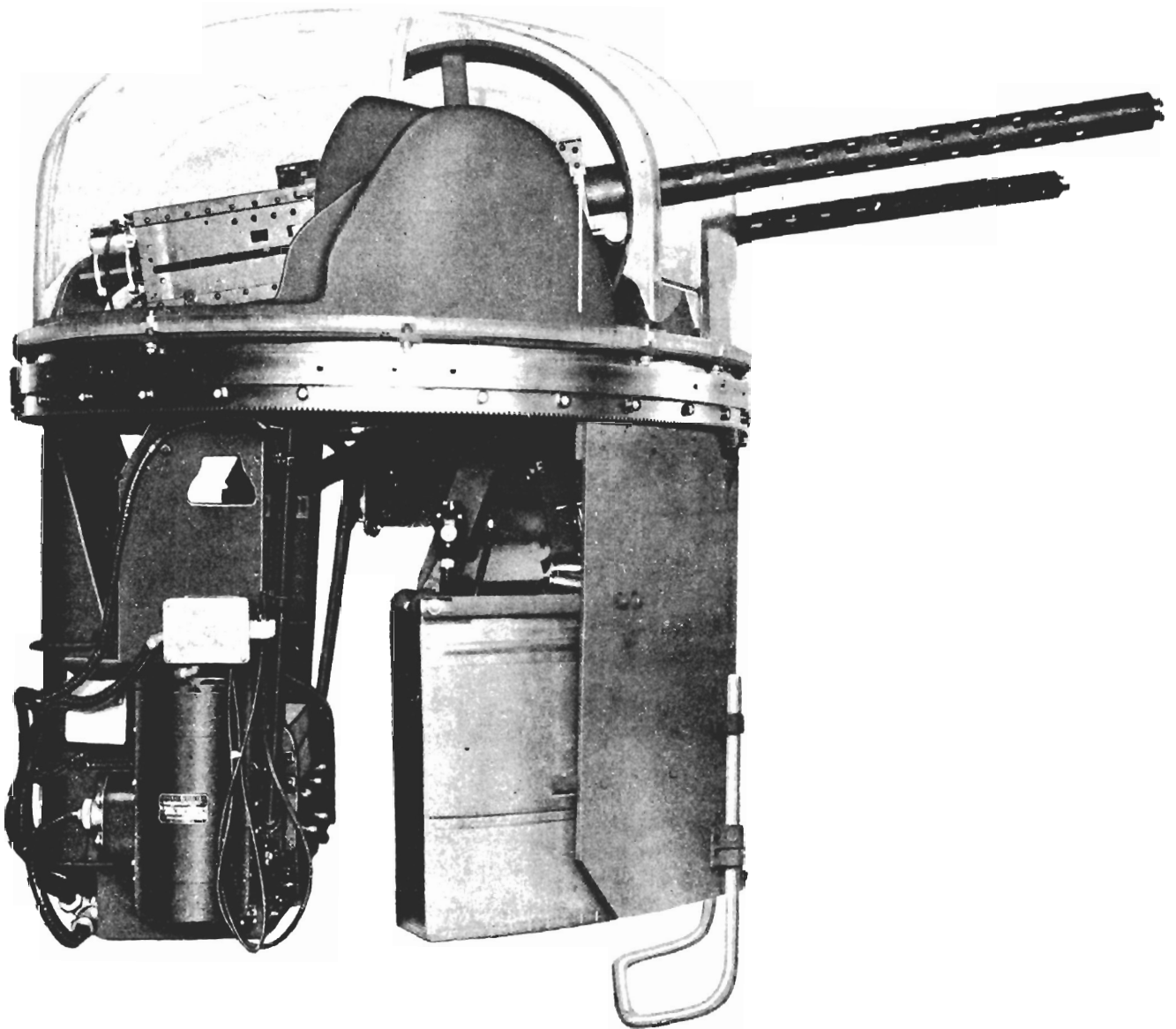

Figure 78 — Martin Power Turret

**WARNING**

To avoid accidents, the master switch should always be in the "OFF" position when the operator is entering or leaving the turret.

2. Ascertain whether one or two seat cushions are to be used and snap them into place on the seat.

3. Grasp the handles that are provided on the turntable casting above the seat and with both feet on the footrest slam the seat closed.

**CAUTION**

Do not use the sight link rods as handles.

*(b) TURRET CONTROLS. (See figure 79.)*

1. After being properly strapped in place, reach under the front edge of the seat and close the master switch on the right-hand side of the junction box.

2. Place both hands on the control grips, thereby operating the deadman switches and starting the amplidyne motor generators.

**NOTE**

Unless at least one of the deadman switches is depressed, the turret will not operate.



Figure 79 — Turret Controls

3. The guns are elevated and lowered by twisting the grips about the horizontal shaft on which they are mounted. To rotate the turret, the grips are turned about the vertical axis between them.

a. The speed at which the turret or guns move depends upon the displacement of the grips from the center position.

b. All motion is stopped by returning the grips to the center position or by releasing both dead-man switches.

4. The turret drive is designed to give a smooth speed varying from 0 to a maximum normal speed of 20 degrees per second in both elevation and azimuth. At any position of the control grips the speed can be increased approximately 2-1/4 times in azimuth and 1-1/2 times in elevation by pressing the high speed switch, which is located on the right-hand grip within easy reach of the thumb.

(c) GUN CONTROL.

1. Charge the guns by pulling the gun charging handles to the full extent of their travel and then releasing.

2. Raise the guard over the gun switch located on the front of the control unit and turn the switch to "ON."

3. The operation of the firing triggers is controlled by the selector switch located on the front of the control unit next to the gun switch.

a. When the selector switch is in the "DOWN" position, either trigger will fire both guns and operate the G.S.A.P. camera when used.

b. When the selector switch is in the "UP" position, the right-hand trigger fires the right-hand gun and the left-hand trigger fires the left-hand gun. The G.S.A.P. camera when used will operate only when the left-hand firing trigger is depressed.

4. The firing triggers are located in the control grips and are operated by the index fingers.

(d) CAMERA CONTROL.—The camera switch is located on the front of the control unit. When the switch is turned to "ON," the camera will operate when either firing trigger is depressed when the selector switch is turned to "BOTH GUNS." When the selector switch is turned to "INDIVIDUAL GUNS" the camera will operate only when the left-hand trigger is depressed.

(e) MICROPHONE CONTROL.—The microphone switch is located on the left-hand grip within easy reach of the thumb. Depress the switch to connect the microphone to the airplane interphone system.

(f) SIGHT CONTROL.—The N-6 or N-6A sight is controlled by a combination switch and rheostat located on the front of the control unit. On turrets of later manufacture the sight switch and rheostat is located on the sight yoke to the left of the sight.

(g) OVERLOAD PROTECTION.

1. Thermal overload circuit breakers for the control circuit and the ammunition booster circuit are located on the control unit panel.

2. Thermal overload circuit breakers for the gun circuit, the auxiliary power circuit, and the two amplidyne motor generator power circuits are located on the front of the junction box.

3. In the case of a short circuit or an excessive overload the breakers will snap open within a short period of time. They can be reclosed after a few seconds by pushing the reset button but will open again if the overload condition still exists.

(b) **MANUAL DRIVE.**—The manual drive is provided for auxiliary operation in the event the electric drive becomes inoperative.

1. Release the azimuth and elevation motor drive clutches.

2. Rotate both the right and left drive cranks in either direction until the manual drive engages.

3. The right-hand crank operates the turret in azimuth.

a. Looking at the handle end, rotate the crank in a clockwise direction to turn the turret to the right and counterclockwise to turn the turret to the left.

b. The right crank handle incorporates a gun firing switch, button type, for operation with the thumb.

4. The left-hand crank operates the turret in elevation. Looking at the handle end, rotate the crank in a clockwise direction to elevate the guns and counterclockwise to depress the guns.

## 9. TAIL GUN COMPARTMENT. (See figures 80 and 81.)

### a. TYPE M-6 MOUNT.

#### (1) GENERAL.

(a) Two M-2, .50-caliber guns fitted with G-11 solenoids, are mounted side by side in a Bell type M-6 mount in the extreme tail of the airplanes of later manufacture.

(b) The Bell Sundstrand system of control is designed to provide remote control of gun movements in both azimuth and elevation. The system consists of two hydraulic pumps and a motor in one unit, azimuth and elevation vanes, and a control unit. The control unit is mounted on the back of the armor plate thereby enabling the gunner to remain in a protected position.

(c) Gun charging handles are installed in the most forward position on each gun and are accessible through the armor plate doors.

(d) Firing triggers are incorporated in the gun mount control grips.

(e) Accurate sighting of guns is obtained through the use of an N-8 illuminated sight mounted immediately forward of the window in the armor plate.

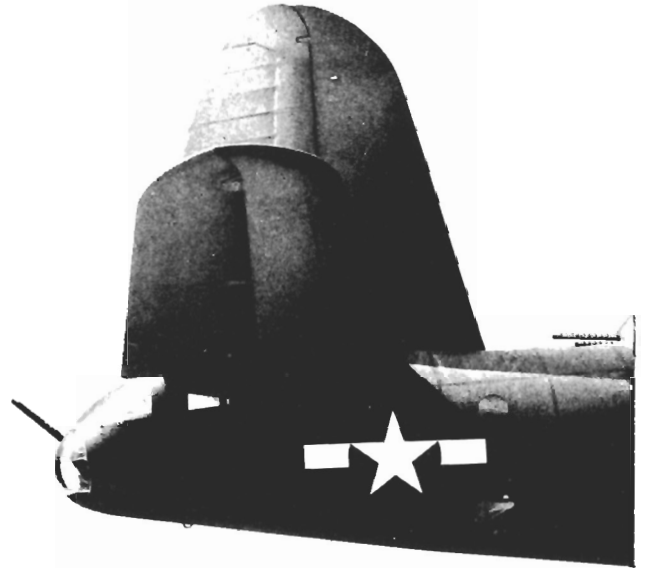

Figure 80 — Aft Section of Airplane

#### (2) GUN CONTROL.

(a) To charge the guns, open the armor plate doors to gain access to the charging handle. Pull handle back through the full extent of its travel and then release.

(b) The armor glass window may be opened in order to obtain additional scanning vision. Access to the sight switch and bulb is also obtained through this door.

(c) Close armor glass window before becoming engaged in combat.

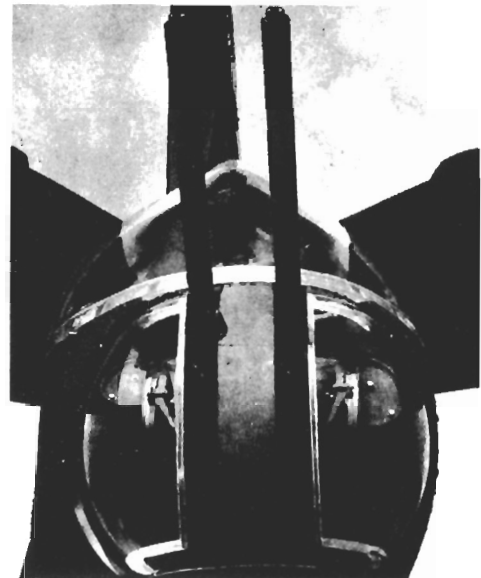

Figure 81 — Bell Type M-6 Mount

(d) Turn power supply "ON." The switch is located on the cover of the junction box directly above the control unit.

(e) Turn both left- and right-hand booster motor switches "ON." These switches are located on the cover of the junction box directly above the control unit.

(f) Grasp hand grips.

(g) Depress deadman switch permitting operation of the mount.

#### WARNING

Keep fingers off triggers until ready to fire.

#### NOTE

Push-buttons, in the face of the hand grips, are for interphone.

(b) To aim in azimuth, turn grips on their vertical axis. The speed of gun movement is controlled by the displacement of the grips from their center position.

(i) To aim in elevation, turn grips about their horizontal axis.

(j) Sighting is accomplished through an illuminated sight mounted directly forward of the armor window.

(k) Depress triggers to fire guns. Both guns are controlled and may be fired by either or both hands. Guns cannot be fired individually.

#### (3) LIST OF EQUIPMENT INSTALLED IN TAIL GUN COMPARTMENT.

(a) Tail gunner's stool.

(b) Side window defrosters.

(c) Heater.

(d) Switches for right and left ammunition booster motors.

(e) Extension light.

(f) Interphone jack box.

(g) Oxygen regulator (type A-9A).

#### NOTE

The oxygen regulator is not installed in later model aircraft.

(b) Suit heater panel.

(i) Head rest.

#### b. TWIN MANUALLY OPERATED GUNS

(installed in airplanes of early manufacture).

##### (1) GENERAL.

(a) To charge the guns swing handles outboard and up.

(b) Grasp handles, pull them back to the full extent of their travel, and then release.

(c) Fold the handles into their stowed position.

(d) Grasp the spade grips and swing guns about the yoke as desired.

(e) Firing is accomplished through use of either the push-button switch on the grip or the chain attached to the manual trigger mechanism.

**APPENDIX I**  
**GLOSSARY OF NOMENCLATURE**



<i>U. S.</i>	<i>British</i>	<i>U. S.</i>	<i>British</i>
Airplane	Aeroplane	Muffler	Silencer
Airport	Aerodrome	Navigation	Avigation
Antenna	Aerial	Pan, oil	Crankcase sump
Bombardier	Bomb Aimer	Pin, cotter	Split pin
Capacity, fuel	Fuel volume	Pin, knuckle	Wrist pin
Ceiling	Cloud height	Plug, spark	Sparking plug
Co-Pilot	Second pilot	Pressure, manifold	Boost pressure
Controls, air	Flying controls	Radio	Wireless
Course	Track angle	Radio operator	Wireless operator
Cylinder, hydraulic	Jack	Raft, life	Dinghy
Efficiency, propeller	Net efficiency	Right	Starboard
Field, Landing	Landing ground	Run, green	Running-in
Flare, signal	Signal projectile	Set, liaison	General purpose set
Friction, skin	Surface friction	Set, command	Pilot controller set
Gage, fuel	Fuel contents gauge	Speed, calibrated air	Indicated air-speed
Head, air-speed	Pressure head	Speed, indicated air	Air-speed-indicator reading
Heading	Course	Stabilizer, horizontal	Tail plane
Inclinometer	Clinometer	Stabilizer, vertical	Fin
Inverter	Motor Generator (DC to AC)	Stack	Pipe
Lean	Weak	Tab, trim	Trimming tab
Left	Port	Weight empty	Tare weight
Level-off	Flatten out	Windshield	Windscreen
Mast, Radio	Rod aerial	Wing	Main plane
Meter, drift	Drift sight	Zone, combat	Forward area
Meter, frequency	Wavemeter		

## APPENDIX II

### FLIGHT OPERATING CHARTS, TABLES, CURVES AND DIAGRAMS

#### 1. INTRODUCTION.

The following Flight Operation Data are presented to acquaint the pilot with tested operating and performance data for the airplane. Adherence to the operation instructions given on the charts will result in attainment of best possible performance under each required condition. Sooner or later, every pilot is confronted with a situation which requires the maximum performance from his airplane. Success in meeting such situations hinges largely on a thorough understanding of the limitations and capabilities of the airplane under the various conditions outlined in these charts.

#### 2. TAKE-OFF CLIMB AND LANDING CHART.

(See Figure 82.)

a. The "Take-off Distance Table" lists the ground run necessary for take-off and the total distance required to clear a 50-ft. obstacle for various gross weights, wind speeds, altitudes and runway surfaces. The take-off distances are for average service conditions; with precision flying, take-off distances of only 80 percent of the values shown may be obtained. Optimum take-off is obtained by taking off at approximately power-on stall speed with the flaps deflected 3/4-down and maintaining the same speed while climbing over the obstacle.

b. The "Climb Data Table" gives the best climb speed, rate of climb, time to climb and the fuel used for climb to various altitudes with Normal Rated Power. The rates of climb listed are actual flight test values obtained with cowl flaps set at 15 degrees. It is imperative that the cowl flaps and oil cooler shutters be kept as near closed as possible without exceeding engine temperature limits. A 15-degree setting will normally be adequate for rated power climbs in summer air and much lower settings can be used in winter air. A change in cowl flap setting from 15 to 30 degrees results in 10 percent loss in rate of climb. The fuel consumption data given contain a margin of 5 percent to allow for the normal variations between engines. An allowance of 60 gallons of fuel is shown in the sea level column for warm-up and take-off, and the same allowance is contained in the fuel values shown on this chart to climb to other altitudes. If range is more important than high rate of climb, power settings from the "Flight Operation Instruction Charts" (figure 83) should be used for climbing soon after take-off. The range during climb can be increased 50 percent at

heavy gross weights and as high as 150 percent at light gross weights by operating according to Column V of these charts. When climbing with cruising powers for maximum range as given in Column V (figure 83), the best climb speeds are 10 MPH lower than the best climb speeds (Best I.A.S.) given for "Rated Power Climb" in figure 82.

c. The "Landing Distance Table" lists the ground roll distance as well as the total distance required to land over a 50-ft. obstacle for various gross weights and altitudes. The best indicated approach speeds given are safe speeds for approaching the field with flaps deflected 40 degrees (full down). The landing distances given are for average service conditions; with precision flying, landing distances of only 80 percent of the values shown can be obtained. Optimum landing is obtained by passing the obstacle at approximately stall speed, descending to the ground at the same speed avoiding an excessively long flare distance and applying full braking power shortly after landing.

#### 3. FLIGHT OPERATION INSTRUCTION CHARTS.

(See Figures 83 and 84.)

This group of charts is most important in flight planning. In making up a flight plan, the available fuel for the mission is obtained by subtracting the allowances for warm-up, taxiing, take-off and climb from the total fuel load. The remaining fuel is available for cruising and reserve. From gross weight, range required, altitude desired and available fuel figures, the engine operation and cruising speed can be chosen to meet the requirements. The fuel required and flying time for a given mission depend largely upon the speed desired. With all other factors remaining equal in an airplane, speed is obtained with a sacrifice of range; and, conversely, range is obtained with a sacrifice in speed. The speed is usually determined after considering the urgency of the flight and the range obtainable at various speeds. The time of take-off is adjusted to have the flight arrive at its destination at the predetermined time.

##### a. GENERAL INSTRUCTIONS.

(1) The charted ranges make no allowance for warm-up, take-off and climb. Fuel consumed during these operations should be obtained from the "Take-off Climb and Landing Chart" (see figure 82). Similarly, no account is taken of the improved miles per gallon realizable during descent. Neglect of this factor is recommended to balance the fuel required for the landing operation.



(2) The operating data included on any one chart should be used only when the gross weight is within the limits specified in the title block. When diminishing fuel load causes the gross weight to decrease to a value included in the weight limits of the next chart, the operating data included in the corresponding column of that chart should be used. **THIS IS ESSENTIAL, AS RANGES HAVE BEEN COMPUTED ON THIS BASIS.** In planning a flight in which bombs are dropped, the flight should be considered split into two legs to determine the fuel required or range available for each condition. Consideration of the lighter gross weight condition after the bombs are dropped results in increased economy.

(3) All data have been based on the maximum weight for which the chart is applicable. When gross weight is within the chart weight limits and less than the maximum (due to lighter initial weight or diminished fuel load), the airspeed should be slightly greater than that listed on the chart. In order to maintain the charts in a simplified form, no account has been taken of this factor. The operating data given are therefore slightly conservative.

(4) Experience has shown that fuel consumptions vary some between engines particularly under difficult service conditions. Therefore a conservative margin of five percent has been included in all of the fuel consumptions and range values shown on the "Flight Operation Instruction Charts." The fuel consumptions listed are five percent higher, and the range values given are five percent less than careful flight tests have shown with both airplane and engines in first-class condition. **NO ALLOWANCE HAS BEEN MADE FOR WIND, NAVIGATIONAL ERROR, OR OTHER CONTINGENCIES. NO ALLOWANCE HAS BEEN MADE FOR COMBAT OR FORMATION FLIGHT. APPROPRIATE ALLOWANCES FOR THESE ITEMS SHOULD BE DICTATED BY LOCAL DOCTRINE.** The fuel quantity used in entering the chart, therefore, should be the fuel available after reaching flight altitude less allowances appropriate for the mission.

#### b. PLANNING A FLIGHT.

(1) Select the "Flight Operation Instruction Chart" for the initial gross weight.

(2) Locate the largest figure entered under G.P.H. (gallon per hour) in the column applicable to the flight plan on the lower half of the chart.

(3) Multiply this figure by the number of hours desired for reserve fuel.

(4) Add the resulting figure to the number of gallons required for starting, warm-up and take-off (Normally 60 gallons unless additional allowance is required for delays in take-off or climbing (figure 82)).

(5) Subtract this figure from the number of gallons of fuel in the airplane before the engines were started. This figure represents the amount of fuel available for cruising and applicable for flight planning purposes on the "Flight Operation Instruction Chart."

(6) Select the figure in the fuel column equal to (or just below) the amount of fuel determined in the preceding paragraph.

(7) Read horizontally to the right or left and select the "Range in Airmiles" figure equal to (or just above) the number of airmiles (with no wind) to be flown.

(8) Reading vertically downward in the column in which this figure appears will give the highest cruising speed (I.A.S., true airspeed) possible for the range desired together with the optimum engine settings. The airplane may be flown using values contained in any column of a higher range with the flight plan being completed at a sacrifice of airspeed, but an increase in fuel economy. The airplane and engine operating values listed in any single column are calculated to give approximately constant miles per gallon at all altitudes listed. Therefore, the airplane may be operated at any altitude with the corresponding conditions given, as long as they are in the same column listing the range desired.

#### c. OPERATING AND PLANNING DURING FLIGHT.

(1) When the gross weight becomes less than the minimum limit specified on the "Flight Operation Instruction Chart" used for the take-off gross weight, read the operating data from the same column on the chart of the next lowest gross weight.

(2) The time (in hours) during flight, when this transition occurs, can be found by dividing the difference between the take-off gross weight and the minimum weight on the chart by six times the gallons per hour fuel consumption. (Note: One gallon of gasoline weighs six pounds).

(3) If the flight is of long duration, make the change in operating data several times, i.e., as soon as the airplane gross weight "falls" in the next chart weight range.

(4) The flight plan may be changed readily at any time en route, and the chart will show the balance of range at various cruising powers by following the "Instructions for Using Chart" printed on each chart. If the flight dictates a mission requiring changes in engine power, airspeed, gross weight (dropping bombs), or if one engine fails in flight, "break down" the total flight into a series of "short flights," compute each individually, and then add them together to determine the total flight and its requirements.

**CAUTION**

Be sure to select the correct chart applicable to the specific operating condition.

**Note**

All fuel consumptions and ranges given in the flight operating charts are for fuel of standard density. Fuel is at standard density (6.0 pounds per gallon) when its temperature is 15°C. The density of fuel decreases with an increase in temperature, and, conversely, the density of fuel increases with a decrease in temperature. As a result, the power output of a gallon of gasoline at low temperature is higher, and, conversely, the power output is lower at high temperature. The effect of temperature on the weight of fuel carried is important for extreme temperature conditions. The fuel volume (gallons) with which the airplane is loaded should be multiplied by the temperature correction factors given below to obtain the *standard density fuel* carried.

**FUEL TEMPERATURE      FUEL TEMPERATURE  
DEGREES CENTIGRADE      CORRECTION FACTOR**

60	.954
50	.964
40	.974
30	.985
20	.995
15	1.000
10	1.007
0	1.015
-10	1.030
-20	1.043
-30	1.057
-40	1.072

**Example:**

All tanks are filled to capacity of 1992 gallons and the temperature of the airplane is observed on the O.A.T. gage to be 40°C at time of take-off.

Standard Density fuel = Temperature Correction Factor x gallons fuel

$$= .974 \times 1992 = 1940 \text{ gallons}$$

Only 1940 "effective" gallons of fuel are available for the flight.

**4. MORE MILES PER GALLON.**

The highest operating efficiency of an airplane is obtained with conditions which give the maximum miles per gallon of fuel. Since the airplane is composed of the airframe and the power plant, peak efficiency results from the best operating combination of both. The "Flight Operation Instruction Charts" are constructed to give optimum engine settings for each airplane condition shown with maximum range being obtained in Column V. The pilot should operate his airplane carefully according to these charts to obtain maximum efficiency. In addition to following the charts precisely the pilot can increase the operating efficiency by reducing unnecessary drag items and by choosing the optimum altitude.

a. DRAG.—The drag of an airplane can vary depending upon its mission and loading conditions, particularly when external high-drag items are included. Similarly, the drag of the airplane can change during flight due to changes in configuration caused by tactical or operational circumstances. In the normal operation of the B-26 airplane there are a number of drag items which can be controlled, at least on certain missions. The elimination of these items plus general cleanliness of the airplane surfaces add up to give the so called "clean airplane" and result in maximum flight efficiency. Below are listed a number of drag items with their respective costs in maximum range of the B-26 airplane.

<i>Drag Item</i>	<i>Cost in Percent Maximum Range</i>
1. Cowl flaps open 15 degrees	3
2. Cowl flaps open 30 degrees	13
3. Deck turret (guns pointing in aft position)	2
4. Deck turret (guns pointing broadside)	3
5. Package guns (4)	2
6. Open waist gun doors and air deflectors	5
7. One dead engine with propeller feathered	30-45

b. OPTIMUM CRUISING ALTITUDE. — It has been stated above that any single column on the "Flight Operation Instruction Charts" gives *approximately constant miles per gallon at all altitudes*. By following the optimum altitudes given below, advantage can be taken of small increases in range which could not be included on the simplified charts. When operating with rated power, Column I, range will increase with an increase in operating altitude until the optimum altitude of 15,000 feet is reached. At 39,000 pounds gross weight with rated power, the range is

seven percent greater at 15,000 feet than at sea level; and at 27,000 pounds gross weight, the range is eighteen percent greater at 15,000 feet. At heavy gross weights, maximum range operation, Column V, will be most efficient at sea level to 5,000 feet. For gross weights below 33,000 pounds greatest range is obtained at 10,000 to 15,000 feet. The benefits in maximum range to be gained by following these optimum altitudes is one percent at 39,000 pounds gross weight varying to five percent at 27,000 pounds gross weight.

AIRCRAFT MODEL(S) B-26B-1, & B-26C		<b>TAKE-OFF, CLIMB &amp; LANDING CHART</b>																		ENGINE MODEL(S) R-2800-41 R-2800-43	
<b>TAKE-OFF DISTANCE FEET</b>																					
GROSS WEIGHT LB.	HEAD WIND M.P.H. KTS.		HARD SURFACE RUNWAY						SOD-TURF RUNWAY						SOFT SURFACE RUNWAY						
			AT SEA LEVEL		AT 3000 FEET		AT 6000 FEET		AT SEA LEVEL		AT 3000 FEET		AT 6000 FEET		AT SEA LEVEL		AT 3000 FEET		AT 6000 FEET		
	GROUND RUN	TO CLEAR 50' OBJ.	GROUND RUN	TO CLEAR 50' OBJ.	GROUND RUN	TO CLEAR 50' OBJ.	GROUND RUN	TO CLEAR 50' OBJ.	GROUND RUN	TO CLEAR 50' OBJ.	GROUND RUN	TO CLEAR 50' OBJ.	GROUND RUN	TO CLEAR 50' OBJ.	GROUND RUN	TO CLEAR 50' OBJ.	GROUND RUN	TO CLEAR 50' OBJ.	GROUND RUN	TO CLEAR 50' OBJ.	
38000	0		2390	3590	2870	4280	3670	5760	2540	3730	3070	4490	3980	6080	3040	4240	3740	5140	5040	7130	
	20		1680	2670	2050	3220	2680	4440	1790	2770	2200	3370	2910	4670	2130	3120	2670	3840	3680	5448	
	40		1090	1860	1350	2280	1830	3250	1150	1930	1450	2390	1980	3400	1380	2160	1780	2710	2516	3936	
32000	0		1590	2510	1910	2920	2440	3630	1680	2600	2010	3020	2570	3760	1920	2840	2330	3340	3060	4260	
	20		1080	1820	1310	2140	1710	2700	1140	1880	1390	2220	1800	2780	1300	2040	1610	2440	2150	3130	
	40		660	1220	830	1470	1110	1880	700	1260	870	1510	1160	1950	800	1360	1020	1650	1400	2170	
26000	0		990	1710	1190	1970	1480	2370	1030	1750	1230	2010	1550	2430	1140	1860	1380	2160	1760	2630	
	20		640	1210	790	1410	1000	1710	660	1230	830	1440	1050	1750	730	1300	920	1540	1190	1890	
	40		350	770	460	920	610	1140	370	780	490	940	640	1170	410	820	530	1000	720	1250	

NOTE: INCREASE CHART DISTANCES AS FOLLOWS: 75°F + 10%; 100°F + 20%; 125°F + 30%; 150°F + 40%  
 DATA AS OF 12-15-44 BASED ON: FLIGHT TEST (RED VALUES CALCULATED)  
 AT SEA LEVEL OPTIMUM TAKE-OFF WITH 2700 RPM, 52 IN.HG. & 30 DEG. FLAP IS 80% OF CHART VALUES  
 AT 3000 FEET OPTIMUM TAKE-OFF WITH 2700 RPM, 51 IN.HG. & 30 DEG. FLAP IS 80% OF CHART VALUES  
 AT 6000 FEET OPTIMUM TAKE-OFF WITH 2700 RPM, 46 IN.HG. & 30 DEG. FLAP IS 80% OF CHART VALUES

<b>CLIMB DATA</b>																												
GROSS WEIGHT LB.	AT SEA LEVEL			AT 5000 FEET			AT 10,000 FEET			AT 15,000 FEET			AT 20,000 FEET			AT 25,000 FEET												
	BEST I. A. S.		RATE OF CLIMB F.P.M.	BEST I. A. S.		RATE OF CLIMB F.P.M.	FROM SEA LEVEL		BEST I. A. S.		RATE OF CLIMB F.P.M.	FROM SEA LEVEL		BEST I. A. S.		RATE OF CLIMB F.P.M.	FROM SEA LEVEL		BEST I. A. S.		RATE OF CLIMB F.P.M.	FROM SEA LEVEL						
	MPH	KTS		MPH	KTS		TIME MIN.	FUEL USED	MPH	KTS		TIME MIN.	FUEL USED	MPH	KTS		TIME MIN.	FUEL USED	MPH	KTS		TIME MIN.	FUEL USED	MPH	KTS	TIME MIN.	FUEL USED	
38000	166		820	60	163		830	6.5	100	159		540	14.0	145	154		410	24.5	200									
32000	160		1220	60	157		1250	4.5	85	154		930	9.0	115	149		810	15.0	145	144		370	24.0	190				
26000	152		1770	60	149		1830	3.0	80	146		1470	6.0	95	142		1350	9.5	115	137		850	14.0	135	132	360	23.0	170

POWER PLANT SETTINGS: (DETAILS ON FIG. 66 SECTION 111): 2400 RPM, 42 IN.HG. SHIFT TO HIGH BLOWER AT 9000 FEET.  
 DATA AS OF 12-15-44 BASED ON: FLIGHT TEST FUEL USED (U.S. GAL.) INCLUDES WARM-UP & TAKE-OFF ALLOWANCE

<b>LANDING DISTANCE FEET</b>																						
GROSS WEIGHT LB.	BEST IAS APPROACH				HARD DRY SURFACE						FIRM DRY SOD						WET OR SLIPPERY					
	POWER OFF		POWER ON		AT SEA LEVEL		AT 3000 FEET		AT 6000 FEET		AT SEA LEVEL		AT 3000 FEET		AT 6000 FEET		AT SEA LEVEL		AT 3000 FEET		AT 6000 FEET	
	MPH	KTS	MPH	KTS	GROUND ROLL	TO CLEAR 50' OBJ.	GROUND ROLL	TO CLEAR 50' OBJ.	GROUND ROLL	TO CLEAR 50' OBJ.	GROUND ROLL	TO CLEAR 50' OBJ.	GROUND ROLL	TO CLEAR 50' OBJ.	GROUND ROLL	TO CLEAR 50' OBJ.	GROUND ROLL	TO CLEAR 50' OBJ.	GROUND ROLL	TO CLEAR 50' OBJ.	GROUND ROLL	TO CLEAR 50' OBJ.
34000	150		140		2000	3890	2200	4220	2410	4560	2380	4230	2360	4370	2280	4960	7220	9110	7920	9920	8650	10800
26000	135		125		1540	3070	1680	3320	1840	3620	1800	3330	1960	3610	2150	3930	5546	7070	6050	7690	6630	8410

DATA AS OF 12-15-44 BASED ON: FLIGHT TEST (RED VALUES CALCULATED)  
 REMARKS: OPTIMUM LANDING IS 80% OF CHART VALUES

**LEGEND**  
 I. A. S. : INDICATED AIRSPEED  
 M.P.H. : MILES PER HOUR  
 KTS. : KNOTS  
 F.P.M. : FEET PER MINUTE

NOTE: TO DETERMINE FUEL CONSUMPTION IN BRITISH IMPERIAL GALLONS, MULTIPLY BY 10, THEN DIVIDE BY 12

Figure 82 — Take-off, Climb, and Landing Chart

AFPM-5/8 7-1-74		AIRCRAFT MODEL(S) B-26B-1, B-26C							FLIGHT OPERATION INSTRUCTION CHART							EXTERNAL LOAD ITEMS NONE																		
ENGINE(S): R-2800-41 R-2800-43		CHART WEIGHT LIMITS: 39000 TO 36000 POUNDS														NUMBER OF ENGINES OPERATING: TWO (2)																		
LIMITS	RPM	M.P. IN. HG.	BLOWER POSITION	MIXTURE POSITION	TIME LIMIT	CYL. TEMP.	TOTAL G.P.H.	INSTRUCTIONS FOR USING CHART: SELECT FIGURE IN FUEL COLUMN EQUAL TO OR LESS THAN AMOUNT OF FUEL TO BE USED FOR CRUISING <sup>(1)</sup> MOVE HORIZONTALLY TO RIGHT OR LEFT AND SELECT RANGE VALUE EQUAL TO OR GREATER THAN THE STATUTE OR NAUTICAL AIR MILES TO BE FLOWN. VERTICALLY BELOW AND OPPOSITE VALUE NEAREST DESIRED CRUISING ALTITUDE (ALT.) READ RPM, MANIFOLD PRESSURE (M.P.) AND MIXTURE SETTING REQUIRED.							NOTES: COLUMN I IS FOR EMERGENCY HIGH SPEED CRUISING ONLY. COLUMNS II, III, IV AND V GIVE PROGRESSIVE INCREASE IN RANGE AT A SACRIFICE IN SPEED. AIR MILES PER GALLON (MI./GAL.) (NO WIND), GALLONS PER HR. (G.P.H.) AND TRUE AIRSPEED (T.A.S.) ARE APPROXIMATE VALUES FOR REFERENCE. RANGE VALUES ARE FOR AN AVERAGE AIRPLANE FLYING ALONE (NO WIND) <sup>(2)</sup> TO OBTAIN BRITISH IMPERIAL GAL. (OR G.P.H.): MULTIPLY U.S. GAL. (OR G.P.H.) BY 10 THEN DIVIDE BY 12.																			
WAR EMERG.								FOR DETAILS SEE POWER PLANT CHART (FIG. 66 SECT. III)																										
MILITARY POWER	2700	52	LOW	A.R.	5 Min	260°	540																											
COLUMN I				FUEL			COLUMN II				COLUMN III				COLUMN IV				FUEL		COLUMN V													
RANGE IN AIRMILES				U.S.			RANGE IN AIRMILES				RANGE IN AIRMILES				RANGE IN AIRMILES				U.S.		RANGE IN AIRMILES													
STATUTE		NAUTICAL		GAL.			STATUTE		NAUTICAL		STATUTE		NAUTICAL		STATUTE		NAUTICAL		GAL.		STATUTE		NAUTICAL											
1465				1270			1992				1825				1585				2190		1900				2540		2205							
1360				1180			1932				1470				2025				1760		2350				2040		2680							
1280				1110			1800				1380				1900				1650		2200				1910		1700							
1200				1040			1600				1295				1775				1540		2055				1785		1600							
1125				975			1500				1210				1645				1430		1905				1655		1500							
1050				915			1400				1125				1530				1330		1765				1535		1400							
975				845			1300				1195				1040				1225				1630		1420				1300		1845			
900				780			1200				955				1295				1490		1295				1200		1685							
820				710			1100				870				1180				1025		1355				1180		1530							
745				645			1000				905				1060				920		1215				1055		1000							
670				580			900				705				950				825		1085				945		900							
595				515			800				625				840				730		960				835		800							
MAXIMUM CONTINUOUS				PRESS			(.88 STAT. (.76 NAUT.) MI./GAL.)				(1.02 STAT. (.88 NAUT.) MI./GAL.)				(1.16 STAT. (1.01 NAUT.) MI./GAL.)				PRESS		MAXIMUM AIR RANGE													
R.P.M.		M.P. INCHES		MIX-TURE		APPROX.		ALT. FEET		R.P.M.		M.P. INCHES		MIX-TURE		APPROX.		ALT. FEET		R.P.M.		M.P. INCHES		MIX-TURE		APPROX.		ALT. FEET						
						TOT. T.A.S.										TOT. T.A.S.										TOT. T.A.S.								
						GPH MPH KTS.										GPH MPH KTS.										GPH MPH KTS.								
								40000										40000								40000								
								35000										35000								35000								
								30000										30000								30000								
								25000										25000								25000								
								20000										20000								20000								
								15000										15000								15000								
2400		F.T. A.R.		368 278				2200		F.T. A.R.		298 261				2050		F.T. A.R.		234 236						2100		33.0 A.L.		198 236				
2400		F.T. A.R.		330 265				2300		F.T. A.R.		294 259				2150		F.T. A.R.		244 246						2100		33.0 A.L.		198 236				
2400		42.0 A.R.		398 269				2050		39.5 A.R.		286 252				1900		F.T. A.R.		234 238						1800		F.T. A.R.		190 221				
2400		42.0 A.R.		368 254				2150		39.5 A.R.		278 241				1900		40.0 A.R.		224 229						1700		F.T. A.R.		186 216				
								10000																				10000						
								5000																				5000						
								S.L.																				S.L.						

RESTRICTED

Revised 30 April 1945

**SPECIAL NOTES**  
(1) MAKE ALLOWANCE FOR WARM-UP, TAKE-OFF & CLIMB (SEE FIG. 82) PLUS ALLOWANCE FOR WIND, RESERVE AND COMBAT AS REQUIRED.  
**USE HIGH BLOWER ABOVE HEAVY LINE.**

**EXAMPLE**  
AT 39000 LB. GROSS WEIGHT WITH 1400 GAL. OF FUEL (AFTER DEDUCTING TOTAL ALLOWANCES OF 60 GAL.) TO FLY 2000 STAT. AIRMILES AT 5000 FT. ALTITUDE MAINTAIN 1850 RPM AND 33 IN. MANIFOLD PRESSURE WITH MIXTURE SET: **A.L.**

**LEGEND**  
ALT. : PRESSURE ALTITUDE      F.R. : FULL RICH  
M.P. : MANIFOLD PRESSURE    A.R. : AUTO-RICH  
GPH : U.S. GAL. PER HOUR    A.L. : AUTO-LEAN  
TAS : TRUE AIRSPEED        C.L. : CRUISING LEAN  
KTS. : KNOTS                M.L. : MANUAL LEAN  
S.L. : SEA LEVEL            F.T. : FULL THROTTLE

DATA AS OF 12-15-44      BASED ON: FLIGHT TEST

Figure 83 (Sheet 1 of 5 Sheets) — Flight Operation Instruction Chart—Two Engine

AIRCRAFT MODEL (S) B-26B-1, B-26C R-2800-41 ENGINE (S): R-2800-43										<b>FLIGHT OPERATION INSTRUCTION CHART</b>										EXTERNAL LOAD ITEMS NONE					
LIMITS										CHART WEIGHT LIMITS: 36000 TO 33000 POUNDS										NUMBER OF ENGINES OPERATING: TWO (2)					
WAR EMERG.										INSTRUCTIONS FOR USING CHART: SELECT FIGURE IN FUEL COLUMN EQUAL TO OR LESS THAN AMOUNT OF FUEL TO BE USED FOR CRUISING <sup>(1)</sup> MOVE HORIZONTALLY TO RIGHT OR LEFT AND SELECT RANGE VALUE EQUAL TO OR GREATER THAN THE STATUTE OR NAUTICAL AIR MILES TO BE FLOWN. VERTICALLY BELOW AND OPPOSITE VALUE NEAREST DESIRED CRUISING ALTITUDE (ALT.) READ RPM, MANIFOLD PRESSURE (M.P.) AND MIXTURE SETTING REQUIRED.										NOTES: COLUMN I IS FOR EMERGENCY HIGH SPEED CRUISING ONLY. COLUMNS II, III, IV AND V GIVE PROGRESSIVE INCREASE IN RANGE AT A SACRIFICE IN SPEED. AIR MILES PER GALLON (MI./GAL.) (NO WIND), GALLONS PER HR. (G.P.H.) AND TRUE AIRSPEED (T.A.S.) ARE APPROXIMATE VALUES FOR REFERENCE. RANGE VALUES ARE FOR AN AVERAGE AIRPLANE FLYING ALONE (NO WIND) <sup>(2)</sup> TO OBTAIN BRITISH IMPERIAL GAL. (OR G.P.H.): MULTIPLY U.S. GAL. (OR G.P.H.) BY 10 THEN DIVIDE BY 12.					
MILITARY POWER 2700 52 LOW A.R. 5 Min 260C 540										FOR DETAILS SEE POWER PLANT CHART (FIG. 66 SECT. 111)															
COLUMN I		FUEL		COLUMN II				COLUMN III				COLUMN IV				FUEL		COLUMN V							
RANGE IN AIRMILES		U.S.		RANGE IN AIRMILES				RANGE IN AIRMILES				RANGE IN AIRMILES				U.S.		RANGE IN AIRMILES							
STAUTE NAUTICAL		GAL.		STATUTE NAUTICAL		STATUTE NAUTICAL		STATUTE NAUTICAL		STATUTE NAUTICAL		STATUTE NAUTICAL		GAL.		STATUTE NAUTICAL									
		1992		SUBTRACT FUEL ALLOWANCES NOT AVAILABLE FOR CRUISING <sup>(3)</sup>												1992									
1485	1290	1932	1915	1665	2330	2025	2755	2395	1932	3175	2760				1932	3175	2760								
1380	1200	1800	1775	1540	2160	1880	2545	2210	1932	2935	2550				1932	2935	2550								
1305	1135	1700	1670	1450	2030	1765	2385	2070	1700	2745	2385				1700	2745	2385								
1225	1065	1600	1565	1360	1895	1645	2225	1930	1600	2565	2230				1600	2565	2230								
1135	985	1500	1460	1270	1760	1530	2070	1800	1500	2375	2060				1500	2375	2060								
1060	920	1400	1355	1180	1640	1425	1920	1670	1400	2200	1910				1400	2200	1910								
990	860	1300	1255	1090	1515	1320	1770	1540	1300	2025	1760				1300	2025	1760								
910	790	1200	1150	1000	1390	1210	1620	1410	1200	1855	1610				1200	1855	1610								
830	720	1100	1050	910	1265	1100	1475	1280	1100	1680	1460				1100	1680	1460								
755	655	1000	950	825	1135	985	1325	1150	1000	1505	1310				1000	1505	1310								
680	590	900	855	740	1020	885	1185	1030	900	1345	1170				900	1345	1170								
605	525	800	755	655	900	780	1050	910	800	1190	1030				800	1190	1030								
MAXIMUM CONTINUOUS				PRESS (.92 STAT. (.80 NAUT.) MI./GAL.)				PRESS (1.10 STAT. (.95 NAUT.) MI./GAL.)				PRESS (1.27 STAT. (1.10 NAUT.) MI./GAL.)				PRESS				MAXIMUM AIR RANGE					
R.P.M.	M.P. INCHES	MIX-TURE	APPROX.			ALT. FEET	R.P.M.	M.P. INCHES	MIX-TURE	APPROX.			R.P.M.	M.P. INCHES	MIX-TURE	APPROX.			R.P.M.	M.P. INCHES	MIX-TURE	APPROX.			
			TOT. GPH	T.A.S. MPH	T.A.S. KTS.					TOT. GPH	T.A.S. MPH	T.A.S. KTS.				TOT. GPH	T.A.S. MPH	T.A.S. KTS.				TOT. GPH	T.A.S. MPH	T.A.S. KTS.	
						40000																			
						35000																			
						30000																			
2400	F.T.	A.R.	274	257		25000																			
2400	F.T.	A.R.	368	285		20000	2200	F.T.	A.R.	292	270	2150	F.T.	A.L.	202	218									
						15000	2050	F.T.	A.L.	224	247	2050	F.T.	A.L.	224	247	2150	F.T.	A.R.	178	226				
2400	F.T.	A.R.	330	271		10000	2250	F.T.	A.R.	282	263	2100	F.T.	A.R.	228	249									
2400	42.0	A.R.	398	273		5000	2000	F.T.	A.R.	274	254	1900	F.T.	A.R.	216	239									
2400	42.0	A.R.	368	257		S.L.	2100	39.7	A.R.	266	243	1850	40.6	A.R.	208	230									
<b>SPECIAL NOTES</b>										<b>EXAMPLE</b>										<b>LEGEND</b>					
(1) MAKE ALLOWANCE FOR WARM-UP, TAKE-OFF & CLIMB (SEE FIG. 82) PLUS ALLOWANCE FOR WIND, RESERVE AND COMBAT AS REQUIRED.										AT 36000 LB. GROSS WEIGHT WITH 1600 GAL. OF FUEL (AFTER DEDUCTING TOTAL ALLOWANCES OF 60 GAL.) TO FLY 2225 STAT. AIRMILES AT 5000 FT. ALTITUDE MAINTAIN 2050 RPM AND F.T. MANIFOLD PRESSURE WITH MIXTURE SET: <b>A.L.</b>										ALT. : PRESSURE ALTITUDE M.P. : MANIFOLD PRESSURE GPH : U.S. GAL. PER HOUR TAS : TRUE AIRSPEED KTS. : KNOTS S.L. : SEA LEVEL F.R. : FULL RICH A.R. : AUTO-RICH A.L. : AUTO-LEAN C.L. : CRUISING LEAN M.L. : MANUAL LEAN F.T. : FULL THROTTLE					
USE HIGH BLOWER ABOVE HEAVY LINE.																									
DATA AS OF 12-15-44										BASED ON: FLIGHT TEST															

Figure 83 (Sheet 2 of 5 Sheets) — Flight Operation Instruction Chart—Two Engine

AIRFC-528 A-1-44		AIRCRAFT MODEL(S) B-26B-1, AND B-26C							<b>FLIGHT OPERATION INSTRUCTION CHART</b>								EXTERNAL LOAD ITEMS NONE																																				
		ENGINE(S): R-2800-41 R-2800-43							CHART WEIGHT LIMITS: 33000 TO 30000 POUNDS								NUMBER OF ENGINES OPERATING: TWO (2)																																				
<b>LIMITS</b>		RPM	M.P. IN. HG.	BLOWER POSITION	MIXTURE POSITION	TIME LIMIT	CYL. TEMP.	TOTAL G.P.H.	INSTRUCTIONS FOR USING CHART: SELECT FIGURE IN FUEL COLUMN EQUAL TO OR LESS THAN AMOUNT OF FUEL TO BE USED FOR CRUISING <sup>(1)</sup> MOVE HORIZONTALLY TO RIGHT OR LEFT AND SELECT RANGE VALUE EQUAL TO OR GREATER THAN THE STATUTE OR NAUTICAL AIR MILES TO BE FLOWN. VERTICALLY BELOW AND OPPOSITE VALUE NEAREST DESIRED CRUISING ALTITUDE (ALT.) READ RPM, MANIFOLD PRESSURE (M.P.) AND MIXTURE SETTING REQUIRED.								NOTES: COLUMN I IS FOR EMERGENCY HIGH SPEED CRUISING ONLY. COLUMNS II, III, IV AND V GIVE PROGRESSIVE INCREASE IN RANGE AT A SACRIFICE IN SPEED. AIR MILES PER GALLON (MI./GAL.) (NO WIND), GALLONS PER HR. (G.P.H.) AND TRUE AIRSPEED (T.A.S.) ARE APPROXIMATE VALUES FOR REFERENCE. RANGE VALUES ARE FOR AN AVERAGE AIRPLANE FLYING ALONE (NO WIND) <sup>(2)</sup> TO OBTAIN BRITISH IMPERIAL GAL. (OR G.P.H.): MULTIPLY U.S. GAL. (OR G.P.H.) BY 10 THEN DIVIDE BY 12.																																				
<b>WAR EMERG.</b>																																																					
<b>MILITARY POWER</b>		2700	52	LOW	A.R.	5 Min	260°	540																																													
		FOR DETAILS SEE POWER PLANT CHART (FIG. 66 SECT. 111)																																																			
<b>COLUMN I</b>		<b>FUEL</b>			<b>COLUMN II</b>				<b>COLUMN III</b>				<b>COLUMN IV</b>				<b>FUEL</b>			<b>COLUMN V</b>																																	
RANGE IN AIRMILES		U.S. GAL.			RANGE IN AIRMILES				RANGE IN AIRMILES				RANGE IN AIRMILES				U.S. GAL.			RANGE IN AIRMILES																																	
STATUTE NAUTICAL		GAL.			STATUTE		NAUTICAL		STATUTE		NAUTICAL		STATUTE		NAUTICAL		GAL.			STATUTE		NAUTICAL																															
1110 1010 930		965 880 810			1432 1300 1200		1455 1315 1205		SUBTRACT FUEL ALLOWANCES NOT AVAILABLE FOR CRUISING <sup>(1)</sup> 1265 1785 1550 2130 1140 1610 1400 1915 1050 1470 1280 1755				1850 1665 1525		1432 1300 1200			2470 2220 2030		2145 1930 1760																																	
850 770 690		740 670 600			1100 1000 900		1100 995 890		955 865 775		1340 1210 1085		1165 1050 945		1595 1435 1285		1385 1250 1120			1100 1000 900		1850 1660 1485		1610 1440 1290																													
615 535 455		535 465 395			800 700 600		790 690 585		685 600 510		960 835 710		835 725 615		1135 990 840		985 860 730			800 700 600		1310 1135 965		1140 985 840																													
380 305 230		330 265 200			500 400 300		485 390 290		420 340 250		585 470 350		510 410 305		690 550 415		600 480 360			500 400 300		790 630 475		685 550 415																													
MAXIMUM CONTINUOUS						PRESS		(.97 STAT. (.84 NAUT.) MI./GAL.)				(1.18 STAT. (1.03 NAUT.) MI./GAL.)				(1.38 STAT. (1.20 NAUT.) MI./GAL.)				PRESS		MAXIMUM AIR RANGE																															
R.P.M.		M.P. INCHES		MIX-TURE		APPROX.						R.P.M.		M.P. INCHES		MIX-TURE		APPROX.						R.P.M.		M.P. INCHES		MIX-TURE		APPROX.																							
TOT. GPH.		T.A.S. MPH.		KTS.		ALT. FEET		R.P.M.		M.P. INCHES		MIX-TURE		APPROX.						ALT. FEET		R.P.M.		M.P. INCHES		MIX-TURE		APPROX.																									
2400		F.T.		A.R.		274 271		25000		2150		F.T.		A.R.		208 249		35000		2200		F.T.		A.R.		210 253		30000		2100		F.T.		A.L.		166 239		25000		1900		26.0		A.L.		132 206							
2400		F.T.		A.R.		368 291		20000		2250		F.T.		A.R.		210 253		35000		2250		F.T.		A.R.		210 253		30000		2100		F.T.		A.L.		166 239		25000		1900		26.0		A.L.		132 206							
2400		F.T.		A.R.		330 275		10000		2050		F.T.		A.R.		212 250		5000		2050		F.T.		A.R.		202 238		1850		F.T.		A.R.		202 238		1900		33.0		A.L.		174 240		10000		1700		29.5		A.L.		124 197	
2400		42.0		A.R.		398 276		5000		1850		F.T.		A.R.		202 238		S.L.		1850		F.T.		A.R.		190 229		1700		41.0		A.R.		190 229		1950		33.0		A.L.		152 211		10000		1600		31.5		A.L.		114 183	
2400		42.0		A.R.		368 260		S.L.		2050		F.T.		A.R.		256 244		S.L.		2050		F.T.		A.R.		256 244		1700		41.0		A.R.		190 229		1950		33.0		A.L.		152 211		10000		1600		31.5		A.L.		112 175	

**SPECIAL NOTES**

(1) MAKE ALLOWANCE FOR WARM-UP, TAKE-OFF & CLIMB (SEE FIG. 82) PLUS ALLOWANCE FOR WIND, RESERVE AND COMBAT AS REQUIRED.

USE HIGH BLOWER ABOVE HEAVY LINE.

**EXAMPLE**

AT 33000 LB. GROSS WEIGHT WITH 900 GAL. OF FUEL (AFTER DEDUCTING TOTAL ALLOWANCES OF 60 GAL.) TO FLY 1485 STAT. AIRMILES AT 5000 FT. ALTITUDE MAINTAIN 1600 RPM AND 31.5 IN. MANIFOLD PRESSURE WITH MIXTURE SET: A.L.

**LEGEND**

ALT. : PRESSURE ALTITUDE  
M.P. : MANIFOLD PRESSURE  
GPH : U.S. GAL. PER HOUR  
TAS : TRUE AIRSPEED  
KTS. : KNOTS  
S.L. : SEA LEVEL

F.R. : FULL RICH  
A.R. : AUTO-RICH  
A.L. : AUTO-LEAN  
C.L. : CRUISING LEAN  
M.L. : MANUAL LEAN  
F.T. : FULL THROTTLE

DATA AS OF 12-15-44      BASED ON: FLIGHT TEST

RESTRICTED

RESTRICTED AN 01-35B-1

Revised 30 April 1945

Figure 83 (Sheet 3 of 5 Sheets) — Flight Operation Instruction Chart—Two Engine



LIMITS		RPM	M.P. IN. HG.	BLOWER POSITION	MIXTURE POSITION	TIME LIMIT	CYL. TEMP.	TOTAL G.P.H.	AIRCRAFT MODEL(S) B-26B-1, B-26C R-2800-41 ENGINE(S): R-2800-43		FLIGHT OPERATION INSTRUCTION CHART				EXTERNAL LOAD ITEMS NONE																				
WAR EMERG.									CHART WEIGHT LIMITS: 30000 TO 27000 POUNDS		INSTRUCTIONS FOR USING CHART: SELECT FIGURE IN FUEL COLUMN EQUAL TO OR LESS THAN AMOUNT OF FUEL TO BE USED FOR CRUISING <sup>(1)</sup> MOVE HORIZONTALLY TO RIGHT OR LEFT AND SELECT RANGE VALUE EQUAL TO OR GREATER THAN THE STATUTE OR NAUTICAL AIR MILES TO BE FLOWN. VERTICALLY BELOW AND OPPOSITE VALUE NEAREST DESIRED CRUISING ALTITUDE (ALT.) READ RPM, MANIFOLD PRESSURE (M.P.) AND MIXTURE SETTING REQUIRED.				NUMBER OF ENGINES OPERATING: TWO (2)																				
MILITARY POWER		2700	52	LOW	A.R.	5 Min	260°	540	FOR DETAILS SEE POWER PLANT CHART (FIG. 66 SECT. III)		NOTES: COLUMN I IS FOR EMERGENCY HIGH SPEED CRUISING ONLY. COLUMNS II, III, IV AND V GIVE PROGRESSIVE INCREASE IN RANGE AT A SACRIFICE IN SPEED. AIR MILES PER GALLON (MI./GAL.) (NO WIND), GALLONS PER HR. (G.P.H.) AND TRUE AIRSPEED (T.A.S.) ARE APPROXIMATE VALUES FOR REFERENCE. RANGE VALUES ARE FOR AN AVERAGE AIRPLANE FLYING ALONE (NO WIND) <sup>(1)</sup> TO OBTAIN BRITISH IMPERIAL GAL. (OR G.P.H.): MULTIPLY U.S. GAL. (OR G.P.H.) BY 10 THEN DIVIDE BY 12.																								
COLUMN I		FUEL		COLUMN II		COLUMN III		COLUMN IV		FUEL		COLUMN V																							
RANGE IN AIRMILES		U.S.		RANGE IN AIRMILES		RANGE IN AIRMILES		RANGE IN AIRMILES		U.S.		RANGE IN AIRMILES																							
STAUTE	NAUTICAL	GAL.		STAUTE	NAUTICAL	STAUTE	NAUTICAL	STAUTE	NAUTICAL	STAUTE	NAUTICAL	STAUTE	NAUTICAL																						
860	750	1100		1150	1000	1425	1240	1705	1480	1100	1990	1730																							
780	680	1000		1040	905	1285	1120	1545	1345	1000	1800	1565																							
705	610	900		940	815	1175	1020	1385	1205	900	1620	1410																							
630	550	800		830	720	1025	890	1225	1065	800	1430	1240																							
550	480	700		720	625	885	770	1065	1010	700	1240	1080																							
470	410	600		615	535	755	655	905	785	600	1060	920																							
390	340	500		510	445	625	545	745	650	500	870	755																							
310	270	400		405	350	500	435	595	515	400	695	605																							
235	205	300		305	265	375	325	445	385	300	520	450																							
155	135	200		205	180	250	220	300	260	200	345	300																							
75	65	100		100	85	125	110	150	130	100	175	150																							
MAXIMUM CONTINUOUS				PRESS		(1.02 STAT. (.89 NAUT.) MI./GAL.)				(1.25 STAT. (1.09 NAUT.) MI./GAL.)				(1.49 STAT. (1.29 NAUT.) MI./GAL.)				PRESS		MAXIMUM AIR RANGE															
R.P.M.	M.P. INCHES	MIX- TURE	APPROX.			ALT. FEET	R.P.M.	M.P. INCHES	MIX- TURE	APPROX.			R.P.M.	M.P. INCHES	MIX- TURE	APPROX.			ALT. FEET	R.P.M.	M.P. INCHES	MIX- TURE	APPROX.												
			TOT.	T.A.S.						TOT.	T.A.S.					TOT.	T.A.S.						TOT.	T.A.S.											
			GPH	MPH	KTS.				GPH	MPH	KTS.				GPH	MPH	KTS.					GPH	MPH	KTS.											
						40000												40000																	
						35000												35000																	
						30000												30000																	
2400	F.T.	A.R.	202	250	25000				2400	F.T.	A.R.	198	247	25000				2400	F.T.	A.R.	156	235	25000												
2400	F.T.	A.R.	274	280	20000				2200	F.T.	A.R.	208	261	20000				2100	F.T.	A.L.	166	249	20000												
2400	F.T.	A.R.	368	296	15000	2150	F.T.	A.R.	278	278	2250	F.T.	A.R.	206	259	15000	2100	F.T.	A.L.	156	249	15000	2100	F.T.	A.L.	118	205								
2400	F.T.	A.R.	330	279	10000	2200	F.T.	A.R.	260	268	2100	33.0	A.L.	196	256	10000	1900	F.T.	A.L.	158	240	10000	1600	F.T.	A.L.	110	191								
2400	42.0	A.R.	398	279	5000	1950	F.T.	A.R.	256	258	2100	33.0	A.L.	182	240	5000	1800	33.0	A.L.	152	225	5000	1600	29.0	A.L.	102	179								
2400	42.0	A.R.	368	263	S.L.	2000	40.0	A.R.	246	246	1650	F.T.	A.R.	180	230	S.L.	1600	37.5	A.R.	142	212	1600	30.5	A.L.	100	172									
SPECIAL NOTES												EXAMPLE												LEGEND											
(1) MAKE ALLOWANCE FOR WARM-UP, TAKE-OFF & CLIMB (SEE FIG. 82) PLUS ALLOWANCE FOR WIND, RESERVE AND COMBAT AS REQUIRED. USE HIGH BLOWER ABOVE HEAVY LINE.												AT 30000 LB. GROSS WEIGHT WITH 700 GAL. OF FUEL (AFTER DEDUCTING TOTAL ALLOWANCES OF 60 GAL.) TO FLY 885 STAT. AIRMILES AT 5000 FT. ALTITUDE MAINTAIN 2100 RPM AND F.T. MANIFOLD PRESSURE WITH MIXTURE SET: A.L.												ALT. : PRESSURE ALTITUDE F.R. : FULL RICH M.P. : MANIFOLD PRESSURE A.R. : AUTO-RICH GPH : U.S. GAL. PER HOUR A.L. : AUTO-LEAN TAS : TRUE AIRSPEED C.L. : CRUISING LEAN KTS. : KNOTS M.L. : MANUAL LEAN S.L. : SEA LEVEL F.T. : FULL THROTTLE											
DATA AS OF 12-15-44												BASED ON: FLIGHT TEST																							

Figure 83 (Sheet 4 of 5 Sheets) — Flight Operation Instruction Chart—Two Engine

AIRCRAFT MODEL(S) B-26B-1, B-26C R-2800-41 R-2800-43	FLIGHT OPERATION INSTRUCTION CHART										EXTERNAL LOAD ITEMS NONE													
ENGINE(S):	CHART WEIGHT LIMITS: 27000 TO 23400 POUNDS										NUMBER OF ENGINES OPERATING: TWO (2)													
LIMITS	RPM	M.P. IN. HG.	BLOWER POSITION	MIXTURE POSITION	TIME LIMIT	CYL. TEMP.	TOTAL G.P.H.	INSTRUCTIONS FOR USING CHART: SELECT FIGURE IN FUEL COLUMN EQUAL TO OR LESS THAN AMOUNT OF FUEL TO BE USED FOR CRUISING. MOVE HORIZONTALLY TO RIGHT OR LEFT AND SELECT RANGE VALUE EQUAL TO OR GREATER THAN THE STATUTE OR NAUTICAL AIR MILES TO BE FLOWN. VERTICALLY BELOW AND OPPOSITE VALUE NEAREST DESIRED CRUISING ALTITUDE (ALT.) READ RPM, MANIFOLD PRESSURE (M.P.) AND MIXTURE SETTING REQUIRED.				NOTES: COLUMN I IS FOR EMERGENCY HIGH SPEED CRUISING ONLY. COLUMNS II, III, IV AND V GIVE PROGRESSIVE INCREASE IN RANGE AT A SACRIFICE IN SPEED. AIR MILES PER GALLON (MI./GAL.) (NO WIND), GALLONS PER HR. (G.P.H.) AND TRUE AIRSPEED (T.A.S.) ARE APPROXIMATE VALUES FOR REFERENCE. RANGE VALUES ARE FOR AN AVERAGE AIRPLANE FLYING ALONE (NO WIND). TO OBTAIN BRITISH IMPERIAL GAL (OR G.P.H.): MULTIPLY U.S. GAL (OR G.P.H.) BY 10 THEN DIVIDE BY 12.												
WAR EMERG.																								
MILITARY POWER	2700	52	LOW	A.R.	5 Min	260C	540																	
COLUMN I		FUEL		COLUMN II		COLUMN III		COLUMN IV		FUEL		COLUMN V												
RANGE IN AIRMILES		U.S. GAL.		RANGE IN AIRMILES		RANGE IN AIRMILES		RANGE IN AIRMILES		U.S. GAL.		RANGE IN AIRMILES												
STATUTE NAUTICAL		GAL.		STATUTE NAUTICAL		STATUTE NAUTICAL		STATUTE NAUTICAL		GAL.		STATUTE NAUTICAL												
SUBTRACT FUEL ALLOWANCES NOT AVAILABLE FOR CRUISING (1)																								
470																								
390																								
315																								
240																								
160																								
80																								
470	410	600	640	555	800	695	960	835	600	1120	970													
390	340	500	530	460	660	570	800	695	500	930	810													
315	275	400	430	370	550	480	640	555	400	750	650													
240	210	300	320	280	400	350	480	415	300	560	485													
160	140	200	210	180	260	225	320	280	200	370	320													
80	70	100	105	90	130	115	160	140	100	190	165													
MAXIMUM CONTINUOUS					(1.06 STAT. (.92 NAUT.) MI./GAL.)					(1.33 STAT. (1.16 NAUT.) MI./GAL.)					(1.60 STAT. (1.39 NAUT.) MI./GAL.)									
PRESS ALT. FEET					PRESS ALT. FEET					PRESS ALT. FEET					PRESS ALT. FEET									
R.P.M.	M.P. INCHES	MIX-TURE	APPROX. T.A.S. GPH MPH KTS.		R.P.M.	M.P. INCHES	MIX-TURE	APPROX. T.A.S. GPH MPH KTS.		R.P.M.	M.P. INCHES	MIX-TURE	APPROX. T.A.S. GPH MPH KTS.		R.P.M.	M.P. INCHES	MIX-TURE	APPROX. T.A.S. GPH MPH KTS.						
2400	F.T.	A.R.	202	265	2400	F.T.	A.R.	274	287	2400	F.T.	A.R.	198	263	2400	F.T.	A.R.	150	238					
2400	F.T.	A.R.	274	287	2150	F.T.	A.R.	202	266	2200	F.T.	A.R.	154	246	20000	1950	F.T.	A.L.	114	209				
2400	F.T.	A.R.	368	300	2200	F.T.	A.R.	198	263	2100	F.T.	A.L.	158	252	15000	1700	F.T.	A.L.	102	196				
2400	F.T.	A.R.	330	283	2050	33.0	A.L.	194	260	1850	F.T.	A.L.	146	239	10000	1600	26.5	A.L.	100	190				
2400	42.0	A.R.	398	282	1950	F.T.	A.R.	242	258	1700	33.0	A.L.	138	223	5000	1600	27.5	A.L.	98	181				
2400	42.0	A.R.	368	265	1650	F.T.	A.R.	172	230	1800	33.0	A.L.	132	211	S.L.	1600	29.0	A.L.	94	172				

**SPECIAL NOTES**

(1). MAKE ALLOWANCE FOR WARM-UP, TAKE-OFF & CLIMB (SEE FIG. 82) PLUS ALLOWANCE FOR WIND, RESERVE AND COMBAT AS REQUIRED.  
USE HIGH BLOWER ABOVE HEAVY LINE.

**EXAMPLE**

AT 27000 LB. GROSS WEIGHT WITH 500 GAL. OF FUEL (AFTER DEDUCTING TOTAL ALLOWANCES OF 60 GAL.) TO FLY 530 STAT. AIRMILES AT 5000 FT. ALTITUDE MAINTAIN 1950 RPM AND (F.T.) MANIFOLD PRESSURE WITH MIXTURE SET: A.R.

**LEGEND**

- ALT. : PRESSURE ALTITUDE
- M.P. : MANIFOLD PRESSURE
- GPH : U.S. GAL. PER HOUR
- TAS : TRUE AIRSPEED
- KTS. : KNOTS
- S.L. : SEA LEVEL
- F.R. : FULL RICH
- A.R. : AUTO-RICH
- A.L. : AUTO-LEAN
- C.L. : CRUISING LEAN
- M.L. : MANUAL LEAN
- F.T. : FULL THROTTLE

DATA AS OF 12-15-44 BASED ON: FLIGHT TEST

Figure 83 (Sheet 5 of 5 Sheets) — Flight Operation Instruction Chart—Two Engine

LIMITS		RPM	M.P. IN. HG.	BLOWER POSITION	MIXTURE POSITION	TIME LIMIT	CYL. TEMP.	TOTAL G.P.H.	AIRCRAFT MODEL(S) B-26B-1, B-26C		FLIGHT OPERATION INSTRUCTION CHART				EXTERNAL LOAD ITEMS NONE																				
WAR EMERG.									ENGINE(S): R-2800-41 AND R-2800-43				CHART WEIGHT LIMITS: 33000 TO 30000 POUNDS				NUMBER OF ENGINES OPERATING: ONE (1)																		
MILITARY POWER		2700	52	LOW	A.R.	5 Min	260°C	270	FOR DETAILS SEE POWER PLANT CHART (FIG. 66 SEC. 111)				INSTRUCTIONS FOR USING CHART: SELECT FIGURE IN FUEL COLUMN EQUAL TO OR LESS THAN AMOUNT OF FUEL TO BE USED FOR CRUISING <sup>(1)</sup> MOVE HORIZONTALLY TO RIGHT OR LEFT AND SELECT RANGE VALUE EQUAL TO OR GREATER THAN THE STATUTE OR NAUTICAL AIR MILES TO BE FLOWN. VERTICALLY BELOW AND OPPOSITE VALUE NEAREST DESIRED CRUISING ALTITUDE (ALT.) READ RPM, MANIFOLD PRESSURE (M.P.) AND MIXTURE SETTING REQUIRED.				NOTES: COLUMN I IS FOR EMERGENCY HIGH SPEED CRUISING ONLY. COLUMNS II, III, IV AND V GIVE PROGRESSIVE INCREASE IN RANGE AT A SACRIFICE IN SPEED. AIR MILES PER GALLON (MI./GAL.) (NO WIND), GALLONS PER HR. (G.P.H.) AND TRUE AIRSPEED (T.A.S.) ARE APPROXIMATE VALUES FOR REFERENCE. RANGE VALUES ARE FOR AN AVERAGE AIRPLANE FLYING ALONE (NO WIND) <sup>(1)</sup> TO OBTAIN BRITISH IMPERIAL GAL. (OR G.P.H.): MULTIPLY U.S. GAL. (OR G.P.H.) BY 10 THEN DIVIDE BY 12.																		
MILITARY POWER		2700	52	LOW	A.R.	5 Min	260°C	270													COLUMN I				COLUMN II		COLUMN III		COLUMN IV		COLUMN V				
RANGE IN AIRMILES		U.S. GAL.		RANGE IN AIRMILES		RANGE IN AIRMILES		RANGE IN AIRMILES		U.S. GAL.		RANGE IN AIRMILES		STATUTE		NAUTICAL		RANGE IN AIRMILES		STATUTE		NAUTICAL													
STATUTE		NAUTICAL		STATUTE		NAUTICAL		STATUTE		NAUTICAL		STATUTE		NAUTICAL		STATUTE		NAUTICAL		STATUTE		NAUTICAL													
1400		1220		1432		SUBTRACT FUEL ALLOWANCES NOT AVAILABLE FOR CRUISING <sup>(1)</sup>																													
1260		1090		1300																															
1150		1000		1200																															
1050		910		1100																															
940		815		1000																															
840		730		900																															
740		640		800																															
650		565		700																															
550		480		600																															
450		390		500																															
360		310		400																															
270		230		300																															
MAXIMUM CONTINUOUS				PRESS		STAT. ( NAUT.) MI./GAL.)		STAT. ( NAUT.) MI./GAL.)		STAT. ( NAUT.) MI./GAL.)		PRESS		MAXIMUM AIR RANGE																					
R.P.M.	M.P. INCHES	MIX-TURE	APPROX.			ALT. FEET	R.P.M.	M.P. INCHES	MIX-TURE	APPROX.			R.P.M.	M.P. INCHES	MIX-TURE	APPROX.			R.P.M.	M.P. INCHES	MIX-TURE	APPROX.													
			TOT. GPH.	T.A.S. MPH.	T.A.S. KTS.					TOT. GPH.	T.A.S. MPH.	T.A.S. KTS.				TOT. GPH.	T.A.S. MPH.	T.A.S. KTS.				TOT. GPH.	T.A.S. MPH.	T.A.S. KTS.											
					40000																														
					35000																														
					30000																														
					25000																														
					20000																														
					15000																														
					10000																														
2400	42	A.R.	199	167	5000																														
2400	42	A.R.	184	164	S. L.																														
SPECIAL NOTES												EXAMPLE												LEGEND											
(1) PLUS ALLOWANCE FOR WIND, RESERVE AND COMBAT AS REQUIRED.												AT 33000 LB. GROSS WEIGHT WITH 1000 GAL. OF FUEL												ALT. : PRESSURE ALTITUDE											
USE LOW BLOWER.												TO FLY 940 STAT. AIRMILES AT 5000 FT. ALTITUDE												F.R. : FULL RICH											
												MAINTAIN 2400 RPM AND 42 IN. MANIFOLD PRESSURE												M.P. : MANIFOLD PRESSURE											
												WITH MIXTURE SET: A.R.												A.R. : AUTO-RICH											
																								G.P.H. : U.S. GAL. PER HOUR											
																								T.A.S. : TRUE AIRSPEED											
																								KTS. : KNOTS											
																								M.L. : MANJAL LEAN											
																								S.L. : SEA LEVEL											
																								F.T. : FULL THROTTLE											
DATA AS OF 12-15-44												BASED ON: FLIGHT TEST																							

Figure 84 (Sheet 1 of 3 Sheets) — Flight Operation Instruction Chart—Single Engine

LIMITS		RPM	M.P. IN. HG.	BLOWER POSITION	MIXTURE POSITION	TIME LIMIT	CYL. TEMP.	TOTAL G.P.H.	FOR DETAILS SEE POWER PLANT CHART (FIG. 66 SECT. III)	INSTRUCTIONS FOR USING CHART: SELECT FIGURE IN FUEL COLUMN EQUAL TO OR LESS THAN AMOUNT OF FUEL TO BE USED FOR CRUISING. MOVE HORIZONTALLY TO RIGHT OR LEFT AND SELECT RANGE VALUE EQUAL TO OR GREATER THAN THE STATUTE OR NAUTICAL AIR MILES TO BE FLOWN. VERTICALLY BELOW AND OPPOSITE VALUE NEAREST DESIRED CRUISING ALTITUDE (ALT.) READ RPM, MANIFOLD PRESSURE (M.P.) AND MIXTURE SETTING REQUIRED.	NOTES: COLUMN I IS FOR EMERGENCY HIGH SPEED CRUISING ONLY. COLUMNS II, III, IV AND V GIVE PROGRESSIVE INCREASE IN RANGE AT A SACRIFICE IN SPEED. AIR MILES PER GALLON (MI./GAL.) (NO WIND), GALLONS PER HR. (G.P.H.) AND TRUE AIRSPEED (T.A.S.) ARE APPROXIMATE VALUES FOR REFERENCE. RANGE VALUES ARE FOR AN AVERAGE AIRPLANE FLYING ALONE (NO WIND). TO OBTAIN BRITISH IMPERIAL GAL. (OR G.P.H.): MULTIPLY U.S. GAL. (OR G.P.H.) BY 10 THEN DIVIDE BY 12.									
WAR EMERG.																				
MILITARY POWER	2700	52	LOW	A.R.	5 Min	260°C	270													
AIRCRAFT MODEL(S) B-26B-1, AND B-26C		FLIGHT OPERATION INSTRUCTION CHART							EXTERNAL LOAD ITEMS NONE											
ENGINE(S): R-2800-41 AND R-2800-43		CHART WEIGHT LIMITS: 30000 TO 27000 POUNDS							NUMBER OF ENGINES OPERATING: ONE (1)											
COLUMN I		FUEL			COLUMN II		COLUMN III		COLUMN IV		FUEL			COLUMN V						
RANGE IN AIRMILES		U.S.			RANGE IN AIRMILES		RANGE IN AIRMILES		RANGE IN AIRMILES		U.S.			RANGE IN AIRMILES						
STAUTE	NAUTICAL	GAL.			STAUTE	NAUTICAL	STAUTE	NAUTICAL	STAUTE	NAUTICAL	GAL.			STAUTE	NAUTICAL					
1130	980	1100			SUBTRACT FUEL ALLOWANCES NOT AVAILABLE FOR CRUISING <sup>(1)</sup>										1100	1430	1240			
1030	895	1000											1000	1290	1120					
920	800	900											900	1140	990					
810	705	800											800	1000	870					
700	610	700											700	860	745					
600	520	600											600	710	615					
490	425	500											500	570	495					
390	340	400											400	460	400					
290	250	300											300	340	295					
200	170	200											200	230	200					
100	85	100											100	110	95					
MAXIMUM CONTINUOUS					PRESS	( STAT. ( NAUT. ) MI. / GAL. )					PRESS	MAXIMUM AIR RANGE								
R. P. M.	M. P. INCHES	MIX-TURE	APPROX.		ALT. FEET	R. P. M.	M. P. INCHES	MIX-TURE	APPROX.		R. P. M.	M. P. INCHES	MIX-TURE	APPROX.		R. P. M.	M. P. INCHES	MIX-TURE	APPROX.	
			TOT. GPH	T. A. S. MPH KTS.					TOT. GPH	T. A. S. MPH KTS.				TOT. GPH	T. A. S. MPH KTS.				TOT. GPH	T. A. S. MPH KTS.
					40000															
					35000															
					30000															
					25000															
					20000															
					15000															
2400	42	A.R.	165	150	10000															
2400	42	A.R.	199	186	5000															
2400	42	A.R.	184	178	S. L.															
SPECIAL NOTES					EXAMPLE										LEGEND					
(1) PLUS ALLOWANCE FOR WIND, RESERVE AND COMBAT AS REQUIRED. USE LOW BLOWER.					AT 30000 LB. GROSS WEIGHT WITH 900 GAL. OF FUEL TO FLY 1140 STAT. AIRMILES AT 5000 FT. ALTITUDE MAINTAIN 2050 RPM AND F.T. MANIFOLD PRESSURE WITH MIXTURE SET: A.R.										ALT. : PRESSURE ALTITUDE M.P. : MANIFOLD PRESSURE GPH : U.S. GAL. PER HOUR TAS : TRUE AIRSPEED KTS. : KNOTS S.L. : SEA LEVEL F.R. : FULL RICH A.R. : AUTO-RICH A.L. : AUTO-LEAN C.L. : CRUISING LEAN M.L. : MANUAL LEAN F.T. : FULL THROTTLE					
DATA AS OF 12-15-44					BASED ON: FLIGHT TEST															

RESTRICTED

RESTRICTED  
AN 01-358B-1

Revised 30 April 1945

Figure 84 (Sheet 2 of 3 Sheets) — Flight Operation Instruction Chart—Single Engine

AIRCRAFT MODEL(S) B-26B-1, AND B-26C										FLIGHT OPERATION INSTRUCTION CHART										EXTERNAL LOAD ITEMS NONE						
ENGINE(S): R-2800-41 AND R-2800-43										CHART WEIGHT LIMITS: 27000 TO 23400 POUNDS										NUMBER OF ENGINES OPERATING: ONE (1)						
LIMITS	RPM	M.P. IN. HG.	BLOWER POSITION	MIXTURE POSITION	TIME LIMIT	CYL. TEMP.	TOTAL G.P.W.	FOR DETAILS SEE POWER PLANT CHART (FIG. 66 SECT. III)			INSTRUCTIONS FOR USING CHART: SELECT FIGURE IN FUEL COLUMN EQUAL TO OR LESS THAN AMOUNT OF FUEL TO BE USED FOR CRUISING <sup>(1)</sup> MOVE HORIZONTALLY TO RIGHT OR LEFT AND SELECT RANGE VALUE EQUAL TO OR GREATER THAN THE STATUTE OR NAUTICAL AIR MILES TO BE FLOWN. VERTICALLY BELOW AND OPPOSITE VALUE NEAREST DESIRED CRUISING ALTITUDE (ALT.) READ RPM, MANIFOLD PRESSURE (M.P.) AND MIXTURE SETTING REQUIRED.										NOTES: COLUMN I IS FOR EMERGENCY HIGH SPEED CRUISING ONLY. COLUMNS II, III, IV AND V GIVE PROGRESSIVE INCREASE IN RANGE AT A SACRIFICE IN SPEED. AIR MILES PER GALLON (MI./GAL.) (NO WIND), GALLONS PER HR. (G.P.H.) AND TRUE AIRSPEED (T.A.S.) ARE APPROXIMATE VALUES FOR REFERENCE. RANGE VALUES ARE FOR AN AVERAGE AIRPLANE FLYING ALONE (NO WIND) <sup>(1)</sup> TO OBTAIN BRITISH IMPERIAL GAL. (OR G.P.H.): MULTIPLY U.S. GAL. (OR G.P.H.) BY 10 THEN DIVIDE BY 12.					
WAR EMERG.																										
MILITARY POWER	2700	52	LOW	A.R.	5 Min	260°	270																			
COLUMN I			FUEL			COLUMN II			COLUMN III			COLUMN IV			FUEL			COLUMN V								
RANGE IN AIRMILES			U.S.			RANGE IN AIRMILES			RANGE IN AIRMILES			RANGE IN AIRMILES			U.S.			RANGE IN AIRMILES								
STAUTE	NAUTICAL		GAL.	STATUTE	NAUTICAL	STATUTE	NAUTICAL	STATUTE	NAUTICAL	STATUTE	NAUTICAL	STATUTE	NAUTICAL	GAL.	STATUTE	NAUTICAL										
SUBTRACT FUEL ALLOWANCES NOT AVAILABLE FOR CRUISING <sup>(1)</sup>																										
640	555		600											600	860	745										
540	470		500											500	720	625										
430	370		400											400	570	495										
320	280		300											300	430	370										
210	180		200											200	290	250										
110	95		100											100	140	120										
MAXIMUM CONTINUOUS					PRESS		STAT. ( NAUT.) MI./GAL.)			STAT. ( NAUT.) MI./GAL.)			STAT. ( NAUT.) MI./GAL.)			PRESS		MAXIMUM AIR RANGE								
R.P.M.	M.P. INCHES	MIX-TURE	APPROX.		ALT. FEET	R.P.M.	M.P. INCHES	MIX-TURE	APPROX.			R.P.M.	M.P. INCHES	MIX-TURE	APPROX.			ALT. FEET	R.P.M.	M.P. INCHES	MIX-TURE	APPROX.				
TOT.	T.A.S.	TOT.	T.A.S.	TOT.					T.A.S.	TOT.	T.A.S.				TOT.	T.A.S.	TOT.					T.A.S.	TOT.	T.A.S.		
			GPH	KTS.					GPH	MPH	KTS.				GPH	MPH	KTS.					GPH	MPH	KTS.		
					40000													40000								
					35000													35000								
					30000													30000								
					25000													25000								
					20000													20000								
					15000													15000								
2400	F.T.	A.R.	160	183	10000													10000	2200	F.T.	A.R.	127	162			
2400	42	A.R.	198	197	5000													5000	1900	F.T.	A.R.	106	152			
2400	42	A.R.	184	186	S.L.													S.L.	1700	F.T.	A.R.	90	143			

**SPECIAL NOTES**

(1) PLUS ALLOWANCE FOR WIND, RESERVE AND COMBAT AS REQUIRED.  
**USE LOW BLOWER.**

**EXAMPLE**

AT 27000 LB. GROSS WEIGHT WITH 400 GAL. OF FUEL  
TO FLY 570 STAT. AIRMILES AT 5000 FT. ALTITUDE  
MAINTAIN 1900 RPM AND F.T. MANIFOLD PRESSURE  
WITH MIXTURE SET: A.R.

**LEGEND**

- ALT. : PRESSURE ALTITUDE
- M.P. : MANIFOLD PRESSURE
- GPH : U.S. GAL. PER HOUR
- TAS : TRUE AIRSPEED
- KTS. : KNOTS
- S.L. : SEA LEVEL
- F.R. : FULL RICH
- A.R. : AUTO-RICH
- A.L. : AUTO-LEAN
- C.L. : CRUISING LEAN
- M.L. : MANUAL LEAN
- F.T. : FULL THROTTLE

Figure 84 (Sheet 3 of 3 Sheets) — Flight Operation Instruction Chart—Single Engine

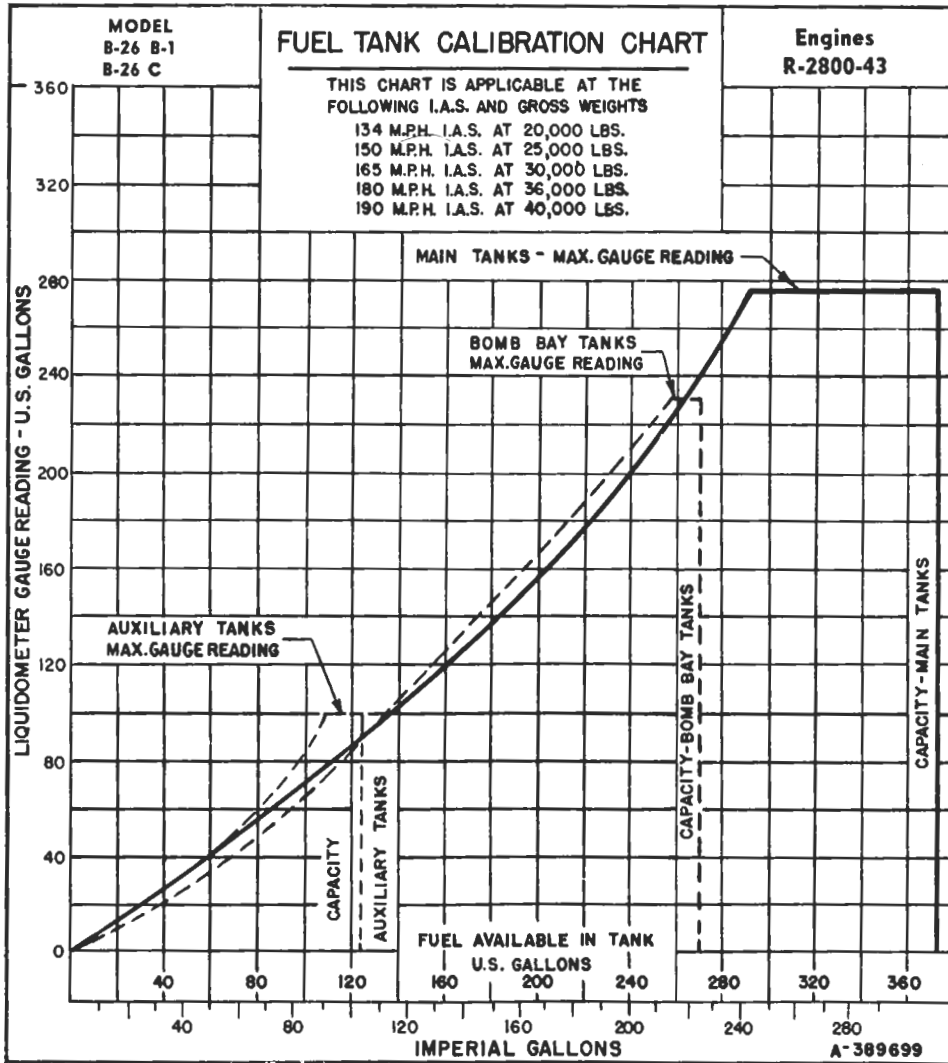

Figure 85 — Fuel Tank Calibration Chart

**5. FUEL TANK CALIBRATION. (See figure 85.)**

Fuel quantities indicated on the liquidometer gage contain inaccuracies over the entire range of the readings. Accurate determination of the actual fuel level in main or auxiliary tanks is made possible by the use of the above chart.

**EXAMPLE.**

*a. REQUIRED.*—Determine the actual quantity of fuel available in the right-hand main tank with a liquidometer gage reading of 160 US gallons.

*b. SOLUTION.*

(1) Project across 160 US gallon liquidometer gage reading line to intersection with main tank curve.

(2) Carry point down to intersect base line and read 204 US (170 Imperial) gallons available fuel in tank.

**Note**

Although the main fuel tanks have a capacity of 360 US (300 Imperial) gallons each, the liquidometer gages are calibrated only from 0 to 275 gallons. The odd shape of the tanks prevents placement of the liquidometer units to register the complete range from empty to full. Since it is more important to have accurate readings in the lower range, the float is placed so that it registers minimum capacity accurately and contacts the top of the tank at the 257-gallon level.

### 3. CRUISING CONTROL CHART. (See figure 89.)

*a. GENERAL.*—Powers given on the chart are percentages of 2 x 1600 brake horse power, which is the specification normal rated power (low blower) at the critical altitude of the airplane. The charted readings for pilot's indicated airspeed include calibration for pitot boom position error. Fuel flows are shown in gallons per hour total for two engines.

#### *b. TO DETERMINE AIRSPEED FOR ANY DESIRED POWER AT ANY GROSS WEIGHT.*

(1) *EXAMPLE.*—Find the indicated and true airspeed under the following conditions: brake horse power 55 percent, free air temperature 20°C (68°F) pressure altitude 7000 feet, gross weight 32,000 pounds.

(2) *SOLUTION.*—Illustrated on chart. (See figure 89.)

(*a*) Project up 20°C (68°F) temperature line (point "A") to intersection with 7000 feet pressure altitude curve to establish 9000 feet density altitude (point "B").

(*b*) Project 9000 feet density altitude line across to intersection with 55 percent brake horse power curve (point "C").

(*c*) Carry this point down to 32,000 pounds gross weight line (point "D").

(*d*) Project diagonally up, parallel to gross weight calibration curves to intersect base line (26,000 pounds line) (point "E"). Read 189.5 mph pilot's indicated airspeed at this intersection.

(*e*) Carry this point up to intersect 9000 feet density altitude line (point "F"). Read 219 mph true airspeed at this intersection.

#### *c. TO DETERMINE BRAKE HORSE POWER REQUIRED FOR ANY DESIRED TRUE AIRSPEED AT ANY GROSS WEIGHT.*

(1) *EXAMPLE.*—Find the brake horse power required for the following conditions: mph 230, free air temperature -6°C (21.2°F) pressure altitude 15,000 feet, gross weight 28,000 pounds.

(2) *SOLUTION.*

(*a*) Project up -6°C (21.2°F) temperature line to intersection with 15,000 feet pressure altitude curve to establish 16,000 feet density altitude.

(*b*) Project 16,000 feet density altitude line across to intersection with 230 mph true airspeed curve. Read 178 mph pilot's indicated airspeed.

(*c*) Carry this point down to intersect base line (26,000 pounds line).

(*d*) Project diagonally down parallel to gross weight calibration curves to intersect 28,000 pounds line.

(*e*) Carry this point up to intersect 16,000 feet density altitude line. At this intersection read 52 percent brake horse power, 2100 rpm, 24.2 inches Hg manifold pressure, low blower, and fuel flow of 128 gallons per hour.

#### *d. DETERMINE AIRSPEED AND ENGINE CONDITIONS FOR MAXIMUM RANGE AT ANY GROSS WEIGHT.*

(1) *EXAMPLE.*—Find airspeed, brake horse power, rpm, manifold pressure, gallons per hour, and blower ratio for maximum range under the following conditions: pressure altitude 8000 feet, gross weight 30,000 pounds, free air temperature 17°C (62.6°F).

(2) *SOLUTION.*

(*a*) Project up 17°C (62.6°F) temperature line to intersection with 8000 feet pressure altitude curve to establish 10,000 feet density altitude.

(*b*) Project 10,000 feet density altitude line across to intersection with maximum range line. Read 200 mph true airspeed and 170.5 pilot's indicated airspeed.

(*c*) Carry this point down to intersect base line (26,000 pounds line).

(*d*) Project diagonally down parallel to gross weight calibration curves to intersect 30,000 pounds gross weight line.

(*e*) Carry this point up to intersect 10,000 feet density altitude line. At this intersection, read 45.5 percent brake horse power, 1810 rpm, 26.5 inches Hg manifold pressure, a fuel flow of 112.5 gallons per hour, and low blower.

#### *e. TO DETERMINE AIRSPEED AND ENGINE CONDITIONS FOR MAXIMUM ENDURANCE AT ANY WEIGHT.*

(1) *EXAMPLE.*—Find airspeed, brake horse power, rpm, manifold pressure, gallons per hour, and blower ratio for maximum endurance under the fol-



lowing conditions: pressure altitude 8000 feet, gross weight 30,000 pounds, free air temperature  $-10^{\circ}\text{C}$  ( $14^{\circ}\text{F}$ ).

(2) SOLUTION.

(a) Project up  $-10^{\circ}\text{C}$  ( $14^{\circ}\text{F}$ ) temperature line to intersection with 8000 feet pressure altitude curve to establish 7000 feet density altitude.

(b) Project 7000 feet density altitude line across to meet 30,000 pounds maximum endurance line. At this intersection read 159 mph pilot's indicated airspeed and 178 mph true airspeed.

(c) Carry this point down to intersect base line (26,000 pounds line).

(d) Project diagonally down parallel to gross weight calibration curves to intersect 30,000 pounds gross weight line.

(e) Carry this point up to intersect 7000 feet density altitude line. Read 41 percent brake horse power, 1720 rpm, 27.0 inches Hg manifold pressure, a fuel flow of 103 gallons per hour, and low blower.

**CAUTION**

Airspeed and brake horse power can be read from the same point on the chart only for 26,000 pounds gross weight.

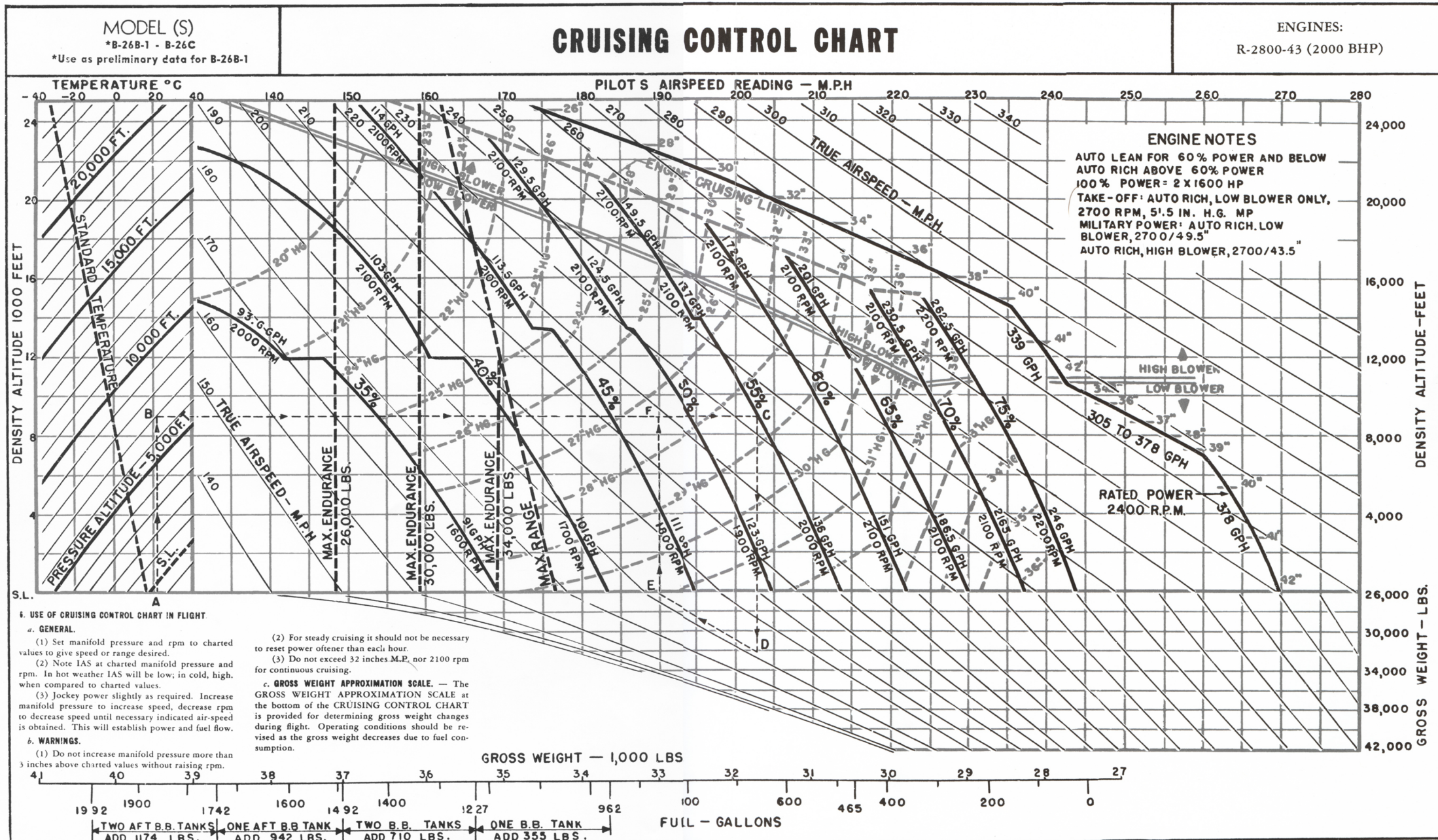

Figure 89 — Cruising Control Chart

(2) SOLUTION.

4. RANGE CHART. (See figure 90.)

a. ESTIMATING RANGE.—Curves for three specific conditions are presented on the "Range Chart." (See figure 90.) A conservative estimate of range with different fuel load and initial gross weight can be made as follows: Use curves for an initial gross weight equal to or greater than that for the modified fuel load including allowance for warm-up, take-off, and climb. Multiply the range shown on the chart for a given airspeed and altitude by the ratio of the fuel carried to the fuel specified on the chart. Ranges shown on the chart are for flight at constant true airspeed and varying power.

b. EXAMPLE.—Use of "Range Chart." (See figure 90.)

(1) REQUIRED.—Estimate the range of the airplane under the following conditions:

- True airspeed 240 mph.
- Density Altitude 15,000 feet.
- Fuel 600 gallons (499.6 Imperial).
- Bombs 1984 pounds.

(a) Choose curves for an initial gross weight of 35,553 pounds, the condition illustrated on the chart closest to the required conditions.

(b) Read a range of 1395 miles at the intersection of 240 mph and 15,000 feet.

(c) The range of 1395 miles is charted for a fuel load of 962 U.S. gallons (801.1 Imperial gallons). Estimate the range for 600 U.S. gallons (499.6 Imperial gallons) as follows:

$$\text{Range (600 U.S. gallons)} = 1395 \times \frac{600}{962} = 870 \text{ miles}$$

c. USE OF RANGE CHART IN FLIGHT. Use the "Range Chart" in conjunction with the "Cruising Control Chart" to obtain the correct settings for the range desired.

- (1) Select true airspeed from the "Range Chart."
- (2) Set rpm and manifold pressure as specified, on the "Cruising Control Chart" for the selected true airspeed, desired altitude, and initial gross weight.
- (3) Maintain charted airspeed by determining new rpm and manifold pressure settings as the flight progresses and gross weight decreases.

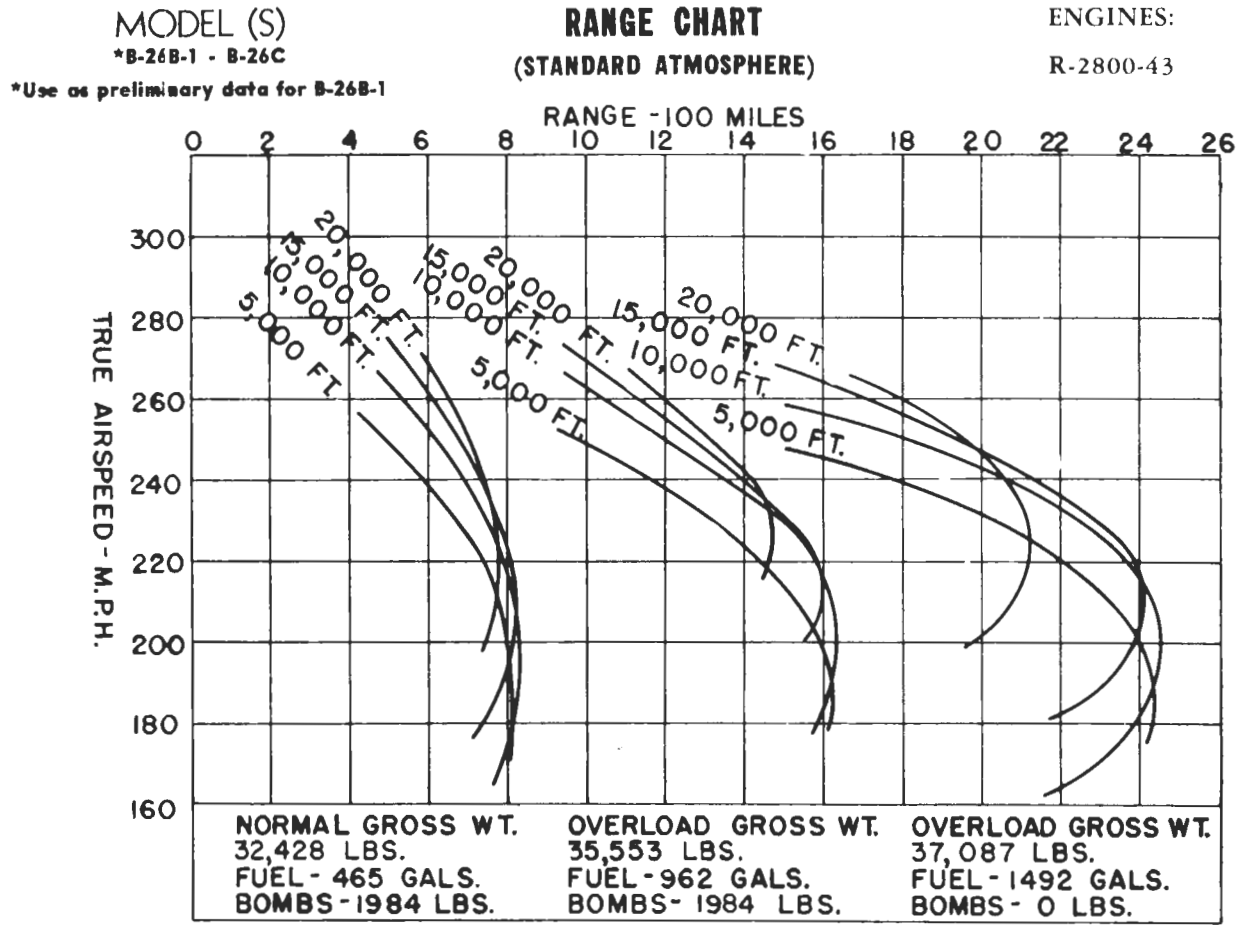

These curves are computed from conditions of altitude, power, and fuel flow specified on the "Cruising Control Chart." For engine cruising limitations during flight, see engine oper-

ating instructions. No allowances are made for warm-up, take-off, climb, head winds, or descent. The bomb load is considered to be carried half the distance of the flight.



5. MAXIMUM RANGE CHART. (See figure 91.)

a. ESTIMATING MAXIMUM RANGE.

(1) Use the "Maximum Range Chart" to find correct operating conditions for maximum range at various gross weights and altitudes.

(2) Select the pilot's indicated airspeed for flight at the desired density altitude from the lower portion. The speed at any altitude is independent of gross weight.

(3) From the upper set of curves read the engine operating conditions of speed (rpm), manifold pressure, and mixture setting for the desired gross weight and altitude. Note that 2100 rpm covers a larger region than the other rpm's shown on the chart.

(4) Obtain miles per gallon, gallons per hour, and check blower ratio for the desired conditions.

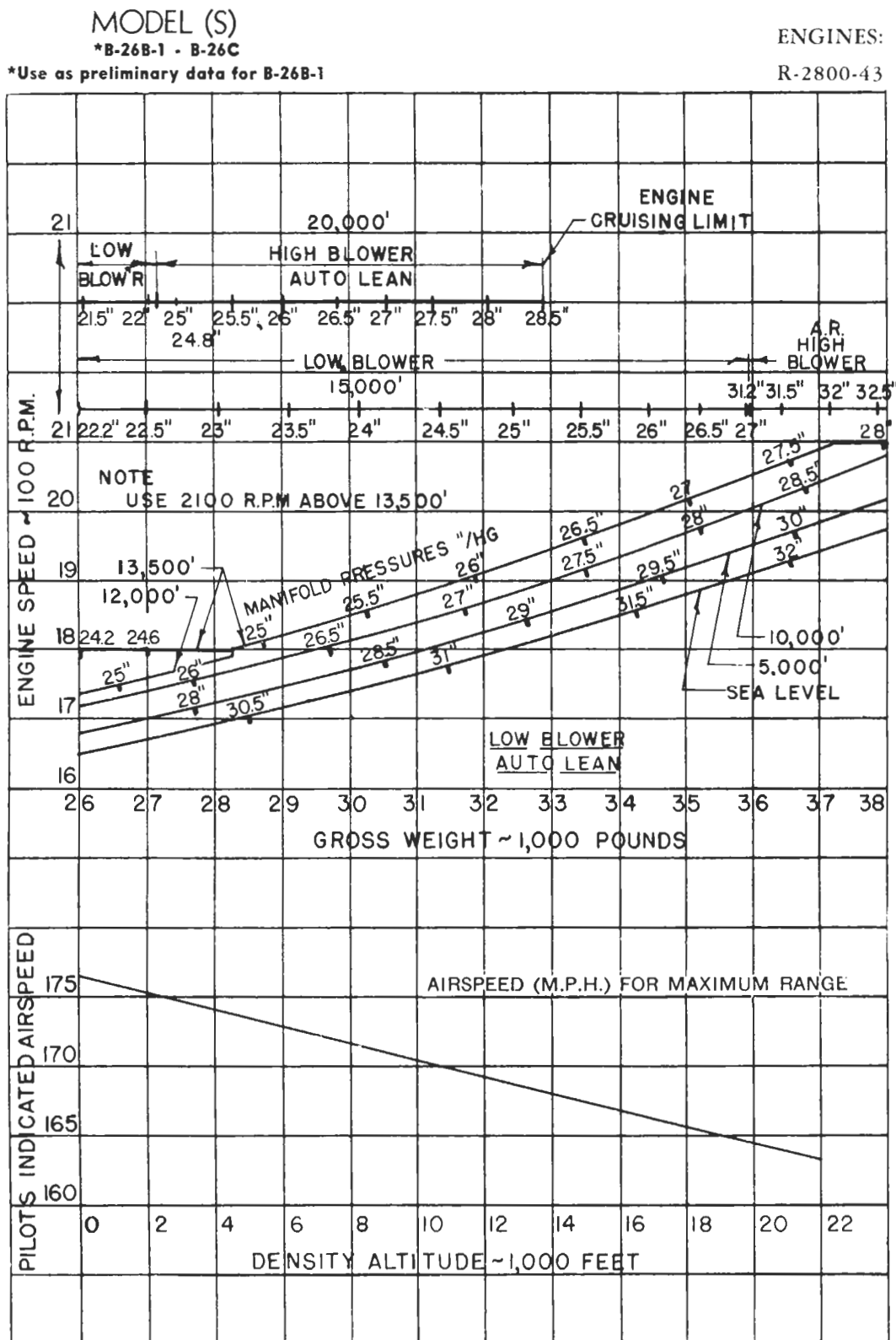

Figure 91 —  
Maximum Range  
Chart

b. EXAMPLE.—Use of "Maximum Range Chart."

(1) REQUIRED.—Estimate the maximum range of the airplane under the following conditions:

Gross weight 33,000 pounds

Density altitude 10,000 feet

(2) SOLUTION.—Obtain the following operating conditions:

Pilot's indicated airspeed—Manifold pressure—

170.5 mph

27.4 inches Hg

RPM—1900

Mixture—"AUTO LEAN"

1.61 miles per gallon (U.S.) 123 U.S. gallons per hour

1.93 Imperial

102.4 Imperial

Find that for the gross weight of 33,000 pounds it is not necessary to shift to high blower until a density altitude of 16,700 feet has been reached.

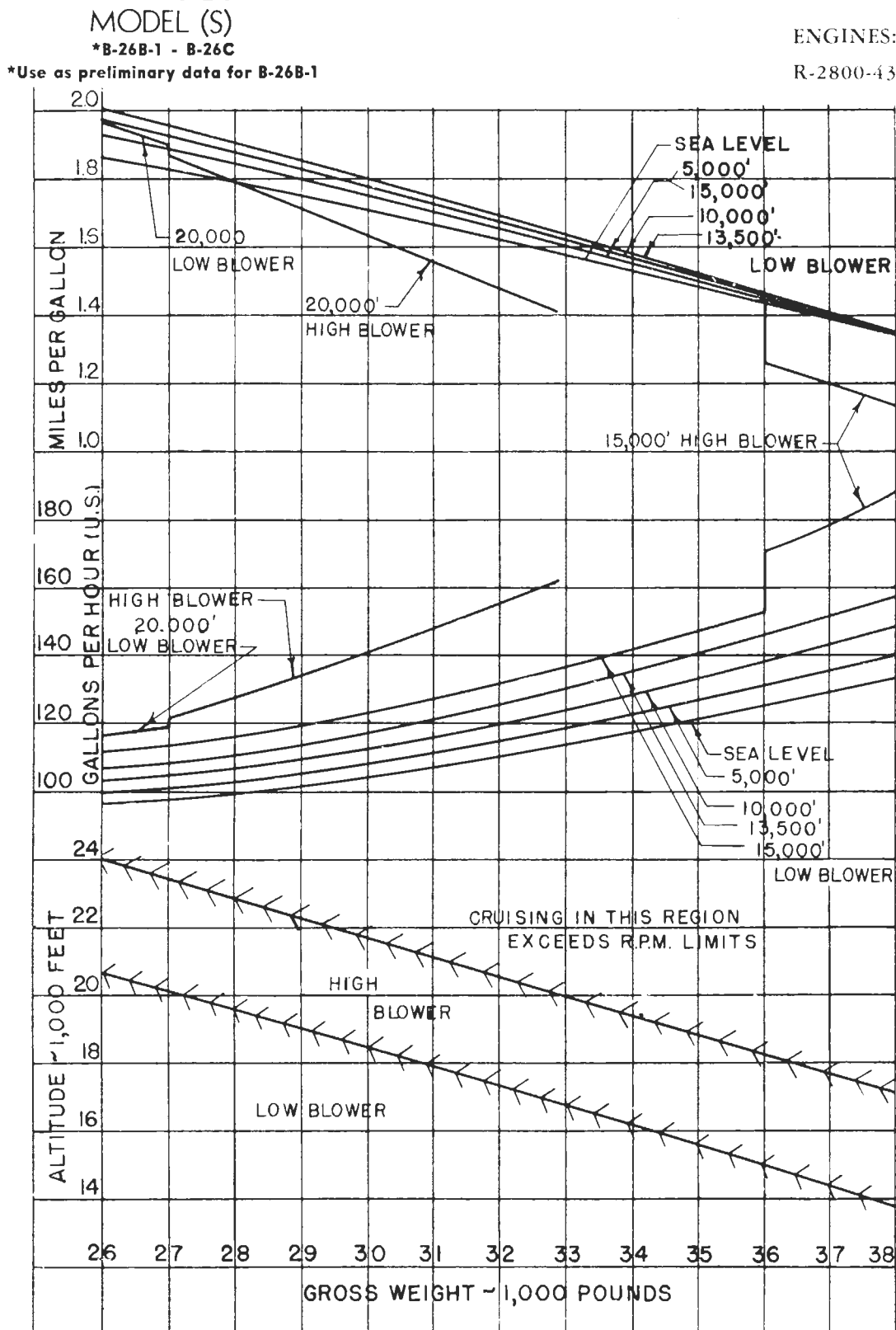

**6. SINGLE ENGINE CONTROL. (See figure 92.)**

*a. SINGLE ENGINE FLIGHT.*—The best attitude in which to fly the airplane with one engine operating is at zero yaw with a small degree of bank. However, there is no instrument or set of instruments which will indicate that the airplane is flying at zero yaw. Optimum conditions must be derived from the resulting performance. For example, if the airplane is banked too greatly for the amount of yaw it will slip and lose altitude, recording such a condition on the rate of climb indicator, altimeter, and turn and bank indicator. If the airplane is not banked sufficiently it will yaw and hence lose altitude because of the increased drag. The optimum condition will be found between excessive bank and insufficient bank where the airplane will be at zero yaw, will perform best, and will maintain level flight for the charted engine and airplane conditions.

*b. TRIMMING FOR SINGLE ENGINE FLIGHT.*—for optimum operation, adjust engine power to the value shown on the chart. Bring the airplane to approximately zero yaw with the angle of bank required to trim. Note rate of descent, adjust angle of bank, trimming with the angle of yaw until the desired altitude can be maintained.

*c. EXAMPLE.* — Determine the engine operation, speed, and fuel consumption required to obtain maximum range at constant altitude under the following conditions:

- Pressure altitude 7000 feet
- Gross weight 29,000 pounds
- Free air temperature 10°C (50°F)

*d. SOLUTION.*—Obtain the following operating conditions:

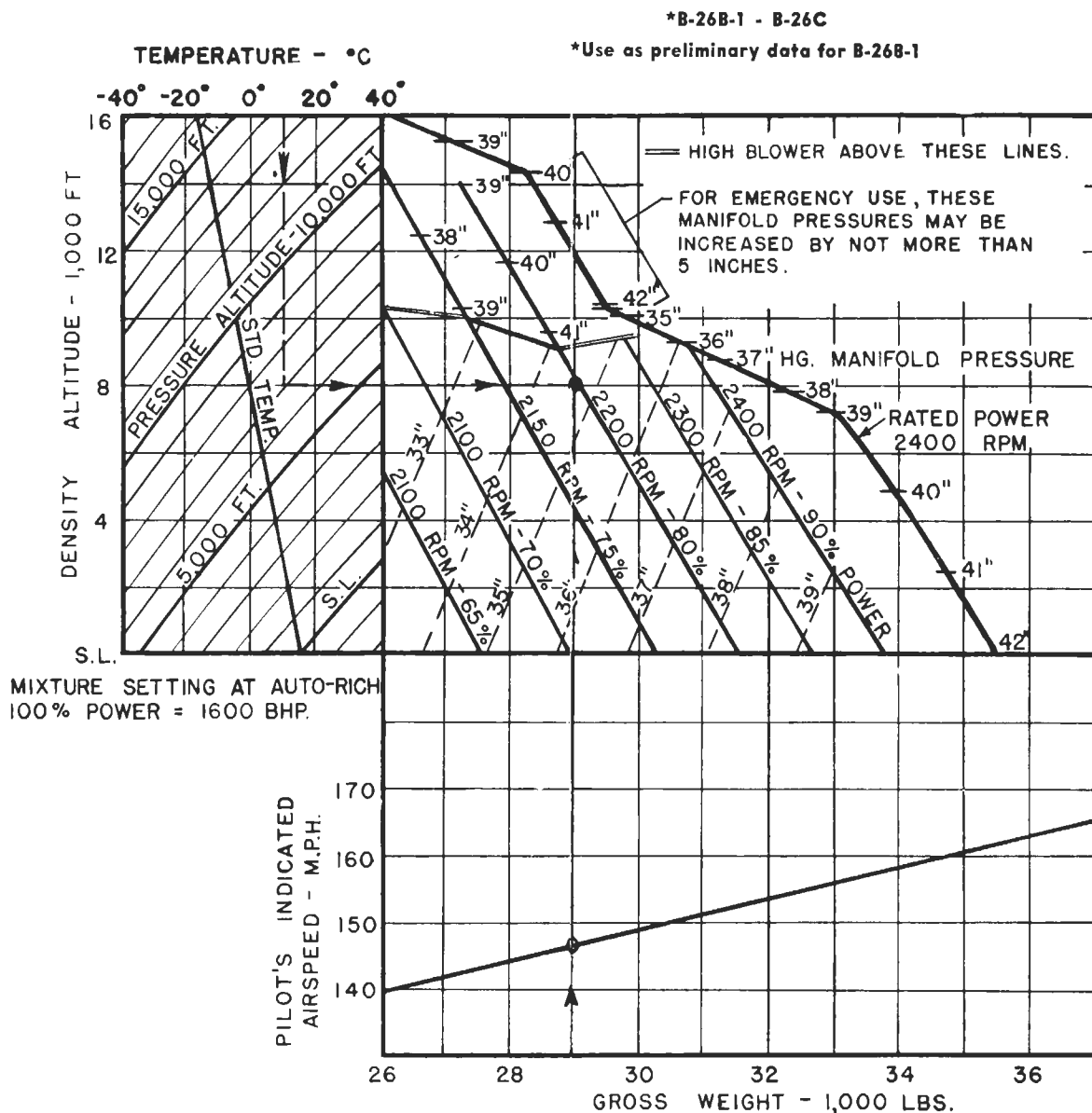

Figure 92 — Single-Engine Control Charts

(1) From figure 92.

(a) Project down 10°C (50°F) temperature line to intersection with 7000 feet pressure altitude curve, to establish 8000 feet density altitude.

(b) Project up 29,000 pounds gross weight line to intersect speed curve and read 147 mph, pilot's indicated airspeed.

(c) Continue projection up to 8000 feet density altitude and read engine operation:

RPM 2200  
Manifold Pressure 34.6 inches Hg  
Power 79.5 percent

Mixture "AUTO RICH"  
Blower Low

(2) From figure 92.

(a) Project up 29,000 pounds gross weight line to intersect lower 8000 feet density altitude curve.

(b) Read 136 gallons per hour.

(c) Continue projection to intersect upper 8000 feet density altitude curve.

(d) Read 1.23 miles per gallon.

**NOTE.**—For optimum flight attitude fly with dead engine high with propeller feathered, and zero angle of yaw.

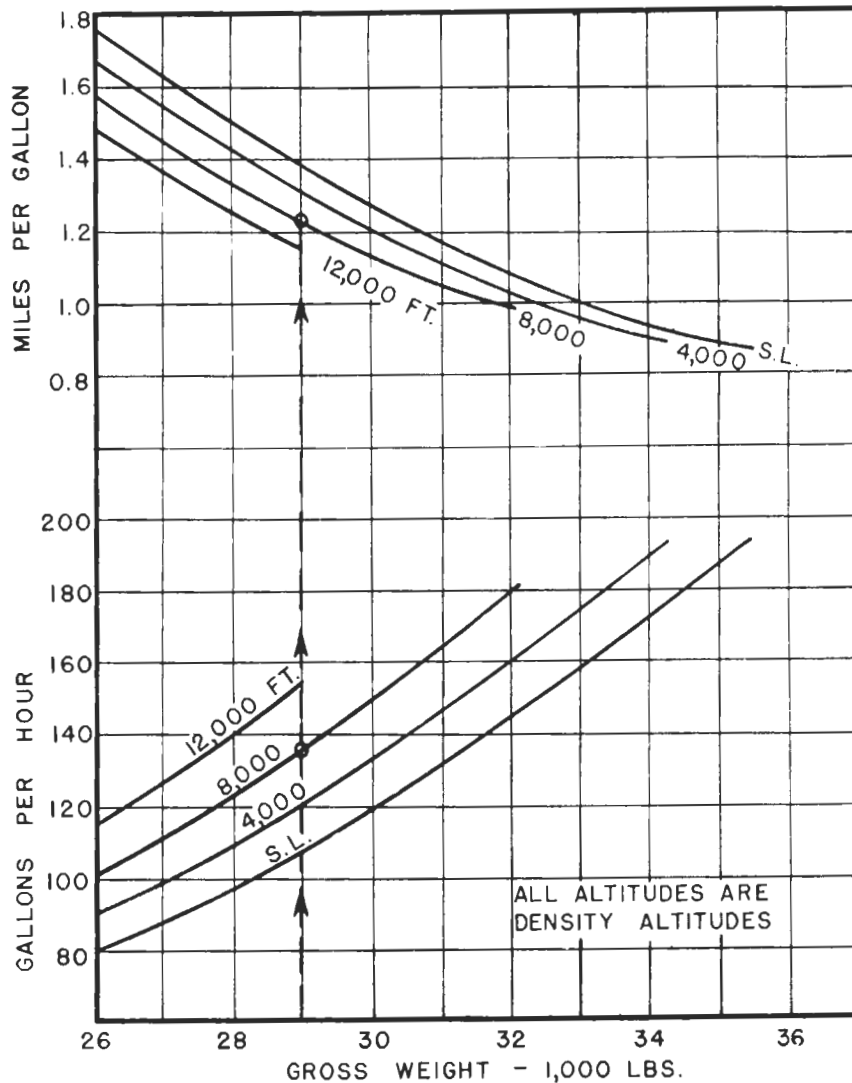
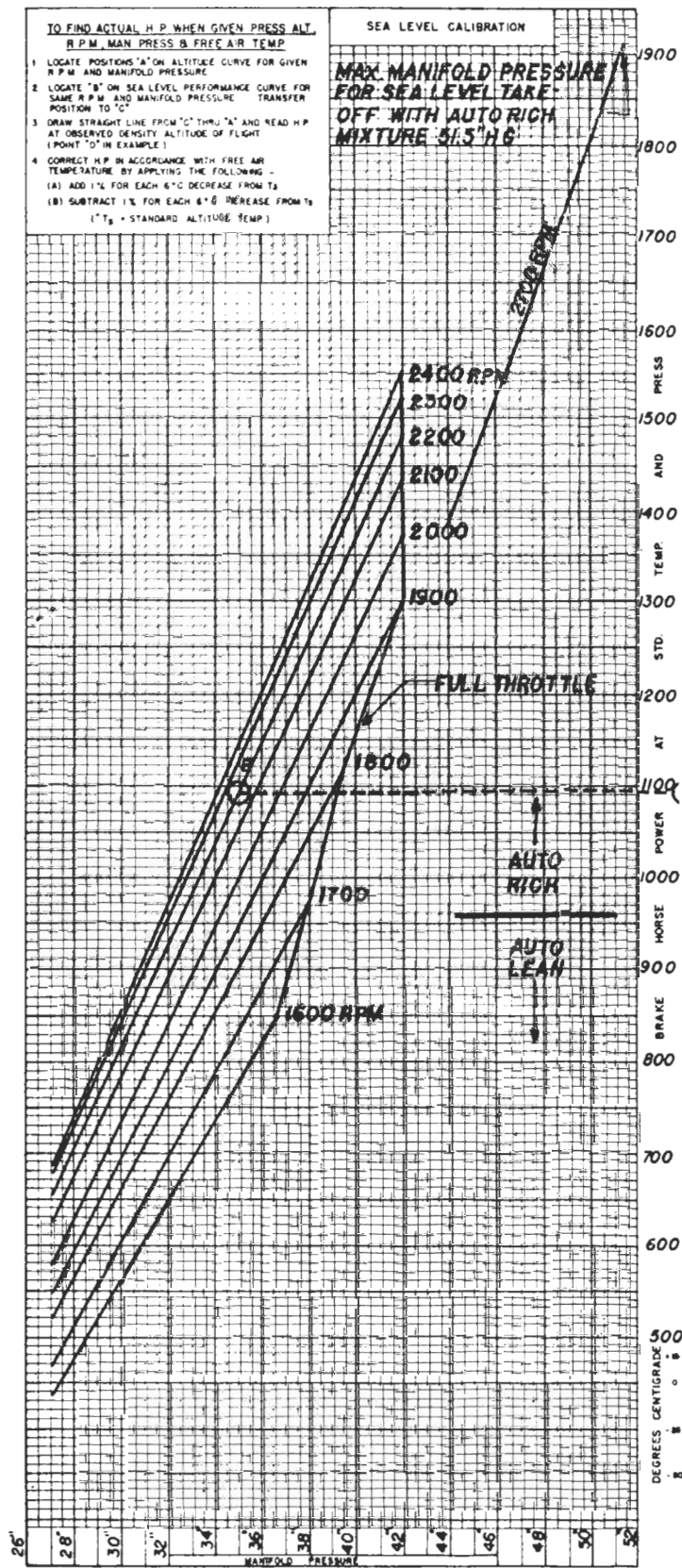



Figure 93 — Engine Flight Calibration Curves. (Sheet 1 of 2)



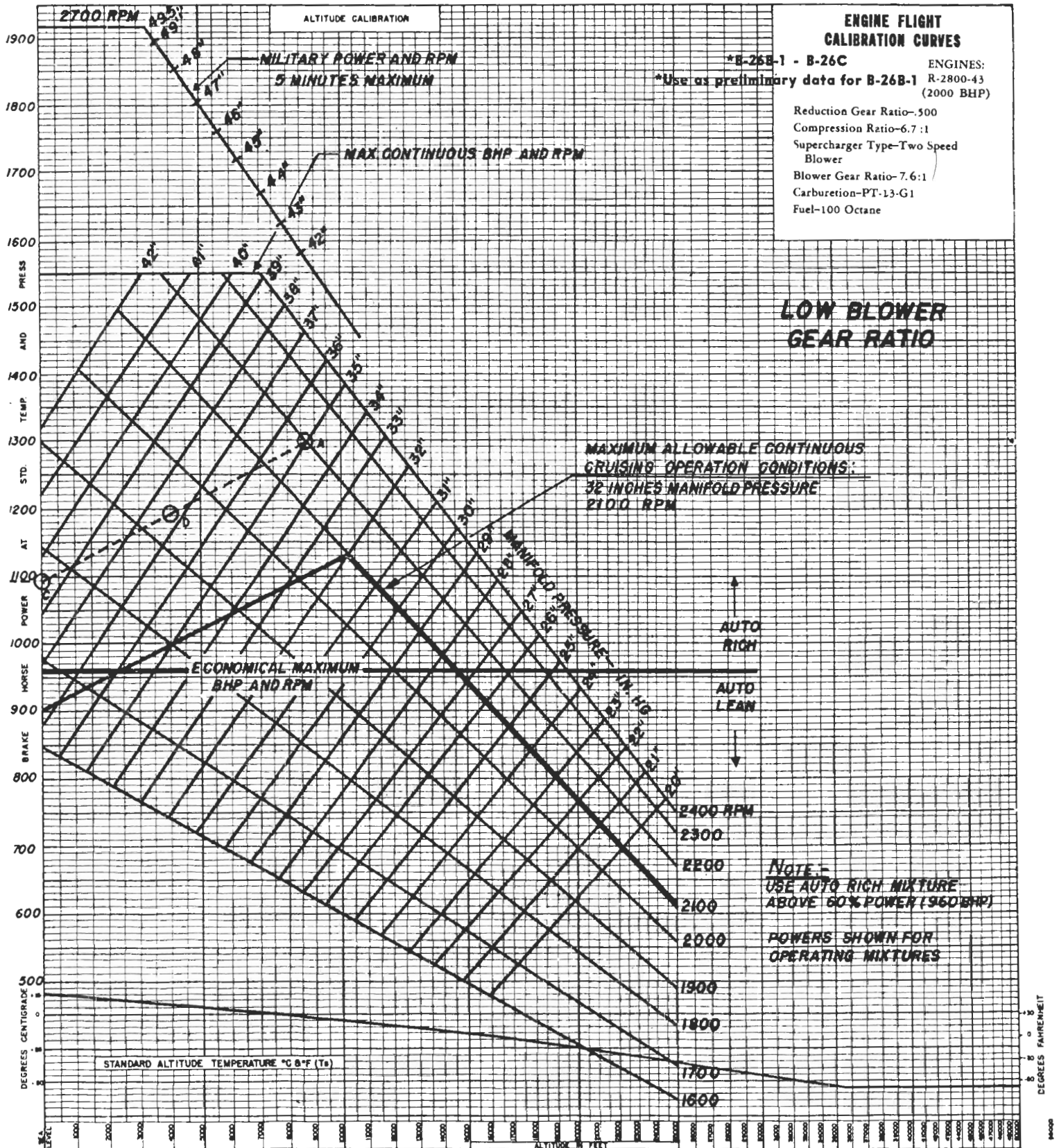

Figure 93 — Engine Flight Calibration Curves. (Sheet 2 of 2)

