

TM 9-1940

★ RESTRICTED

WAR DEPARTMENT

TECHNICAL MANUAL

LAND MINES

15 JULY 1943

PROPERTY

AMMUNITION INSPECTORS SCHOOL

SAVANNAH ARMY DEPOT

NO LIBRARY

★ Dissemination of restricted matter — The information contained in restricted documents and the essential characteristics of restricted materiel may be given to any person known to be in the service of the United States and to persons of undoubted loyalty and discretion who are cooperating in Government work, but will not be communicated to the public or to the press except by authorized military public relations agencies. (See also paragraph 18 b, AR 380-5, 28 September 1942.)

★ RESTRICTED

TECHNICAL MANUAL }
No. 9-1940 }

WAR DEPARTMENT
Washington, 15 July 1943

LAND MINES

CONTENTS

	Paragraph	Pages
SECTION I. Introduction	1	2
II. General	2- 9	
III. Antitank mines and fuzes.....	10-15	
IV. Antipersonnel mines	16-22	23-36
V. Fuzes and firing mechanisms.....	23-28	37-48
VI. References	29-30	
INDEX		50-51

★ Dissemination of restricted matter—The information contained in restricted documents and the essential characteristics of restricted materiel may be given to any person known to be in the service of the United States and to persons of undoubted loyalty and discretion who are cooperating in Government work, but will not be communicated to the public or to the press except by authorized military public relations agencies. (See also paragraph 18 b, AR 380-5, 28 September 1942.)

* Supersedes TB 1940-1, dated 24 September 1942; TB 1940-2, dated 24 September 1942; TB 1940-3, dated 8 October 1942; TB 1900-10, dated 5 January 1943; TM 9-1900, paragraphs 65 to 70; TC 12, 1942; and TC 75, 1942, paragraphs 5, 7, 8, and 9.

LAND MINES

Section I

INTRODUCTION

Paragraph

Purpose and scope 1

1. PURPOSE AND SCOPE.

a. The purpose of this manual is to impart information of a technical nature concerning land mines and related items, such as may be necessary for their intelligent care, handling, and use.

b. This manual describes:

- (1) Antitank mines.
- (2) Antipersonnel mines.
- (3) Bangalore torpedoes.
- (4) Demolition materials.
- (5) Fuzes and firing mechanism.

c. The information covers:

- (1) Identification.
- (2) Care, handling, and preservation.
- (3) Fuzing and unfuzing.
- (4) Authorized assembly and disassembly.
- (5) Packing and marking.

& see C1,

Section II

GENERAL

	Paragraph
Description	2
Classification	3
Identification	4
Care and precautions in handling	5
Storage and preservation	6
Destruction of unserviceable material and duds	7
Packing and marking for shipment	8
Field report of accidents	9

2. DESCRIPTION.

a. All types of land mines consist of a charge of high explosive and a device for detonating this charge under the proper conditions. In general, land mines are of the trap type; they rely on some action of the enemy for initiation. Some types are of complicated design, as the bounding mine which projects a shell 6 to 8 feet above the ground and explodes it there. Most types are simple, consisting only of a container of high explosive and a firing mechanism.

3. CLASSIFICATION.

a. Land mines are classified according to the use for which they are designed as antitank and antipersonnel. However, either type may, on occasion, be used for the other and both types may be used for demolitions, just as either type may be improvised from demolition materials.

b. Antitank mines are also classified as high-explosive, practice, or dummy.

4. IDENTIFICATION.

a. **General.** Ammunition is identified by means of the painting and marking on the item itself and all containers. Complete identification is furnished by:

(1) Standard nomenclature which includes type, size, and model.

(2) Lot number, which includes manufacturer's lot number, manufacturer's initials or symbol, and date of loading.

b. **Standard Nomenclature.** Standard nomenclature is established in order that each item supplied may be specifically identified by name. Its use, for all purposes of record, is mandatory except as noted in subparagraph c, below.

c. **Ammunition Identification Code.** To facilitate reporting, requisitioning, and record keeping in the field, each complete round and each item of issue is assigned a five-character code symbol.

LAND MINES

These symbols and information concerning their use may be found in Standard Nomenclature Lists and OFSB 3-14.

d. **Mark or Model.** To distinguish a particular design, a model number is assigned when the design is adopted. This designation becomes an essential part of the nomenclature of the item. It consists of the letter "M" followed by an Arabic numeral. Modifications of the original model are indicated by adding the letter "A" and the appropriate Arabic numeral to the model designation. Formerly, the word "Mark" was used. This was abbreviated "Mk." and followed by a Roman numeral.

e. **Ammunition Lot Numbers.** When ammunition is manufactured, an ammunition lot number is assigned in accordance with pertinent specifications. The lot number is marked or stamped on every item (unless the item is too small) and on all containers of the ammunition. Its use is required for all purposes of record, including reports on condition, function or accidents.

f. **Painting.** Ammunition is painted to prevent rust, to provide, by the color, an aid to concealment, and for identification as to type. Service land mines are painted lusterless olive-drab with marking in black. However, where it will not affect the concealment qualities, there is an area painted in accordance with the ammunition identification color scheme: yellow, high-explosive; blue, practice; black, dummy or drill.

g. **Marking.** When the size of the item permits, each item of ammunition is marked with the type, size, model, and lot number of the item. Each container is marked with the same information.

5. CARE AND PRECAUTIONS IN HANDLING.

a. Ammunition should be protected against moisture, heat, and shock.

b. Ammunition is packed to withstand all ordinary conditions encountered in handling and shipping. Items that are not waterproof are packed in moisture resistant containers. Such containers should not be opened until the ammunition is about to be used or prepared for use. Items unpacked but not used should be repacked and the containers sealed. Such items should be used first in subsequent operations in order that stocks of opened packings may be kept to a minimum.

c. Damaged packings should be repaired or the items transferred to new packings. Care should be exercised to see that all original markings are reproduced on the new parts of the container.

d. Mines planted in wet surroundings should be waterproofed by treating the joints with grease, wax, cement, or sealing compound.

GENERAL

e. Ammunition should be protected against sources of excessive heat, including the direct rays of the sun. Boxes stored in the open should be covered by a paulin and piled so that there will be free circulation of air throughout the pile.

f. Fuzes, primers, and detonators are especially sensitive to heat and shock.

g. Boxes of ammunition should not be dropped, dragged, or tumbled.

h. Boxes should not be opened in a magazine nor within 100 feet of a store of explosives. Safety tools should be used in unpacking and repacking operations. Safety tools are those made of copper, wood, or other material incapable of producing sparks when struck.

i. No attempt will be made to fuze an item of ammunition closer than 100 feet to a magazine or other such store of explosives or ammunitions.

j. No disassembly of ammunition or components thereof will be permitted except as specifically authorized.

k. Safety pins, safety forks, and other safety devices are designed for the protection of planting personnel. They should be left in place until the last practicable moment before leaving and then removed. In picking up mines, they should be replaced first.

l. Care will be exercised to see that fuze cavities or detonator wells are clear of obstruction and free of foreign material before attempting to assemble the fuze or detonator.

m. Blasting caps, detonators, and fuzes with detonator assembled should be protected from shock, heat, and friction. By "shock" is meant such as is given by detonators knocking together when carried loose in the pocket or when dropped from any height whatever; by "heat," such as prolonged exposure to the direct rays of the sun; by "friction," any abnormal friction such as sliding across a table or being forced into a tight or obstructed well.

6. STORAGE AND PRESERVATION.

a. Explosives and ammunition should be stored in buildings designed, designated, and isolated for the specific purpose. Explosives and ammunition should not be stored in buildings which are used for other purposes, such as basements or attics of barracks, company supply rooms, or general storehouses. When specially constructed magazines are not available, the buildings used must afford good protection against moisture and dampness and have means for adequate ventilation. They must be floored with approved material and may not be heated by open fires or stoves.

b. Boxes, cases, and other containers of ammunition should be clean and dry before being stored. Damaged containers will be re-

LAND MINES

paired or replaced before storing, but the repairs or change of container will not take place in or within 100 feet of a magazine containing explosives. Powder dust or particles of explosive material from broken containers will be carefully taken up as soon as spilled. All work will be suspended until this has been done. Ammunition containers should not be opened in a magazine nor should they be stored after having been opened unless they have been closed securely. No nails or tacks will be driven into a container of explosives or ammunition. Cases should be handled with care. Cases should not be dragged across the floor in magazines as this practice has resulted in starting fires where there was powder dust present.

c. Loose rounds or components will not be kept in a magazine. No empty container, no excess dunnage nor tools, should be permitted to remain in a magazine. No oily rags, paint, turpentine, etc., will be left in a magazine containing ammunition or explosives.

d. Ammunition should be piled by lot numbers in stable piles which are so arranged that the individual containers are accessible for inspection and offer no obstacle to the free circulation of air. The tops of ammunition piles will be below the level of the eaves to avoid the heated space directly beneath the roof. The bottom layer should be raised off the floor about 2 inches. Dunnage should be level; if necessary, shims or wedges should be used. Stacks should not be so high that ammunition or its containers in the lower layers will be crushed or deformed. Partly filled boxes should be fastened securely, marked, and kept on the top of the pile.

e. Magazines should be built on well drained ground.

f. It is essential that explosives and ammunition be segregated in an area specifically set aside for their exclusive storage. This area need not be large, but it is important that it be segregated from inhabited buildings, public highways, and railroads. Individual magazines must be separated by distances adequate to prevent propagation of an explosion from one to another. Such distances are given in TM 9-1900.

g. Vegetation should be controlled and dry leaves, grass, and rubbish removed from the magazine area and burned.

h. Accumulation of trash, empty boxes, scrap lumber, or any such inflammable material should not be permitted.

i. A 50-foot firebreak should be established around each above-ground magazine.

j. Smoking, the carrying of matches, and the use of lights other than approved electric lights in magazines or explosives storage areas, are forbidden.

GENERAL

k. Interiors of magazines should be clean. Paint, oils, gasoline, waste, rags, and other inflammable material should not be left in magazines.

l. Except when they are issued in one packing, mines and fuzes will not be stored in the same magazine. This applies to the detonating element of fuzes such as detonators, blasting caps, and the like, and not to metal parts of fuzes or firing mechanisms when the detonating element is not assembled thereto.

7. DESTRUCTION OF UNSERVICEABLE MATERIAL AND DUDS.

a. **General.** Unserviceable material and duds will be destroyed only by authorized and experienced personnel. Safety precautions such as those laid down in TM 9-1900 and in Ordnance Safety Manual OO No. 7224, will be observed.

b. **Burning.** Unconfined explosives such as demolition blocks may be destroyed by spreading out thin on a layer of combustible material and burning. Small components may be burned in a covered trench or pit by preparing the fire, placing a quantity of the item to be destroyed on the pile, and igniting from a distance by such means as a train of excelsior. Larger items such as the FUZE, antitank mine, M1, may be burned in a covered pit by feeding one at a time down a baffled chute from behind a barricade.

c. Detonation.

(1) Larger items will be destroyed by detonation at safe distances from buildings, inhabited areas, and magazine areas.

(2) Thin-walled mines, such as the antitank mine or bangalore torpedo, will need only one demolition block to detonate a pile but, because the thin-walled mines contain such a large percentage of explosive, care must be exercised to limit the number destroyed at a blast.

(3) Thick-walled mines, such as the antipersonnel mines, will need correspondingly more explosive and greater barricading to limit fragments.

(4) Blasting caps inserted in the fuze cavity or detonator well may be used to destroy an item, instead of using the cap and a block of demolition explosive.

d. **Duds.** Any land mine which failed to explode when its fuze or firing mechanism was operated and any unexploded mine that shows signs of having been operated (such as an antitank mine with vehicle tracks over its location or a mine with a half-pulled detonator wire) will be regarded as a dud. No attempt will be made to disarm, unfuze, or take up a dud. It will be destroyed in place with explosive.

LAND MINES

8. PACKING AND MARKING FOR SHIPMENT.

a. Packing data for land mines and their components are given in Table I.

b. In addition to nomenclature and lot number, packings offered for shipment are marked with the Interstate Commerce Commission name or classification of the article, the names and addresses of consignor and consignee, volume and weight, and the code symbol.

see C1

TABLE I

Item	Quantity	Dimensions (in.)	Sq. Ft.	Ca. Weight (lb.)	
BLOCK, demolition, M2 and M3	16	21 ¹¹ / ₁₆ x 14 ¹⁵ / ₁₆ x 7 ¹¹ / ₃₂	2.16	1.32	62
BLOCKS, demolition, chain, M1	2	21 ¹¹ / ₁₆ x 14 ⁵ / ₁₆ x 7 ¹¹ / ₃₂	2.16	1.32	62
CAP, blasting, tetryl, electric	500	22 x 15 x 9 ¹ / ₂	2.29	1.81	54
CAP, blasting, tetryl, electric	5,000	19 x 16 x 8	2.11	1.40	65
EXPLOSIVE, nitrostarch, rectangular	50 pkg.	Quantities and dimensions may vary with different manufacturers		—	—
EXPLOSIVE, TNT, rectangular	108	17 ³ / ₄ x 12 x 9	1.48	1.11	65
FUZE, mine, antitank, H.E., M1A1	100	27 ⁵ / ₈ x 14 ³ / ₄ x 8 ²³ / ₃₂	2.83	2.06	96
FUZE, mine, antitank, practice, M1	100	27 ⁵ / ₈ x 14 ³ / ₄ x 8 ²³ / ₃₂	2.83	2.06	162
MINE, antipersonnel, M2 and M2A1	10	32 x 13 ³ / ₁₆ x 9 ¹⁵ / ₃₂	2.93	2.31	93
MINE, antipersonnel, M3	6	17 ⁷ / ₈ x 8 ¹¹ / ₁₆ x 9 ¹ / ₃₂	1.08	.81	72
MINE, antitank, H.E., M1	5	26 ¹ / ₈ x 9 ³ / ₄ x 10 ¹⁷ / ₃₂	1.77	1.55	68
MINE, antitank, H.E., M1A1	5	26 ¹ / ₈ x 9 ³ / ₄ x 10 ¹⁷ / ₃₂	1.77	1.55	71
MINE, antitank, H.E., M4	5	26 ¹ / ₈ x 10 x 10 ²⁵ / ₃₂	1.8	1.6	68
MINE, antitank, H.E., M5	4	26 ⁷ / ₈ x 11 ³ / ₈ x 12 ¹ / ₈	2.54	2.58	78
MINE, antitank, practice, M1	5	26 ¹ / ₈ x 9 ³ / ₄ x 10 ¹⁷ / ₃₂	1.77	1.55	64
MINE, antitank, practice, M1B1	5	26 ¹ / ₈ x 10 x 10 ²⁵ / ₃₂	1.8	1.6	37
TORPEDO, bangalore, M1	10	63 ³ / ₈ x 15 ⁷ / ₈ x 5 ³ / ₈	6.99	3.13	168

Section III

ANTITANK MINES AND FUZES

	Paragraph
General	10
Antitank mines	11
Practice antitank mines	12
Dummy antitank mines	13
Antitank mine fuzes	14
MINE, antitank, nonmetallic, H.E., M5, and FUZE, mine, anti-tank, chemical, M5	15

10. GENERAL.

a. An antitank mine is any charge of explosive concealed or laid where it may be passed over and exploded by vehicle. In addition to the standardized types described below, antitank mines can be improvised from bangalore torpedoes (par. 19) and demolition blocks (pars. 20, 21, and 22).

11. ANITANK MINES.

a. **General.** This type of mine is shown with principal dimensions and marking in figures 1, 2, 3, and 4. The complete round consists of three components: the mine body, the spider, and the fuze.

b. **Description.** The mine body is a squat cylindrical container of light steel, filled with high explosive. The bottom is plain and the side has a carrying handle attached. The top extends beyond the side to form a grooved flange for the attachment of the spider. In the center of the top there is an opening for the fuze cup and to the side there is a capped filling hole. The fuze is described in paragraph 14. The spider is in the shape of a wheel and has four hooks attached to the rim for assembling the spider to the flange on the mine body. When assembled, the hub of the spider rests on the striker head of the fuze. As shipped, the spider is nested to the bottom of the mine body.

c. **Fuzing.** The following steps are required to assemble the complete round:

(1) Remove the spider from the bottom of the body.

(2) Insert fuze in fuze cup. Push the fuze down until it latches. When thus assembled, the upper surface of the fuze body is flush with the upper surface of the mine.

see c/ NOTE: Before inserting fuze, be sure that the fuze cup is clear, that is, no foreign matter present; in the Mine M1A1 or M4, be sure the booster is in the bottom of the fuze cup.

(3) Assemble spider. To assemble the spider, aline two adjacent hooks with the two notches in the flange of the body. Engage the

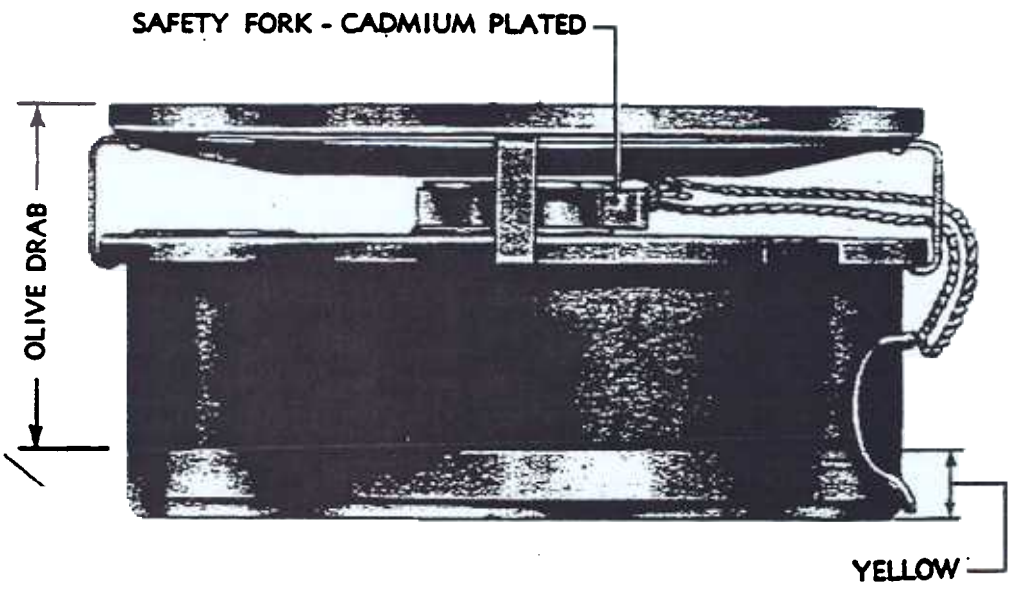
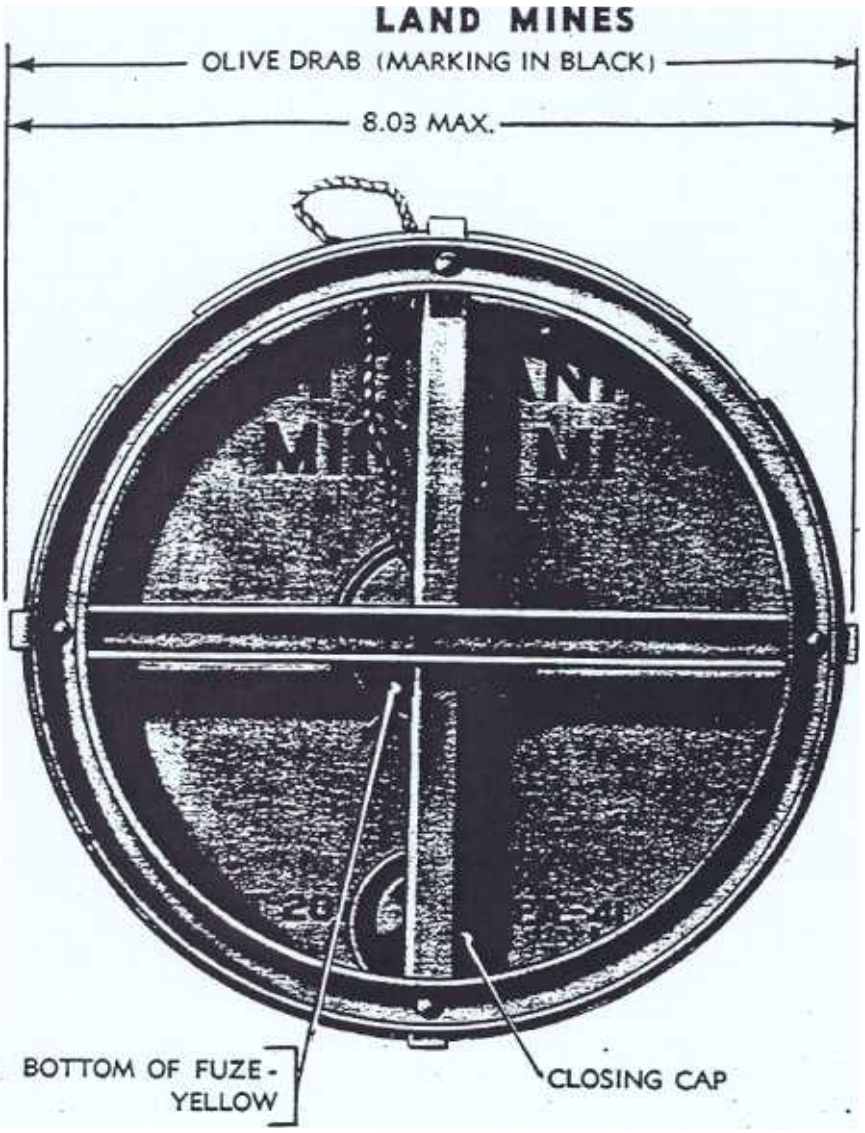
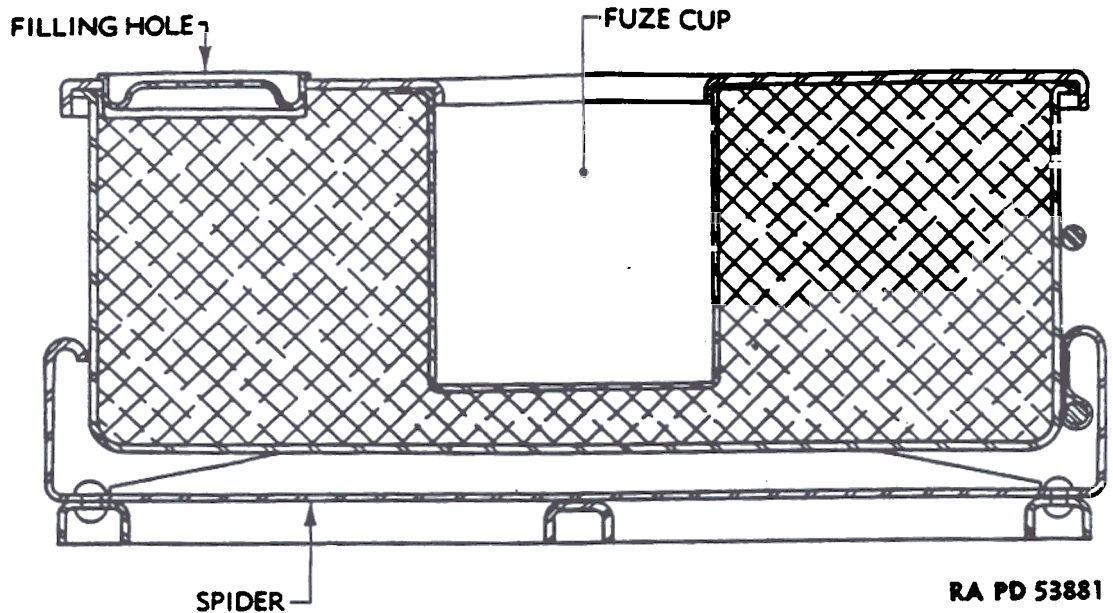

Figure 1 MINE, Antitank, H.E., M1, Fuzed

RA PD 53880A

10

ANTITANK MINES AND FUZES



Red 2 **Figure 2 — MINE, Antitank, H.E., M1, as Shipped**

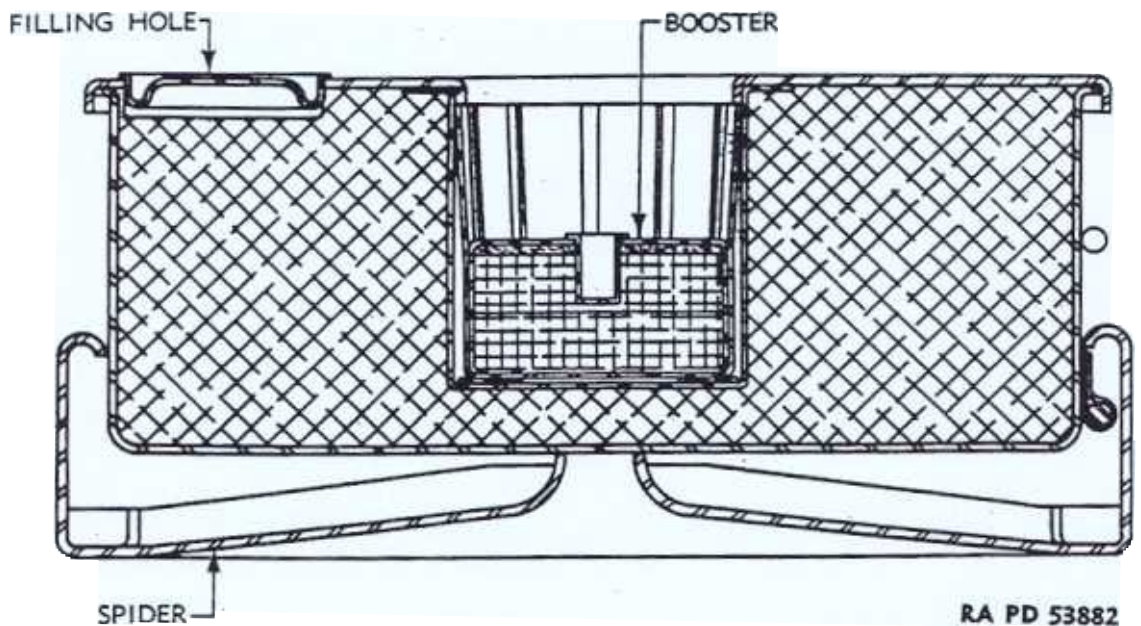

Figure 3 — MINE, Antitank, H.E., M1A1, as Shipped

other two hooks over the flange on the body; next press the first two hooks through the notches; then rotate the spider approximately one-eighth turn in either direction to secure the spider to the body.

(4) Plant mine.

see (5) Pull safety fork, thereby arming fuze. If the mine is buried spider down, the safety fork will have to be removed before the mine is buried. The safety fork should be left beside the mine attached to its cord, never between the body and the spider.

LAND MINES

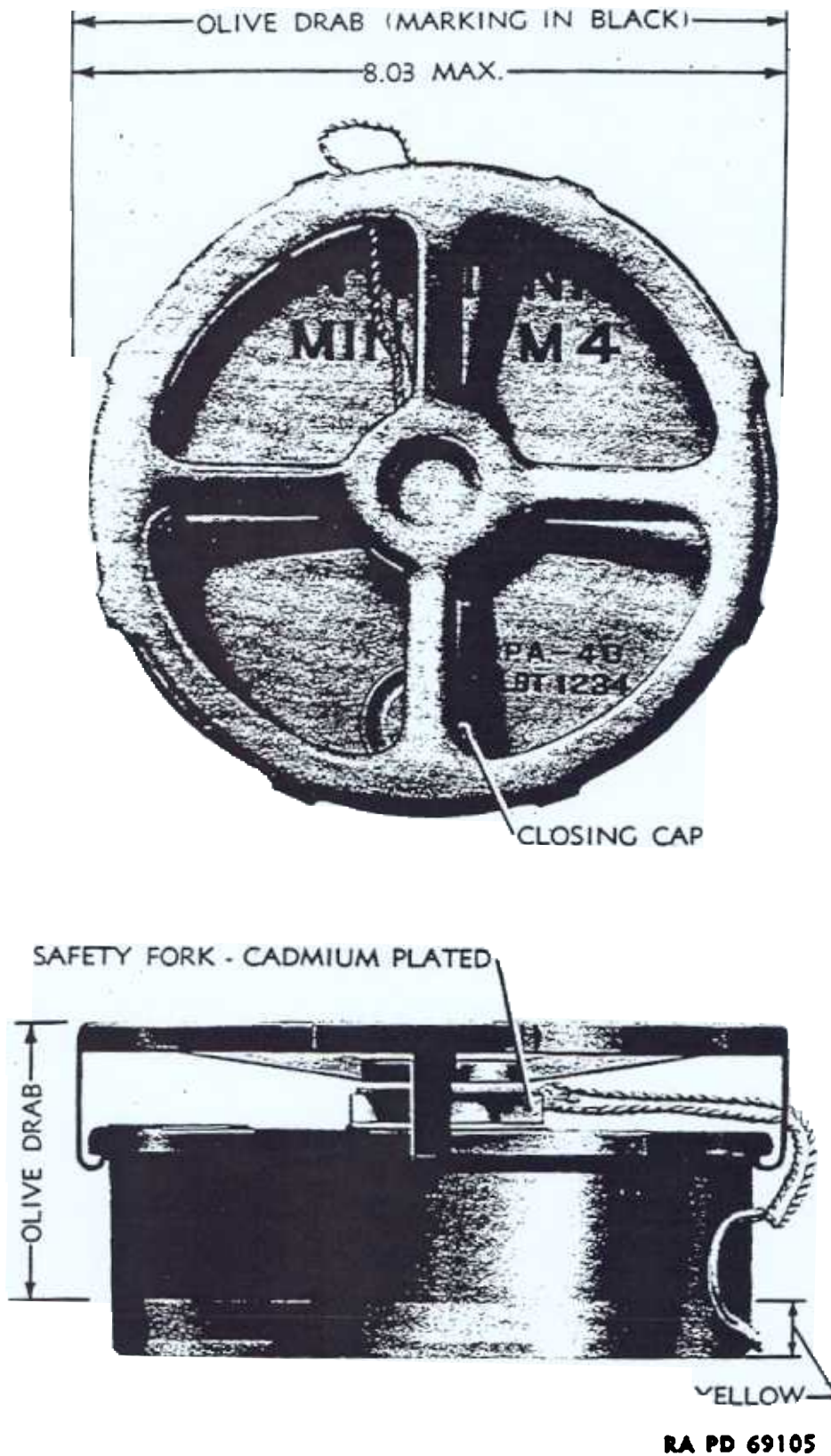

Figure 4 MINE, Antitank, H.E., M4.

ANTITANK MINES AND FUZES

d. Unfuzing. Mines may be disarmed and taken up by reversing the steps in subparagraph c, above.

see c1 — **e. Precautions.**

(1) The safety fork will not be removed except when it is intended to arm the fuze. The fork should not be removed until after the mine has been planted, unless the mine is planted spider down. Should the mine be taken up, the safety fork will first be replaced.

CAUTION: Care will be exercised that no undue load is accidentally brought to bear on the spider, especially the rim, after the safety fork has been removed. A load of approximately 250 pounds on the rim of the spider will actuate the firing mechanism. These figures refer to static loads; a sharp blow from a much smaller weight will operate the fuze. In the case of the M1, the fuze is a shear-pin type, hence a blow or series of blows, while not causing the fuze to operate, will nick the pins and make the fuze more sensitive so that it will operate from much lighter loads than those specified above.

(2) To prevent sympathetic detonation of part or all of a mine field, mines laid singly on the ground should be 3 feet or more apart; if planted flush, 2 feet or more apart. Should it be required to give a more powerful blast, the mines may be buried one on top of another, or side by side, planted flush, or laid on the surface. If planted flush, adjacent mines should be in contact; if laid on the surface, they may be as much as 18 inches apart. Such planting will insure that all mines in the group will detonate, when any one detonates. To prevent sympathetic detonation of part or all of the groups in a mine field, the distances given above should be correspondingly increased.

f. Packing. Antitank mines are packed five in a wooden box which also contains five fuzes. The box is made up with a set of plywood separators and two sets of grooves. As shipped, the fuzes are placed in a fuze container which occupies one compartment of the box; the five mines, with spiders nested to the bottoms, are packed, carrying ring up, one in each of the other five compartments. For convenience in carrying fuzed mines in the field, the same box, but with the partitions moved to the second set of grooves, may be used. The box with five high-explosive mines and fuzes weighs approximately 71 pounds.

see 41 — **g. Models.** MINE, antitank, H. E., M1, is the original model, which has since been modified. When assembled in complete round the Mine M1A1 is essentially the same as the M1. The difference lies in the method of issuing the components (compare figs. 2 and 3). In the case of the Mine M1 and Fuze M1, the booster is assembled as an integral part of the fuze, while in the case of the Mine M1A1, the booster is issued assembled in the fuze cup of the mine, the

LAND MINES

balance of the fuze being issued separately as the Fuze M1A2 (fig. 5). The Mine M4 (fig. 4) is similar to the Mine M1A1 except that there is no detonator cavity in the booster, as the detonator is incorporated in the body of the fuze (fig. 6), and the spider is the one-piece type (shown with the Practice Mine M1B1, fig. 8).

h. Painting. Antitank mines are painted as follows:

(1) The bottom and three-quarters of an inch of the side are painted yellow.

(2) The balance of the surface and the spider are painted lusterless olive-drab.

i. Marking. The top of the mine is marked in black with:

(1) Type and model of mine.

(2) Lot number.

(3) Manufacturer's initials or symbol.

(4) Date loaded.

11.1 see C1
12. PRACTICE ANTITANK MINES.

a. MINE, Antitank, Practice, M1.

(1) **GENERAL.** This mine with principal data and markings is shown as a complete round assembly in figure 7. The complete round consists of three components, an empty mine body, the spider, and a fuze.

(2) **BODY AND SPIDER.** These parts are similar in construction to the corresponding parts of the high-explosive mine except that the body has five 1-inch holes equally spaced around the side.

(3) **FUZES.** Fuzes are described in paragraph 14.

(4) **ASSEMBLY (FUZING AND ARMING).** The practice mine is assembled in the same manner as the service mine, described in paragraph 11 c.

(5) **DISASSEMBLY (DISARMING AND UNFUZING).** See paragraph 11 d.

(6) **PACKING AND MARKING.** Practice mines are packed in a box similar to that of the high-explosive mine, except that the fuze compartment is empty. Practice fuzes are issued in a separate packing. Practice mines are painted blue and marked in white.

b. MINE, Antitank, Practice, M1B1. This model is made of sheet metal and resembles the service mine except that the filling hole is in the bottom of the mine body. The mine is sand-filled to weight before it is issued for use in practice.

13. DUMMY ANTITANK MINES.

a. In contrast to other types of ammunition where "DUMMY" signifies drill ammunition, dummy antitank mines are defined as

ANTITANK MINES AND FUZES

simulated mines laid to deceive and confuse the enemy. They are improvised in the field as the situation requires.

14. ANTITANK MINE FUZES.

a. **FUZE, Mine, Antitank, H. E., M1.** This fuze, which contains the booster as an integral part, is used only in the High-explosive Mine M1. It consists essentially of a striker assembly and a body which contains the primer, detonator, and booster. The striker assembly, on the outer end of which is a 2-inch diameter head, protrudes approximately $\frac{3}{8}$ inch beyond the body of the fuze. The firing mechanism, contained within the striker assembly, is restrained from firing when in the armed condition (safety fork withdrawn) by the collar just below the head and two shear pins. A force of approximately 500 pounds on the striker head is required to actuate the firing mechanism. A weight of 10 pounds dropped 24 inches will operate the fuze. When the fuze is assembled to the mine with the spider in place, these figures are materially reduced. For safety in shipping and handling, a safety fork, attached to the striker head by a cord, is fitted over the collar between the striker head and the top of the fuze body. The safety fork will not be removed except when it is intended to arm the fuze. The striker head of the fuze is painted yellow and the side is marked in black with:

- (1) Designation of the fuze.
- (2) Loader's lot number.
- (3) Loader's initials.
- (4) Date loaded.

NOTE: When not packed with the mine, this fuze is packed 100 per box.

b. **FUZE, Mine, Antitank, H. E., M1A1.** This fuze differs from the M1, described above, in that the booster forms a separate assembly and is assembled to the mine body as issued. The detonator assembly protrudes from the bottom of the fuze. Upon assembly of the complete round, the detonator enters a mating cavity in the booster.

c. **FUZE, Mine, Antitank, H. E., M1A2.** This fuze (fig. 5) is identical in outward appearance to the Fuze M1A1. The detonator is more powerful to insure a high order explosion.

d. **FUZE, Mine, Antitank, H. E., M4.** This fuze (fig. 6) functions on the "cricket" or "oilcan" principle. This means that the firing pin spring consists of a convex metal diaphragm, which when depressed under a weight of approximately 500 pounds, snaps downward with sufficient force to detonate the fuze. The detonator is assembled within the body of the fuze.

LAND MINES

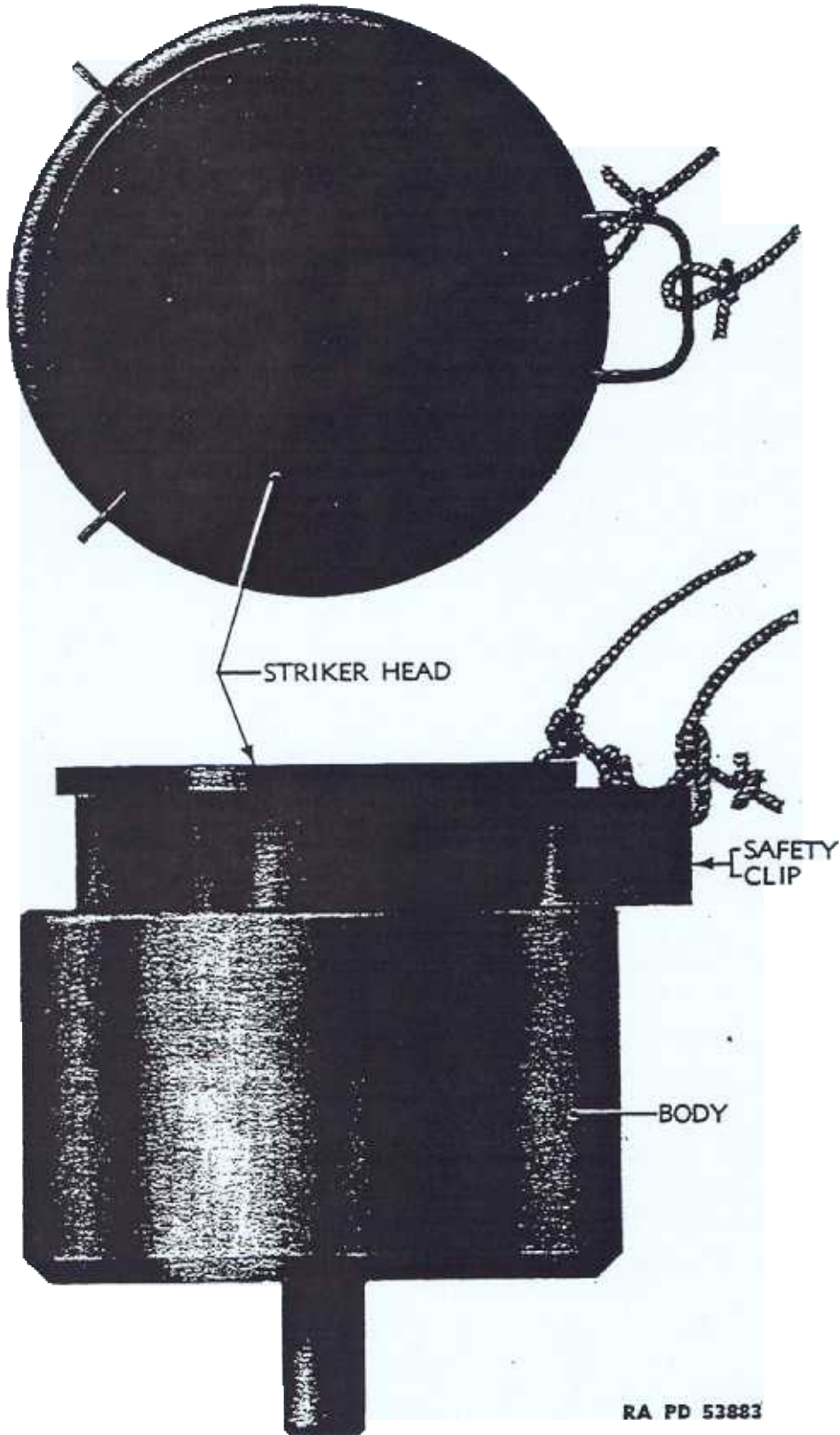

RA PD 53883

Figure 5 FUZE, Mine, Antitank, H.E., M1A2

ANTITANK MINES AND FUZES

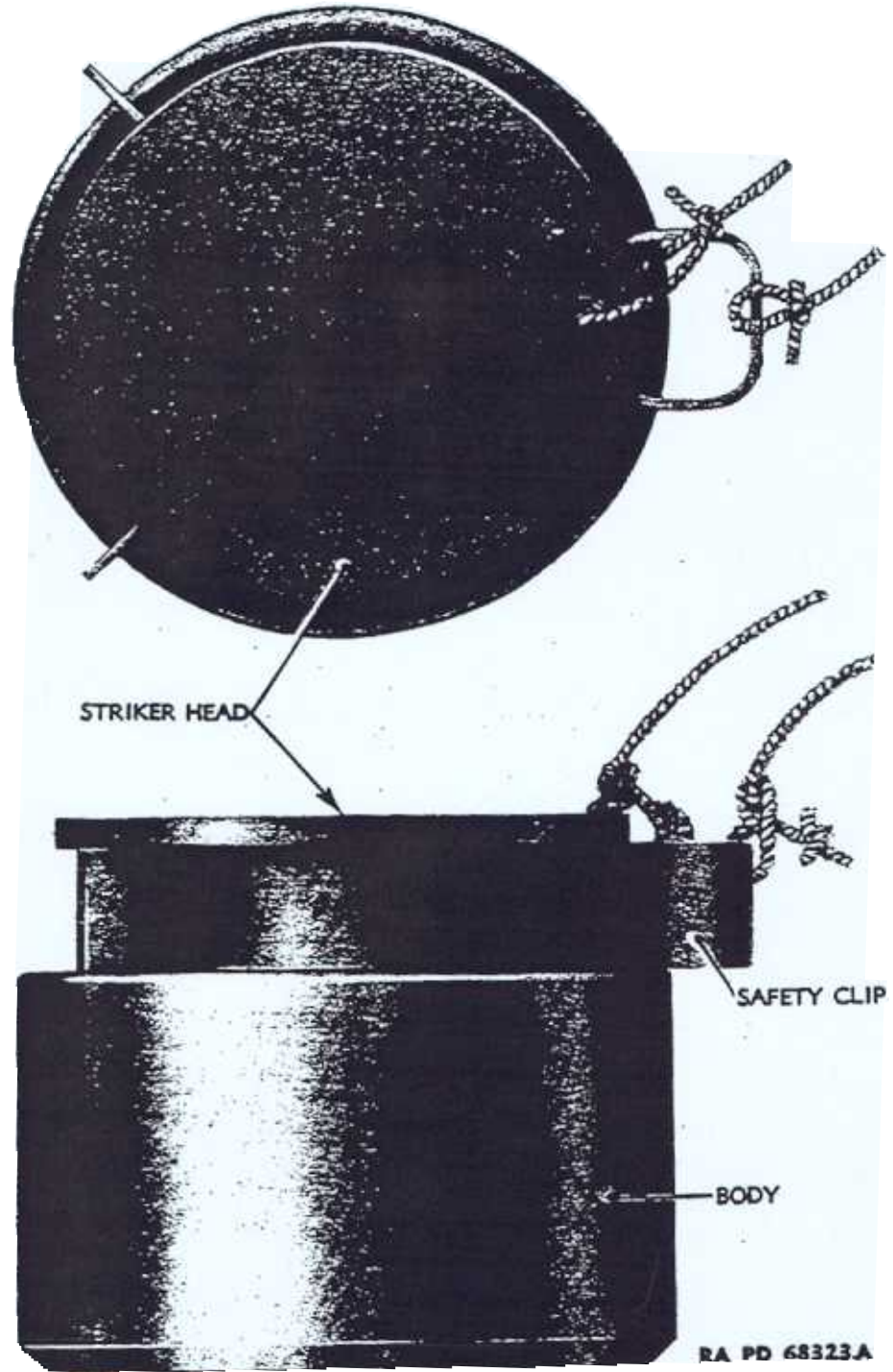
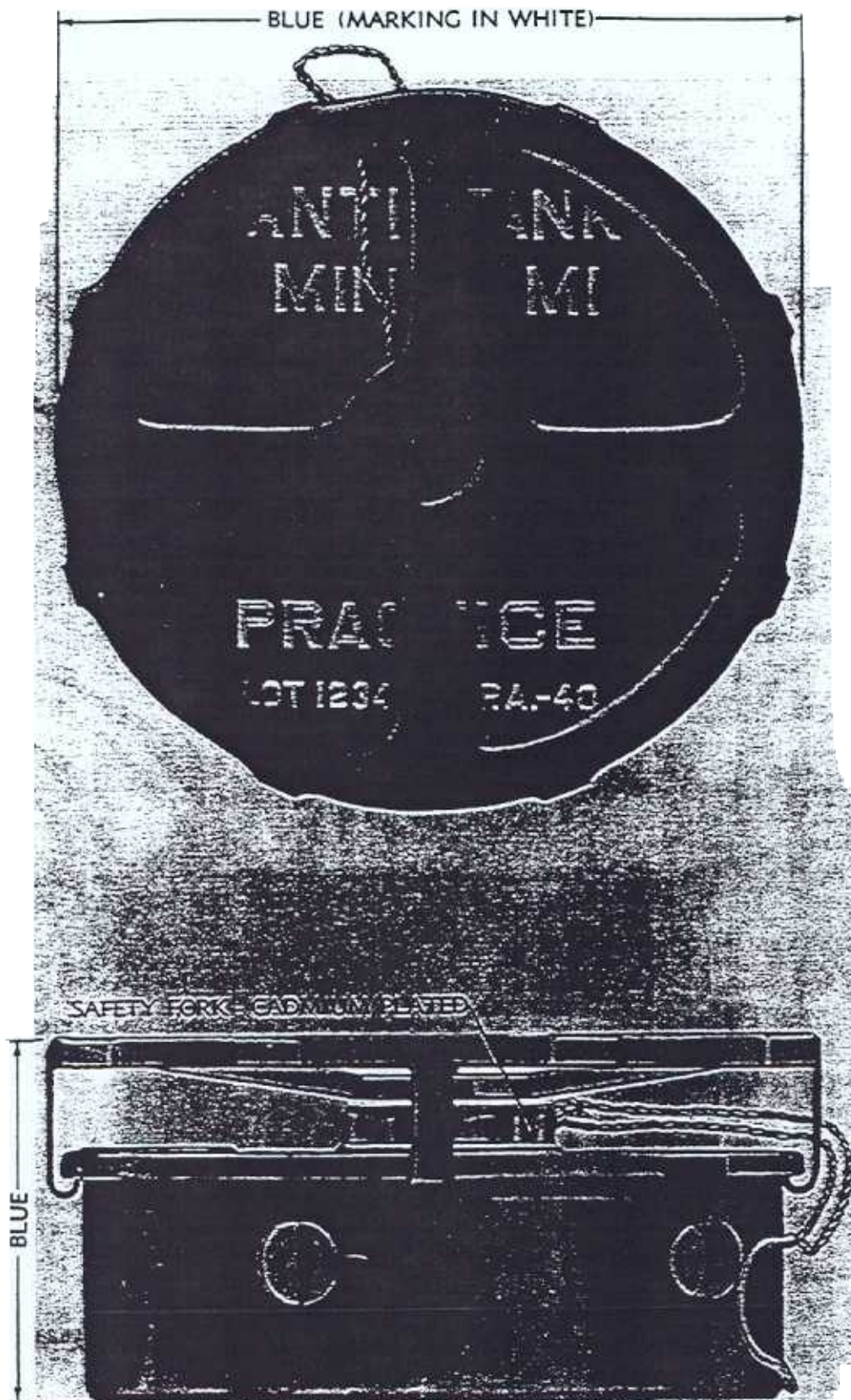

Figure FUZE, Mine Antitank, H.E., M4
17

LAND MIN



RA PD 13884A

Figure 7 MINE Antitank, Practice, M1

ANTITANK MINES AND FUZES

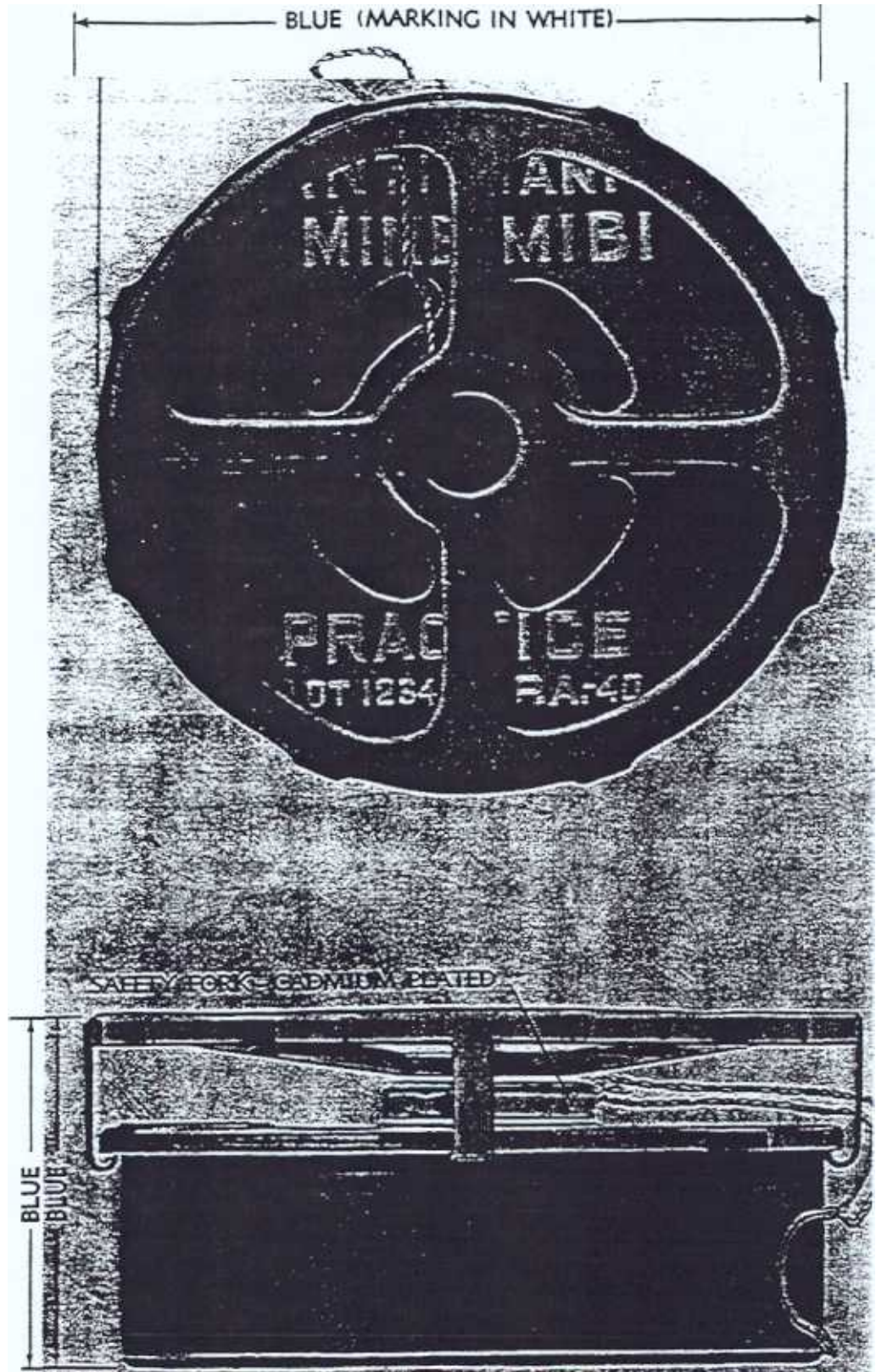

RA PD 69104

Figure 8 MINE, Antitank, Practice, M1B1

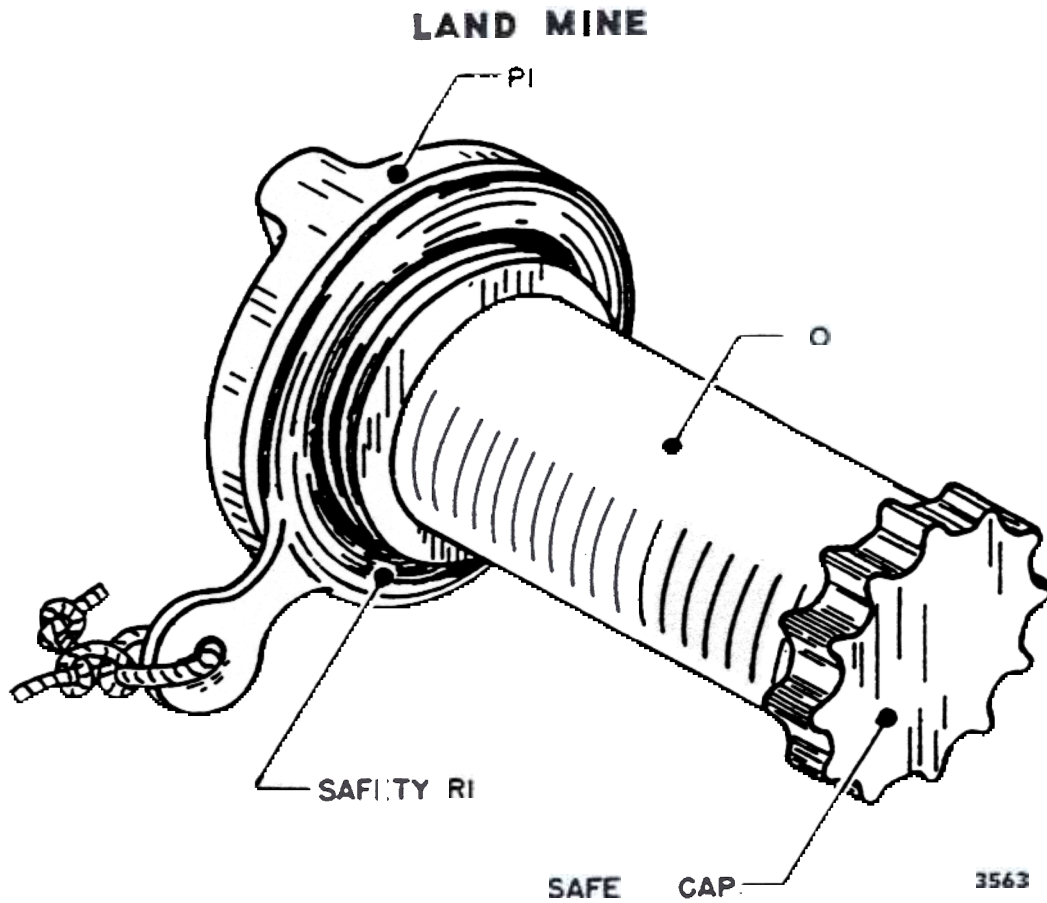

Figure 9 FUZE, Mine Antitank, Che ica M5

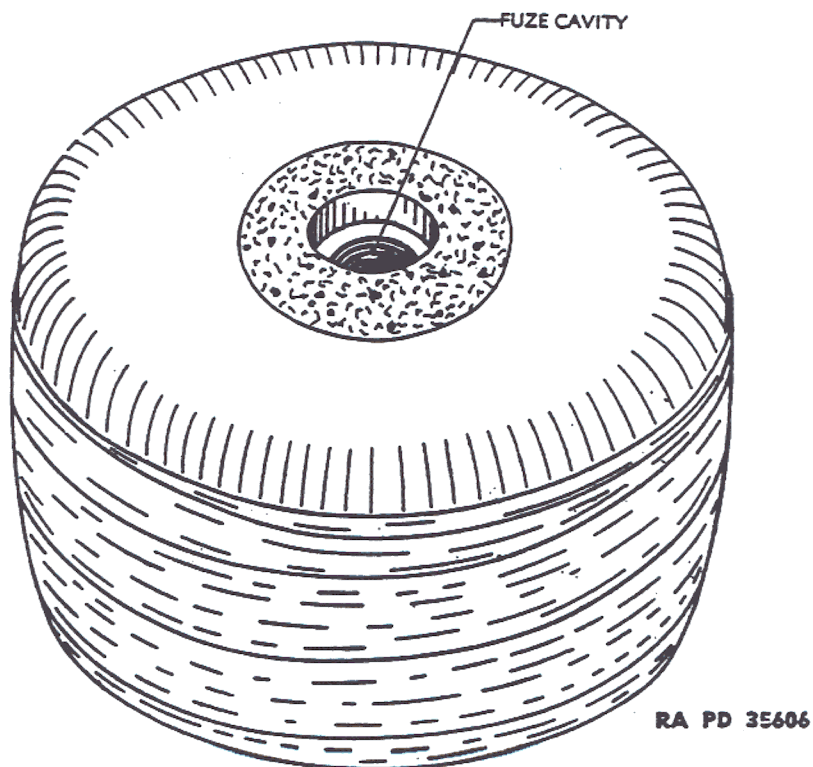

Figure 1 MINE, Antitank, Nonmetallic. H.E M5

ANTITANK MINES AND FUZES

e. Practice Fuzes.

(1) FUZE, MINE, ANTITANK, PRACTICE, M1. This fuze is similar in form and operation to FUZE, mine, antitank, H. E., M1 described above, except that it contains a smoke-puff charge in place of the booster element.

(2) FUZE, DUMMY (PRACTICE ANTITANK MINE). This item of drill ammunition is completely inert. It is made of metal or plastic to simulate the Service Fuze M1 and has a removable safety fork.

(3) These fuzes are used with the practice mine body for training and practice.

M. 1 see C 1

15. MINE, ANTITANK, NONMETALLIC, H. E., M5, AND FUZE, MINE, ANTITANK, CHEMICAL, M5.

a. General. This round (figs. 9 and 10) is manufactured without the use of materials which would betray its presence to an enemy using an electromagnetic mine detector. The mine body consists of a ceramic bowl containing 5.6 pounds of high explosive and a ceramic plate which acts as the spider. These components are separated by a cushion of rubber or similar material and enclosed in a hard paper container. There is a threaded opening in the top of the mine for assembly of the fuze and a bakelite plug, in the bottom, which may be removed for the attachment of an antiremoval device. Because of its construction, this mine may be buried without fear of stones or dirt jamming the firing mechanism and, being waterproof, it may be installed under water or in swampy ground. The fuze consists of a cylindrical body attached to a threaded plug. Instead of a metal safety pin, a bakelite cap is screwed on the base of the fuze body. This cap must be removed before the fuze can be assembled to the mine. In addition to this safety cap, which restrains the firing pin, there is a safety ring around the fuze body against the flange of the plug, which prevents the fuze being screwed home into functioning position in the mine.

b. Fuzing.

(1) The mine may be fuzed by the following steps. NOTE: The outer hard paper container of the mine body will be left in place.

(a) Remove the adhesive cover of the fuze cavity and examine the cavity to insure that it is free of all foreign material.

(b) Examine the fuze to insure that it is serviceable and that the safety ring and safety cap are in place.

(c) Remove the safety cap.

(d) Insert the fuze, with safety ring in place, into the mine and screw down handtight.

(e) Plant the mine.

LAND MINES

(f) Remove the safety ring. If necessary, back the fuze out one turn.

(g) Screw the fuze in handtight in a *clockwise* direction.

c. **Unfuzing.** The mine may be taken up by reversing the steps in subparagraph b, above.

d. **Antiremoval Devices.** Any of the firing devices described in section V may be attached to this mine by removing the plastic plug in the bottom of the mine and attaching as described in the paragraph on the device used. It should be borne in mind, however, that the use of a metallic firing device tends to defeat the purpose of designing this mine and fuze with no metal parts.

e. **Precautions.** In addition to the general precautions to be observed in handling antitank mines and fuzes, care should be exercised in arming the mine to screw the fuze in *no more than handtight* and, when taking up the mine, to turn the fuze in a *counterclockwise* direction.

f. **Marking.** MINE, antitank, nonmetallic, H. E., M5, is painted lusterless olive-drab and marked in yellow.

g. **Packing.** MINE, antitank, nonmetallic, H. E., M5, and FUZE, mine, antitank, chemical, M5, are packed four of each to the box (par. 8).

Section IV

ANTIPERSONNEL MINES

	Paragraph
General	16
MINE, antipersonnel, M2	17
MINE, antipersonnel, M3	18
TORPEDO, bangalore, M1	19
Demolition materials	20
Blocks, demolition, chain, M1	21
Demolition blocks	22

16. GENERAL.

a. All antipersonnel mines depend for initiation upon some action of the enemy. In general, as enemy personnel will not have the restrictions of vision that are imposed upon the driver of an armored vehicle, it is important that full advantage be taken of every opportunity for concealment. Therefore, antipersonnel mines and firing mechanisms used therewith will receive special attention to the maintenance of the neutral color and finish.

b. In addition to standardized antipersonnel mines, this section also describes other items of demolition material from which antitank or antipersonnel mines may be improvised. Firing mechanisms are described in section V.

see 21

17. MINE, ANTIPERSONNEL, M2.

a. MINE, antipersonnel, M2 (figs. 11 and 12), is similar to a small mortar. It projects a shell about 6 feet in the air, where it explodes. Designed for use against personnel, it has an effective radius of about 30 feet. The shell weighs approximately 3 pounds, of which 12 percent is high explosive. The shell fuze, which is ignited by the propelling charge, contains a delay element that delays detonation of the shell until it has attained an effective height. This mine is fired by the action of a pull wire or a pressure device.

b. Description.

(1) The mine (figs. 11 and 12) consists of a base plate, a length of thin-walled steel tubing riveted (M2) or soldered (M2A1) to the base plate and serving to contain and project the loaded and fuze shell, and a 1/4-inch pipe nipple, threaded to the base plate and serving as a connection for the firing mechanism. The cavity in the base plate contains the propelling charge, which consists of 20 grains of black powder assembled in a small bag. The tube, containing the fuze shell, is sealed with a metal cap. Attached to the pipe nipple is a coupling into which is fitted the primer and igniter assembly. The primer is protected during handling and shipment by a hex-

LAND MINES

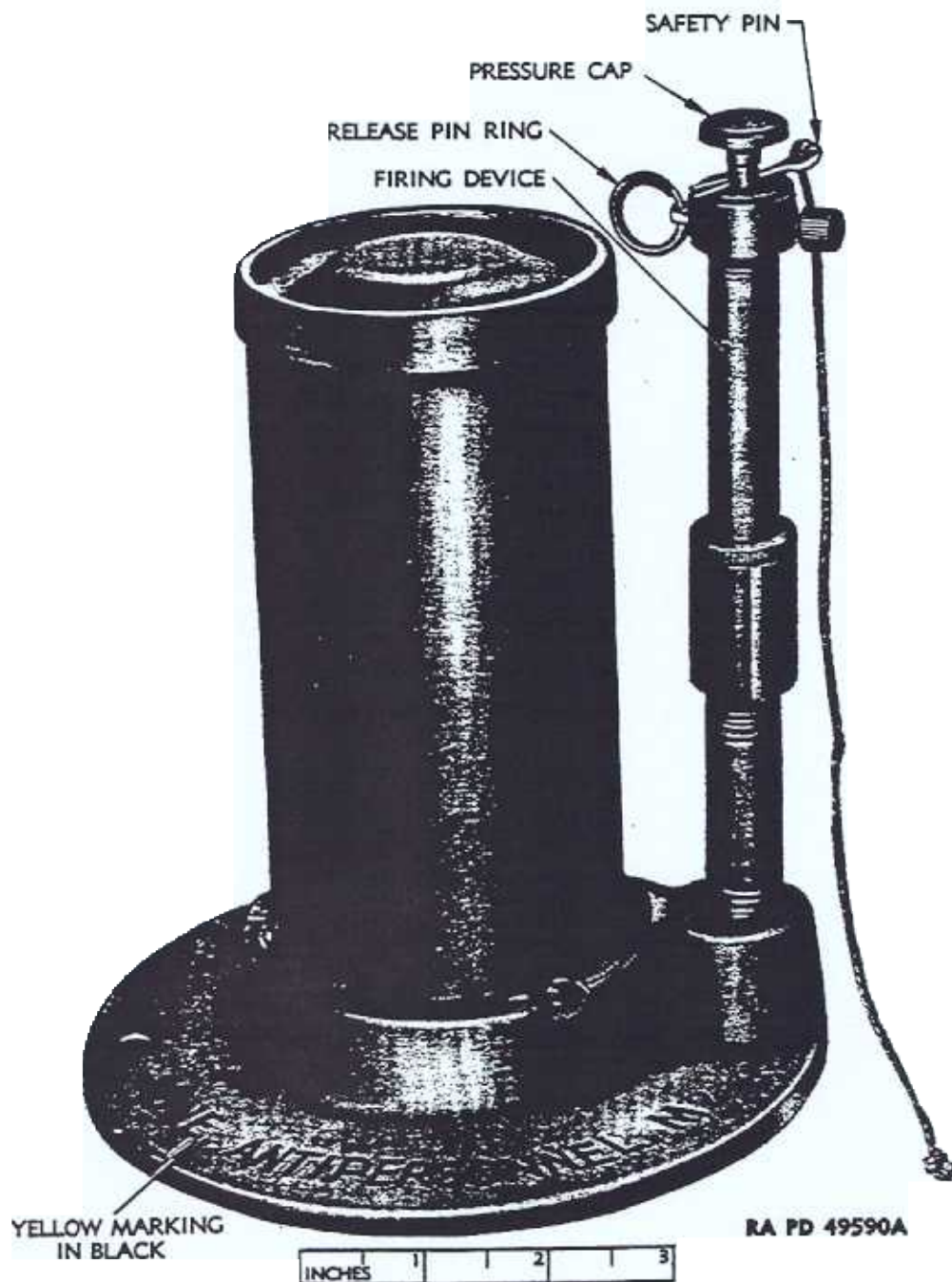
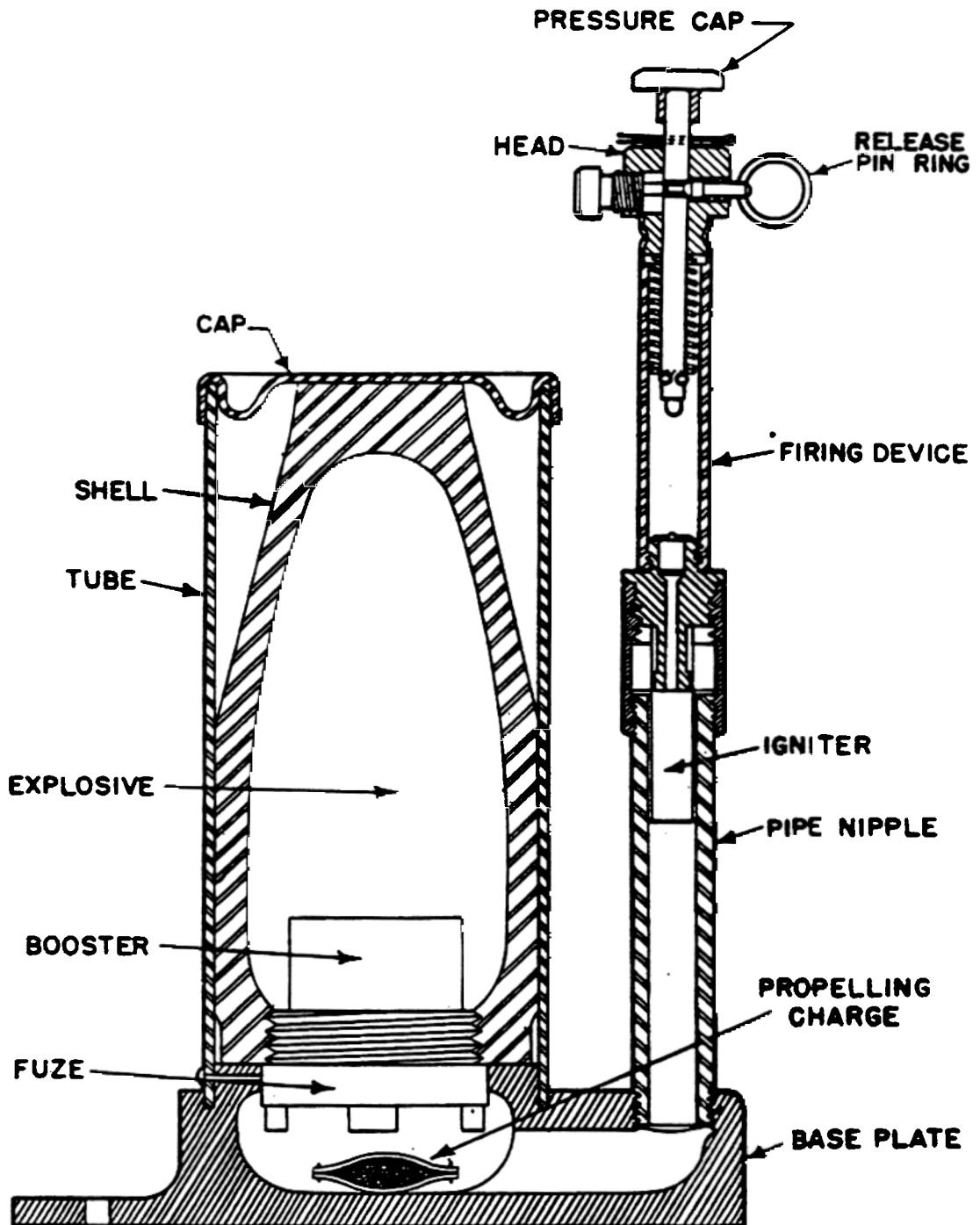

Figure 11 MINE, Antipersonnel, M2

ANTIPERSONNEL MINES



RA PD 49598C

Figure 12 — MINE, Antipersonnel, M2A1

LAND MINES

agonal cap. FUZE, mine, antipersonnel, M2, is shipped separately in a tube, in the same box with the mine.

(2) The fuze issued with this mine consists of the Combination Firing Device M1 (par. 24) with an igniter cap attached. The base and igniter are assembled to the mine and the firing pin assembly is supplied, disassembled, in the same carton. It is a simple type firing mechanism containing a spring-loaded firing pin. It may be fired by means of a trip wire connected to the release pin ring or by pressure applied to the pressure cap (fig. 11). A pressure of 20 to 40 pounds on the pressure cap or tension of 3 to 6 pounds on the release pin will cause release of the firing pin and detonation of the mine. Lengths of wire packed with the mines are for connecting to the release pin ring and making tripping devices. The wire supplied with some mines is olive-drab; that supplied with others is sand colored.

c. Operation. To assemble the mine, remove the hexagonal cap from the primer and, after making sure that the locking screw and safety pin are in place, screw the firing pin assembly onto the primer.

(1) **TO PLANT OR PREPARE FOR ACTION** (par. 24 c).

(a) Be sure the locking screw and safety pin are in place.

(b) Place the mine on a firm foundation.

(c) Remove the hexagonal cap from the primer and screw on the firing pin assembly.

(d) Attach trip wire or install the pressure trip on the pressure cap.

(e) Check to see that the trip wire is not too tight or that there is not too much weight on the pressure cap.

(f) Remove the locking screw.

(g) Remove the safety pin. If the safety pin tends to bind, the device is unsafe and should not be used.

(h) *Special Safety Precaution.* This device may fire if the release pin is rotated after the locking screw is loosened or removed and the safety pin is removed. Do not adjust the position of the release pin unless the safety pin and locking screw are securely in place.

(2) **TO PICK UP OR RECOVER.**

(a) Replace safety pin and screw the locking screw in place.

(b) Cut the trip wire or remove the pressure tripping device from the pressure cap.

(c) Take up the mine.

(d) Remove fuze, screw on the hexagonal cap, and return the mine and components to original packing.

d. Precautions.

(1) No attempt will be made to disassemble the mine (except to

ANTIPERSONNEL MINES

remove the firing pin assembly when the mine is picked up). Mines with loose caps or primers will not be used until inspection by ordnance personnel shows that the igniter and propelling charge have not been damaged by moisture, and the mine cap and primer assembly have been resealed.

(2) When mines are being planted, place the hexagonal cap from the primer and the locking screw and safety cotter pin near the body of the mine, in a position where they may be readily found if it is necessary to pick up or recover the mines.

(3) While this mine is water resistant, it should not be expected to function after prolonged submergence in water.

e. Marking and Packing.

(1) The mine and the fuze are painted lusterless olive-drab, except for the flange of the mine base, which is painted yellow. Stenciled on the flange is the type and model of the mine, the lot number, manufacturer's symbol, and date of loading.

(2) The mine is packed one per corrugated paper carton. The carton also contains the firing pin assembly and 1 spool of four 26-foot lengths of wire. Ten such containers are packed in a wooden box. The boxes are marked "OLIVE DRAB" or "SAND COLOR" to indicate the color of the wire packed therein (par. 8).

see C1

18. MINE, ANTIPERSONNEL, M3.

see C1

a. General. The MINE, antipersonnel, M3, is a fragmentation type of land mine intended primarily for use against personnel. The complete round consists of the mine, a hollow cast-iron block containing TNT, and FUZE, mine, antipersonnel, M3. It has an effective radius against personnel of 10 yards when fired at the surface of the ground. The effective radius is slightly increased when the mine is used several feet above ground level, and is decreased when the mine is buried in the ground. Fragments of the mine may be thrown more than 100 yards and suitable protection should be provided for friendly personnel within this radius.

b. Description.

(1) The MINE, antipersonnel, M3, is shown with principal dimensions in figure 13. The cast-iron casing is filled with a 0.90-pound charge of flaked TNT. In two opposite sides and one end, there are holes below which are cap wells. Any one of these holes may be used. As shipped, the holes are closed with plastic plugs. In the end opposite the well is a filling hole which is closed with a metal disk.

(2) FUZE, mine, antipersonnel, M3 (fig. 14), consists of a special blasting cap (U. S. Army blasting cap, type A) crimped to the Combination Firing Device M1 (par. 24) for use with this mine. The firing device contains a spring-loaded firing pin and a primer.

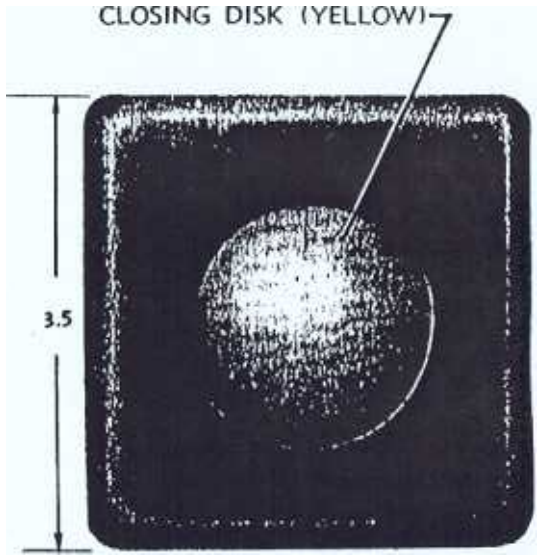
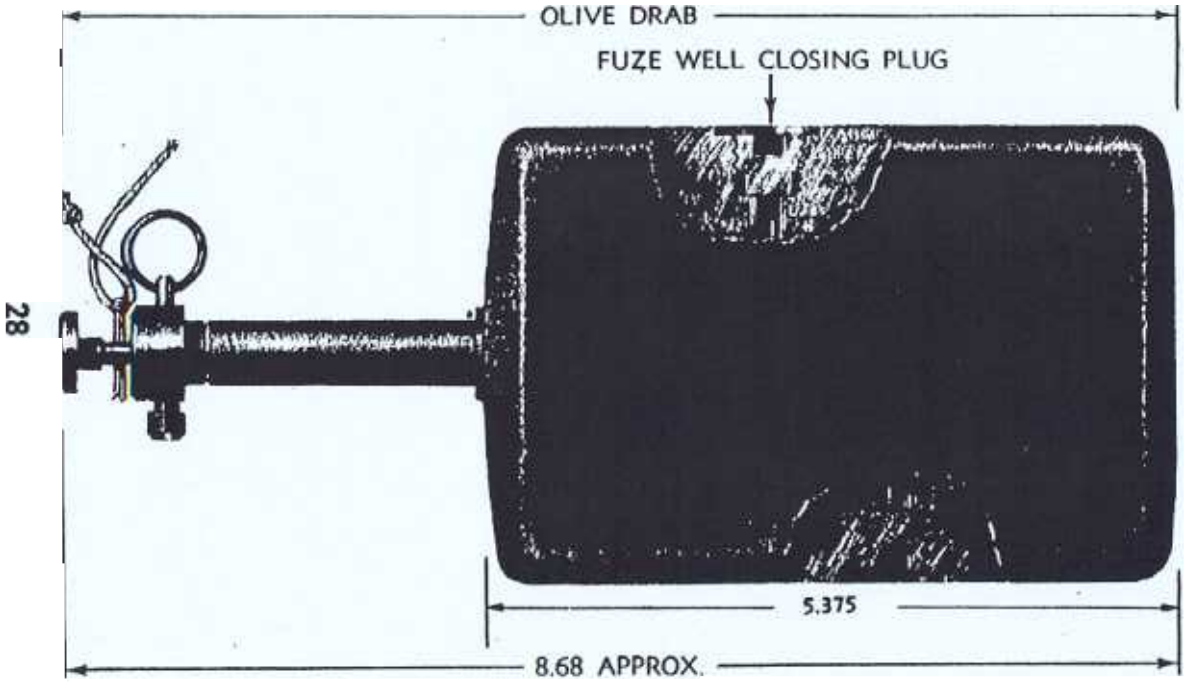

LAND MINES

RA PD 49595

Figure 13 — MINE, Antipersonnel, M3, Complete

ANTIPERSONNEL MINES

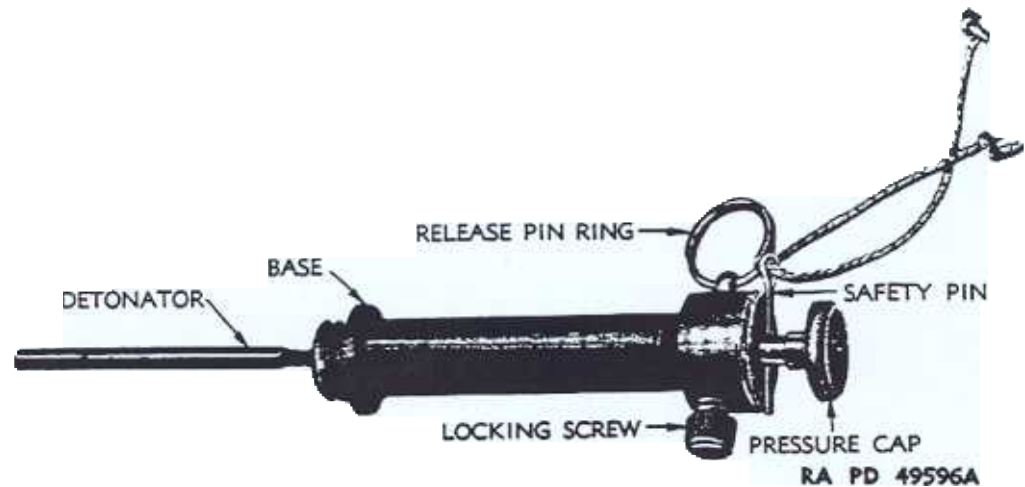

Figure 14 — FUZE, Mine, Antipersonnel, M3

It may be fired by means of a cord or wire connected to the release pin ring, or by pressure applied to the pressure cap. A pressure of 20 to 40 pounds on the pressure cap, or a tension of 3 to 6 pounds on the release pin, will release the firing pin and detonate the primer. Wire is furnished for connecting to the pull ring for making tripping devices. A safety pin located in a hole in the firing pin, and a locking screw bearing on a groove in the firing pin, protect the firing device from accidental functioning during shipping and handling. The firing device is issued unassembled to the mine.

c. Operation. To assemble the mine, it is only necessary to remove the closing plug from the desired fuze hole and to screw in the firing device firmly. Be sure that the well is clear of foreign material and that the detonator enters freely.

(1) **TO PLANT OR PREPARE FOR ACTION** (par. 24 c).

(a) Remove the closing plug. Use the wrench packed with the mines.

(b) Assemble the fuze to the mine.

(c) Attach a trip wire to the release pin ring, or install a pressure trip on the pressure cap.

(d) Check to see that the trip wire is not too tight, or that there is not too much weight on the pressure cap.

(e) Remove the locking screw and safety pin. If the safety pin tends to bind, the fuze is unsafe and should not be used.

(f) **Special Safety Precaution.** This device may fire if the release pin is rotated after the locking screw is loosened or removed, and the safety pin is removed. Do not adjust the position of the release pin unless the safety pin and locking screw are securely in place.

LAND MINES

(2) TO PICK UP OR RECOVER.

- (a) Replace the safety pin and screw the locking screw in place.
- (b) Cut the trip wire or remove the pressure tripping device from the pressure trip.
- (c) Take up the mine.
- (d) Remove the fuze from the mine and replace the closing plug.
- (e) Repack the components in their original packing. The fiber case in which the fuze is packed should be resealed.

d. Precautions.

(1) No attempt will be made to disassemble the mine or components, except to remove or replace the fuze hole closing plug and assemble or remove the fuze.

(2) Do not remove the locking screw or safety pin from the fuze until the mine is placed and the installation is checked to see that there is not too much tension on the pull ring, or too much pressure on the pressure cap.

(3) Protect the fuze from shock, heat, and friction.

(4) When the mines are being planted, place the fuze hole plug, locking screw, and the safety pin in a position where they may be readily found if necessary to pick up and recover the mines.

(5) Exposure to moisture will not affect the operation of the mine. However, the mine is not waterproof, and should not be planted in positions where it will be immersed in water for more than a few days.

e. Marking and Packing.

(1) **MARKING.** The mine body and the fuze are painted olive-drab with markings in black. On one side are marked the type and model of the mine, metal parts manufacturer's lot number, and date of manufacture. The opposite side is marked with the type and model, loader's lot number, and date of loading. The closing disk is painted yellow.

(2) **PACKING.** Six mines are packed in a wooden packing case, which also contains six fuzes. The fuzes are packed in sealed cylindrical fiber containers which, in turn, are packed in compartments in one end of the packing box. Packed in the box is a small wrench which fits the square holes in the plastic plugs in the mine and is used for unscrewing them prior to assembling the fuzes. Six spools of wire for making tripping devices are also packed in the box. Each spool has four 26-foot lengths of wire. The boxes are marked "OLIVE DRAB" or "SAND COLOR" to indicate the color of the wire packed therein (par. 8).

ANTIPERSONNEL MINES**19. TORPEDO, BANGALORE, M1.****a. Description.**

(1) The bangalore torpedo (fig. 15) is a tube or pipe filled with high explosive, primarily used for blasting an opening through wire entanglements or for clearing mine fields. The TORPEDO, bangalore, M1, consists of a steel tube 5 feet in length and $2\frac{1}{8}$ inches in diameter which is grooved and capped at each end. The tube is filled with amatol, with about 4 inches of TNT at each end. The weight of explosive charge is about 9 pounds. Each end of the tube is capped and contains a recess or well to accommodate a detonator or blasting cap attached to any of the standard firing devices described in section V. A nose sleeve which fits on the end of the torpedo, and connecting sleeves for assembling the torpedoes in multiple lengths, are provided. The torpedoes and accessories are painted lusterless olive-drab.

(2) In addition to clearing wire entanglements and mine fields, this torpedo may also be used as an antitank mine or antipersonnel mine. Because of its high percentage of explosive charge, it may also be used for demolition purposes.

b. Components and Accessories. The following parts are used for detonating the torpedoes or placing them in multiple assembly.

(1) DETONATOR.

(a) Electric or nonelectric blasting cap may be used to detonate the torpedo. If commercial blasting caps are used, a combination (tetryl) defonator, equivalent to a No. 8, or stronger, blasting cap should be used.

(b) Primacord may be used by inserting primacord in the well and wedging it in place.

(2) **NOSE SLEEVE.** This is a rounded point which fits over the end of a torpedo (fig. 15). It contains a single clip which holds it in place. The nose sleeve is provided for ease in pushing the torpedo through obstacles such as heavy brush or barbed wire. It is not necessary for the proper functioning of the torpedo.

(3) **CONNECTING SLEEVE.** The connecting sleeve (fig. 15) is a short tube into which the ends of two torpedo tubes will fit and be held by three spring clips. It is used when assembling the torpedoes in multiple lengths.

c. Assembly. The sleeves and torpedo are alined and forced together until the spring clips on the sleeve snap into the groove on the end of the torpedo.

(1) **ASSEMBLY IN MULTIPLE LENGTHS.** To assemble in multiple lengths, fit a nose sleeve over the leading end of the torpedo. Then fit a connecting sleeve on the other end and fit another torpedo into

LAND MINES

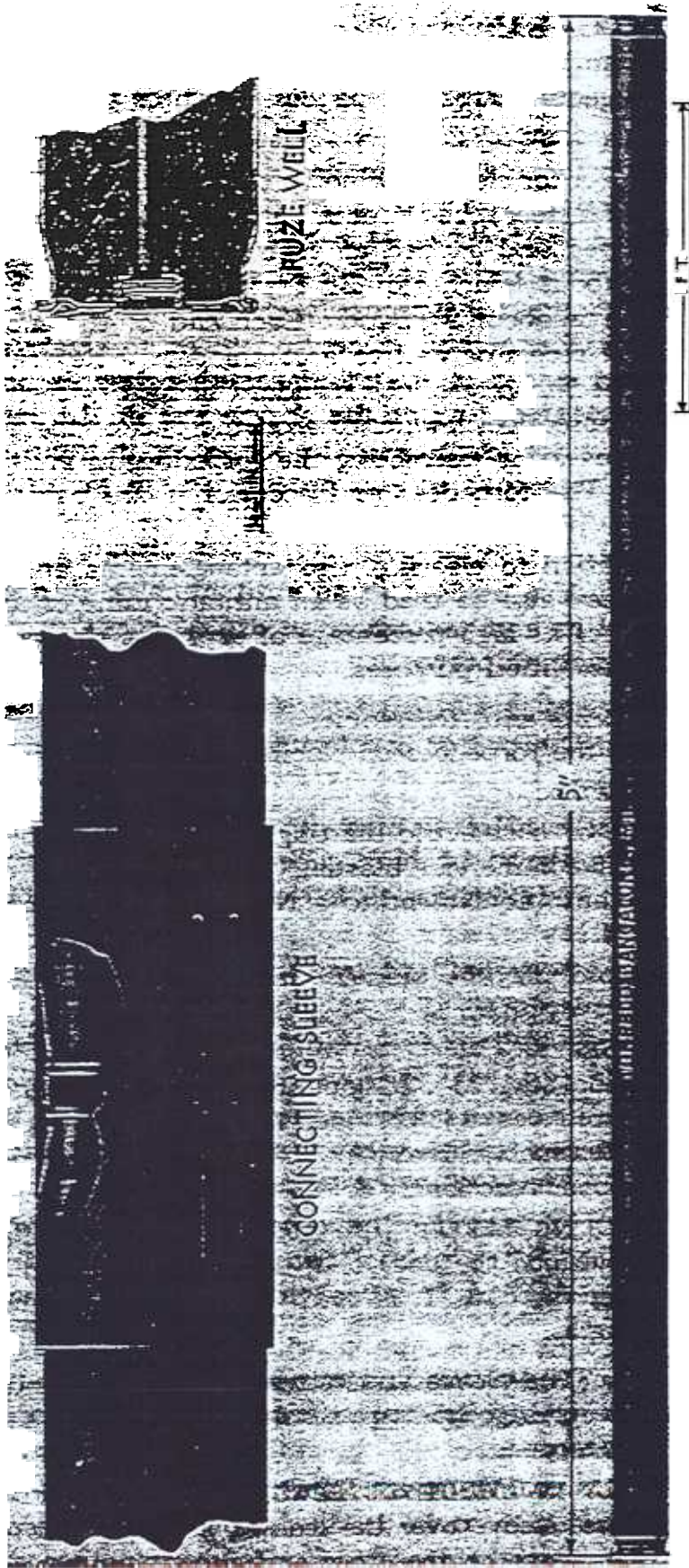

Figure 15 — TORPEDO, Bangalore, M1

ANTIPERSONNEL MINES

the sleeve. Add additional sleeves and torpedoes until the desired length is obtained. One detonator in the cap well at the end will detonate the entire line of torpedoes.

d. **Packing.** TORPEDO, bangalore, M1, is packed 10 in a box, which also contains 10 connecting sleeves, and 1 nose sleeve (par. 8).

20. DEMOLITION MATERIALS.

a. **Explosives.** Half- and quarter-pound blocks of compressed TNT and nitrostarch, respectively, are supplied for demolitions and like purposes. These may be used either by themselves with any of the firing mechanisms (sec. V) equipped with a detonator, or may be used to augment any of the mines described herein.

NOTE: Nitrostarch is more sensitive than TNT, consequently nitrostarch blocks will not be crushed or broken.

b. **Primacord.** Primacord consists of a flexible tube filled with high explosive. It is ordinarily used to transmit a detonation from a blasting cap to a charge of high explosive or from one charge of high explosive to another without requiring the use of a second cap. In addition to its function of transmitting a detonation, primacord contains enough high explosive so that it may be used as the main charge of a booby trap by making a flat coil about 3 inches in diameter of 12 to 20 feet of primacord and taping nails, empty cartridge cases, or other metal fragments around it.

21. BLOCKS, DEMOLITION, CHAIN, M1.

a. **General.** BLOCKS, demolition, chain, M1, assembly (figs. 16 and 17), consists of eight 2- by 2- by 11-inch blocks of tetrytol strung on a 16-foot length of primacord (par. 20 b) and packed in a haversack. The assembly is provided primarily for demolition purposes and is designed for ease in use and handling. The entire chain, or any part of the chain, may be used laid out in a line, wrapped around an object, or as packed in the haversack.

b. **Description.** Each block is rectangular in shape and is enclosed in a crinkle kraft paper bag. Printed on the bag in at least one place, is the designation: "DEMOLITION BLOCKS, M1 (TETRYTOL). MUST BE DETONATED BY CORPS OF ENGINEERS, U. S. ARMY, BLASTING CAP. ONE BLOCK - SIX ½-LB. TNT BLOCKS." The blocks are cast in place on the primacord with 8 inches between blocks and 2 feet of primacord free at each end. They consist of tetrytol, which is 75 percent tetryl and 25 percent TNT, with a cylindrical pellet of tetryl cast in each end of each block. The dimensions of the haversack are approximately 12½ by 9 by 4½ inches, and its weight, packed, is 22.5 pounds.

c. **Characteristics.** Tetrytol is more powerful and more brisant than TNT: hence these blocks are more effective in cutting steel

LAND MINES

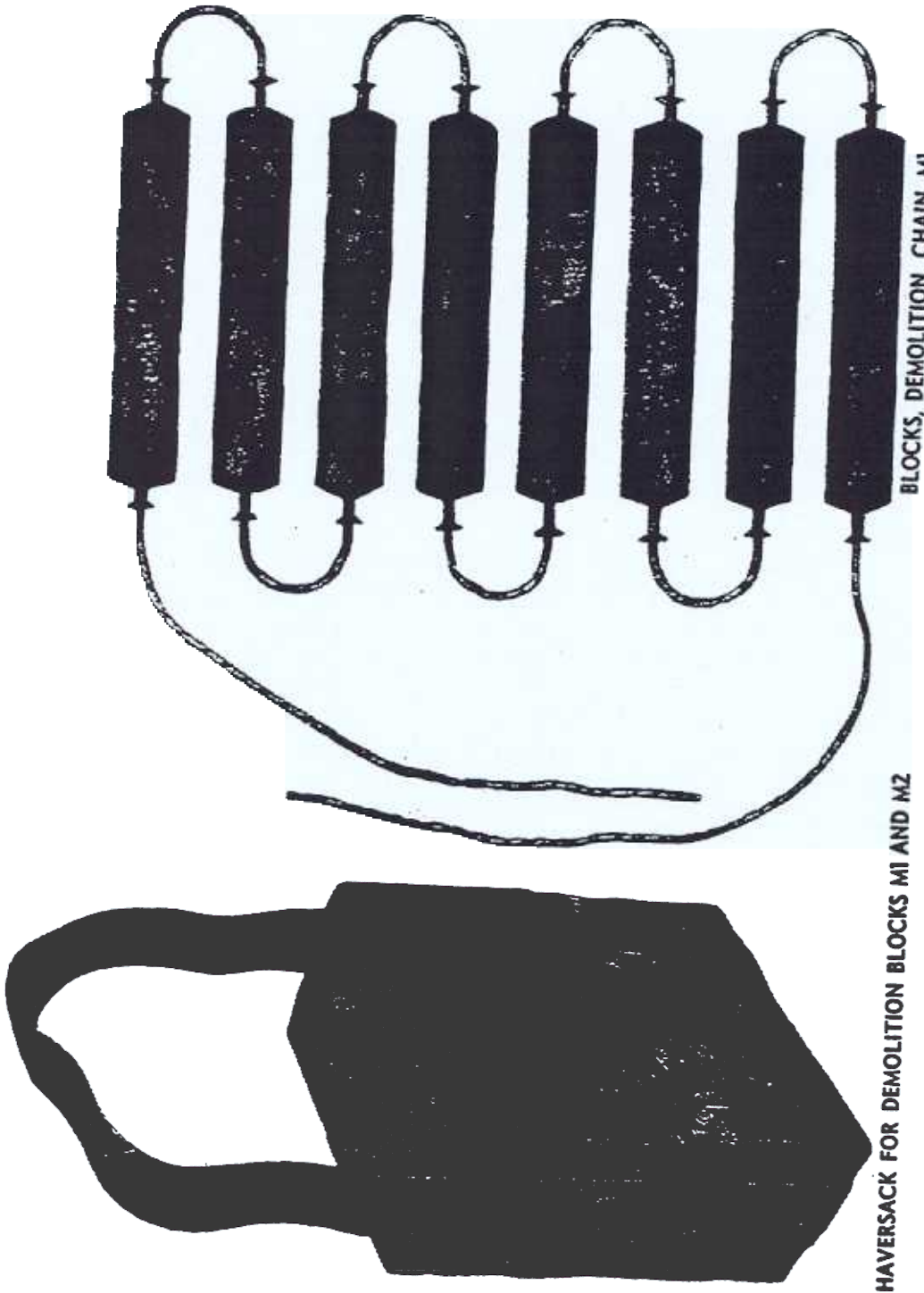

HAVERSACK FOR DEMOLITION BLOCKS MI AND M2

BLOCKS, DEMOLITION. CHAIN, MI

RA FD 69107

Figure 16 BLOCKS, Demolition, Chain, M

ANTIPERSONNEL MINES

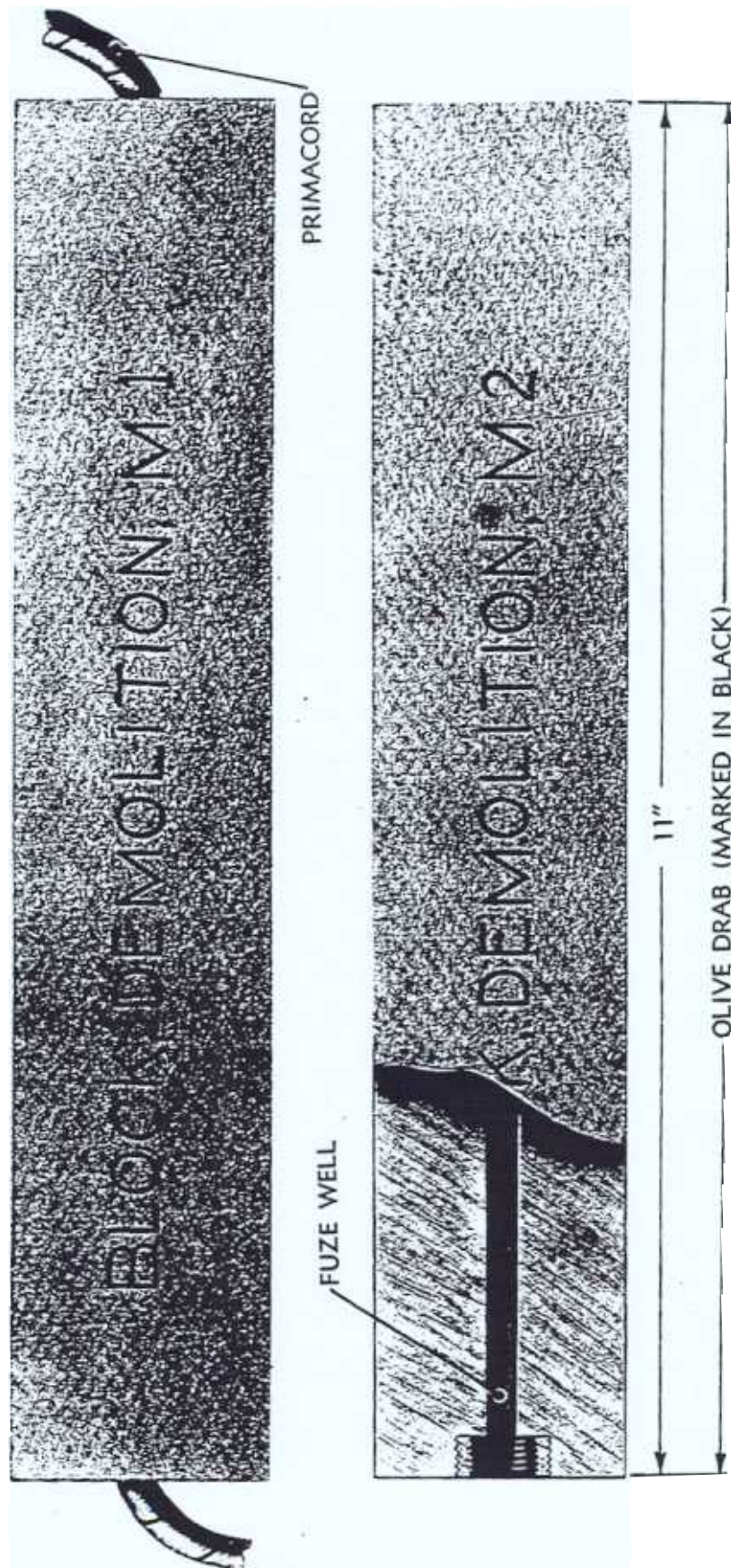

RA PD 69108

Figure 17 Demolition Blocks

LAND MINES

and in demolition work. If necessary, each block may be broken within its bag, but care should be exercised not to break the primacord. The blocks and primacord are comparatively insensitive to shock, but the assembly, that is, with tetryl pellet, is slightly more sensitive than TNT.

d. **Use.** It is necessary to detonate the primacord by means of a blasting cap or detonator in order to fire the entire chain. Sympathetic detonation of unconnected blocks can be obtained when they are separated by as much as 10 inches of air.

22. DEMOLITION BLOCKS.

a. **BLOCK, Demolition, M2.** BLOCK, demolition, M2 (fig. 17), is a rectangular block of tetrytol 2 by 2 by 11 inches, with a detonator well in each end. At the outer end of each well there is an adapter threaded to receive any of the standard firing devices. At the inner end of each well, there is a tetryl pellet cast in the block to act as a booster. Each block is wrapped in olive-drab paper on which is printed "BLOCK, DEMOLITION, M2" and "EQUIVALENT TO SIX ½-POUND TNT BLOCKS". This block, except for the replacement of the primacord by detonator wells, is similar to BLOCKS, demolition, chain, M1. It is packed in the same manner and has the same properties and uses.

b. **BLOCK, Demolition, M3.** BLOCK, demolition, M3, is a rectangular 2¼-pound block of plastic explosive 2 by 2 by 11 inches. It is packed in a cardboard box which is marked:

HIGH EXPLOSIVE
Composition C-2

"One block is equivalent to six ½-pound TNT blocks."

(1) This plastic explosive can be moulded by hand into any desired shape or position and is very efficient as a result of the good contact thus obtained combined with its high power. The explosive is plastic at temperatures ranging from 20 F below to 125 F above zero and is resistant to the action of water. BLOCK, demolition, M3, is packed in a cardboard box, eight such boxes per haversack, two haversacks per box.

c. **BLOCK, Demolition, M4.** BLOCK, demolition, M4, is a ½-pound block of high-explosive composition C 2, packed in a cardboard box 6.75 by 1.5 by 1 inch. These are packed without haversack, about 52 pounds per wooden box.

Section V

FUZES AND FIRING MECHANISMS

	Paragraph
General	23
Combination firing device M1	24
Pull firing device M1	25
Pressure firing device M1	26
Release firing device M1	27
Blasting caps	28

23. GENERAL.

a. Any of the firing mechanisms described herein may be used, with the appropriate detonator or igniter, with any of the devices described in the preceding section.

see c 1 **24. COMBINATION FIRING DEVICE M1.**

a. **Description.** This is a nonelectric mechanism designed for use with a trip wire or a pressure arrangement. The device (figs. 18 and 19) consists of a head, body, and base (figs. 11, 12, and 14). The base, containing the primer, has an extension to which an igniter or a detonator may be attached. The base is threaded below to screw into a mine or demolition block, and above to receive the body housing. The body contains a spring-loaded firing pin which passes through the head. The firing pin is grooved to receive the locking screw and release pin as it passes through the head and is drilled to receive the safety pin above the head. The pressure cap fits over the top of the firing pin.

b. **Function.** When the locking screw and safety pin are removed, the release pin, which bears in the groove in the firing pin, holds it against the firing pin spring. A pull of 3 to 6 pounds on the ring attached to the outer end of the release pin releases the firing pin. Also a force of 20 to 40 pounds on the pressure cap forces the release pin back, thus releasing the firing pin. Driven by the firing pin spring, the pin strikes the primer which explodes, sending a spurt of fire through the extension in the base, initiating the igniter or detonator attached thereto.

c. Installation.

(1) **IN ANTIPERSONNEL MINES M2 AND M3.** As issued with Antipersonnel Mine M2 the firing device has an igniter attached to the base. The base is separated from the body of the firing device and assembled to the mine. The firing pin assembly, designated FUZE, mine, antipersonnel, M2, is supplied with the mine but not assembled to it. As issued for the Antipersonnel Mine M3 the device is complete

- A — PULL FIRING DEVICE, M1
- B — PRESSURE FIRING DEVICE, M1
- C — COMBINATION FIRING DEVICE, M1

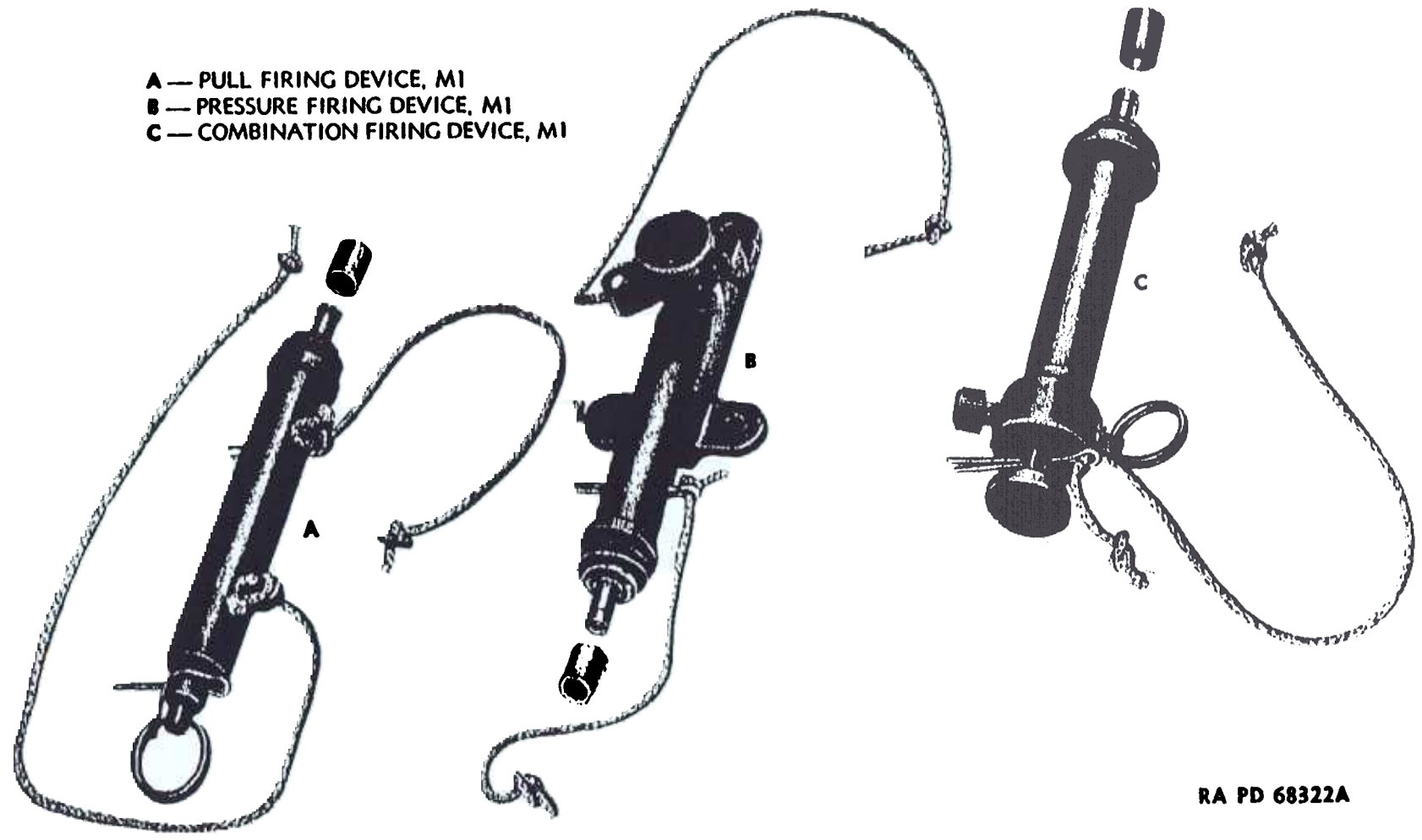

RA PD 68322A

Figure 18 Firing Devices

39

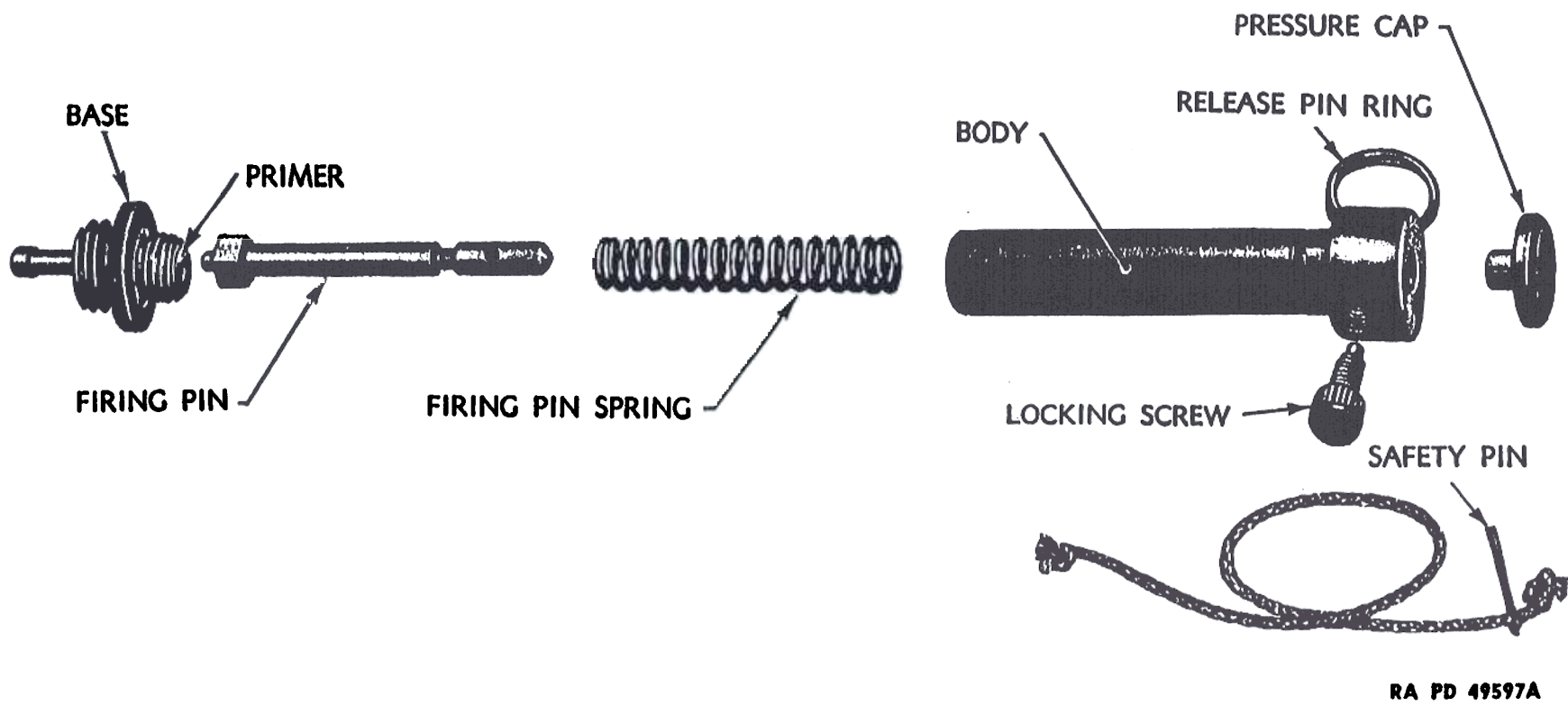

Figure 19 — Combination Firing Device M1

LAND MINES

and has a blasting cap assembled. This assembly is designated FUZE, mine, antipersonnel, M3. In this case the fuze is packed separately, but in the same packing box with the mine. For installation, see paragraphs 17 and 18.

(2) FOR INSTALLATION IN OTHER CHARGES.

(a) Prepare and place the mine charge. In addition to the standard mines supplied, the mine charge may be a fragmentation hand grenade, primacord, bangalore torpedo, or any explosive which can be detonated by the Army special nonelectric cap or by primacord. The procedure to be followed is the same as for the placing of any demolition charge where a nonelectric cap is used. If the firing device and the charge are not to be placed together, primacord may be used to connect them, by taping or tying three turns around a demolition block or inserting the end of the primacord into a fuze hole and wedging it there with a twig or piece of wood. The other end of the primacord is formed into a short loop and taped securely to the blasting cap on the firing device. Necessary waterproofing arrangements should be made where the charge is exposed to the weather. If severe weather conditions are anticipated, or the installation is expected to be subjected to weather for a long period, it is necessary to take additional steps to seal the connection between the firing device base and the blasting cap. A small amount of heavy grease, wax, cap-sealing compound, or any other suitable waterproofing material which is available should be applied in making all joints.

(b) Remove the base containing the primer, leaving the safety screw and safety pin in place.

(c) Remove the cardboard protector tube from the tip.

(d) Slide the open end of a nonelectric cap over the projection on the base and crimp, using cap crimpers. This should be done carefully as only a tight crimp will result in a waterproof joint between the base and the blasting cap.

(e) Screw the base, with blasting cap attached, to the device.

(f) Insert the blasting cap into the charge or tape primacord to the cap.

(3) FOR USE AS A PULL TYPE FIRING MECHANISM.

(a) Anchor the firing device as close to the mine charge as possible.

(b) Install the trip wire. *Always start from the far end.* Fasten the trip wire to a peg, bush, or other anchor, and then lay it out toward the mine. There should be *no tension* on the trip wire. Before connecting the trip wire to the firing device, step off to the side and inspect to see that the wire is not visible. Rearrange it, if necessary, so that it is not visible.

(c) Attach the trip wire to the firing device. It must place *no tension* on the device.

FUZES AND FIRING MECHANISMS

(4) FOR USE AS A PRESSURE FIRING MECHANISM (par. 26).

(a) Prepare the pressure trip installation, making sure that there is a firm attachment for the firing mechanism and that the pressure trip does not bear too heavily on the pressure cap.

(b) Attach blasting cap and prime charge as above.

(c) Install mechanism and pressure trip. Make sure that the installation is not detectable.

(5) The final operation is to remove the locking screw while the safety pin is in place. If there is too much pressure or tension on the firing device the safety pin will tend to bind and the installation should be checked. If the safety pin does not bind, gently remove it and leave both safety pin and locking screw concealed near the mine in case it should be necessary to disarm and take up the mine.

25. PULL FIRING DEVICE M1.

a. **Description.** The Pull Firing Device M1 (procured from Corps of Engineers) is a nonelectrical mechanism, designed primarily for use with a trip wire, for firing mines or other explosive charges. A direct pull of from 3 to 5 pounds applied to the trip wire releases the firing pin, which is driven by the compression spring into a percussion cap fitted in the base. This percussion cap fires a nonelectric blasting cap, attached to the base, which in turn detonates the explosive charge. The device (figs. 18 and 20) measures approximately $4\frac{3}{4}$ inches long by $\frac{5}{8}$ inch diameter. It consists of a head, a housing tube, and a base. The head contains a release pin, a safety pin, and a loading spring. The housing tube contains the firing pin, the firing pin compression spring, and a second safety pin which passes through the body between the firing pin and the percussion cap. The base contains a recess into which a percussion cap is placed, and a projection to which a nonelectric blasting cap is crimped when the firing device is loaded. The firing mechanism consists of a firing pin, a compression spring, a release pin assembly, and a loading spring. The split head of the firing pin is forced against pressure of the compression spring through a small opening or well, in the housing. The release pin enters into and expands the split head of the firing pin spindle against the sides of the well, thus preventing its return, although the striker is under pressure from the compression spring. The release pin is held in position by the loading spring. Holes in the main head and in the release pin allow insertion of safety pins, thus preventing accidental movement of the release pin to fire the cap. A soldered joint is made between the main head and the housing tube, so that this part of the device cannot be taken apart. A short piece of flexible wire terminating in a loop is attached to the housing tube at this joint. This is to be used as an anchorage for the firing

LAND MINES

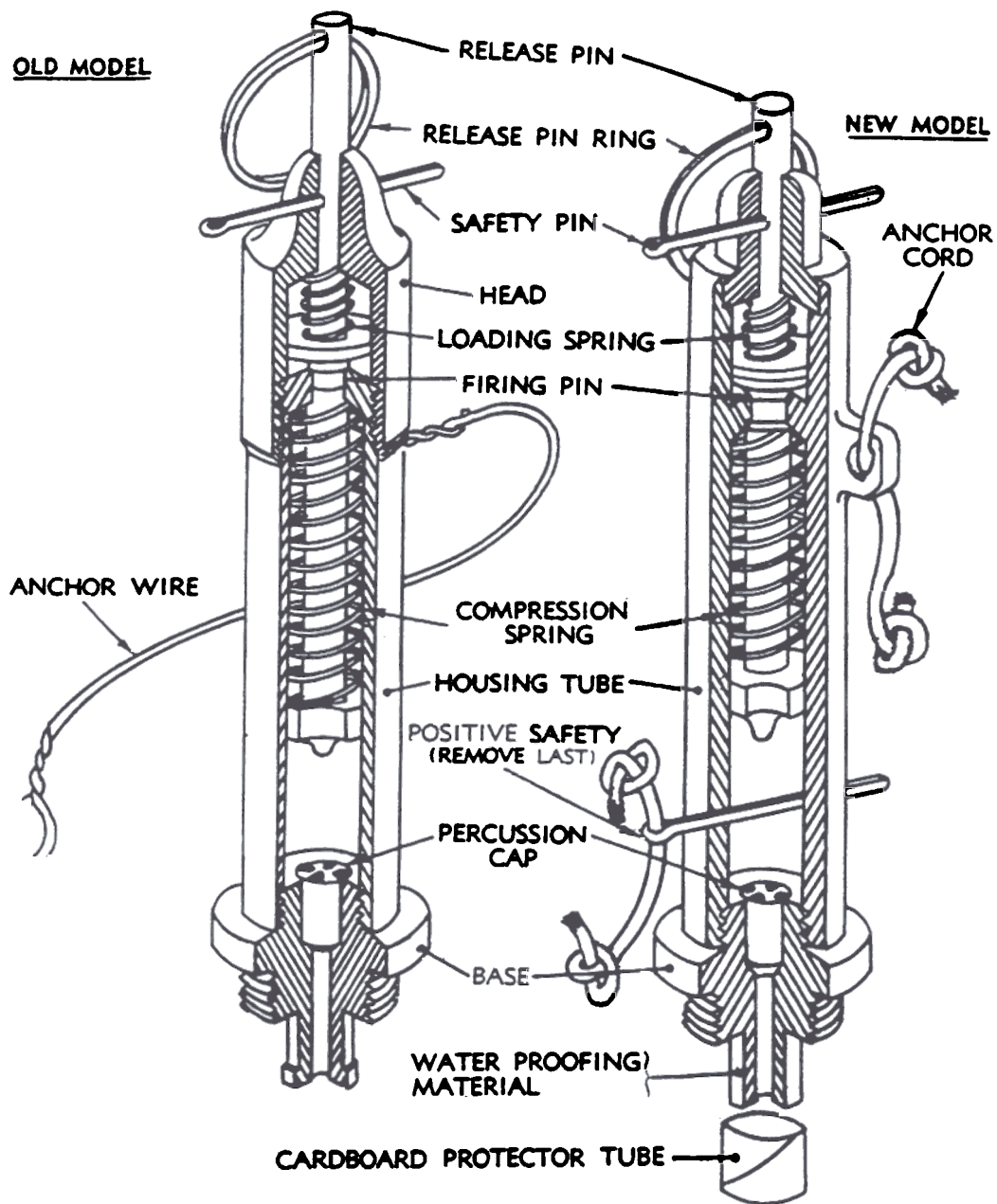

RA PD 69075

Figure 20 — Pull Firing Device M1

device. The ring on the release pin facilitates fastening the trip wire to the device. The safety pin through the body positively restrains the firing pin from striking the percussion cap.

b. **Functioning.** When the safety pins are removed, a pull of from 3 to 5 pounds applied through a distance of about $\frac{1}{32}$ inch is sufficient to overcome the resistance of the loading spring and cause the tapered end of the release pin to be withdrawn from within the

FUZES AND FIRING MECHANISMS

split head of the firing pin. The split head of the spindle, being no longer forced against the well, slips through under the influence of the compression spring. This forward movement of the firing pin continues until it strikes the head of the percussion cap contained in the base of the device. The percussion cap is thus fired, and detonates a nonelectric cap crimped to the base.

c. **Installation.** This device is installed in a manner similar to the combination firing device (par. 24) except that the safety pin through the body is removed last, after all other preparations have been made and tested.

d. **Packing.** Pull firing devices are packed in boxes, each box containing five devices complete with percussion caps and two 80-foot spools of light trip wire. The boxes measure $4\frac{3}{4}$ by $4\frac{7}{8}$ by $1\frac{5}{8}$ inches. Each full box weighs 1 pound 3 ounces.

26. PRESSURE FIRING DEVICE M1.

a. **Description.** The Pressure Firing Device M1 (procured from Corps of Engineers) is a nonelectrical device designed to cause the detonation of antipersonnel mines or other explosive charges when the device is subjected to a pressure of 30 pounds or more. The device (figs. 18 and 21) is mounted on a rectangular metal base plate, measuring $2\frac{1}{2}$ by $1\frac{1}{2}$ inches, and is composed of a barrel, head, and base. The barrel contains the firing mechanism and a safety pin. The head, permanently joined to the barrel, contains the trigger assembly. The base, which screws into the barrel, contains a recess into which a percussion cap fits and a projection over which a nonelectric blasting cap is crimped. (The base and percussion cap are identical with those used on the Pull Firing Device M1.) The firing mechanism consists of a striker assembly, a striker spring, a trigger assembly, and a trigger spring. The striker assembly consists of a round spindle, with a groove three-eighths of an inch from the end opposite the striker, the striker head, and a firing pin mounted on the striker head. The trigger unit consists of a large, flat head mounted on a trigger pin extending through the side and down into the barrel. The trigger pin has a pear-shaped hole in it. The small section of the spindle fits in the small end of a pear-shaped hole so that the striker spring is unable to cause movement of the striker and firing pin. A safety clip extends around the trigger pin, between the barrel and the trigger head. No appreciable movement of the trigger pin against the action of the trigger spring is possible until the safety clip is removed. The firing pin is restrained from striking the percussion cap until the safety pin through the body is removed.

b. **Functioning.** When the safety clip is removed, a force of from 25 to 35 pounds applied to the trigger head through a distance of three-sixteenths of an inch is sufficient to overcome the resistance of

LAND MINES

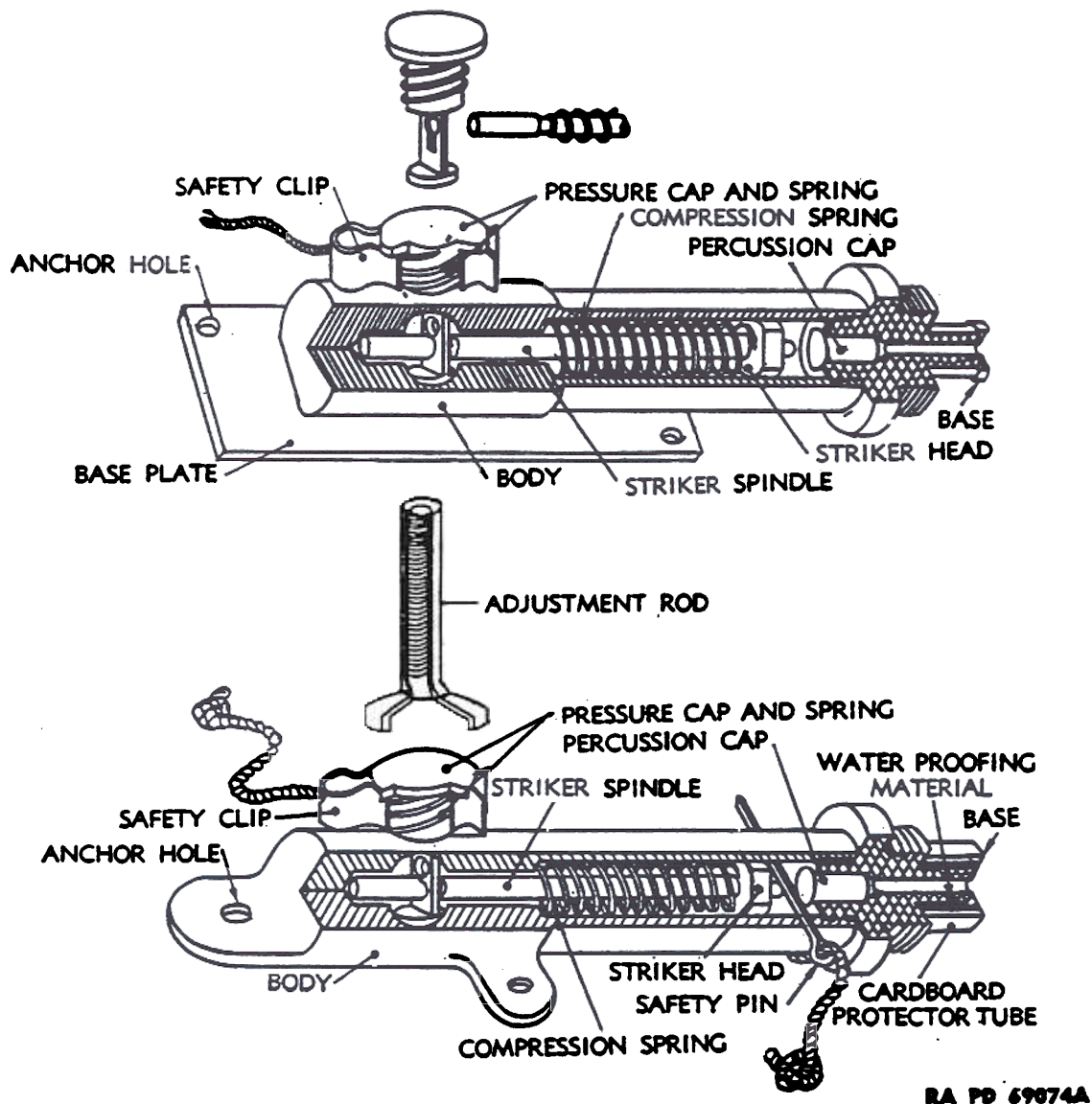

Figure 21 Pressure Firing Device M1

the trigger spring and cause the trigger pin to move into the barrel, permitting the striker and firing pin to be driven forward and strike the percussion cap. The percussion cap detonates a nonelectric blasting cap crimped to the projection on the base.

c. Installation. To install the Pressure Firing Device M1, the procedure is as follows:

(1) Prepare and place the mine charge as for the combination firing device (par. 24).

(2) Keeping the safety clip in position on the firing device, remove the base containing the percussion cap.

(3) Place the firing device in position at the location where it is to be used. Be sure that it has solid footing. Place the pressure

FUZES AND FIRING MECHANISMS

device in place and see that it does not bear too heavily on the trigger head.

(4) Slide the open end of the nonelectric cap around the projection on the base, and crimp, using the cap crimper.

(5) Screw the base, blasting cap attached, to the device.

(6) Prime the charge. When primacord is used, tape the looped end of the primacord to the blasting cap in the proper manner and run the other end to the charge. If primacord is not used, insert the blasting cap into a block of explosive.

(7) Next remove the safety clip gently. The safety clip should pull off very easily; a sudden jerk may cause the device to fire prematurely. If the safety clip does not pull off easily, check the installation to make sure that there is no pressure on the trigger pin.

(8) The final operation, after all parts of the installation have been checked, is to remove the safety pin. When the device is firmly anchored, it is good practice to remove safety clip and safety pin from a safe distance, using a string or length of wire for the purpose.

(9) When the firing device is employed with the Fragmentation Hand Grenade Mk. II, unscrew the grenade fuze assembly without removing the safety pin. Utilize the fiber washer under the fuze head assembly by placing it under the flange of the firing device base. Screw the firing device base, with nonelectric blasting cap attached, back into the grenade in place of the fuze assembly. Place the grenade, with firing device attached, and carefully camouflage the installation.

d. **Packing.** These firing devices are packed in boxes containing five devices each, complete with percussion caps. A full box weighs 1 pound 14 ounces, and measures $4\frac{3}{4}$ by $1\frac{5}{8}$ inches.

27. RELEASE FIRING DEVICE M1.

a. **Description.** The Release Firing Device M1 is a nonelectrical firing device designed to operate when a restraining load is removed from it. The device (fig. 22) measures approximately $2\frac{7}{8}$ by $1\frac{7}{8}$ inches, and consists of a cube-shaped body containing the lever, spring, and firing pin, mounted on a nailing bracket. The end of the body is provided with a female connection to take the standard firing device base used in the other types of firing device. The firing mechanism consists of the latch, spring lever, spring, and firing pin. The latch normally is held in position by the safety pin. Two $\frac{3}{16}$ -inch diameter holes are provided on the sides to permit the insertion of a nail or stiff wire to act as an auxiliary safety device by blocking the spring lever from striking the firing pin. When cocked, the device is restrained from firing as long as there is at least a 2-pound load

LAND MINES

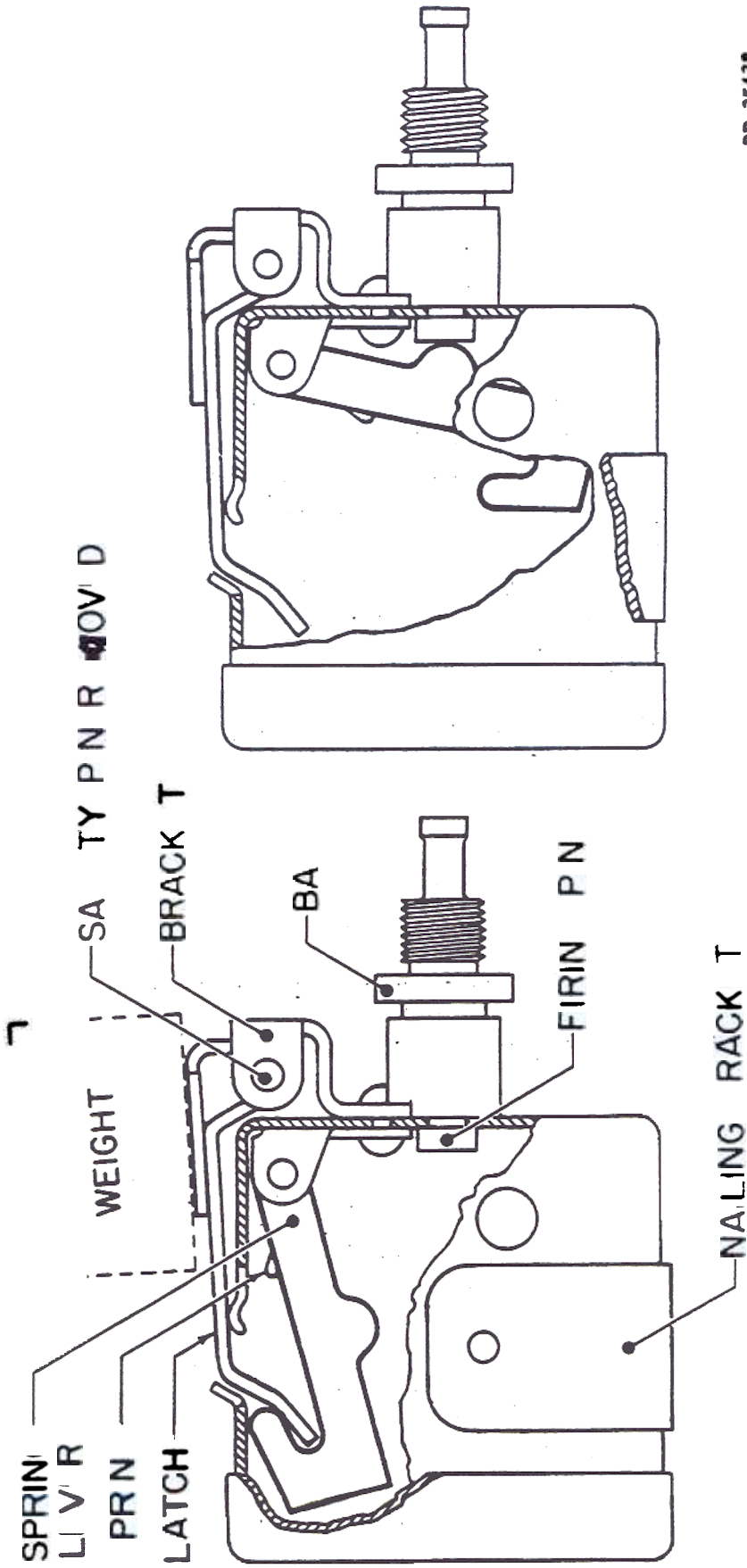

PD 35638

Figure 2 Lease 1-11-41 Devl M1

FUZES AND FIRING MECHANISMS

on the top face of the latch. A nailing bracket is provided by a thin plate $\frac{3}{4}$ of an inch wide by 4 inches long, spot-welded to the bottom of the body.

b. Functioning. In order to remove the safety pin, a weight of at least 2 pounds must be applied to the exposed surface of the latch. After the safety pin is removed, the removal of the load on the latch automatically frees the spring lever which, propelled by the spring, swings through and strikes the firing pin at the end of its flight, firing the percussion cap and detonating a nonelectric cap crimped to the base.

c. Installation. Prepare and place the mine charge as for the other firing devices (par. 24 c (2)).

(1) Slide the open end of a nonelectric cap over the projection on the base and crimp, using cap crimpers. This should be done carefully to insure a tight crimp and a waterproof joint between the base and the blasting cap.

(2) Provide a level, solid foundation on which the device is to rest. If a board is available, utilize it as a foundation and nail the device to it.

(3) Be sure the safety pin is in place. Insert a nail or wire through the side holes as an additional safety device.

(4) Screw the base with the blasting cap attached, into the device.

(5) Insert the blasting cap in the charge.

(6) Place the restraining load (antitank mine, heavy book, etc.) on the exposed surface of the latch.

(7) Remove the safety pin and then the additional safety device (nail or wire). Be careful not to disturb the restraining load.

28. BLASTING CAPS.

a. Blasting caps consist, in general, of a copper tube containing a charge of detonating explosive, usually tetryl, and a smaller charge of initiating explosive which on initiation by an electric current (electric caps) or a flame (nonelectric caps) detonates the larger charge. A current of at least 0.5 ampere each is necessary to insure the detonation of electric caps (fig. 23).

LAND MINES



CAP, BLASTING, NON-ELECTRIC



CAP, BLASTING, ELECTRIC

RA PD 53890

Figure 23 Blasting Caps

Section VI
REFERENCES

	Paragraph
Standard nomenclature lists	29
Explanatory publications	30

29. STANDARD NOMENCLATURE LISTS.

- a. Ground mines and fuzes, demolition material for use in policing target ranges, and ammunition for simulated artillery and grenade fire..... SNL R-7

Current Standard Nomenclature Lists are tabulated here. An up-to-date list of SNL's is maintained as the "Ordnance Publications for Supply Index" OPSI

30. EXPLANATORY PUBLICATIONS.

- a. Ammunition, general TM 9-1900
- b. Engineer field manual: Engineer antimechanized measures FM 5-30
- c. Engineer field manual: Explosives and demolition FM 5-25
- d. Ordnance safety manual OO No. 7224

LAND MINES INDEX

	Page No.		Page No.
A			
Accessories and components of		release firing device M1	45-47
bangalore torpedo	32	torpedo, bangalore, M1	32
Ammunition identification code..	3-4	Destruction of unserviceable ma-	
Ammunition lot numbers	4	terial and duds	7
Antipersonnel mines		Detonation of unserviceable ma-	
blocks, demolition, chain, M1.	33-36	terial	7
demolition blocks	36	Disassembly of antitank mines..	13
demolition materials	33	Dummy antitank mines	14-15
mine, antipersonnel, M2	23-27	F	
mine, antipersonnel, M3	27-30	Field report of ammunition ac-	
torpedo, bangalore, M1	32-33	cidents	8
Antitank mines and fuzes		Functioning or release firing de-	
antitank mine fuzes	15-21	vice M1	47
antitank mines	9-14	Fuzes and firing mechanisms	
dummy antitank mines	14-15	blasting caps	47
mine, antitank, nonmetallic,		combination firing device M1	37-42
H. E. M5, and fuze, mine,		pressure firing device M1..	44-45
antitank, chemical, M5..	21-22	pull firing device M1	42-44
practice antitank mines	14	release firing device M1	45-47
Assembly		Fuzing antitank mines	9-11
antitank mines	9-11	Identification of ammunition . . .	3-4
torpedo, bangalore, M1	32-33	L	
B			
Blasting caps, description	47	Land mines	
Blocks, demolition, chain, M1		care and precautions in han-	
characteristics	33-36	dling	4-5
description	33	classification	3
use	36	description	3
C			
Characteristics of blocks, demoli-		destruction of unserviceable ma-	
tion, chain, M1	33-36	terial and duds	7
Classification of land mines..	3	field report of accidents	8
Combination firing device M1		identification	3-4
description and functioning . . .	37	packing and marking for ship-	
installation	37-42	ment	8
D			
Demolition blocks	36	storage and preservation	5-7
Demolition materials	33	M	
Description and functioning		Mine, antipersonnel, M2	
antitank mines	9	description	23-26
blocks, demolition, chain, M1..	33	installation of firing device in	37-40
combination firing device M1..	37	operation	26
mine, antipersonnel, M2	23-26	packing and marking	27
mine, antipersonnel, M3	27-29	precautions	26-27
pressure firing device M1	44	Mine, antipersonnel, M3	
pull firing device M1	42	description	27-29
		installation of firing device in	37-40

INDEX

M—Cont'd	Page No.		Page No.
Mine, antipersonnel, M3—Cont'd		Precautions in handling	
marking and packing	30	ammunition	4-5
operation	29-30	antitank mines	22
precautions	30	mine, antipersonnel, M2	26-27
Marking		mine, antipersonnel, M3	30
ammunition	4	Pressure firing device M1	
antitank mines	14	description and functioning....	44
N		installation	44-45
Nonmetallic antitank mine		packing	45
fuzing	21-22	Primacord, description	33
packing and marking	22	Pull firing device M1	
O		description	42
Operation		functioning	42-43
mine, antipersonnel, M2	26	installation	43
mine, antipersonnel, M3 ...	29-30	packing	43-44
P		R	
Packing (See also Packing and		Release firing device M1	
marking)		description	45-47
antitank mines	13	functioning and installation ...	47
pressure firing device M1	45	S	
pull firing devices	43-44	Storage and preservation of am-	
torpedo, bangalore, M1	33	munition	5-7
Packing and marking		T	
ammunition for shipment	8	Torpedo, bangalore, M1	
mine, antipersonnel, M2	27	assembly	32-33
mine, antipersonnel, M3	30	components and accessories ...	32
Painting		description	32
ammunition	4	packing	33
antitank mines	14		

[A.G. 300.7 (30 Jan. 1943)
O.O. 461/27157 R.A. (15 Jul. 1943)]

BY ORDER OF THE SECRETARY OF WAR:

G. C. MARSHALL,
Chief of Staff.

OFFICIAL:

J. A. ULIO,
Major General,
The Adjutant General.

DISTRIBUTION: IR 5(5); R 9(4); IBn 5(5); Bn 2, 4, 6, 7, 9, 17, 18,
and 44(2); IC 5(10); C 9(8)

(For explanation of symbols, see FM 21-6)

TECHNICAL MANUAL

LAND MINES

CHANGES }
No. 1 }

WAR DEPARTMENT,
WASHINGTON 25, D. C., 7 August 1944.

TM 9-1940, 15 July 1943, is changed as follows:

1. PURPOSE AND SCOPE.

d. (Added.) Tactical information on this matériel may be found in FM 5-31.

8. PACKING AND MARKING FOR SHIPMENT.

TABLE I

Name	Quantity	Dimensions (in.)	Sq. Ft.	Cu. Ft.	Weight (lb.)
CAP, blasting, special electric	500	22 x 15 x 9 1/2	2.90	1.81	54
CAP, blasting, special nonelectric	5,000	19 x 16 x 8	2.11	1.40	65
EXPLOSIVE, ammonium nitrate (cratering charge)	In commercial size containers				
MINE, antipersonnel M2, M2A1, M2A3, M2A3B1, and M2A3B2	10	32 x 13 3/16 x 9 15/32	2.93	2.31	93
MINE, antipersonnel, M3
MINE, antitank, H. E., M1A1
MINE, antitank, H. E., M4
MINE, antitank, H. E., M5	4	12 3/25 x 25 11/25 x 25 2/5	2.54	2.58	78
MINE, antitank, practice M1
MINE, antitank, practice, M1B1
MINE, antitank, H. E., heavy, T6E1	1	13 3/8 x 13 3/8 x 44 1/2	1.23	.460	30
MINE, antitank, H. E., light, T7	8	7 1/2 x 11 x 19 1/2	1.43	.92	52
COVER, mine, antitank, H. E., M1A1 and M4 and practice M1 (also packed with antitank mines)	50/bundles, 40/bundles (2000 covers/wire-bound bale)	35 1/2 x 27 x 16	6.57	5.47	104
TORPEDO, bangalore, M1A1, Kit/	10	63 3/8 x 15 7/8 x 5 3/8	6.99	3.13	168
Box/	10	64 2/25 x 15 3/8 x 5 2/5	6.81	4.63	205

*These changes supersede TB 9-1940-4, 24 January 1944, and TB 9-1940-5, 24 February 1944.

*Posters
Junk*

11. METALLIC ANTITANK MINES.

* * * * *

c. Fuzing.

* * * * *

(2) Insert fuze in * * * of the mine.

NOTE: Before inserting fuze * * * the fuze cup. Inspect the hooks of the spider to make certain that all four fit snugly over the flange of the mine body. If they do not, they should be bent forward as far as necessary to fit securely.

* * * * *

Figure 1, Mine, antitank, H. E., M1, fuzed, is rescinded.

Figure 2, Mine, antitank, H. E., M1, as shipped, is rescinded.

(5) Pull safety fork, thereby arming fuze. If the mine is buried spider down, or in a mine cover, the safety fork will be removed just before the mine is planted.

* * * * *

e. Precautions.

(1) The safety fork * * * arm the fuze. The fork should not be removed until after the mine has been planted, unless the mine is planted spider down or in a mine cover. Should the mine * * * first be replaced.

CAUTION: Care will be * * * the firing mechanism. These figures refer to static loads; a sharp blow from a much smaller weight will operate the fuze.

* * * * *

g. Models. MINE, antitank, H. E., M1A1, is issued with the booster assembled in the fuze cup of the mine, the balance of the fuze being issued separately as the Fuze M1A2 (fig. 5). (The Mine M4 * * * M1B1, fig. 8).

* * * * *

11.1 MINE, ANTITANK, H. E., LIGHT, T7 (M7). (Added.)

a. General. The T7 mine is a metallic lightweight, quart-size antitank mine. It may also be used as an antipersonnel mine. The complete mine consists of three components: the loaded mine body, the pressure plate, and the fuze (fig. 4.1).

b. Description.

(1) The mine body is a rectangular container (approximately 7 by 4½ by 2½ inches) filled with a high explosive charge of tetrytol. The fuze well is located in the center of the top surface and at one end is an activator well that will accommodate any standard firing mech-

LAND MINES

anism. The pressure plate is shaped to the contour of the mine body and is slotted so that it may be guided by rivets in the sides of the mine body, into position over the fuze. A small circular pad on the under side of the pressure plate bears against the head of the fuze.

(2) The fuze issued with this mine is FUZE, chemical mine anti-tank, T9. A brass piston protrudes from the fuze body through a circular opening in a steel spring. A safety key straddles the com-

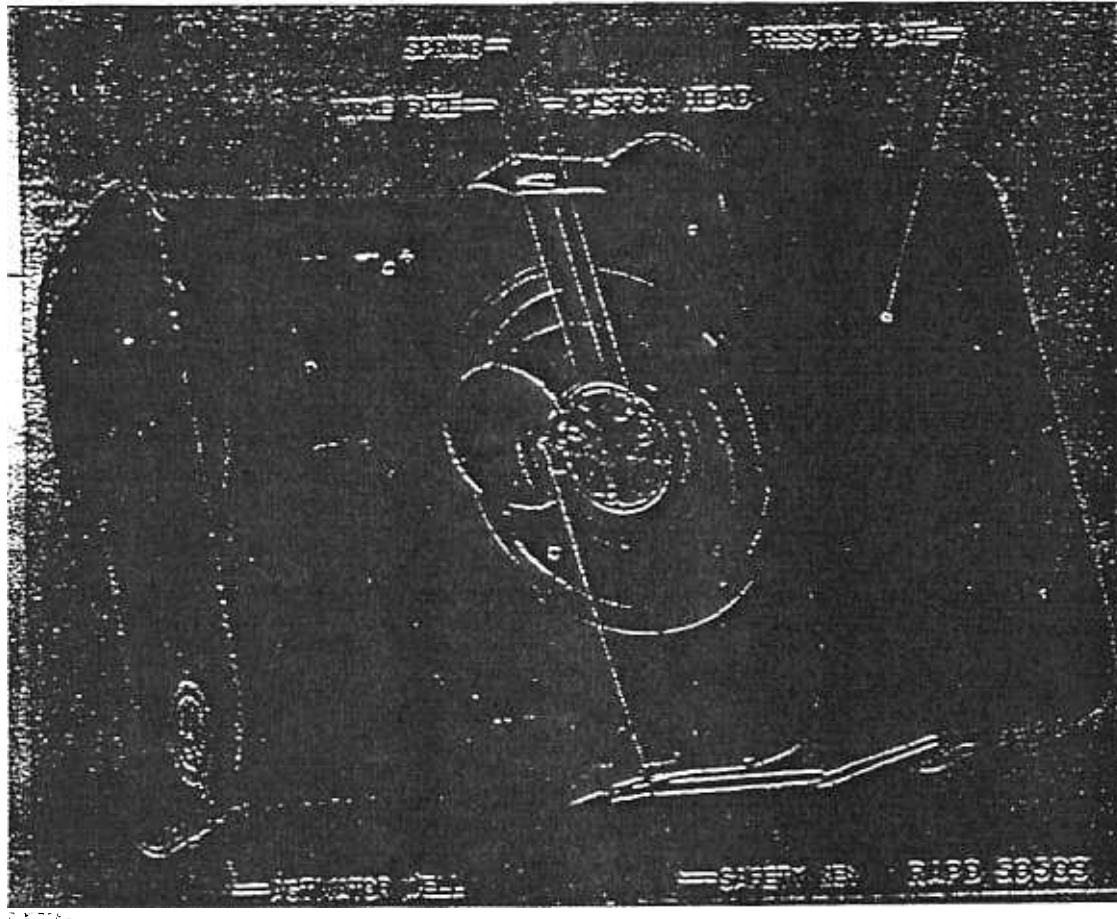

Figure 4.1. MINE, antitank, H. E., light, T7.

pression sleeve which is located between the fuze body and piston head. A force of approximately 300 to 400 pounds on the pressure plate is required to activate the fuze.

c. Fuzing.

- (1) Lift pressure plate and insert fuze, first being sure the well is free of any foreign matter.
- (2) Remove safety key.
- (3) Slide pressure plate into position over the fuze. Center the plate so the rivets in the sides of the mine are located in the vertical slots of the pressure plate.

(4) Plant mine. Pressure plate side may be up or down.

d. Defuzing. This mine may be defuzed by reversing the steps in c above.

e. Antiremoval Devices.

(1) Any standard firing mechanism with a Corps of Engineers blasting cap crimped to it, may be inserted in the activator well. For methods of installation, refer to paragraphs 24 to 26, inclusive.

(2) The mine may be disarmed as follows:

(a) Replace all safety devices.

(b) Cut pull or trip wires.

(c) Unscrew the firing mechanism from the activator well.

(d) Unscrew the base from the firing mechanism. Store these two items separately.

CAUTION: DO NOT ATTEMPT TO REMOVE THE BLASTING CAP FROM THE BASE.

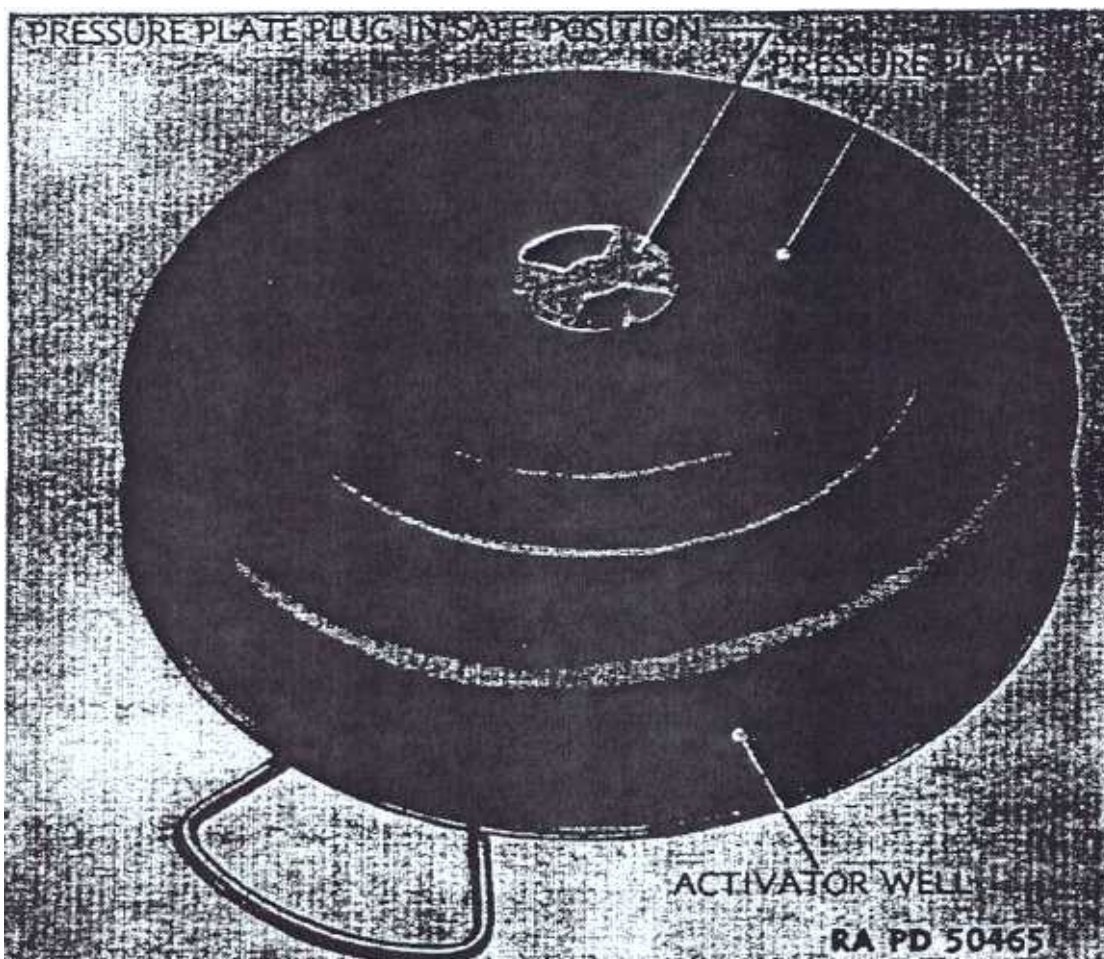

Figure 4.2. MINE, antitank, H. E., heavy, T6E1 showing pressure plate plug in SAFE position.

11.2 MINE, ANTITANK, H. E., HEAVY, T6E1. (Added.)

a. General. The complete mine (fig. 4.2) consists of the loaded mine body, the fuze, and the pressure plate plug. In addition to the fuze well, two threaded activator wells are located in the mine body, one in the bottom and one on the side.

b. Description.

(1) The round steel mine body has a base diameter of 13 inches and is loaded with approximately 12 pounds of TNT. It is painted olive-drab, with markings stenciled in yellow. Both activator wells are threaded to receive the M1 activator (fig. 4.5). The carrying handle is attached to the bottom of the mine. Assembled to the mine body is a round pressure plate, 7½ inches in diameter, containing the reversible pressure plate plug which covers the fuze well. The pressure plate is supported internally by circular (Belleville) springs. The

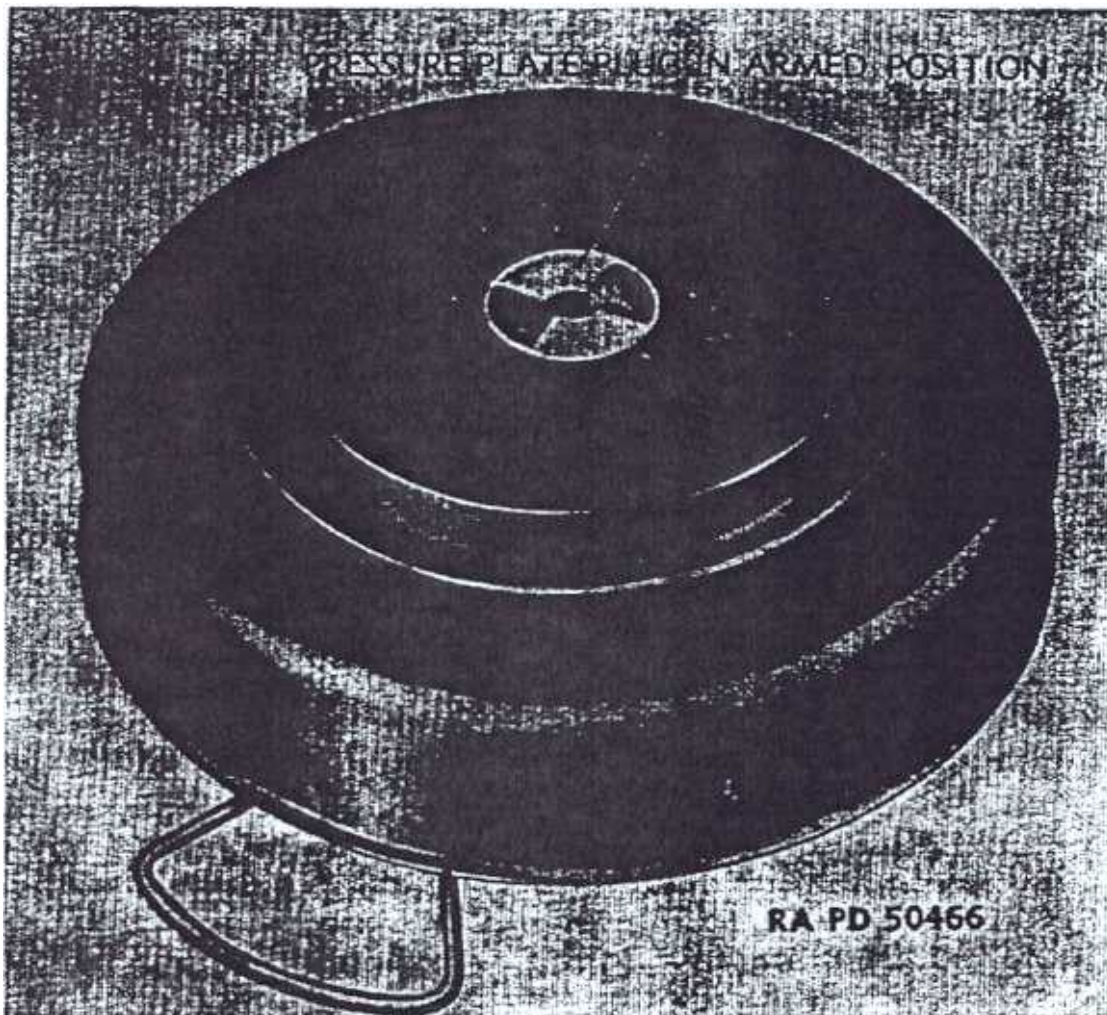

Figure 4.3. MINE, antitank, H. E., heavy, T6E1 showing pressure plate plug in ARMED position.

maximum height of the mine is $3\frac{1}{4}$ inches. This mine is not affected by stones, dirt, or moisture.

(2) Upon issue the pressure plate plug is screwed in the pressure plate in SAFE position (fig. 4.2). When the plug is unscrewed and removed, the fuze retaining spring is exposed at the top of the fuze well. After the fuze is inserted, the plug is reversed and inserted so



Figure 4.4. FUZE, chemical, mine, antitank, T8E1.

that the solid center portion of the plug rests directly over the top of the fuze. The plug will then be in ARMED position (fig. 4.3). Pressure of 350 pounds or more on the pressure plate, with the plug in ARMED position, will cause the fuze to function and detonate the mine.

(3) FUZE, chemical, mine, antitank, T8E1 (fig. 4.4), is armed for firing when the safety key is withdrawn. The safety key will not be removed except immediately before placing the fuze in the fuze well.

(4) **ACTIVATOR, M1** (fig. 4.5), is a plastic adaptor approximately 2 inches long. It has a threaded plug in the head and a tetryl booster charge in the cylindrical cup at the opposite end. The plug and cork gasket are removed from the head to accommodate any standard firing mechanism. The base is threaded to fit into the side or bottom activator well of the mine. This activator must be used to assemble a firing mechanism to the mine. When fired, the primer of the firing mechanism ignites the activator booster charge which detonates the mine.

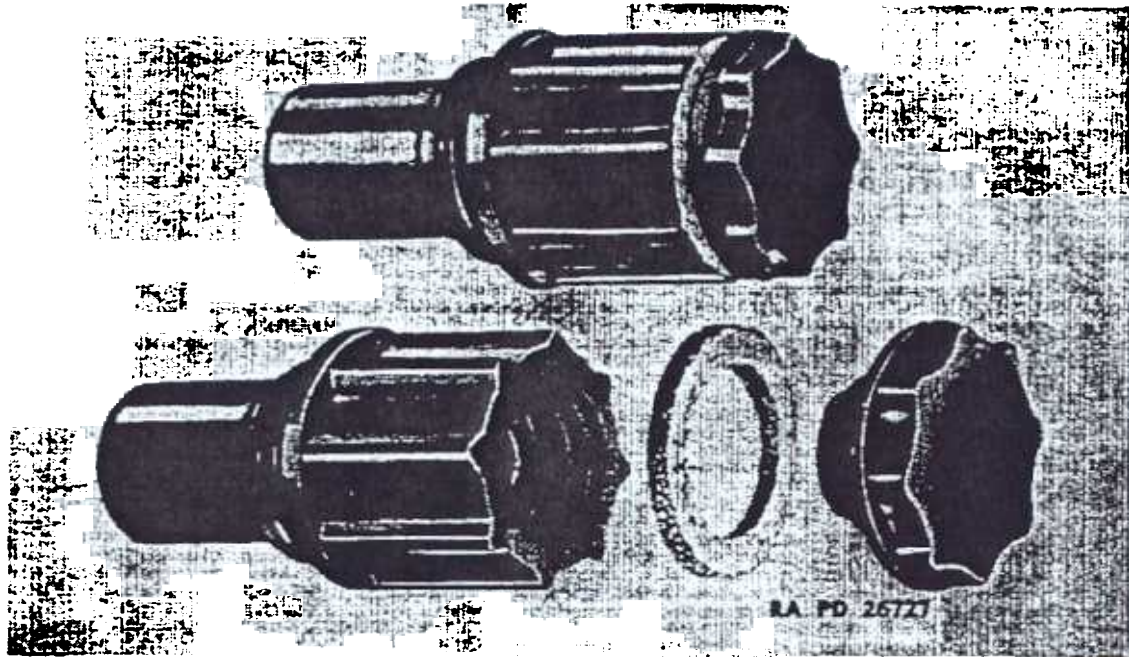

Figure 4.5. ACTIVATOR M1.

c. Fuzing of the Mine.

- (1) Remove pressure plate plug.
- (2) Inspect fuze well to be certain it is clear of any foreign matter.
- (3) Remove safety key from fuze.
- (4) Insert fuze in well with head up. Avoid pressure directly on top of fuze head. Push fuze down until retaining spring clicks around top of fuze body.
- (5) Replace pressure plate plug in the mine in ARMED position (fig. 4.3). Screw plug in handtight.

NOTE: Functioning of the fuze may be prevented by installing the pressure plate plug in SAFE position.

d. Defuzing. To defuze the mine, proceed as follows:

- (1) Remove pressure plate plug by unscrewing it in a counter-clockwise direction.

(2) Loop a piece of wire under the fuze spring (fig. 4.4). Withdraw fuze and replace safety key. The fuze may also be removed by grasping the edges of the spring with long-nosed pliers.

(3) Replace pressure plate plug in SAFE position (fig. 4.2), and screw in handtight.

e. Antiremoval Devices.

(1) **INSTALLATION.** Any standard firing mechanism may be attached to this mine, after the mine is fuzed. Use the M1 activator as described below. **CAUTION:** Fuze the mine (see c above) before installing any antiremoval devices. Be sure the pressure plug plate is in ARMED position during this installation.

(a) Remove tape and shipping sleeve from activator well.

NOTE: Care must be exercised not to exert pressure on the pressure plate.

(b) Inspect well to be certain it is free of foreign matter.

(c) Remove plug and cork gasket from head of activator. Screw activator handtight into well.

(d) Screw firing mechanism handtight into activator.

(e) Plant the mine and arm firing mechanism in accordance with type used (pars. 24, 25).

(2) **REMOVAL.** If the mine is to be picked up, all antiremoval devices must be disarmed and removed as follows:

(a) Replace all safety devices in the firing mechanism.

(b) Cut trip or anchor wires.

(c) Unscrew firing mechanism from activator.

(d) Remove activator. Replace plug and gasket in head of activator.

(e) Defuze mine (see d above).

f. Packing. Each mine is packed separately in an olive-drab square metal crate. A metal can containing one T8E1 is packed in the crate with the mine. The crate is 13½ inches square and 4½ inches high. The complete pack weighs 30 pounds.

14. METALLIC ANTITANK MINE FUZES.

a. FUZE, Mine, Antitank, H. E., M1A1. This fuze consists essentially of a striker assembly and a body which contains the primer and detonator. The striker assembly, on the outer end of which is a 2-inch diameter head, protrudes approximately ¾ inch beyond the body of the fuze. The detonator assembly protrudes from the bottom of the fuze. The firing mechanism, contained within the striker assembly, is restrained from firing when in armed condition (safety fork withdrawn) by the collar just below the head and two shear pins.

Upon assembly of the complete round, the detonator enters a mating cavity in the body of the mine. A force of * * * 100 per box.

b. FUZE, Mine, Antitank, H. E., M1A1.—Rescinded.

* * * * *

e. FUZE, Chemical, Mine, Antitank, T9.

(1) This fuze issued with the T7 light antitank mine operates under a load of 300 to 400 pounds. This force moves the piston into the fuze under the resistance of the spring and sleeve. The sleeve is crushed by the force, then allowing the piston to break an ampoule in the fuze. A liquid contained in the ampoule detonates the primer mixture and activates the mine.

(2) The fuze is marked in yellow with its designation, loader's lot number, loader's initials, and date loaded.

f. FUZE, Chemical, Mine, Antitank, T8E1. This fuze is similar in outward appearance and functioning to the T9 fuze. The spring on the top of the fuze is cut away at either side, and the perforations in the sleeve are larger so that the fuze alone may be activated by a force of 190 pounds. When inserted in the T6E1 mine, a force of 300 to 400 pounds is required to overcome the resistance of the Belleville spring in the mine.

CAUTION: The T8E1 fuze must never be used with the T7 mine.

g. Practice Fuzes.

(1) FUZE, MINE, ANTITANK, PRACTICE, M1. This fuze contains a smoke-puff charge and is similar in form and operation to FUZE, mine, antitank, H. E., M1A1.

* * * * *

14.1. COVER, MINE, ANTITANK, H. E. (Added.)

a. General. Protective bag covers are provided for the M1A1, and M4, H. E. mines, and for the M1, and M1B1 practice mines. Their purpose is to prevent dirt, sand, stones, or other foreign matter from working between the spider and the mine body, thereby causing the mine to fail to function properly. The cover (fig. 10.1) is cylindrical in shape, 8.75 inches in diameter, 9 inches high, and open at one end. It is made of moisture-resistant, mildewproof fabric.

b. Packing. Covers are supplied in bulk for the M1A1 and M4 H. E. mines and for the M1 and M1B1 practice mines. In the case of mines of current manufacture, covers are packed, one cover per mine, in the box with the mines.

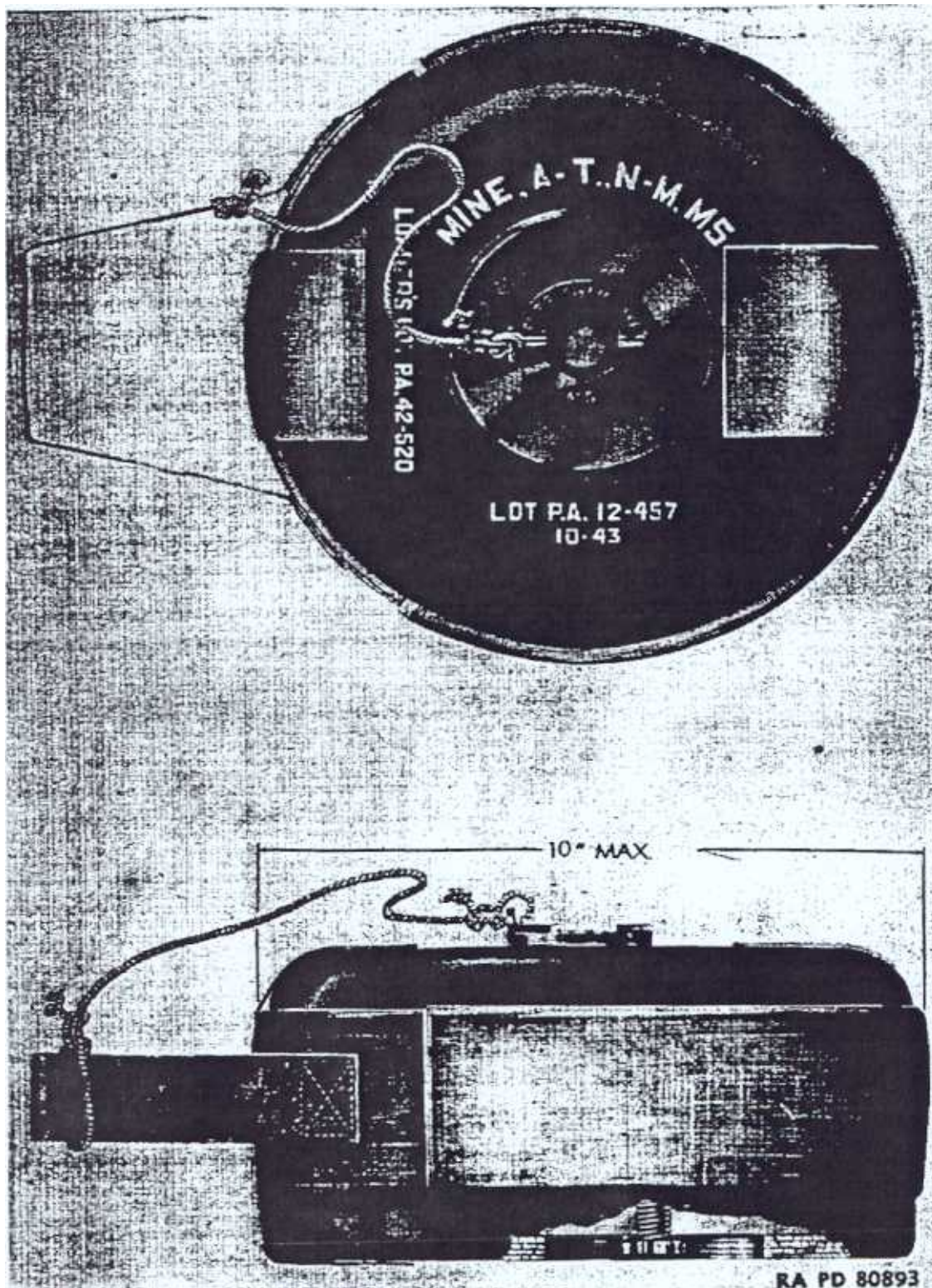

Figur 0. MINE ik, H. MS ed

17. MINE, ANTIPERSONNEL, M2 AND MODIFICATIONS.

a. MINE, antipersonnel, M2 (figs. 11, 12, and 12.1), is similar to a small mortar. It projects a shell * * * a pressure device. The standard and alternate standard models of the M2 antipersonnel mine are MINE, antipersonnel, M2A3, and MINE, antipersonnel, M2A3B1, and MINE, antipersonnel, M2A3B2.

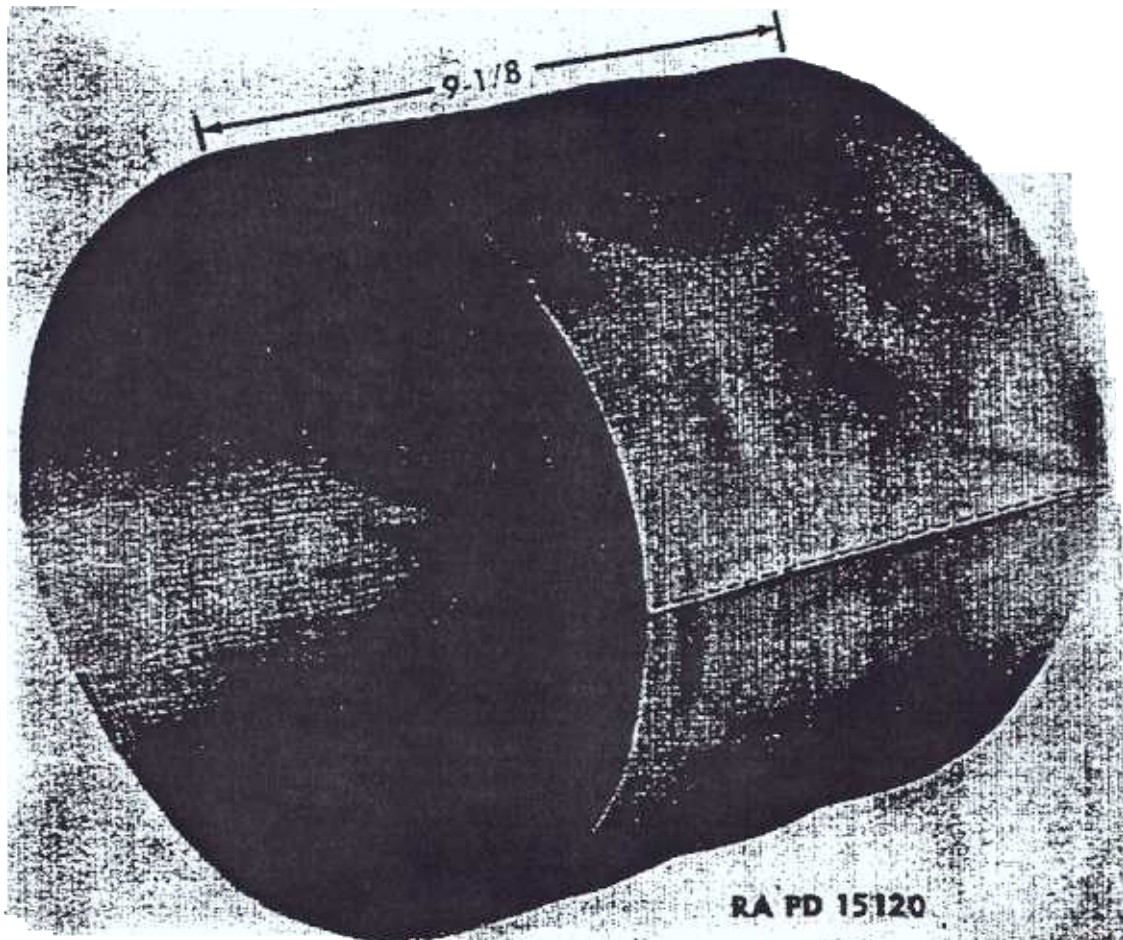

Figure 10.1. COVER, mine, antitank, H. E., M1A1, M4 and practice, M1, M1B1.

b. Description.

(1) The mine (figs. 11, 12, and 12.1) consists of a base, a length of thin-walled steel tubing riveted (M2) or soldered (M2A1) or coined (M2A3) to the base and serving to contain and project the loaded and fuzed shell. A $\frac{1}{4}$ -inch pipe nipple, threaded to the base serves as a connection for the firing mechanism. The M2A3B1 mine is a modification in which tube, base, and nipple are cast in one piece. The M2A3B2 mine is a combination of the M2A3 and M2A3B1. It has a cast base with the tube and nipple coined. The cavity in the base contains the propelling charge, which consists of 20 grains of

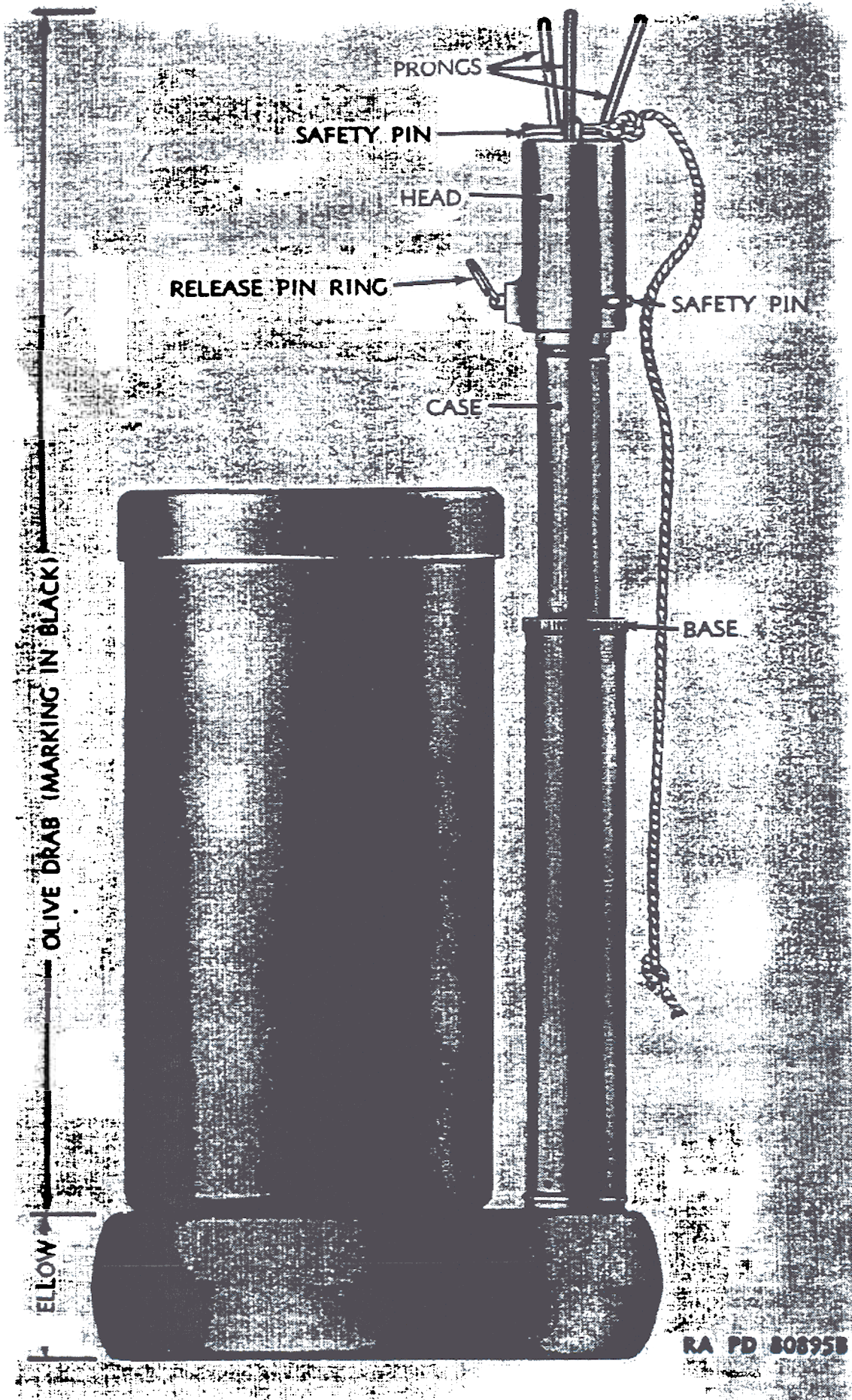

Figure 12.1. MINE, antipersonnel, M2A3.

LAND MINES

black powder in a small bag. The tube, containing * * * with the mine.

(2) The fuze issued with the M2 and M2A1 antipersonnel mines consists of the Combination Firing Device M1 (par. 24) with an igniter cap attached. The base and * * * is sand colored.

(3) (Added.) The fuze issued with the M2A3 and M2A3B1 antipersonnel mines is the FUZE, mine, combination, M2 or FUZE, mine, combination, M6 (fig. 19.1). The M6 fuze consists of a firing mechanism with a three-pronged head (par. 24.1) and an igniter. As issued, the igniter is assembled to the mine and the firing mechanism is packed separately in the same container. A pull of 6 to 10 pounds on the pull ring or a load of 10 to 20 pounds on all three prongs or 10 to 30 pounds on one prong will operate this fuze.

c. Operation. To assemble the mine, remove the hexagonal cap from the primer and, after making sure that all safety devices are in place, screw the firing mechanism onto the primer.

(1) **TO PLANT OR PREPARE FOR ACTION WITH THE M2 FUZE** (par. 24c).

* * * * *

(2) **TO PLANT OR PREPARE FOR ACTION WITH THE M6 FUZE** (par. 24.1).

(a) Be sure both safety pins are in place.

(b) Place the mine on a firm foundation.

(c) Remove the hexagonal cap from the primer and screw on the firing pin assembly.

(d) Attach trip wire. If desired, install the pressure trip on the three-pronged top.

(e) Check to see that the trip wire is not too tight, or that there is not too much weight on the three-pronged top.

(f) Remove the lower safety pin which is through the release pin.

(g) Remove the top safety pin (between the three prongs) which is through the firing pin. If the safety pin binds or is tight against the top of the fuze, the device is unsafe and will not be used.

(h) **SPECIAL SAFETY PRECAUTION:** Do not remove either safety pin until all trip wires are connected and checked to make certain they are not too tight.

(3) **TO PICK UP OR RECOVER.**

(a) Replace all safety devices.

(b) Cut the trip wire or remove the pressure tripping device from the pressure cap or three-pronged top.

* * * * *

d. Precautions.

* * * * *

(2) Rescinded.

* * * * *

17.1. MINE, ANTIPERSONNEL, PRACTICE, T4 (Added).

a. General. MINE, antipersonnel, practice, T4 is similar in appearance and operation to the M2A3. Obsolete bodies of M2 and M2A1B1 mines, with the bases painted blue and the marking "T4 Practice" on them, are utilized. This mine does not contain a propelling charge in the base as does the standard H. E. mine. The propelling charge for projecting the cardboard projectile into the air is contained in the igniter charge on the base of the fuze. The projectile contains a 12-gauge shotgun charge loaded with black powder. The explosion of the shotgun shell simulates a live mine. The primer and igniter, which has an approximate 5-second delay, is activated by FUZE, mine, combination T14E1. This fuze is a three-pronged firing device similar to FUZE, mine, combination M6 (par. 24.1).

b. Packing. Two mines with fuzes and twenty replaceable parts are packed in one box. The twenty replaceable parts consist of twenty projectiles, twenty propelling charges and twenty spotting charges in two containers, and twenty igniter assemblies in two containers.

18. MINE, ANTIPERSONNEL, M3.

a. General. The MINE, antipersonnel, M3 * * * use against personnel. The complete round consists of the mine, a hollow cast-iron block containing TNT, and FUZE, mine, antipersonnel, M3, or FUZE, mine, combination M7. It has an * * * within this radius.

b. Description.

* * * * *

(3) (Added.) FUZE, mine combination, M7 consists of a firing mechanism with a three-pronged head and a special blasting cap (par. 24.1). A pull of 6 to 10 pounds on the pull ring, or a load of 10 to 20 pounds on all three prongs or of 10 to 30 pounds on one prong will activate this fuze.

c. Operation.

* * * * *

(1) TO PLANT OR PREPARE FOR ACTION WITH THE M3 FUZE.

* * * * *

LAND MINES

(2) TO PLANT OR PREPARE FOR ACTION WITH THE M7 FUZE. After removing the closing plug from the mine, install the fuze as directed in paragraph 17c (2).

(3) TO PICK UP OR RECOVER.

(a) Replace the safety devices.

(b) Cut the trip wire or remove the pressure tripping device from the pressure trip or pronged top.

* * * * *

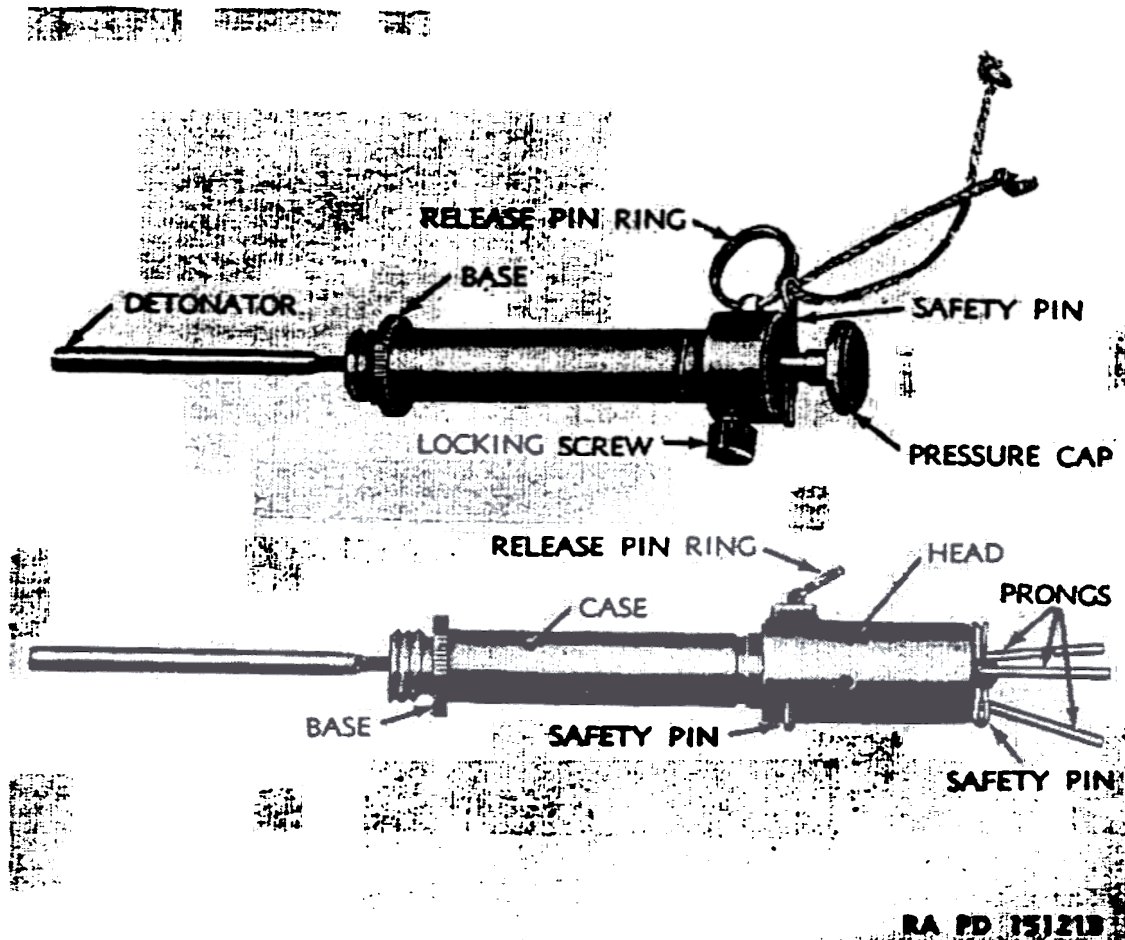

Figure 14. FUZES for mine, antipersonnel, M3.

19. TORPEDO, BANGALORE, M1A1.

a. Description.

(1) The bangalore torpedo * * * clearing mine fields. The TORPEDO, bangalore, M1A1, consists of a steel tube 5 feet in length and 2½ inches in diameter which is grooved and capped at each end. The tube is * * * lusterless olive-drab.

b. Components and Accessories.

* * * * *

(2) **Nose SLEEVE.** This is a rounded point which fits over the end of the torpedo. It contains a * * * of the torpedo.

* * * * *

d. Packing. TORPEDO, bangalore, M1A1, is packed 10 in a box, which also contains 10 connecting sleeves, and 1 nose sleeve (par. 8).

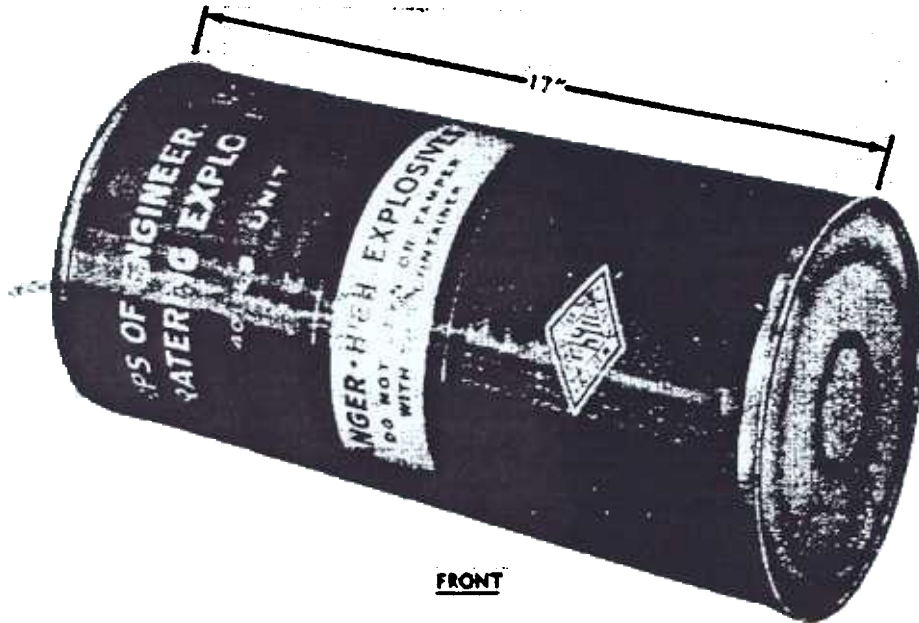

FRONT

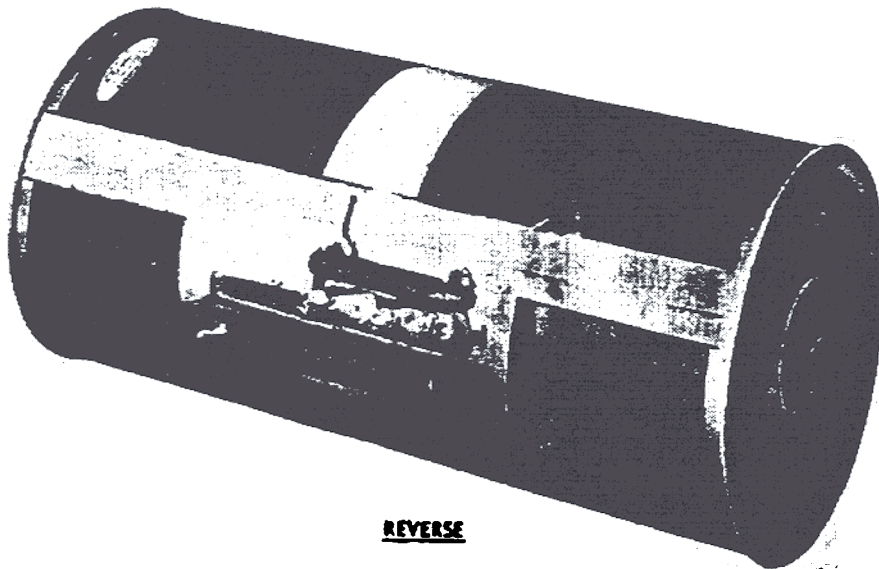

REVERSE

RA PD 80905

Figure 15.1. EXPLOSIVE, ammonium nitrate (cratering charge) in metal container.

20. DEMOLITION MATERIALS.

* * * * *

c. Cratering Charges (Added). Charges of 40 pounds of ammonium nitrate, sensitized with TNT, are furnished for blasting craters in roadways and for similar demolition work. The charge (fig. 15.1) is inclosed in a metal or paper container 8.5 inches in diameter. The metal container is 17 inches long; the paper container is 17.5 inches long. Clips for securing blasting caps or primacord are attached to the container. Cratering charges are packed in individual wooden boxes; the box for the metal container is 1.55 by 0.80 by 0.80 feet; that for the paper packed charge is 1.89 by 0.81 by 0.80 feet.

24.1. FUZE, MINE, COMBINATION, M6 and M7 (Added).

a. Description.

(1) Fuze, mine, combination M6 and M7 consist of a firing mechanism with a 3-pronged head and base to which is assembled an igniter (M6) or a blasting cap (M7).

(2) The fuze consists of a head and a case crimped together, which contain a trigger pin, a release pin, and a firing pin, each with a spring. A small groove in the firing pin is held in the narrow part of a keyhole slot in the release pin. The release pin is provided with a ring for attaching pull wires. When the release pin is moved to one side the firing pin is allowed to pass through the large opening of the keyhole slot in the release pin. The trigger pin has three 1-inch long prongs of stiff steel wire projecting from its head. A wedge is provided on the bottom of the trigger pin which enters a slot in the release pin, and when sufficient pressure is applied to one or more of the prongs, the release pin is moved aside and the firing pin passes through the large opening of the keyhole slot. Two safety pins are provided with this fuze. The top safety pin, which is inserted through a hole in the firing pin, is located between the three prongs. This pin has a crimp on one side to prevent it from sliding out. The lower safety pin passes through the release pin opposite the release pin ring.

(3) The base is a hollow cylinder which contains the primer. It is threaded above for attachment of the firing mechanism and below for assembly of the fuze to the mine. A tubular projection serves for attachment of the igniter or detonator.

b. Data.

(1) FUZE, mine, combination, M6 is 6.62 inches in length. The threaded portion of the base is $\frac{1}{2}$ inch long. The charge of the igniter consists of approximately 10 grains of black powder. A pull on the

release pin ring of 6 to 10 pounds, moving it $\frac{1}{2}$ inch, or a load on three prongs of 10 to 20 pounds, or on one prong of 10 to 30 pounds, moving the trigger pin $\frac{1}{2}$ inch, will release the firing pin and operate the fuze.

(2) FUZE, mine, combination, M7 is 7.13 inches in length. The threaded portion of the base is $\frac{1}{4}$ inch long. The detonator consists of CAP, blasting, U. S. Army special, type A. A pull on the release pin ring of 6 to 10 pounds, moving it $\frac{1}{2}$ inch, or a load on the three prongs of 10 to 20 pounds, or on one prong of 10 to 30 pounds, moving the trigger pin $\frac{1}{2}$ inch, will release the firing pin and operate the fuze.

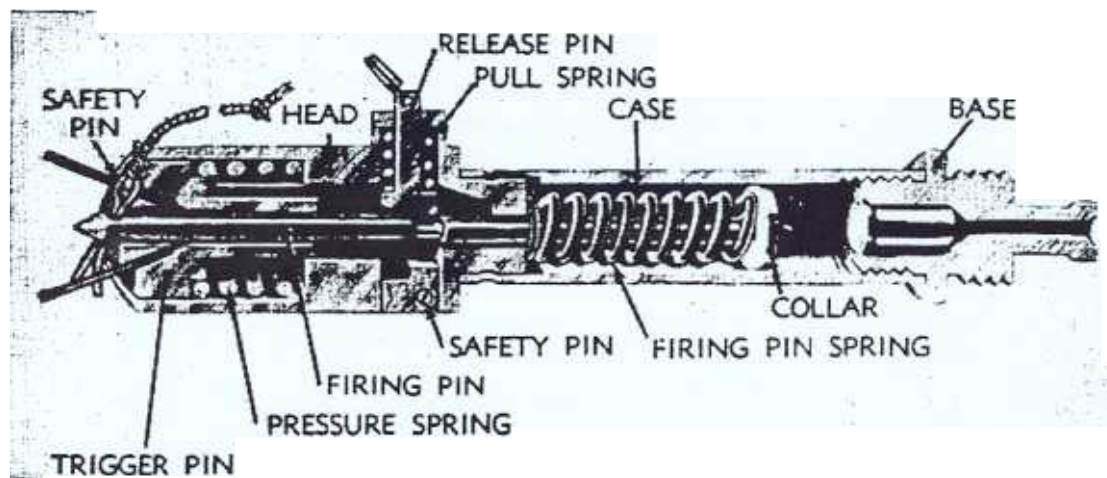

RA PD 15122B

Figure 19.1. FUZE, mine, combination, M6 and M7.

[A. G. 300.7 (4 Apr 44).]

BY ORDER OF THE SECRETARY OF WAR:

G. C. MARSHALL,
Chief of Staff.

OFFICIAL:

J. A. ULIO,
Major General,
The Adjutant General.

DISTRIBUTION:

As prescribed in paragraph 9a, FM 21-6, R 9(4); IR 5(5);

Ibn 5(5); Bn 2, 4, 6, 7, 9, 17, 18, 44(2); IC 5(10); C 9(8);

IR 5: T/O 5-171, T/O & E 5-192.

IBn 5: T/O 5-225, 5-455; T/O & E 5-215, 5-415.

IC 5: T/O & E 5-17, 5-387, 5-417, T/O 5-216, 5-226.

For explanation of symbols, see FM 21-6.