

U
400.3
A5
TNA-707

*Received per para. 81,
Sec. II, DA Cir. 310-54, 21 March
1952* **TM 9-707**

WAR DEPARTMENT

TECHNICAL MANUAL

BASIC HALF-TRACK VEHICLES (IHC)
(PERSONNEL CARRIER M5, CAR M9A1
MULTIPLE GUN MOTOR CARRIAGE M14, AND
SIMILAR IHC VEHICLES)

MAY 21, 1943

BASIC HALF-TRACK VEHICLES (IHC)

(PERSONNEL CARRIER M5, CAR M9A1, MULTIPLE GUN MOTOR CARRIAGE M14, AND SIMILAR IHC VEHICLES)

Prepared under the direction of the
 Chief of Ordnance

(with the cooperation of International Harvester Company)

CONTENTS

PART ONE – Vehicle Operating Instructions

SECTION		Paragraphs	Pages
I.	Introduction	1– 4	3– 21
II.	Driving controls and operation.....	5– 7	22– 32
III.	Auxiliary equipment controls and operation (winch)	8– 11	33– 35
IV.	Inspection and preventive main- tenance service	12– 20	36– 69
V.	Lubrication	21– 24	70– 76
VI.	Tools and equipment stowage on the vehicle	25– 30	77–112
VII.	Operation under unusual conditions	31– 40	113–120

* This manual supersedes TM 9-711A, Half-track Personnel Carrier M5.

BASIC HALF-TRACK VEHICLES (IHC) (PERSONNEL CARRIER M5, CAR M9A1, MULTIPLE GUN MOTOR CARRIAGE M14, AND SIMILAR IHC VEHICLES)

PROPERTY OF U.S.A.

PART TWO – Vehicle Maintenance Instructions

	Paragraphs	Pages
Section VIII. Maintenance collection.	41- 44	121-131

IX. Organization tools and equipment	45	132-134
X. Front axle	46- 49	135-148
XI. Rear axle	50- 53	149-158
XII. Bogie suspension and track	54- 58	159-188
XIII. Brake systems	59- 68	189-236
XIV. Clutch	69- 73	237-242
XV. Cooling system	74- 83	243-261
XVI. Electrical system	84-102	262-311
XVII. Engine	103-118	312-347
XVIII. Exhaust system	119-121	348-351
XIX. Frame	122-124	352-356
XX. Fuel system	125-131	357-376
XXI. Instruments and gages	132-134	377-389
XXII. Propeller shafts	135-137	390-393
XXIII. Springs and shock absorbers	138-141	394-400
XXIV. Steering gear	142-145	401-412
XXV. Transmission and transfer case	146-148	413-421
XXVI. Wheels, tires, and wheel bearings..	149-152	422-432
XXVII. Winch	153-158	433-436
XXVIII. References	159-160	437-439
INDEX		440-449

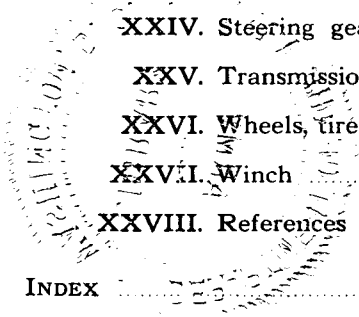

PART ONE – Vehicle Operating Instructions

Section I

INTRODUCTION

	Paragraph
Scope	1
Content and arrangement of text	2
Description	3
Tabulated data	4

1. SCOPE.

a. This manual is published for the information of the using arms and services.

b. It is a basic manual for Half-track Personnel Carrier M5, Half-track Car M9A1, Multiple Gun Motor Carriage M14, and other similar half-track vehicles manufactured by International Harvester Company.

c. In addition to a description of the vehicles, this manual contains technical information required for the identification, use, and care of the materiel.

d. Disassembly, assembly, and such repairs as may be handled by using arm personnel may be undertaken only under the supervision of an officer or the chief mechanic.

e. In all cases where the nature of the repair, modification, or adjustment is beyond the scope or facilities of the unit, the responsible ordnance service should be informed so that trained personnel with suitable tools and equipment may be provided, or proper instructions issued.

2. CONTENT AND ARRANGEMENT OF TEXT.

a. Information for operating personnel (crews) is in Part One, sections I to VII, inclusive. Information for organizational maintenance personnel (using arms unit mechanics) is in Part Two, sections VIII to XXVII, inclusive. A list of references is available in section XXVIII.

3. DESCRIPTION.

a. The armored vehicles described in this manual are of half-track type but have different bodies. Each vehicle has a specially designed, commercial type, front-and-rear drive, truck chassis with an armored hull. Each vehicle is powered by a conventional 6-cylinder gasoline engine.

b. **Half-track Personnel Carrier M5.** This vehicle is illustrated in figures 1, 2, and 3. The personnel carrier is distinguished by the seating

BASIC HALF-TRACK VEHICLES (IHC) (PERSONNEL CARRIER M5, CAR M9A1, MULTIPLE GUN MOTOR CARRIAGE M14, AND SIMILAR IHC VEHICLES)

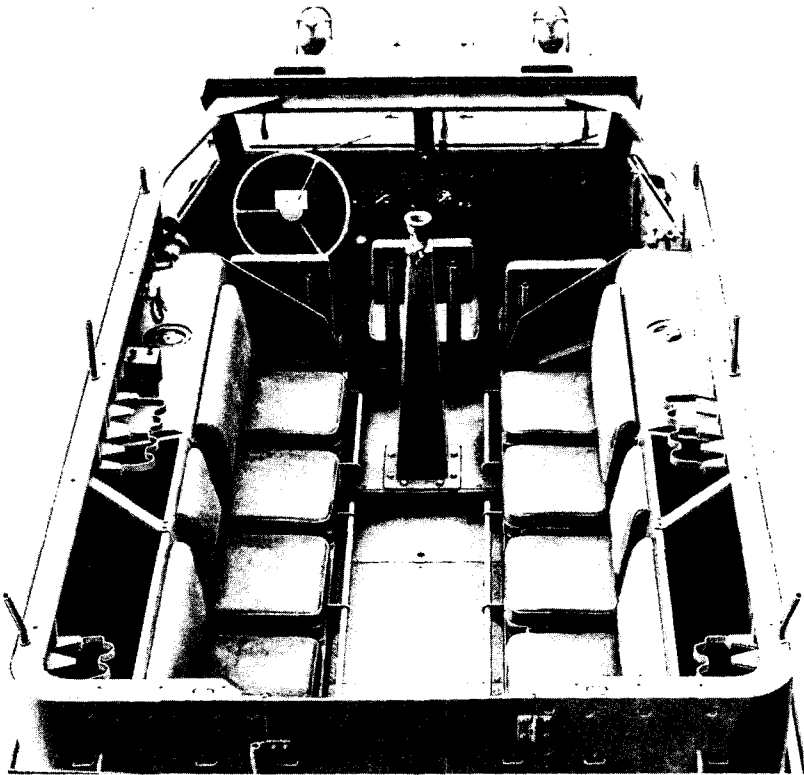

RA PD 18331

Figure 1 — Half-track Personnel Carrier M5 — Top View

arrangement for a crew of 13, a pedestal mount, and the presence of a rear door. There are 3 driver's compartment seats, and the remaining 10 seats are arranged in 2 lengthwise rows of 5 each.

c. **Half-track Car M9A1.** This vehicle is illustrated in figures 4 to 7, inclusive, and has a seating arrangement for a crew of 10, a gun ring, a radio mast, and a rear door. The driver's seat and commander's seat are in the driver's compartment. A third seat is just behind the driver's compartment but also faces toward the front. The remaining seats are arranged 3 on either side at the fuel tanks and 1 facing the rear just behind the center driver's compartment seat.

d. **Multiple Gun Motor Carriage M14.** This vehicle is illustrated in figures 7 to 11, inclusive, and is distinguished by the seating arrangement for a crew of five, and the twin mount machine gun. There are

INTRODUCTION

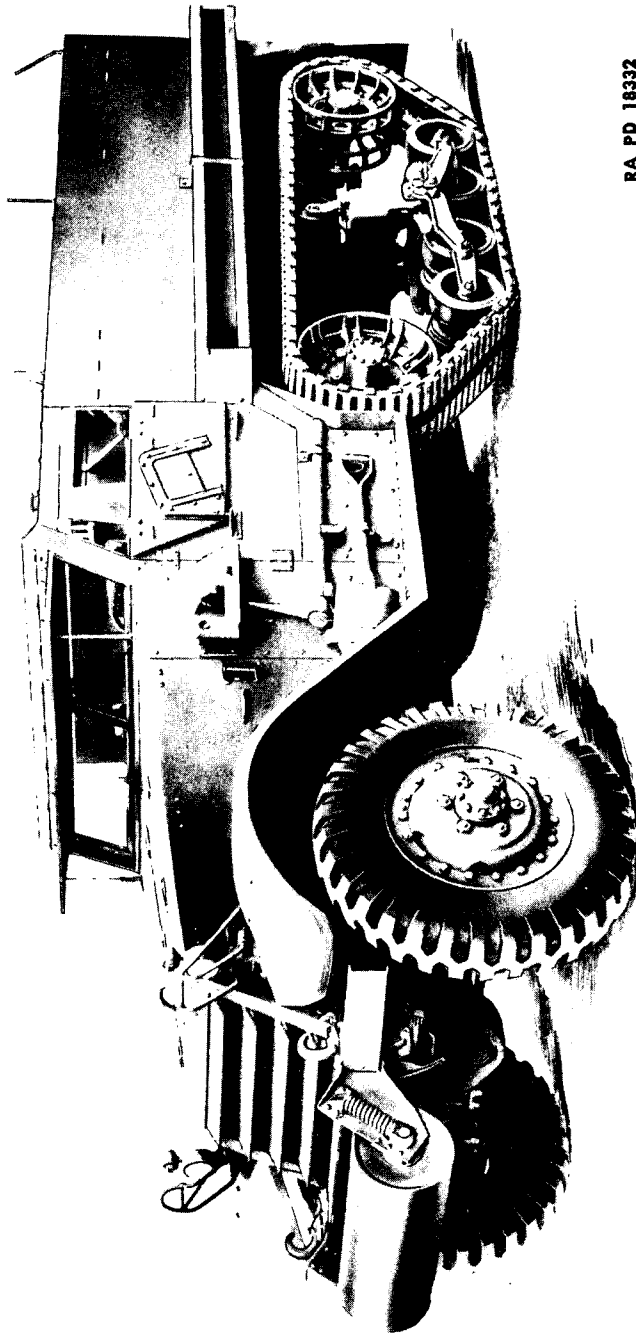

RA PD 18332

Figure 2 — Half-track Personnel Carrier M5 — Left Front

**BASIC HALF-TRACK VEHICLES (IHC) (PERSONNEL CARRIER M5, CAR M9A1,
MULTIPLE GUN MOTOR CARRIAGE M14, AND SIMILAR IHC VEHICLES)**

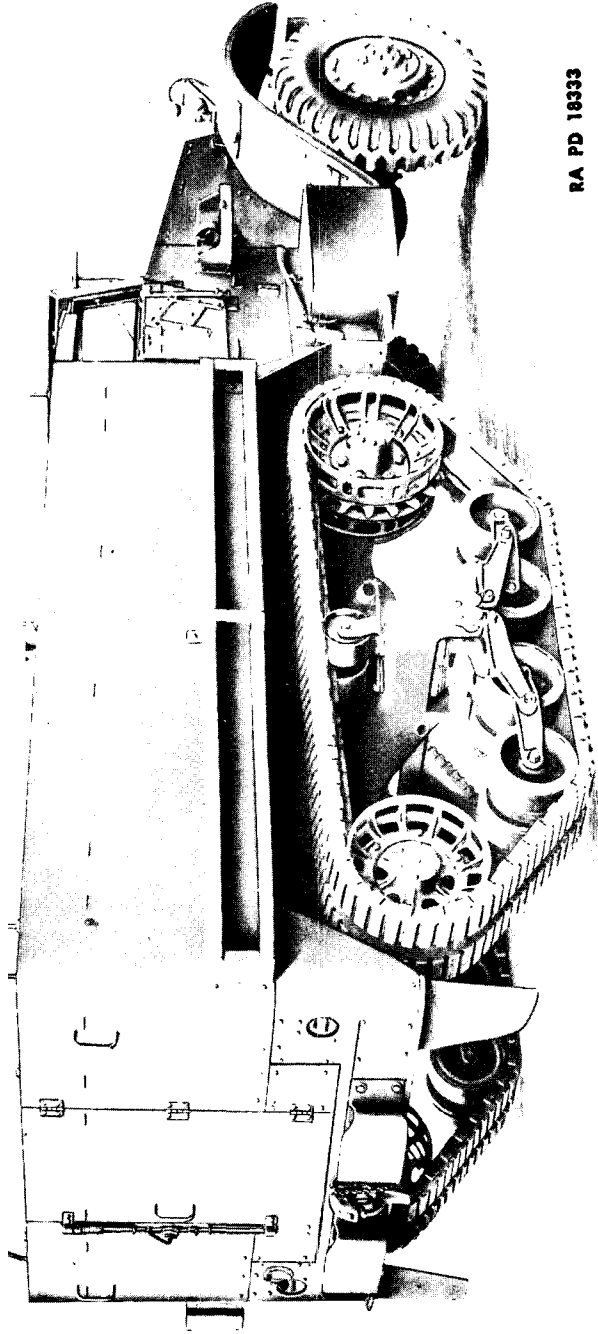

RA PD 18333

Figure 3 — Half-track Personnel Carrier M5 — Right Rear

INTRODUCTION

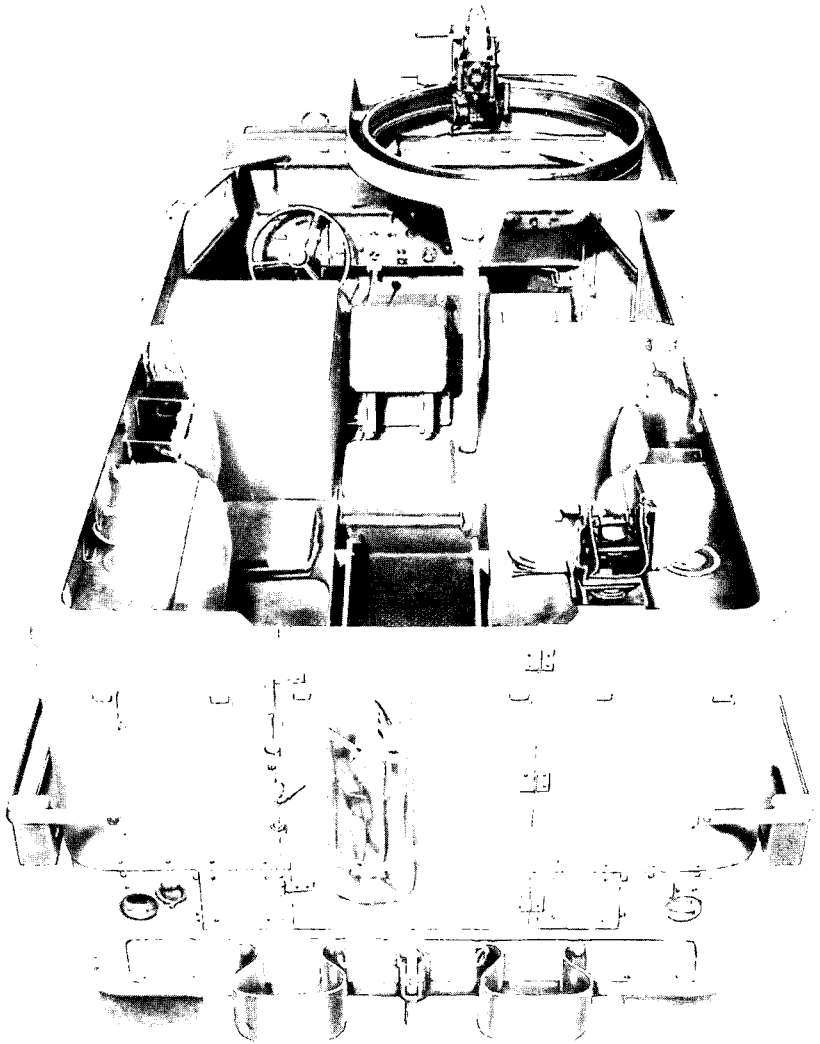

RA PD 18540

Figure 4 – Half-track Car M9A1 – Top View

three driver's compartment seats and the remaining two seats face each other just to the rear of the driver's compartment.

e. **Identification Numbers.** The manufacturer's chassis serial number and model numbers are located on a plate attached to the right side of the instrument panel. The engine number is stamped on a pad on the left side and to the front of the crankcase.

**BASIC HALF-TRACK VEHICLES (IHC) (PERSONNEL CARRIER M5, CAR M9A1,
MULTIPLE GUN MOTOR CARRIAGE M14, AND SIMILAR IHC VEHICLES)**

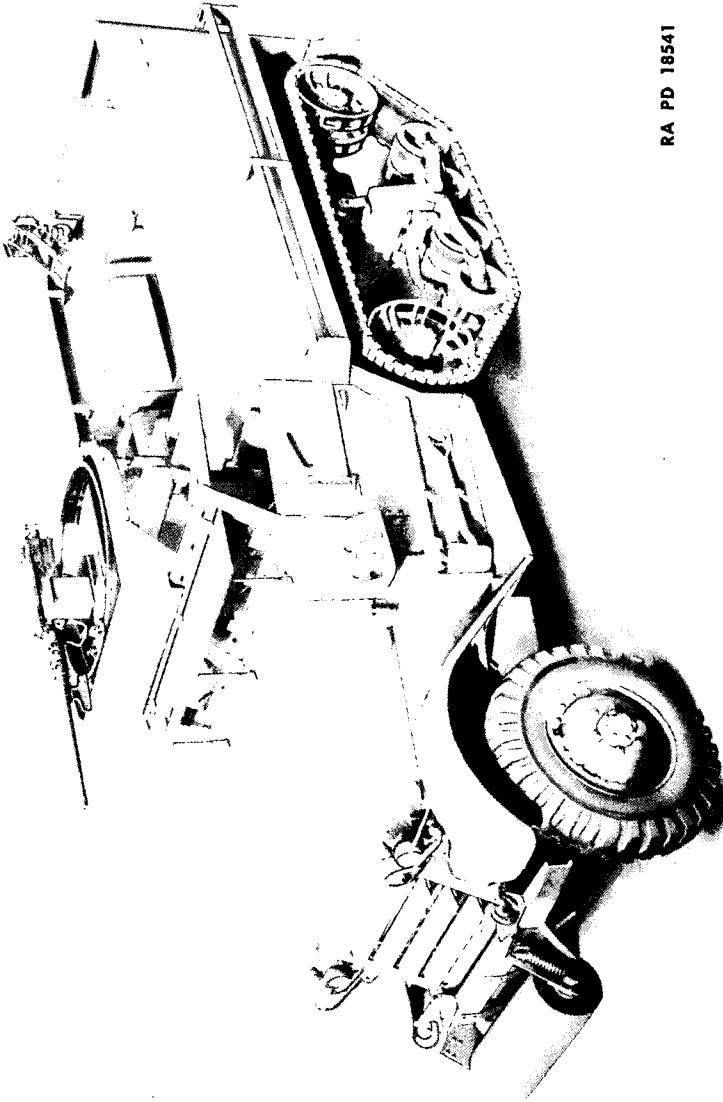

RA PD 18541

Figure 5 — Half-track Car M9A1 — Left Front

INTRODUCTION

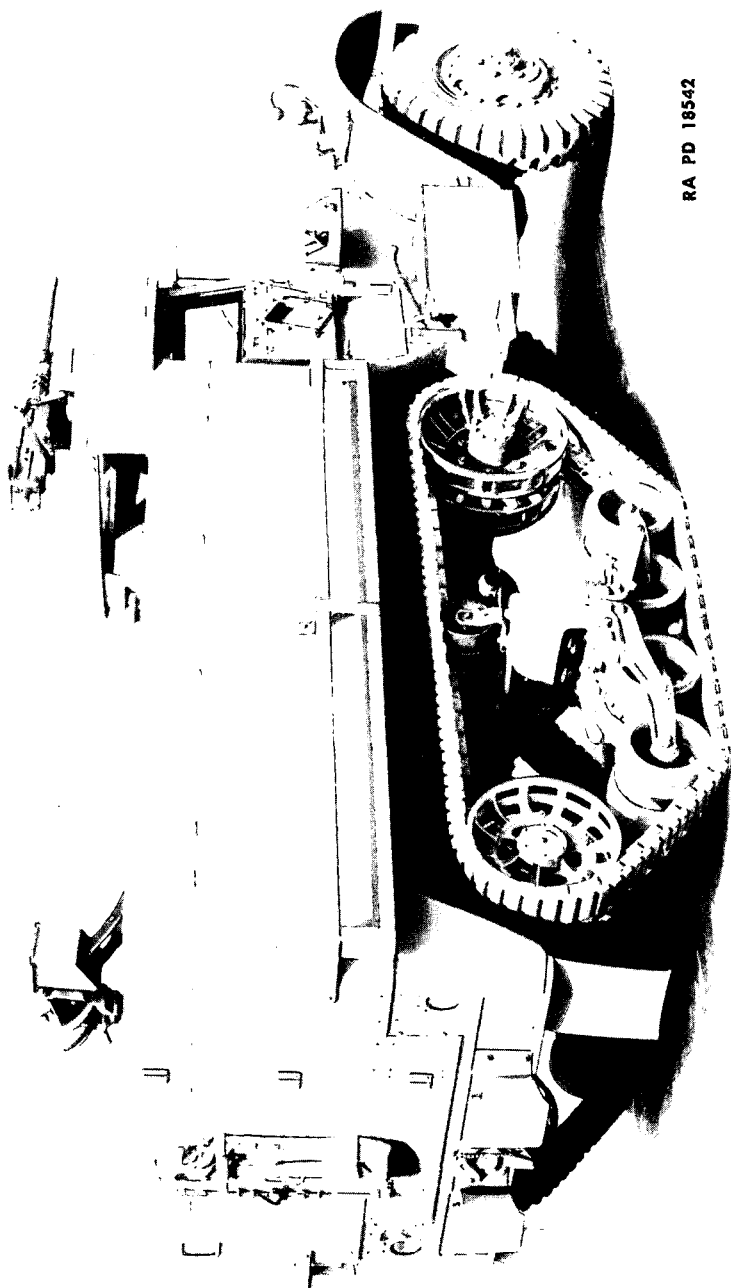

RA PD 18542

Figure 6 — Half-track Car M9A1 — Right Rear

BASIC HALF-TRACK VEHICLES (IHC) (PERSONNEL CARRIER M5, CAR M9A1, MULTIPLE GUN MOTOR CARRIAGE M14, AND SIMILAR IHC VEHICLES)

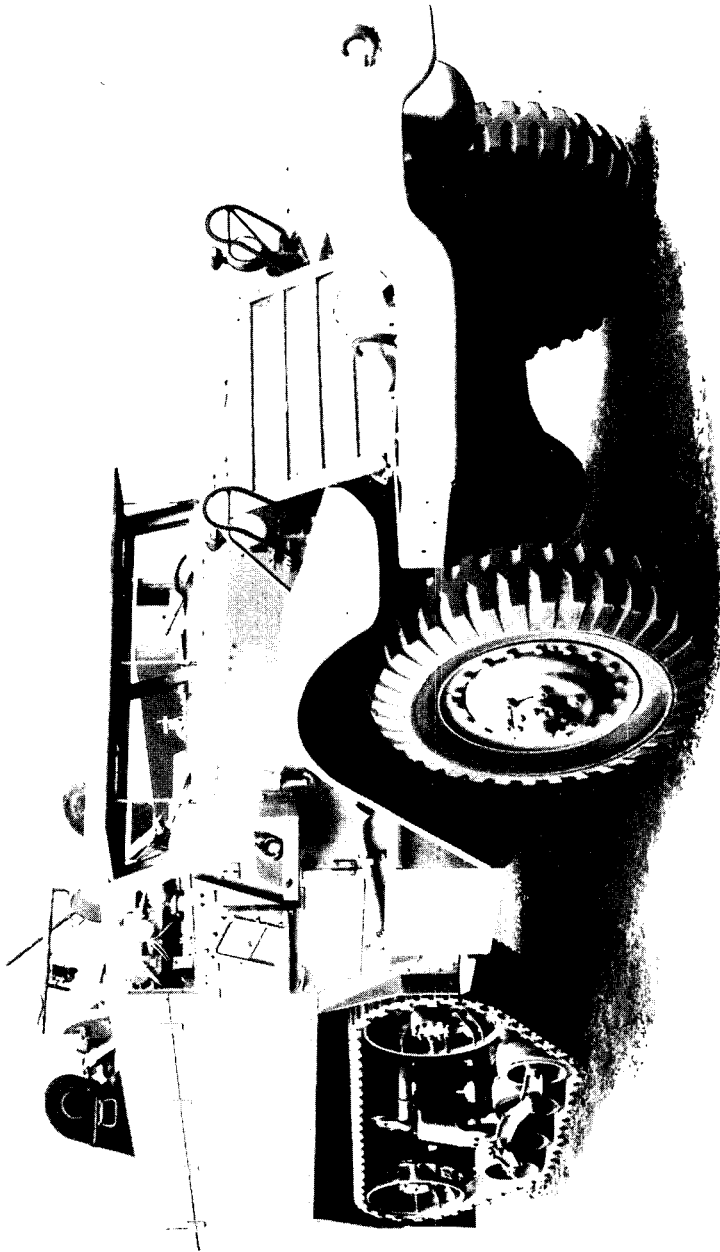

RA PD 18530

Figure 7 — Multiple Gun Motor Carriage M14 — Right Front

INTRODUCTION

RA PD 18531

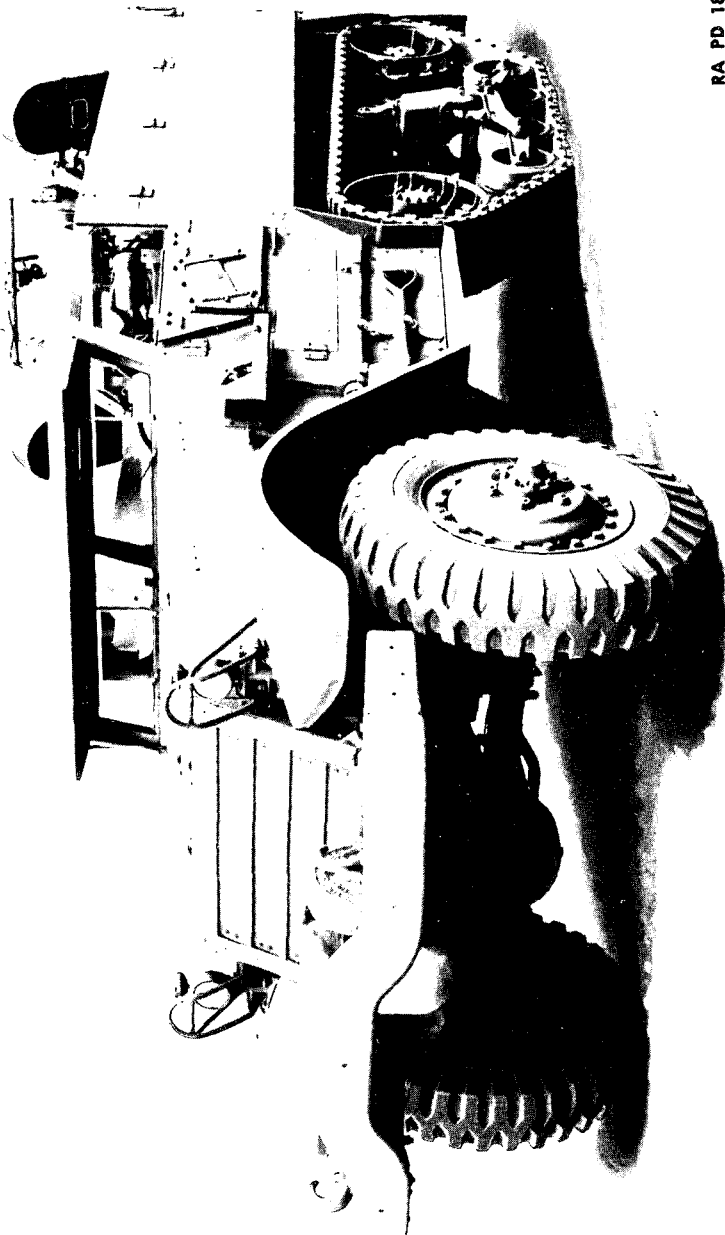
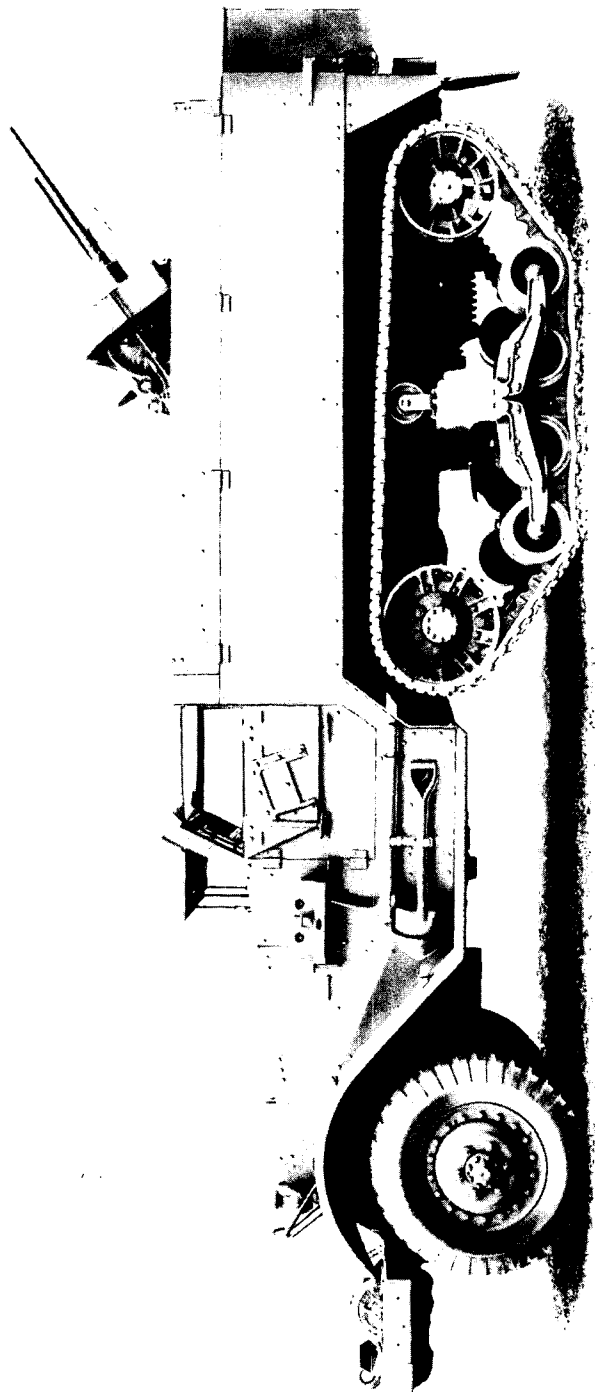

Figure 8 — Multiple Gun Motor Carriage M14 — Left Front

BASIC HALF-TRACK VEHICLES (IHC) (PERSONNEL CARRIER M5, CAR M9A1, MULTIPLE GUN MOTOR CARRIAGE M14, AND SIMILAR IHC VEHICLES)



RA PD 18532

Figure 9 — Multiple Gun Motor Carriage M14 — Left

INTRODUCTION

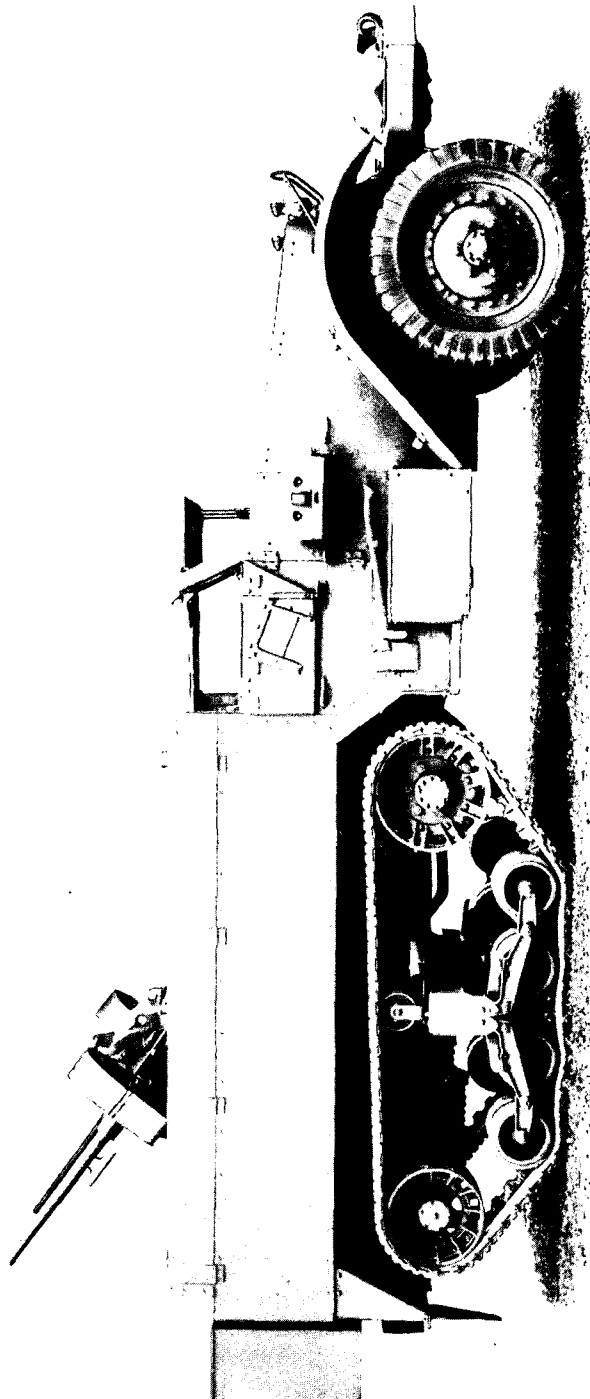

RA PD 18533

Figure 10 — Multiple Gun Motor Carriage M14 — Right

BASIC HALF-TRACK VEHICLES (IHC) (PERSONNEL CARRIER M5, CAR M9A1, MULTIPLE GUN MOTOR CARRIAGE M14, AND SIMILAR IHC VEHICLES)

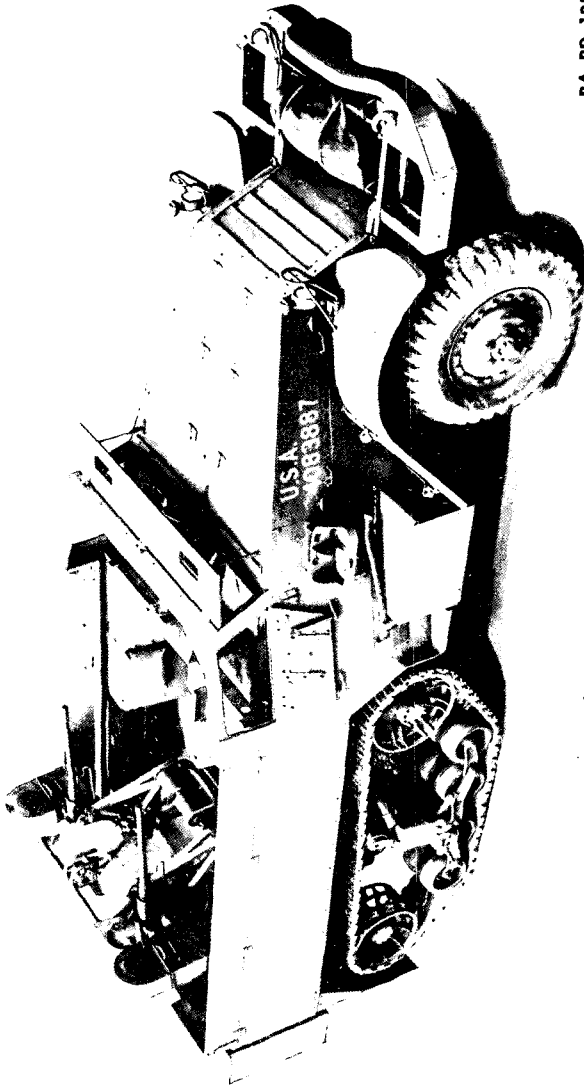

RA PD 18534

Figure 11 -- Multiple Gun Motor Carriage M14 -- Top

INTRODUCTION

f. Mobility. The vehicle is designed for travel on highways and cross-country and will negotiate steep grades and rough terrain provided traction is maintained. Approach and departure angles are illustrated in figures 12 and 13.

g. Body. The body is protected by $\frac{5}{16}$ -inch armor plate at the sides and rear. A folding armor shield on each door is provided to increase the height of the armor protection for the driver's compartment. These shields are hinged to the side doors and supported in the upright position by vertical rods latched to the doors. Vision slots are incorporated. The armor plate is replaceable on the hood and doors and is assembled with removable screws and safety nuts. The body armor plate is welded.

h. Louvres. Radiator louvres or shutters, made of $\frac{5}{16}$ -inch armor plate, are provided for protection of the radiator. The shutters are operated by a control lever at the right side of the driver's compartment. Three intermediate positions between fully open and fully closed are provided.

i. Hood. Top and side protection is afforded the engine by the armor plate hood which is made of two double panels hinged together to aid in opening. Two latches on each side panel secure the hood when closed.

j. Windshields (figs. 14 and 15). The shatterproof glass windshield is constructed of two sections which are held in position by six half-clamps and one full clamp. A protective shield of $\frac{5}{8}$ -inch armor plate is provided. This armor shield is hinged at the top to the windshield support frame and is held in the open position by three support rods. Before the windshield armor plate is lowered into the closed position, remove the two sections of the windshield.

(1) **WINDSHIELD BREAKAGE.** The cause of windshield breakage should be determined before replacing glass. Unless the glass is struck by some object, breakage may be caused by unusual twisting of the windshield frame members resulting from vibration.

(2) **WINDSHIELD REMOVAL.** To remove the windshield, loosen the clamps by unscrewing the wing nuts. To remove the windshield wiper blades, depress the spring clip at the bottom of the wiper arm and unhook the wiper arm from the shaft.

BASIC HALF-TRACK VEHICLES (IHC) (PERSONNEL CARRIER M5, CAR M9A1, MULTIPLE GUN MOTOR CARRIAGE M14, AND SIMILAR IHC VEHICLES)

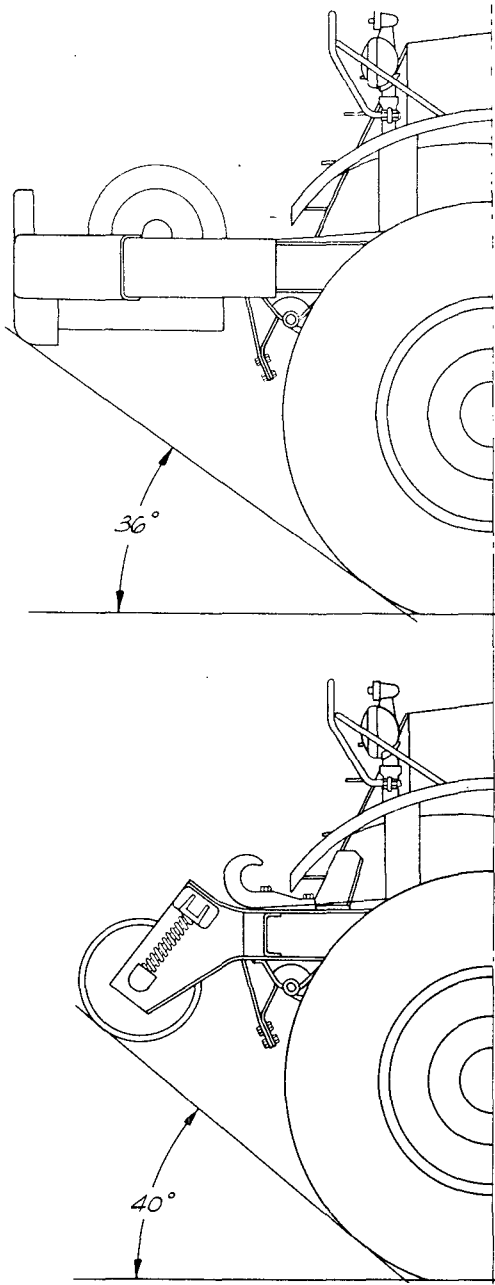

RA PD 18338

Figure 12 – Approach Angle

INTRODUCTION

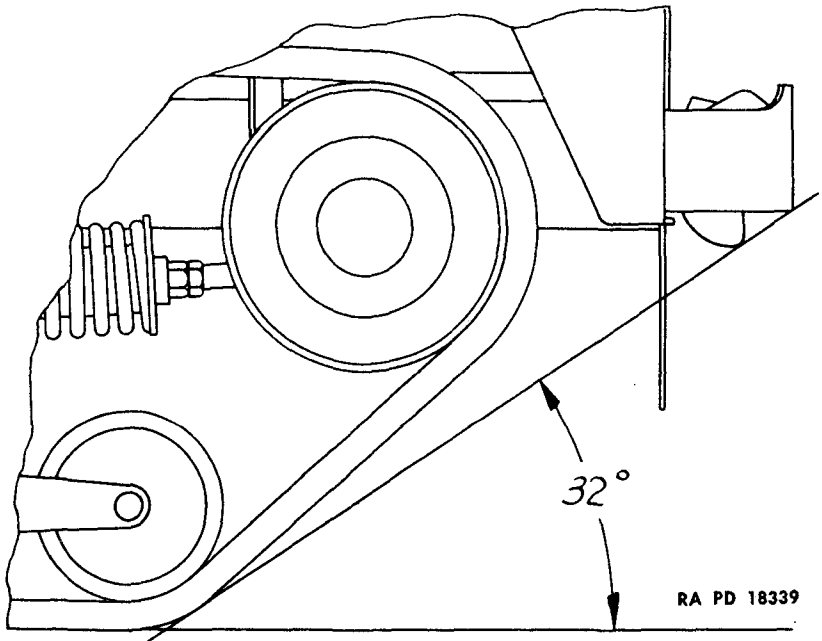

Figure 13 – Departure Angle

(3) **VISION SLOTS.** Two vision slots are provided in the armor shield. Each opening may be covered by a sliding panel of armor which is held in position by a thumbscrew.

k. Tarpaulin. A detachable canvas tarpaulin is supplied with the M14 vehicle to serve as a cover when desired.

l. Top (M5 and M9A1). The detachable canvas top is supported by three removable metal bows and the windshield frame. Removable side curtains with transparent windows are also provided. The top is secured by a series of strap fasteners that attach to footman loops around the sides of the body.

m. Seats. The driver's seat is adjustable, while the commander's seat is hinged and can be folded. The center seat backs can also be folded down. Loose seat cushions are provided for all seats. These cushions may be opened by slide fasteners and blankets may be inserted. All seat back covers are detachable for decontamination purposes.

BASIC HALF-TRACK VEHICLES (IHC) (PERSONNEL CARRIER M5, CAR M9A1, MULTIPLE GUN MOTOR CARRIAGE M14, AND SIMILAR IHC VEHICLES)

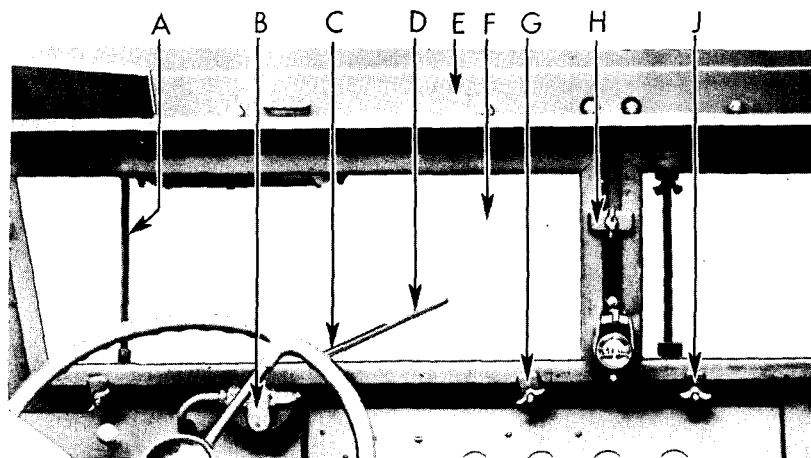

A—WINDSHIELD ARMOR LEFT SUPPORT ROD ASSEMBLY

B—WINDSHIELD WIPER ASSEMBLY

C—WINDSHIELD WIPER ARM

D—WINDSHIELD WIPER BLADE

E—WINDSHIELD HEADER

F—LEFT WINDSHIELD, WITH GLASS, ASSEMBLY

G—WINDSHIELD HALF CLAMP

H—WINDSHIELD FULL CLAMP

J—WINDSHIELD WING NUT

RA PD 18340

Figure 14 — Windshield Details

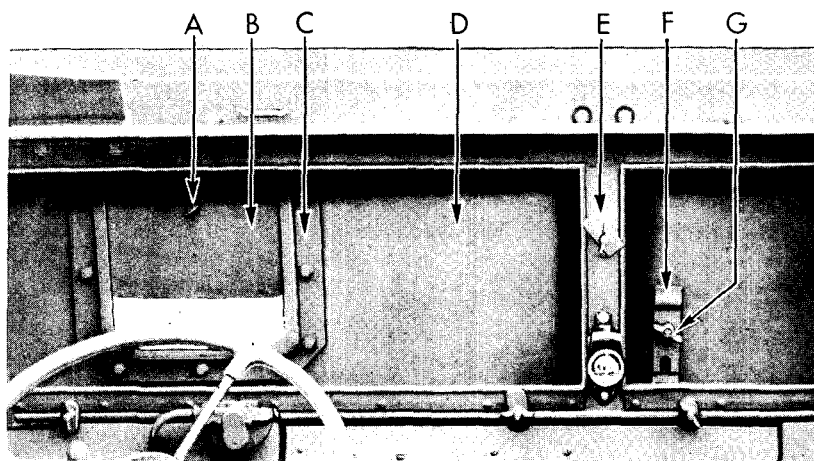

A—WINDSHIELD ARMOR PORT HOLE COVER THUMB SCREW

B—WINDSHIELD ARMOR PORT HOLE COVER

C—PORT HOLE COVER RETAINER

D—WINDSHIELD ARMOR PLATE ASSEMBLY

E—CENTER RETAINER

F—ARMOR PLATE RETAINING CLAMP

G—WING NUT

RA PD 18341

Figure 15 — Windshield Details — Armor

INTRODUCTION

4. TABULATED DATA.

a. Data indicating comparative size and performance of the vehicle is tabulated as follows:

(1) VEHICLE SPECIFICATIONS.

	M5	M9A1	M14
Wheel base (in.).....	135½	135½	135½
Length, over-all (roller-equipped) (in.).....	242¾ ₁₆	242¾ ₁₆	—
Length, over-all (winch-equipped) (in.).....	—	—	249¾ ₁₆
Width, over-all (in.).....	86¾ ₈	86¾ ₈	85¾ ₄
Weight, over-all (top of body) (in.).....	91	91	74½ (top of hull)
Wheel size (in.).....	20	20	20
Tire size	9.00-20	9.00-20	9.00-20
Track size (width) (in.).....	12	12	12
Tread (center to center):			
Front	66½	66½	66½
Rear	63 ¹³ / ₁₆	63 ¹³ / ₁₆	63 ¹³ / ₁₆
Crew	13	10	5
Weight of vehicle (winch-equipped):			
Net	15,900	16,050	16,200
Gross	18,900	19,050	19,200
Pay load	3,000	3,000	3,000
Weight of vehicle (roller-equipped):			
Net	15,400	16,050	—
Gross	18,900	19,050	—
Pay load	3,500	3,500	—
Ground clearance:			
Front (in.)	11¾ ₁₆	11¾ ₁₆	11¾ ₁₆
Rear (in.)	17¼	17¼	17¼
Pintle height (in.).....	29¾ ₁₆	29¾ ₁₆	29¾ ₁₆
Gasoline octane rating	70 to 72	70 to 72	70 to 72

BASIC HALF-TRACK VEHICLES (IHC) (PERSONNEL CARRIER M5, CAR M9A1, MULTIPLE GUN MOTOR CARRIAGE M14, AND SIMILAR IHC VEHICLES)

(2) **ARMAMENT.**

	M5	M9A1	M14
Machine gun, cal. .30 (pedestal mounted)	1	3	—
Submachine gun, cal. .45	1	1	1
Rifles, cal. .30	12	1	1
Machine gun, cal. .50 (ring mount)	—	1	—
Machine gun, cal. .50 (motor mount)	—	—	2 or 4
Carbines, cal. .30	—	—	3
Hand grenades	22	10	36
Land mines	26	14	—

(3) **PERFORMANCE.**

Speeds, maximum (transfer case) (mph):

	Low	High	Low	High	Low	High
1st gear	3.4	8.5	3.4	8.5	3.4	8.5
2nd gear	6.5	16.0	6.5	16.0	6.5	16.0
3rd gear	9.7	24.0	9.7	24.0	9.7	24.0
4th gear	16.9	42.0	16.9	42.0	16.9	42.0
Reverse	3.8	9.6	3.8	9.6	3.8	9.6

Approach angle

(roller equipped) (deg)	40	40	—
------------------------------	----	----	---

Approach angle

(winch equipped) (deg) ..	36	36	36
---------------------------	----	----	----

Departure angle (deg)

32	32	32
----	----	----

Turning radius:

Left	29 ft 10 in.	29 ft 10 in.	29 ft 10 in.
Right	27 ft 11 in.	27 ft 11 in.	27 ft 11 in.

Fording depth (in.)

31 $\frac{7}{8}$	31 $\frac{7}{8}$	31 $\frac{7}{8}$
------------------	------------------	------------------

Towing facilities:

Front	Tow hooks	Tow hooks	Tow hooks
Rear	Pintle	Pintle	Pintle

Maximum grade ascending ability (with 4,500 lb towed load, low gear, low range, dry slope) (percent)

60	60	60
----	----	----

INTRODUCTION

	M5	M9A1	M14
Maximum allowable speed (mph)	42	42	42
Maximum allowable engine speed (rpm)	2,600	2,600	2,600
Miles per gallon (minimum) (mph)	3.8	3.8	3.8
Cruising range (minimum) (miles)	225	225	225

(4) CAPACITIES.

Transmission and transfer case:			
Less power take-off (pt).....	17	17	17
With power take-off (pt).....	18½	18½	18½
Front Axle Differential (pt).....	10	10	10
Rear Axle Differential:			
Refill (pt)	8	8	8
Dry (pt)	9	9	9
Fuel (gal).....	60	60	60
Cooling system (qt).....	31	31	31
Crankcase:			
Dry (qt).....	10½	10½	10½
Refill (qt)	9	9	9
Winch gear case (pt).....	8	8	8
Air cleaner (pt).....	3¾	3¾	3¾
Front axle universal joint.....	2 lb 11 oz	2 lb 11 oz	2 lb 11 oz

(5) COMMUNICATIONS. Refer to section VI.

BASIC HALF-TRACK VEHICLES (IHC) (PERSONNEL CARRIER M5, CAR M9A1, MULTIPLE GUN MOTOR CARRIAGE M14, AND SIMILAR IHC VEHICLES)

Section II

DRIVING CONTROLS AND OPERATION

	Paragraph
Controls	5
Starting and warming up the engine	6
Operating the vehicle	7

5. CONTROLS (fig. 16).

a. The controls described in the following paragraphs are illustrated in this section. The driver must become thoroughly familiar with the location and use of all control devices before attempting to operate vehicle.

(1) **STEERING MECHANISM.** The vehicle is steered by use of a conventional type steering mechanism (fig. 265).

(2) **CLUTCH AND BRAKE PEDALS.** The pedals are of conventional type and are located in the usual positions relative to the base of the steering column.

(3) **CHOKER.** The choke control button is located at the left of the instrument panel. The control button is connected to the choke by cable. For normal operation, the button is pushed all the way in against the panel (fig. 16).

(4) **THROTTLE CONTROLS.** The throttle is controlled by a foot accelerator pedal and by a throttle control button located on the instrument panel at the left. The foot accelerator pedal is connected to the throttle by mechanical linkage and the hand control button is connected to the throttle by cable. Hand control is useful for starting but not for driving. The hand control is not affected by pedal operation but the pedal is actuated when the hand control is pulled out (fig. 16).

(5) **SHIFT LEVERS AND HAND BRAKE (figs. 272 and 273).** The transmission, transfer case, front axle engagement, and drive shaft brake levers are located and used in the customary manner. The ratios in the transfer case (auxiliary transmission) should not be changed when the vehicle is in motion.

(6) **RADIATOR SHUTTER.** The control lever for the radiator shutter is located at the right-hand side in the driver's compartment (fig. 16).

(7) **VENTILATORS.** The left and right ventilators below the dash are controlled by cable-connected buttons mounted on the instrument panel (fig. 16).

DRIVING CONTROLS AND OPERATION

(8) **WINDSHIELD WIPERS.** These devices are controlled by buttons at the base of the respective mechanisms when the engine is running (fig. 14).

6. STARTING AND WARMING UP THE ENGINE (figs. 16 and 17).

a. General Instructions. Before starting the engine, make the before operations service outlined in section IV. The procedure outlined below is satisfactory under average operating conditions:

(1) Set the hand brake securely and place the transmission gear shift lever in neutral (fig. 18).

(2) Check the selection of fuel tanks and make sure that the fuel transfer valve behind the driver's seat is open (fig. 231).

(3) Pull out the choke button; pull out the hand throttle button about one-quarter inch (fig. 16).

(4) Depress the clutch pedal to disengage the clutch and ease the starting load.

(5) Turn on the ignition and push the starter button (fig. 17).

(6) Release the starter the moment the engine begins to run. Never press the starter button for more than 10 to 15 seconds. If the engine has not started after two such trials, allow the starter to cool for at least a minute. If the engine fails to start or makes a false start, do not press the starter button again until the engine has come to a complete stop. Failure to observe this precaution, especially after a false start, may result in a broken starter motor drive housing.

(7) After the engine has started, slowly release the clutch and adjust the hand throttle and choke controls to prevent the engine from racing. As soon as the engine runs smoothly or warms up (approximately 140 F), push in the choke control. Excessive use of the choke will cause dilution of the engine oil. During the engine warm-up period, keep the radiator louvres closed and operate the engine at 800 to 1,000 revolutions per minute as indicated by the tachometer. The engine should have an idle speed of around 300 to 400 revolutions per minute as indicated by the tachometer (fig. 16).

b. Starting Hints.

(1) If the starter engages the engine flywheel but the engine fails to start after repeated attempts, follow procedure given in paragraph 106 a (10).

(2) If the starter device engages the engine flywheel and locks, release the starter push button, turn off the ignition, place the transmission in high gear, release the brake, and push with another vehicle.

BASIC HALF-TRACK VEHICLES (IHC) (PERSONNEL CARRIER M5, CAR M9A1, MULTIPLE GUN MOTOR CARRIAGE M14, AND SIMILAR IHC VEHICLES)

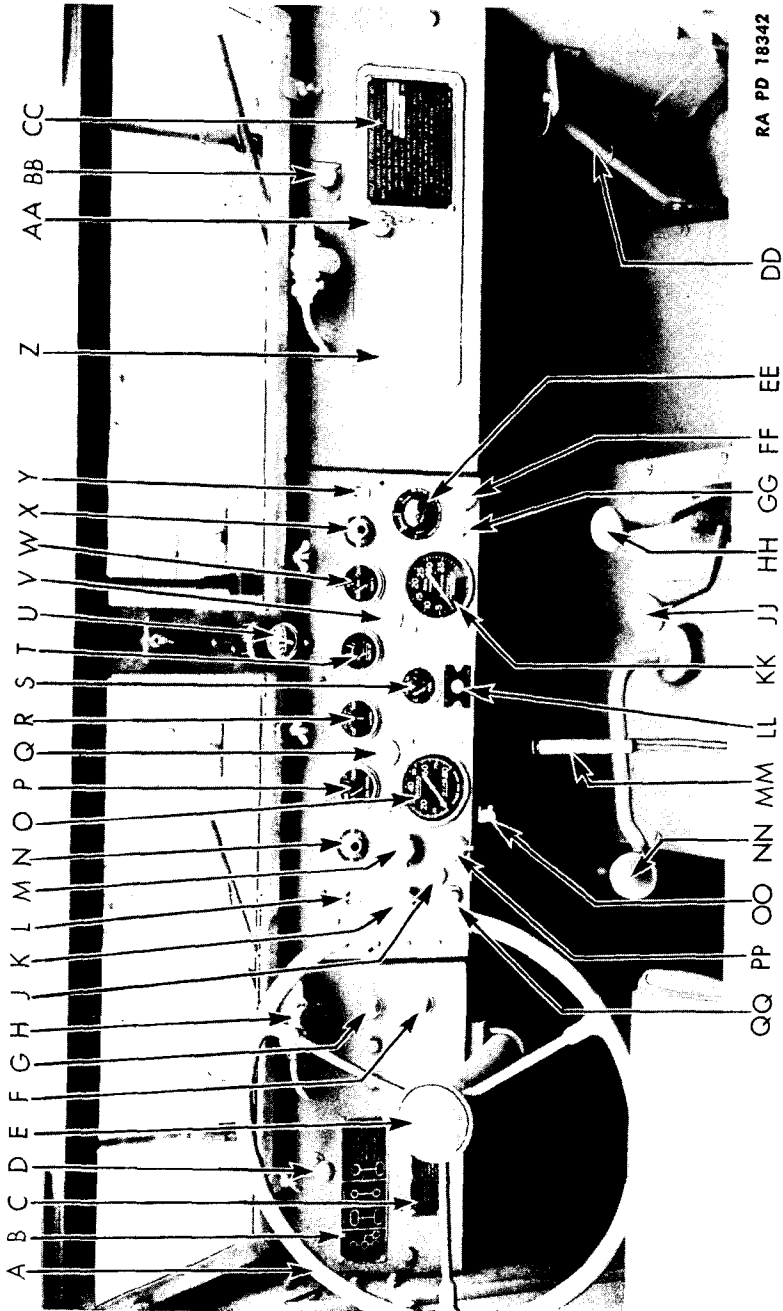

Figure 16 — Details of Driver's Compartment

DRIVING CONTROLS AND OPERATION

- | | |
|--------------------------------------|----------------------------------------------|
| A--STEERING WHEEL | V--PANEL LIGHT COVER |
| B--GEAR SHIFT INSTRUCTION PLATE | W--COOLANT TEMPERATURE GAGE |
| C--WINCH OPERATION CAUTION PLATE | X--COOLANT TEMPERATURE WARNING LIGHT |
| D--COMPARTMENT VENT CONTROL | Y--INSPECTION LAMP SOCKET |
| E--HORN BUTTON | Z--MAP COMPARTMENT DOOR |
| F--THROTTLE CONTROL | AA--MAP COMPARTMENT DOOR LOCK |
| G--CHOKE CONTROL | BB--AIR CLEANER CONTROL |
| H--WINDSHIELD WIPER ASSEMBLY | CC--VEHICLE REGISTRATION PLATE |
| J--PANEL LIGHT SWITCH | DD--RADIATOR SHUTTER CONTROL LEVER |
| K--BLACKOUT DRIVING LAMP SWITCH | EE--RHEOSTAT LOAD CONTROL FOR TRAILER BRAKES |
| L--INSPECTION LAMP SOCKET | FF--MAP READING LAMP |
| M--BLACKOUT AND SERVICE LIGHT SWITCH | GG--MAP READING LAMP SWITCH |
| N--OIL PRESSURE WARNING LIGHT | HH--FRONT AXLE SHIFT LEVER |
| O--SPEEDOMETER | JJ--TRANSFER CASE SHIFT LEVER |
| P--OIL PRESSURE GAGE | KK--TACHOMETER |
| Q--PANEL LIGHT COVER | LL--FUEL TANK SELECTOR SWITCH |
| R--AMMETER | MM--HAND BRAKE LEVER |
| S--FUEL GAGE | NN--TRANSMISSION SHIFT LEVER |
| T--VOLTMETER | OO--SPEEDOMETER RE-SET SHAFT |
| U--COMPASS | PP--IGNITION SWITCH |
| | QQ--STARTER BUTTON |

RA PD 18342B

Legend for Figure 16 -- Details of Driver's Compartment

BASIC HALF-TRACK VEHICLES (IHC) (PERSONNEL CARRIER M5, CAR M9A1, MULTIPLE GUN MOTOR CARRIAGE M14, AND SIMILAR IHC VEHICLES)

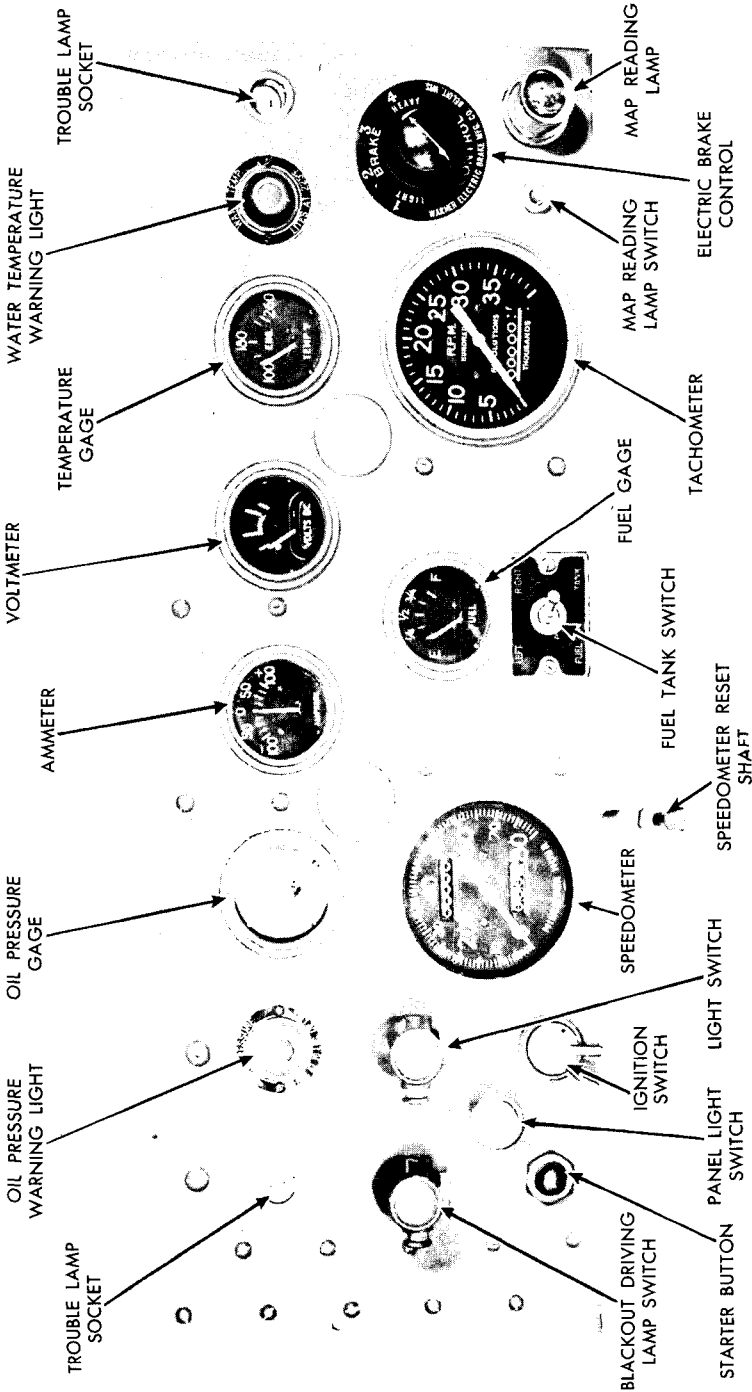

RA PD 18538

Figure 17 — Instrument Panel

DRIVING CONTROLS AND OPERATION

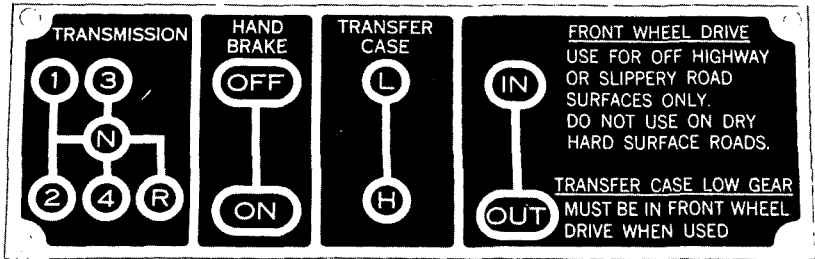

RA PD 18212

Figure 18 — Shift Diagram Plate

If the gear still sticks, loosen the starting motor mounting screws and shake the starting motor until its gear releases. Retighten the starting motor mounting screws and test the starter again.

(3) If the starter does not turn, but the lights dim when the starting button is depressed, the starter bearings may be gummed or “frozen” (par. 106).

(4) Towing of a vehicle to start should only be done in an emergency. Prior to towing the vehicle, the engine should be turned over by hand three or four revolutions. The towing vehicle should be placed in low gear. The vehicle to be towed should be placed in high gear. The engine should be primed or choked. After the vehicle starts moving, the clutch of the towed vehicle should be engaged smoothly. After the engine starts turning over, the ignition switch should be turned on.

7. OPERATING THE VEHICLE.

a. **Starting on Level Ground.** After the engine has been thoroughly warmed up and checked for satisfactory operation, start the vehicle moving as follows:

- (1) Release the hand brake.
- (2) Disengage the clutch fully.
- (3) Disengage the front axle drive.
- (4) Move the transfer case shift lever into high position.
- (5) Move the transmission gearshift lever to the selected position (fig. 18).
- (6) Release the clutch pedal gradually, and at the same time slowly depress the accelerator pedal to increase the speed of the engine. Do not race the engine.

b. **Starting on a Grade.** If the vehicle is on a grade, one method of starting is as follows:

- (1) Disengage the clutch fully.

BASIC HALF-TRACK VEHICLES (IHC) (PERSONNEL CARRIER M5, CAR M9A1, MULTIPLE GUN MOTOR CARRIAGE M14, AND SIMILAR IHC VEHICLES)

(2) Select low or high speed position of the transfer case gearshift, depending on the situation and the transmission gear ratio.

(3) Move the gearshift lever to the first speed position.

(4) Gradually engage the clutch, release hand brake as engine picks up load, and accelerate the engine by means of the foot accelerator.

c. Gearshifts. Practice will enable a driver to judge at what rates of speed the vehicle should be moving before he shifts from a lower to a higher speed. An engine should never be permitted to labor unduly when a change in gear ratios would improve operation.

(1) **TRANSMISSION.** To shift gears from any speed to a lower speed ratio, disengage the clutch, make the shift to the next lower position, engage the clutch, and at the same time depress the accelerator to maintain engine speed. Bring vehicle to a halt when attempting to shift into reverse. Depress clutch pedal fully. Shift lever into reverse, being sure that it is brought to its extreme rearward position, and then gradually release the clutch pedal (figs. 12 and 273).

(2) **TRANSFER CASE.** When the transfer case low gear is used, the front axle drive should be engaged. To shift the auxiliary transmission (transfer case) from high (direct) to low (under-drive) for heavy going, stop the vehicle, disengage the clutch, shift the main transmission to second gear, shift the transfer case gears, lightly engaging and disengaging the clutch, and then fully engage the clutch to operate the vehicle. Shift the main transmission from second to third and high as the operation permits. When the vehicle is operated at extremely low speeds for considerable distances, use low gear of the transfer case with the front axle drive engaged. When the vehicle is being operated with the under-drive and it is desired to shift back to the direct range, stop the vehicle if conditions permit. Disengage the clutch and shift the transfer case gears. If conditions do not permit stopping the vehicle, the shift can be made with the vehicle in motion. Disengage the clutch, shift the transfer case gears, and reengage the clutch carefully to prevent shock to the propelling mechanism (figs. 18 and 270).

d. Cautions.

(1) Do not ride the clutch. The driver's foot should rest on the clutch only when he is operating it.

(2) Do not engage the clutch suddenly. A sudden engagement is injurious to the mechanism and may stall the engine.

(3) When the clutch is to be disengaged, it should be disengaged fully to avoid gear damage and shifting difficulties.

DRIVING CONTROLS AND OPERATION

(4) In shifting from one speed ratio to another, do not skip positions.

e. Front Axle Drive. The front axle drive should be engaged and the transfer case placed in low range before the vehicle leaves hard surfaced roads to negotiate hazardous conditions. Driven by wheels and tracks, a vehicle can traverse a stretch of mud, snow, ice, or sand which it could not negotiate generally with the rear drive only.

(1) **ENGAGING FRONT AXLE DRIVE.** If the engagement cannot be made readily, try shifting while turning the vehicle to right or left. The gears involved turn at slightly different speeds while the vehicle negotiates a turn, the difference in their speeds permitting them to engage. Do not force the shifting lever.

(2) **DISENGAGING FRONT AXLE DRIVE.** It is generally found more difficult to disengage the front axle drive than to engage it. Action is aided by exerting a moderate manual effort on the shift lever while the vehicle is rolling slowly in first or reverse gear and with front wheels straight ahead. Avoid sudden shock to the driving parts when in low gear. Every effort must be made to prevent sudden shock to the driving clutch at any time, and especially if the vehicle rolls backward, no matter how slowly. **CAUTION:** If there is any tendency for the vehicle to roll backwards on a moderate or steep grade and it is desired to get under way, proceed as outlined in subparagraph **b** above. If it is not convenient to block the wheels, and should conditions permit, by all means allow the vehicle to coast back, under control of the brakes, to a standstill before attempting to start forward. Failure to observe these simple precautions will result in snapping of drive shaft gears and shafts.

f. Braking. Intermittent application will reduce the wear of brake linings and drums. Application should be gradual with just enough force to accomplish the desired result. **CAUTION:** In anticipating a stop, the driver should make full use of the engine braking effect, disengaging the clutch in time to avoid stalling the engine. When descending hills, the driver should use the engine as a brake by using the proper gear ratio and applying the brakes from time to time to prevent overspeeding the engine. The ignition should not be turned off. The engine speed when descending a hill should be no greater than 2,600 revolutions per minute. On steep hills the gear necessary to give the desired results should be engaged before the vehicle is started up or down the hill. Attempting to shift gears after the vehicle has started down a steep slope may result in a runaway vehicle.

(1) **MOISTURE EFFECT.** After passing through water, the brakes should be set slightly and the vehicle operated until sufficient heat has been generated to dry the brakes.

BASIC HALF-TRACK VEHICLES (IHC) (PERSONNEL CARRIER M5, CAR M9A1, MULTIPLE GUN MOTOR CARRIAGE M14, AND SIMILAR IHC VEHICLES)

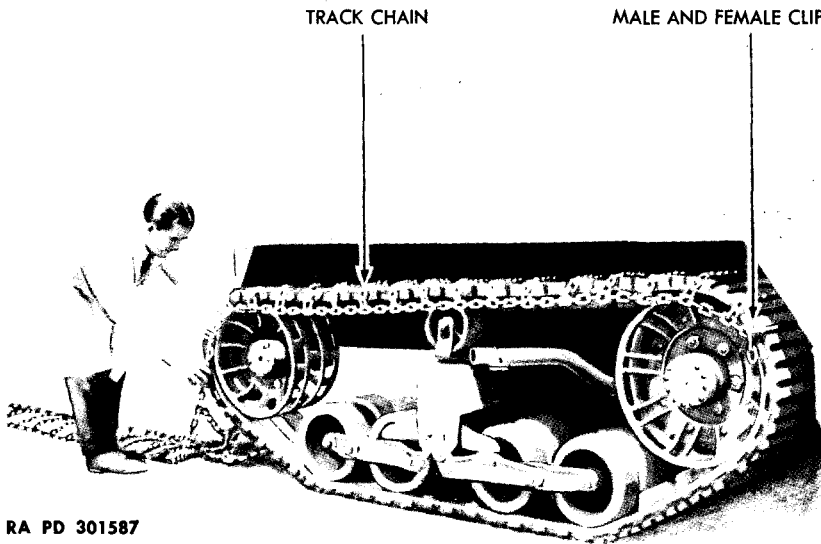

RA PD 301587

Figure 19 – Track Chain Installation

g. Stopping the Vehicle. Release the gas throttle, apply the foot brake, release the clutch, and shift the transmission into neutral. Do not retard the vehicle speed by disengaging and engaging the clutch.

h. Traction Aids. Chains should always accompany the vehicle. They should be kept in serviceable condition to permit installation with a minimum of delay. Remove promptly when no longer necessary, in order to prevent unnecessary damage to tires and roads.

(1) **CHAINS.** The chains should be applied before the vehicle becomes mired, and in such a manner that rotation of the wheel tends to close the chain fasteners. If chains are improperly installed, rotation of the wheels opens the chain fasteners and the chains will be lost. Chains must be installed on both wheels. Chains and chain applicators are provided for the tracks (fig. 19). **NOTE:** Chains should not be installed on tracks having lugs for grouser attachment without first grinding off the lugs.

i. Track Chain Installation.

- (1) Check the chain and eliminate any incorrect twists.
- (2) Center the end of chain which has four free links between the idler sprocket and the top guide wheel on the rear section of the track. The rest of the chain should trail in back of vehicle.
- (3) Pass the shorter leg of the male portion of the applier through

DRIVING CONTROLS AND OPERATION

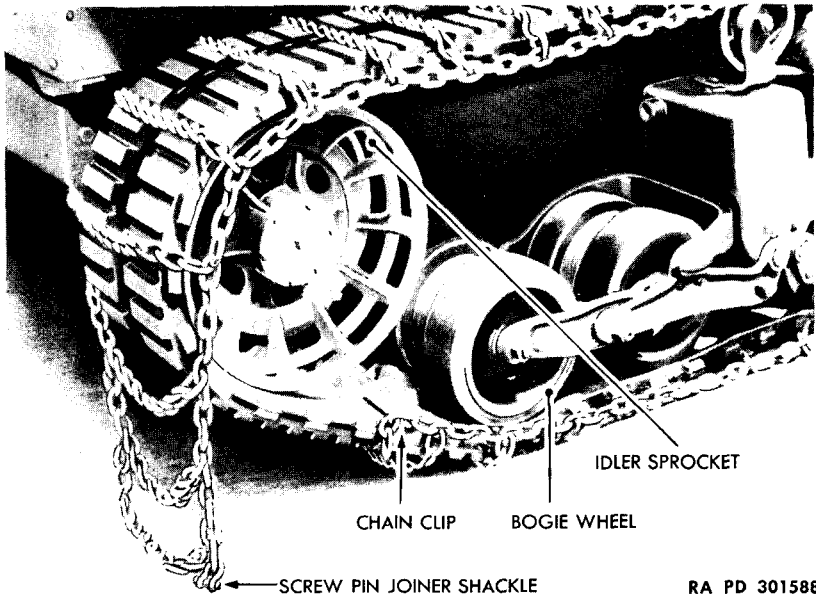

Figure 20 — Securing Track Chain

the third link of the inner side chain, then slide it onto the track as far as possible with the longer leg on the tread side of the track.

(4) Pass the shorter leg of the female portion of the applier through the third link of the outside side chain; then push this clip or applier onto the track directly opposite the male portion with the longer leg on the tread side of the track.

(5) Slip the female portion over the long end of the male clip and push both tight against the edges of the track.

(6) Straighten the rest of the chain behind the vehicle to line up with the track.

(7) Place transmission in first gear, low range, and move vehicle forward very slowly. A man in the rear of each track should feed the chains evenly onto the tracks. **NOTE:** Extreme care must be used by the men feeding the chains onto the tracks so that their hands or feet do not get caught in the chain.

(8) Stop the vehicle when clips are centered between the rear bogie wheel and the idler sprocket. If in mud, bring clips around to starting position (fig. 20).

(9) Remove male and female portions of applier and fasten ends of chain together with screw pin joiner shackles provided. Do not mislay the appliers. Stow in vehicle compartment for future use.

(10) Before vehicle is moved at high speeds, check installation after complete assembly to make sure of clearance between chain and

BASIC HALF-TRACK VEHICLES (IHC) (PERSONNEL CARRIER M5, CAR M9A1, MULTIPLE GUN MOTOR CARRIAGE M14, AND SIMILAR IHC VEHICLES)

any part of vehicle. **NOTE:** Chains should be applied as tight as possible by hand. If driving continually, check chains occasionally and take up any excess slack in side chains.

j. Care of Chains When Removed. When removed, chains should be cleaned and dipped in oil, and replaced in vehicle stowage compartment in an orderly manner for future use.

k. Front Wheel Chain Installation.

(1) Inspect chains and eliminate any incorrect twists.

(2) Drape the tire chain over the tire with the gap between cross chains four and five (counting from either end of side chain) coming directly on the top of the tire. Side chain with rod attached must be on the inside of wheel.

(3) Shift the rod end of the chain toward the inside of the wheel and place the rod within easy reach of the last link on the inside side chain. **NOTE:** On the one side of the vehicle the rod is thrust from front to rear. On the other side, the rod is thrust from rear to front.

(4) Hook the rod onto the last link of the inner side chain.

(5) Readjust the chain on the tire.

(6) Fasten the outer side chain. The links hanging free must always be away from the tire.

Section III

**AUXILIARY EQUIPMENT CONTROLS AND
OPERATION (WINCH)**

	Paragraph
General	8
Winch controls	9
Winch operation	10
Winch lubrication	11

8. GENERAL (figs. 21, 22, and 23).

a. The Multiple Gun Motor Carriage M14 is equipped with a winch mounted on the front of the frame. Power for winch operation is supplied by the engine of the vehicle by a power take-off unit mounted on the side of the transmission. The winch can be used as an auxiliary source of power to help lift or move a mired vehicle. It can be used to move another vehicle or the vehicle on which it is mounted by rigging the winch cable and snatch block to suitable anchorage.

9. WINCH CONTROLS.

a. The winch is controlled by a lever in the driver's compartment and a clutch shifter fork handle mounted on the winch. The lever is locked in neutral position by a safety catch which must be lifted before the lever can be moved.

10. WINCH OPERATION.

a. **To Hook On.** Disengage drum clutch control and pull off required amount of cable. If the line is under too much of a strain to permit the unrolling as described, depress vehicle clutch pedal and shift power take-off into reverse (full rearward position of lever). Slowly release vehicle clutch pedal.

b. **To Pull.** Engage drum clutch control, depress vehicle clutch pedal, shift power take-off into forward speed, then release vehicle clutch pedal. Speed of winch operation is controlled by the vehicle engine speed.

c. **To Stop Winch.** Depress vehicle clutch pedal and shift power take-off into neutral (mid-position of lever). The load will be held by the winch brake.

BASIC HALF-TRACK VEHICLES (IHC) (PERSONNEL CARRIER M5, CAR M9A1, MULTIPLE GUN MOTOR CARRIAGE M14, AND SIMILAR IHC VEHICLES)

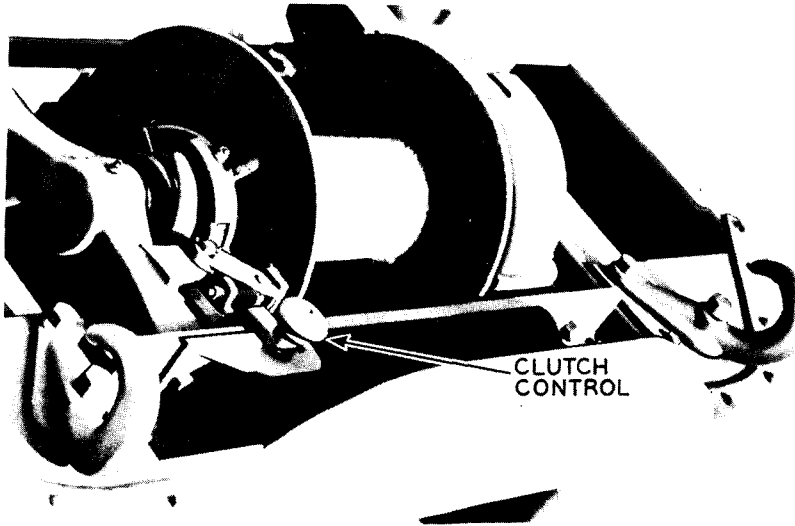

RA PD 18548

Figure 21 — Winch Installed — Less Cable — Right Side

d. To Release or Reverse Load. Depress vehicle clutch pedal and shift power take-off into reverse (full rearward position of lever). Release vehicle clutch pedal.

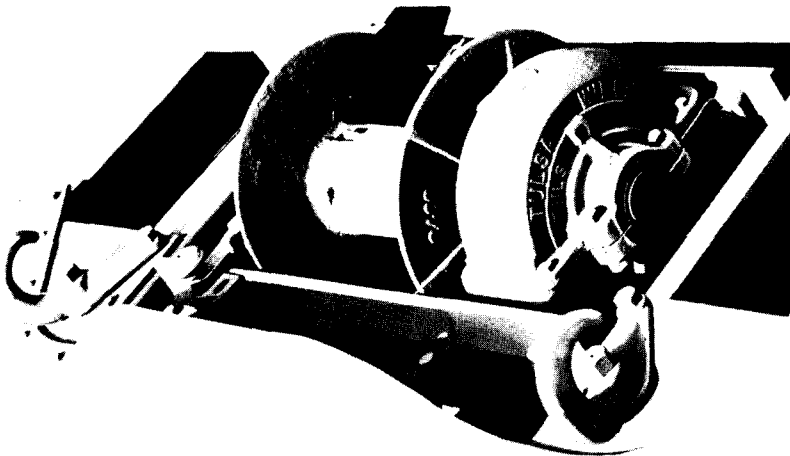

RA PD 18549

Figure 22 — Winch Installed — Less Cable — Left Side

AUXILIARY EQUIPMENT CONTROLS AND OPERATION (WINCH)

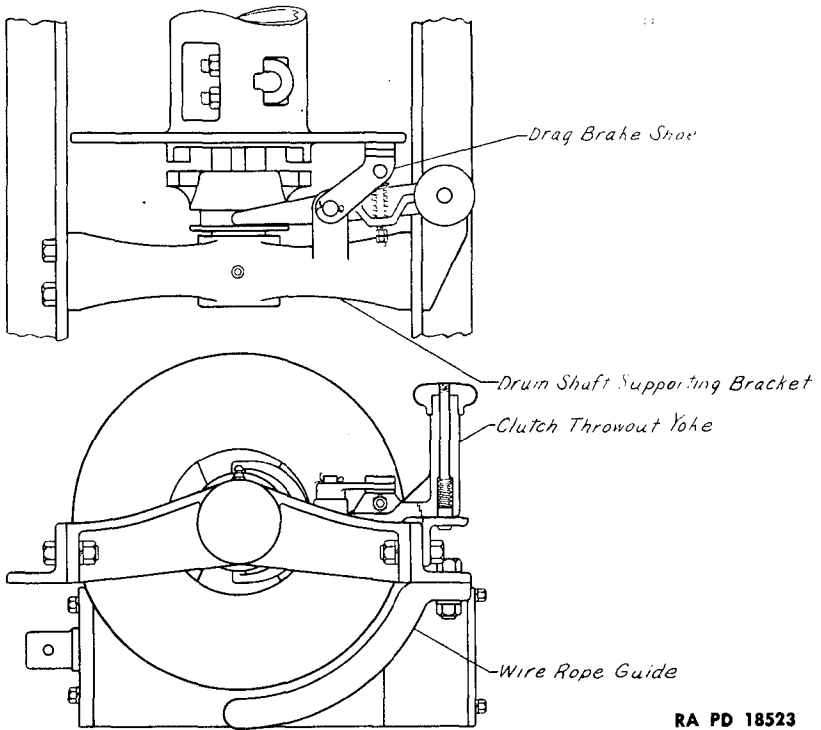

Figure 23 – View of Winch Showing Drum Clutch and Drag Brake

RA PD 18523

11. WINCH LUBRICATION.

a. The correct lubricants and intervals for the lubrication of this winch is outlined in the War Department Lubrication Guide (fig. 24 and par. 22).

BASIC HALF-TRACK VEHICLES (IHC) (PERSONNEL CARRIER M5, CAR M9A1, MULTIPLE GUN MOTOR CARRIAGE M14, AND SIMILAR IHC VEHICLES)

Section IV

INSPECTION AND PREVENTIVE MAINTENANCE SERVICE

	Paragraph
Purpose	12
Reports	13
Before operation service	14
During operation service	15
At halt service	16
After operation and weekly service	17
Second echelon preventive maintenance basic instructions	18
Second echelon general procedures	19
Procedure for 1,000-mile (monthly) and 6,000-mile (6-month) maintenance service	20

12. PURPOSE.

a. To insure mechanical efficiency, it is necessary that vehicle be systematically inspected at intervals in order that defects may be discovered and corrected before they result in serious damage. Certain scheduled maintenance services will be performed at these designated intervals. The services set forth in this section are those performed by driver or crew, before operation, during operation, at halt, after operation, and weekly.

b. Driver preventive maintenance services are listed on the back of "Driver's Trip Ticket" and Preventive Maintenance Service Record WD Form No. 48 to cover vehicles of all types and models. Items peculiar to specific vehicles but not listed on WD Form No. 48 are covered in manual procedures under the items with which they are related. Certain items listed on the form that do not pertain to the vehicle involved are eliminated from the procedures as written into the manual. Every organization must thoroughly school each driver in performing the maintenance procedures set forth in manuals whether they are listed specifically on WD Form No. 48 or not.

c. The items listed on WD Form No. 48 that apply to this vehicle are expanded in this manual to provide specific procedures for accomplishment of the inspections and services. These services are arranged to facilitate inspection and conserve the time of the driver, and are not necessarily in the same numerical order as shown on WD Form No. 48. The item numbers, however, are identical with those shown on that form.

INSPECTION AND PREVENTIVE MAINTENANCE SERVICE

d. The general inspection of each item applies also to any supporting member or connection, and generally includes a check to see whether the item is in good condition, correctly assembled, secure, or excessively worn.

(1) The inspection for "good condition" is usually an external visual inspection to determine whether the unit is damaged beyond safe or serviceable limits. The term good condition is explained further by the following terms: not bent or twisted, not chafed or burned, not broken or cracked, not bare or frayed, not dented or collapsed, not torn or cut.

(2) The inspection of the unit to see that it is "correctly assembled" is usually an external visual inspection to see whether it is in its normal assembled position in the vehicle.

(3) The inspection of a unit to determine if it is "secure" is usually an external visual examination, a hand-feel, or a pry-bar check for looseness. Such an inspection should include any brackets, lock washers, lock nuts, locking wires, or cotter pins used in assembly.

(4) "Excessively worn" will be understood to mean worn, close to or beyond serviceable limits, and likely to result in a failure if not replaced before the next scheduled inspection.

13. REPORTS.

a. The Chief of Ordnance should be advised through the local ordnance officer of any chronic troubles or technical failures. Any suggestion for the improvement of the service procedure based on actual operating experience should likewise be forwarded so that all units may benefit.

14. BEFORE OPERATION SERVICE.

a. This inspection schedule is designed primarily as a check to see that the vehicle has not been tampered with, or sabotaged since the after operation service was performed. Various combat conditions may have rendered the vehicle unsafe for operation and it is the duty of the driver to determine whether or not the vehicle is in condition to carry out any mission to which it is assigned. This operation will not be entirely omitted, even in extreme tactical situations.

b. **Procedures.** Before operation service consists of inspecting items listed below according to the procedure described, and correcting or reporting any deficiencies. Upon completion of the service, results should be reported promptly to the designated individual in authority.

(1) **ITEM 1, TAMPERING OR DAMAGE.** Look for any injury to vehicle or armament, and for signs of load shifting or tampering with vehicle load

BASIC HALF-TRACK VEHICLES (IHC) (PERSONNEL CARRIER M5, CAR M9A1, MULTIPLE GUN MOTOR CARRIAGE M14, AND SIMILAR IHC VEHICLES)

or load fastenings. Tarpaulins must be fastened securely. Raise hood, look for signs of tampering or sabotage. To facilitate starting, dry spark plugs, distributor, and wiring, if they appear wet.

(2) **ITEM 2, FIRE EXTINGUISHERS.** Shake to be sure they are fully charged. Mount securely.

(3) **ITEM 3, FUEL, OIL, AND WATER LEAKS.** Look at all filler points for tampering or foreign material put in. Add as need is indicated by fuel gage, oil dipstick, or lack of water in filler neck.

(4) **ITEM 4, ACCESSORIES AND DRIVES.** See that they are secure, not damaged, and in alignment; see that the fan belts are in good condition and adjusted to ½-inch deflection.

(5) **ITEM 6, LEAKS; GENERAL.** Look on ground under vehicle for fuel oil, brake fluid, or grease. Trace any indications to source and correct.

(6) **ITEM 7, CHOKE.** Work control through entire travel for ease of operation. Observe effectiveness when starting engine.

(7) **ITEM 8, ENGINE WARM-UP.** Observe any tendency toward hard starting and low cranking speed, and if starting motor engages and disengages readily without unusual noise. Idle engine only fast enough to run smoothly; close choke as engine warms up.

(8) **ITEM 9, OIL PRESSURE GAGE.** Watch for unusually low or no oil pressure, or if there is unusual fluctuation of indicator; if one of these conditions is observed, *stop engine immediately* and report.

(9) **ITEM 9, AMMETER.** High (+) charging rate for first few minutes after starting. Zero or slight positive (+) charge at idling speed with lights and accessories off is normal. Any unusual drop or continued high (+) rate indicates defect in electrical system.

(10) **ITEM 9, TEMPERATURE GAGE.** Gradual increase in temperature during warm-up indicates correct operation. Normal temperature is 160 F to 185 F for warm engine.

(11) **ITEM 10, HORN AND WINDSHIELD WIPERS.** If tactical situation permits, sound horn and observe tone. See that windshield wiper arms and blades are not bent or damaged. Operate to be sure of functioning. Wiper motors must be secure.

(12) **ITEM 11, GLASS AND REAR VISION MIRRORS.** Wipe windshield, rear vision mirror, and instrument glass thoroughly clean and inspect for damage. Adjust rear view mirror.

INSPECTION AND PREVENTIVE MAINTENANCE SERVICE

(13) **ITEM 12, LAMPS.** Lamps must be securely mounted. If tactical situation permits, operate all lamp switches. Lamps must light when on. Lights must not remain lighted when *off*. Apply brake pedal to be sure the stop light operates. Lens must be clean and unbroken, reflectors not corroded.

(14) **ITEM 13, WHEEL AND FLANGE NUTS.** See that all are present and secure.

(15) **ITEM 14, TIRES AND TRACKS.** Tires: 70 pounds pressure, maximum, when cool. Look for damage and see that there are no embedded objects in treads or carcass. See that track tension is satisfactory and there are no embedded objects in treads and between tracks and bogie units.

(16) **ITEM 15, SPRINGS AND SUSPENSIONS.** See that they are secure and not damaged.

(17) **ITEM 16, STEERING LINKAGE.** Steering gear case and all connecting linkage must be secure, not damaged, and no lubricant leaks in evidence.

(18) **ITEM 17, FENDERS AND BUMPERS.** Observe for damage and looseness.

(19) **ITEM 18, TOWING CONNECTIONS.** See that they are secure and locked, not damaged; electric cables connected and supported; safety switch connected between motor vehicle and towed vehicle.

(20) **ITEM 19, BODY, LOAD, AND TARPAULINS.** Inspect for condition and security.

(21) **ITEM 20, DECONTAMINATOR.** Fully charged and securely mounted.

(22) **ITEM 21, TOOLS AND EQUIPMENT.** Check against vehicle stowage lists to be sure all items are present, serviceable, and properly stowed.

(23) **ITEM 22, ENGINE OPERATION.** Should idle smoothly. Accelerate and decelerate the engine and listen for any unusual noise that may indicate compression or exhaust leaks, worn, damaged, loose, or inadequately lubricated engine parts or accessories. Note any unusual smoke from the exhaust.

(24) **ITEM 23, DRIVER'S PERMIT AND STANDARD ACCIDENT FORM No. 26.** Present and legible.

(25) **ITEM 25, DURING OPERATION CHECK.** As the vehicle is first put into motion, begin the observations of the during operation service immediately in the nature of a road test.

BASIC HALF-TRACK VEHICLES (IHC) (PERSONNEL CARRIER M5, CAR M9A1, MULTIPLE GUN MOTOR CARRIAGE M14, AND SIMILAR IHC VEHICLES)**15. DURING OPERATION SERVICE.**

a. While the vehicle is in motion, listen for any sounds such as rattles, knocks, squeals, or hums that may indicate trouble. Look for indications of trouble in cooling system and smoke from any part of the vehicle. Be on the alert to detect any *odor* of overheated components or units such as generator, brakes or clutch, fuel vapor from a leak in fuel system, exhaust gas or other signs of trouble. Any time the brakes are used, gears shifted, or vehicle turned, consider this a test and notice any unsatisfactory or unusual performance. Watch the instruments constantly. Notice promptly unusual instrument indication that may signify possible trouble in system to which the instrument applies.

b. **Procedures.** During operation services consist of observing items listed below according to the procedures following each item, and investigating any indications of serious trouble. Notice minor deficiencies to be corrected or reported at earliest opportunity, usually next scheduled halt.

(1) **ITEM 27, FOOT AND HAND BRAKES.** Try hand brake lever full range; should have reserve of one-half ratchet travel. Apply foot brakes for smooth and even operation, no side pull. Foot-to-floor-board clearance 1 inch.

(2) **ITEM 28, CLUTCH.** Observe for chatter, squeal, or slip when fully engaged. Free travel, 1¾ to 2 inches.

(3) **ITEM 29, TRANSMISSION.** Test for ease of shifting, quiet operation, and maintenance of mesh.

(4) **ITEM 30, TRANSFER.** Test for ease of shifting, quiet operation, and maintenance of mesh.

(5) **ITEM 31, ENGINE AND CONTROLS.** Be on the alert at all times during operation of the vehicle for any abnormal engine operating characteristics and for lack of proper response to the controls. Note any looseness or binding in the engine control mechanism and linkage.

(6) **ITEM 32, INSTRUMENTS.** To see if they are indicating properly, observe the readings of all instruments frequently as follows:

(a) **Temperature Gage.** Normal range approximately 180 F. Red light on indicates 225 F.

(b) **Oil Pressure Gage.** No pressure, sudden drop to low reading, or needle fluctuation; *stop engine* and report.

(c) **Ammeter.** High (+) charge rate for first few minutes after starting. Zero or slight positive (+) charge at idle speed with accessories and

INSPECTION AND PREVENTIVE MAINTENANCE SERVICE

lights off is normal. Any unusual drop or continued high (+) charging rate indicates defect in electrical system.

(d) *Tachometer.* Observe for noise or grinding and fluctuation of needle.

(e) *Fuel Gage.* Observe for sticking needle and incorrect indications of fuel supply.

(f) *Speedometer and Odometer.* Observe for unusual noise or grinding, or fluctuation of needle. See that odometer is registering.

(7) **ITEM 33, STEERING GEAR.** Observe for looseness, binding, pulling to one side, wandering, shimmy, or unusual noises.

(8) **ITEM 34, RUNNING GEAR.** Listen for any unusual noise in the wheels, axles, springs, shock absorbers, tracks, and bogie suspensions, that might indicate loose or damaged parts or units.

(9) **ITEM 35, BODY.** Note any unusual noise in the body that would indicate loose or damaged panels, doors, hardware, gun mounts, or attachments.

16. AT HALT SERVICE.

a. At halt services may be regarded as minimum maintenance procedures and should be performed under all tactical conditions, even though more extensive maintenance services must be slighted or omitted altogether.

b. **Procedures.** At halt services consist of investigating any deficiencies noted during operation, inspecting items listed below according to the procedures following the items, and correcting any deficiencies found. Deficiencies not corrected should be reported promptly to the designated individual in authority.

(1) **ITEM 38, FUEL, OIL, AND WATER.** Replenish as required.

(2) **ITEM 39, TEMPERATURES; HUBS, BRAKE DRUMS, TRANSFER, TRANSMISSION, AND AXLES.** Feel these assemblies for overheating. Transfer case temperatures will run higher than other gear cases.

(3) **ITEM 40, AXLE AND TRANSFER VENTS.** Wipe off dirt or grease and examine for stoppage. Remove and clear if necessary.

(4) **ITEM 41, PROPELLER SHAFTS.** Examine for looseness, damage, and excessive lubricant leakage.

(5) **ITEM 42, SPRINGS AND SUSPENSIONS.** Examine for looseness, damage, or shifting.

(6) **ITEM 43, STEERING LINKAGE.** Examine for looseness, or damage.

BASIC HALF-TRACK VEHICLES (IHC) (PERSONNEL CARRIER M5, CAR M9A1, MULTIPLE GUN MOTOR CARRIAGE M14, AND SIMILAR IHC VEHICLES)

(7) **ITEM 44, WHEEL AND FLANGE NUTS.** All must be present and secure.

(8) **ITEM 45, TIRES AND TRACKS.** 70 pounds tire pressure. Check filler core caps. Look for damage and embedded objects in treads and between tracks and bogie assemblies. Observe if track tension is satisfactory.

(9) **ITEM 46, LEAKS; GENERAL.** Look under the vehicle and under the hood for indications of fuel, oil, coolant, or brake fluid leaks.

(10) **ITEM 47, ACCESSORIES AND BELTS.** Examine for looseness, damage, and incorrect alinement. Belt tension 1/2-inch deflection.

(11) **ITEM 48, AIR CLEANERS.** Must be secure and air passages clear. In extremely dusty or sandy operation, cleaning and servicing will be required more often than indicated in scheduled services. Follow special instructions as issued for specific conditions encountered.

(12) **ITEM 49, FENDERS AND BUMPERS.** Secure.

(13) **ITEM 50, TOWING CONNECTIONS.** Must be securely connected and locked. Electric wiring connections must be in good condition and secure, and safety switch attached correctly.

(14) **ITEM 51, BODY, LOAD, AND TARPAULINS.** Examine body and load for shifting.

(15) **ITEM 52, APPEARANCE AND GLASS.** Clean windshield, rear vision mirror, and lamp glass. Look for looseness or damage. Adjust mirror.

17. AFTER OPERATION AND WEEKLY SERVICE.

a. After operation servicing is particularly important because at this time the driver inspects his vehicle to detect any deficiencies that may have developed and corrects those he is permitted to handle. He should report promptly, to the designated individual in authority the results of his inspection. If this schedule is performed thoroughly, the vehicle should be ready to roll again on a moment's notice. The before operation service, with a few exceptions, is then necessary only to ascertain whether the vehicle is in the same condition in which it was left upon completion of the after operation service. The after operation service should never be entirely omitted even in extreme tactical situations, but may be reduced to the bare fundamental services outlined for the at halt service if necessary.

b. **Procedures.** When performing the after operation service the driver must remember and consider any irregularities noticed during the

INSPECTION AND PREVENTIVE MAINTENANCE SERVICE

day in the before operation, during operation, and at halt services. The after operation service consists of inspecting and servicing the following items. Those items of the after operation service that are marked by an asterisk (*) require additional weekly services, the procedures for which are indicated in substep (b) of each applicable item.

(1) **ITEM 54, FUEL, OIL, AND WATER.** Fill fuel tanks and spare fuel cans. Read crankcase oil level on dip stick and fill to the correct level with specified oil. Note level of the coolant in filler and observe for contamination. Add water if needed.

(2) **ITEM 55, ENGINE OPERATION.** Observe for smooth idle, no stalling. Accelerate and decelerate the engine and listen for any unusual noise or unsatisfactory operating characteristics in engine or accessories. Note any unusual exhaust smoke. Investigate any deficiencies observed during operation.

(3) **ITEM 56, INSTRUMENTS.** Report any unusual performance observed during operation.

(a) *Temperature Gage.* As soon as the vehicle is stopped, observe if the engine temperature (not over 180 F) is normal. An increase above running temperature will occur when engine is stopped or idling.

(b) *Oil Pressure Gage.* Oil pressure should be 40 pounds to 45 pounds at fast idling speed. Low or no pressure indicates defect. Observe for sticking or fluctuating needle.

(c) *Ammeter.* Should register a zero or slight positive charge at idling speed with lights and accessories off. High charging rate indicates probable defect in electrical system.

(d) *Tachometer.* Observe for sticking or fluctuating needle, unusual or grinding noises.

(e) *Voltmeter.* Should register at least the nominal battery rating.

(f) *Fuel Gage.* With tank full, gage reading should agree. Watch for needle sticking or not registering.

(g) Check the operation of all other instruments not covered above, such as warning lights and compass, to see that they are secure, not damaged, and functioning. Stop the engine at this time.

(4) **ITEM 57, HORN AND WINDSHIELD WIPERS.** Sound horn. Observe tone. Operate wipers momentarily and see that they make proper contact with the glass and operate through their full stroke. See that arms and blades are not bent or damaged. Motor must be secure.

(5) **ITEM 58, GLASS AND REAR VISION MIRRORS.** Wipe clean and check for looseness or damage. Adjust rear view mirror.

BASIC HALF-TRACK VEHICLES (IHC) (PERSONNEL CARRIER M5, CAR M9A1, MULTIPLE GUN MOTOR CARRIAGE M14, AND SIMILAR IHC VEHICLES)

(6) **ITEM 59, LAMPS AND SAFETY REFLECTORS.** Must be clean and secure. Operate all lamp switches. All lamps must light when *on*, not remain lighted when *off*. Stop light must operate when brake is applied.

(7) **ITEM 60, FIRE EXTINGUISHERS.** Valves must be closed, nozzles clear. Check to see that they are fully charged and that the valves are entirely closed.

(8) **ITEM 61, DECONTAMINATOR.** When furnished, check to see that it is securely mounted and fully charged. **NOTE:** It must be reloaded each 90 days, as the contents deteriorate.

(9) **ITEM 62, *BATTERY AND VOLTMETER.**

(a) Examine battery to see that it is secure, clean, and not damaged or leaking; that terminals are tight and not corroded; and that cables are well supported and not chafing. Wipe off the filler plugs and be sure vents are open. Fluid should be three-eighth inch above the cell plates. Depress the voltmeter switch. It should indicate at least nominal battery voltage.

(b) *Weekly.* Clean top of battery. Add water so as to maintain level three-eighth inch above cell plates. If posts and terminals are corroded, clean and apply fresh coat of grease. Tighten terminal and battery carrier bolts. Clean battery carrier if corroded.

(10) **ITEM 63, *ACCESSORIES AND BELTS.**

(a) Examine accessories and fan belts to see that they are in good condition, clean, and secure, fan belt tension one-half inch deflection.

(b) *Weekly.* Tighten all accessory mountings, bolts, and line connections. Inspect for leaks. Examine belts for excessive wear or deterioration.

(11) **ITEM 64, *ELECTRICAL WIRING.**

(a) Examine to see that it is in good condition, well supported, clean, and properly connected.

(b) *Weekly.* Clean all wiring. Examine insulation and shielding for damage or excessive wear. Report unserviceable wiring.

(12) **ITEM 65, *AIR CLEANERS AND BREATHER CAPS.**

(a) Examine to see that oil in cleaner bowl is at correct level and not excessively dirty, and that cleaner element is sufficiently lubricated.

(b) *Weekly.* Remove, disassemble, and clean. Refill reservoir to proper level with oil. Clean oil bath type breather in same manner.

(13) **ITEM 66, *FUEL FILTERS.**

(a) See that they are in good condition, securely mounted and con-

INSPECTION AND PREVENTIVE MAINTENANCE SERVICE

ected, and whether there are indications of fuel leaks at filters or connecting fuel lines.

(b) *Weekly.* Drain water and sediment.

(14) **ITEM 67, ENGINE CONTROLS.** Inspect the engine and accessory controls to see that they are secure, not damaged or excessively worn, that they operate freely, and are adequately lubricated.

(15) **ITEM 68, *TIRES AND TRACKS.**

(a) Remove all foreign matter, such as nails, glass, or stones from tires or from between duals. Inspect for signs of abnormal tread wear, cuts, wrong tread direction, position of valve stems, and presence of valve caps. Replace missing valve caps. Tires may be mounted in the tractional position (the point of the "V" striking the ground first) when additional traction is required. If necessary to change a tire, it should be properly matched. All tires must be gaged and inflated as necessary (70 pounds maximum when cold), at least once each day that the vehicle is operated. Inspect tracks to see that they are in good condition, that the connectors are secure and that the track tension is satisfactory. Remove all embedded objects from between treads, tracks, and bogie assemblies.

(b) *Weekly.* Replace badly worn or otherwise unserviceable tires by authority of the designated individual. Tighten all loose track connections and guide nuts and adjust track to correct tension.

(16) **ITEM 69, *SPRINGS AND SUSPENSIONS.**

(a) Inspect to see that they are secure, not damaged, and in correct position and alignment.

(b) *Weekly.* Tighten and aline as required.

(17) **ITEM 70, *STEERING LINKAGE.** See that it is in good condition, secure, and not excessively worn; whether it is adequately lubricated; and that there are no excessive lubricant leaks.

(18) **ITEM 71, PROPELLER SHAFTS.** Remove any dirt or excess grease from around shafts or U-joints and check for loose connections, lubricant leaks, and damage. Remove any foreign material wrapped around the shafts.

(19) **ITEM 72, *AXLE AND TRANSFER VENTS.**

(a) Wipe off any accumulation of mud or grease and examine to see whether they are obstructed.

(b) *Weekly.* Clean thoroughly of all obstructions.

(20) **ITEM 73, LEAKS, GENERAL.** Look under the vehicle and under the hood for indications of fuel, oil, coolant, or brake fluid leaks.

BASIC HALF-TRACK VEHICLES (IHC) (PERSONNEL CARRIER M5, CAR M9A1, MULTIPLE GUN MOTOR CARRIAGE M14, AND SIMILAR IHC VEHICLES)

(21) **ITEM 74, GEAR OIL LEVELS.** Examine transmission, transfer, driving axles, and winch to see whether lubricant is up to proper level, which is from ½ inch below the filler hole when cold, to the bottom edge of the hole when hot. Add specified oil as required. Note any indication of excessive oil leaks.

(22) **ITEM 76, FENDERS AND BUMPERS.** See that they are secure and not damaged.

(23) **ITEM 77, *TOWING CONNECTIONS.**

(a) Be sure that any towed load is securely connected; that locking devices operate properly; and that electric wiring connections are in good condition and secure, and safety switch properly attached between towing and towed vehicle.

(b) *Weekly.* Tighten and lubricate as necessary.

(24) **ITEM 78, BODY, LOAD, AND TARPAULINS.** Inspect body and load for shifting. Be sure load and tarpaulins are securely fastened.

(25) **ITEM 79, ARMOR AND FRONT ROLLER.** Inspect for damage, broken welds, and loose mounting bolts, screws, or rivets. Examine door and windshield armor shields, compartment doors, and peephole and pistolport covers for damage; hinges, latches, and supports, for damage and proper functioning; radiator shutters, for damage and proper operation of controls. Tighten all loose bolts, nuts, or screws securely. Lubricate hinges and locking devices as necessary. Examine front roller and its mounting brackets and recoil springs for looseness or damage, and to see that roller will revolve.

(26) **ITEM 82, *TIGHTENING.**

(a) Tighten all loose wheel, rim, sprocket, idler, bogie assembly, axle drive flange, spring shackle, and U-bolt nuts securely.

(b) *Weekly.* Tighten spring U-bolts, bumper assembly and mounting bolts, half-track sprocket and idler assembly bolts, and any other items which are known through experience to need tightening weekly. Pay particular attention to body armor and assembly bolts.

(27) **ITEM 83, *LUBRICATION.**

(a) Lubricate all parts where inspection reveals a deficiency in this respect. Wipe all dirt from fittings before applying lubricant and report any missing fittings or plugs.

(b) *Weekly.* Properly lubricate the following items and any additional items which experience indicates should be lubricated each week; hood hinges and fasteners, carburetor control linkage, cab and body

INSPECTION AND PREVENTIVE MAINTENANCE SERVICE

hardware, windshield hinges and fasteners, radiator shutters and linkage, front roller, pintle hook, and all control linkage beneath the vehicle.

(28) **ITEM 84, *CLEAN ENGINE AND VEHICLE.**

(a) Clean dirt and trash from inside of cab and body and remove excessive dirt or grease from the exterior of the vehicle and engine.

(b) *Weekly.* Clean the engine and engine compartment thoroughly. Remove insects and trash from in and around radiator core air passages. Wash the vehicle, when possible. If not possible, wipe off thoroughly; do not rub lusterless paint enough to create a shine that may cause a reflection.

(29) **ITEM 85, *TOOLS AND EQUIPMENT.**

(a) Check to see if all tools and equipment assigned, including pioneer tool equipment, traction devices, tow rope or chain, spare winch shear pins, fuel can nozzle, tire gage bucket, and trouble lamp (if so equipped) are clean, in good condition, and properly stored. Replenish the first-aid kit, if necessary. See whether vehicle maintenance manuals, parts lists, lubrication Chek-Chart, and Standard Form No. 26 (accident report form) are present. See whether any special equipment is in serviceable condition and securely attached. Replace missing or damaged items. When performing the weekly service in conjunction with this after operation service, omit this item and perform it when doing the weekly service.

(b) *Weekly.* Inspect pioneer tools to see that they are in good condition and securely attached; see that other vehicle tools, traction devices, tow rope or chain, spare winch shear pins, fuel can nozzle, bucket, tire gage, and trouble lamp (if so equipped) are present, clean, and in good condition. See that fire extinguisher, decontaminator, and first-aid kit are present; replenish if necessary. See that vehicle maintenance manuals, parts lists and Standard Form No. 26 (accident report form) are present. See that any special equipment, such as gun tripods, is in serviceable condition and securely attached. Replace any missing items.

18. SECOND ECHELON PREVENTIVE MAINTENANCE BASIC INSTRUCTIONS.

a. Regular scheduled maintenance inspections and services are a preventive maintenance function of the using arms, and are the responsibility of commanders of operating organizations.

(1) **FREQUENCY.** The frequencies of the preventive maintenance services outlined herein are considered a minimum requirement for normal operations of vehicles. Under unusual operating conditions such as extreme temperatures, dusty or sandy terrain, it may be necessary to perform certain maintenance services more frequently.

BASIC HALF-TRACK VEHICLES (IHC) (PERSONNEL CARRIER M5, CAR M9A1, MULTIPLE GUN MOTOR CARRIAGE M14, AND SIMILAR IHC VEHICLES)

(2) **FIRST ECHELON PARTICIPATION.** The drivers should accompany their vehicles and assist the mechanics while periodic second echelon preventive maintenance services are performed. Ordinarily, the driver should present the vehicle for a scheduled preventive maintenance service in a reasonably clean condition; that is, it should be dry and not caked with mud or grease to such an extent that inspection and servicing will be seriously hampered. However, the vehicle should not be washed or wiped thoroughly clean, since certain types of defects, such as cracks, leaks, and loose or shifted parts or assemblies are more evident if the surfaces are slightly soiled or dusty.

(3) If instructions other than those contained in the general procedures in paragraph 19 or the specific procedures in paragraph 20 which follow, are required for the correct performance of a preventive maintenance service or for correction of a deficiency, other sections of the vehicle operator's manual pertaining to the item involved, or a designated individual in authority, should be consulted.

19. SECOND ECHELON GENERAL PROCEDURES.

a. These general procedures are basic instructions which are to be followed when performing the services on the items listed in the specific procedures. **NOTE:** The second echelon personnel must be thoroughly trained in these procedures so that they will apply them automatically.

(1) When new or overhauled subassemblies are installed to correct deficiencies, care should be taken to see that they are clean, correctly installed, properly lubricated, and adjusted.

(2) When installing new lubricant retainer seals, a coating of the lubricant should be wiped over the sealing surface of the lip of the seal. When the new seal is a leather seal, it should be soaked in **OIL**, engine, **SAE 10** (warm, if practicable), for at least 30 minutes. Then, the leather lip should be worked carefully by hand before installing the seal. The lip must not be scratched or marred.

(3) **SPECIAL SERVICES.** These are indicated by repeating the item numbers in the columns which show the interval at which the services are to be performed, and show that the parts or assemblies are to receive certain mandatory services. For example, an item number in one or both columns opposite a "tighten" procedure means that the actual tightening of the object must be performed. The special services include:

(a) *Adjust.* Make all necessary adjustments in accordance with the pertinent section of the vehicle operator's manual, special bulletins, or other current directives.

INSPECTION AND PREVENTIVE MAINTENANCE SERVICE

(b) *Clean.* Clean units of the vehicle with solvent to remove excess lubricant, dirt, and other foreign material. After the parts are cleaned, rinse them in clean fluid and dry them thoroughly. Take care to keep the parts clean until reassembled, and be certain to keep cleaning fluid away from rubber or other material which it will damage. Clean the protective grease coating from new parts since this material is not a good lubricant.

(c) *Special Lubrication.* This applies either to lubrication operations that do not appear on the vehicle lubrication chart and to items that do appear on such charts but should be performed in connection with the maintenance operations if parts have to be disassembled for inspection or service.

(d) *Service.* This usually consists of performing special operations, such as replenishing battery water, draining and refilling units with oil, and changing the oil filter cartridge.

(e) *Tighten.* All tightening operations should be performed with sufficient wrench torque (force on the wrench handle) to tighten the unit according to good mechanical practice. Use torque-indicating wrench where specified. Do not overtighten, as this may strip threads or cause distortion. Tightening will always be understood to include the correct installation of lock washers, lock nuts, and cotter pins provided to secure the tightening.

(4) When conditions make it difficult to perform the complete preventive maintenance procedures at one time, they can sometimes be handled in sections, planning to complete all operations within the week if possible. All available time at halts and in bivouac areas must be utilized, if necessary, to assure that maintenance operations are completed. When limited by the tactical situation, items with special services in the columns should be given first consideration.

(5) The numbers of the preventive maintenance procedures that follow are identical with those outlined on WD A.G.O. Form No. 461, which is the Preventive Maintenance Service Work Sheet for Wheeled and Half-track Vehicles. Certain items on the work sheet that do not apply to this vehicle are not included in the procedures in this manual. In general, the numerical sequence of items on the work sheet is followed in the manual procedures, but in some instances there is deviation for conservation of the mechanics' time and effort.

20. PROCEDURE FOR 1,000-MILE (MONTHLY) AND 6,000-MILE (6-MONTH) MAINTENANCE SERVICE.

a. *Specific Procedures.* The procedures for performing each item in the 1,000-mile (monthly) and 6,000-mile (6-month) maintenance

BASIC HALF-TRACK VEHICLES (IHC) (PERSONNEL CARRIER M5, CAR M9A1, MULTIPLE GUN MOTOR CARRIAGE M14, AND SIMILAR IHC VEHICLES)

procedures are described in the following chart. Each page of the chart has two columns at its left edge corresponding to the 6,000-mile and the 1,000-mile maintenance, respectively. Very often it will be found that a particular procedure does not apply to both scheduled maintenances. In order to determine which procedure to follow, look down the column corresponding to the maintenance due, and wherever an item number appears, perform the operations indicated opposite the number.

ROAD TEST

6,000-Mile Maintenance	1,000-Mile Maintenance	
		<p>NOTE: When the tactical situation does not permit a full road test, perform those items which require little or no movement of the vehicle. When a road test is possible, it should be for preferably 5 and not over 10 miles.</p>
1	1	<p>BEFORE OPERATION SERVICE. Perform the before operation service as described in paragraph 14, as a check to determine whether the vehicle is in a satisfactory condition to make the road test safely.</p>
3	3	<p>INSTRUMENTS AND GAGES.</p> <p><i>Oil Pressure.</i> Oil pressure range is 40 to 45 pounds with engine at fast idle. Warning light may flicker at idle but must extinguish at increased engine speed. CAUTION: When gage or warning light indicates zero or excessively low pressure, stop engine immediately and investigate.</p> <p><i>Ammeter.</i> Reading should show high charge for a short time after starting and then return to slightly above zero with all lights and electrical accessories switched off. When battery is low, a higher charge may be indicated and for a longer period of time.</p> <p><i>Speedometer, Odometer, and Tachometer.</i> Speedometer and tachometer must operate without excessive fluctuation, or unusual noises. Odometer must register the accumulating mileage.</p> <p><i>Temperature.</i> Should not exceed 180 F. Warning light indicates dangerous temperature of 225 F or over.</p> <p><i>Fuel.</i> With the fuel tank selector switch in both positions, see that fuel gage registers approximate amount of fuel in each tank.</p>
4	4	<p>HORN, MIRRORS, AND WINDSHIELD WIPERS. When tactical situation permits, operate horn. Aim, clean, and secure rear vision mirrors. Operate windshield wipers. Tighten, adjust arms, and replace blades if faulty.</p>

INSPECTION AND PREVENTIVE MAINTENANCE SERVICE

6,000- Mile Main- tenance	1,000- Mile Main- tenance	
5	5	<p>BRAKES (FOOT, HAND, AND TRAILER). Make first brake check from low speed when starting road test. Continue tests as other stops are made.</p> <p><i>Foot Brakes.</i> Foot brakes must stop the vehicle safely at a fast rate, within a reasonable distance; must operate with good effectiveness. Brake pedal must have moderate but not "hard" or "spongy" feel. Front brakes must not pull the vehicle to one side. Listen for any objectionable noise or chatter. Reserve pedal travel at the end of the stop should be 1 inch minimum.</p> <p><i>Hand Brake.</i> When set, must hold vehicle effectively on grade. Half the ratchet travel should be reserve.</p> <p><i>Trailer Brake.</i> Examine controller for good condition, security of mounting, and tight connections. Test for quick application and release with trailer connected. Apply trailer brakes only and observe for normal effectiveness, objectionable noise, sidesway, or unequal brake action. Stop vehicle and check to see that safety switch will operate properly to apply the trailer brakes.</p>
6	6	<p>CLUTCH. Test for grabbing, dragging, chatter or noise that might indicate faulty adjustment, defective clutch parts, or dry release bearing. Pedal should have free travel of $1\frac{3}{4}$ to 2 inches before meeting resistance. While running at low speed in high gear, depress accelerator fully, at same time applying brakes slightly, and observe if clutch appears to slip.</p>
7	7	<p>TRANSMISSION AND TRANSFER. With vehicle in motion, shift through the entire gear range of transmission and transfer and see that shifter mechanism operates freely without clashing or jumping out of gear; that declutching mechanism operates freely; whether there are any unusual vibrations that might indicate loose mountings; and whether there is any unusual noise.</p>
8	8	<p>STEERING. With the vehicle in motion, move steering wheel fully in both directions and observe whether there is any indication of looseness or binding. Test for any tendency to wander, shimmy, or pull to one side while vehicle is operated at normal speeds. Steering column and steering wheel must be in good condition and secure.</p>

BASIC HALF-TRACK VEHICLES (IHC) (PERSONNEL CARRIER M5, CAR M9A1, MULTIPLE GUN MOTOR CARRIAGE M14, AND SIMILAR IHC VEHICLES)

6,000- Mile Main- tenance	1,000- Mile Main- tenance
------------------------------------	------------------------------------

9

9

ENGINE.

Idle. During the road test, note any tendency of the engine to stall while decelerating to shift gears. With the vehicle stopped, observe whether engine will run smoothly at normal idle speed.

Acceleration, Power, and Noise. Observe if engine has normal acceleration, pulling power, and operating characteristics in each speed when shifting through the gear range from first to high. Make a similar observation in high gear from low speed with wide open throttle. During this operation, note any unusual engine noise such as excessive "ping" which may indicate early timing or too low octane fuel. Listen for other noises that might indicate damaged, excessively worn, or inadequately lubricated engine parts or accessories, or loose drive belts.

Governed Speed. With vehicle in second gear, slowly depress the accelerator to toe-board and by observing speedometer reading, see if vehicle reaches, but does not exceed, the governed speed specified on the caution plate. Check tachometer reading to see that engine speed does not exceed the specified revolutions per minute.

10

10

UNUSUAL NOISES. Be alert for any unusual noise that may indicate looseness, damage, excessive wear in body, wheels, tracks, suspension assemblies, attachments, and equipment.

11

11

BRAKE BOOSTER OPERATION—HYDROVAC. Test brakes to learn whether vacuum power unit assists in application. A quick test is to stop vehicle, with engine running, and listen for air movement in the Hydrovac unit air cleaner, while the brake pedal is being operated.

13

13

TEMPERATURES. After completing road test run:

Brake Drums and Hubs. Feel all brake drums and wheel hubs cautiously for abnormal temperatures. An overheated brake drum or wheel hub is an indication of a dragging brake, or a defective, dry, or improperly adjusted wheel bearing; an abnormally cool brake drum is an indication of an inoperative brake.

Axles, Transmission, and Transfer. Cautiously feel axle differentials and carriers, transmission, and transfer case for

INSPECTION AND PREVENTIVE MAINTENANCE SERVICE

6,000- Mile Main- tenance	1,000- Mile Main- tenance	
		overheating. If any gear case is excessively hot, for the distance traveled, an abnormal condition in the unit is indicated.
14	14	LEAKS. Look within engine compartment and under vehicle for indications of fuel, oil, water, and brake fluid leaks. Trace them to their source, and correct or report them.
16	16	GEAR OIL LEVEL AND LEAKS. Examine driving axles, transmission, and transfer for lubricant level and leaks. NOTE: The safe range level is from the lower edge of the filler hole when hot, to one-half inch below when cold. When organization lubrication records indicate a change of oil in these units is due, drain and refill transmission, transfer case, and front and rear axle housings, and refill with specified lubricant.
<p>MAINTENANCE OPERATIONS RAISE VEHICLE — BLOCK SAFELY</p>		
17	17	<p>UNUSUAL NOISES. With the engine running:</p> <p><i>Engine, Belts, and Accessories.</i> Accelerate and decelerate engine momentarily and listen for unusual noise that might indicate damaged, loose, or excessively worn engine parts, drive belts or accessories. Locate and correct or report any unusual engine noise heard during road test.</p> <p><i>Transmission, Transfer, Propeller Shafts and U-joints, Axles and Wheel Bearings.</i> With transmission in intermediate gear, and front driving axles engaged, operate these units at constant, moderate speed by use of the hand throttle, and test for any unusual noise that might indicate damaged, loose, or excessively worn unit parts. Also observe all propeller shafts for vibrations or run-out, and vibrations in the other units which may indicate looseness or unbalance. Locate, correct, or report any noise noted during road test.</p>
<p>ENGINE AND ACCESSORIES</p>		
18	18	CYLINDER HEAD AND GASKET. Check for cracks or indications of oil, water, or compression leaks around studs, cap screws, and gasket. CAUTION: Cylinder heads should not ordinarily be tightened unless there is definite indication of looseness or leaks.
	19	VALVE MECHANISM. Adjust valve stem clearance if valves are noisy. Intake and exhaust, 0.018 inch. Leaking cover gasket must be replaced.

BASIC HALF-TRACK VEHICLES (IHC) (PERSONNEL CARRIER M5, CAR M9A1, MULTIPLE GUN MOTOR CARRIAGE M14, AND SIMILAR IHC VEHICLES)

6,000- Mile Main- tenance	1,000- Mile Main- tenance	
19		<i>Inspect.</i> See that valves, rocker arms, shafts, springs, and locks are in good condition, correctly assembled, secure, and that oil is being delivered to mechanism. Adjust valve-stem-to-rocker-arm clearances to 0.018 inch, making sure lock nuts are secure when clearances are last checked during adjustment.
20	20	SPARK PLUGS. Clean and examine insulators to see if they are cracked. Reset electrodes to 0.028 inch. Test compression before reinstalling plugs.
21		COMPRESSION TEST. Test compression. Compression at normal cranking speed should not vary more than 10 to 15 pounds between cylinders.
22	22	BATTERY (CABLES, HOLD-DOWNS, CARRIER, SPECIFIC GRAVITY). Examine for leaks. Clean and dry exterior, cables, and terminals. Grease terminals. Tighten hold-down bolts. Test specific gravity (normal 1.275); report reading of 1.225 or less. Bring electrolyte level to one-half inch above plates.
22		<i>Service.</i> Make a high rate discharge test of the battery. Report if difference in reading between cells is more than 30 percent.
23	23	CRANKCASE. Inspect the crankcase, valve covers, timing gear cover, and clutch housing for oil leaks, and check oil level. NOTE: When organization lubrication records indicate an oil change is due, drain crankcase and refill to proper level with specified oil. Do not start engine again until item 24 is completed.
24	24	OIL FILTERS, COOLERS, AND LINES. Inspect for leakage, loose connections, or loose mountings.
24		<i>Service.</i> Remove the filter. Clean oil filter case, install new filter cartridge.
25	25	RADIATOR (CORE, SHUTTERS, MOUNTINGS, HOSE, CAP AND GASKET, AND SURGE TANK). Observe for looseness, damage, or leakage. Check coolant for contamination. Clean dirt, insects, and trash from exterior of core.
25		<i>Antifreeze.</i> If antifreeze is used, check protective value for temperature encountered.
25		<i>Tighten</i> all radiator mountings and hose.

INSPECTION AND PREVENTIVE MAINTENANCE SERVICE

6,000- Mile Main- tenance	1,000- Mile Main- tenance	
26	26	WATER PUMP, FAN, AND SHROUD. Observe water pump for leaks. Test shaft for end play and loose bearings. Inspect fan blades and shroud for damage.
27	27	GENERATOR, STARTER, AND SWITCH. Examine mountings, wiring connections, starter linkage and retracting spring for good condition and security.
27		<i>Service.</i> Remove inspection covers and inspect to see that commutators and brushes are in good condition and not excessively worn; that brushes are free in holders, and brush-connecting wires are secure and not chafing. Dirty commutator must be cleaned with sandpaper (No. 00) according to instructions in this manual (par. 87 b and 88 b). Blow out the dust with compressed air. Tighten starting motor mounting nuts securely.
29	29	DRIVE BELTS AND PULLEYS. Check fan drive belts for good condition, and drive pulleys and hubs for good condition and security. Adjust fan drive belts to one-half inch deflection.
30	30	TACHOMETER DRIVE AND ADAPTER. See that they are in good condition, correctly assembled, and secure, and that flexible shaft does not leak.
31	31	DISTRIBUTOR. Wipe off distributor and external attachments and examine for good condition and security. <i>Cap, Rotor, and Points.</i> Remove cap and examine cap, rotor, and breaker plate assembly parts for good condition, correct assembly, security, and serviceability. Inspect for cracks in cap and rotor arm, corrosion of terminals and connections, and burning of the outer ends of conductor strap. Breaker points must be in good condition, alined, and adjusted to 0.018 to 0.024 inch gap. Replace if burned, pitted, or excessively worn.
31		<i>Service.</i> If breaker plate assembly is excessively worn or dirty, remove distributor, clean in solvent, dry with compressed air, lubricate as specified below, and reinstall in position for timing. When cleaning, remove the wick and lubrication cup. Clean while removed and reinstall only after distributor assembly is cleaned and dried. Lubricate cam surface, movable breaker arm pin, wick, and camshaft with light oil. Adjust breaker point gap to 0.018 to 0.024 inch.
31	31	<i>Shaft.</i> Inspect for looseness. Test centrifugal advance to

BASIC HALF-TRACK VEHICLES (IHC) (PERSONNEL CARRIER M5, CAR M9A1, MULTIPLE GUN MOTOR CARRIAGE M14, AND SIMILAR IHC VEHICLES)

6,000- Mile Main- tenance	1,000- Mile Main- tenance	
		see whether the camshaft can be rotated by finger force through normal range of movement permitted by centrifugal advance mechanism and returns when released, without binding or sticking.
32	32	COIL AND WIRING. Inspect coil for good condition, cleanliness, and security, and see that all high voltage ignition wiring, including shielding or conduits are in good condition and securely fastened at all support mountings and terminals. See that insulation and connections are clean. Inspect all low voltage wiring in the engine compartment in the same manner.
33	33	MANIFOLDS. Inspect intake and exhaust manifold for good condition and security, and manifold gaskets for leaks.
34	34	AIR CLEANER. Inspect carburetor air cleaner for good condition, security, and oil leaks. Observe condition of the cleaning element, baffles, and seals. Clean element and fill reservoir to correct level with specified oil.
35	35	BREATHER CAPS AND VENTILATORS. Inspect to see that they are in good condition, correctly assembled, secure, and that ventilator tubes are open. Remove the elements, and clean both element and body in solvent. Dip element in engine oil. Clean and service oil bath cylinder head breather in the same manner as for item 34.
36	36	CARBURETOR (CHOKE, THROTTLE, LINKAGE, AND GOVERNOR). Inspect to see that they are in good condition, correctly assembled, and secure; that carburetor does not leak, and that governor is secure and properly sealed.
37	37	FUEL FILTER AND LINES. Inspect fuel filter, sediment bowl, fuel lines and connections, to see that they are in good condition, secure, and not leaking. Remove filter bowl and element, and clean in solvent. Include screen or filter element at carburetor fuel line connection or fuel pump. Reinstall, using new gaskets. After assembling, recheck for leaks.
38	38	FUEL PUMP. Inspect fuel and vacuum pump for good condition, security, and leaks. Attach test gage, and with the engine idling, note whether the pump pressure and vacuum are satisfactory.
39	39	STARTER. Start engine, observing whether general action of starting motor is satisfactory, particularly whether it engages

INSPECTION AND PREVENTIVE MAINTENANCE SERVICE

6,000- Mile Main- tenance	1,000- Mile Main- tenance	
		and disengages properly without excessive noise and has adequate cranking speed, and whether engine starts readily.
40	40	LEAKS. Check in engine compartment and under the vehicle for engine oil, fuel, brake fluid, and water leaks.
41	41	IGNITION TIMING. With the engine running, and the neon timing light connected, set ignition timing correctly. Observe whether automatic controls advance timing as engine is accelerated gradually.
42	42	ENGINE IDLE AND VACUUM TEST. Connect a vacuum gage to intake manifold, adjust engine to its normal idle speed by means of throttle stop screw, then adjust the idle mixture adjusting needle until vacuum gage indicates maximum reading. If this latter adjustment changes idle speed appreciably, reset idle speed and mixture until both are satisfactory.
43	43	REGULATOR UNIT. Observe if it is in good condition and if connections and mountings are secure. Connect low voltage circuit tester and test voltage regulator, current regulator and cut-out for proper generator output control. Follow the instructions which accompany the test instrument.
		CHASSIS, BODY, AND ATTACHMENTS
47	47	TIRES AND RIMS. Inspect as follows: <i>Valve Stems and Caps.</i> Inspect valve stems for good condition and correct position, and that all valve caps are present and secure. <i>Condition and Tread Wear.</i> Inspect tires for cuts, bruises, breaks, blisters, and irregular tread wear, watching for any sign of flat spots, cupping, feather edges, and one-sided wear. Any mechanical deficiencies causing such conditions should be determined and corrected or reported. Remove embedded glass, nails, and stones. The wheel positions of tires with irregular wear should be changed, front tires to rear-wheel positions and vice-versa. <i>Direction.</i> Directional and nondirectional tires should not be installed on same vehicle. Directional tires on front wheels should be mounted so that "V" of chevron points down. <i>Matching.</i> With the tires properly inflated, inspect for matching according to over-all circumference, 1½ inch variation permissible.

BASIC HALF-TRACK VEHICLES (IHC) (PERSONNEL CARRIER M5, CAR M9A1, MULTIPLE GUN MOTOR CARRIAGE M14, AND SIMILAR IHC VEHICLES)

6,000- Mile Main- tenance	1,000- Mile Main- tenance	
		<p><i>Spare Tire Carriers.</i> Inspect spare tire carriers for good condition and security.</p> <p><i>Rims:</i> Check to see that all rims and their lock rings or flanges are in good condition and secure. Tighten securely.</p>
106	106	<p>TRACKS (GUIDES AND TREAD WEAR). Inspect tracks to see that they are in good condition and in proper position on sprockets and rollers, that guides are all present, not excessively worn, and that guide nuts are secure. Remove stones or other obstructions from between the tracks and rollers or lodged in the suspension system.</p>
106		<p><i>Tighten.</i> Track guide nuts with a torque-indicating wrench to 100 foot-pounds.</p>
107	107	<p>SPROCKETS (FLANGES, BEARINGS, AND SEALS). Inspect sprockets and flanges for good condition, security, and for oil leaks from seals.</p>
107		<p><i>Service.</i> Disassemble and clean the sprocket hubs, bearings, and oil seals. Inspect rollers, balls, races, and cages to see that they are in good condition. Lubricate them correctly, using new oil seals, and adjust until a drag is felt; then back off one-eighth turn. When reassembling the sprocket, tighten all hub flanges, sprocket flange, and jackshaft flange nuts securely.</p>
108		<p>BRAKES, REAR. Inspect and service as follows:</p> <p><i>Drums and Supports.</i> Remove dirt and grease and inspect to see if they are in good condition, securely mounted, and not excessively worn or scored.</p> <p><i>Wheel Cylinders.</i> Observe if they are in good condition, securely mounted, and not leaking. Tighten the brake support and drum mounting bolts securely.</p>
109	109	<p>BRAKE SHOES, REAR (LININGS, LINKS, GUIDES, AND ANCHORS). Inspect and service as follows:</p>
	109	<p><i>Inspect.</i> Inspect the linings through inspection holes or openings in brake drums or supports to see whether they are so excessively worn that rivet heads may score drums within next 1,000 miles of operation. If linings are not visible, remove right rear hub and drum for inspection of brake linings by motor sergeant to determine whether they should be replaced. If linings on this wheel brake must be replaced, remove all</p>

INSPECTION AND PREVENTIVE MAINTENANCE SERVICE

6,000- Mile Main- tenance	1,000- Mile Main- tenance	
		wheels and service their brakes similarly, being sure to clean, lubricate, and adjust all removed bearings and to adjust brakes. A similar inspection of brake linings should be made if vehicle has recently been operated in deep water, mud, or loose sand or dirt which may have entered brake drum.
109		<i>Inspect.</i> Inspect to see that linings are in good condition, secure, in good wearing contact with drums, free of lubricant or brake fluid, and not excessively worn. Also see that brake shoes are in good condition; properly secured and guided by anchor bolts, connecting links, guides and springs; and properly returned against their cams or stops by the retracting springs. Clean dust from the linings with a wire brush, clean cloth, or compressed air. After completion, adjust brake shoes by minor adjustment methods, so that linings have proper clearances from brake drums. Where new linings have been installed, adjust shoes by the major adjustment method.
110	110	IDLERS (FLANGES AND BEARINGS). Examine idler wheels and flanges for good condition, security, and indications of oil leaks from seals.
110		<i>Clean.</i> Disassemble and clean the the idler hubs, bearings, and oil seals. Examine rollers, balls, races, cages, and seals for good condition. Repack idler bearings as they are reassembled. Adjust bearings properly, and apply additional lubricant through grease fitting until full. Tighten flanges securely.
111	111	IDLER (POSTS, SHACKLES, SHAFTS, ADJUSTING RODS, AND BRACKETS). Examine for good condition, correct assembly, and security.
111		<i>Tighten.</i> Tighten all hub and flange nuts securely when re-assembling idler.
112	112	FRAME BRACKETS AND CROSS TUBE. Examine for condition and security.
112		<i>Tighten.</i> Tighten all mounting bolt nuts securely.
113	113	BOGIE (CRAB ASSEMBLIES, SPRINGS AND BLOCKS, GUIDES AND SLIDES, ARMS, AND BOLTS). Examine for good condition, security, and excessive wear. Examine springs for good condition and proper seating in spring blocks, and see that they have not taken a permanent set. If two or more coils are rested on seat, it indicates that springs have taken permanent set and should be replaced.

BASIC HALF-TRACK VEHICLES (IHC) (PERSONNEL CARRIER M5, CAR M9A1, MULTIPLE GUN MOTOR CARRIAGE M14, AND SIMILAR IHC VEHICLES)

6,000- Mile Main- tenance	1,000- Mile Main- tenance	
114	114	<p>BOGIE ROLLERS (UPPER AND LOWER, TIRES, BEARINGS, SEALS, AND BOLTS). Examine upper rollers and brackets, and lower rollers and tires for good condition, correct alinement with track, and security; see that tires are secure on lower rollers and not excessively worn. Pay particular attention to cuts or gouged spots in the tires, and also that lubricant is not leaking excessively from the seals.</p>
114		<p><i>Service.</i> Remove and clean bogie lower rollers, bearings, and seals. Examine bolts, links, balls, races, and cages for good condition. Repack bearings with lubricant. Apply additional grease through grease fitting until entire hub is filled.</p>
115	115	<p>TRACK TENSION (ON GROUND). Adjust track tension by bringing tension springs to compressed length of 13½ inches.</p>
53		<p>FRONT BRAKES (DRUMS, SUPPORTS, AND CYLINDERS). Inspect and service as follows:</p> <p><i>Drums and Supports.</i> Remove dirt and grease and examine drums and supports for good condition, secure mounting, excessive wear, or scoring.</p> <p><i>Wheel Cylinders.</i> Examine for good condition and secure mounting and fluid leaks. Tighten brake support and drum mounting bolts securely. Examine backing plate for alinement and distortion.</p>
54	54	<p>FRONT BRAKE SHOES (LININGS, LINKS, GUIDES, AND ANCHORS). Inspect and service as follows:</p>
54	54	<p><i>Service.</i> Examine linings through inspection holes or openings in brake drums or supports to see whether they are so excessively worn that rivet heads may score drums within next 1,000 miles of operation. If linings are not visible in this manner, remove the right rear hub and drum for inspection of brake linings by motor officer or motor sergeant to determine whether linings are so worn that they should be replaced. If linings on this wheel brake must be replaced, remove both front wheels and service their brakes similarly, being sure to clean, lubricate, and adjust all removed bearings, and to adjust brakes. A similar inspection of the brake linings should be made if vehicle has recently been operated in deep water, mud, or loose sand or dirt which may have entered brake drum.</p>

INSPECTION AND PREVENTIVE MAINTENANCE SERVICE

6,000- Mile Main- tenance	1,000- Mile Main- tenance	
54		<i>Check.</i> Check to see that linings are in good condition, tightly secured to brake shoes, in good wearing contact with the drums, free of lubricant or brake fluid, and not excessively worn. Also check to see that brake shoes are in good condition; properly secured and guided by anchor bolts, connecting links, guides and springs; and properly returned against cams or stops by retracting springs. Clean all dust from linings with a wire brush, clean cloth, or compressed air.
54	54	<i>Adjust.</i> After services and inspections of all following items to and including item 60, have been completed, adjust brake shoes by minor adjustment method, so that linings have proper clearances from brake drums. Where new linings have been installed, adjust shoes by major adjustment method.
55	55	STEERING KNUCKLES (JOINTS, BEARINGS, SEALS, AND BOOTS.) Inspect and service as follows: Examine knuckle housings and steering arms for good condition; observe whether outside seals and dust boots are in good condition and secure. Obtain a sample of the lubricant from each knuckle; inspect it for contamination.
55		<i>Clean.</i> Disassemble and clean the steering knuckle and drive U-joint assembly parts. Observe whether disassembled knuckle and joint parts are in good condition, particularly U-joint washers, balls and races, axle splines, seals and boots, and pivot bearings or bushings. As the knuckle pivot bearings and drive joints are reassembled, lubricate and adjust the pivot bearing according to the instructions in paragraph 48, 30 to 35 pounds pull. When reassembling the units, be sure to install any required new lubricant retainer seals, boots, and gaskets.
56	56	FRONT SPRINGS (CLIPS, LEAVES, U-BOLTS, HANGERS, AND SHACKLES). Examine to see that they are in good condition, correctly assembled, and secure, and whether springs have excessive sag. Tighten U-bolts securely.
57	57	STEERING (ARMS, TIE ROD, DRAG LINK, SEALS AND BOOTS, PITMAN ARMS, GEAR, COLUMN, AND WHEEL). Examine to see that these items are in good condition, correctly and securely assembled and mounted, and whether steering gear case lubricant is at the proper level and not leaking. Note if steering gear is in satisfactory adjustment.
57		<i>Tighten.</i> Tighten pitman arm shaft nut and steering gear

BASIC HALF-TRACK VEHICLES (IHC) (PERSONNEL CARRIER M5, CAR M9A1, MULTIPLE GUN MOTOR CARRIAGE M14, AND SIMILAR IHC VEHICLES)

6,000-Mile Maintenance	1,000-Mile Maintenance	
		case assembly and mounting nuts or screws securely. CAUTION: Loosen the steering column bracket when tightening the steering case mounting nuts, so as not to distort the column.
58	58	FRONT SHOCK ABSORBERS AND LINKS. Examine shock absorber bodies and links for good condition, security, and fluid leaks.
58		<i>Service.</i> Fill shock absorber bodies with specified fluid. Work the arm several times and add fluid. Repeat this operation until all air is expelled and the reservoir is full. Disconnect the link and check to see that the action is normal. A double-acting shock absorber should have resistance in both directions.
60	60	FRONT WHEELS (BEARINGS, SEALS, FLANGE, AXLE END PLAY, AND NUTS). Inspect and service these items as follows: <i>Wheels.</i> Inspect to see that wheels are in good condition; revolve them, and observe if they have excessive run-out. <i>Bearings and Seals.</i> Without removing front wheels, examine for evidence of looseness in wheel bearing or adjustment. Revolve front wheels and listen for indications of dry or damaged wheel bearings. Inspect drive flanges and around brake supports and drums for lubricant or brake fluid leaks. <i>Drive Flanges and Nuts.</i> Check to see that they are in good condition and secure.
	60	<i>Service.</i> On the 1,000-mile service, if vehicle has recently been operated in deep water which may have entered wheel bearings, remove one wheel to see whether bearing's lubricant appears to be contaminated. Clean and lubricate bearings of the one removed wheel before it is reinstalled. When such inspections of wheel bearing lubricant are made, also inspect the brake linings to see whether they are excessively worn.
60		<i>Clean.</i> Disassemble the bearings and oil seals. Clean thoroughly and inspect the rollers, balls, races, and cages to see that they are in good condition, and that the cups are secure. Also examine to see if the machined surfaces upon which the bearings are assembled are in good condition. When bearings are reinstalled, lubricate the wheel bearings and adjust until drag is felt, then back off one-eighth turn.
61	61	FRONT AXLE (PINION END PLAY, SEAL, VENT, AND ALIGNMENT). If front axle appears to be out of line, measure the

INSPECTION AND PREVENTIVE MAINTENANCE SERVICE

6,000. Mile Main- tenance	1,000. Mile Main- tenance	
		distance from front spring eyebolt to center of axle spring pad on each side. This distance should be about the same on each side. Inspect to see that the axle housing is in good condition and not leaking. Examine pinion shaft for excessive end play and seal for leaks. When the axle housing vent is threaded, remove the vent and clean thoroughly.
62	62	FRONT PROPELLER SHAFT (JOINTS AND ALINEMENT, SEALS AND FLANGES). Inspect for good condition, correct and secure assembly and mountings; inspect U-joints for proper alinement and excessive wear; slip joint should be free, not excessively worn, and well lubricated; and seals of U-joints and slip joint should not leak excessively.
62		<i>Tighten.</i> Tighten all U-joint assembly and companion flange bolts securely. <i>Engine Mountings, Ground Strap, and Side Pans.</i> Inspect to see that they are in good condition and securely mounted and connected. If the mounting bolts are loose, tighten them properly. Remove all oil or grease from rubber mountings.
64	64	HAND BRAKE (RATCHET AND PAWL, LINKAGE, DRUM OR DISK, AND LINING). Examine to see that hand brake ratchet and pawl linkage are in good condition and secure; that brake disk is not scored or oily; and that brake lining is not oil-soaked, nor worn thin. <i>Adjust.</i> Adjust the clearance between the brake disk and lining to 0.010 inch.
65	65	CLUTCH PEDAL (FREE TRAVEL, LINKAGE, AND RETURN SPRING). Examine to see that the pedal free travel is satisfactory (1¾ to 2 inches), that the pedal is securely mounted, and that clutch operating linkage is in good condition, secure, and not excessively worn.
65		<i>Adjust.</i> Adjust clutch pedal free travel according to following specifications: 1¾ inch to 2 inches.
67		BRAKE MASTER CYLINDER (VENT, FLUID LEVEL, LEAKS, AND SWITCH). Examine to see that they are in good condition and secure and that the boot is properly installed; see whether there are any indications of fluid leaks. <i>Service.</i> Fill the master cylinder reservoir to the correct level. Allow approximately one-quarter inch for expansion. Clean vent.

BASIC HALF-TRACK VEHICLES (IHC) (PERSONNEL CARRIER M5, CAR M9A1, MULTIPLE GUN MOTOR CARRIAGE M14, AND SIMILAR IHC VEHICLES)

6,000- Mile Main- tenance	1,000- Mile Main- tenance	
68	68	BRAKE BOOSTER—HYDROVAC (LINKAGE, AIR CLEANER HOSE, AND SLAVE CYLINDER). Inspect to see that they are in good condition, securely assembled and mounted, and that the operating and control linkage does not bind; see whether brake fluid is leaking from the slave cylinder. Clean and oil the air cleaner element.
68		<i>Special Lubrication.</i> Insert a few drops of light oil into power cylinder.
71	71	TRANSMISSION (MOUNTING, SEALS, POWER TAKE-OFF, AND LINKAGE). Inspect transmission case for good condition, oil leaks from seals and gaskets, and see that control linkage is in good condition, properly connected, and secure.
71		<i>Tighten.</i> Tighten all transmission and power take-off mounting and external assembly bolts and cap screws securely.
72	72	TRANSFER (MOUNTINGS, LINKAGE, SEALS, AND VENT). Inspect transfer case for good condition and security of mountings, and inspect seals for leaks. Be sure transfer case vent is clean, and tighten mountings and external assembly nuts or screws securely.
73	73	REAR PROPELLER SHAFTS. Inspect in the same manner as item 62.
73		<i>Tighten.</i> Tighten the U-joint and companion flange bolts securely.
75	75	REAR AXLES (PINION END PLAY, SEALS, VENTS, AND ALIGNMENT). Inspect items and clean vent items in the same manner as for item 61.
79	79	BODY MOUNTINGS. Check to see that all mounting brackets and bolts are present and tighten securely. CAUTION: If body has loosened, be sure to loosen the steering column bracket before tightening.
80	80	FRAME (RAILS AND CROSS MEMBERS). Inspect to see that they are in good condition, secure, and correctly aligned.
81	81	WIRING, CONDUITS, AND GROMMETS. Examine these items underneath the vehicle to see that they are in good condition, properly supported, connected, and secure.
82	82	FUEL TANKS, FITTINGS, AND LINES. Examine fuel tanks for

INSPECTION AND PREVENTIVE MAINTENANCE SERVICE

6,000- Mile Main- tenance	1,000- Mile Main- tenance	
		good condition and security. Inspect caps for defective gaskets or plugged vents. See that filler necks and caps fit securely. Inspect fuel lines and fittings for good condition, security and leaks.
83	83	BRAKE LINES (FITTINGS AND HOSE). Look underneath vehicle and on rear axle housing to see that they are in good condition, secure, and whether they leak.
84	84	EXHAUST PIPES AND MUFFLER. Examine exhaust pipe to see that it is securely attached to the exhaust manifold and muffler, whether gasket or packing leaks, and that muffler is in good condition and securely mounted. Examine tail pipe to see that it is securely clamped to the muffler, properly supported and unobstructed at its outer end.
85	85	VEHICLE LUBRICATION. Check the lubrication of the entire vehicle. On any unit where disassembly was necessary for inspection purposes, lubrication must be performed unless the vehicle is to be deadlined for repair of that unit. Lubricate all points of vehicle and gun mounts in accordance with instructions in vehicle maintenance manual, lubrication guide, and current lubrication bulletins or directives, and the following instructions: Use only clean lubricant and keep all lubricant containers covered. On all unsealed bushings or joints the lubricant should be applied until it appears at the openings. On units provided with lubricant retainer seals, do not force the lubricant beyond the seals.
		<i>Service.</i> Drain oil from engine, transmission, transfer case, or axle housings while warm. Refill units to the correct level as soon as the draining is completed, so there will be little hazard that they may be operated without lubricant. The correct <i>cold</i> oil level in the axles, transfer case, and transmission is $\frac{1}{2}$ inch below the lower side of the filler-plug hole. Do not apply more than specified amount of lubricant to generators, starters, distributors, or water pump. To do so may cause a failure. Wipe off excess lubricant that may drip onto brakes or rubber parts, soil clothes, or detract from the vehicle's appearance. Parts or assemblies that have already been lubricated while disassembled for inspection, gear cases that have been drained and refilled as mandatory items in the procedures, and those parts that have been indicated in the

BASIC HALF-TRACK VEHICLES (IHC) (PERSONNEL CARRIER M5, CAR M9A1, MULTIPLE GUN MOTOR CARRIAGE M14, AND SIMILAR IHC VEHICLES)

6,000- Mile Main- tenance	1,000- Mile Main- tenance
------------------------------------	------------------------------------

procedures for special lubrication may be omitted from the general lubrication of the vehicle.

LOWER VEHICLE TO GROUND

86 86 **TOE-IN AND TURNING STOPS.** With the front wheels on the ground in straight-ahead position, and using a proper toe-in gage, see if the front-wheel toe-in is within specified limits, $\frac{1}{16}$ to $\frac{1}{8}$ inch; and that the wheel turning stops are present and secure, tight, and weld not broken. Turn the front wheels in both directions to see that they engage the stops and if the tires clear all parts of the vehicle in this position. If there is any indication that turning angle exceeds the specified limits, such as scuffing of tires against vehicle, or abnormal front-drive U-joint wear, report for check of turning angle by higher echelon.

87 87 **WINCH (CLUTCH, BRAKE, DRIVE, SHEAR PIN, CABLE, AND GUIDES).** Inspect for good condition, correct assembly, and security. See that clutch moves freely and latches securely, that the drag-brake lining is in good condition, secure, and correctly adjusted. Inspect automatic brake to see that lining is secure, not excessively worn. Check the propeller shaft in the same manner as in item 62; see that the proper shear pin is installed and in good condition. Check cable guides for good condition and security. Also see that the oil level in the worm gear case is correct. If level is high, remove the drain plug and drain off the water or excess lubricant to proper level. Lubricate the winch clutch, shaft, and operating arm with engine oil. Move the clutch back and forth several times during application of lubricant to be sure it is free. Unwind cable and inspect it for broken or frayed strands and for flat or rusty spots.

87 *Clean and Service.* Clean entire length of the cable with a cloth saturated with a mixture of one part engine oil and four parts kerosene. Dry off excess, and as cable is properly re-wound on drum, coat it with a thin film of grease or gear oil. Used engine oil is suggested. Drain the worm-gear case and refill to correct level.

89 89 **MOTOR VEHICLE TO TRAILER BRAKE WIRING AND CONNECTIONS.** Examine brake wiring to see that it is in good condi-

INSPECTION AND PREVENTIVE MAINTENANCE SERVICE

6,000- Mile Main- tenance	1,000- Mile Main- tenance	
		tion and securely fastened. See that connecting fittings are in good condition, secure, and not excessively worn. Inspect light wiring in the same manner.
91	91	LAMPS (HEAD, TAIL, STOP, AND BLACKOUT). Test to see that switches and lamps operate properly; be sure to include the stop light and see that foot switch controls head lamp beams and that they are correctly adjusted. Inspect all lamps for good condition and security, and check for dirty and broken lenses or discolored reflectors.
91		<i>Adjust.</i> Adjust head lamp beams.
93	93	FRONT BUMPERS, ROLLERS, TOW HOOKS, BRUSH GUARDS, AND SHUTTERS. Inspect to see that they are in good condition and secure; that front roller turns and is properly lubricated, correctly assembled to brackets, and that brackets are in good condition and secure.
94	94	HOOD (HINGES AND FASTENERS). See that the hood, hinges, fasteners, and props are in good condition, secure, and properly lubricated.
95	95	FRONT FENDERS AND RUNNING BOARDS. See that they are in good condition and secure.
100	100	BODY (FLOOR, BOWS, TOPS, TROOP SEATS, AND STOWAGE COMPARTMENTS). Inspect these items to see that they are in good condition and secure, and that the tarpaulin and end curtains, fasteners or ropes, grommets, and metal hooks or loops on the body are all present and secure; see that all door, troop seats, and stowage compartment door hinges and latches are adequately lubricated.
99	99	REAR FENDERS AND SPLASH GUARDS. See that they are in good condition and secure.
101	101	REAR BUMPERS AND PINTLE HOOK (LATCH, LOCKPIN, AND DRAWBAR). See that they are in good condition and secure, that the pintle and latch operate properly and are adequately lubricated, and that lockpin is secured with a chain.
102	102	ARMOR PLATE (BODY, COWL, DOORS, WINDSHIELD, AND PORT COVERS). Examine for good condition and security, including peephole or pistolport covers, hinges, and fasteners. Note whether hinges and fasteners are adequately lubricated.

BASIC HALF-TRACK VEHICLES (IHC) (PERSONNEL CARRIER M5, CAR M9A1, MULTIPLE GUN MOTOR CARRIAGE M14, AND SIMILAR IHC VEHICLES)

6,000- Mile Main- tenance	1,000- Mile Main- tenance	
103	103	PAINT AND MARKINGS. Examine paint of entire vehicle for good condition. Repaint bright spots in finish that might cause glare or reflection. See that identification plates and vehicle markings are legible.
104	104	RADIO BONDING (SUPPRESSORS, FILTERS, CONDENSERS, AND SHIELDING). Examine these items to see if their bonding connections are in good condition, clean, and secure, and whether all items are securely mounted. NOTE: Any irregularities, except cleaning and tightening, should be reported through channels to Signal Corps personnel.
105	105	ARMAMENT (GUNS, MOUNTS, RAILS, SPARE PARTS, AND COVERS). Examine gun mountings and rails for good condition, clean lines, security, and lubrication. NOTE: Refer all mounted guns and spare gun parts and covers through channels to the armorer or gun commander for all inspections and service.
TOOLS AND EQUIPMENT		
131	131	TOOLS (VEHICLE AND PIONEER). Check all the standard vehicle and pioneer tools against the stowage lists to see that they are all present, in good condition, clean, and properly stowed or securely mounted. Any tools mounted on the outside of vehicle which have bright or polished surfaces should be painted or otherwise treated so as not to cause glare or reflection.
132	132	FIRE EXTINGUISHER. Inspect to see that it is fully charged, in good condition, securely mounted, and the nozzle clean. The CO ₂ extinguisher must be checked for full charge by weight.
133	133	DECONTAMINATOR. Inspect for good condition, security, and full charge. NOTE: Contents of decontaminator must be renewed every 90 days, as it deteriorates. Refer to tag for date of last recharge.
134	134	FIRST-AID KIT. Inspect for good condition and presence of all items. Report deficiencies immediately.
135	135	PUBLICATIONS AND FORM NO. 26. The vehicle and equipment operators' manuals and parts lists, check chart lubrica-

INSPECTION AND PREVENTIVE MAINTENANCE SERVICE

6,000- Mile Main- tenance	1,000- Mile Main- tenance	
		tion guide, and Standard Accident Form No. 26 should be present, legible, and properly stowed.
136	136	TRACTION DEVICES (CHAINS AND BAND TRACK APPLIER). Inspect chains and connector links for good condition, cleanliness, excessive wear, protection against rust, and proper stowage.
137	137	TOW (CHAIN, CABLES, ROPE, AND BLOCK). See that provided towing devices are in good condition, clean, and properly stowed. Tow chains or cables should be properly protected against rust when not in use. If snatch blocks are furnished, see that they operate freely.
138	138	SPARE SHEAR PINS, FUSES, AND BULBS. See that prescribed number and sizes are present, in good condition, and properly stowed.
139	139	FUEL AND WATER CANS AND BRACKETS. See that they are in good condition and secure, and that caps fit tightly and are secured to can with a chain; examine cans for leaks.
141	141	MODIFICATIONS (FIELD SERVICE MODIFICATION WORK ORDERS COMPLETED). The organizational vehicle records should be checked by the chief of section or other designated individual to be sure that all Field Service Modification Work Orders pertaining to the vehicle have been completed.
142	142	FINAL ROAD TEST. Make final road test, rechecking items 2 to 15 inclusive. Be sure to recheck the transmission, transfer case, and all driving axles to see that lubricant is at the correct level and not leaking. Confine road test to minimum distance necessary to make satisfactory observations. Correct or report all deficiencies found during final road test.

BASIC HALF-TRACK VEHICLES (IHC) (PERSONNEL CARRIER M5, CAR M9A1, MULTIPLE GUN MOTOR CARRIAGE M14, AND SIMILAR IHC VEHICLES)

Section V

LUBRICATION

	Paragraph
Introduction	21
Lubrication guide	22
Points to be serviced and/or lubricated by ordnance maintenance personnel	23
Methods	24

21. INTRODUCTION.

a. Lubrication is an essential part of preventive maintenance, determining to a great extent the serviceability of parts and assemblies.

22. LUBRICATION GUIDE (figs. 24 and 25).

a. **General.** Lubrication instructions for this materiel are consolidated in a lubrication guide (figs. 24 and 25). These specify the points to be lubricated, the periods of lubrication, and the lubricant to be used. In addition to the items on the guide, other small moving parts, such as hinges and latches, must be lubricated at frequent intervals.

b. **Supplies.** In the field it may not be possible to supply a complete assortment of lubricants called for by the lubrication guide to meet the recommendations. It will be necessary to make the best use of those available, subject to inspection by the officer concerned, in consultation with responsible ordnance personnel.

c. **Lubrication Notes.** The following notes apply to the lubrication guide (figs. 24 and 25). All note references in the guide correspond to the step below having the corresponding number:

(1) **FITTINGS.** Clean before applying lubricant. Lubricate until new lubricant is forced from the bearing, unless otherwise specified. **CAUTION:** Lubricate chassis and suspension points after washing vehicle.

(2) **INTERVALS.** Intervals indicated are for normal service. For extreme conditions of speed, heat, water, sand and mud (splash or submersion), snow, rough roads, dust, etc., reduce interval by one-half or lubricate daily when conditions warrant.

(3) **AIR CLEANERS.**

(a) *Engine Air Cleaner* (sec. XVII). *Daily*, check level and refill oil reservoir to bead level with used crankcase oil or OIL, engine (crank-

LUBRICATION

case grade). Every 100 to 1,000 miles, depending on operating conditions, drain, clean, and refill. Every 2,000 miles, also remove air cleaner and wash all parts.

(b) *Hydrovac Cylinder Air Cleaner* (sec. XIII). Every 3 months, remove Hydrovac cylinder air cleaner, wash hair, and oil with used crankcase oil or OIL, engine (crankcase grade).

(c) *Valve Chamber Breather*. Weekly, drain, clean, and refill oil reservoir with used crankcase oil or OIL, engine (crankcase grade). Every 3 months, wash and oil hair element.

(4) **CRANKCASE**. Drain only when engine is hot. Refill to "FULL" mark on gage (9 quarts refill). Run engine a few minutes and recheck oil level. **CAUTION**: Be sure pressure gage indicates oil is circulating.

(5) **OIL FILTERS**. The oil filters are of cartridge type and the unit is mounted on the engine on the left-hand side. Every 2,000 miles, or more frequently, if necessary, remove the cartridges or filter elements by removing the covers and lifting out the cartridges (fig. 26). Drain the sumps to remove deposits when replacing cartridges. Frequency of replacing cartridges depends on the oil used and on operating and atmospheric conditions. A visual inspection of the oil on the bayonet gage will ordinarily determine when the cartridges have become loaded and should be discarded (smoky or black color). Check the oil level after running the engine a few minutes and add oil, if necessary, to bring the oil level to the "FULL" mark. Do not attempt to clean or reinstall old cartridges which have been used.

(6) **GEAR CASES**. Weekly, check level with vehicle on level ground and, if necessary, add lubricant to the correct level; also make visual inspection for leakage; if leakage is found, report to ordnance maintenance personnel. Drain, flush, and refill at the end of the first 1,000 miles; thereafter, as indicated at points on guide. When draining, drain immediately after operation.

(7) **FRONT WHEEL BEARINGS** (sec. XXVI). Remove wheel, clean and repack bearings. To repack bearings properly, remove the hub cap and driving flange stud nuts. Then remove drive shaft flange and bearing adjusting nut. Every 5,000 miles remove bearings, wash, dry, and repack with **GREASE**, general purpose, No. 2 (WB). Replace bearings, tighten adjusting nut until bearings seat themselves and wheel begins to bind while turning by hand. Back off nut one-eighth turn until wheel turns freely without end play. Lock adjusting nut in position with lock washer.

(8) **UNIVERSAL JOINTS (FRONT WHEELS)**. With vehicle on level ground, remove inspection plug in front of joint and fill through fitting at top of housing until lubricant comes out of inspection hole. Every 6,000

BASIC HALF-TRACK VEHICLES (IHC) (PERSONNEL CARRIER M5, CAR M9A1, MULTIPLE GUN MOTOR CARRIAGE M14, AND SIMILAR IHC VEHICLES)

CAUTION Lubricate Dotted Arrow Points on BOTH SIDES. Points on OPPOSITE SIDE are indicated by Dotted Short Shaft Arrows.

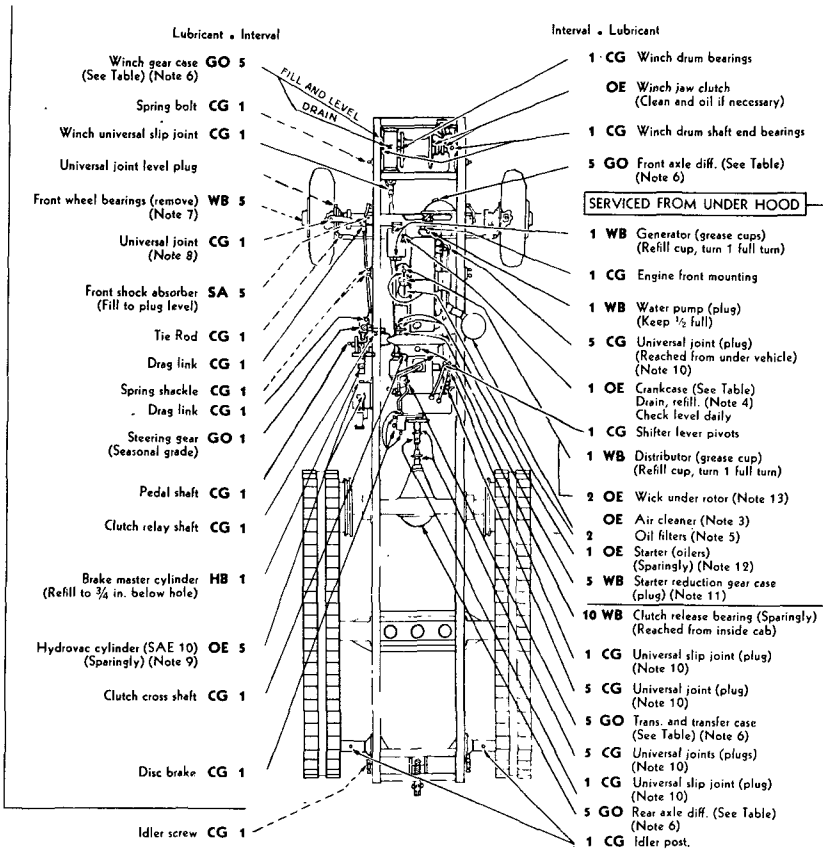

KEY

Lubricants	
OE —OIL, engine Crankcase grade (unless otherwise specified)	WB —GREASE, general purpose No. 2
GO —LUBRICANT, gear, universal	WP —GREASE, water pump
CG —GREASE, general purpose No. 1 (above +32°) No. 1 or No. 0 (+32° to +10°) No. 0 (below +10°)	SA —SHOCK ABSORBER FLUID, heavy
	HB —FLUID, brake, hydraulic

Intervals	
1 — 1,000 Miles	Intervals indicated are for normal service. For extreme conditions of speed, heat, water and mud (splash or submersion), snow, rough roads, dust, etc., reduce interval by one-half or lubricate daily when conditions warrant.
2 — 2,000 Miles	
5 — 5,000 Miles	
Check daily — Crankcase, Aircleaner	

RA PD 302539

Figure 24 — Lubrication Guide

LUBRICATION

TABLE OF CAPACITIES AND LUBRICANTS TO BE USED

	Capacity (Approx.)	Above +32F	+32F to +10F	+10F to -10F	Below -10F
Crankcase	9 qt refill	OE SAE 30*	OE SAE 30 or 10	OE SAE 10**	
Transmission and Transfer Case	9½ qt				
Differential (front)	5 qt	GO SAE 90	GO SAE 80	GO SAE 80	Refer to OFSB 6-11
Differential (rear)	4½ qt				
Winch Gear Case	4 qt				

*Above 90 F, use SAE 50.

**Below 0 F, use SAE 10 plus 10 percent kerosene.

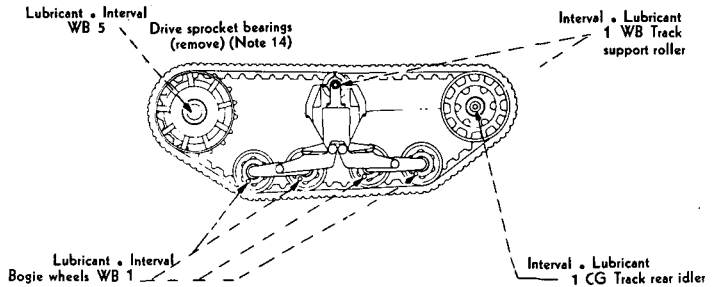

CAUTION Lubricate Suspension System Points on BOTH SIDES of Vehicle

KEY

Lubricants	
CG—GREASE, general purpose No. 1 (above +32°)	WB—GREASE, general purpose No. 2
No. 1 or No. 0 (+32° to +10°)	
No. 0 (below +10°)	

Intervals	
1 — 1,000 Miles	Intervals indicated are for normal service. For extreme conditions of speed, heat, water and mud (splash or submersion), snow, rough roads, dust, etc., reduce interval by one-half or lubricate daily when conditions warrant.
2 — 2,000 Miles	
5 — 5,000 Miles	
Check daily — Crankcase, Aircleaner	

RA PD 302538

Figure 25 — Lubrication Guide of Suspension System

miles, disassemble, clean, reassemble, and refill. (Capacity, 2 pounds 11 ounces.) CAUTION: Do not overlubricate the universal joints as they are not equipped with relief valves.

BASIC HALF-TRACK VEHICLES (IHC) (PERSONNEL CARRIER M5, CAR M9A1, MULTIPLE GUN MOTOR CARRIAGE M14, AND SIMILAR IHC VEHICLES)



RA PD 18345

Figure 26 – Oil Filter Cartridge – Installation

(9) **HYDROVAC CYLINDER.** Every 5,000 miles, remove plug at front of cylinder and plug at center of cylinder and inject about 1 teaspoonful of OIL, engine, SAE 10, in each.

(10) **UNIVERSAL JOINTS AND SLIP JOINTS.** Remove plug and insert fitting to lubricate. **CAUTION:** Do not overlubricate the universal joints as they are not equipped with relief valves.

(11) **STARTER REDUCTION GEAR CASE.** Every 5,000 miles, remove plug in top of housing and lubricate with GREASE, general purpose, No. 2 (WB).

(12) **STARTER.** Every 5,000 miles, remove starter and lubricate Bendix drive outer bearing with OIL, engine (crankcase grade).

(13) **DISTRIBUTOR.** Every 1,000 miles, wipe distributor breaker cam lightly with GREASE, general purpose (seasonal grade), and lubricate breaker arm pivot with OIL, engine (crankcase grade), sparingly. Fill grease cup with GREASE, general purpose, No. 2 (WB) and give one turn.

(14) **DRIVE SPROCKET BEARINGS (sec. XXVI).** Every 5,000 miles remove tracks, drive sprocket flanges, and bearing hubs. Then remove,

LUBRICATION

clean, and repack bearings. To repack bearings properly, remove driving shaft flange stud nuts. Then remove flange and axle. Remove lock nut, adjusting nut, and bearings. Wash bearings, dry, and repack with **GREASE**, general purpose, No. 2 (WB). Replace bearings; tighten adjusting nut to seat bearings until the sprocket turns hard while rotating. Back off one-eighth turn until wheel turns freely without end play. Replace lock nut and lock in place with the lock washer.

(15) **OILCAN POINTS**. Every 1,000 miles, lubricate throttle connections, transfer case linkage, parking brake linkage, bumper roller slides (if so equipped), brake and clutch clevises and pins, and pintle with **OIL**, engine (crankcase grade).

(16) **POINTS REQUIRING NO LUBRICATION SERVICE**. Springs, shock absorber links, bumper roller bearings (if so equipped), clutch pilot bearings, coil springs, bogie wheel suspension linkage, and slides, require no lubrication service. **NOTE**: Friction and vibration tend to develop squeaks, groans, improper fitting of *rubber* chassis parts, instrument panel accessories, and engine mounts. Lubricants such as mineral oil, castor oil, engine oil, or other greases must not be used by reason of their tending to swell or rot the rubber. A suitable lubricating material can be made by mixing colloidal graphite with **ETHYLENE GLYCOL** or glycerine and adding enough water to prevent rapid drying before the solution has penetrated. The solution can be applied with an ordinary spray, but a needle spray will be needed to force the lubricant between parts having close clearance. Rubber parts which are used to keep other parts from slipping or rotating should not be lubricated.

d. Brakes (pars. 59 to 68). If the fluid becomes low due to leakage or through use, air will enter the system and it will be necessary to bleed the brake system. To remove this air, unscrew the plug and fill the supply tank with **FLUID**, brake, hydraulic. Bleed the Hydrovac first and then bleed the wheel cylinders. In bleeding the Hydrovac, start at the bleeder screw nearest the power cylinder and bleed in 1, 2, 3 order toward the end of the slave cylinder. Wheel cylinders may then be bled in any convenient order. Attach bleeder hose to bleeder screw. Run free end of hose to clean glass jar partly filled with brake fluid. Open bleeder valve three-quarters of a turn with wrench provided and pump pedal, slowly forcing fluid from the wheel cylinder into the jar. Continue to pump until the fluid flows clear and without bubbles. The free end of the bleeder must be kept immersed in fluid in jar during pumping, or air will be sucked back into the cylinder. When the fluid flows clear, without bubbles, close bleeder valve, remove bleeder tube, and replace cap screw. After one cylinder has been bled, do not depress brake pedal until the valve of

BASIC HALF-TRACK VEHICLES (IHC) (PERSONNEL CARRIER M5, CAR M9A1, MULTIPLE GUN MOTOR CARRIAGE M14, AND SIMILAR IHC VEHICLES)

the next cylinder has been opened. When all wheel cylinders have been bled, refill master cylinder to proper level with **FLUID**, brake, hydraulic.

23. POINTS TO BE SERVICED AND/OR LUBRICATED BY ORDNANCE MAINTENANCE PERSONNEL.

a. **Speedometer Cable and Tachometer Cable.** Disconnect at the heads and remove the inner cables. Coat shaft with **GREASE**, graphited, light.

b. **Winch Universal Joints.** Whenever the joints are disassembled, clean and repack with **GREASE**, general purpose, No. 2.

24. METHODS.

a. Lubricants are applied by employing the equipment provided with the vehicle.

(1) **LOW TEMPERATURE LUBRICATION.** See section VII for information on chassis, crankcase, and gear lubricants for subzero temperatures.

(2) **RECORDS.** Keep a record of lubrication for every vehicle in its motor book. Responsible personnel will check at regular intervals the actual mileage and date at which each vehicle receives prescribed attention.

Section VI

TOOLS AND EQUIPMENT STOWAGE ON THE VEHICLE

	Paragraph
Vehicular tools	25
Vehicular equipment	26
Vehicular spare parts	27
Gun tools	28
Gun equipment	29
Gun spare parts	30

25. VEHICULAR TOOLS.

a. **General.** The materiel indicated herein includes tools and equipment for general care, maintenance, and preservation for the Half-track Personnel Carrier M5, Half-track Car M9A1, and Multiple Gun Motor Carriage M14. Tools and equipment should not be used for purposes other than as prescribed and when not in use should be stowed in their proper places or receptacles provided.

b. **Manuals.** Technical Manuals describing drivers' operations and organization maintenance as well as Parts Catalogs are shipped with the vehicles for initial delivery. These publications are a part of the equipment and should accompany the vehicle at all times, or be available within the organization and transferred with the vehicle. Complete familiarity with the data in these publications is necessary for the proper performance and function of drivers and mechanics. Technical Manuals and Standard Nomenclature Lists prepared by the War Department supplement and augment the manufacturers' manuals according to War Department requirements.

c. The following vehicular tools are for the Half-track Personnel Carrier M5.

(1) **VEHICULAR TOOLS.**

TOOL	NUMBER CARRIED	WHERE CARRIED
ADAPTER, fitting, lubricating, grease gun	1	Center floor well
BRUSH, wire	1	" " "
EXTENSION, ½-in. sq-drive, 10-in.	1	" " "
GUN, lubricating, hand type, 1	1	" " "
HAMMER, machinist, ball peen, 32-oz	1	" " "

BASIC HALF-TRACK VEHICLES (IHC) (PERSONNEL CARRIER M5, CAR M9A1, MULTIPLE GUN MOTOR CARRIAGE M14, AND SIMILAR IHC VEHICLES)

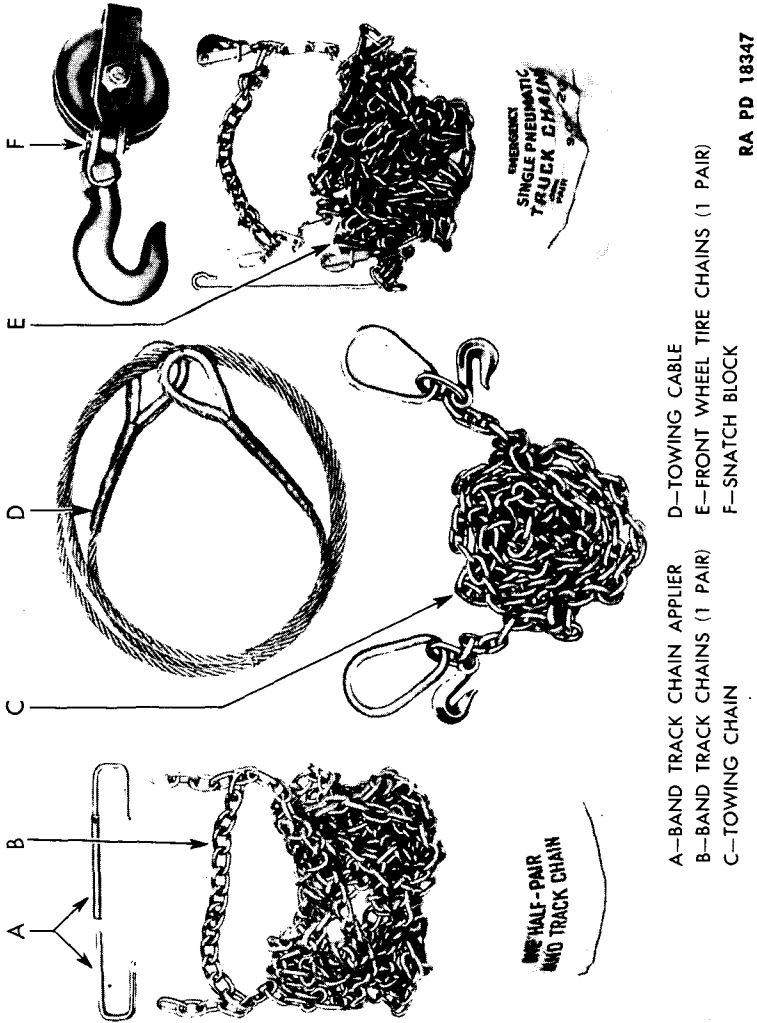

A—BAND TRACK CHAIN APPLIER D—TOWING CABLE
 B—BAND TRACK CHAINS (1 PAIR) E—FRONT WHEEL TIRE CHAINS (1 PAIR)
 C—TOWING CHAIN F—SNATCH BLOCK

RA PD 18347

Figure 27 — Tools and Equipment

TOOLS AND EQUIPMENT STORAGE ON THE VEHICLE

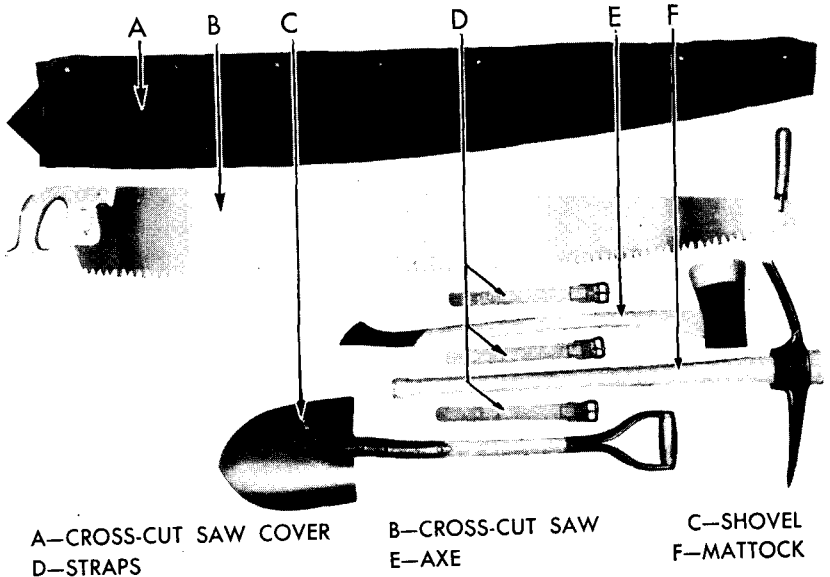

RA PD 18348

Figure 28 — Tools and Equipment

TOOL	NUMBER CARRIED	WHERE CARRIED
HANDLE, wheel bearing nut wrench	1	Center floor well
JACK, hydraulic, w/handle	1	“ “ “
OILER, trigger type, 1-pt	1	“ “ “
PLIERS, combination, slip joint, 8-in.	1	“ “ “
PUMP, tire, hand	1	Under left rear seat
RATCHET, wrench, reversible, 1/2-in. sq-drive, 9-in.	1	Center floor well
SCREWDRIVER, common, 6-in. blade	1	“ “ “
SCREWDRIVER, common, 8-in. blade	1	“ “ “
SCREWDRIVER, special purpose, 1 3/4-in. blade	1	“ “ “
WRENCH, engrs., dble-end, 7/16 x 1/2	1	“ “ “
WRENCH, engrs., dble-end, 9/16 x 5/8	1	“ “ “

BASIC HALF-TRACK VEHICLES (IHC) (PERSONNEL CARRIER M5, CAR M9A1, MULTIPLE GUN MOTOR CARRIAGE M14, AND SIMILAR IHC VEHICLES)

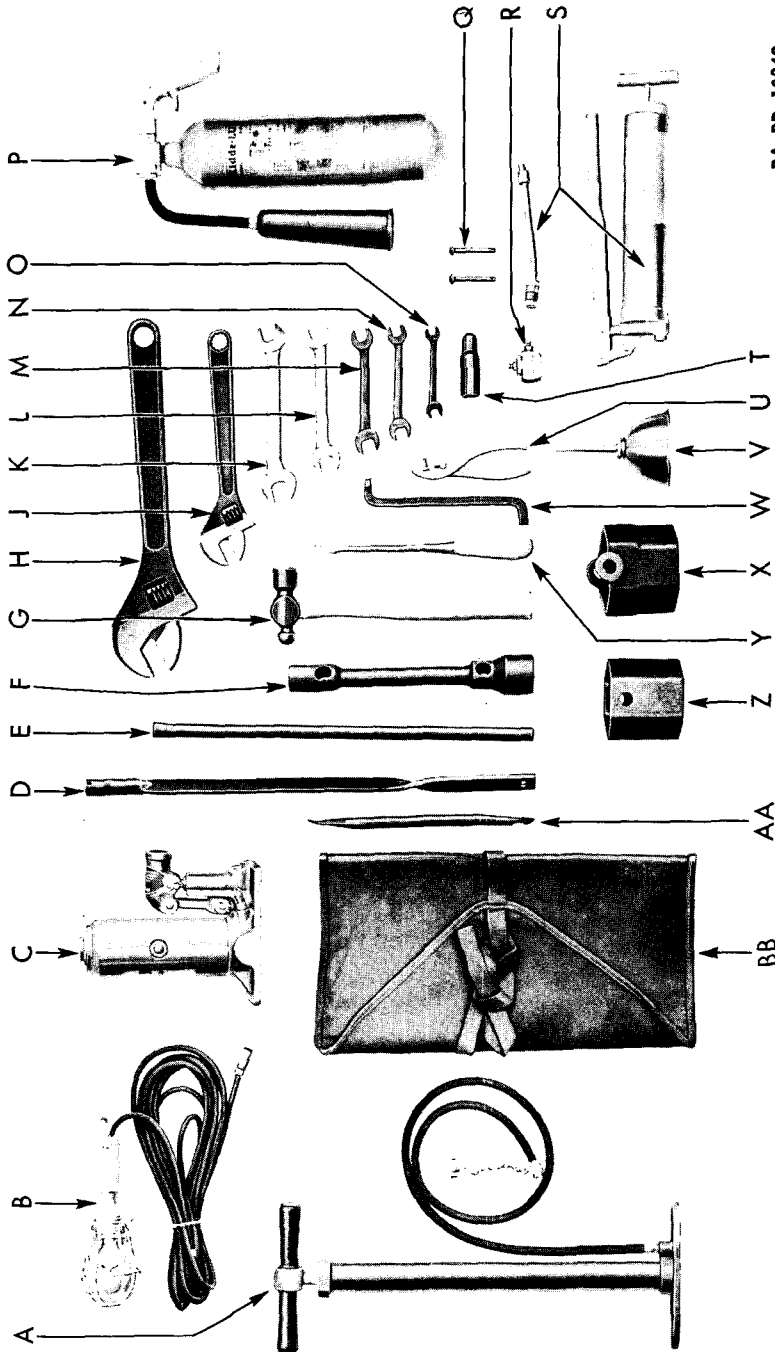

RA PD 18349

Legend for Figure 29 — Tools and Equipment

TOOLS AND EQUIPMENT STOWAGE ON THE VEHICLE

- | | |
|------------------------------------------|---------------------------------------------|
| A—TIRE PUMP | P—FIRE EXTINGUISHER (CO ₂) |
| B—INSPECTION LIGHT | Q—WINCH DRIVE SHAFT SHEAR PIN |
| C—HYDRAULIC JACK | R—ALEMITE GUN ADAPTER (BUTTON HEAD FITTING) |
| D—JACK HANDLE | S—ALEMITE GUN AND ADAPTER |
| E—RIM NUT WRENCH HANDLE | T—SPARK PLUG WRENCH |
| F—RIM NUT SOCKET WRENCH | U—PLIERS |
| G—HAMMER | V—OIL CAN |
| H—ADJUSTABLE WRENCH—18 INCH | W—DRAIN PLUG WRENCH |
| J—ADJUSTABLE WRENCH—12 INCH | X—REAR AXLE SPROCKET HUB BEARING NUT WRENCH |
| K—DOUBLE-END WRENCH—3/4 IN. x 7/8 IN. | Y—SCREW DRIVER |
| L—DOUBLE-END WRENCH—5/8 IN. x 25/32 IN. | Z—FRONT WHEEL BEARING NUT WRENCH |
| M—DOUBLE-END WRENCH—9/16 IN. x 11/16 IN. | AA—BEARING NUT WRENCH HANDLE |
| N—DOUBLE-END WRENCH—1/2 IN. x 19/32 IN. | BB—TOOL BAG |
| O—DOUBLE-END WRENCH—3/8 IN. x 7/16 IN. | |

RA PD 18349B

Legend for Figure 29 — Tools and Equipment

BASIC HALF-TRACK VEHICLES (IHC) (PERSONNEL CARRIER M5, CAR M9A1, MULTIPLE GUN MOTOR CARRIAGE M14, AND SIMILAR IHC VEHICLES)

TOOL	NUMBER CARRIED	WHERE CARRIED
WRENCH, engr., dble-end, 3/4 x 1 5/16	1	Center floor well
WRENCH, engr., dble-end, 1 1/16 x 1 5/16 (special)	1	" " "
WRENCH, sgle-end, adj., 18-in.	1	" " "
WRENCH, socket, 1/2-in. sq-drive, 3/4-in. hex.	1	" " "
WRENCH, socket, wheel bearing nut	1	" " "
WRENCH, socket, wheel stud nut	1	" " "
WRENCH, spark plug	1	" " "
(2) PIONEER TOOLS.		
AXE (chopping, single bit, 5-lb)	1	Outside vehicle in brackets provided
COVER, canvas, crosscut saw	1	Under right rear seats
MATTOCK, pick, M1 (w/handle), 5-lb	1	Outside vehicle in brackets provided
SAW, crosscut, one-man, 4 1/2-ft long, w/handle	1	Under right rear seats
SHOVEL, short handle	1	Outside vehicle in brackets provided

d. The following vehicular tools are for the Half-track Car M9A1.

(1) VEHICULAR TOOLS.

ADAPTER, fitting, lubricating, grease gun	1	Center floor well
BRUSH, wire	1	" " "
EXTENSION, 1/2-in. sq-drive, 10-in.	1	" " "
GUN, lubricating, hand type	1	" " "
HAMMER, machinist, ball peen, 32-oz	1	" " "
HANDLE, wheel bearing nut wrench	1	" " "
JACK, hydraulic, w/handle	1	" " "

TOOLS AND EQUIPMENT STOWAGE ON THE VEHICLE

TOOL	NUMBER CARRIED	WHERE CARRIED
OILER, trigger type, 1-pt	1	Center floor well
PLIERS, combination, slip joint, 8-in.	1	" " "
RATCHET, wrench, reversible, 1/2-in. sq-drive, 9-in.	1	" " "
SCREWDRIVER, common, 6-in. blade	1	" " "
SCREWDRIVER, common, 8-in. blade	1	" " "
SCREWDRIVER, special purpose, 1 3/4-in. blade	1	" " "
WRENCH, engr., dble-end, 7/16 x 1/2	1	" " "
WRENCH, engr., dble-end, 9/16 x 5/8	1	" " "
WRENCH, engr., dble-end, 3/4 x 1 1/16	1	" " "
WRENCH, engr., dble-end, 1 1/16 x 1 5/16 (special)	1	" " "
WRENCH, sgle-end, adj., 18-in.	1	" " "
WRENCH, socket, 1/2-in. sq-drive, 3/4-in. hex.	1	" " "
WRENCH, socket, wheel bearing nut	1	" " "
WRENCH, socket, wheel stud nut	1	" " "
WRENCH, spark plug	1	" " "
(2) PIONEER TOOLS.		
AXE (chopping, single bit, 5-lb)	1	Outside vehicle in brackets provided
COVER, canvas, crosscut saw	1	Under right rear seats
CROWBAR, pinch point, 5-ft	1	Under left rear seats
MATTOCK, pick, M1 (w/handle), 5-lb	1	Outside vehicle in brackets provided
SAW, crosscut, one-man, 4 1/2-ft long, w/handle	1	Under right rear seats
SHOVEL, short handle	1	Outside vehicle in brackets provided

BASIC HALF-TRACK VEHICLES (IHC) (PERSONNEL CARRIER M5, CAR M9A1, MULTIPLE GUN MOTOR CARRIAGE M14, AND SIMILAR IHC VEHICLES)

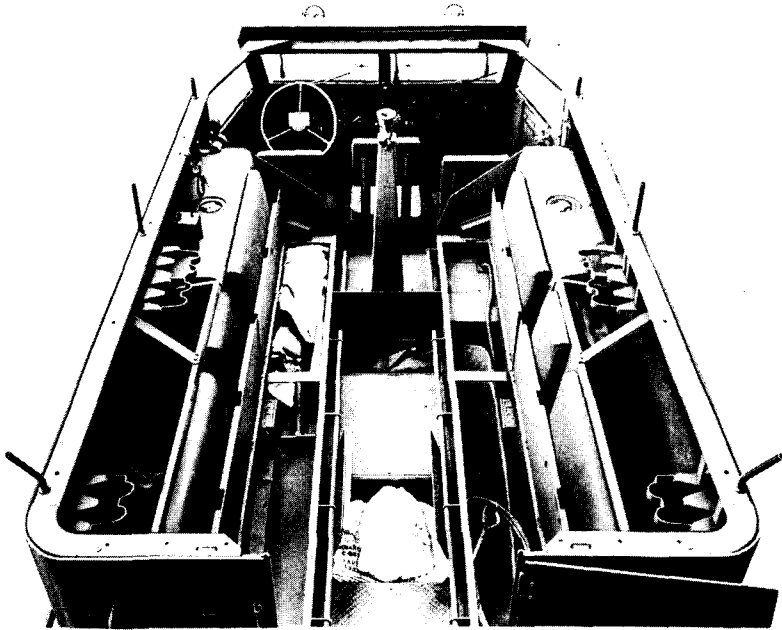

RA PD 18351

Figure 30 – Stowage Compartments – Open (M5)

e. The following vehicular tools are for the Multiple Gun Motor Carriage M14.

(1) **VEHICULAR TOOLS.**

TOOL	NUMBER CARRIED	WHERE CARRIED
BRUSH, wire	1	Center floor well
CHISEL, cold, 3/4-in.	1	“ “ “
CORE, valve, tire	5	“ “ “
EXTENSION, 1/2-in. sq-drive, 10-in.	1	“ “ “
FILE, hand, smooth, 8-in.	1	“ “ “
FILE, 3-sq smooth, 6-in.	1	“ “ “
FITTING, grease, 1/8-in., straight	3	“ “ “
FITTING, grease, 1/8-in., 90 deg	3	“ “ “
HAMMER, machinist, ball peen, 32-oz	1	“ “ “
HANDLE, rim wrench	1	“ “ “

TOOLS AND EQUIPMENT STOWAGE ON THE VEHICLE

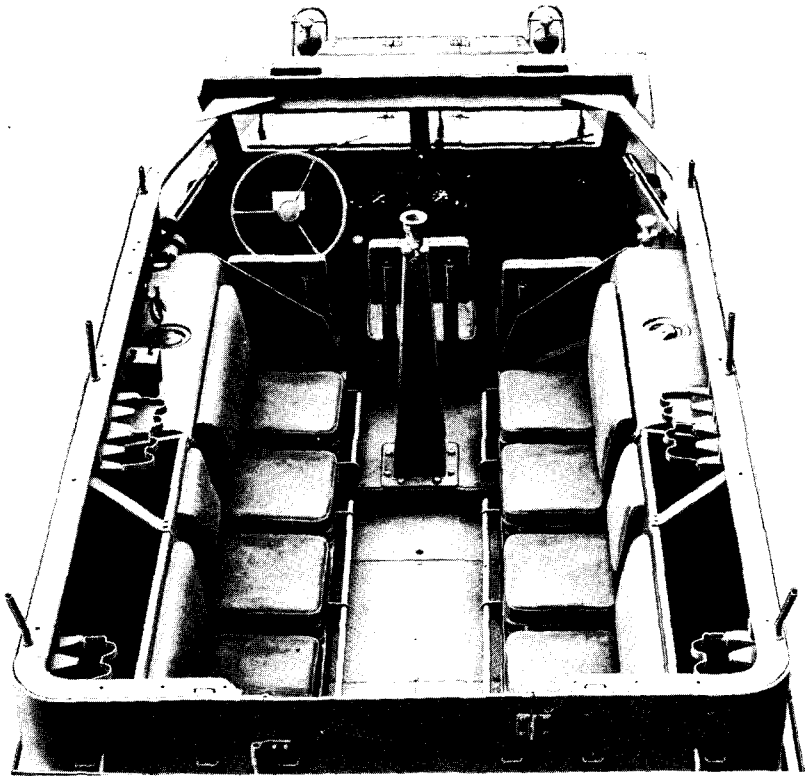

RA PD 18331

Figure 31 — Stowage Compartments — Closed (M5)

TOOL	NUMBER CARRIED	WHERE CARRIED
HANDLE, socket wrench	1	Center floor well
HEAD LAMP, removable, driving (spare)	1	In spare lamp bracket
JACK, hydraulic, w/handle	1	Center floor well
PLUG, pipe, 1/8-in.	1	" " "
PLUG, pipe, 1/4-in.	1	" " "
PLUG, spark	3	" " "
PLIERS, combination, slip joint, 8-in.	1	" " "
RATCHET, reversible, 1/2-in. sq-drive, 9-in.	1	" " "
SCREWDRIVER, common, 6-in. blade	1	" " "

TM 9-707

25-26

BASIC HALF-TRACK VEHICLES (IHC) (PERSONNEL CARRIER M5, CAR M9A1, MULTIPLE GUN MOTOR CARRIAGE M14, AND SIMILAR IHC VEHICLES)

TOOL	NUMBER CARRIED	WHERE CARRIED
SCREWDRIVER, common, 8-in. blade	1	Center floor well
SCREWDRIVER, special purpose, 1 3/4-in. blade	1	" " "
WRENCH, drain plug	1	" " "
WRENCH, engrs., dble-hd., 7/16 x 1/2	1	" " "
WRENCH, engrs., dble-hd., 9/16 x 5/8	1	" " "
WRENCH, engrs., dble-hd., 3/4 x 1 5/16	1	" " "
WRENCH, engrs., dble-hd., 1 1/16 x 1 5/16 (special)	1	" " "
WRENCH, sgle-end, adj., 18-in. (modified to 2 3/16-in.)	1	" " "
WRENCH, socket, 1/2-in. sq-drive, 3/4-in. hex.	1	" " "
WRENCH, socket, front wheel bearing nut	1	" " "
WRENCH, socket, rear wheel bearing nut	1	" " "
(2) PIONEER TOOLS.		
AXE (chopping, single bit, 5-lb)	1	Outside below right door
CROWBAR, pinch point, 5-ft	1	In fighting compartment
MATTOCK, pick, M1 (w/handle), 5-lb	1	Outside below left door
SHOVEL, short handle	1	" " " "

26. VEHICULAR EQUIPMENT.

a. The following accessories and equipment cover the Half-track Personnel Carrier M5.

(1) MISCELLANEOUS ACCESSORIES AND EQUIPMENT.

ITEM	NUMBER CARRIED	WHERE CARRIED
APPARATUS, decontaminating, 1 1/2-qt, M11	1	Right of right shutter handle bracket fastened to plate

TOOLS AND EQUIPMENT STOWAGE ON THE VEHICLE

ITEM	NUMBER CARRIED	WHERE CARRIED
APPLIER, track chain (female)	2	Rear floor well in bag w/track chains
APPLIER, track chain (male)	2	Rear floor well in bag w/track chains
BAG, field, canvas, O.D., M1936	13	Between individual's feet
BAG, tool	1	Center floor well
BOOK, O.O. form 7255	1	In glove compartment
BUCKET, canvas, folding, 18-qt	1	Rear floor well
CABLE, towing, 5/8-in. x 15-ft	1	" " "
CANTEEN, M1910, with cup and cover, M1910	13	On seats between cushions
CHAIN, tire, front wheel (with bag)	1 pr.	Rear floor well
CONTAINER, fuel, 5-gal, Q.M.C. standard	2	Behind left rear seats
CONTAINER, water, 5-gal, Q.M.C. standard	2	In brackets on side of cowl
CROWBAR, pinched point, 5-ft	1	Under left rear seats
EXTINGUISHER, fire (2-lb CO ₂) and BRACKET assembly	1	To right of right front seat
FLASHLIGHT, TL-122A	2	In flashlight clips
GAGE, tire pressure	1	Center floor well
GUIDE, lubrication	1	In bracket, right door
KEY, map compartment	2	In map compartment lock
KIT, first-aid, 24-unit	1	In bracket front of center front seat
KIT, tire repair, hot patch, w/clamp	1	Center floor well
LINK, No. 4, monkey, track chain repair	4	Center floor well
LAMP, bulb inspection, 12-16V	2	In glove compartment
LAMP, inspection	1	" " "
MANUAL, field, for A.T. mines	1	Under left rear seat
MANUAL, field, for hand grenades (FM 23-30)	1	" " " "

BASIC HALF-TRACK VEHICLES (IHC) (PERSONNEL CARRIER M5, CAR M9A1, MULTIPLE GUN MOTOR CARRIAGE M14, AND SIMILAR IHC VEHICLES)

ITEM	NUMBER CARRIED	WHERE CARRIED
MANUAL, field, for machine gun, cal. .30, M1919A4 (FM 23-50)	1	Under left rear seat
MANUAL, field, for submachine gun, cal. .45, M1928A1 (FM 23-40)	1	" " " "
MANUAL, operating	1	In glove compartment
MANUAL, spare parts, illustrated (for vehicle)	1	" " "
MANUAL, technical (TM 9-711A)	1	" " "
MITTENS, asbestos, pr.	2	Under left rear seats
NET, camouflage, 22- x 22-ft	1	" " " "
ROLL, blanket	13	Inside canvas seats
SNATCH BLOCK (use with winch only)	1	Rear floor well
STRAP, fender, 42- x 1½-in.	4	On fenders
TOP, assembly, canvas, vehicle, including the following:	1	On right front fender
BAG, canvas	1	Behind left rear seats
BOW, top (1-front, 1-center, 1-rear)	3	" " " "
CURTAIN, canvas, L.H., w/flaps	1	" " " "
CURTAIN, canvas, R.H., w/flaps	1	" " " "
ROD, curtain, ⅜ diam x 22 ⁵ / ₁₆ -in. long	2	" " " "
ROD, curtain, ⅜ diam x 22 ⁵ / ₁₆ -in. 2-center, 2-rear)	6	" " " "
STRAP, top	2	" " " "
TUBE, flexible nozzle	2	Under left rear seat
WIRE, soft iron, 14-ga., 10-ft	1	Center floor well
(2) BINOCULAR M3, COMPLETE.	1	On commander
Composed of:		
BINOCULAR, M3	1	
CASE, carrying	1	
STRAP, neck	1	
(3) SIGNALING EQUIPMENT.		
ANTENNA, complete w/cover	1	Behind right rear seats

TOOLS AND EQUIPMENT STOWAGE ON THE VEHICLE

ITEM	NUMBER CARRIED	WHERE CARRIED
RADIO SET, SCR. 193, or 245, or 506 or 508, or 510	1	In brackets provided
(4) RATIONS.		
Type "C" 1-day rations for 13 men	78 cans	Under left rear seat
Type "D" 1-day rations for 13 men	4 cans	" " " "
b. The following accessories and equipment cover the Half-track Car M9A1.		
(1) MISCELLANEOUS ACCESSORIES AND EQUIPMENT.		
APPARATUS, decontaminating, 1½-qt, M11	1	Right of right shutter handle bracket fastened to plate
APPLIER, track chain (female)	2	Rear floor well in bag w/track chains
APPLIER, track chain (male)	2	Rear floor well in bag w/track chains
BAG, field, canvas, O.D., M1936	10	6 under left and 4 under right seats
BAG, tool	1	Center floor well
BOOK, O.O. form 7255	1	In glove compartment
BUCKET, canvas, folding, 18-qt	1	Rear floor well
CABLE, towing, ⅝-in. x 15-ft	1	On front bumpers or rear floor well
CANTEEN, M1910, with cup and cover M1910	10	Between seats
CHAIN, tire, front wheel (w/bag)	1 pr.	Rear floor well
CHAIN, track	1 pr.	" " "
CONTAINER, fuel, 5-gal, Q.M.C. standard	1	Floor at rear of vehicle
CONTAINER, water, 5-gal, Q.M.C. standard	1	In brackets on side of cowl
EXTINGUISHER, fire (2-lb CO ₂) and BRACKET assembly	1	To right of right front seat
FLASHLIGHT, TL-122A	2	In flashlight clips
GAGE, tire pressure	1	Center floor well
GUIDE, lubrication	1	In bracket, right door

BASIC HALF-TRACK VEHICLES (IHC) (PERSONNEL CARRIER M5, CAR M9A1, MULTIPLE GUN MOTOR CARRIAGE M14, AND SIMILAR IHC VEHICLES)

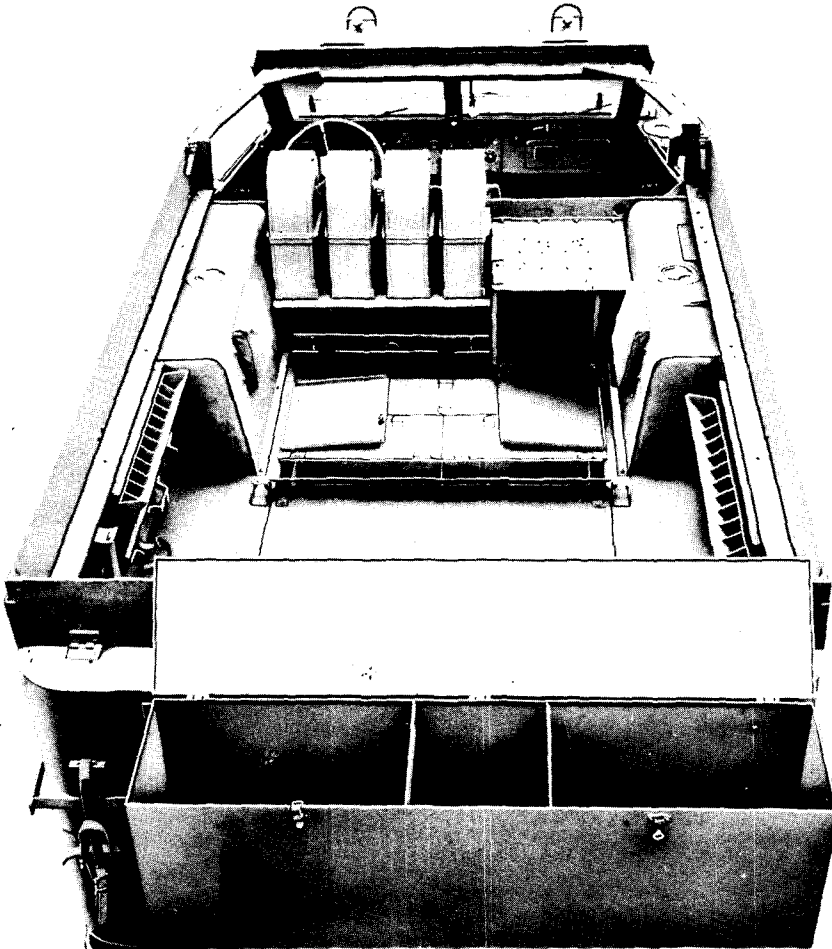

Figure 32 — Stowage Compartments — Open (M14) RA PD 18535

ITEM	NUMBER CARRIED	WHERE CARRIED
KEY, map compartment	2	In lock, map compartment
KIT, first-aid, 24-unit	1	Between center seats and right ammunition chests
KIT, tire repair, hot patch, w/clamp	1	Rear floor well
LAMP, bulb, inspection, 12-16V	2	In glove compartment
LAMP, inspection	1	“ “ “
LINK, No. 4, monkey, track chain repair	4	Rear floor well

TOOLS AND EQUIPMENT STOWAGE ON THE VEHICLE

ITEM	NUMBER CARRIED	WHERE CARRIED
MANUAL, field, for A. T. mines	1	Under left rear seat
MANUAL, field, for hand grenades (FM 23-30)	1	" " " "
MANUAL, field, for machine gun, cal. .30, M1919A4 (FM 23-50)	1	" " " "
MANUAL, field, for submachine gun, cal. .45, M1928A1 (FM 23-40)	1	" " " "
MANUAL, field, for Browning machine gun, cal. .50, M2 (FM 23-65)	1	" " " "
MANUAL, operating	1	In glove compartment
MANUAL, spare parts, illustrated (for vehicle)	1	" " "
MANUAL, technical (TM 9-711A)	1	" " "
MITTENS, asbestos, pr.	2	Under left rear seats
NET, camouflage, 22- x 22-ft.	1	" " " "
PUMP, tire, hand	1	Center floor well
PULLER, ammunition	2	Under left rear seats
ROLL, blanket	10	Inside seat covers
SNATCH BLOCK (use with winch only)	1	Rear floor well
STRAPS, fender, 42- x 1½-in.	4	On front fenders
TAPE, friction, ¼-in. wide, 30-ft roll	1	Rear floor well
TOP, assembly, canvas, vehicle, including the following:	1	On right front fender
BAG, canvas	1	Under left rear seat
BOW, top (1-center, 1-rear, 1-front)	3	" " " "
CURTAIN, canvas, L.H., w/flaps	1	" " " "
CURTAIN, canvas, R.H., w/flaps	1	" " " "
ROD, curtain, ⅜ diam x 22⅝-in. long	2	" " " "
ROD, top bow support (2-front, 2-center, 2-rear)	6	" " " "
STRAP, top	2	" " " "
TUBE, flexible nozzle	2	Under left rear seat
WIRE, soft iron, 14-ga., 10-ft	1	Center floor well

**BASIC HALF-TRACK VEHICLES (IHC) (PERSONNEL CARRIER M5, CAR M9A1,
MULTIPLE GUN MOTOR CARRIAGE M14, AND SIMILAR IHC VEHICLES)**

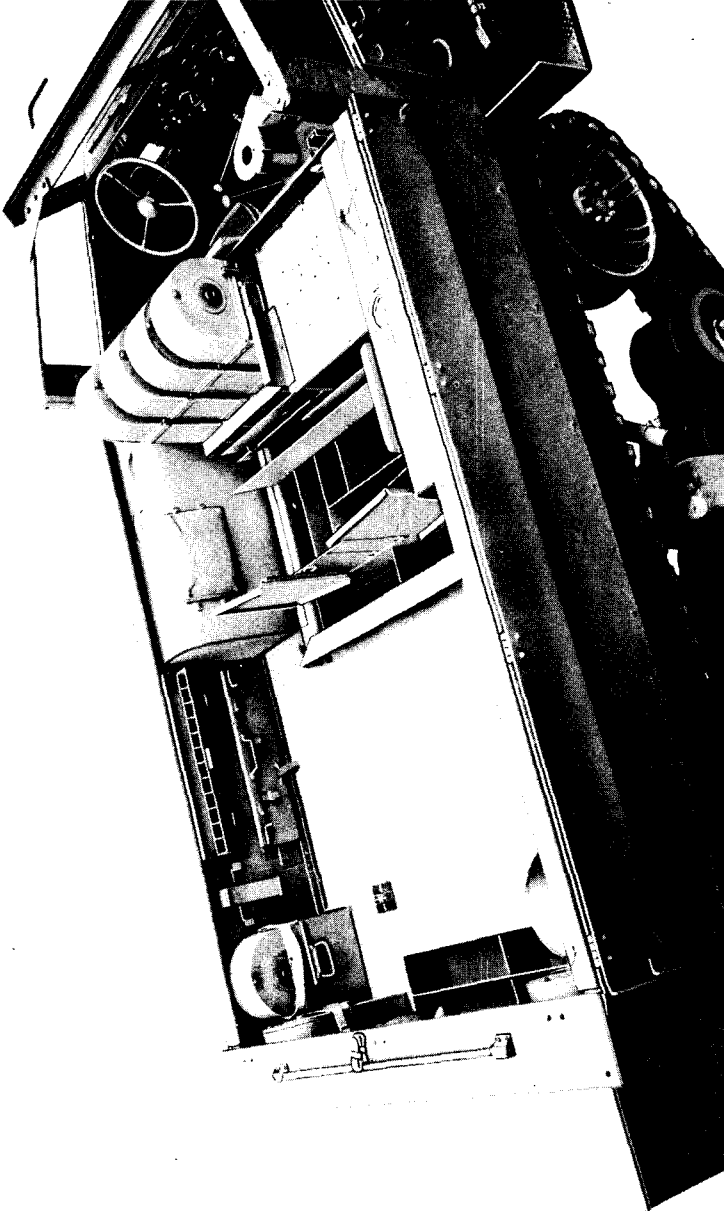

RA PD 18536

Figure 33 — Stowage Compartments — Closed (M14)

TOOLS AND EQUIPMENT STOWAGE ON THE VEHICLE

ITEM	NUMBER CARRIED	WHERE CARRIED
(2) BINOCULAR M3, COMPLETE.	1	On commander
Composed of:		
BINOCULAR, M3	1	
CASE, carrying	1	
STRAP, neck	1	
(3) SIGNALING EQUIPMENT.		
ANTENNA, complete, w/cover	1	Above right rear seats
RADIO SET, SCR. 193, or 245, or 506, or 508, or 510	1	In brackets provided
(4) RATIONS.		
Type "C" 1-day rations for 10 men	60 cans	Under left rear seats
Type "D" 1-day rations for 10 men	4 cans	" " " "

c. The following accessories and equipment cover the Multiple Gun Motor Carriage M14.

(1) MISCELLANEOUS ACCESSORIES AND EQUIPMENT.		
ADAPTER, lubricating grease gun	1	Center floor well
APPARATUS, decontaminating, 1½-qt, M2	1	Left of driver's seat
APPLIER, track chain	2	Center floor well
BAG, field, canvas, O.D., M1936	5	Top of front gas tanks
BAG, tool	1	Center floor well
BOOK, O.O. form 7255	1	Glove compartment
BUCKET, canvas, folding, 18-qt	1	Behind driver's seat
BUCKET, galv. iron, 14-qt	1	Left rear outside
CABLE, towing, 5/8-in. x 15-ft	1	On front bumpers
CANTEEN, M1910, w/cup and cover, M1910	5	On troops
CHAIN, tire, front wheel (w/bag) (9.00 x 20)	1 pr.	Center floor well
CHAIN, track	1 pr.	" " "
CONTAINER, water, 5-gal, Q.M.C. standard	2	Outside, engine cowl
CUSHION, seat	5	On seat boxes

BASIC HALF-TRACK VEHICLES (IHC) (PERSONNEL CARRIER M5, CAR M9A1, MULTIPLE GUN MOTOR CARRIAGE M14, AND SIMILAR IHC VEHICLES)

ITEM	NUMBER CARRIED	WHERE CARRIED
EXTINGUISHER, fire (2-lb CO ₂) and BRACKET assembly	1	Right of driver's seat
FLASHLIGHT (specification 17-197)	2	In flashlight clips
GAGE, tire pressure	1	Center floor well
GUIDE, lubrication	1	In bracket, right door
GUN, lubricating, hand type	1	Center floor well
KEY, map compartment	2	In map compartment lock
KIT, first-aid, 24-unit	1	Left side fighting compartment
KIT, tire repair, hot patch, w/clamp	1	Center floor well
LAMP, bulb, inspection, 12-16V D.C.	2	Glove compartment
LAMP, inspection	1	" "
LINK, No. 4, monkey, track chain repair	4	Center floor well
MANUAL, field, for Browning machine gun, cal. .50, HB M2 (FM 23-65)	1	Glove compartment
MANUAL, field, for hand grenades (FM 23-30)	1	" "
MANUAL, field, for submachine gun, cal. .45, M1928A1 (FM 23-40)	1	" "
MANUAL, operating	1	" "
MANUAL, spare parts, illustrated (for vehicle)	1	" "
MANUAL, technical, for Multiple Gun Motor Carriage M14 (TM 9-707)	1	" "
MANUAL, technical, mount, machine gun, twin, cal. .50, M33 (TM 9-223)	1	" "
MITTENS, asbestos	2 pr.	Center floor well
NET, camouflage, 22- x 22-ft	1	Right front fender
OILER, trigger type, 1-pt	1	Center floor well
PUMP, tire, hand, complete	1	" " "
ROLL, blanket	5	Box, rear of vehicle
SHEAR PIN, winch	6	Center floor well
SNATCH BLOCK	1	" " "

TOOLS AND EQUIPMENT STOWAGE ON THE VEHICLE

ITEM	NUMBER CARRIED	WHERE CARRIED
STRAP, fender, 42- x 1 1/2-in.	4	2 each front fender
TAPE, friction, 3/4-in. wide, 30-ft roll	1	Center floor well
TARPAULIN, 12- x 12-ft	1	Left front fender
TUBE, flexible nozzle	2	Center floor well
WIRE, soft iron, 14-ga., 1-lb	1	" " "
(2) BINOCULAR M3, COMPLETE.	1	On commander
Composed of:		
BINOCULAR, M3	1	
CASE, carrying	1	
STRAP, neck	1	
SIGHT, reflector, Mk. IX (Navy)	1	On gun mount
(3) SIGNALING EQUIPMENT.		
FLAG SET, M238, composed of:	1	Right of commander's seat
CASE, CS-90	1	
FLAG, MC-273 (red)	1	
FLAG, MC-274 (orange)	1	
FLAG, MC-275 (green)	1	
FLAG STAFF, MC-270	3	
RADIO SET, SCR. 593, or British No. 19	1	
(4) RATIONS.		
Type "C" 2-day rations for 5 men	60 cans	In compartment under radio
Type "D" 1-day rations for 5 men	2 cans	In compartment under radio

27. VEHICULAR SPARE PARTS.

a. The following vehicular spare parts cover the Half-track Personnel Carrier M5.

(1) VEHICULAR SPARE PARTS.

BELT, fan	2	Center floor well
CAP, valve, tire	5	" " "
CONDENSER, distributor	1	" " "
CORE, valve, tire	5	" " "

BASIC HALF-TRACK VEHICLES (IHC) (PERSONNEL CARRIER M5, CAR M9A1, MULTIPLE GUN MOTOR CARRIAGE M14, AND SIMILAR IHC VEHICLES)

ITEM	NUMBER CARRIED	WHERE CARRIED
FITTING, grease, 1/8-in., straight	3	Center floor well
FITTING, grease, 1/8-in., 45 deg	3	" " "
HEAD LAMP, removable, driving (spare)	1	Above left gas tank
PLUG, pipe, 1/8-in.	1	Center floor well
PLUG, pipe, 1/4-in.	1	" " "
PLUG, spark	3	Center floor well
SHEAR PIN, winch (when winch is specified)	6	" " "
TAPE, friction, 3/4-in. wide, 30-ft roll	1	" " "

b. The following vehicular spare parts cover the Half-track Car M9A1.

(1) VEHICULAR SPARE PARTS.

BELT, fan	2	Center floor well
CAP, valve, tire	5	" " "
CONDENSER, distributor	1	" " "
CORE, valve, tire	5	" " "
FITTING, grease, 1/8-in., straight	3	" " "
FITTING, grease, 1/8-in., 45 deg	3	" " "
HEAD LAMP, removable, driving (spare)	1	Stored in bracket provided
PLUG, pipe, 1/8-in.	1	Center floor well
PLUG, pipe, 1/4-in.	1	" " "
PLUG, spark	3	" " "
SHEAR PIN, winch (when winch is specified)	6	" " "

c. The following vehicular spare parts cover the Multiple Gun Motor Carriage M14.

(1) VEHICULAR SPARE PARTS.

BELT, fan	2	Center floor well
CAP, valve, tire	5	" " "

TOOLS AND EQUIPMENT STOWAGE ON THE VEHICLE

ITEM	NUMBER CARRIED	WHERE CARRIED
CONDENSER (distributor) and bracket (unassembled)	1	Center floor well
CORE, valve, tire	5	" " "
FITTING, grease, 1/8-in., straight	3	" " "
FITTING, grease, 1/8-in., 90 deg	3	" " "
PLUG, pipe, 1/8-in.	1	" " "
PLUG, pipe, 1/4-in.	1	" " "
PLUG, spark	3	" " "
HEAD LAMP, removable, driving (spare)	1	In spare lamp bracket

28. GUN TOOLS.

a. The following gun tools cover the Half-track Personnel Carrier M5.

(1) TOOLS FOR CAL. .30 MACHINE GUN.

SCREWDRIVER, common, 3-in. blade	1	Under right rear seats
WRENCH, combination, M6	1	" " " "
WRENCH, socket (front barrel bearing plug)	1	" " " "

b. The following gun tools cover the Half-track Car M9A1.

(1) TOOLS FOR CAL. .30 MACHINE GUN.

SCREWDRIVER, common, 3-in. blade	1	Under right rear seats
WRENCH, combination, M6	1	" " " "
WRENCH, socket (front barrel bearing plug)	1	" " " "

(2) TOOLS FOR CAL. .50 MACHINE GUN.

WRENCH, combination, M2	1	Under right rear seats
-------------------------	---	------------------------

c. The following gun tools cover the Multiple Gun Motor Carriage M14.

(1) TOOLS FOR CAL. .50 MACHINE GUN.

PLIERS, side cut, parallel jaw, 6-in.	2	1 in each M5 chest
PUNCH, drive pin, 12-in. point	2	" " " " "

BASIC HALF-TRACK VEHICLES (IHC) (PERSONNEL CARRIER M5, CAR M9A1, MULTIPLE GUN MOTOR CARRIAGE M14, AND SIMILAR IHC VEHICLES)

ITEM	NUMBER CARRIED	WHERE CARRIED
PUNCH, drive pin, 18-in. point	2	1 in each M5 chest
SCREWDRIVER, common, 3-in. blade	2	" " " " "
WRENCH, combination, M2	2	" " " " "
WRENCH, engrs., dble-hd., alloy-S., $\frac{7}{16} \times \frac{1}{2}$	2	" " " " "
WRENCH, engrs., dble-hd., alloy-S., $\frac{5}{8} \times \frac{3}{4}$	2	" " " " "
WRENCH, engrs., dble-hd., alloy-S., $\frac{7}{8} \times 1$	2	" " " " "

29. GUN EQUIPMENT.

a. The following gun equipment consisting of ammunition, armament, and accessories are for the Half-track Personnel Carrier M5.

(1) AMMUNITION.

Cal. .30 (in boxes D44070 and belts C3951)	4,000 rounds	One 250-round belt in box in front floor well One 250-round belt in box on gun—balance in metal liner of shipping case behind right rear seats
Cal. .45	540 rounds	Under right rear seats
GRENADE, hand	22	Under front center seat
Chemical, A.T. (AW mixture), M1	2	
Fragmentation, Mk. II	2	
Offensive, Mk. III A2 (w/FUZE, detonating, HAND GRENADE M6A3)	10	
Smoke, AN-M8	2	
Incendiary, AN-M14	2	
CN-DM, irritant, M6	4	
MINE, A.T., M1A1, w/FUZE, M1A2	26	Outside in racks, left and right sides

TOOLS AND EQUIPMENT STOWAGE ON THE VEHICLE

(2) **ARMAMENT.**

ITEM	NUMBER CARRIED	WHERE CARRIED
GUN, machine, cal. .30, M1919A4 (flexible)	1	On Mount M35
GUN, submachine, cal. .45, Thompson, M1928A1	1	Above left gasoline tank, rear of driver's seat
RIFLE, M1	12	In brackets provided behind left and right rear seats

(3) **ACCESSORIES FOR CAL. .30 MACHINE GUN.**

BAG, empty cartridge, cal. .30	1	On gun
BELT, ammunition, 250 rounds	16	Under right rear seats
BOX, ammunition, M1	16	" " " "
BRUSH, chamber cleaning, M6	1	" " " "
BRUSH, cleaning, cal. .30, M2	3	" " " "
CAN, tubular (w/o contents)	1	" " " "
CASE, cleaning rod, M1	1	" " " "
CASE, cover group	1	" " " "
CASE, spare bolt, M2 (w/o contents)	3	" " " "
CHEST, steel, M5 (w/o contents)	1	" " " "
COVER, spare barrel	1	" " " "
COVER, tripod mount, M2	1	On tripod
COVER, tripod mount, over-all	1	Outside rear door on brackets
CRADLE, machine gun		
ENVELOPE, spare parts, M1 (w/o contents)	1	Under right rear seats
EXTRACTOR, ruptured cartridge, Mk. IV	1	" " " "
MOUNT, machine gun, cal. .30 or cal. .50, M35	1	On pedestal mount
MOUNT, tripod, cal. .30, M2	1	On outside of rear door
OILER, rectangular, 12-oz	1	Under rear right seats
REFLECTOR, barrel, cal. .30	1	" " " "
ROD, cleaning, jointed, cal. .30, M1	1	" " " "

BASIC HALF-TRACK VEHICLES (IHC) (PERSONNEL CARRIER M5, CAR M9A1, MULTIPLE GUN MOTOR CARRIAGE M14, AND SIMILAR IHC VEHICLES)

ITEM	NUMBER CARRIED	WHERE CARRIED
ROLL, spare parts, M3 (w/o contents)	1	Under right rear seats
ROLL, tool, M12 (w/o contents)	1	“ “ “ “
(4) ACCESSORIES FOR CAL. .45 SUBMACHINE GUN.		
BRUSH, chamber cleaning, M6	1	Under left rear seats
BRUSH, cleaning, cal. .45, M5	1	“ “ “ “
CASE, accessories and spare parts, M18 (w/o contents)	1	“ “ “ “
COVER, Thompson submachine gun	1	On gun or under left rear seats
ENVELOPE, fabric, one-button, 3 x 3 1/8	1	Under left rear seats
MAGAZINE, 30 rounds (clip) or MAGAZINE, 20 rounds (clip)	18	“ “ “ “
OILER, Thompson submachine gun	1	“ “ “ “
ROD, cleaning	1	“ “ “ “
SLING, gun, M1923 (webbing)	1	On gun
THONG	1	Under left rear seats

b. The following gun equipment consisting of ammunition, armament, and accessories are for the Half-track Car M9A1.

(1) AMMUNITION.

Cal. .30 (in boxes D44070 and belts C3951)	7,750 rounds	Two 250-round belts in two boxes at rear inside straps provided — one 250-round box behind right seat — one 250-round box on gun
Cal. .45	540 rounds	Clips and drums packet among bags
Cal. .50	700 rounds	One 100-round belt in box between front seats—one 100-round box behind seats under cal. .30 boxes —one 100-round box for gun

TOOLS AND EQUIPMENT STOWAGE ON THE VEHICLE

ITEM	NUMBER CARRIED	WHERE CARRIED
GRENADE, hand	10	In boxes between front seats
Chemical, A.T. (AW mixture), M1	2	
Fragmentation, Mk. II	2	
Offensive, Mk. III A2 (w/FUZE, detonating) Hand Grenade M6A3	2	
Smoke, AN-M8	2	
Incendiary, AN-M14	2	
MINE, A.T., w/FUZE, M1	14	Outside in racks, left and right sides
(2) ARMAMENT.		
GUN, machine, cal. .30, M1919A4 (flexible)	1	On Mount M35
GUN, machine, cal. .50, M2, heavy barrel (flexible)	1	On Mount M35
GUN, Thompson, submachine, cal. .45, M1928A1	1	Between left chest and mast
(3) ACCESSORIES FOR CAL. .30 MACHINE GUN.		
BAG, empty cartridge, cal. .30	1	On gun or under right rear seats
BELT, ammunition, 250 rounds	31	Under right rear seats
BOX, ammunition, M1	31	" " " "
BRUSH, chamber cleaning, M6	1	" " " "
BRUSH, cleaning, cal. .30, M2	3	" " " "
CAN, tubular (w/o contents)	1	Under right rear seats
CARRIAGE, machine gun, cal. .30 or cal. .50 (skate mount)	2	On machine gun track
CASE, cleaning rod, M1	1	Under right rear seats
CASE, cover group	1	" " " "
CASE, spare bolt, M2 (w/o contents)	3	" " " "
CHEST, steel, M5 (w/o contents)	1	" " " "
COVER, machine gun, cal. .30 (gun and skate mount)	1	On gun or under right rear seat
COVER, spare barrel	1	Under right rear seat

BASIC HALF-TRACK VEHICLES (IHC) (PERSONNEL CARRIER M5, CAR M9A1, MULTIPLE GUN MOTOR CARRIAGE M14, AND SIMILAR IHC VEHICLES)

ITEM	NUMBER CARRIED	WHERE CARRIED
COVER, tripod mount, M2	1	On tripod
COVER, tripod mount, over-all	1	Outside rear door with brackets
CRADLE, machine gun	1	On carriage
ENVELOPE, spare parts, M1 (w/o contents)	1	Under right rear seat
EXTRACTOR, ruptured cartridge Mk. IV	1	" " " "
MOUNT, tripod, machine gun, cal. .30, M2	1	Outside rear door on brackets provided
OILER, rectangular, 12 oz	1	Under right rear seat
REFLECTOR, barrel, cal. .30	1	" " " "
ROD, cleaning, jointed, cal. .30, M1	1	" " " "
ROLL, spare parts, M13 (w/o contents)	1	" " " "
ROLL, tool, M12 (w/o contents)	1	" " " "

(4) ACCESSORIES FOR CAL. .45 SUBMACHINE GUN.

BRUSH, chamber cleaning, M6	1	Under left rear seats
BRUSH, cleaning, cal. .45, M5	1	" " " "
CASE, accessories and spare parts, M1918 (w/o contents)	1	" " " "
COVER, Thompson submachine gun	1	On gun or under left rear seats
ENVELOPE, fabric, one-button, 3 x 3 1/8	1	Under left rear seats
MAGAZINE, 30 rounds (clip) or MAGAZINE, 20 rounds (clip)	18	On gun or under rear seats
OILER, Thompson submachine gun	1	Under left rear seats
ROD, cleaning	1	" " " "
SLING, gun, M1923 (webbing)	1	" " " "
THONG	1	" " " "

(5) ACCESSORIES FOR CAL. .50 MACHINE GUN.

BAG, metallic belt link	1	Under right rear seats
-------------------------	---	------------------------

TOOLS AND EQUIPMENT STOWAGE ON THE VEHICLE

ITEM	NUMBER CARRIED	WHERE CARRIED
BRUSH, cleaning, cal. .50, M4	4	Under right rear seats
CASE, cleaning rod, M15	1	“ “ “ “
CHEST, ammunition, cal. .50, M17	7	“ “ “ “
CHUTE, metallic belt link, M1	1	“ “ “ “
COVER, machine gun, cal. .50 (gun and skate mount)	1	On gun or under right rear seats
COVER, spare barrel, M13, 45-in.	1	Under right rear seats
COVER, tripod mount, M1	1	On tripod
ENVELOPE, spare parts, M1 (w/o contents)	2	Under right rear seats
EXTRACTOR, ruptured cartridge	1	“ “ “ “
MOUNT, machine gun, cal. .30 or cal. .50, M35	1	On machine gun track
MOUNT, tripod, machine gun, cal. .50, M3	1	Outside rear body in brackets provided
OILER, filling, oil buffer	1	Under right rear seats
ROD, cleaning, jointed, M7	1	“ “ “ “

c. The following gun equipment consisting of ammunition, armament, and accessories are for the Multiple Gun Motor Carriage M14.

(1) AMMUNITION.

Cal. .45	480 rounds	Left side fighting compartment
Cal. .50 packed as follows:	5,000 rounds	In fighting compartment
200-round boxes	10	
200-round belts	15	
GRENADE, hand	26	In box left side fighting compartment
Fragmentation, Mk. II	12	
Smoke, AN-M8	12	
Incendiary, AN-M14	2	
GRENADE, A.T., M9A1	10	Under radio shelf

(2) ARMAMENT.

ADAPTER, grenade, cal. .30, M1903, rifle	1	In grenade chest
---------------------------------------------	---	------------------

BASIC HALF-TRACK VEHICLES (IHC) (PERSONNEL CARRIER M5, CAR M9A1, MULTIPLE GUN MOTOR CARRIAGE M14, AND SIMILAR IHC VEHICLES)

ITEM	NUMBER CARRIED	WHERE CARRIED
CARBINE, cal. .30	3	2—right side fighting compartment 1—driver's compartment
GUN, machine, cal. .50, M2, heavy barrel (flex)	2	Gun Mount M33
GUN, Thompson, submachine, cal. .45, M1928A1	1	Left side fighting compartment
RIFLE, cal. .30, M1903	1	Driver's compartment

(3) ACCESSORIES FOR CAL. .45 SUBMACHINE GUN.

BRUSH, chamber cleaning, M6	1	Center floor well
BRUSH, cleaning, cal. .45, M5	1	“ “ “
CASE, accessories and spare parts, M1918 (w/o contents)	1	“ “ “
COVER, Thompson submachine gun	1	On gun
ENVELOPE, fabric, one-button, 3 x 3 1/8	1	Center floor well
MAGAZINE, 20 rounds (clip)	24	Container left side fighting compartment
OILER, Thompson submachine gun	1	Center floor well
ROD, cleaning	1	“ “ “
SLING, gun, M1923 (webbing)	1	“ “ “
THONG	1	“ “ “

(4) ACCESSORIES FOR CAL. .50 MACHINE GUN.

BRUSH, cleaning, cal. .50, M4	12	6—in each M5 Chest
CAN, tubular (w/o contents) for spare parts	2	1—in each M5 Chest
CASE, cleaning rod, M15	2	1 “ “ “ “
CHEST, ammunition, cal. .50, M2	10	In fighting compartment
CHEST, steel, M5 (w/o contents)	2	In driver's compartment under seat
ENVELOPE, spare parts, M1 (w/o contents)	4	2—in each M5 chest
GAGE, head space and timing, cal. .50, Browning machine gun	2	1—in each M5 chest

TOOLS AND EQUIPMENT STOWAGE ON THE VEHICLE

ITEM	NUMBER CARRIED	WHERE CARRIED
COVER, twin cal. .50 machine gun mount	1	On gun mount
CRANK, chest, ammunition, M2	3	Center floor well
OILER, rectangular, 12-oz	2	1—in each M5 chest
REFLECTOR, barrel, cal. .50	2	1 “ “ “ “
ROD, jointed, cleaning, M7	2	1 “ “ “ “
ROLL, spare parts, M14 (w/o contents)	2	1 “ “ “ “
ROLL, tool, M10 (w/o contents)	2	1 “ “ “ “

30. GUN SPARE PARTS.

a. The following gun spare parts are for the Half-track Personnel Carrier M5.

(1) SPARE PARTS FOR CAL. .30 MACHINE GUN.

BAND, lock, front barrel bearing	1	Under right rear seats
BAND, lock, front barrel bearing plug	1	“ “ “ “
BARREL	1	“ “ “ “
BOLT, group, consisting of:	1	Under right rear seats
BOLT, assembly, B147299	1	
EXTRACTOR, assembly, C64135	1	
LEVER, cocking, B131317	1	
PIN, cocking lever, A20567	1	
PIN, firing, assembly, C9186	1	
ROD, driving spring, assembly, B147222	1	
SEAR, C64137	1	
SPRING, driving, B212654	1	
SPRING, sear assembly, A131265	1	
COVER, group, consisting of:	1	Under right rear seats
COVER, assembly, C9801	1	
LEVER, feed belt, B17503	1	
PAWL, feed belt, C8461	1	
PIN, belt feed pawl, assembly, B131255	1	
PIVOT, belt feed lever, group assembly, B110529	1	

BASIC HALF-TRACK VEHICLES (IHC) (PERSONNEL CARRIER M5, CAR M9A1, MULTIPLE GUN MOTOR CARRIAGE M14, AND SIMILAR IHC VEHICLES)

ITEM	NUMBER CARRIED	WHERE CARRIED
SLIDE, feed belt, assembly, B131262	1	Under right rear seats
SPRING, belt feed pawl, B147224	1	
SPRING, cover extractor, B17513	1	
EXTENSION, barrel, group, consist- ing of:	1	Under right rear seats
EXTENSION, barrel, assembly, C64139	1	
LOCK, breech, B147214	1	
PIN, breech lock, assembly, B131253	1	
SPRING, locking barrel, B147230	1	
FRAME, lock, group, consisting of:	1	Under right rear seats
ACCELERATOR, C64142	1	
FRAME, lock, assembly, C9182	1	
PIN, accelerator, assembly, B131253	1	
PIN, trigger, A20503	1	
PLUNGER, barrel, assembly, B131251	1	
SPRING, barrel plunger, A135057	1	
SPRING, trigger pin, B147231	1	
TRIGGER, C8476	1	
LEVER, cocking	1	Under right rear seats
LEVER, feed belt	1	" " " "
PAWL, feed belt	1	" " " "
PAWL, holding belt	1	" " " "
PIN, accelerator, assembly	1	" " " "
PIN, belt holding pawl, split	1	" " " "
PIN, cocking lever	1	" " " "
PIN, firing, assembly	1	" " " "
PIN, trigger	1	" " " "
PLUG, front barrel bearing	1	" " " "
SPRING, belt holding pawl	1	" " " "

TOOLS AND EQUIPMENT STOWAGE ON THE VEHICLE

ITEM	NUMBER CARRIED	WHERE CARRIED
SPRING, locking barrel	1	Under right rear seats
SPRING, sear, assembly	1	“ “ “ “
TRIGGER	1	Under right rear seats

(2) SPARE PARTS FOR CAL. .45 SUBMACHINE GUN.

DISCONNECTOR, 6D	1	Under left rear seats
EJECTOR, 4B (M1928A1 only)	1	“ “ “ “
EJECTOR, assembly (M1 only)	1	“ “ “ “
EXTRACTOR, 15A	1	“ “ “ “
PIN, firing, 14A	1	“ “ “ “
ROCKER, 16D	1	“ “ “ “
SPRING, disconnecter, 9A	1	“ “ “ “
SPRING, firing pin, 14C	1	“ “ “ “
SPRING, magazine catch, 9D	1	“ “ “ “
SPRING, recoil, 17C	1	“ “ “ “
SPRING, sear, 9B	1	“ “ “ “

b. The following gun spare parts are for the Half-track Car M9A1.

(1) SPARE PARTS FOR CAL. .30 MACHINE GUN.

BAND, lock, front barrel bearing	1	Under right rear seats
BAND, lock, front barrel bearing plug	1	“ “ “ “
BARREL	1	“ “ “ “
BOLT, group, consisting of:	1	“ “ “ “
BOLT, assembly, B147299	1	
EXTRACTOR, assembly, C64135	1	
LEVER, cocking, B131317	1	
PIN, cocking lever, A20567	1	
PIN, firing, assembly, C9186	1	
ROD, driving spring, assembly, B147222	1	
SEAR, C64137	1	
SPRING, driving, B212654	1	
SPRING, sear assembly, A131265	1	

BASIC HALF-TRACK VEHICLES (IHC) (PERSONNEL CARRIER M5, CAR M9A1, MULTIPLE GUN MOTOR CARRIAGE M14, AND SIMILAR IHC VEHICLES)

ITEM	NUMBER CARRIED	WHERE CARRIED
COVER, group, consisting of:	1	Under right rear seats
COVER, assembly, C9801	1	
LEVER, feed belt, B17503	1	
PAWL, feed belt, C8461	1	
PIN, belt feed pawl, assembly, B131255	1	
PIVOT, belt feed lever, group assembly, B110529	1	
SLIDE, feed belt, assembly, B131262	1	
SPRING, cover extractor, B17513	1	
SPRING, belt feed pawl, B147224	1	
EXTENSION, barrel, group, consisting of:	1	Under right rear seats
EXTENSION, barrel, assembly, C64139	1	
LOCK, breech, B147214	1	
PIN, breech lock, assembly, B131253	1	
SPRING, locking barrel, B147230	1	
FRAME, lock, group, consisting of:	1	Under right rear seats
ACCELERATOR, C64142	1	
FRAME, lock, assembly, C9182	1	
PIN, accelerator, assembly, B131253	1	
PIN, trigger, A20503	1	
PLUNGER, barrel, assembly, B131251	1	
SPRING, barrel plunger, A135057	1	
SPRING, trigger pin, B147231	1	
TRIGGER, C8476	1	
LEVER, cocking	1	
LEVER, feed belt	1	
PAWL, feed belt	1	

TOOLS AND EQUIPMENT STOWAGE ON THE VEHICLE

ITEM	NUMBER CARRIED	WHERE CARRIED
PAWL, holding belt	1	Under right rear seats
PIN, accelerator, assembly	1	
PIN, belt holding pawl, split	1	
PIN, cocking lever	1	
PIN, firing, assembly	1	
PIN, trigger	1	
PLUG, front barrel bearing	1	
SPRING, belt holding pawl	1	
SPRING, locking barrel	1	
SPRING, sear, assembly	1	
TRIGGER	1	

(2) SPARE PARTS FOR CAL. .45 SUBMACHINE GUN.

DISCONNECTOR, 6D	1	Under left rear seats
EJECTOR, 4B (M1928A1 only)	1	" " " "
EJECTOR, assembly (M1 only)	1	" " " "
EXTRACTOR, 15A	1	" " " "
PIN, firing, 14A	1	" " " "
ROCKER, 16D	1	" " " "
SPRING, disconnecter, 9A	1	" " " "
SPRING, firing pin, 14C	1	" " " "
SPRING, magazine catch, 9D	1	" " " "
SPRING, recoil, 17C	1	" " " "
SPRING, sear, 9B	1	" " " "

(3) SPARE PARTS FOR CAL. .50 MACHINE GUN.

BARREL, assembly	1	Under right rear seats
DISK, buffer	1	" " " "
EXTENSION, firing pin assembly	1	" " " "
EXTRACTOR, assembly	1	" " " "
LEVER, cocking	1	" " " "
PIN, cotter, belt feed lever pivot stud	1	" " " "
PIN, cotter, cover pin	1	" " " "
PIN, cotter, switch pivot	2	" " " "

BASIC HALF-TRACK VEHICLES (IHC) (PERSONNEL CARRIER M5, CAR M9A1, MULTIPLE GUN MOTOR CARRIAGE M14, AND SIMILAR IHC VEHICLES)

ITEM	NUMBER CARRIED	WHERE CARRIED
PIN, firing	1	Under right rear seats
PLUNGER, belt feed lever	1	" " " "
ROD, driving spring, w/spring assembly	1	" " " "
SLIDE, belt feed group, consisting of:	1	" " " "
ARM, belt feed pawl B8914	1	
PAWL, feed belt, assembly, B8961	1	
PIN, belt feed pawl, assembly, B8962	1	
SLIDE, belt feed, assembly, B261110	1	
SPRING, belt feed pawl, A9351	1	
SLIDE, sear	1	Under right rear seats
SPRING, belt feed lever plunger	1	" " " "
SPRING, belt holding pawl	1	" " " "
SPRING, cover extractor	1	" " " "
SPRING, locking barrel	1	" " " "
SPRING, sear	1	" " " "
STUD, bolt	1	" " " "

c. The following gun spare parts are for the Multiple Gun Motor Carriage M14.

(1) SPARE PARTS FOR CAL. .45 SUBMACHINE GUN.

DISCONNECTOR, 6D	1	Center floor well
EJECTOR, 4B (M1928A1 only)	1	" " "
EJECTOR, assembly (M1 only)	1	" " "
EXTRACTOR, 15A	1	" " "
PIN, firing, 14A	1	" " "
ROCKER, 16D	1	" " "
SPRING, disconnecter, 9A	1	" " "
SPRING, firing pin, 14C	1	" " "
SPRING, magazine catch, 9D	1	" " "

TOOLS AND EQUIPMENT STOWAGE ON THE VEHICLE

TOOL	NUMBER CARRIED	WHERE CARRIED
SPRING, recoil, 17C	1	Center floor well
SPRING, sear, 9B	1	“ “ “
(2) SPARE PARTS FOR CAL. .50 MACHINE GUN.		
ACCELERATOR	2	1—in each M5 Chest
ARM, belt feed pawl	2	1 “ “ “ “
BAR, trigger	2	1 “ “ “ “
BARREL, assembly	4	In fighting compartment
COLLAR, driving spring rod	2	1—in each M5 Chest
DISK, buffer	4	2—in each M5 Chest
EJECTOR	2	1—in each M5 Chest
EXTENSION, firing pin, assembly	4	2—in each M5 Chest
EXTRACTOR, assembly	4	2 “ “ “ “
LEVER, cocking	2	1—in each M5 Chest
LEVER, feed belt	2	1 “ “ “ “
LOCK, spring, oil buffer body	2	1—in each M5 Chest
NUT, $\frac{3}{8}$ —16NC-2	2	1 “ “ “ “
PAWL, feed belt, assembly	2	1 “ “ “ “
PAWL, holding, belt	2	1 “ “ “ “
PIN, accelerator, assembly	2	1 “ “ “ “
PIN, belt holding pawl, assembly	4	2—in each M5 Chest
PIN, breech lock, assembly	2	1—in each M5 Chest
PIN, cocking lever	2	1—in each M5 Chest
PIN, cotter, split, S., $\frac{1}{16}$ x $\frac{3}{4}$	10	5—in each M5 Chest
PIN, cotter, split, S., $\frac{1}{16}$ x 1	10	5 “ “ “ “
PIN, cotter, split, S., $\frac{3}{32}$ x $\frac{3}{4}$	6	3—in each M5 Chest
PIN, cotter, split, S., $\frac{1}{8}$ x $\frac{7}{8}$	4	2—in each M5 Chest
PIN, firing	4	2 “ “ “ “
PIN, stop, driving spring rod collar	2	1—in each M5 Chest
PIN, trigger bar, assembly	2	1 “ “ “ “
PLUNGER, belt feed lever	4	2—in each M5 Chest
ROD, driving spring, w/spring, assembly	4	2 “ “ “ “

BASIC HALF-TRACK VEHICLES (IHC) (PERSONNEL CARRIER M5, CAR M9A1, MULTIPLE GUN MOTOR CARRIAGE M14, AND SIMILAR IHC VEHICLES)

TOOL	NUMBER CARRIED	WHERE CARRIED
SCREW	2	1—in each M5 Chest
SCREW, cap, hex-hd.	2	1—“ “ “ “
SCREW, filler, oil buffer tube	2	1—“ “ “ “
SCREW, retracting slide bracket, front	4	2—in each M5 Chest
SCREW, retracting slide bracket, rear	8	4—in each M5 Chest
SEAR	2	1—in each M5 Chest
SLIDE, sear	4	2—in each M5 Chest
SPRING, belt feed lever plunger	2	1—in each M5 Chest
SPRING, belt feed pawl	4	2—in each M5 Chest
SPRING, belt holding pawl	4	2 “ “ “ “
SPRING, cover extractor	4	2 “ “ “ “
SPRING, ejector	2	1—in each M5 Chest
SPRING, locking barrel	4	2—in each M5 Chest
SPRING, oil buffer	2	1—in each M5 Chest
SPRING, retracting slide lever, R.H.	2	1 “ “ “ “
SPRING, sear	4	2—in each M5 Chest
SPRING, side plate trigger	2	1—in each M5 Chest
SPRING, side plate trigger slide	2	1 “ “ “ “
STOP, sear assembly	2	1 “ “ “ “
STUD, bolt	4	2—in each M5 Chest
WASHER, lock, $\frac{3}{8}$	2	1—in each M5 Chest
WASHER, lock, shakeproof, reg. $\frac{1}{4}$	2	1 “ “ “ “
WASHER, lock, shakeproof, reg. $\frac{3}{8}$	2	1—in each M5 Chest

Section VII

OPERATION UNDER UNUSUAL CONDITIONS

	Paragraph
Subzero operation	31
Fuels for low temperatures.....	32
Lubrication of vehicles.....	33
Preparation of vehicles.....	34
Cold weather accessories.....	35
High temperature operation.....	36
Sandy and desert terrain.....	37
Desert operation maintenance.....	38
Desert operation special equipment.....	39
Desert driving	40

31. SUBZERO OPERATION.

a. Operation of automotive equipment at subzero temperatures presents problems that demand special precautions and extra careful servicing both from operation and maintenance personnel if poor performance and total functional failure are to be avoided. Automotive equipment can be operated efficiently at low temperatures if this care is accorded.

b. Extreme care must be exercised whenever a vehicle or parts are moved from a warm place into subzero temperatures as moisture will immediately condense on all surfaces and freeze.

c. "Low temperatures" have been divided into 2 ranges: -10 F to -30 F, and below -30 F. Engine and lubricants undergo changes in physical properties below -30 F. In many cases, accessories and equipment for supplying heat to engine, fuel, and intake air are required.

32. FUELS FOR LOW TEMPERATURES.

a. Gasoline.

(1) Winter grade of gasoline is designed to reduce cold weather starting difficulties; therefore the winter grade of motor fuels procured under U. S. Army Specification 2-103, latest issue, must be used in the engine of this vehicle.

(2) **STORAGE AND HANDLING.** Due to condensation of moisture in the air, water will accumulate in tanks, drums, and containers. At low temperatures, this water will form ice crystals that will clog fuel lines and carburetor jets unless the following precautions are taken:

BASIC HALF-TRACK VEHICLES (IHC) (PERSONNEL CARRIER M5, CAR M9A1, MULTIPLE GUN MOTOR CARRIAGE M14, AND SIMILAR IHC VEHICLES)

(a) Strain the fuel through a chamois skin or any other type of strainer that will prevent the passage of water. **CAUTION:** Gasoline flowing over a surface generates static electricity that will result in a spark unless means are provided to ground the electricity. A metallic contact between the container and the tank must be provided to assure an effective ground.

(b) Keep tanks full, if possible. The more fuel there is in the tank, the smaller will be the volume of air from which the moisture can be condensed.

(c) Be sure that all containers are thoroughly clean and free from rust before storing fuel in them.

(d) If possible, after filling or moving a container, allow the fuel to settle before filling the vehicle tank from it.

(e) Keep all closures of containers tight to prevent snow, ice, dirt, and other foreign matter from entering.

(f) Never pump gasoline drums dry; allow about four inches of fuel to remain.

(g) Add one-half pint of denatured alcohol to a tank of gasoline to absorb moisture that might condense.

33. LUBRICATION OF VEHICLES.

a. Lubrication of automotive equipment at temperatures above 0 F is covered in section V as outlined in War Department Lubrication Guides and Ordnance Field Service Bulletins. Subzero temperatures affect both metals and lubricants; therefore, special attention must be given the lubrication and servicing of equipment when such temperatures are encountered. One of the following measures must be taken according to facilities available:

(1) Keep vehicle in heated enclosure, if possible, when it is not being operated.

(2) When the engine is stopped, drain the crankcase oil while it is still warm and store it in a warm place until vehicle is to be operated again. If a warm place is not available, heat the oil before putting it in the crankcase. (Do not get the oil too hot. Heat only to a point where the bare hand can be inserted without burning.) *Place a tag in a conspicuous place in the cab to warn personnel that the crankcase is empty.*

(3) Cover the engine with a tarpaulin. About three hours before the engine is to be started, place fire pots under the tarpaulin. A Van Prag, Primus type, or other types of blow torches or kerosene lanterns may

OPERATION UNDER UNUSUAL CONDITIONS

be used. With due consideration for fire hazards involved, the flame may be applied direct to the oil pan.

(4) Dilute crankcase oil with gasoline. The table below shows the quantities of diluent to be added to the oil prescribed on the lubrication guides for use at -10 F. The quantities of diluents will form mixtures for satisfactory starting at temperatures indicated.

	-10 F to -30 F	Below -30F
Gasoline	1/2 qt to each 4 1/2 qt of engine oil	1 qt to each 5 qt of engine oil

(a) When the crankcase oil is first diluted, turn the engine over several times to mix oil and diluent thoroughly.

(b) Check oil level frequently.

h. Lubricants. The lubricants recommended for use in this vehicle for subzero temperatures will be found outlined in special field service bulletin OFSB 6-11 and OFSB 6-5.

34. PREPARATION OF VEHICLES.

a. Cooling System. ETHYLENE GLYCOL is prescribed as an antifreeze solution and instructions outlined in paragraph 82 pertinent to antifreeze apply.

b. Electrical System.

(1) **GENERATOR.** See that the brushes and commutators are clean and making good contact (par. 88).

(2) **WIRING.** Check and clean all connections, especially the battery terminals. Care should be taken to make certain that no short circuits are present and all connections are tight (par. 85).

(3) **COIL.** Check coil for proper functioning. Inspect, clean, replace or tighten all terminals and connections in high tension circuit (par. 90).

(4) **DISTRIBUTOR.** Clean distributor thoroughly and clean or replace contact points. Check the points frequently. In cold weather, slightly pitted points can prevent the engine from starting (par. 91).

(5) **SPARK PLUGS.** Clean, test, and replace if necessary. If it is difficult to make the engine fire, reduce the gap to 0.023 inch to 0.027 inch. This will make ignition more effective at the reduced voltages likely to prevail (par. 92).

(6) **TIMING.** Check carefully. Care should be taken that the spark is not unduly advanced or retarded (par. 94).

BASIC HALF-TRACK VEHICLES (IHC) (PERSONNEL CARRIER M5, CAR M9A1, MULTIPLE GUN MOTOR CARRIAGE M14, AND SIMILAR IHC VEHICLES)

(7) **BATTERY.** The efficiency of a battery decreases sharply with decreasing temperatures and becomes practically nil at minus 40 F. Do not try to start the engine with the battery when it has been chilled to temperatures below minus 30 F until the battery has been heated. See that the battery is always fully charged with the hydrometer readings between 1.275 and 1.300. A fully charged battery will not freeze at temperatures likely to be encountered even in Arctic climates, but a discharged battery will freeze at relatively higher temperatures (par. 86). Do not add water to battery when it has been exposed to subzero temperatures unless the battery is to be charged immediately afterward. If water is added and the battery is not put on charge, the layer of water will stay on top and freeze before it gets a chance to mix with the electrolyte (par. 86).

(8) **LIGHTS AND IGNITION.** Inspect the lights carefully. Check for short circuits and presence of moisture around the sockets. Before every start, see that the spark plugs, wiring, and other electrical equipment are free from ice.

(9) **STARTING MOTOR.** See that brushes and commutator are clean and making good contact. Be sure that no heavy grease or dirt has been left on the starter throw-out mechanism. Heavy grease or dirt may keep the gears from being meshed or cause them to remain in mesh after the engine starts running. The latter will ruin the starter and necessitate repairs (par. 87).

(10) **CHOKE CONTROL.** A full choke is necessary to secure the air-fuel ratio required for cold weather starting. Check the butterfly valve to see that it closes all the way and otherwise functions properly (par. 130).

(11) **CARBURETOR.** Carburetors which give no appreciable trouble at normal temperatures may not operate satisfactorily at low temperatures. Adjust carburetor and exhaust manifold heat control valve (par. 130).

(12) **FUEL PUMP.** A fuel pump which will deliver enough gasoline at normal starter speeds may have leaky valves or a diaphragm which will prevent it from delivering a sufficient amount of fuel at reduced temperatures to produce sufficient vapor to fire the engine at reduced engine revolutions per minute. Remove, empty, and clean fuel pump bowl (par. 128).

(13) **AIR CLEANERS.** At temperatures below 0 F do not use oil in air cleaners. The oil will congeal and prevent easy flow of air. Wash the filtering element in SOLVENT, dry-cleaning, dry, and replace. Ice and frost formations on the air cleaner filtering element may cause an abnormally high intake vacuum in the carburetor air horn. Below -30 F, remove the air cleaner (par. 131).

OPERATION UNDER UNUSUAL CONDITIONS

(14) **FUEL FILTER.** Remove and clean sediment bowl and strainer daily (par. 129).

(15) **OIL FILTERS.** Remove or bypass oil filters at temperatures below —30 F.

(16) **BRAKES.** Park the vehicle with brakes released in order to prevent binding of the brakes. Block wheels or otherwise prevent movement of the vehicle.

(17) **SPEEDOMETER CABLE.** Disconnect oil-lubricated speedometer cable at drive end when operating at temperatures of —30 F and below (par. 148).

(18) Retune engine frequently.

(19) Before starting the engine, pull the choke all the way out and leave it partially pulled out until the engine has warmed up. Turn the engine as rapidly as possible with the starter and release starting pedal as soon as the engine fires. After the engine has started, idle it until it has warmed up sufficiently to run smoothly. Do not race the engine immediately after starting (par. 6).

(20) To stop the engine, first increase the engine speed; then turn off the ignition and release the throttle at the same time.

35. COLD WEATHER ACCESSORIES.

a. The following list of cold weather accessories may be employed at the discretion of officers in charge of the materiel:

(1) Tarpaulins, tents, or collapsible sheds are useful for covering vehicles, particularly the engines.

(2) Fire pots, Primus type, or Van Prag blowtorches, ordinary blowtorches, oil stoves, or kerosene lanterns can be used for heating vehicles.

(3) Extra batteries and facilities for changing batteries quickly are aids in starting.

(4) Steel drum and suitable metal stands are useful for heating crankcase oil.

(5) Insulation of the fuel line will help prevent ice formation inside the line.

(6) Small quantities of denatured alcohol, about one-half pint to a tank of fuel, will reduce difficulties resulting from water in gasoline.

(7) Radiator covers can be improvised locally and help to keep the engine running at normal temperatures.

36. HIGH TEMPERATURE OPERATION.

a. To prevent overheating, the following units should be checked:

(1) The cooling system should be kept clean and full (par. 75).

BASIC HALF-TRACK VEHICLES (IHC) (PERSONNEL CARRIER M5, CAR M9A1, MULTIPLE GUN MOTOR CARRIAGE M14, AND SIMILAR IHC VEHICLES)

(2) The fins in the radiator should be kept free from bugs and foreign material that might affect free circulation of air.

(3) The fan belt should be properly adjusted (par. 79).

(4) A gear reduction which requires the engine to labor at low engine speeds should not be used, if practical, as this will cause overheating due to lack of sufficient water and air circulation.

(5) Under severe conditions it may be advisable to remove the hood side panels, providing less restriction to the flow of air.

(6) Watch the temperature indicator; and if the needle goes in the red band, stop the engine and investigate the cause. The vehicle should be headed into the wind, if possible, and permitted to cool.

b. Vapor Locks. Vapor locks are frequent. The fuel lines and fuel pump should be located away from areas of great heat and should not be screened from the air circulated by the fan. If vapor locks occur, it may be necessary to insulate fuel lines and fuel pumps which cannot be relocated.

37. SANDY AND DESERT TERRAIN.

a. Air Filters and Protective Covers.

(1) There is always some sand in the air in the desert, more is stirred up by the passage of vehicles, and during a sandstorm the amount may be such as to prohibit movement. Without adequate protective measures the sand will choke carburetors, plug feed lines, score the cylinders, damage the distributor, and increase the wear on all bearings. The oil bath air filter will protect the engine if it is kept clean. Constant, close supervision and daily inspection of air filters are the only ways of insuring that sand will not get into the engine. The crankcase breather opening should be equipped with an effective air cleaner. Air cleaners should be also provided for any other device using an air intake, such as a vacuum booster or engine driven compressor. Air cleaners should be located where the air stream will have the least dirt pollution.

(2) Sand will enter the crankcase and fuel lines when replenishing the oil or refueling unless great care is used during these operations. The driver should wipe all sand off the caps before removing and off the spouts of oil and gasoline containers before they are used. It may be necessary to make canvas boots to protect front wheel joints and distributors. Sand and dust will cause failure of instruments in panel if these are not carefully sealed. Scotch tape may be used for this purpose.

OPERATION UNDER UNUSUAL CONDITIONS

38. DESERT OPERATION MAINTENANCE.

a. Tires.

(1) Operations in the desert will require movement over all types of terrain. Tires must be suitable for every type of surface which will be encountered. Most difficulty will be met in sand. Air pressure must be varied to suit the type of ground surface. Over sand or soft powdered clay, the ground pressure per square inch should be reduced to the minimum. By deflating the tires the area in contact with the ground is increased and the tire fits itself to the irregularities of the sand without breaking through the crust. The minimum pressure must be determined by test for each type of vehicle. Tires on flat-base rims will spin on the rims if pressure is too low.

(2) In rocky or boulder-strewn ground, tires must be as fully inflated as the age and condition of the vehicle permit. At low pressure the innermost layer of canvas will be broken by the violent inward bending when a sharp rock is struck. The resulting chafing will wear out the inner tube even though no danger is apparent from the outside of the tire. Since a normal day's march will take a vehicle over different kinds of ground, strict tire discipline is necessary.

b. Electrical Difficulties. The constant shock and vibration caused by the passage over rough ground frequently causes cable clips to shake loose and cables are broken or shorted. Frequent inspection of cable clips should be made and spring washers inserted under the nuts if possible. Voltage control units may cause trouble because of breaking of wire in shunt-winding or sticking of regulator points. Drivers should watch the ammeter as carefully as any other instrument since overcharging, even when not sufficient to buckle the plates, always results in loss of battery water, most difficult to obtain in the desert. The high salinity of water issued for drinking and for radiators forbids its use in batteries.

c. Loading. The vehicle must be carefully loaded. Excessive breaking of springs has been a constant source of trouble in the vehicles used in the desert. The rough going is very hard on springs and they are quickly broken by overloading, improper distribution of load, or shifting of load while moving.

39. DESERT OPERATION SPECIAL EQUIPMENT.

a. To extricate the vehicle from soft sand, the driving wheels must be given a firm surface. For vehicles with single tires on driving wheels, an excellent solution is the provision of a pair of steel channels 4 or 5 feet long. In cross section the channels should have a curved bottom

BASIC HALF-TRACK VEHICLES (IHC) (PERSONNEL CARRIER M5, CAR M9A1, MULTIPLE GUN MOTOR CARRIAGE M14, AND SIMILAR IHC VEHICLES)

wide enough to take the whole width of the tire at low pressure. It should be bent up sharply at the sides to prevent the tires running off, and then down again to form a rounded flange on each side to strengthen the channel. Two angle irons projecting from the underside and holes punched in the bottom will prevent the channel from slipping under driving thrust. Mats should be used to form a roadway for front wheels. Canvas strips, stiffened by lateral rungs of steel sewn between two thicknesses of canvas, are excellent for this purpose. Such mats can be rolled up for transport and rolled out in front of each front wheel when needed.

b. If dual wheels are used on the vehicle, a single round wooden spar may be used instead of channels. The spar should be placed between the tires and used as a rail.

40. DESERT DRIVING.

a. The driver should not attempt to get out of the sand by means of his engine, the instant the vehicle has broken through the crust and ceased to move. Otherwise, the driving wheels will merely sink deeper into the sand and extrication will be made more difficult.

b. If the vehicle breaks through the crust and becomes stuck, adequate excavations must be made in front (or, if backing out, in rear) of the wheels so that the near ends of the channels or mats are on a level with the bottom of the tire thread, and so that the slope of the channels is not too steep. If this is not done, the engine will be unable to set the vehicle in motion up the initial slope to enable the wheels to begin to drive against the firm surface of the extricating equipment. Once in motion, the vehicle should be driven to firm ground or stopped heading down a slope to avoid getting stuck again after the channels have been loaded on.

c. To avoid breaking through the crust when starting, vehicles should always halt, when possible, on hard ground or heading down a slope.

PART TWO – Vehicle Maintenance Instructions

Section VIII

MAINTENANCE ALLOCATION

	Paragraph
Scope	41
Definition of terms.....	42
Maintenance allocation	43
Trouble shooting	44

41. SCOPE.

a. The scope of maintenance and repair by the crew and other units of the using arms is determined by the availability of suitable tools, availability of necessary parts, capabilities of the mechanics, time available, and the tactical situation. All of these are variable and no exact system of procedure can be described.

b. Indicated in the following paragraphs are the maintenance duties for which tools and parts have been provided for the using arm personnel. Other replacements and repairs are the responsibility of ordnance maintenance personnel but may be performed by using arm personnel when circumstances permit, within the discretion of the commander concerned.

42. DEFINITION OF TERMS. Echelons and words as used in this list of maintenance allocations are defined as follows:

SECOND ECHELON: Line organization regiments, battalions, companies, detachments, and separate companies (first and second echelons).

THIRD ECHELON: Ordnance light maintenance companies, ordnance medium maintenance companies, ordnance divisional maintenance battalions, and post ordnance shops.

FOURTH ECHELON: Ordnance heavy maintenance companies and service command shops.

FIFTH ECHELON: Ordnance base regiments, ordnance bases, arsenals, and manufacturers' plants.

BASIC HALF-TRACK VEHICLES (IHC) (PERSONNEL CARRIER M5, CAR M9A1, MULTIPLE GUN MOTOR CARRIAGE M14, AND SIMILAR IHC VEHICLES)

SERVICE: Consists of servicing, cleaning, lubricating, tightening bolts and nuts, and making external adjustments of subassemblies or assemblies and controls. (Including preventive maintenance) (par. 23 a (1) and (2), AR 850-15 (10-6-42))

REPLACE: Consists of removing the part, subassembly or assembly from the vehicle and replacing it with a new or reconditioned or rebuilt part, subassembly or assembly, whichever the case may be. (par. 23 a (4), AR 850-15 (10-6-42))

REPAIR: Consists of making repairs to, or replacement of, the part, subassembly or assembly that can be accomplished without completely disassembling the subassembly or assembly, and does not require heavy welding, riveting, machining, fitting, and/or alining or balancing. (par. 23 a (3) and (5), in part, AR 850-15 (10-6-42))

REBUILD: Consists of completely reconditioning and replacing in serviceable condition any unserviceable part, subassembly or assembly of the vehicle, including welding, riveting, machining, fitting, alining, balancing, assembling, and testing. (par. 23 a (5), in part, and (6), AR 850-15 (10-6-42))

43. MAINTENANCE ALLOCATION.

NOTE: Operations allocated will normally be performed in the echelon indicated by "X." Operations allocated to the echelons as indicated by "E" may be accomplished by the respective echelons in emergencies only.

	ECHELONS			
	2nd	3rd	4th	5th
AXLES, FRONT				
Arms, steering—replace (par. 49).....				X
*Axle, front assembly—replace (par. 49).....		X		
Axle, front assembly—repair.....		X		
Axle, front assembly—rebuild.....			E	X
Bearing, wheel—adjust and replace (par. 152).....		X		

*The second echelon is authorized to remove and reinstall items marked by an asterisk. However, when it is necessary to replace an item marked by an asterisk with a new or rebuilt part, subassembly or unit assembly, the assembly marked by an asterisk may be removed from the vehicle by the second echelon only after authority has been obtained from a higher echelon of maintenance.

MAINTENANCE ALLOCATION

	ECHELONS			
	2nd	3rd	4th	5th
AXLES, FRONT (CONT'D)				
Carrier, differential, w/ring gear and pinion assembly— replace and repair.....		X		
Carrier, differential, w/ring gear and pinion assembly— rebuild			E	X
Grease retainers, wheel—replace (par. 152).....	X			
Shaft, axle—replace		X		
Wheel turning stop—adjust and replace.....		X		
Wheel alinement, camber and caster—adjust.....			E	X
Wheel alinement, toe-in—adjust (par. 48).....	X			
AXLE, REAR (JACKSHAFT)				
*Axle, rear assembly—replace (par. 53).....		X		
Axle, rear assembly—repair.....		X		
Axle, rear assembly—rebuild.....			E	X
Carrier, differential, w/ring gear and pinion assembly— replace and repair.....		X		
Carrier, differential, w/ring gear and pinion assembly— rebuild			E	X
Shaft, axle—replace (par. 53).....	X			
Sprocket and hub assembly, w/drum—replace (par. 53) ..	X			
Sprocket and hub assembly, w/drum—repair.....		X		
Sprocket and hub assembly, w/drum—rebuild.....			E	X
BODY				
Body—replace and repair.....		X		
Body—rebuild			E	X
Body, armor plate—replace.....		X		
Body, floors, hood and doors—replace.....	X			
Seat assemblies—replace (par. 3).....	X			
Seat assemblies—repair		X		
Seat assemblies—cushion and back rest—rebuild.....			X	

*The second echelon is authorized to remove and reinstall items marked by an asterisk. However, when it is necessary to replace an item marked by an asterisk with a new or rebuilt part, subassembly or unit assembly, the assembly marked by an asterisk may be removed from the vehicle by the second echelon only after authority has been obtained from a higher echelon of maintenance.

BASIC HALF-TRACK VEHICLES (IHC) (PERSONNEL CARRIER M5, CAR M9A1, MULTIPLE GUN MOTOR CARRIAGE M14, AND SIMILAR IHC VEHICLES)

	ECHELONS			
	2nd	3rd	4th	5th
Windshield—replace (par. 3).....	X			
Windshield—repair		X		
Windshield—rebuild			E	X
Wipers, windshield—replace	X			
Wipers, windshield—rebuild			X	

BRAKE GROUP

Cleaner, air (Hydrovac)—service and replace (par. 62)	X			
Cylinder assembly, brake booster (Hydrovac)—replace (par. 62).....	X			
Cylinder assembly, brake booster (Hydrovac)—repair		X		
Cylinder assembly, brake booster (Hydrovac)—rebuild		E	X	
Cylinder assembly, brake master—replace (par. 61).....	X			
Cylinder assembly, brake master—repair.....		X		
Cylinder assembly, brake master—rebuild.....			X	
Cylinder assembly, brake wheel, front and rear—replace	X			
Cylinder assembly, brake wheel, front and rear—repair		X		
Cylinder assembly, brake wheel, front and rear—rebuild		E	X	
Hose, brake, and lines—replace.....	X			
Lines and fittings, brake—repair.....		X		
Shoe, brake, front and rear—adjust (par. 65).....	X			
Shoe, brake—replace (par. 63).....	X			
Shoe, brake—repair, reline.....		X		
Shoe, brake—rebuild			X	

BRAKE GROUP (HAND OR EMERGENCY)

Linkage and lever (hand brake)—adjust and replace (par. 67)	X			
-------------------------------------------------------------------	---	--	--	--

MAINTENANCE ALLOCATION

	ECHELONS			
	2nd	3rd	4th	5th
BRAKE GROUP (HAND OR EMERGENCY) (CONT'D)				
Linkage and lever (hand brake)—repair.....		X		
Shoe, hand brake assembly—replace (par. 67).....	X			
Shoe, hand brake assembly—reline.....			X	
CLUTCH GROUP				
Clutch assembly—replace (par. 73).....	E	X		
Clutch assembly—repair.....		X		
Clutch assembly—rebuild.....			E	X
Housing, clutch—replace.....	E	X		
Housing, clutch—repair.....				X
Pedal and linkage, clutch—service and replace (par. 72).....		X		
ELECTRICAL SYSTEM				
Battery, charge and service—replace (par. 86).....	X			
Battery—repair.....		X		
Battery—rebuild.....			E	X
Box, apparatus assembly (generator control)—replace (par. 89).....	X			
Box, apparatus assembly (generator control)— adjust and repair.....			X	
Box, apparatus assembly (generator control)— rebuild.....				X
Control, load, electric brake (dash mount)— replace (par. 132).....	X			
Control, load, electric brake (dash mount)— repair.....			X	
Controller, electric brake (chassis mount)— replace (par. 101).....	X			
Controller, electric brake (chassis mount)—repair.....		X		
Horns—service and replace.....	X			
Horns—repair.....		X		
Lamps—service and replace.....	X			
Lamps—repair.....		X		
Switches, lighting and starting—replace (par. 132).....	X			
Switches, lighting and starting—repair.....		X		

BASIC HALF-TRACK VEHICLES (IHC) (PERSONNEL CARRIER M5, CAR M9A1, MULTIPLE GUN MOTOR CARRIAGE M14, AND SIMILAR IHC VEHICLES)

	ECHELONS			
	2nd	3rd	4th	5th
ENGINE COOLING SYSTEM				
Hose and pipes—replace.....	X			
Radiator—clean and flush (par. 82).....	X			
Radiator—replace (par. 76).....	X			
Radiator—repair		X		
Radiator—rebuild			E	X
Tanks, surge—replace (par. 81).....	X			
Tanks, surge—repair		X		

ENGINE AND ENGINE COMPONENTS

Balancer assembly, harmonic—replace.....		X		
Bearings, connecting rod—replace.....		E	E	X
Bearings, crankshaft—replace		E	E	X
Belt, fan—adjust or replace (par. 79).....	X			
Breather and ventilator—service and repair (par. 116)	X			
Carburetor, w/governor—replace (par. 130).....	X			
Carburetor, w/governor—repair		X		
Carburetor, w/governor—rebuild			X	
Cooler, oil—replace and repair.....		X		
Cooler, oil—rebuild			E	X
Cover, timing gears—replace.....		X		
Cover, valves—replace (par. 111).....	X			
Crankshaft—rebuild (recondition)			E	X
Cylinder sleeve—replace		E	E	X
*Engine assembly—replace (par. 118).....		X		
Engine assembly—repair		X		
Engine assembly—rebuild			E	X
Fan blade assembly—replace (par. 77).....	X			

*The second echelon is authorized to remove and reinstall items marked by an asterisk. However, when it is necessary to replace an item marked by an asterisk with a new or rebuilt part, subassembly or unit assembly, the assembly marked by an asterisk may be removed from the vehicle by the second echelon *only after authority has been obtained from a higher echelon of maintenance.*

MAINTENANCE ALLOCATION

ENGINE AND ENGINE COMPONENTS (CONT'D)	ECHELONS			
	2nd	3rd	4th	5th
Filter, oil—service and repair (par. 22).....	X			
Flywheel—replace			E	X
Flywheel—rebuild (recondition)			E	X
Gaskets, cylinder head, manifold and oil pan—replace (pars. 107, 109, and 115).....	X			
Gears, timing—replace		X		
Generator, assembly—replace (par. 88).....	X			
Generator assembly—repair		X		
Generator assembly—rebuild			X	
Head, cylinder—replace (par. 107).....	E	X		
Lifters and valve lifter guides—replace.....			E	X
Manifolds—replace (par. 109).....	X			
Manifolds—repair		X		
Motor, starting assembly—replace (par. 87).....	X			
Motor, starting assembly—repair		X		
Motor, starting assembly—rebuild.....			X	
Pan, oil—replace (par. 115).....	E	X		
Pan, oil—remove and clean (par. 115).....	X			
Piston assembly, w/pins and rings—replace.....		E	E	X
Pump, fuel—replace (par. 128)	X			
Pump, fuel—repair		X		
Pump, fuel—rebuild			X	
Pump, oil—replace (par. 110).....	E	X		
Pump, oil—repair		E	X	
Pump, oil—rebuild			E	X
Pump, water—replace (par. 78).....	X			
Pump, water—repair		X		
Pump, water—rebuild			X	
Rocker arm and tappet assembly—service and replace....	X			
Rocker arm and tappet assembly—repair.....		X		
Rods, connecting—replace		E	E	X
Springs, valve—replace (par. 111).....	E	X		

BASIC HALF-TRACK VEHICLES (IHC) (PERSONNEL CARRIER M5, CAR M9A1, MULTIPLE GUN MOTOR CARRIAGE M14, AND SIMILAR IHC VEHICLES)

	ECHELONS			
	2nd	3rd	4th	5th
ENGINE AND ENGINE COMPONENTS (CONT'D)				
Strainer, oil—clean or replace (par. 110).....	E	X		
Thermostat—replace (par. 80).....	X			
Tune-up, engine.....	X			
Valves, clean carbon (par. 113).....	X			
Valves—replace, reface, and reseat.....		E	E	X
EXHAUST SYSTEM				
Mufflers and exhaust pipes—replace (par. 121).....	X			
FRAME				
Frame—repair.....		E	X	
Frame—replace and rebuild.....			E	X
FUEL SYSTEM				
Cleaner, air—clean or replace (par. 131).....	X			
Pipes and connections, fuel—replace.....	X			
Pipes and connections, fuel—repair.....	X			
Tank, fuel—clean or replace (par. 127).....	X			
Tank, fuel—repair.....		X		
Coil, ignition—replace (par. 90).....	X			
Condenser, ignition—replace (par. 91).....	X			
Condenser and filter—replace (primary circuit).....	X			
Distributor assembly—replace (par. 91).....	X			
Distributor assembly—repair.....		X		
Distributor assembly—rebuild.....			X	
Points, breaker—replace (par. 91).....	X			
Points, breaker—service (par. 91).....	X			
Spark plugs—replace (par. 92).....	X			
Spark plugs—repair.....		X		
Wiring, ignition assembly—replace and repair.....	X			

MAINTENANCE ALLOCATION

	Echelons			
	2nd	3rd	4th	5th
INSTRUMENTS AND GAGES				
Panel instrument (with instruments, gages, and warning lights)—replace (par. 132).....	X			
Panel instrument (with instruments, gages, and warning lights)—repair		X		
Panel instrument (with instruments, gages, and warning lights)—rebuild			E	X
MISCELLANEOUS				
Boards, running—replace	E	X		
Chains, tire—replace	X			
Cleaning	X			
Guards, mud—replace	X			
Guards, mud—repair		X		
Hook, pintle—replace (par. 123)	X			
Hook, pintle—repair		X		
Lubrication (pars. 21 to 24).....	X			
Painting	X			
Sheet metal (splash pans and guards)—replace.....	X			
Sheet metal (splash pans and guards)—repair.....		X		
Tires—replace (par. 151)	X			
Tires—repair			X	
Tubes—replace (par. 151)	X			
Tubes—repair	E	E	X	
Roller, front assembly—replace (par. 124).....	X			
Roller, front assembly—repair (par. 124).....		X		
Welding, light		X		
Welding, medium			X	
Welding, heavy			E	X
Wheels—replace	X			
Wheels—repair		X		
Wheels—rebuild			E	X

BASIC HALF-TRACK VEHICLES (IHC) (PERSONNEL CARRIER M5, CAR M9AT, MULTIPLE GUN MOTOR CARRIAGE M14, AND SIMILAR IHC VEHICLES)

	ECHELONS			
	2nd	3rd	4th	5th
PROPELLER SHAFT ASSEMBLY				
Propeller shaft, w/universal joints, assembly—replace (par. 137)	X			
Propeller shaft, w/universal joints, assembly—repair....		X		
Propeller shaft, w/universal joints, assembly—rebuild....			E	X
SPRINGS AND SHOCK ABSORBERS				
Absorbers, shock and linkage—replace (par. 141)	X			
Absorbers, shock and linkage—repair		X		
Absorbers, shock and linkage—rebuild			E	X
Springs and shackles—replace (par. 141)	X			
Springs and shackles—repair		X		
Springs and shackles—rebuild			E	X
STEERING GEAR				
Gear, steering assembly—replace (par. 145)	E	X		
Gear, steering assembly—repair		X		
Gear, steering assembly—rebuild			E	X
Link, drag and component parts—service and replace (par. 144)	X			
Link, drag and component parts—repair		X		
Link, drag and component parts—rebuild			X	
SUSPENSION SYSTEM AND TRACK ASSEMBLY				
Bearings and oil seals, idler and bogie wheel—replace (pars. 56 and 57)	X			
Bogie components—replace (par. 56)	X			
Bogie—repair		X		
Bogie—rebuild			E	X
Idler assemblies—replace (par. 57)	X			
Idler assemblies—repair		X		
Idler assemblies—rebuild			E	X
Roller, track supporting assembly—replace (par. 58)	X			
Roller, track supporting assembly—repair		X		
Roller, track supporting assembly—rebuild			X	

MAINTENANCE ALLOCATION

	ECHELONS			
	2nd	3rd	4th	5th
SUSPENSION SYSTEM AND TRACK ASSEMBLY (CONT'D)				
Tracks—replace (par. 55).....	X			
Track adjusting mechanism—replace (par. 56).....	X			
Track adjusting mechanism—repair.....		X		
Track adjusting mechanism—rebuild.....			E	X

TRANSMISSION AND TRANSFER CASE

Levers, shift, transmission—replace (par. 148).....	X			
Levers, shift, transmission—repair.....		X		
*Transmission and transfer case assembly—replace (par. 148)			X	
Transmission and transfer case assembly—repair.....		X		
Transmission and transfer case assembly—rebuild.....			E	X

VEHICLE ASSEMBLY

Vehicle assembly—service	X			
Vehicle assembly—rebuild (with serviceable assemblies)			E	X

WINCH

Brake, safety—adjust and replace shoes (par. 155).....	X			
Brake, safety—repair (reline).....		X		
Brake, winch drum—adjust and replace (par. 155).....	X			
Brake, winch drum—repair (reline).....		X		
Pin, shear—replace (par. 156).....	X			
Shaft, drive, w/universal joints—service and replace (par. 158)			X	
Shaft, drive, w/universal joints—repair.....		X		
*Winch assembly—replace (par. 158)		X		
Winch assembly—repair		X		
Winch assembly—rebuild			E	X

44. TROUBLE SHOOTING.

a. Each of the sections which follow contains a trouble shooting paragraph for a portion of the vehicle.

*The second echelon is authorized to remove and reinstall items marked by an asterisk. However, when it is necessary to replace an item marked by an asterisk with a new or rebuilt part, subassembly or unit assembly, the assembly marked by an asterisk may be removed from the vehicle by the second echelon *only after authority has been obtained from a higher echelon of maintenance.*

BASIC HALF-TRACK VEHICLES (IHC) (PERSONNEL CARRIER M5, CAR M9A1, MULTIPLE GUN MOTOR CARRIAGE M14, AND SIMILAR IHC VEHICLES)

Section IX

ORGANIZATION TOOLS AND EQUIPMENT

Allocation of tools and equipment..... Paragraph 45

45. ALLOCATION OF TOOLS AND EQUIPMENT.

a. The tools and equipment included in this section, together with the vehicular tools listed in section VI, provide the using arms with necessary tools and equipment for servicing the vehicle.

b. Organization Maintenance Tools, Standard Sets.

Standard Tool Sets	Federal Stock Numbers
TOOL-SET, motor vehicle mechanics'	41-T-3538
TOOL-SET, welders'	41-T-3555
TOOL-SET, unit equipment, second echelon No. 1.....	41-T-3545-10
TOOL-SET, unit equipment, second echelon No. 2.....	41-T-3545-11
TOOL-SET, unit equipment, second echelon No. 3.....	41-T-3545-12
TOOL-SET, unit equipment, second echelon No. 4.....	41-T-3545-13
TOOL-SET, unit equipment, second echelon No. 5.....	41-T-3545-14
TOOL-SET, unit equipment, second echelon No. 6.....	41-T-3545-15
TOOL-SET, unit equipment, second echelon No. 7.....	41-T-3545-16
TOOL-SET, unit equipment, second echelon No. 9.....	41-T-3545-18

c. Regimental Maintenance Platoon Tools.

Name	Mfrs. Symbol	Mfrs. Tool No.	Federal Stock Number	Vehicle Set	Mech. Set	Company Set	Bin. or Regl. Crew Set	Regl. or Bin. Maint. Plat. Set
COMPRESSOR, idler spring trailing			41C2548	2	2	2		
COMPRESSOR, suspension volute spring			41C2559-50	2	2	2		
CONE, assembling bogie wheel grease retainer seal			41C2562-100	1	1	1		

ORGANIZATION TOOLS AND EQUIPMENT

Name	Mfrs. Symbol	Mfrs. Tool No.	Federal Stock Number	Vehicle Set Mech. Set	Company Set	Bin. or Regl. Crew Set	Regl. or Bin. Maint. Plat. Set
CONE, assembling track support roller grease retainer			41C2562-430			1	1
CONE, assembling trailing idler grease retainer			41C2562-460	1	1	1	
FIXTURE, track connecting, w/simplex jack and lever bar			41F2997-85	1	1	1	
GAGE, turret hydraulic system, 1,000-lb			41G450	1			1
GAGE, low and reverse, transmission band adjusting			41G218	2	1	1	
GAGE, throttle, front relay			41G426	2	1	1	
GAGE, throttle, intermediate relay			41G426-20	2	1	1	
GAGE, valve stem length			41G504			1	1
GUIDE, bogie wheel gudgeon, installing (use w/slide hammer C6644C)			41G2501	1	1	1	
INSTALLER, valve lifter bracket			41I144-250			1	1
LIFT, bogie wheel, medium tank			41L1375-75	1	1	1	
LIFTER, valve remover and replacer			41L1425			1	1
PULLER, bogie gudgeon, screw type, w/adapter A161884			41P2905-65	1	1	1	
PULLER, slide hammer type, bogie gudgeon			41P2957-27	1	1	1	
RATCHET, trailing idler shaft wrench			41R380	1	1	1	

BASIC HALF-TRACK VEHICLES (IHC) (PERSONNEL CARRIER M5, CAR M9A1, MULTIPLE GUN MOTOR CARRIAGE M14, AND SIMILAR IHC VEHICLES)

Name	Mfrs. Mfrs.	Symbol Tool No.	Federal Stock Number	Vehicle Set	Mech. Set	Company Set	Bfn. or Regi. Crew Set	Regl. or Bfn. Maint. Plat. Set
SLING, controlled differential and transfer unit			41S3832-27					4
SLING, front deck, engine roof and gun turret								
SLING, radiator lifting			41S3832-20					4
SOCKET, screwdriver, 1/2-in. sq-drive, for 5/8-in. armor plate bolts			41S3832-85					4
WRENCH, box, bogie axle; capacity, 2 3/16-in.; 60 in. long			41S3867-155	1	2			2
WRENCH, brake adjusting, 1 1/16-in.			41W547		1		1	1
WRENCH, engrs., sgle-end, gudgeon nut, 1 7/8-in.			41W1314		1		1	1
WRENCH, spanner, oil cooler nut			41W642-200	1	1		1	1
WRENCH, spark plug type, 1/2-in. sq-drive, 5/8-in.			41W3252-75				1	1
WRENCH, torque, 0—25 ft-lb			41W3322	1	1		1	1
WRENCH, trailing idler shaft			41W3629		2		1	1
WRENCH, trailing idler wheel nut and track adjusting,			41W3671		1		1	1
1 1 1/16- x 3 3/4-in.			41W3673		1			1

Section X

FRONT AXLE

	Paragraph
Description	46
Trouble shooting	47
Steering maintenance and adjustments	48
Front axle replacement	49

46. DESCRIPTION (figs. 34 and 35).

a. The front axle is of single-reduction, full-floating type having a straddle-mounted bevel-drive pinion and a conventional type differential. The front wheels are driven through constant-velocity universal joints enclosed within steering knuckles at the outer ends of the axle housing. Boots encircle the joints to prevent corrosion and rust formation on the housing sleeve. The weight of the front axle assembly is 820 pounds.

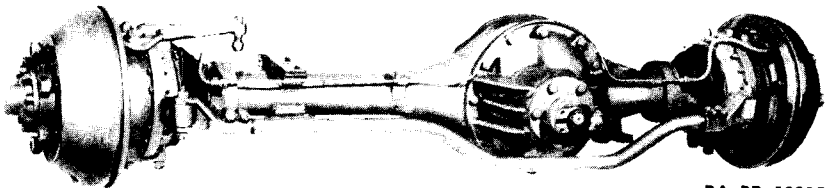

Figure 34 – Front Axle – Removed

RA PD 18215

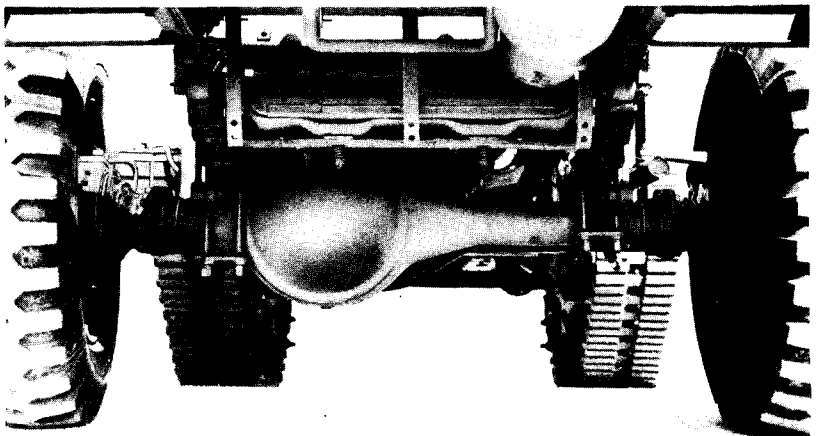

Figure 35 – Front Axle – Installed

RA PD 18216

BASIC HALF-TRACK VEHICLES (IHC) (PERSONNEL CARRIER M5, CAR M9A1, MULTIPLE GUN MOTOR CARRIAGE M14, AND SIMILAR IHC VEHICLES)

47. TROUBLE SHOOTING.

a. Hard Steering.

Possible Cause	Possible Remedy
Front axle shifted.	Relocate and tighten spring clips (par. 140).
Shackle bolts too tight.	Tighten snugly, and back off one-quarter turn (par. 140).
Lack of lubrication.	Lubricate tie rod yoke, steering gear, and steering drag link.
Improper toe-in.	Adjust at tie rod yokes (par. 48).
Tires underinflated.	Inflate tires to 70 pounds (max) (par. 149 c).
Bent frame.	Report to ordnance personnel.
Excessive caster.	Report to ordnance personnel.
Tight steering gear.	Adjust steering gear (par. 144).

b. Shimmy.

Knuckle bearings loose or worn.	Readjust or replace (par. 48 a).
Tie rod loose.	Tighten or replace worn parts.
Front axle shifted.	Relocate and tighten U-bolts and spring clips (par. 140).
Insufficient toe-in.	Adjust at tie rod yokes (par. 48 b).
Improper load distribution.	Equalize load.
Steering gear loose.	Retighten (par. 144).
Excessive or insufficient caster.	Report to ordnance personnel.
Spring set.	Report to ordnance personnel.

c. Wandering.

Axle shifted.	Relocate and tighten U-bolts and spring clips (par. 140).
Front wheel bearings out of adjustment.	Adjust wheel bearings (par. 152 a).
Bent axle parts.	Report to ordnance personnel.
Tight steering gear.	Adjust steering gear (par. 144).
Tires unequally inflated.	Inflate to 70 pounds (max) (par. 149 c).
Brakes dragging.	Adjust brakes (par. 65).

FRONT AXLE

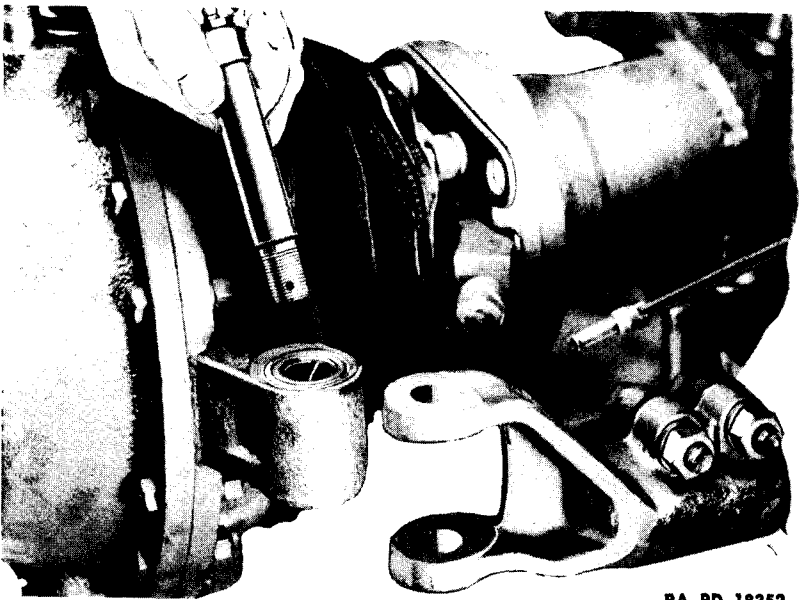

RA PD 18352

Figure 36 — Disconnecting Tie Rod End

48. STEERING MAINTENANCE AND ADJUSTMENTS.

a. Steering Knuckle Bearing Adjustment.

(1) EQUIPMENT.

JACK (2)

PLIERS

SCREWDRIVER

TENSION SCALE

WRENCH, $1\frac{5}{16}$ -in.

WRENCH, 1-in.

(2) PROCEDURE.

(a) Jack up Axle.

JACK (2)

Place jacks under axle and raise wheels.

(b) Disconnect Tie Rod End (fig. 36).

PLIERS

WRENCH, $1\frac{5}{16}$ -in.

Remove cotter key and remove nut from tie rod end bolt. Remove bolt and disconnect tie rod end.

(c) Disconnect Drag Link (fig. 37).

PLIERS

SCREWDRIVER

Remove boot from axle end of drag link. Remove cotter key and remove end plug. Disconnect drag link from steering arm.

(d) Adjustment.

WRENCH, 1-in.

BASIC HALF-TRACK VEHICLES (IHC) (PERSONNEL CARRIER M5, CAR M9A1, MULTIPLE GUN MOTOR CARRIAGE M14, AND SIMILAR IHC VEHICLES)

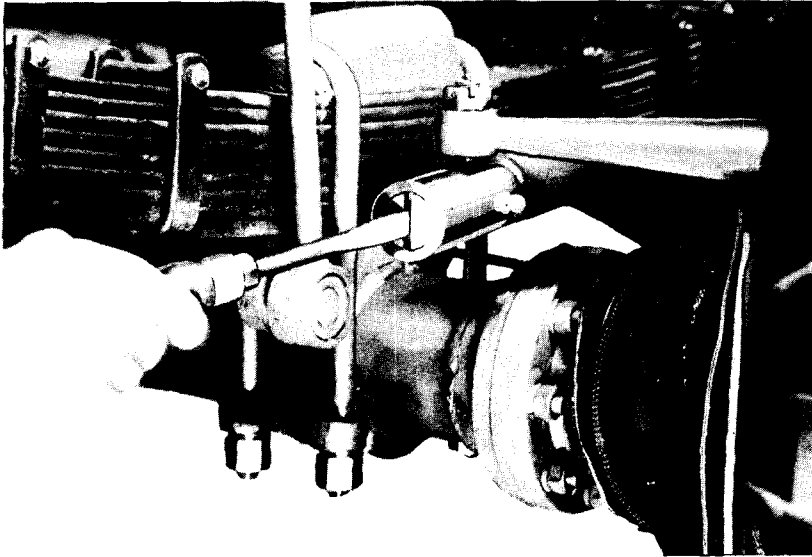

RA PD 18221

Figure 37 – Disconnecting Steering Drag Link

Remove upper and lower bearing retainer nuts and lock washers. Remove retainers. Remove one thin shim from both upper and lower shim packs. Reinstall retainers with nuts and lock washers. Test steering knuckle for bind.

(e) *Testing Adjustment* (fig. 38).

TENSION SCALE

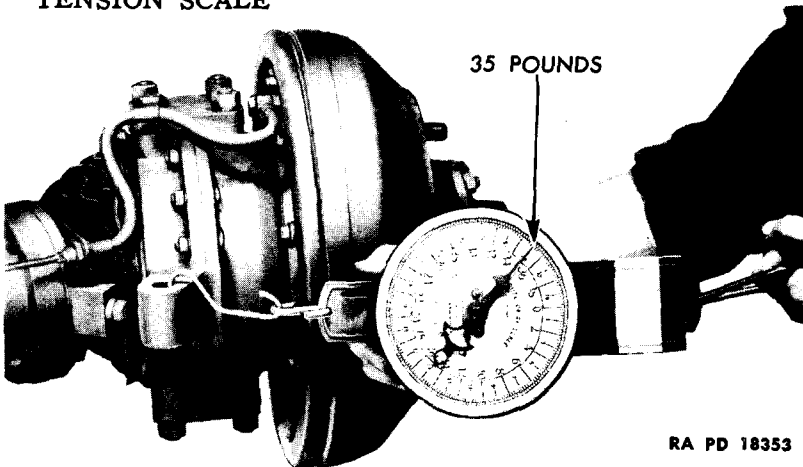

RA PD 18353

Figure 38 – Testing Steering Knuckle Bearing Adjustment

FRONT AXLE

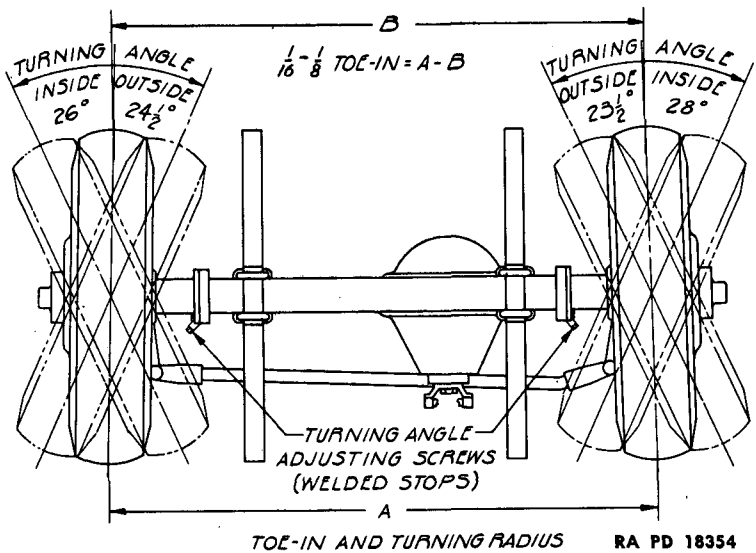
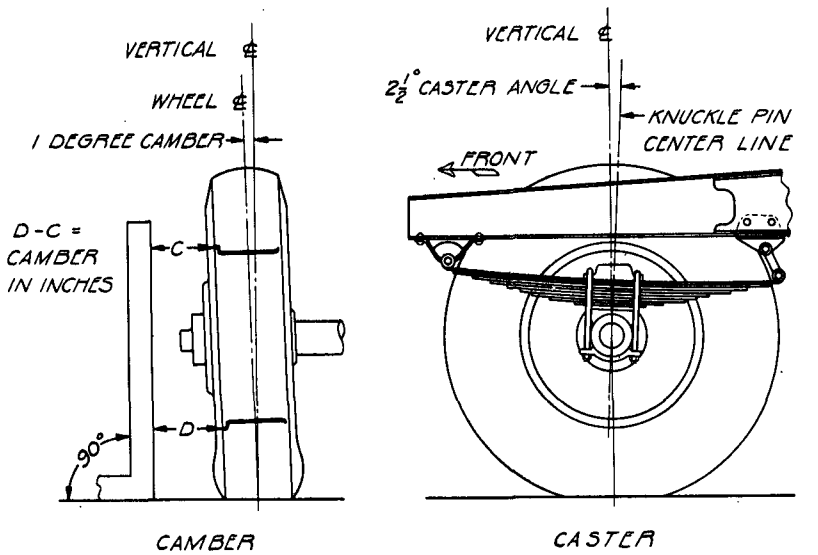
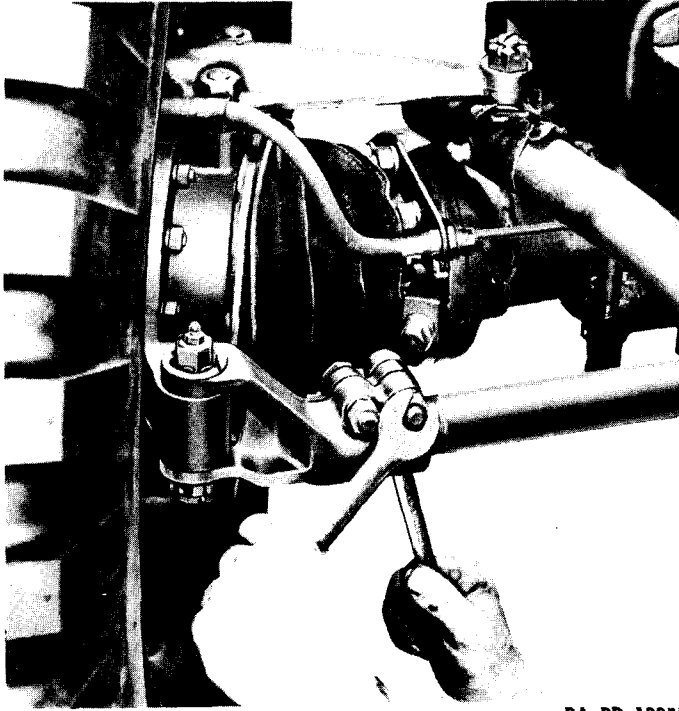

Figure 39 - Front Wheel Alinement

BASIC HALF-TRACK VEHICLES (IHC) (PERSONNEL CARRIER M5, CAR M9A1, MULTIPLE GUN MOTOR CARRIAGE M14, AND SIMILAR IHC VEHICLES)



RA PD 18355

Figure 40 — Loosening Tie Rod Clamp Bolts

Hook tension scale into tie rod end of steering knuckle. Tension or pull of from 30 to 35 pounds should be required to move steering knuckle assembly with seal through its range of travel.

(f) Connect Tie Rod Ends.

NOTE: Do not draw nut so tight that it will squeeze yoke together and cause a bind.

(g) Connect Drag Link to Steering Arm.

(h) Lower Wheels and Remove Jacks.

b. Toe-in (fig. 39).

The front wheels are not parallel when in the position of straight ahead running, but are closer together at the front than at the rear. Toe-in has the effect of counteracting the tendency of the wheels to roll outward or separate as a result of camber. Specified toe-in of the front wheels is one-sixteenth inch to one-eighth inch, and should be maintained within these limits.

FRONT AXLE

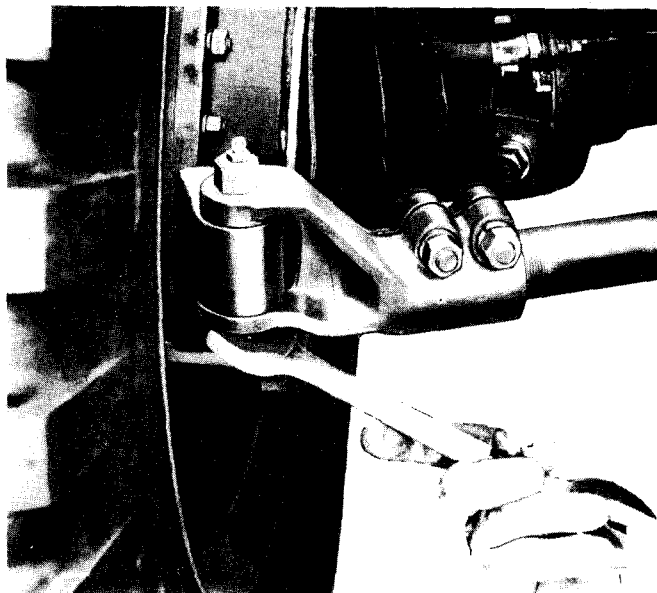

RA PD 18356

Figure 41 — Tie Rod End Bolt Nut — Removal

(1) EQUIPMENT.

CHALK

GAGE, toe-in

JACK (2)

MEASURING STICK

PLIERS

SCREWDRIVER

WRENCH, $\frac{3}{4}$ -in.

WRENCH, $\frac{15}{16}$ -in.

(2) PROCEDURE.

(a) *Raise Wheels.*

JACK (2)

Place jacks under axle and raise wheels.

(b) *Scribe Tire Tread.*

CHALK

SCREWDRIVER

Chalk tread of tires, spin wheels and, using screwdriver point, scribe line on each tire. Line will meet all the way around.

(c) *Lower Wheels.*

(d) *Measure Toe-in.*

MEASURING STICK

With wheels in straight ahead position, measure between scribed lines at front of tire and compare with measurement between lines at rear. Measurements should be as near hub height as possible. If measurement is not one-sixteenth inch to one-eighth inch greater at rear of tires than at front, make adjustment.

**BASIC HALF-TRACK VEHICLES (IHC) (PERSONNEL CARRIER M5, CAR M9A1,
MULTIPLE GUN MOTOR CARRIAGE M14, AND SIMILAR IHC VEHICLES)**

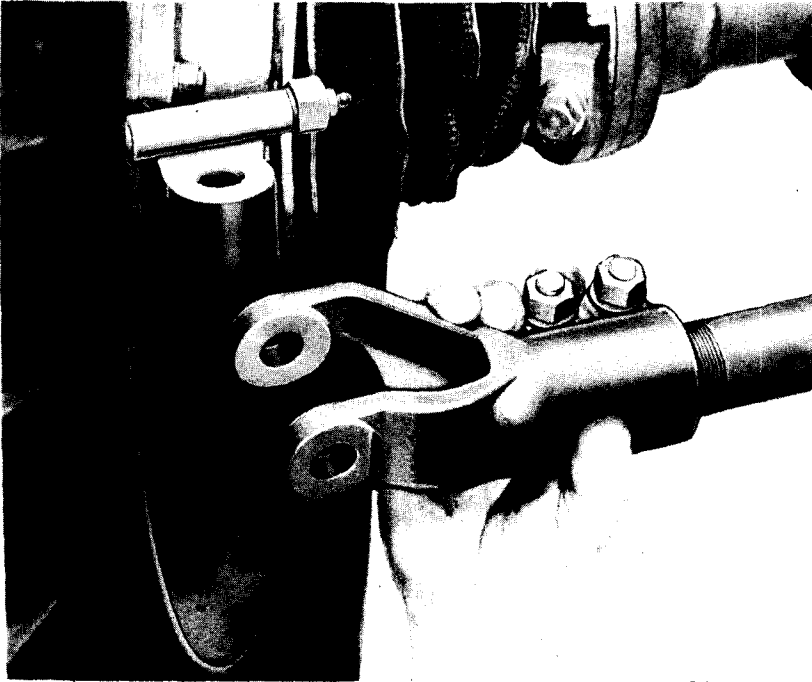

RA PD 18357

Figure 42 – Adjusting Tie Rod End

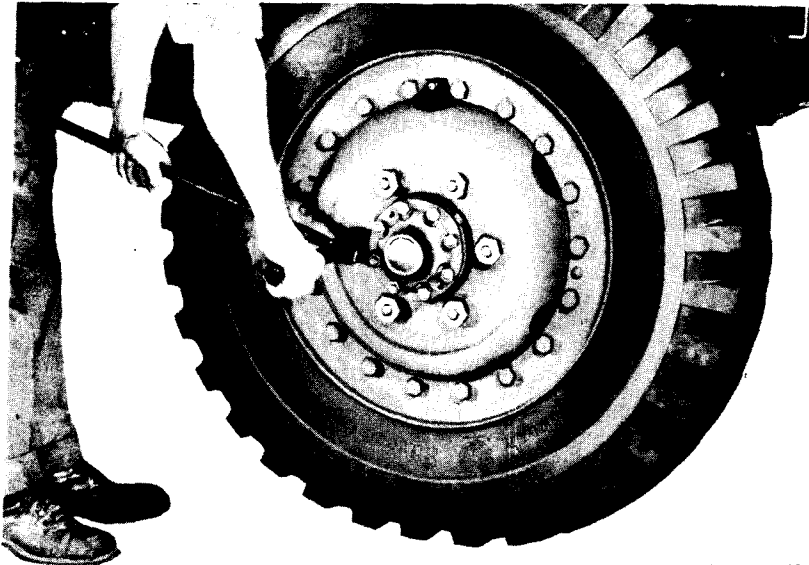

RA PD 18218

Figure 43 – Loosening Wheel Stud Nuts

FRONT AXLE

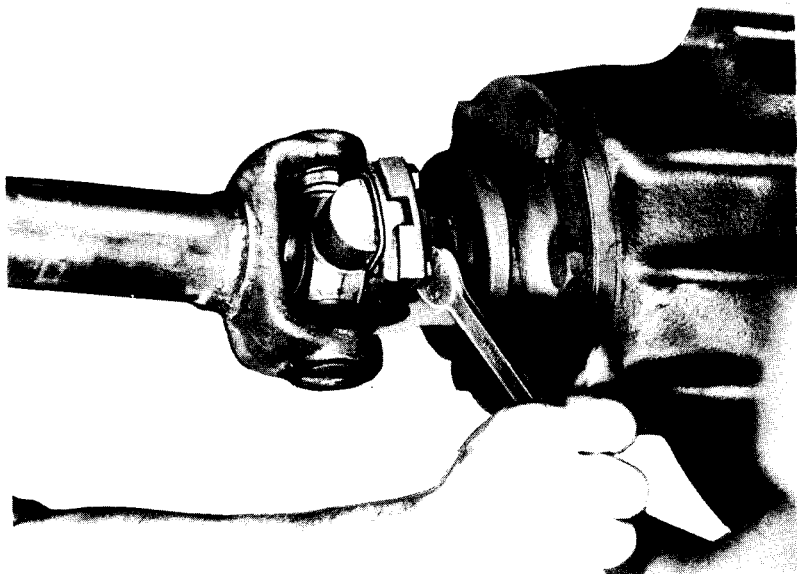

RA PD 18219

Figure 44 – Disconnecting Universal Joint

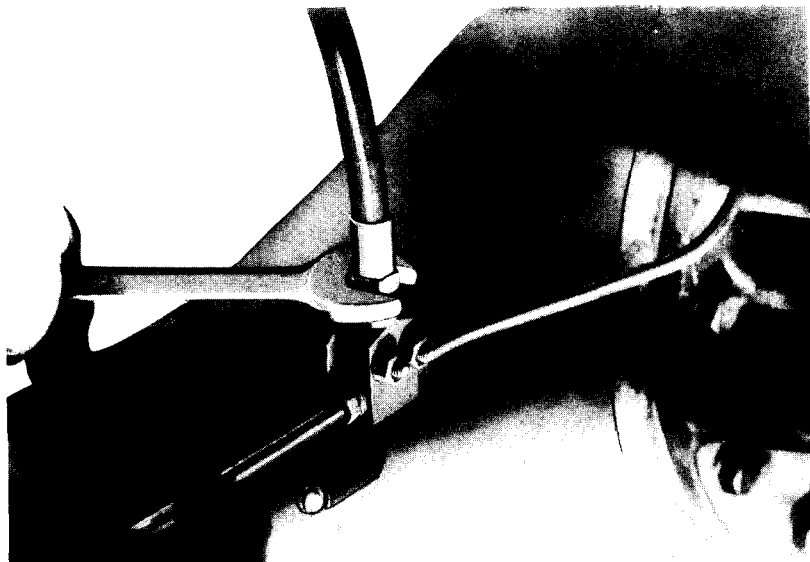

RA PD 18220

Figure 45 – Disconnecting Brake Tube

BASIC HALF-TRACK VEHICLES (IHC) (PERSONNEL CARRIER M5, CAR M9A1, MULTIPLE GUN MOTOR CARRIAGE M14, AND SIMILAR IHC VEHICLES)

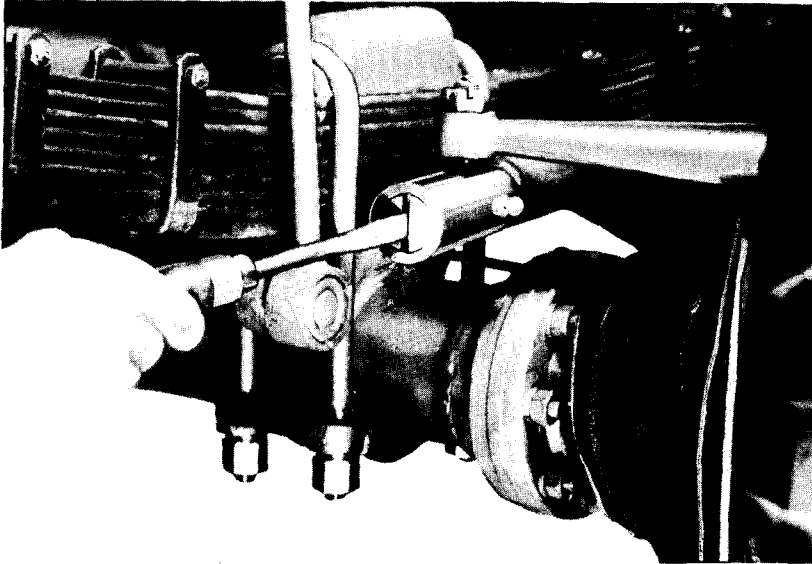

RA PD 18221

Figure 46 — Disconnecting Steering Drag Link

(e) *Adjustment.*

PLIERS

MEASURING STICK

WRENCH, $\frac{3}{4}$ -in.

WRENCH, $1\frac{5}{16}$ -in.

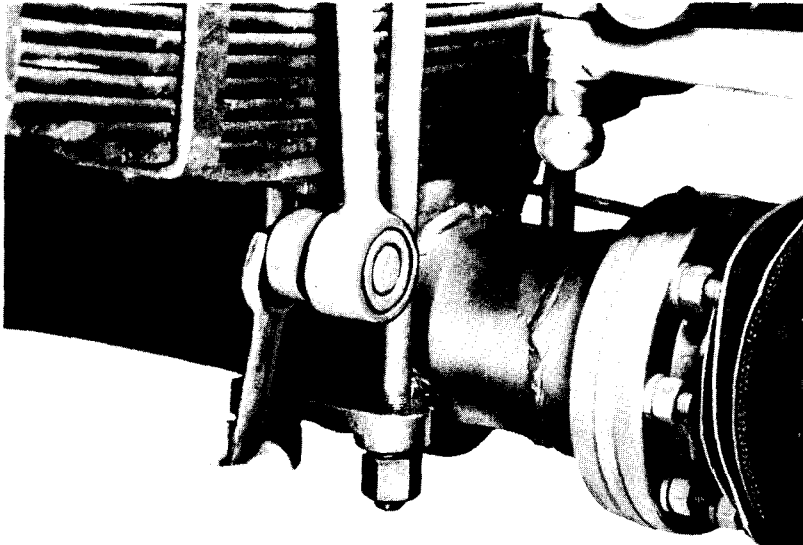

RA PD 18222

Figure 47 — Disconnecting Shock Absorber

FRONT AXLE

Loosen clamp bolt nuts (fig. 40). Remove cotter pin from tie rod end bolts. Remove tie rod end bolt nut from end having fine threads (fig. 41). Remove bolt and turn tie rod end one complete turn to lengthen or shorten rod as indicated by measurement (fig. 42). Reconnect tie rod end. Roll truck forward one foot. Recheck measurements. Repeat above operations as necessary to obtain specified toe-in. Coarse-threaded end may be used to accomplish adjustment.

(f) *Remove Jacks.*

(g) *Reconnect Tie Rod Ends.*

NOTE: Do not draw nut so tight that it will squeeze yoke and cause a bind.

(h) *Tighten Clamp Bolts Securely.*

49. FRONT AXLE REPLACEMENT.

a. Equipment.

HAMMER	WRENCH, $\frac{9}{16}$ -in.
JACK, tall (2)	WRENCH, $\frac{7}{8}$ -in.
PLIERS	WRENCH, end, $\frac{3}{4}$ -in.
SCREWDRIVER	WRENCH, end, 1-in.
SUPPORT (2)	WRENCH, wheel stud nut

b. Procedure.

(1) **LOOSEN WHEEL STUD NUTS** (fig. 43).

WRENCH, wheel stud nut

Loosen wheel stud nuts on front wheels.

(2) **DISCONNECT FRONT UNIVERSAL JOINT** (fig. 44).

WRENCH, $\frac{9}{16}$ -in.

Remove four cap screws from propeller shaft front universal joint.

(3) **DISCONNECT BRAKE FLEXIBLE TUBE** (fig. 45).

WRENCH, end, $\frac{3}{4}$ -in.

WRENCH, end, 1-in.

Disconnect brake tube at engine cross arm and at front axle.

(4) **DISCONNECT STEERING DRAG LINK AT STEERING ARM** (fig. 46).

PLIERS

SCREWDRIVER

Remove boot. Remove cotter pin. Remove drag link plug.

(5) **DISCONNECT SHOCK ABSORBER LINK** (fig. 47).

HAMMER

WRENCH, $\frac{7}{8}$ -in.

Remove nut from shock absorber link at axle. Remove link from axle.

BASIC HALF-TRACK VEHICLES (IHC) (PERSONNEL CARRIER M5, CAR M9A1, MULTIPLE GUN MOTOR CARRIAGE M14, AND SIMILAR IHC VEHICLES)

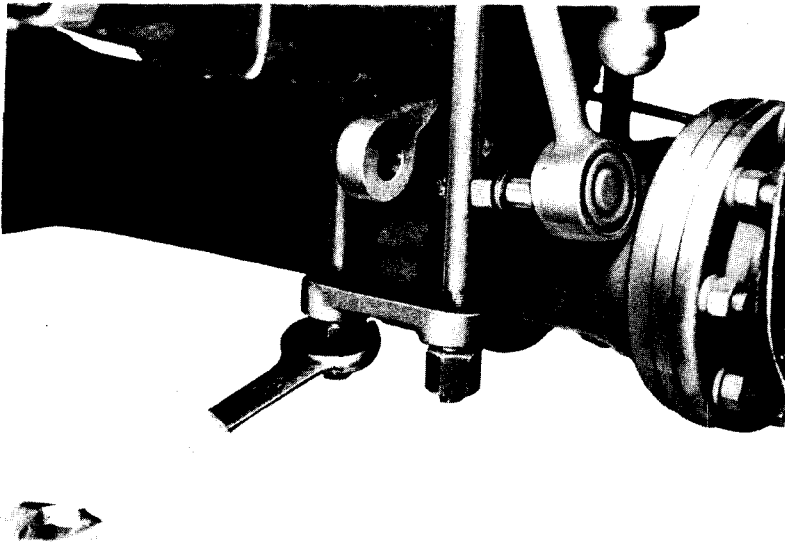

Figure 48 – U-Bolt Nuts – Removal

RA PD 18223

(6) REMOVE ENGINE SIDE GUARD ARMORS.

WRENCH, $\frac{3}{16}$ -in.

Remove bolts holding engine guard armors.

(7) REMOVE FRONT SPRING U-BOLT AND NUTS (fig. 48).

WRENCH, end, 1-in.

Remove eight spring U-bolt nuts and washers. Remove spring U-bolts.

(8) RAISE FRONT OF VEHICLE.

JACK, tall (2)

Place jacks under the frame just to the rear of each front spring. Raise front end of vehicle. **CAUTION:** Place blocking or trestle as safety precaution, so that the vehicle will not fall off the jacks and injure personnel or property.

(9) REMOVE AXLE ASSEMBLY (fig. 49).

Roll front axle assembly out from under vehicle.

(10) REMOVE WHEEL AND TIRE ASSEMBLIES (fig. 50).

WRENCH, wheel stud nut

Place axle assembly on supports. Remove wheel stud nuts. Remove wheel and tire assemblies.

FRONT AXLE

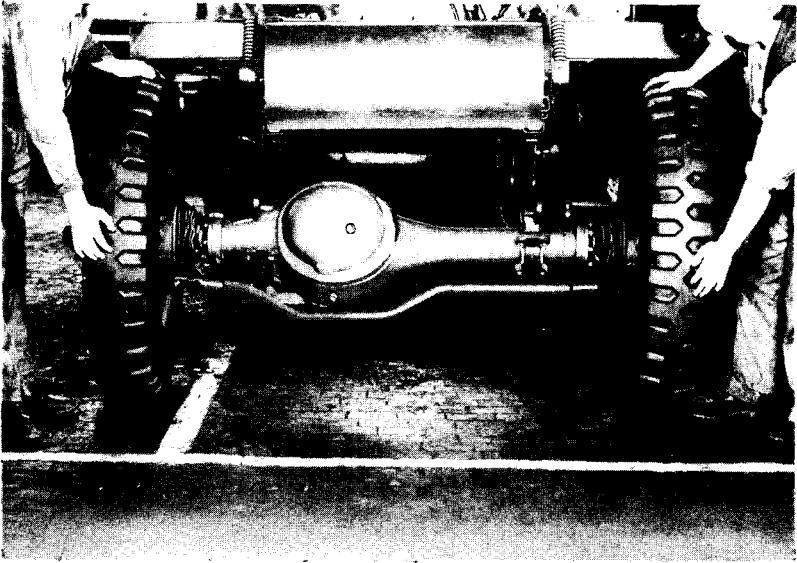

RA PD 18224

Figure 49 — Front Axle — Removal

- (11) INSTALL AXLE AND WHEEL AND TIRE ASSEMBLIES.
- (12) ROLL AXLE ASSEMBLY IN POSITION UNDER VEHICLE.

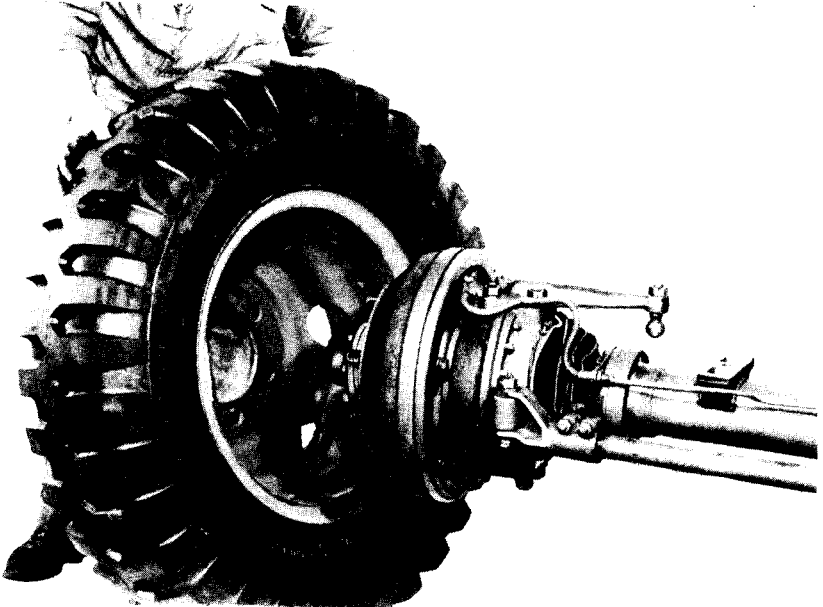

RA PD 18225

Figure 50 — Tire and Wheel — Removal

BASIC HALF-TRACK VEHICLES (IHC) (PERSONNEL CARRIER M5, CAR M9A1, MULTIPLE GUN MOTOR CARRIAGE M14, AND SIMILAR IHC VEHICLES)

- (13) INSTALL SPRING U-BOLT AND NUTS.
- (14) CONNECT BRAKE LINE FLEXIBLE TUBES.
- (15) INSTALL ENGINE GUARD ARMORS.
- (16) CONNECT DRAG LINK TO STEERING ARM.
- (17) CONNECT FRONT UNIVERSAL JOINT.
- (18) CONNECT SHOCK ABSORBER LINK.
- (19) BLEED BRAKE LINES (par. 66).
- (20) LOWER VEHICLE AND REMOVE JACKS.
- (21) TIGHTEN WHEEL STUD NUTS.

Section XI

REAR AXLE

	Paragraph
Description	50
Trouble shooting	51
Rear axle maintenance and adjustments	52
Rear axle replacement	53

50. DESCRIPTION (figs. 51 and 52).

a. The rear axle is of the single-reduction type having a straddle-mounted bevel-drive pinion and a conventional type differential. The housing is of banjo type and the differential carrier and differential are installed as an assembly. The weight of the rear axle assembly is 796 pounds.

51. TROUBLE SHOOTING.

a. Backlash.

Loose axle shaft.	Tighten flange nuts (par. 53).
Worn axle shaft splines.	Replace axle shaft (par. 53 a).
Excessive pinion and bevel drive clearance.	Report to ordnance personnel.

b. Grease Leakage.

Grease on brakes.	Inspect seals and replace if necessary (par. 152 d).
-------------------	------------------------------------------------------

52. REAR AXLE MAINTENANCE AND ADJUSTMENTS.

a. Equipment.

CHAIN	WRENCH, $\frac{5}{8}$ -in.
CROWBAR	WRENCH, end, $\frac{1}{2}$ -in.
EXTENSION, socket wrench	WRENCH, end, $\frac{3}{4}$ -in.
HAMMER	WRENCH, end, 2 $\frac{1}{4}$ -in.
HANDLE, socket wrench	WRENCH, end, 2 $\frac{5}{16}$ -in.
JACK, 12-ton (2)	WRENCH, socket, $\frac{3}{4}$ -in.
PUNCH	WRENCH, socket, 1 $\frac{5}{16}$ -in.
SCREW, cap, $\frac{1}{2}$ -in. x 2-in. (2)	WRENCH, wheel bearing nut, with handle
SCREWDRIVER	
TURNBUCKLE	WRENCH, wheel stud nut

BASIC HALF-TRACK VEHICLES (IHC) (PERSONNEL CARRIER M5, CAR M9A1, MULTIPLE GUN MOTOR CARRIAGE M14, AND SIMILAR IHC VEHICLES)

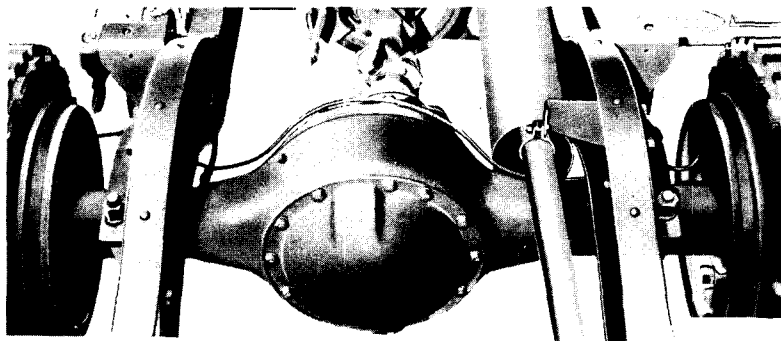

RA PD 18226

Figure 51 — Rear Axle — Installed

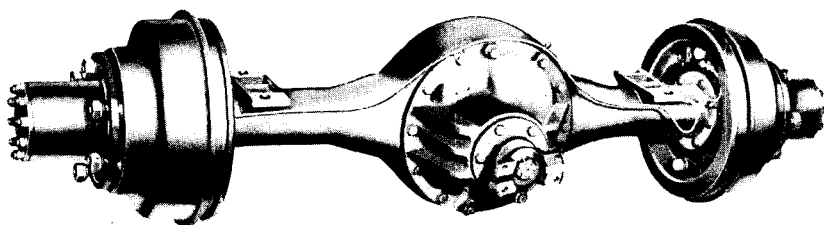

RA PD 18358

Figure 52 — Rear Axle — Removed

b. Procedure.

(1) DRIVE SPROCKET BEARING ADJUSTMENT.

- | | |
|---------------------------------|----------------------------|
| CHAIN | WRENCH, 5/8-in. |
| CROWBAR | WRENCH, end, 1/2-in. |
| EXTENSION, socket wrench | WRENCH, end, 3/4-in. |
| HAMMER | WRENCH, end, 2 1/4-in. |
| HANDLE, socket wrench | WRENCH, end, 2 5/16-in. |
| JACK, 12-ton (2) | WRENCH, socket, 3/4-in. |
| PUNCH | WRENCH, socket, 1 5/16-in. |
| SCREW, cap, 1/2-in. x 2-in. (2) | WRENCH, wheel bearing nut |
| SCREWDRIVER | WRENCH, wheel stud nut |
| TURNBUCKLE | |

(a) Remove Track (par. 55).

(b) Remove Driving Shaft.

WRENCH, socket, 3/4-in.

Remove ten driving shaft flange nuts and lockwashers (fig. 53). Insert two cap screws in the two threaded holes in flange to force shaft outward

REAR AXLE

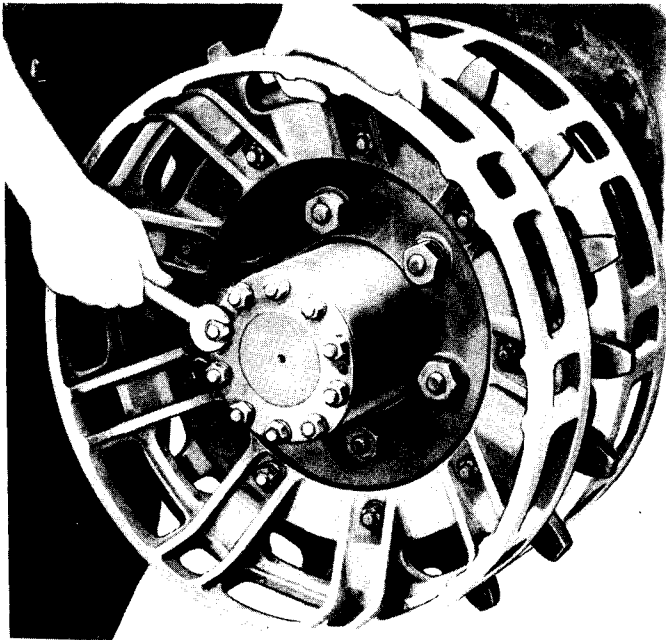

RA PD 18360

Figure 53 — Forcing Shaft from Housing

(fig. 54). Turn screws alternately, pulling shaft out. Remove driving shaft (fig. 55).

(c) *Remove Bearing Lock Nut.*

HAMMER
PUNCH

WRENCH, wheel bearing nut

Straighten lock washer flange. Remove outer lock nut and lock washer (fig. 56).

(d) *Adjust Bearing* (fig. 57).

HANDLE, for nut wrench

WRENCH, wheel bearing nut

Tighten bearing nut while turning drive sprocket until drag is felt. Back off adjustment one-eighth turn.

(e) *Install Bearing Lock Nut and Lock Washer.*

(f) *Install Driving Shaft and Retaining Nuts and Washers.*

(g) *Install Track* (par. 55).

53. REAR AXLE REPLACEMENT.

a. **Driving Shaft.** The shaft should be replaced if it has become bent or if the splines are worn. When replacing, use a new flange gasket.

**BASIC HALF-TRACK VEHICLES (IHC) (PERSONNEL CARRIER M5, CAR M9A1,
MULTIPLE GUN MOTOR CARRIAGE M14, AND SIMILAR IHC VEHICLES)**

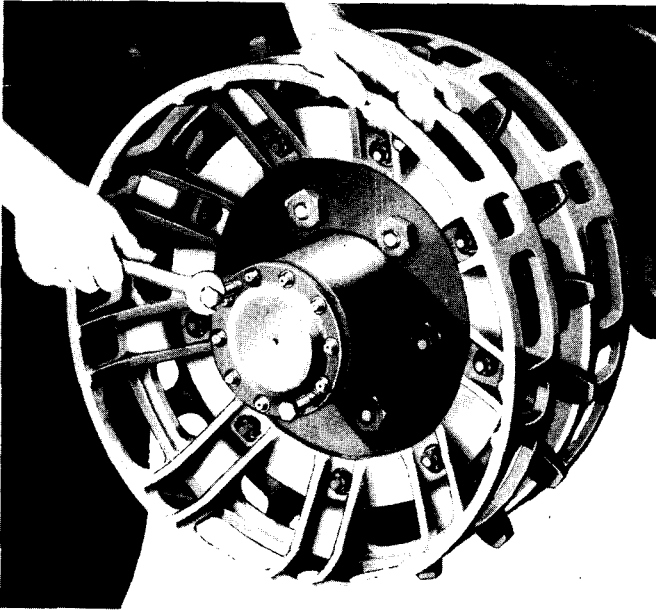

RA PD 18359

Figure 54 — Drive Shaft Nut — Removal

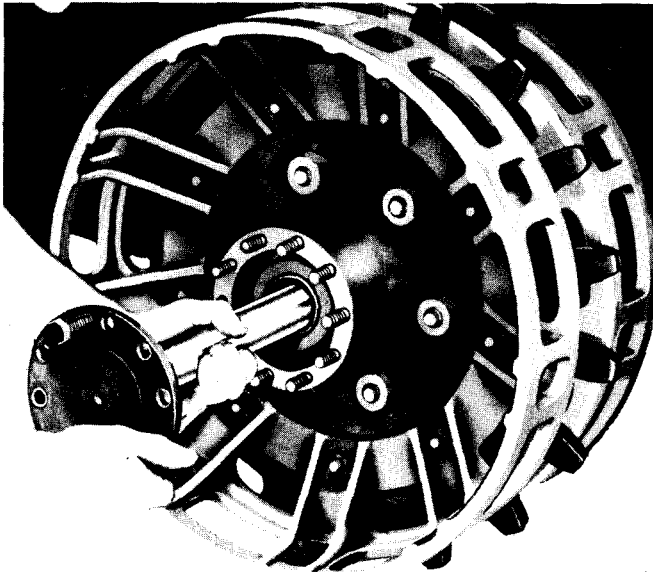

RA PD 18361

Figure 55 — Drive Shaft — Removal

REAR AXLE

(1) EQUIPMENT.

SCREW, cap, 2½-in. x 2-in. WRENCH, ¾-in.

(2) PROCEDURE.

(a) *Remove Driving Shaft.*

SCREW, cap, 2½-in. x 2-in. WRENCH, ¾-in.

Remove the ten driving shaft flange nuts and washers (fig. 53). Insert flange screws in the two threaded holes in flange and force shaft outward (fig. 54). Remove shaft and gasket (fig. 57).

(b) *Install Driving Shaft and New Gasket.*(c) *Install Driving Flange Nuts and Washers and Tighten Securely.***b. Rear Axle Assembly.**

(1) EQUIPMENT.

CHAIN	TURNBUCKLE
CROWBAR	WRENCH, end, ½-in.
EXTENSION, socket wrench	WRENCH, end, ⅝-in.
HANDLE, socket wrench	WRENCH, end, ¾-in.
HANDLE, wheel stud nut wrench	WRENCH, end, 2¼-in.
JACK, 12-ton (2)	WRENCH, end, 2⅝-in.
PULLER	WRENCH, socket, ¾-in.
SCREWDRIVER	WRENCH, socket, 1⅝-in.
	WRENCH, wheel stud nut

(2) REMOVE TRACKS (par. 55).

(3) DISCONNECT PROPELLER SHAFT UNIVERSAL JOINT (fig. 58).

SCREWDRIVER WRENCH, end, ⅝-in.

Bend back tangs of universal joint lock plate. Remove four cap screws holding universal joint to companion flange. Lower propeller shaft.

(4) REMOVE DRIVE SPROCKET ASSEMBLY.

HANDLE, wheel stud nut wrench WRENCH, wheel stud nut

Remove drive sprocket retaining nuts (fig. 59). Remove drive sprocket assembly (fig. 60).

(5) DISCONNECT BRAKE LINE (fig. 61).

WRENCH, end, ½-in.

Disconnect brake line at frame coupling.

(6) DISCONNECT FRAME COUPLING FROM BRACKET (fig. 62).

WRENCH, ½-in.

Remove cap screw holding coupling to frame bracket.

(7) BLOCK UP AXLE ASSEMBLY.

**BASIC HALF-TRACK VEHICLES (IHC) (PERSONNEL CARRIER M5, CAR M9A1,
MULTIPLE GUN MOTOR CARRIAGE M14, AND SIMILAR IHC VEHICLES)**

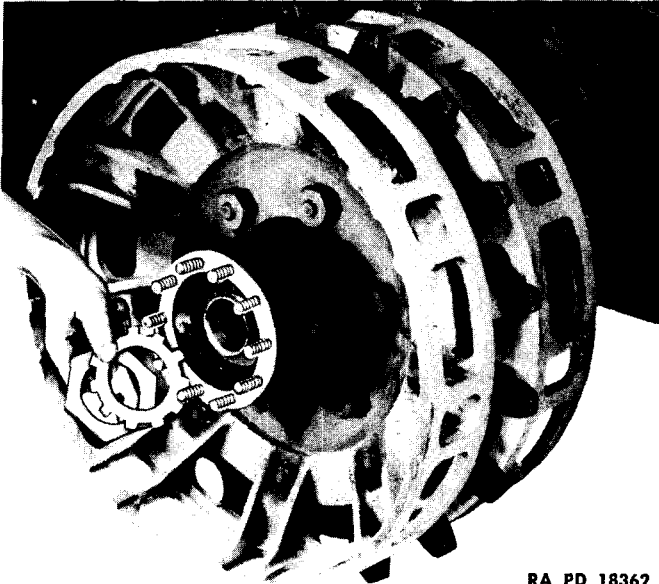

RA PD 18362

Figure 56 — Lock Nut — Removal

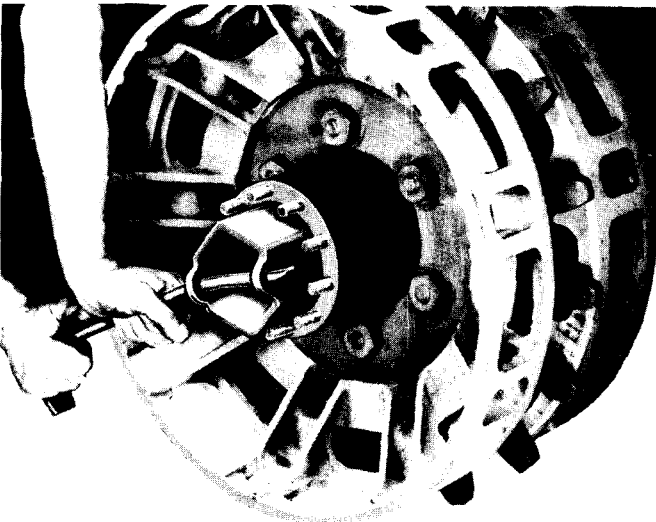

RA PD 18363

Figure 57 — Adjusting Bearings

REAR AXLE

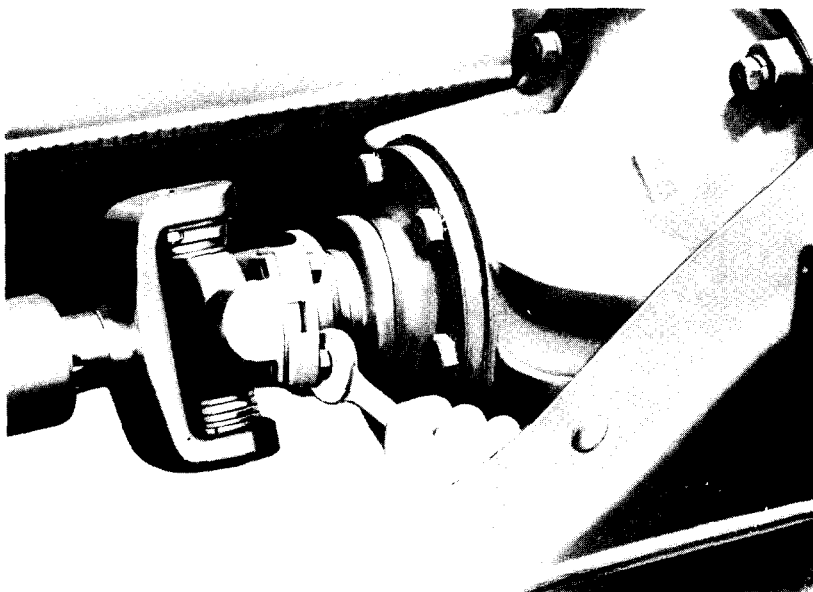

RA PD 18539

Figure 58 — Disconnecting Universal Joint

(8) REMOVE U-BOLT NUTS (fig. 63).

HANDLE, socket wrench

WRENCH, socket, $1\frac{5}{16}$ -in.

Remove four U-bolt nuts, lock washers, and U-bolts from rear axle.

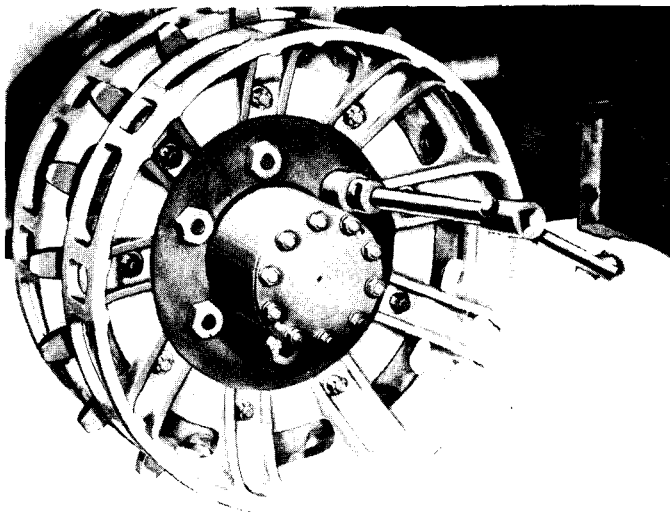

RA PD 18365

Figure 59 — Drive Sprocket Hub Stud Nut — Removal

**BASIC HALF-TRACK VEHICLES (IHC) (PERSONNEL CARRIER M5, CAR M9A1,
MULTIPLE GUN MOTOR CARRIAGE M14, AND SIMILAR IHC VEHICLES)**

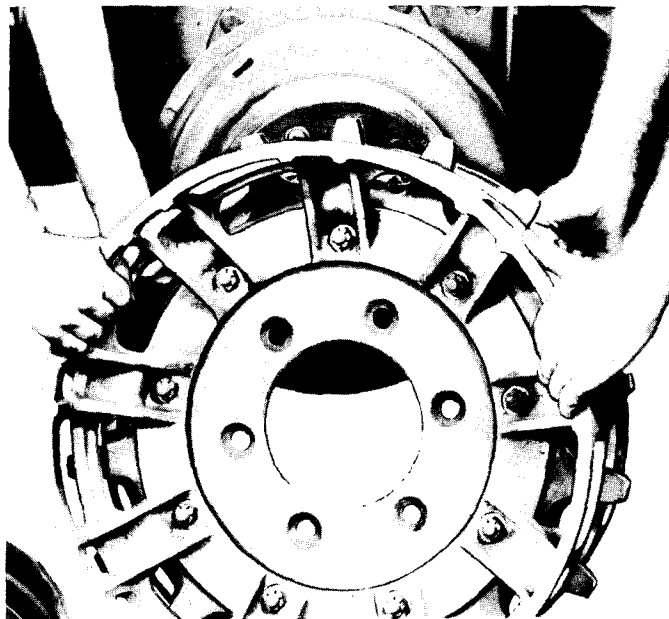

RA PD 18366

Figure 60 – Drive Sprocket Assembly – Removal

- (9) LOWER AND REMOVE ASSEMBLY (fig. 64).
- (10) RAISE REAR AXLE ASSEMBLY AND SUPPORT IN POSITION.

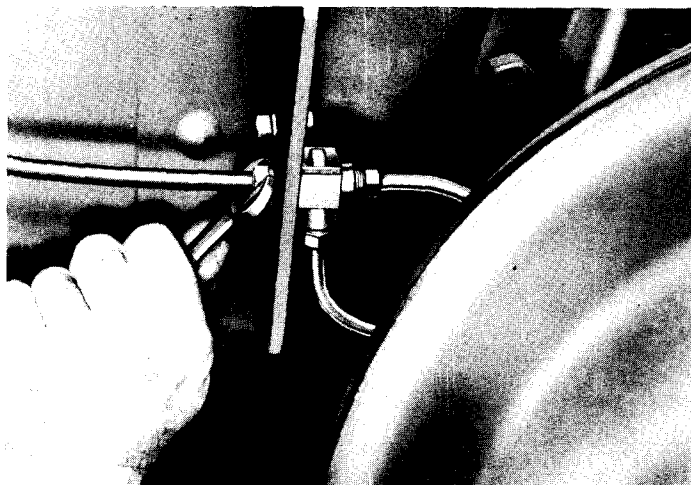

RA PD 18367

Figure 61 – Disconnecting Brake Line

REAR AXLE

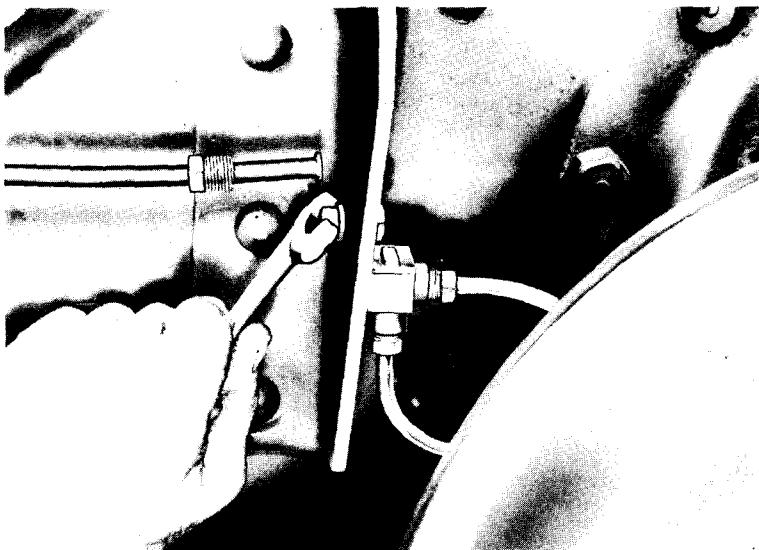

RA PD 18368

Figure 62 – Brake Line Coupling – Removal

- (11) INSTALL U-BOLTS, NUTS, AND WASHERS.
- (12) CONNECT BRAKE LINE COUPLING TO FRAME BRACKET.
- (13) CONNECT BRAKE LINE TO FRAME COUPLING.
- (14) CONNECT UNIVERSAL JOINT.

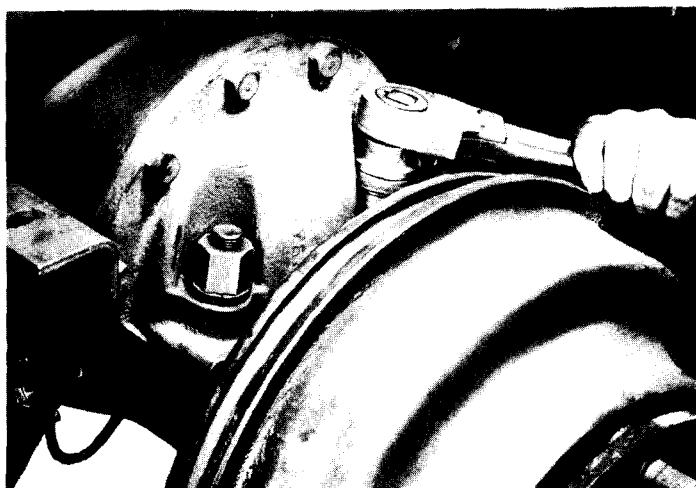

RA PD 18369

Figure 63 – U-Bolt Nuts – Removal

BASIC HALF-TRACK VEHICLES (IHC) (PERSONNEL CARRIER M5, CAR M9A1, MULTIPLE GUN MOTOR CARRIAGE M14, AND SIMILAR IHC VEHICLES)

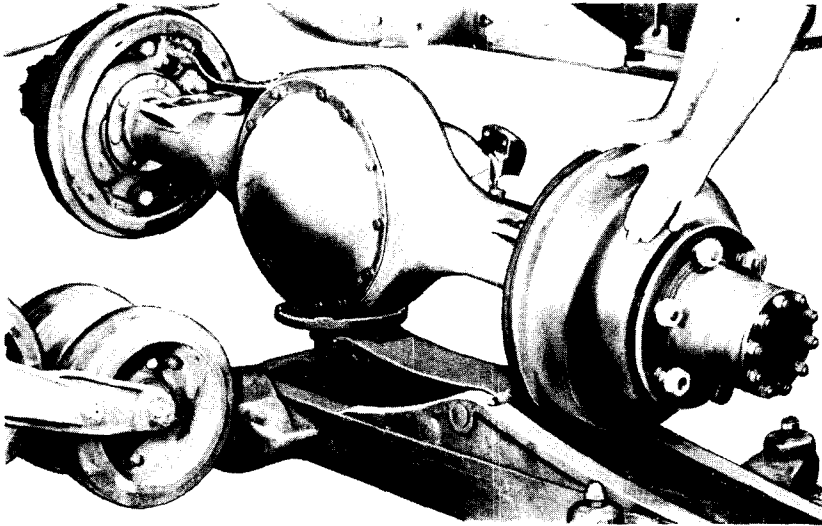

RA PD 18370

Figure 64 – Rolling Out Rear Axle Assembly

- (15) INSTALL DRIVE SPROCKET ASSEMBLY.
- (16) INSTALL TRACKS (par. 55).
- (17) BLEED BRAKE LINES (par. 66).

Section XII

BOGIE SUSPENSION AND TRACK

	Paragraph
Description	54
Tracks	55
Bogies	56
Adjusting idlers	57
Track supporting rollers	58

54. DESCRIPTION (fig. 65).

a. The rear of the vehicle is mounted on two bogie suspensions. Each suspension is spring-supported and rubber-tired rollers ride on an endless track. Each track is supported at the top center by a steel roller and is driven from the rear axle by the front sprocket. The rear idler sprocket is adjustable to maintain the proper track tension.

55. TRACKS (fig. 66).

a. **Description.** Tracks are of endless band type, made of rubber moulded around steel cables which extend throughout the track length. Metal guides are bolted along the center line of the tracks and act as guides for the drive sprocket teeth. The weight of one track is approximately 540 pounds.

b. **When to Replace.** Half-track vehicle tracks must be removed when the rubber on the ground side has worn to the extent that wear on the steel cross bars and exposure of the cables is imminent. Quite often the rubber will separate from and expose the cross bars before the track is worn out; when this condition occurs the track may be run until wear on the cross bars is imminent.

c. **Switching Sides.** Half-track tracks which are operated on roads have a tendency to wear faster on the right-hand side of the vehicle. Left-hand tracks should either be combined as replacements with other tracks of equal wear or tracks should be switched from one side of the vehicle to the other in order to obtain maximum wear from all tracks.

d. **Adjusting Tension.** Proper track tension is the most important single maintenance service. Proper tension is as important with half-tracks as proper air pressure is with pneumatic tires. If the track tension is too tight, the vehicle rolls harder, causing increased track wear and greater possibility of failure, because the track runs too hot. Too tight a track also puts added strain on the rear idler, tending to pull it out of

BASIC HALF-TRACK VEHICLES (IHC) (PERSONNEL CARRIER M5, CAR M9A1, MULTIPLE GUN MOTOR CARRIAGE M14, AND SIMILAR IHC VEHICLES)

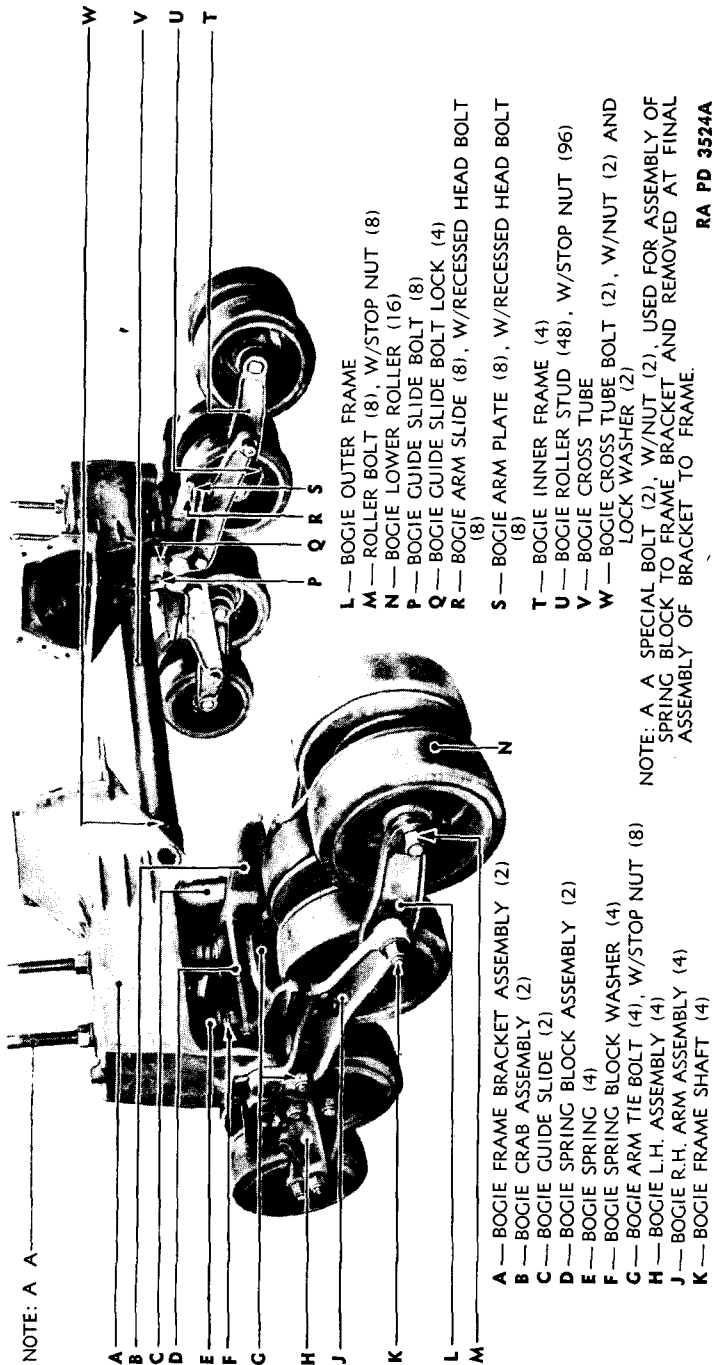

Figure 65 — Bogie Assembly

BOGIE SUSPENSION AND TRACK

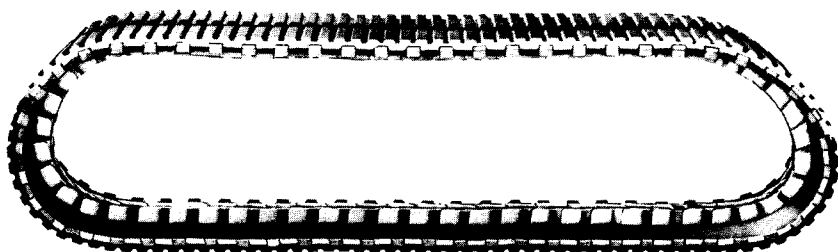

Figure 66 — Track Assembly — Removed

RA PD 18371

line by bending the idler shackle. If the track is too loose the guides may slide over the bogie flange and cut the bogie tires. A loose track also may cause the guides to climb out of the idler throat, loosening or bending the guides and damaging the idler shackle and possibly the idler shaft. There is the added possibility of the vehicle throwing the track.

e. Track Removal and Replacement.

(1) EQUIPMENT.

CHAIN, with turnbuckles

CROWBAR

EXTENSION, socket wrench

HANDLE, socket wrench

JACK, 12-ton (2)

PINCH BAR

WRENCH, end, $\frac{3}{4}$ -in.

WRENCH, end, $2\frac{1}{4}$ -in.

WRENCH, end, $2\frac{5}{16}$ -in.

WRENCH, socket, $\frac{3}{4}$ -in.

(2) PROCEDURE.

(a) Support Bogie Roller Frames (fig. 67).

CHAIN, with turnbuckles

Hook one end of the chain to one of the bogie roller frame shafts. Pass the other end of the chain over the top of the bogie frame bracket (underneath the top roller) and hook it onto the adjacent bogie roller frame shaft. Take all slack out of chain by tightening the turnbuckles.

(b) Raise Vehicle.

JACK, 12-ton (2)

Place the jacks under the frame side rail just back of the bogie frame bracket. Raise the vehicle until the bogie rollers are 5 or 6 inches above the floor. The chain will keep the bogie rollers and springs in their normal running position.

(c) Loosen Tension on Adjusting Springs (fig. 68).

WRENCH, end, $2\frac{5}{16}$ -in.

Loosen lock nut on tension screw and back off adjusting nut as far as possible.

(d) Tighten Stop Screw (fig. 69).

WRENCH, end, $2\frac{1}{4}$ -in.

BASIC HALF-TRACK VEHICLES (IHC) (PERSONNEL CARRIER M5, CAR M9A1, MULTIPLE GUN MOTOR CARRIAGE M14, AND SIMILAR IHC VEHICLES)

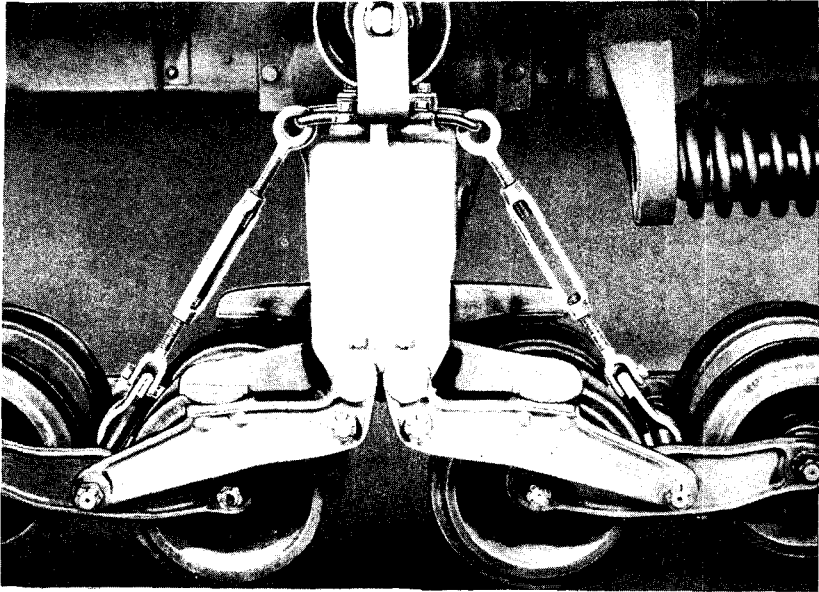

RA PD 18300

Figure 67 – Bogie Roller Assembly – Supported

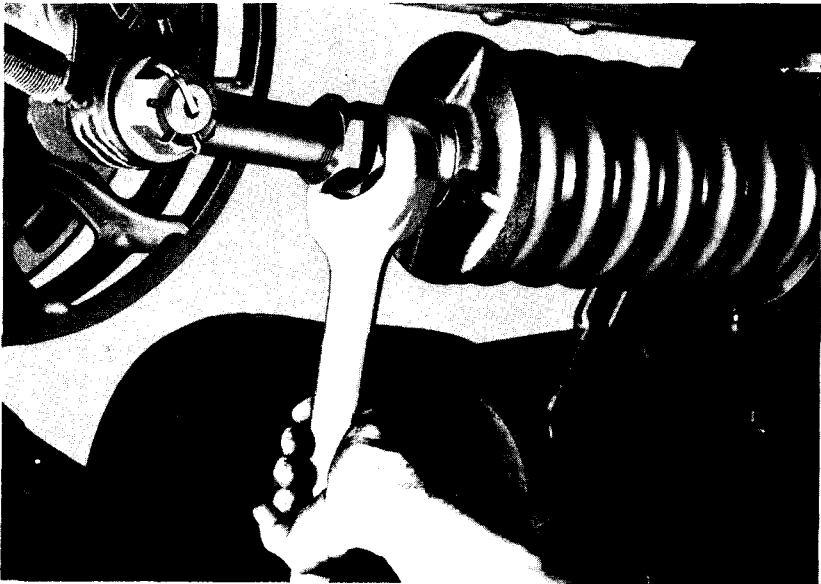

RA PD 18301

Figure 68 – Loosening Tension on Adjusting Screw

BOGIE SUSPENSION AND TRACK

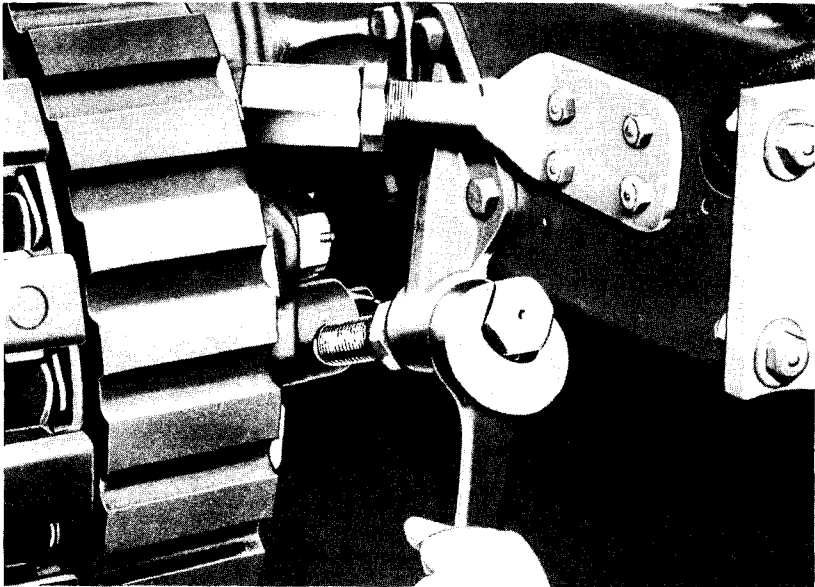

RA PD 18302

Figure 69 — Tightening Stop Screw

Loosen lock nut. Turn stop screw in as far as possible to compress springs and force idler forward.

(e) *Remove Track Upper Rollers (fig. 70).*

WRENCH, end, $\frac{3}{4}$ -in.

Remove four cap screws and lock washers from upper roller brackets. Remove upper roller assembly.

(f) *Remove Idler Flange.*

EXTENSION, socket wrench WRENCH, socket, $\frac{3}{4}$ -in.

HANDLE, socket wrench

Remove the six idler flange stud nuts. Remove the flange (fig. 71).

(g) *Remove Track, Using Crowbar As Slide (fig. 72).*

Use pinch bar to force track from flange.

(h) *Lower Track to Floor.*

(i) *Place Track in Position for Installation.*

Be sure to place track so that wide or outside guide flanges on ground side of the track face the front of the vehicle.

(j) *Place Track on Front and Rear Sprockets.*

(k) *Install Idler Flange.*

(l) *Turn Idler Stop Screw out of Bracket to Clear Idler Shackle.*
Lock in position with idler stop screw lock nut.

(m) *Tighten Idler Adjusting Screw.*

**BASIC HALF-TRACK VEHICLES (IHC) (PERSONNEL CARRIER M5, CAR M9A1,
MULTIPLE GUN MOTOR CARRIAGE M14, AND SIMILAR IHC VEHICLES)**

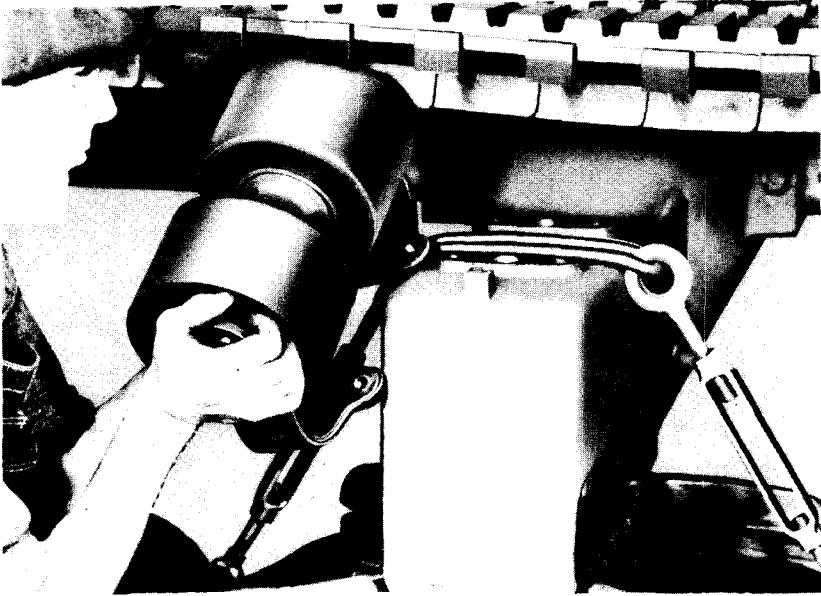

RA PD 18303

Figure 70 — Upper Rollers — Removal

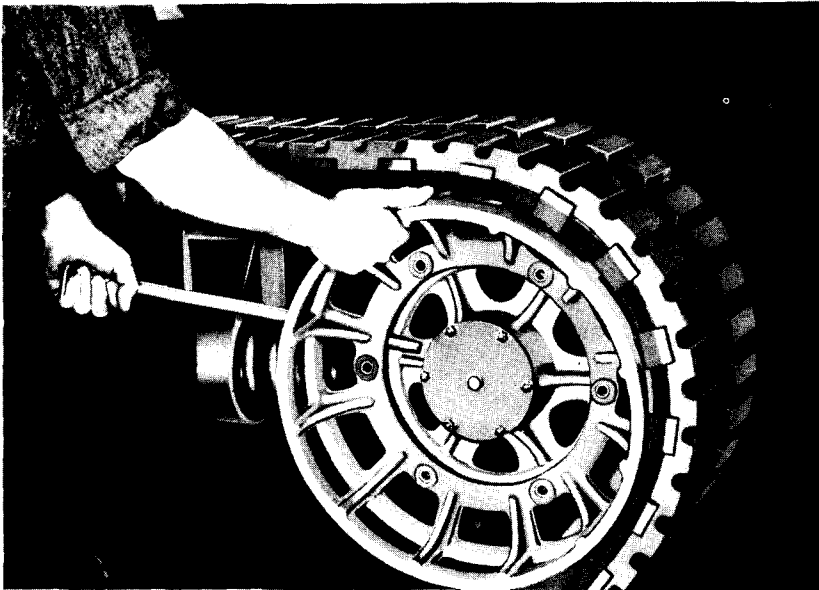

RA PD 18304

Figure 71 — Idler Flange — Removal

BOGIE SUSPENSION AND TRACK

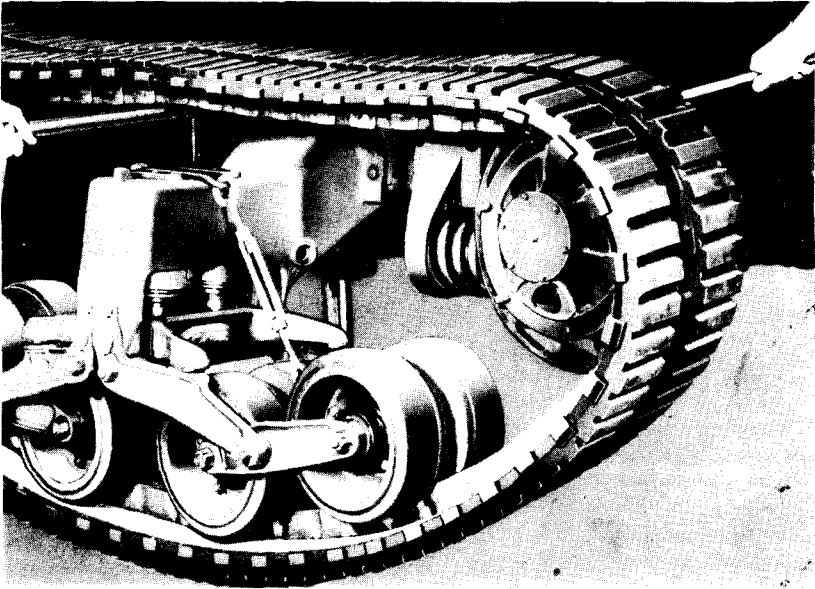

RA PD 18305

Figure 72 — Removing Track from Idler

(n) Lower Vehicle.

Remove chain and turnbuckle. Lower vehicle with jacks. Remove jacks.

(o) Adjust Track Tension (par. 57).

f. Track Maintenance.

(1) EQUIPMENT.

Use same equipment as outlined for track removal with the addition of a tension indicating wrench.

(2) PROCEDURE.

(a) Remove Track (subparagraph e (a) through (g) above).

(b) Tighten Track Guides.

After the first 500 miles of operation and every 1,000 miles thereafter, tighten each guide assembly nut with a tension indicating wrench to a stress of 285 (Ammco reading) which is equivalent to 100 foot-pounds.

(c) Inspect Track Guides.

Inspect each guide assembly and replace any damaged or excessively worn guides.

(d) Replace Track (subparagraph e (h) through (o)).

Be sure that the wide or outside guide wings on the ground side of the track face the front of the vehicle.

(e) Adjust Track (par. 57 d).

BASIC HALF-TRACK VEHICLES (IHC) (PERSONNEL CARRIER M5, CAR M9A1, MULTIPLE GUN MOTOR CARRIAGE M14, AND SIMILAR IHC VEHICLES)

56. BOGIES.

a. Description. The bogies are the supporting and conveying units for the rear of the vehicle, and are sometimes called suspensions. Shocks or vertical movements of the rollers due to rough terrain are transferred to the carrying arms and levers and are absorbed by the volute springs.

b. Bogie Wheel Rubber Wear. Bogie wheels will be removed when the rubber has worn down even with the height of the rim flanges. Bogie wheel tires which have rubber along one or both sides scooped out, due to cutting action of the track guides, need not be changed unless there is not a continuous band of rubber all the way around the center portion of the wheel.

c. Disassembly to Replace Worn or Broken Bogie Parts.

(1) EQUIPMENT.

CHAIN, with turnbuckles	STUD, 1- x 12-in. (2)
CROWBAR	WRENCH, crescent, 18-in.
DRIFT, brass	WRENCH, end, 3/4-in.
EXTENSION, socket wrench	WRENCH, end, 2 1/4-in.
HAMMER	WRENCH, end, 2 5/16-in.
HANDLE, socket wrench	WRENCH, socket, 3/4-in.
JACK, 12-ton (2)	WRENCH, socket, 7/8-in.
PINCH BAR	WRENCH, socket, 1-in.
PUNCH	WRENCH, socket, 1 1/4-in.
SCREWDRIVER, cross recess head	

(2) PROCEDURE.

(a) Remove Track (par. 55 e).

(b) Support Crab Assembly (fig. 73).

STUD, 1- x 12-in. (2) WRENCH, crescent, 18-in.

Install two special studs (1- x 12-inch threaded 14 NF on one end and 8 NC on other end) into the bogie spring block and tighten nuts to compress volute springs until bogie crab is free from bogie arm tie bolt.

(c) Remove Nuts from Bogie Arm Tie Bolts and Bogie Frame Shafts.

HANDLE, socket wrench WRENCH, socket, 1 1/4-in.

Remove eight nuts (outside and inside), frame bogie arm tie bolts, and bogie frame shafts.

BOGIE SUSPENSION AND TRACK

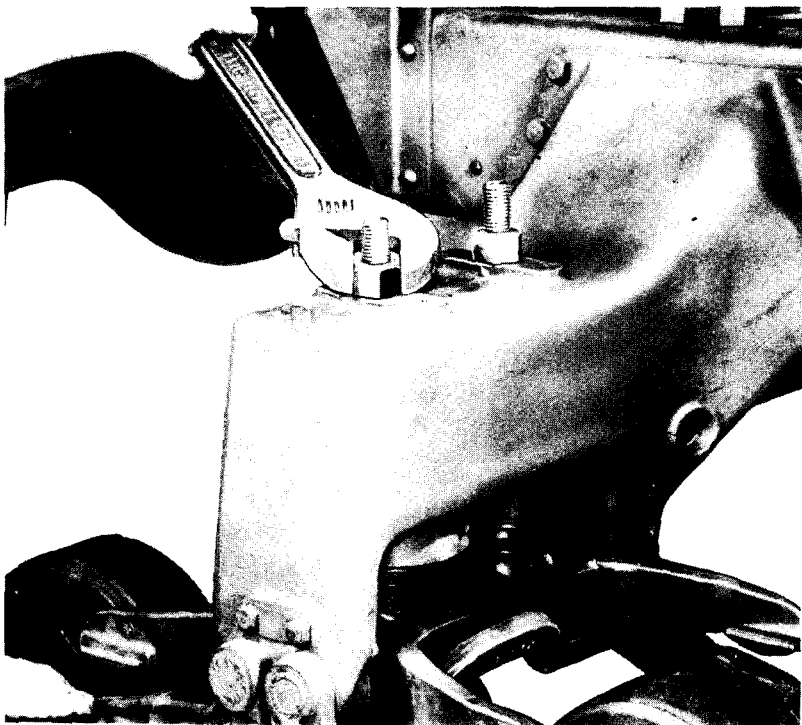

Figure 73 — Supporting Crab Assembly RA PD 18372

(d) Remove Bogie Arms.

HAMMER

PINCH BAR

Use pinch bar as pry and strike bogie frame shaft with hammer (fig. 74). Remove bogie arms and bogie arm tie bolts.

(e) Remove Both Lower Bogie Roller Assemblies (fig. 75).

(f) Remove Bogie Roller Bolt Nuts.

HANDLE, socket wrench

WRENCH, socket, 1¼-in.

Remove two (each roller assembly) nuts from bogie roller bolts.

(g) Remove Bogie Outer Frame (fig. 76).

PINCH BAR

Pry bogie outer frame away from assembly and remove.

(h) Remove Bogie Frame Shaft.

(i) Remove Bogie Inner Frame and Bogie Roller Bolts (fig. 77).

(j) Remove Bogie Roller Inner Bearing and Retainer.

DRIFT, brass

HAMMER

Using drift and hammer knock out inner bearing and retainer.

BASIC HALF-TRACK VEHICLES (IHC) (PERSONNEL CARRIER M5, CAR M9A1, MULTIPLE GUN MOTOR CARRIAGE M14, AND SIMILAR IHC VEHICLES)

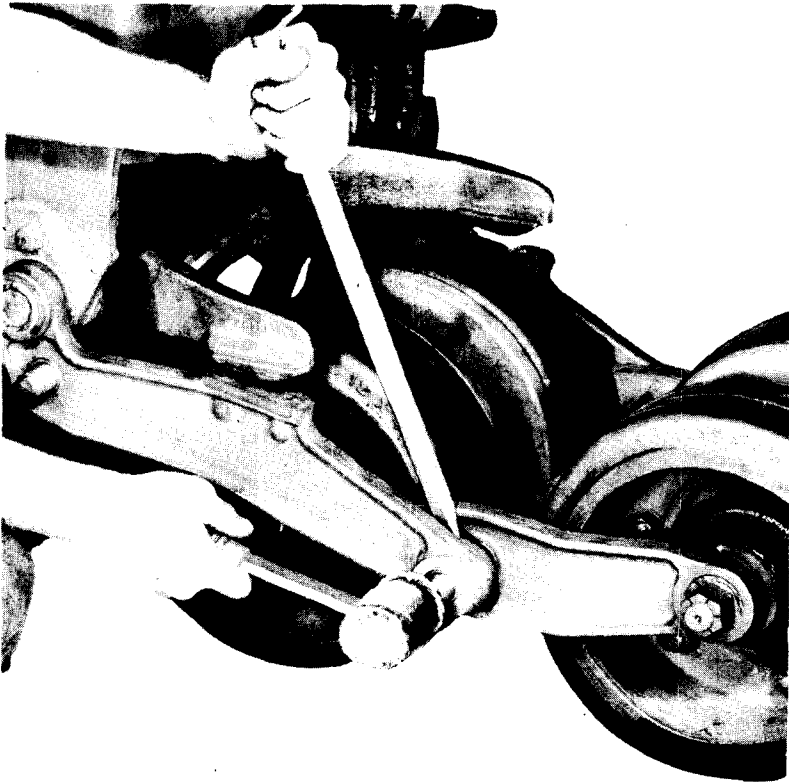

RA PD 18373

Figure 74 – Bogie Arm – Removal

(k) *Remove Bogie Roller Outer Bearing, Retainer, and Bearing Spacer (fig. 78).*

DRIFT, brass

HAMMER

Working from inside, knock out bogie roller outer bearing, retainer, and spacer.

(l) *Remove Hub Stud Nuts from Lower Bogie Roller.*

EXTENSION, socket wrench

WRENCH, socket, 3/4-in.

HANDLE, socket wrench

Remove six hub stud nuts (each roller).

(m) *Remove Bogie Roller from Hub (fig. 79).*

(n) *Lower Bogie Crab Assembly and Remove Volute Springs and Spring Seats (fig. 80).*

WRENCH, crescent, 18-in.

BOGIE SUSPENSION AND TRACK

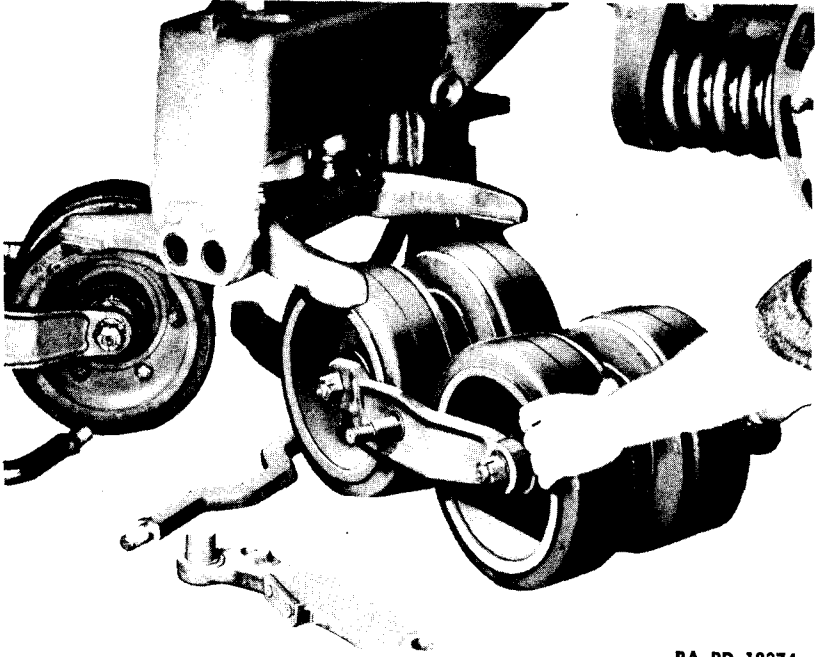

RA PD 18374

Figure 75 — Lower Bogie Roller Assembly — Removal

Loosen nuts of special retaining screws and lower crab and spring assembly. Remove springs and spring seats.

(o) *Remove Crab Guide Blocks.*

Remove retaining locks from guide blocks and lift off guide blocks from crab block pin.

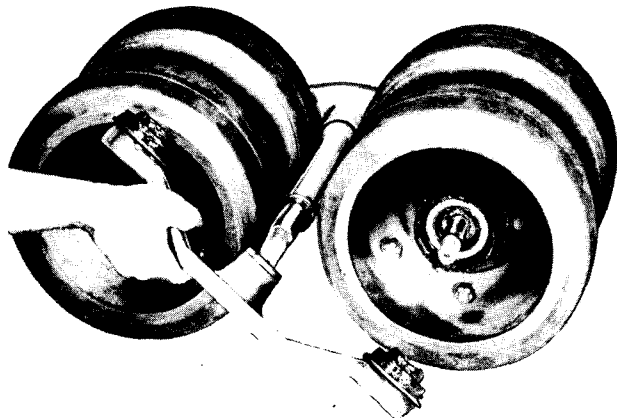

RA PD 18375

Figure 76 — Bogie Outer Frame — Removal

BASIC HALF-TRACK VEHICLES (IHC) (PERSONNEL CARRIER M5, CAR M9A1, MULTIPLE GUN MOTOR CARRIAGE M14, AND SIMILAR IHC VEHICLES)

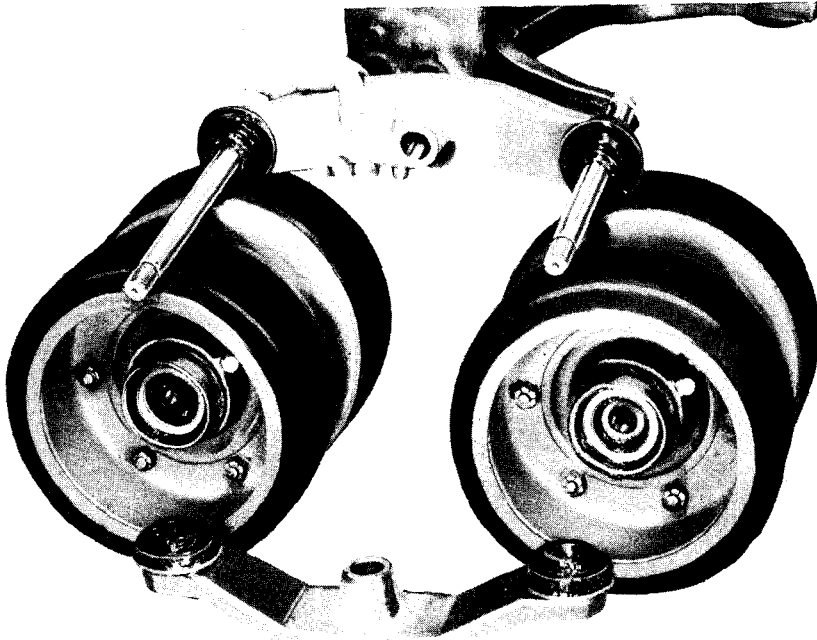

RA PD 18376

Figure 77 — Bogie Inner Frame — Removal

(p) *Remove Crab Block Pin From Crab Block (fig. 81).*

HAMMER

Using hammer, knock crab block pin out of assembly toward Woodruff key end (inner side). Remove block.

(q) *Remove Crab Slide Screws.*

SCREWDRIVER, cross recess head

Remove two cross recess head screws from each (four) crab slide.

(r) *Remove Bogie Arm Plates.*

SCREWDRIVER, cross recess head

Remove two cross recess head screws from each of the four bogie arm plates.

(s) *Remove Bogie Crab Slides (fig. 82).*

HAMMER

WRENCH, 3/4-in.

SCREWDRIVER

Straighten lock plate and remove two cap screws each side. Remove crab slides.

BOGIE SUSPENSION AND TRACK

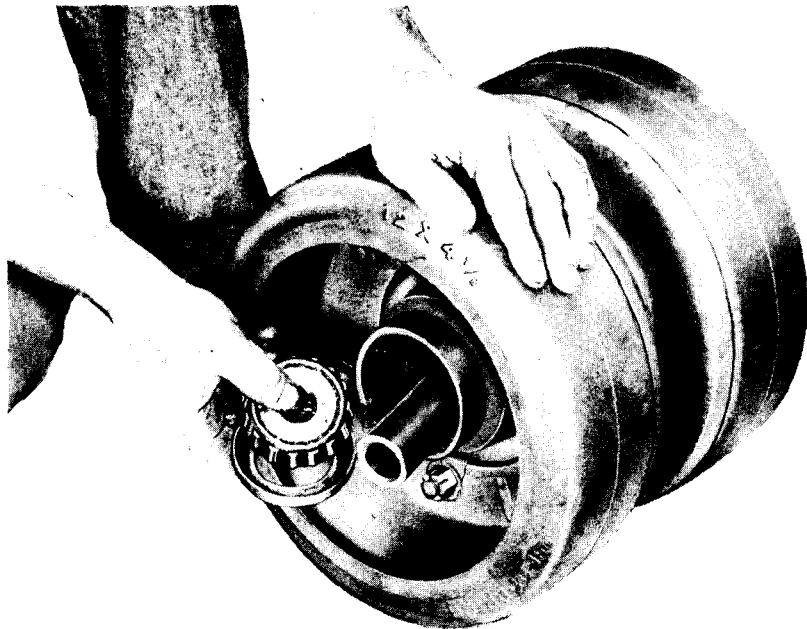

RA PD 18377

Figure 78 – Bogie Roller Bearings – Removal

(t) *Remove Bogie Frame Brackets and Cross Tube.*

HANDLE, socket wrench

WRENCH, socket, $\frac{7}{8}$ -in.

WRENCH, end, 1-in.

Remove six bolts from frame bracket to side rail. Remove two bolts from frame bracket at frame flange (each side of vehicle). Remove frame bracket and cross tube assembly.

d. Bogie Reassembly.

(1) **EQUIPMENT.**

Use same equipment as outlined in subparagraph c (1) above.

(2) **PROCEDURE.**

(a) *Install Bogie Frame Brackets and Cross Tube.*

(b) *Install Bogie Crab Slides.*

(c) *Install Bogie Arm Plates.*

(d) *Install Crab Block Pin in Crab Block.*

(e) *Install Crab Guide Blocks.*

(f) *Place Crab Assembly and Springs in Position.*

Draw into place with special screws.

**BASIC HALF-TRACK VEHICLES (IHC) (PERSONNEL CARRIER M5, CAR M9A1,
MULTIPLE GUN MOTOR CARRIAGE M14, AND SIMILAR IHC VEHICLES)**

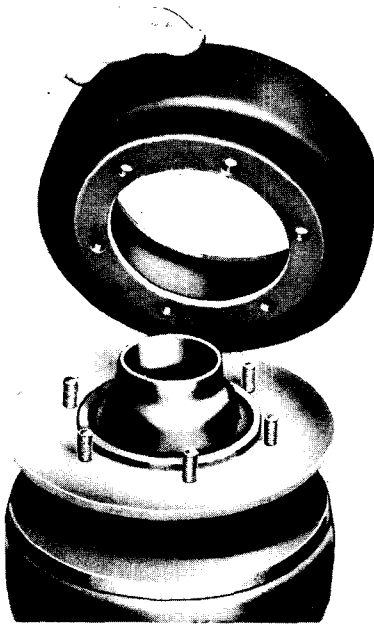

RA PD 18378

Figure 79 – Bogie Roller Removed from Hub

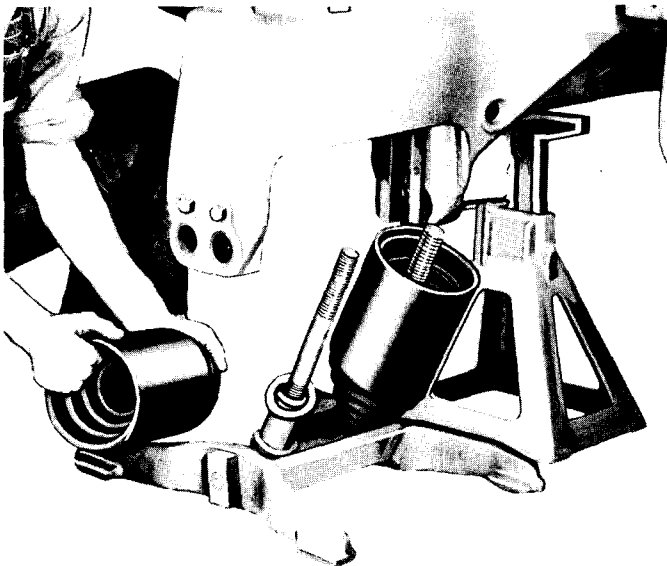

RA PD 18379

Figure 80 – Crab Assembly – Removal

BOGIE SUSPENSION AND TRACK

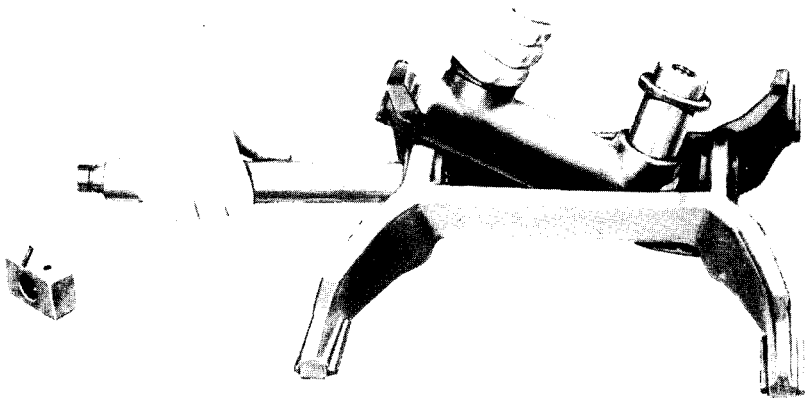
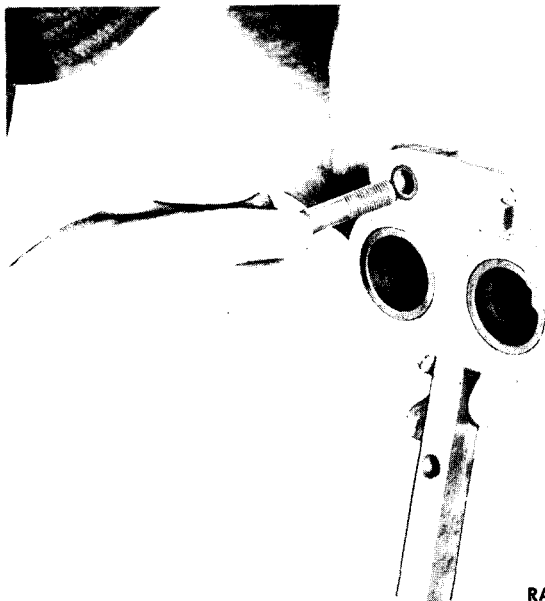

Figure 81 — Crab Block Pin — Removal

RA PD 18380

- (g) *Install Bogie Rollers on Hubs.*
Install stud nuts.
- (h) *Install Bogie Roller Inner and Outer Bearings, Spacer, and Retainers.*
- (i) *Install Bogie Roller Bolts and Inner Frame.*
- (j) *Install Bogie Frame Shaft and Outer Frame.*



RA PD 18381

Figure 82 — Bogie Crab Slides — Removal

BASIC HALF-TRACK VEHICLES (IHC) (PERSONNEL CARRIER M5, CAR M9A1, MULTIPLE GUN MOTOR CARRIAGE M14, AND SIMILAR IHC VEHICLES)

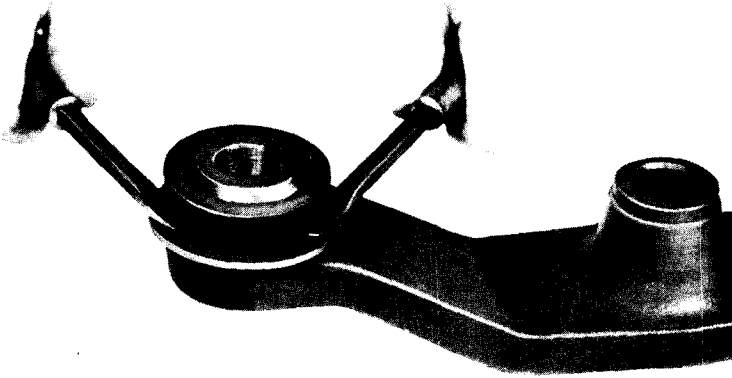

RA PD 18227

Figure 83 — Bogie Arm Seal — Removal

- (k) *Install Bogie Roller Bolt Nuts.*
- (l) *Place Bogie Roller Assemblies in Position.*
- (m) *Install Inner and Outer Bogie Arms and Bogie Tie Bolts.*
- (n) *Install Nuts on Bogie Tie Bolts and Bogie Frame Shafts.*
- (o) *Install Track (par. 55 e).*
- (p) *Adjust Track (par. 57 d).*

e. Bogie Maintenance.

(1) BOGIE ROLLER BEARING REPLACEMENT.

(a) Equipment.

Use equipment listed under paragraph 56 c (1) above, plus the following:

SCREWDRIVER (2) SLEEVE, adapter

(b) *Remove Bogie Wheel Assemblies (par. 56 c (2) (a) through (i)).*

(c) *Remove Inner Grease Seal Retainers and Bearing Roller Assemblies by Means of a Bearing Pulley or Drift (fig. 78).*

DRIFT HAMMER

Use drift and remove bearing roller assemblies, spacer, and retainers.

(d) *Remove Bearing Cups.*

HAMMER PUNCH

Use a punch and hammer and remove bearing cups.

BOGIE SUSPENSION AND TRACK

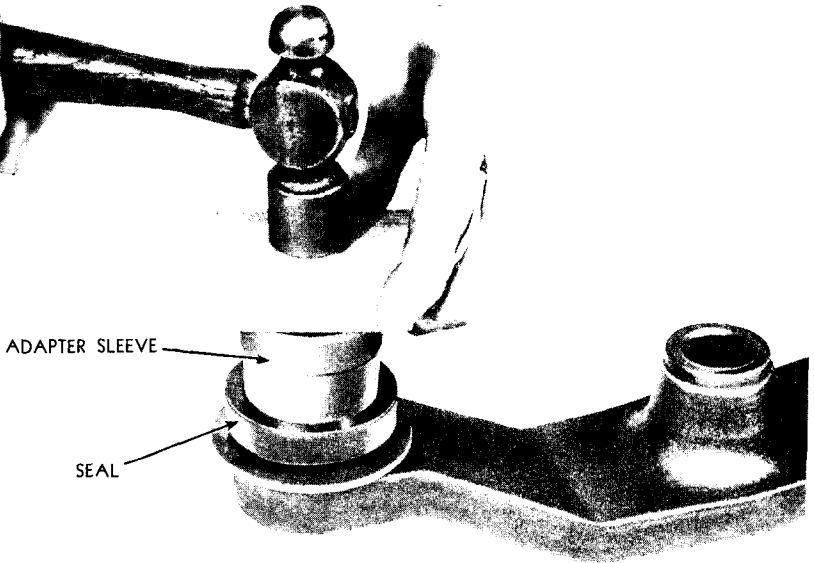

RA PD 18228

Figure 84 — Bogie Arm Seal — Installation

(e) *Remove Grease Seals from Bogie Roller Frames (fig. 83).*

SCREWDRIVER (2)

Pry off grease seals and retainers. If damaged, discard and replace with new seals.

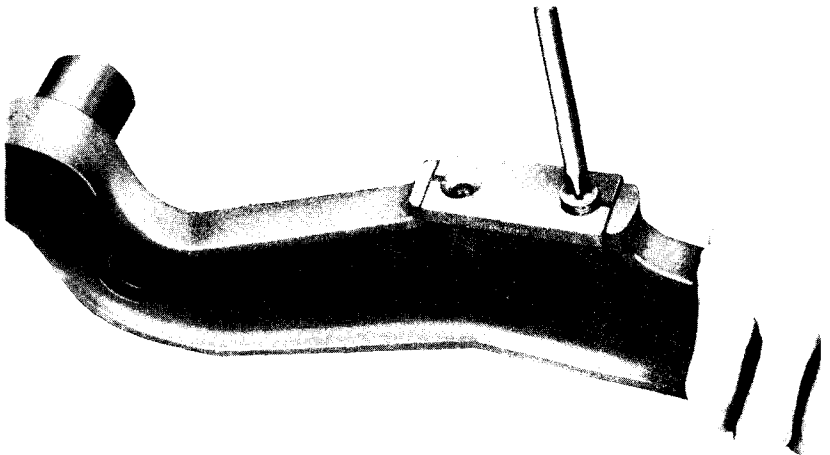

RA PD 18229

Figure 85 — Bogie Arm Wear Plate — Removal

BASIC HALF-TRACK VEHICLES (IHC) (PERSONNEL CARRIER M5, CAR M9A1, MULTIPLE GUN MOTOR CARRIAGE M14, AND SIMILAR IHC VEHICLES)



RA PD 18382

Figure 86 – Idler Cap and Gasket – Removal

(f) *Install New Grease Seals* (fig. 84).

SLEEVE, adapter

Using an adapter sleeve, install new seal assemblies onto bogie roller frames.

(g) *Install Bearing Cups.*

ADAPTER

DRIFT, brass

Install bearing cups in bogie wheel hubs.

(h) *Install Bearing Cones and Inner Seal Retainers.*

(i) *Install Bogie Wheel Assemblies* (par. 56 d (2) (j) through (p)).

(2) **CRAB SLIDE AND WEAR PLATE REPLACEMENT.**

(a) *Equipment.*

Use equipment listed under paragraphs 55 e (1) and 56 c (1) plus the following:

SCREWDRIVER, cross recess head

(b) *Disassemble Bogie* (par. 56 c (2) (a) through (d)).

BOGIE SUSPENSION AND TRACK

(c) *Remove Crab Slides and Plates* (fig. 85).

SCREWDRIVER, cross recess head

Remove crab slides and plates by removing holding screws.

(d) *Install Crab Slides and Plates.*

(e) *Reassemble Bogie* (par. 56 d).

57. ADJUSTING IDLERS.

a. **Description.** A steel idler wheel is mounted at the rear of each track. Its purpose is to support the track. Each idler is provided with an adjusting mechanism for adjusting and controlling the tension of its respective track.

b. Idler and Track Tension Mechanism Removal.

(1) EQUIPMENT.

CHAIN, with turnbuckles	WRENCH, $\frac{7}{8}$ -in.
CROWBAR	WRENCH, 1-in.
DRIFT, brass	WRENCH, 2 $\frac{1}{2}$ -in.
EXTENSION, socket wrench	WRENCH, crescent, 18-in.
HAMMER	WRENCH, end, $\frac{3}{4}$ -in.
HAMMER, heavy	WRENCH, end, 1 $\frac{7}{16}$ -in.
HANDLE, socket wrench	WRENCH, end, 1 $\frac{3}{16}$ -in.
JACK, 12-ton (2)	WRENCH, end, 1 $\frac{7}{8}$ -in.
PINCH BAR	WRENCH, end, 2 $\frac{1}{4}$ -in.
PLIERS	WRENCH, end, 2 $\frac{5}{16}$ -in.
PULLER	WRENCH, socket, $\frac{3}{4}$ -in.
PUNCH	

(2) PROCEDURE.

(a) *Remove Track* (par. 55 e).

(b) *Remove Idler Cap.*

EXTENSION, socket wrench	WRENCH, socket, $\frac{3}{4}$ -in.
HANDLE, socket wrench	

Remove six nuts holding idler cap to hub. Remove cap and gasket (fig. 86).

(c) *Remove Idler Bearing Nut and Lock Washer* (fig. 87).

HAMMER	PUNCH
--------	-------

Remove bearing lock nut and lock washer.

(d) *Remove Idler* (fig. 88).

PULLER	WRENCH, crescent, 18-in.
--------	--------------------------

Using puller, remove idler and bearing assembly.

BASIC HALF-TRACK VEHICLES (IHC) (PERSONNEL CARRIER M5, CAR M9A1, MULTIPLE GUN MOTOR CARRIAGE M14, AND SIMILAR IHC VEHICLES)

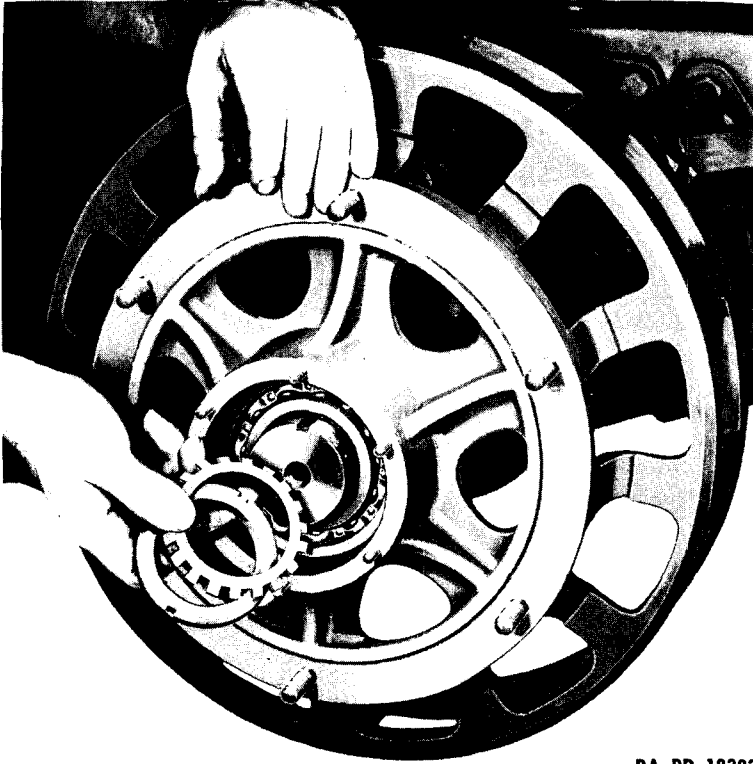

RA PD 18383

Figure 87 — Idler Bearing Nut and Lock — Removal

(e) *Remove Outer Bearing.*

DRIFT, brass

HAMMER

Move center spacer out of position and using drift and hammer, remove outer bearing.

(f) *Remove Inner Bearing and Seal (fig. 89).*

HAMMER

PUNCH

Striking against outer race, remove grease seal and inner bearing.

(g) *Release Tension on Stop Screw.*

WRENCH, end, $1\frac{3}{16}$ -in.

Release tension on idler stop screw.

(h) *Remove Nut from Tension Screw Taper Pin.*

WRENCH, end, $1\frac{7}{16}$ -in.

Remove nut from tension screw taper pin.

BOGIE SUSPENSION AND TRACK

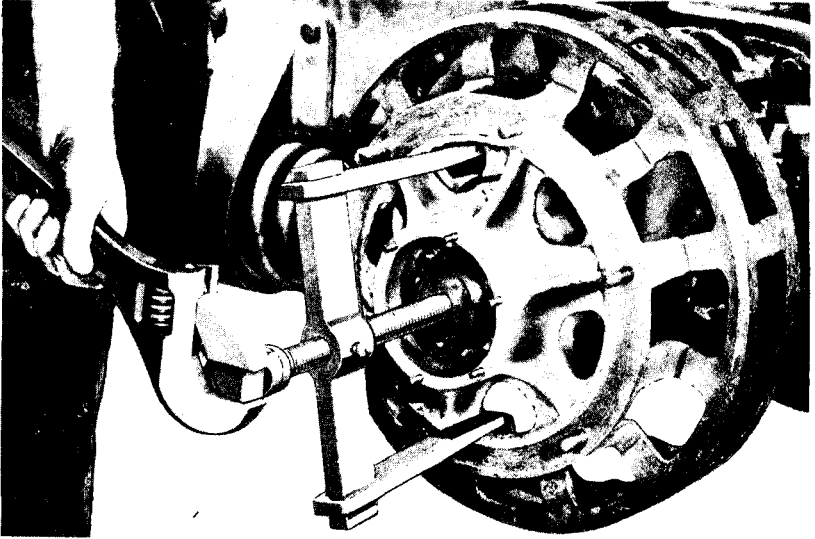

Figure 88 – Idler – Removal

RA PD 18384

(i) Remove Tension Screw from Shackle.

If necessary, remove lubricator and strike end of tension screw taper pin to knock out of shackle.



Figure 89 – Inner Bearing and Seal – Removal

RA PD 18385

**BASIC HALF-TRACK VEHICLES (IHC) (PERSONNEL CARRIER M5, CAR M9A1,
MULTIPLE GUN MOTOR CARRIAGE M14, AND SIMILAR IHC VEHICLES)**

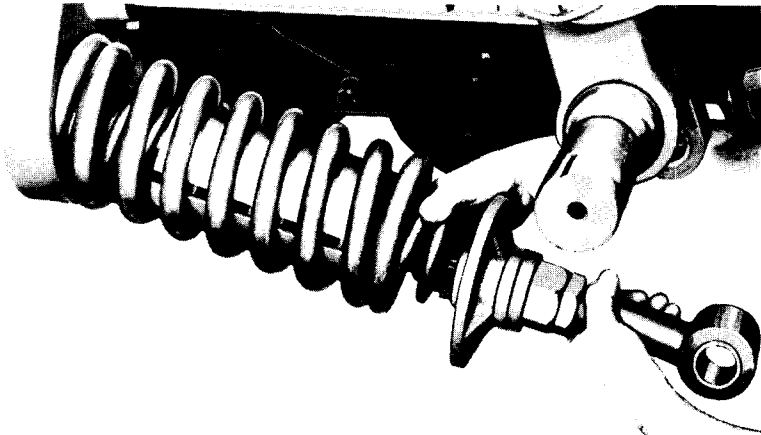

RA PD 18386

Figure 90 — Tension Screw and Springs — Removal

(j) *Lift Out Tension Screw and Springs (fig. 90).*

(k) *Remove Idler Post Nut and Cotter Key.*

PLIERS

WRENCH, 2½-in.

Remove cotter key and remove shackle shaft nut.

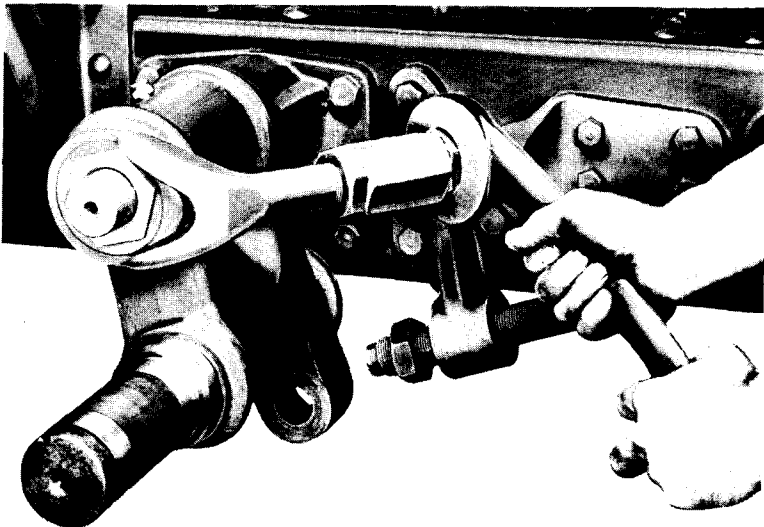

RA PD 18387

Figure 91 — Loosening Idler Post Brace Lock Nuts

BOGIE SUSPENSION AND TRACK

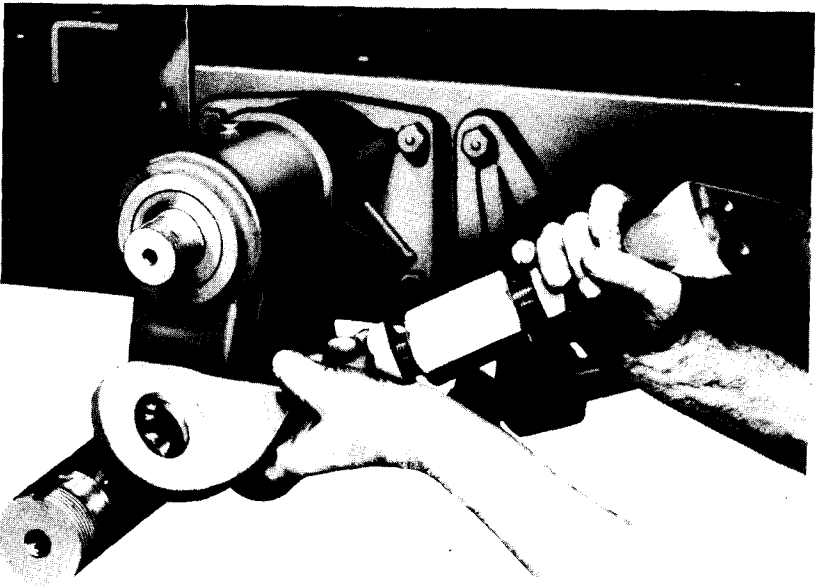

RA PD 18388

Figure 92 — Idler Post Brace — Removal

(l) *Loosen Idler Post Brace Lock Nuts and Loosen Adjusting Nut (fig. 91).*

WRENCH, end, $1\frac{1}{8}$ -in.

Loosen lock nuts and adjusting nut of idler post brace.

(m) *Remove Idler-Post-Brace-to-Frame Bolts.*

WRENCH, $\frac{3}{4}$ -in.

Remove four bolts, nuts, and washers holding brace to frame.

(n) *Remove Idler Post Brace (fig. 92).*

(o) *Remove Shackle and Idler Shaft.*

(p) *Remove Bolts from Idler Stop Screw Bracket to Frame.*

WRENCH, $\frac{7}{8}$ -in.

WRENCH, 1-in.

Remove three bolts, nuts, and washers from idler stop screw bracket to frame.

(q) *Remove Idler Stop Screw and Bracket (fig. 93).*

(r) *Remove Track Tension Spring Support Bracket Bolts.*

WRENCH, $\frac{7}{8}$ -in.

WRENCH, 1-in.

Remove four bolts, nuts, and washers from tension spring support bracket to frame.

(s) *Remove Bracket.*

BASIC HALF-TRACK VEHICLES (IHC) (PERSONNEL CARRIER M5, CAR M9A1, MULTIPLE GUN MOTOR CARRIAGE M14, AND SIMILAR IHC VEHICLES)

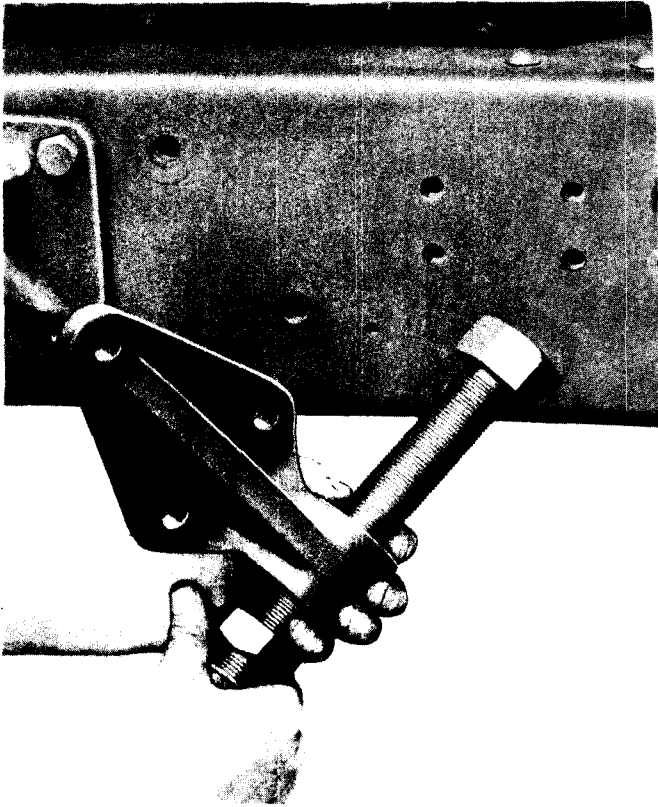

RA PD 18389

Figure 93 — Idler Stop Screw and Bracket — Removal

c. Idler and Track Tension Mechanism Installation.

(1) EQUIPMENT.

Use same equipment as listed for removal in subparagraph b above.

(2) PROCEDURE.

(a) Install Tension Spring Bracket and Bolts at Frame.

(b) Install Idler Stop Screw Bracket and Bolts at Frame.

(c) Install Idler Shackle and Shaft on Idler Post.

(d) Install Shackle Idler Post Brace and Bolts at Frame.

(e) Install Idler Post Nut and Cotter Pin.

(f) Tighten Idler Post Brace Adjusting Nut to Pull Idler Post Back at End $\frac{1}{16}$ -inch.

Tighten lock nuts securely.

BOGIE SUSPENSION AND TRACK

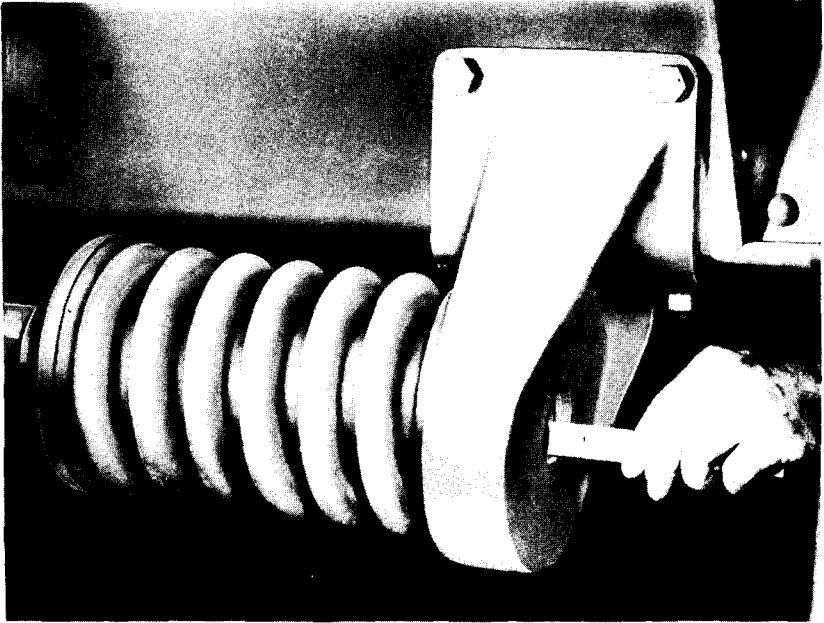

Figure 94 — Measuring Casting Depth

RA PD 18306

- (g) *Place Tension Screw and Spring Assembly in Position and Insert Tension Screw Taper Pin in Shackle.*
- (h) *Install Tension Screw Taper Pin Nut.*
- (i) *Tighten Idler Stop Screw to Compress Tension Springs.*
- (j) *Install Idler Bearings, Spacer, and Seal.*
- (k) *Install Idler and Install Lock Washer and Lock Nut.*
- (l) *Install Idler Cap and Gasket.*
- (m) *Install Track (par. 55).*
- (n) *Adjust Track (subpar. d below).*

d. Track Adjustment.

Proper tension of the track is maintained by means of the adjusting idler mechanism. Correct band track tension is defined as that track tension which allows a 150-pound load, placed on the center of the track midway between the top roller and the idler, to produce a $\frac{3}{4}$ -inch deflection or sag, measured between the top surface of the track and a straight line tangent to the top surface of the track at the top roller and the idler. The tension of the track is governed by the tension springs, which, when correctly adjusted, have a compressed length of from $13\frac{3}{8}$ inches to $13\frac{5}{8}$ inches. Track tension is increased by moving the track idler to the rear and decreased by moving the idler forward. The correct idler

BASIC HALF-TRACK VEHICLES (IHC) (PERSONNEL CARRIER M5, CAR M9A1, MULTIPLE GUN MOTOR CARRIAGE M14, AND SIMILAR IHC VEHICLES)

spring length for the double spring (D-78145), measured from the front side of the spring bracket to the front side of the rear spring seat washer, is as follows:

NO PAYLOAD	HALF PAYLOAD	FULL PAYLOAD
13 ³ / ₈ in.	13 ¹ / ₂ in.	13 ⁵ / ₈ in.

(1) **EQUIPMENT.**

RULER	WRENCH, end, 2 ¹ / ₄ -in.
SCALE	WRENCH, end, 2 ⁵ / ₁₆ -in.

(2) **PROCEDURE.**

(a) *Loosen Idler Stop Screw Lock Nut and Stop Screw.*

WRENCH, end, 2¹/₄-in.

Loosen idler stop screw lock nut and stop screw.

(b) *Adjust Track Tension.*

RULER	WRENCH, end, 2 ⁵ / ₁₆ -in.
SCALE	

Measure depth of casting at hole in spring support bracket (fig. 94). Transfer this measurement to outside of casting and mark distance. Adjust spring tension by tightening adjusting screw nut until springs are compressed to a length of from 13³/₈ inches to 13⁵/₈ inches, according to payload as indicated above (fig. 95).

(c) *Tighten Adjusting Screw Lock Nut.*

(d) *Adjust Idler Stop Screw.*

WRENCH, end, 2¹/₄-in.

Place lock nut at lower end of stop screw. Turn screw all the way out of bracket to the lock nut. Tighten lock nut securely.

(e) Recheck spring tension after every 1,000 miles of operation by measuring spring length as indicated above, or by measuring deflection or sag, as defined in first part of this paragraph.

e. Idler Bearing Replacement.

(1) **EQUIPMENT.**

CHAIN, with turnbuckles	PINCH BAR
CROWBAR	PUNCH
DRIFT, brass	WRENCH, end, 3/4-in.
EXTENSION, socket wrench	WRENCH, end, 2 ¹ / ₄ -in.
HAMMER	WRENCH, end, 2 ⁵ / ₁₆ -in.
HANDLE, socket wrench	WRENCH, socket, 3/4-in.
JACK, 12-ton (2)	

BOGIE SUSPENSION AND TRACK

(2) PROCEDURE.

(a) *Remove Idler and Bearing Assembly* (par. 57 b (2), substeps (a) through (d)).

(b) *Remove Bearings, Spacer, and Seal.*

DRIFT, brass HAMMER

Remove bearings, spacer, and seal from idler (par. 57 c (2), substeps (e) and (f)).

(c) *Install Bearings, Spacer, and Seal.*

DRIFT, brass HAMMER

Install bearings, spacer, and seal. If grease seal is damaged or defective, install a new seal.

(d) *Install Idler.*

(e) *Install Bearing Nut and Lock Washer.*

HAMMER PUNCH

Install lock washer and install bearing nut.

58. TRACK SUPPORTING ROLLERS.

a. **Description.** A steel roller mounted on brackets is bolted to the top of each bogie frame bracket. It supports the returning track.

b. Bearing and Seal Replacement.

(1) EQUIPMENT.

DRIFT, brass	SLEEVE, adapter
HAMMER	WRENCH, end, 3/4-in.
HANDLE, socket wrench	WRENCH, end, 2 1/4-in.
PULLER, bearing	WRENCH, end, 2 5/16-in.
SCREWDRIVER (2)	WRENCH, socket, 3/4-in.

(2) PROCEDURE.

(a) *Loosen Track Tension.*

WRENCH, end, 2 1/4-in. WRENCH, end, 2 5/16-in.

Loosen adjusting screw lock nut. Loosen adjusting screw adjusting nut. Loosen stop screw lock nut. Turn stop screw toward adjusting screw to release tension on track.

(b) *Remove Supporting Roller Assembly.*

WRENCH, end, 3/4-in.

Remove two bolts from each upper roller bracket to top of bogie frame bracket. Remove roller assembly.

**BASIC HALF-TRACK VEHICLES (IHC) (PERSONNEL CARRIER M5, CAR M9A1,
MULTIPLE GUN MOTOR CARRIAGE M14, AND SIMILAR IHC VEHICLES)**

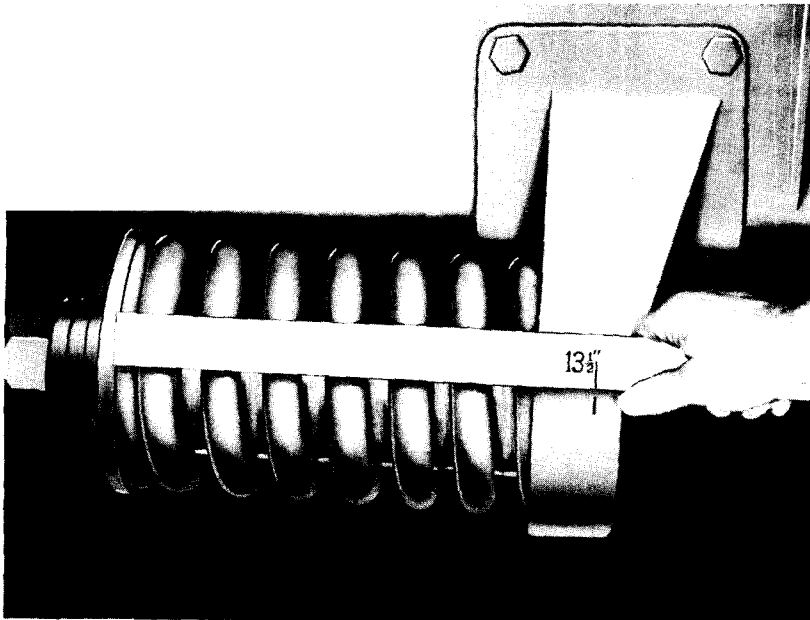

RA PD 18528

Figure 95 — Measuring Compressed Springs

(c) Remove End Brackets.

DRIFT, brass

HANDLE, socket wrench

HAMMER

WRENCH, socket, 3/4-in.

Remove upper roller bolt nut.

(d) Remove End Bracket and Seal (fig. 96).

(e) Remove Opposite End Bracket and Bolt.

DRIFT, brass

HAMMER

Remove upper roller bolt and opposite end bracket, using drift and hammer.

(f) Remove Bolt from End Bracket.

DRIFT, brass

HAMMER

Remove bolt from end bracket, using drift and hammer.

(g) Remove Seals from End Brackets (fig. 97).

SCREWDRIVER (2)

Remove seals from end bracket using two screwdrivers to raise seal and retainer assembly.

BOGIE SUSPENSION AND TRACK

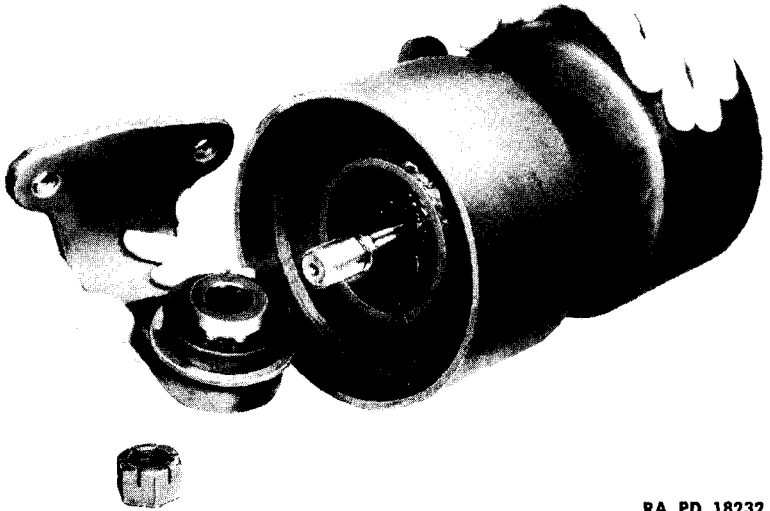

RA PD 18232

Figure 96 – Upper Roller Bracket – Removal

(h) Remove Bearing Cones and Retainers.

DRIFT, brass

HAMMER

Knock out one bearing cone and retainer. Invert roller and repeat for opposite bearing cone and retainer.



RA PD 18235

Figure 97 – Upper Roller Seal – Removal

BASIC HALF-TRACK VEHICLES (IHC) (PERSONNEL CARRIER M5, CAR M9A1, MULTIPLE GUN MOTOR CARRIAGE M14, AND SIMILAR IHC VEHICLES)

(i) *Remove Bearing Cups.*

PULLER, bearing

Use bearing puller and remove bearing cups.

(j) *Install Bearing Cups.*

(k) *Install Bearing Spacer.*

(l) *Install Bearing Cones and Bearing Retainers.*

(m) *Install Seal Assemblies on End Brackets.*

SLEEVE, adapter

Install seals on end brackets using adapter sleeve to avoid damage to seals.

(n) *Install End Brackets.*

(o) *Install Upper Roller Bolt and Nut.*

(p) *Install Upper Roller Assembly on Bogie Frame Bracket.*

(q) *Adjust Track Tension (par. 57 d).*

Section XIII

BRAKE SYSTEMS

	Paragraph
Description	59
Trouble shooting	60
Master cylinder	61
Vacuum power unit (Hydrovac).....	62
Service brake shoes	63
Service brake pedal linkage	64
Service brake adjustments	65
Bleeding the lines	66
Drive shaft brake	67
Electric trailer brake controller	68

59. DESCRIPTION (fig. 98).

a. The service brakes on the front wheels and on the rear axle driving sprockets are actuated under the control of a hydraulic system comprising the foot brake pedal, linkage, a master cylinder, a vacuum power cylinder (Hydrovac), brake lines, wheel cylinders, and brake shoes. A disk type mechanical brake for parking only is mounted on a companion flange of the rear drive shaft. An electric trailer brake controller is provided to control the brakes on a towed load.

60. TROUBLE SHOOTING.

a. Hydraulic System.

Possible Cause	Possible Remedy
(1) PEDAL STRIKING FLOOR BOARD.	
Lining wear.	Adjust brakes, minor adjustment only (par. 65 a (1) and (2)).
Incorrectly adjusted brake shoes.	Adjust brakes, major adjustment (par. 65 a (3) and (4)).
Improper pedal adjustment.	Adjust pedal free travel (par. 64 a (1)).
Hydraulic system leaks.	Check and tighten connections.
Air in hydraulic system (indicated by spongy pedal action).	Bleed brake system (par. 66 a (1) and (2)).
Insufficient brake fluid.	Refill master cylinder (par. 61).

**BASIC HALF-TRACK VEHICLES (IHC) (PERSONNEL CARRIER M5, CAR M9A1,
MULTIPLE GUN MOTOR CARRIAGE M14, AND SIMILAR IHC VEHICLES)**

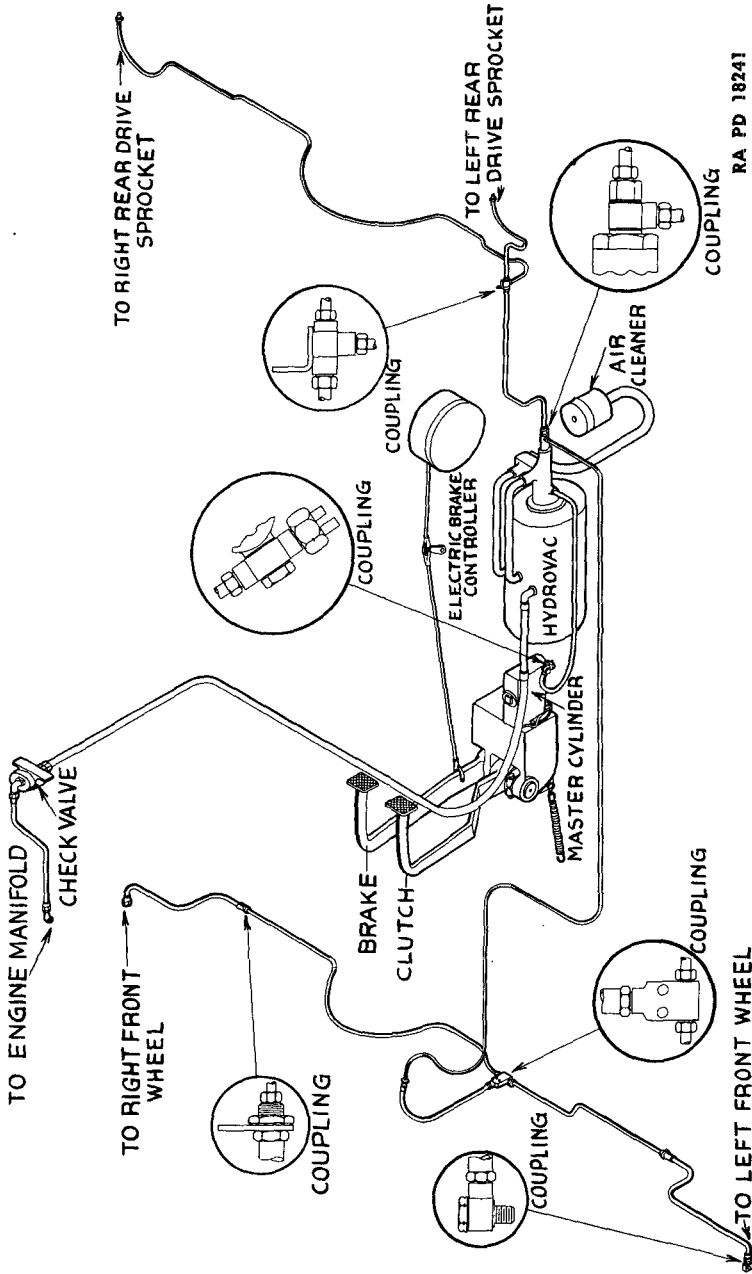

Figure 98 — Schematic Diagram of Brake System

BRAKE SYSTEMS

(2) ALL BRAKES DRAG.

Possible Cause	Possible Remedy
Insufficient brake shoe clearance.	Adjust brakes, minor adjustment (par. 65 a (1) and (2)).
Improper fluid in system.	Flush system and replace wheel cylinders, etc.; report to ordnance personnel.
Improper pedal adjustment.	Adjust pedal free travel (par. 64 a (1)).
Weak pedal return spring.	Replace spring.

(3) ONE BRAKE DRAGS.

Ineffective brake shoe return spring.	Replace shoe return spring.
Shoe binding on anchor pin.	Free up and lubricate.
Insufficient brake shoe clearance.	Adjust brakes, minor adjustment (par. 65 a (1) and (2)).
Loose wheel bearings.	Adjust wheel bearings (par. 152).
Grease on linings.	Replace brake shoes.

(4) PULLING TO ONE SIDE.

Improper brake adjustment.	Adjust brakes, minor adjustment (par. 65 a (1) and (2)).
Grease on linings.	Replace brake shoes (par. 63 b).
Worn linings.	Replace brake shoes (par. 63 b or c).

(5) EXCESSIVE PEDAL PRESSURE REQUIRED FOR STOPPING.

Improperly adjusted brakes.	Adjust brakes (par. 65 a (1) and (2)).
-----------------------------	----------------------------------------

(6) TOO LITTLE PRESSURE REQUIRED FOR STOPPING.

Improperly adjusted brakes.	Adjust brakes (par. 65 a (1) and (2)).
-----------------------------	----------------------------------------

(7) NOISY BRAKES.

Bent or distorted brake shoes.	Replace brake shoes (par. 63 b or c).
Dirt in linings.	Clean linings.
Loose lining rivets.	Replace brake shoes (par. 63 b or c).

**BASIC HALF-TRACK VEHICLES (IHC) (PERSONNEL CARRIER M5, CAR M9A1,
MULTIPLE GUN MOTOR CARRIAGE M14, AND SIMILAR IHC VEHICLES)**

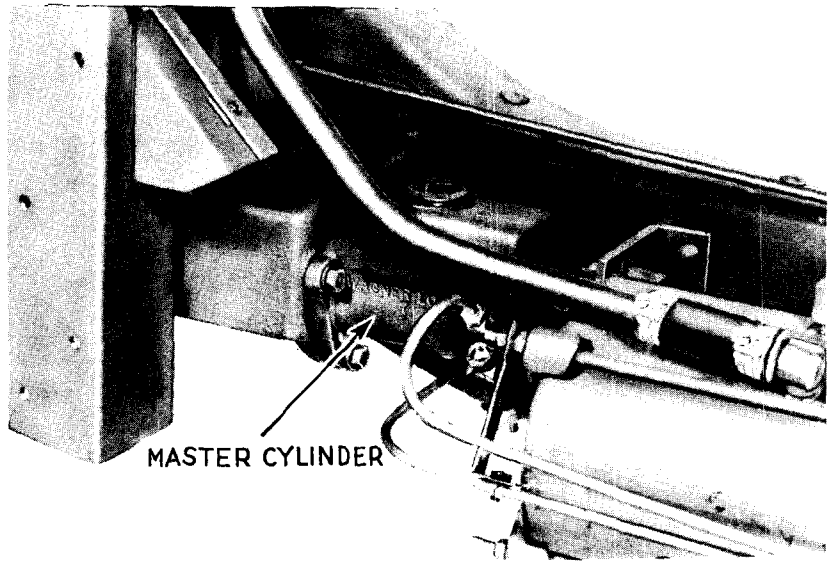

RA PD 18253

Figure 99 – Master Cylinder – Installed

b. Drive Shaft Brake System.

(1) BRAKE DOES NOT HOLD.

Brake shoes not properly mounted.

Correct mounting (par. 67 c).

Brake not properly adjusted.

Adjust brake (par. 67 b).

Linings worn out.

Replace brake shoes (par. 67 c).

61. MASTER CYLINDER (fig. 99).

a. Description. The master cylinder stores the fluid to actuate the service brakes under control of the brake pedal.

b. Servicing. The level of the fluid in the master cylinder supply tank should be inspected at least once a month. The proper level of the liquid is $\frac{3}{4}$ inch below the top of the tank. There should be practically no loss of fluid in the operation of the brakes. Any noticeable loss indi-

BRAKE SYSTEMS

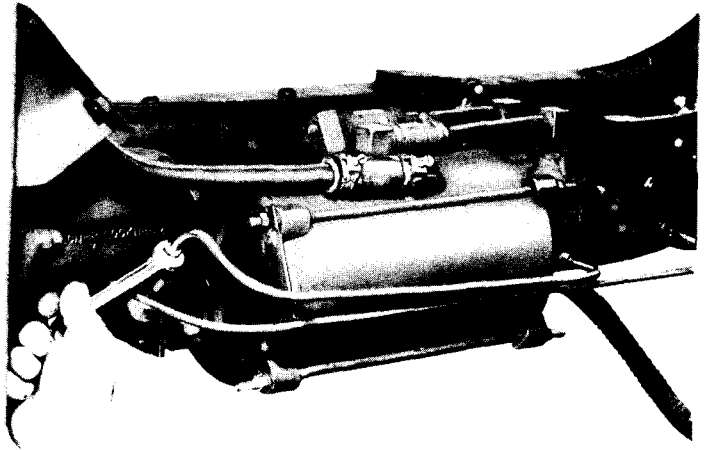

RA PD 18254

Figure 100 — Disconnecting Brake Line at Master Cylinder

icates a leak in the system which should be located and remedied. If tank becomes more than half empty, air will be drawn into the system when the brake is released. In such a case, filling the tank to the proper level is not enough. The system will have to be bled at each wheel cylinder and at the Hydrovac power unit to remove the trapped air.

c. Master Cylinder Replacement. The master cylinder assembly should be removed and replaced as a unit when any part of it is damaged. Procedure is as follows:

(1) EQUIPMENT.

PLIERS

SCREWDRIVER

WRENCH, 1/2-in.

WRENCH, 9/16-in.

(2) PROCEDURE.

(a) *Disconnect Brake Line at Master Cylinder* (fig. 100).

WRENCH, 1/2-in.

Disconnect brake line at master cylinder.

(b) *Disconnect Stop Light Switch* (fig. 101).

SCREWDRIVER

Disconnect wires at stop light switch.

(c) *Disconnect brake pedal pull-back spring* (fig. 102).

BASIC HALF-TRACK VEHICLES (IHC) (PERSONNEL CARRIER M5, CAR M9A1, MULTIPLE GUN MOTOR CARRIAGE M14, AND SIMILAR IHC VEHICLES)

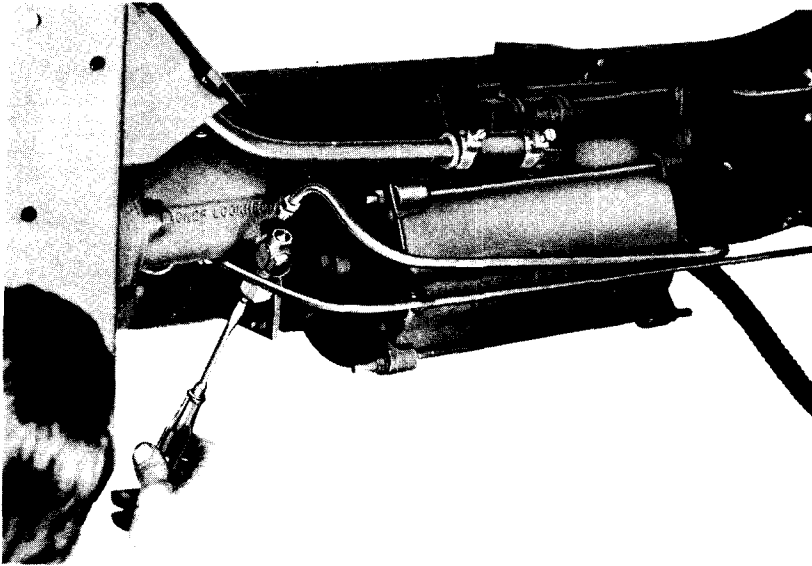

RA PD 18255

Figure 101 — Disconnecting Stop Light Switch

(d) *Remove Push Rod Yoke Pin (fig. 103).*

PLIERS

Remove cotter pin. Remove master cylinder push rod yoke pin.

(e) *Remove Master-Cylinder-to-Bracket-Mounting Cap Screws (fig. 104).*

WRENCH, $\frac{5}{16}$ -in.

Disconnect brake line from slave cylinder to front brakes. Remove three master-cylinder-to-bracket cap screws and lock washers.

(f) *Remove Master Cylinder (fig. 105).* Move master cylinder toward rear and remove. Turning on its side will facilitate removal.

(g) *Install Master Cylinder.*

(h) *Install Master-Cylinder-to-Bracket Cap Screws and Lock Washers.*

(i) *Connect Push Rod Yoke Pin, and Install Cotter Pin.*

(j) *Connect Brake Pedal Pull-back Spring.*

(k) *Connect Brake Line to Front Axle.*

(l) *Connect Brake Line from Master Cylinder to Slave Cylinder.*

(m) *Bleed Brakes (par. 66).*

BRAKE SYSTEMS

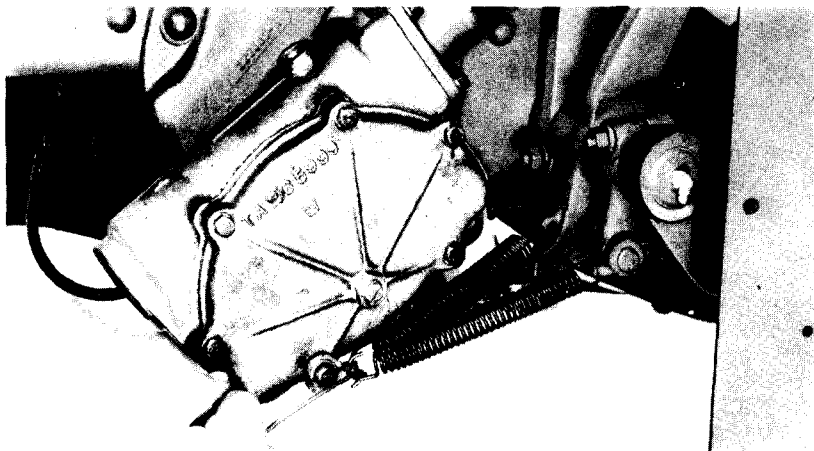

RA PD 18256

Figure 102 – Disconnecting Brake Pedal Pull-back Spring

62. VACUUM POWER UNIT (HYDROVAC) (fig. 106).

a. Description. The vacuum power unit (Hydrovac) consists of a double-piston vacuum-suspended power cylinder, a hydraulic operating

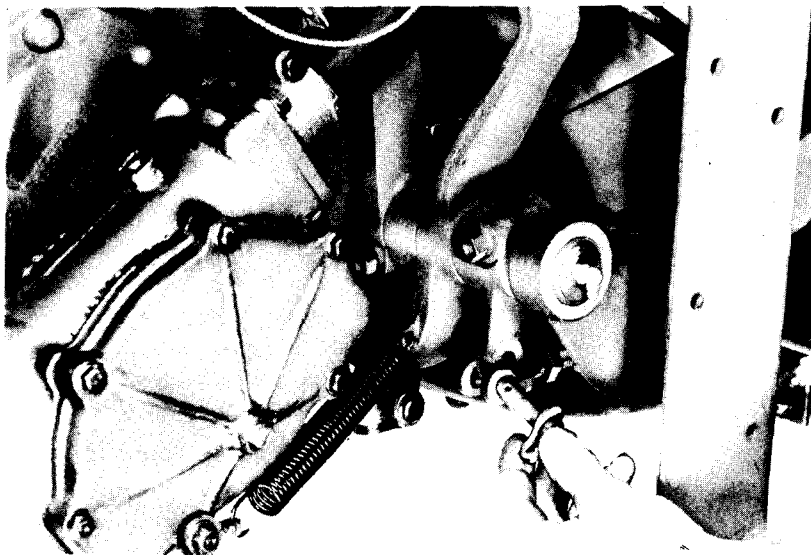

RA PD 18257

Figure 103 – Brake Pedal Yoke Pin – Removal

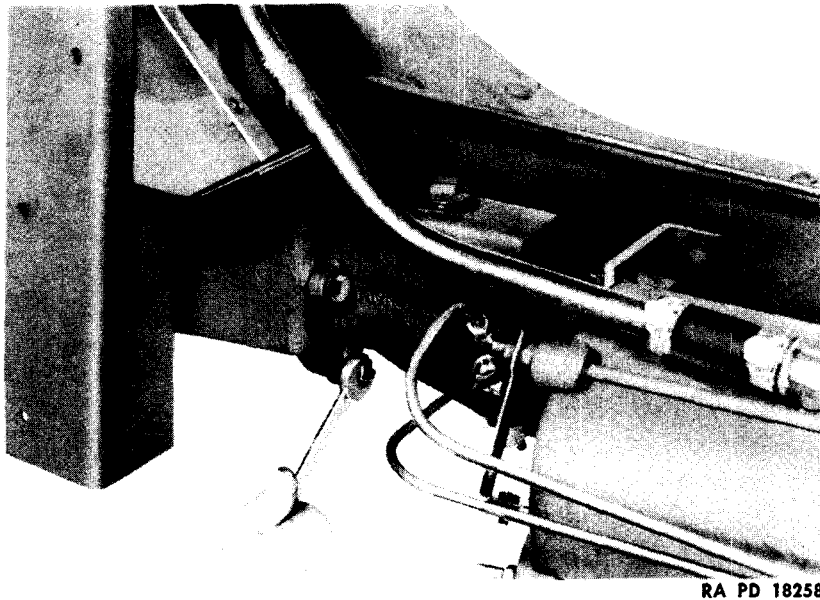
BASIC HALF-TRACK VEHICLES (IHC) (PERSONNEL CARRIER M5, CAR M9A1, MULTIPLE GUN MOTOR CARRIAGE M14, AND SIMILAR IHC VEHICLES)

RA PD 18258

Figure 104 – Master Cylinder Bracket Bolt – Removal

valve, and a hydraulic sleeve cylinder. The three fundamentals are assembled in a single compact unit. The unit acts as a power or booster complement to the brake pedal and master cylinder and reduces the amount of physical effort at the pedal required for brake application. The unit is connected through an air cleaner and a check valve to the engine intake manifold.

b. Testing. The Hydrovac may be tested in the vehicle through a series of tests and through the use of two vacuum gages and a line pressure gage. The tests are as follows:

(1) **TEST #1.** First inspect manifold vacuum and check valve for leakage. Remove vacuum hose from center place connection and connect a vacuum gage to hose. Start engine, observe vacuum gage reading (manifold vacuum) and shut off engine. Check valve should seal and hold vacuum. A drop of more than one inch of vacuum in 15 seconds should be corrected by repair or replacement of check valve.

(2) **TEST #2. ENGINE NOT RUNNING.** Make a few applications of brake pedal to deplete any vacuum that might be present in Hydrovac. Install a 2,000-pound hydraulic pressure gage in the bleed hole of a front wheel cylinder. Allow a slight flow of oil around threads on gage before tightening. Apply foot pedal and note gage pressure of hydraulic pressure at wheel. High pressure reading on gage indicates that brake fluid is

BRAKE SYSTEMS

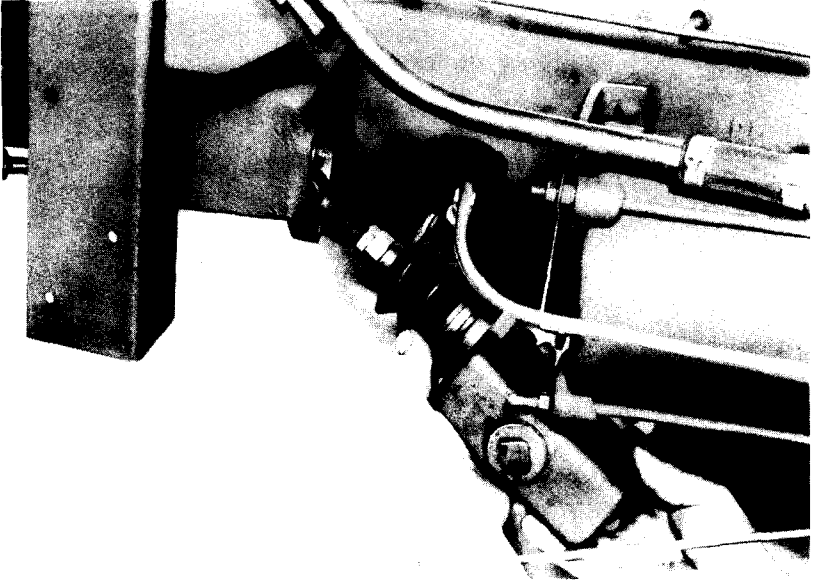

RA PD 18259

Figure 105 — Master Cylinder — Removal

passing through the Hydrovac sleeve cylinder which makes it possible to apply brakes (physically) in case of Hydrovac failure. This hydraulic pressure is the output of the vehicle master cylinder.

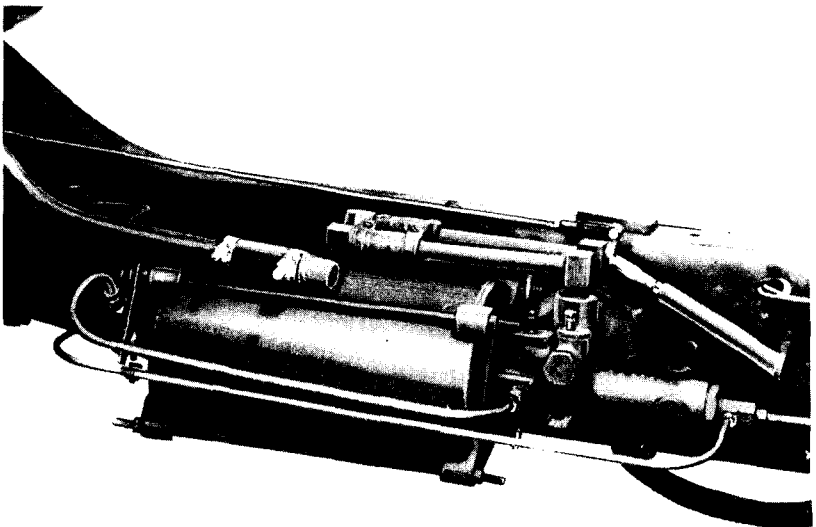

RA PD 18242

Figure 106 — Brake Hydrovac — Installed

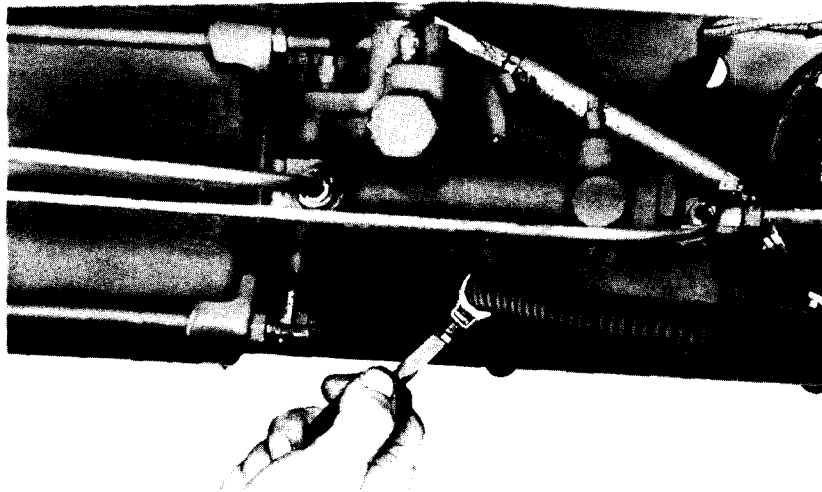
BASIC HALF-TRACK VEHICLES (IHC) (PERSONNEL CARRIER M5, CAR M9A1, MULTIPLE GUN MOTOR CARRIAGE M14, AND SIMILAR IHC VEHICLES)

RA PD 18243

Figure 107 – Disconnecting Air Cleaner Hose

(3) **TEST #3.** Connect vacuum gage and vacuum hose to the Hydrovac cylinder by means of a tee connection. Start engine and apply brake slowly, watching hydraulic pressure gage (at wheel cylinder). With the same amount of physical pressure as was applied in Test #2 the hydraulic gage at the wheel cylinder should now register the original physical pressure (gained in Test #2) *plus* the output of the Hydrovac power unit. The increase with 16 inches of vacuum should be about 600 pounds per square inch in hydraulic pressure. This test proves whether Hydrovac and slave cylinder are functioning.

(4) **TEST #4.** Connect second vacuum gage in plug hole of end cylinder which is on the control side of power piston, which in turn has communication through hollow piston rod to control chamber of other piston. Start engine. When brakes are released, both of the control chambers are connected to intake manifold vacuum through the hydraulic operating valve. The entire unit is suspended in vacuum. Both vacuum gages should register the manifold vacuum (as shown by Test #1). Turn off ignition and note gages for leaks. A rapid drop of more than two inches of vacuum in 15 seconds indicates a leak. If no leaks are indicated, make same test with brakes applied. If leaks are now indicated, Hydrovac should be removed from vehicle and repaired or replaced.

c. **Hydrovac Replacement.** When the Hydrovac unit becomes dam-

BRAKE SYSTEMS

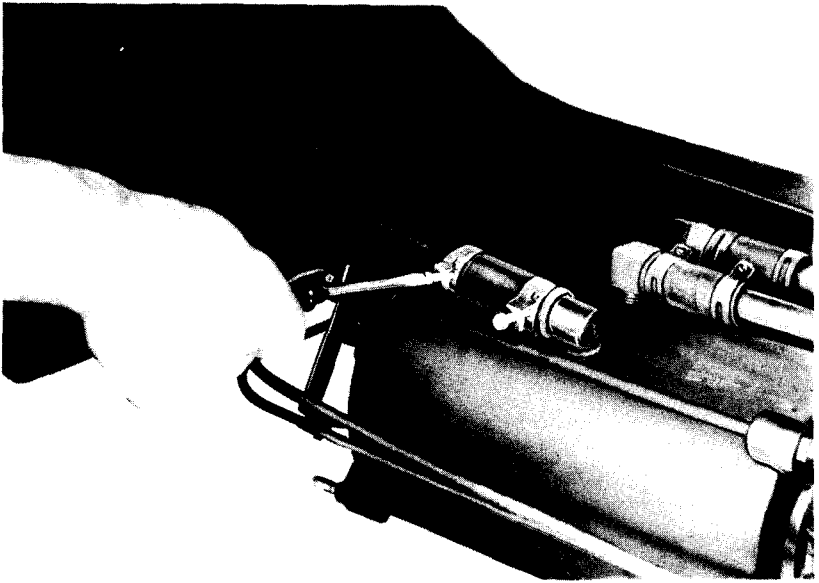

RA PD 18244

Figure 108 — Disconnecting Vacuum Hose

aged or inoperative it must be removed and replaced as a complete unit. Procedure is as follows:

(1) EQUIPMENT.

HANDLE, socket wrench

SCREWDRIVER

WRENCH, end, $\frac{7}{16}$ -in.

WRENCH, end, $\frac{1}{2}$ -in.

WRENCH, end, $\frac{9}{16}$ -in.

WRENCH, socket, $\frac{9}{16}$ -in.

(2) PROCEDURE.

(a) *Disconnect Air Cleaner Hose at Hydrovac (fig. 105).*

SCREWDRIVER

Loosen screws in hose clamps and disconnect air cleaner hose.

(b) *Disconnect Vacuum Line at Hydrovac (fig. 108).*

SCREWDRIVER

Loosen screws in vacuum hose connection. Disconnect hose.

(c) *Disconnect Brake Line to Rear Axle at Slave Cylinder (fig. 109).*

WRENCH, end, $\frac{1}{2}$ -in.

Disconnect brake line at slave cylinder.

(d) *Disconnect Brake Line to Front Axle at Slave Cylinder (fig. 110).*

WRENCH, end, $\frac{7}{16}$ -in.

Disconnect brake line to front axle at slave cylinder. Loosen at front under master cylinder.

BASIC HALF-TRACK VEHICLES (IHC) (PERSONNEL CARRIER M5, CAR M9A1, MULTIPLE GUN MOTOR CARRIAGE M14, AND SIMILAR IHC VEHICLES)

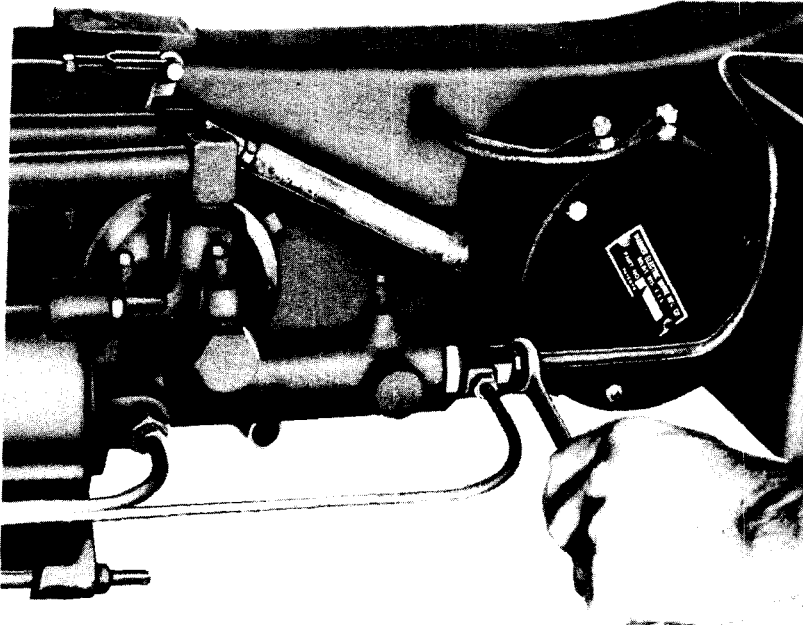

RA PD 18245

Figure 109 – Disconnecting Brake Line to Rear Axle

(e) Disconnect Brake Line to Master Cylinder (fig. 111).

WRENCH, end, 1/2-in.

Disconnect brake line to master cylinder.

(f) Disconnect Brake Line at Master Cylinder (fig. 112).

WRENCH, end, 1/2-in.

Disconnect brake line at master cylinder.

(g) Disconnect Brake Line at Support Clip (fig. 113).

WRENCH, end, 1/2-in.

Remove bolt, nut, and washer from brake line support clip.

(h) Remove Front Hydrovac Mounting Nuts (fig. 114).

WRENCH, end, 1/2-in.

Remove two nuts and lock washers from Hydrovac front mounting bracket.

(i) Remove Hydrovac Rear Mounting Bracket Bolts, Nuts, and Lock Washers (fig. 115).

HANDLE, socket wrench

WRENCH, socket, 1/16-in.

WRENCH, end, 1/16-in.

BRAKE SYSTEMS

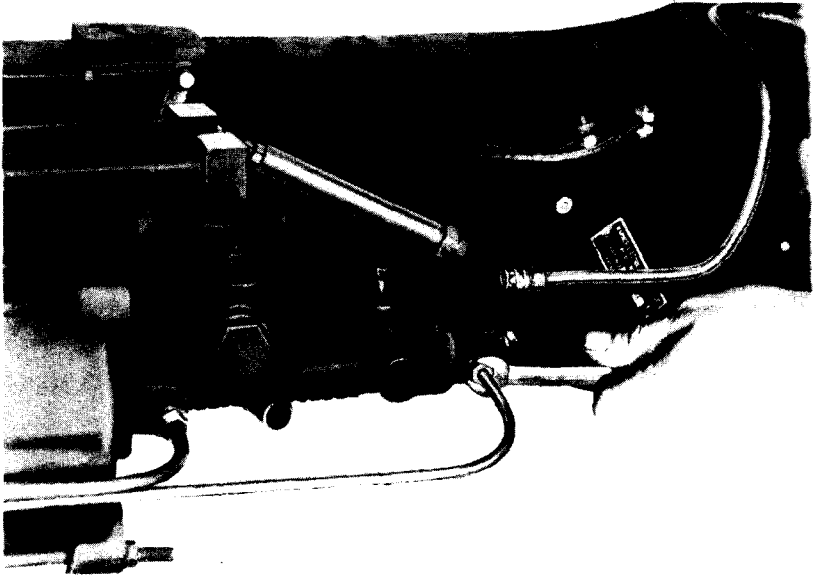

RA PD 18246

Figure 110 – Disconnecting Brake Line to Front Axle

Remove two bolts, nuts, and lock washers from Hydrovac rear mounting brackets at frame.

(j) *Remove Hydrovac Assembly* (fig. 116). Remove Hydrovac assembly from frame.

(k) *Install Hydrovac Assembly.*

(l) *Install Rear-Bracket-to-Frame Mounting Bolts, Nuts, and Lock Washers.*

(m) *Install Two Front Mounting Nuts and Lock Washers.*

(n) *Connect Brake Line at Support Clip.*

(o) *Connect Brake Line at Master Cylinder.*

(p) *Connect Master Cylinder Brake Line to Slave Cylinder.*

(q) *Connect Front Axle Brake Line to Slave Cylinder. Tighten Line Connection Below Master Cylinder.*

(r) *Connect Brake Line to Rear Axle at Slave Cylinder.*

(s) *Connect Vacuum Line at Hydrovac.*

(t) *Connect Air Cleaner Hose at Hydrovac.*

d. Hydrovac Air Cleaner. The Hydrovac air cleaner should be examined and cleaned at regular maintenance intervals. Procedure is as follows:

BASIC HALF-TRACK VEHICLES (IHC) (PERSONNEL CARRIER M5, CAR M9A1,
MULTIPLE GUN MOTOR CARRIAGE M14, AND SIMILAR IHC VEHICLES)

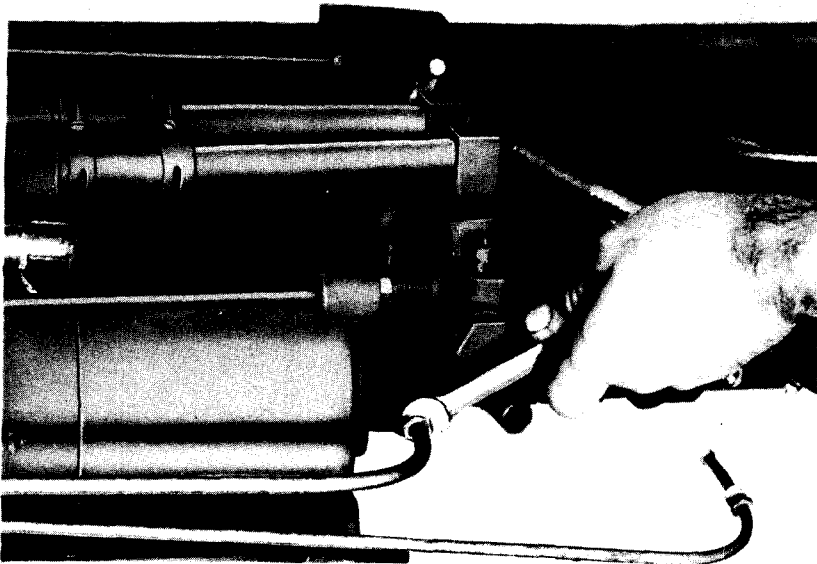

RA PD 18247

Figure 111 – Disconnecting Brake Line to Master Cylinder

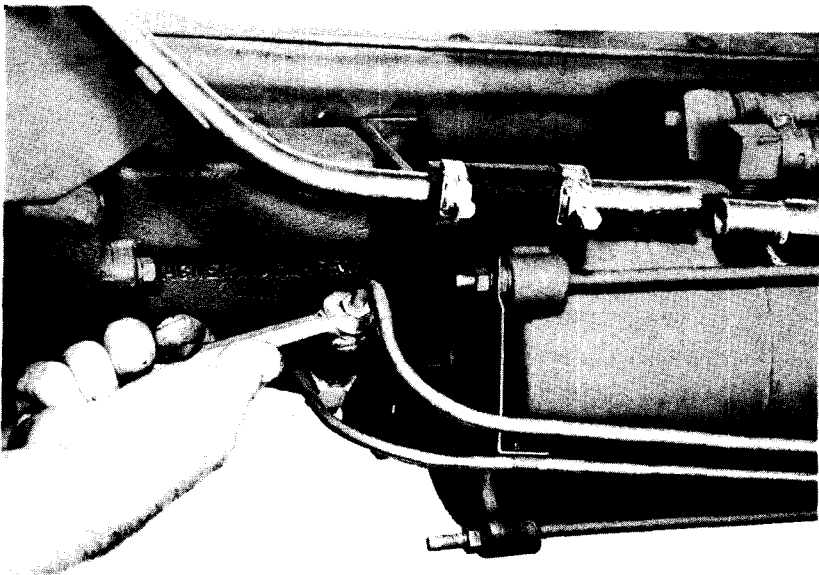

RA PD 18248

Figure 112 – Disconnecting Brake Line at Master Cylinder

BRAKE SYSTEMS

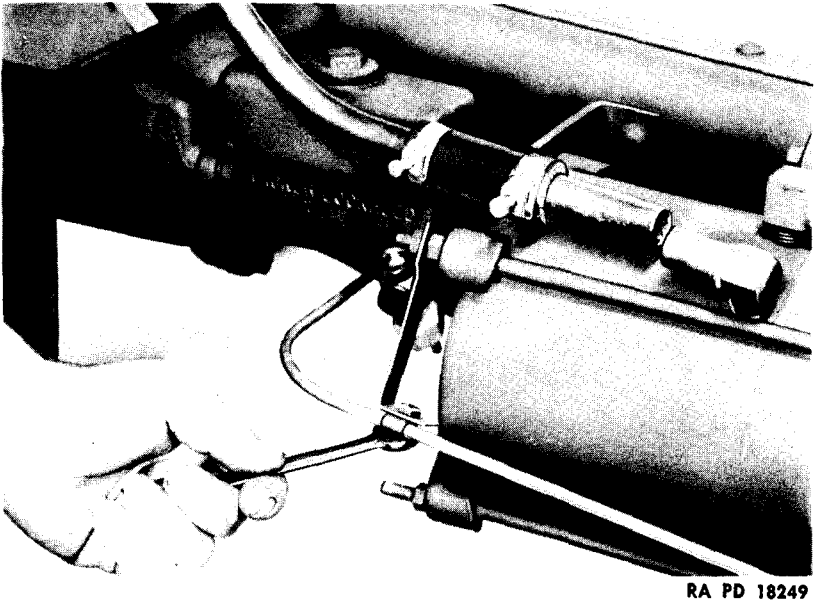

RA PD 18249

Figure 113 — Brake Line Support Clip Bolt — Removal

(1) EQUIPMENT.

SCREWDRIVER

WRENCH, end, $1\frac{7}{16}$ -in.

(2) PROCEDURE.

(a) *Disconnect Air Cleaner Hose at Air Cleaner.*

SCREWDRIVER

Loosen clamp screw holding hose to air cleaner. Disconnect hose.

(b) *Remove Air Cleaner.*

WRENCH, end, $1\frac{7}{16}$ -in.

Remove nut holding air cleaner to bracket. Remove air cleaner.

(c) *Remove Air Cleaner Cover (fig. 117).*

SCREWDRIVER

Remove screw from cover.

(d) *Disassemble Air Cleaner. Remove Cover, Top Screen, Filter, and Lower Screen (fig. 118).*

(e) *Clean Parts, Dip Filter in Light Oil, and Permit to Drain.*

(f) *Reassemble Air Cleaner. Note position and relation of parts (fig. 118) and reassemble.*

(g) *Install Air Cleaner on Bracket.*

(h) *Connect Air Cleaner Hose.*

**BASIC HALF-TRACK VEHICLES (IHC) (PERSONNEL CARRIER M5, CAR M9A1,
MULTIPLE GUN MOTOR CARRIAGE M14, AND SIMILAR IHC VEHICLES)**

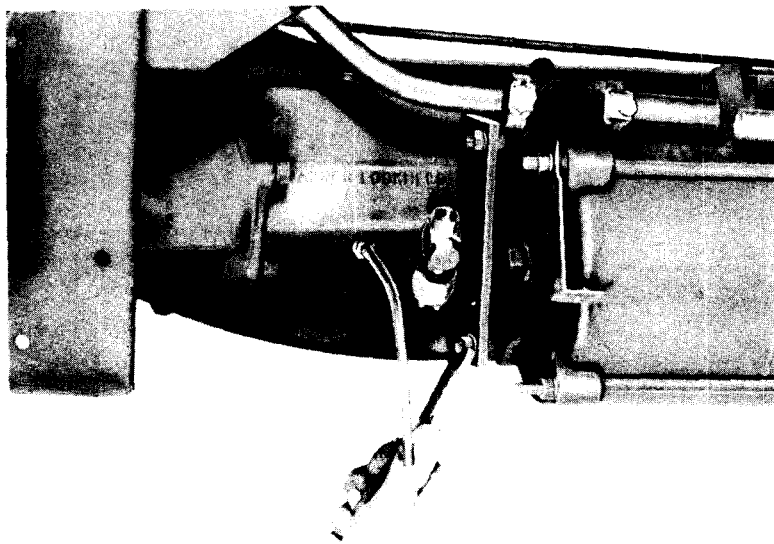

RA PD 18250

Figure 114 — Hydrovac Front Bracket Nuts — Removal

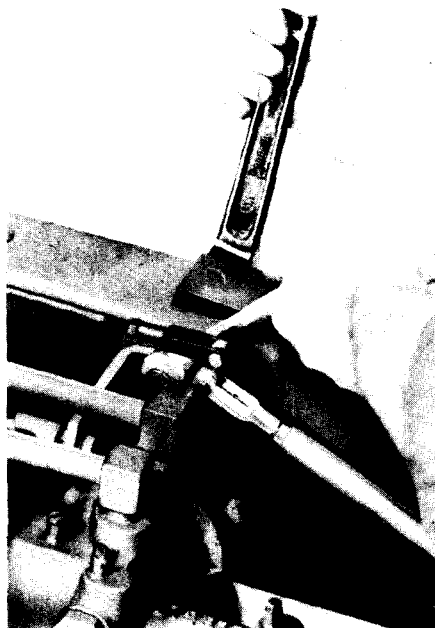

RA PD 18251

Figure 115 — Hydrovac Rear Bracket Bolts — Removal

BRAKE SYSTEMS

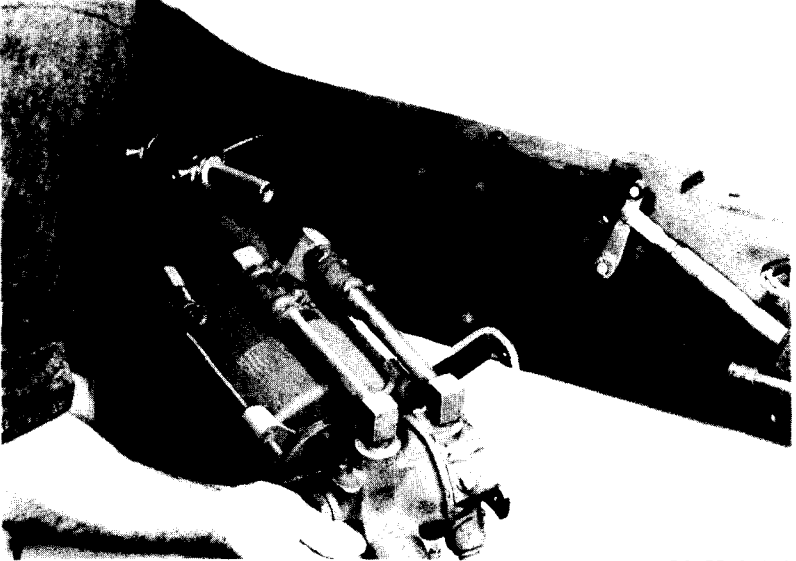

RA PD 18252

Figure 116 – Hydrovac – Removal

63. SERVICE BRAKE SHOES (figs. 119 to 122).

a. **Description.** The service brakes proper consist of a combination of two internal expanding shoes, a brake drum, and a wheel cylinder for each front wheel, and each rear drive sprocket. The shoes, lined with moulded brake lining, are anchored at one end and the opposite end actu-

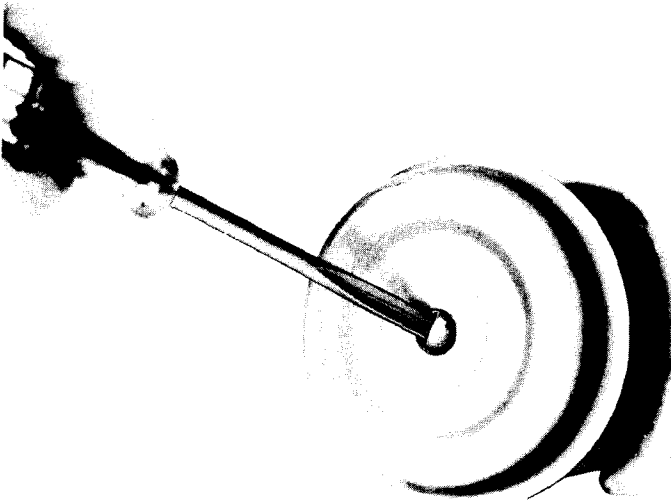

RA PD 18260

Figure 117 – Hydrovac Air Cleaner Top – Removal

BASIC HALF-TRACK VEHICLES (IHC) (PERSONNEL CARRIER M5, CAR M9A1, MULTIPLE GUN MOTOR CARRIAGE M14, AND SIMILAR IHC VEHICLES)

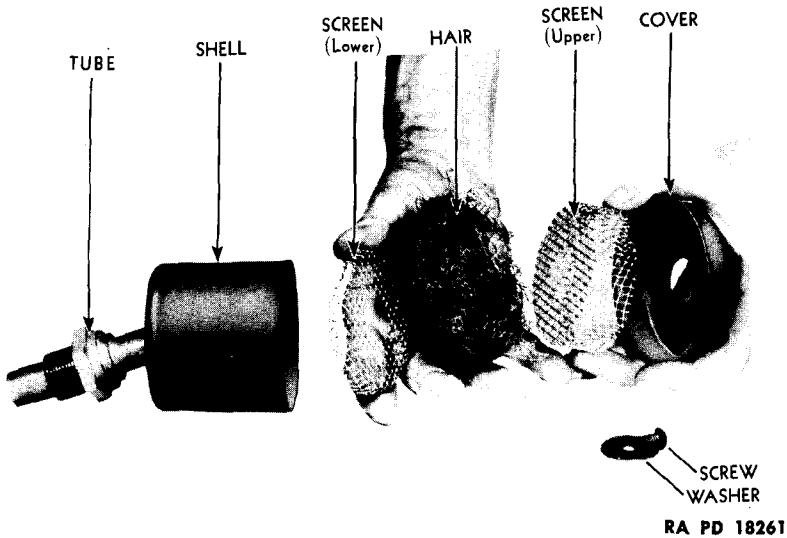

Figure 118 – Hydrovac Air Cleaner – Disassembled

ated by the wheel cylinder. The front brakes are of Lockheed design and the rear brakes are of Wagner Hi-Tork design. In the Lockheed design the two shoes have their anchors at the lower end, and in the Hi-Tork

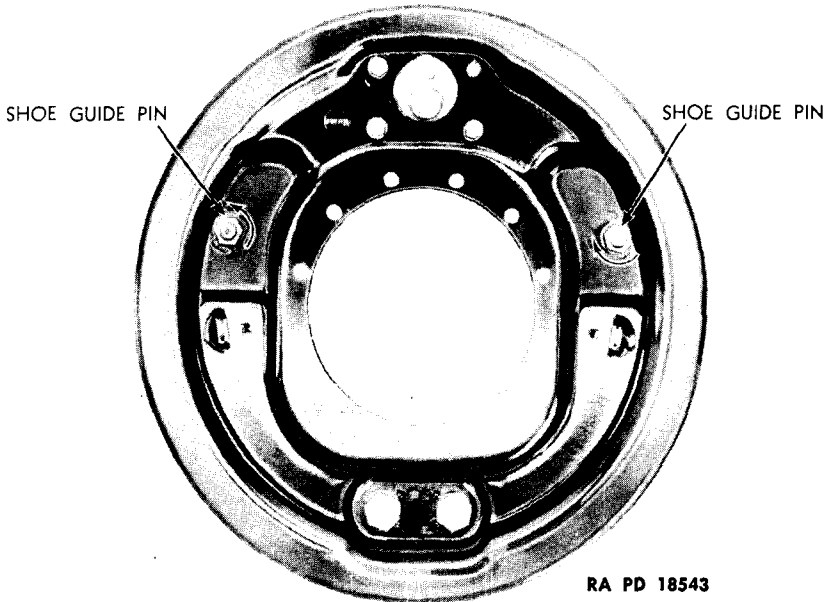

Figure 119 – Front Brake – Rear View

BRAKE SYSTEMS

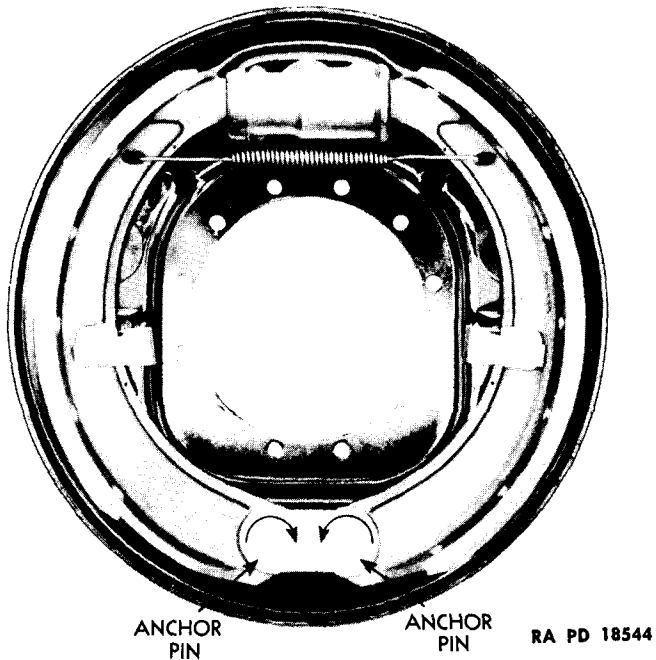

Figure 120 - Front Brake - Inside View

design, the anchors are at opposite ends, the anchor of one shoe being at the bottom, and of the other shoe at the top.

b. Shoe Replacement, Front Wheels. Brake shoes which have become unserviceable should be replaced in the following manner:

(1) EQUIPMENT.

CLAMP, wheel cylinder
JACK
SCREWDRIVER

WRENCH, box, $\frac{15}{16}$ -in.
WRENCH, end, $\frac{3}{8}$ -in.
WRENCH, socket, $\frac{3}{4}$ -in.
WRENCH, wheel bearing nut

(2) PROCEDURE.

(a) *Raise Front Wheels from Floor.*

JACK

Place jack under front axle and raise front wheels from floor.

(b) *Remove Front Axle Drive Flange Nuts.*

WRENCH, $\frac{3}{4}$ -in.

Remove retaining nuts and lock washers from front axle drive flange.

(c) *Remove Axle Shaft Drive Flange.*

WRENCH, $\frac{3}{4}$ -in.

Insert two cap screws in tapped holes in flange. Force flange off shaft.

BASIC HALF-TRACK VEHICLES (IHC) (PERSONNEL CARRIER M5, CAR M9A1, MULTIPLE GUN MOTOR CARRIAGE M14, AND SIMILAR IHC VEHICLES)

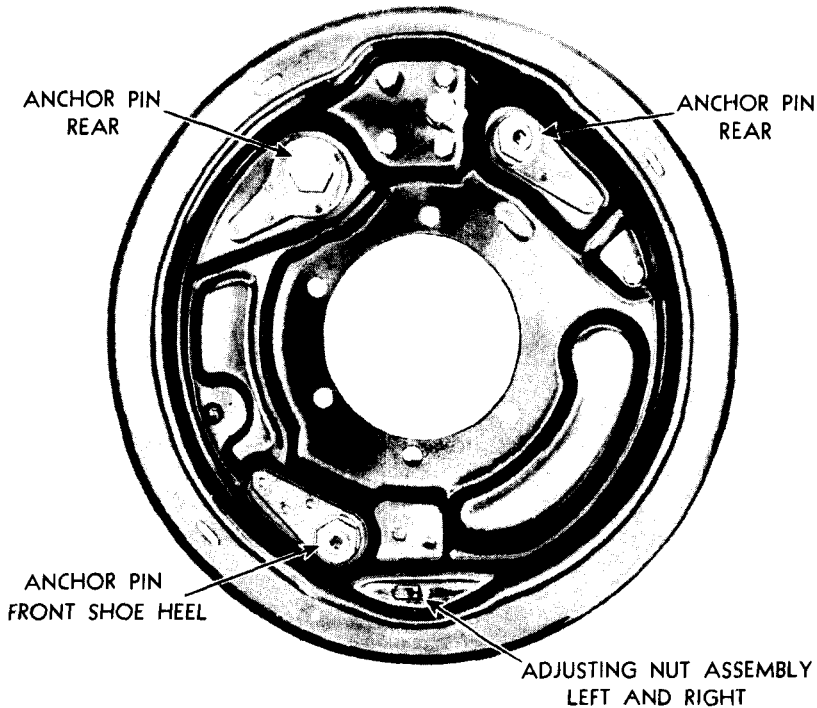

RA PD 18545

Figure 121 - Rear Brake - Rear View

(d) *Remove Wheel Bearing Outer Lock Nut and Lock Washer.*

SCREWDRIVER

WRENCH, wheel bearing nut

Bend tab on lock washer. Remove outer lock nut and lock washer.

(e) *Remove Wheel Bearing Adjusting Nut.*

WRENCH, wheel bearing nut

Remove wheel bearing adjusting nut.

(f) *Remove Wheel Assembly.*

(g) *Remove Brake Shoe Anchor Nuts.*

WRENCH, box, $1\frac{5}{16}$ -in.

WRENCH, end, $\frac{3}{8}$ -in.

Hold anchor pin and loosen and remove brake anchor pin nuts and washer.

(h) *Install Wheel Cylinder Clamp.*

(i) *Remove Brake Shoe Spring.*

(j) *Remove Brake Anchor Pins.*

(k) *Remove Brake Shoes.*

BRAKE SYSTEMS

- (l) Install Replacement Brake Shoes.*
- (m) Install Brake Shoe Anchor Pins.*
- (n) Install Brake Shoe Spring and Remove Wheel Cylinder Clamp.*
- (o) Install Brake Shoe Anchor Pin Nuts and Washers.*
- (p) Install Wheel Assembly.*
- (q) Install Wheel Bearing Adjusting Nut.*
- (r) Adjust Front Wheel Bearings.* Tighten wheel adjusting nut while revolving wheel until a definite drag is felt. Back off adjustment one-eighth turn.
- (s) Install Lock Washer and Outer Lock Nut.*
- (t) Install Axle Shaft Drive Flange.*
- (u) Adjust Brake (par. 65 a (3)).*
- (v) Remove Jack.* Lower vehicle and remove jack.

c. Shoe Replacement, Drive Sprocket. Brake shoes which have become unserviceable should be replaced as follows:

(1) EQUIPMENT.

- | | |
|----------------------------------|------------------------------------------------------------|
| BAR , pinch | WRENCH , drive sprocket hub bearing nut, and handle |
| CHAIN , with turnbuckles | |
| CROWBAR | WRENCH , end, $\frac{7}{16}$ -in. |
| EXTENSION , socket wrench | WRENCH , end, $\frac{3}{4}$ -in. |
| HAMMER | WRENCH , end, $2\frac{1}{4}$ -in. |
| HANDLE , socket wrench | WRENCH , end, $2\frac{5}{16}$ -in. |
| JACK , 12-ton (2) | WRENCH , socket, $\frac{3}{4}$ -in. |
| ROD , hooked | WRENCH , wheel bearing nut |
| SCREWDRIVER | |

(2) PROCEDURE.

- (a) Remove Track (par. 55 b).*
- (b) Remove Sprocket Drive Shaft (fig. 55).*

WRENCH, $\frac{3}{4}$ -in.

Remove driving shaft flange nuts and lock washers. Turn flange screws in to force shaft outward. Remove driving shaft.

- (c) Remove Bearing Lock Nut (fig. 56).*

SCREWDRIVER	WRENCH , drive sprocket hub bearing nut, and handle
--------------------	------------------------------------------------------------

Remove bearing lock nut after bending tab on lock washer. Remove lock washer.

**BASIC HALF-TRACK VEHICLES (IHC) (PERSONNEL CARRIER M5, CAR M9A1,
MULTIPLE GUN MOTOR CARRIAGE M14, AND SIMILAR IHC VEHICLES)**

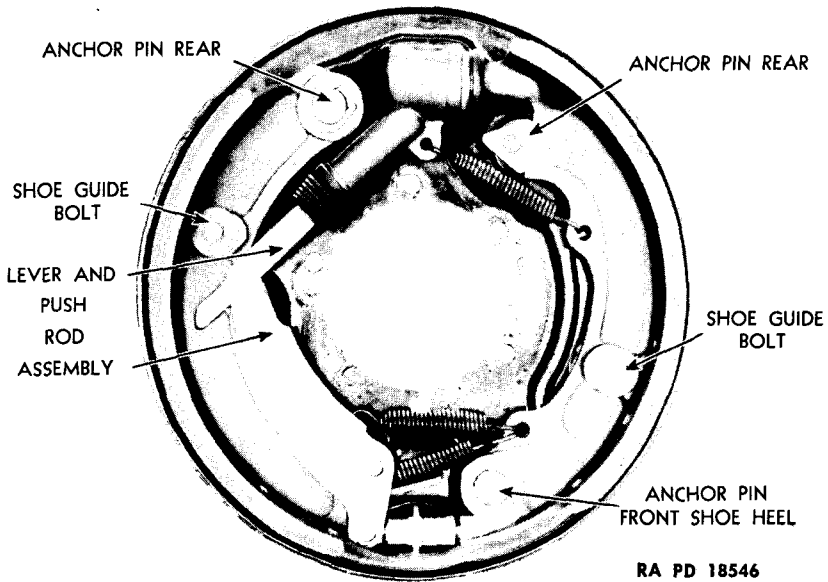
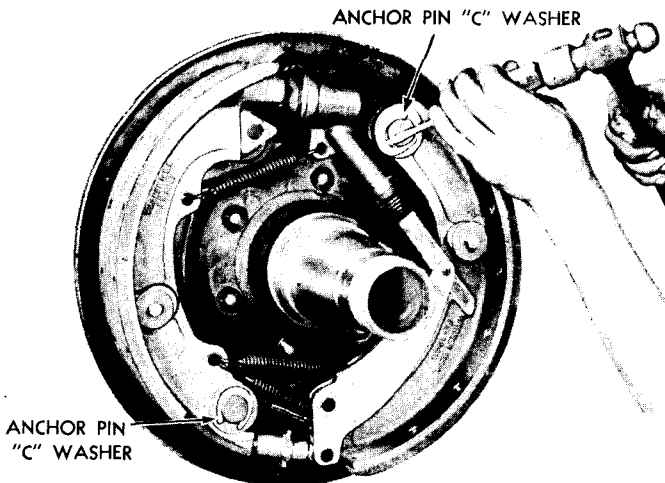

Figure 122 – Rear Brake – Inside View

(d) Remove Bearing Adjusting Nut (fig. 57).

WRENCH, wheel bearing nut,
and handle

Remove drive sprocket bearing adjusting nut.



RA PD 18390

Figure 123 – Shoe Retainer Washer – Removal

BRAKE SYSTEMS

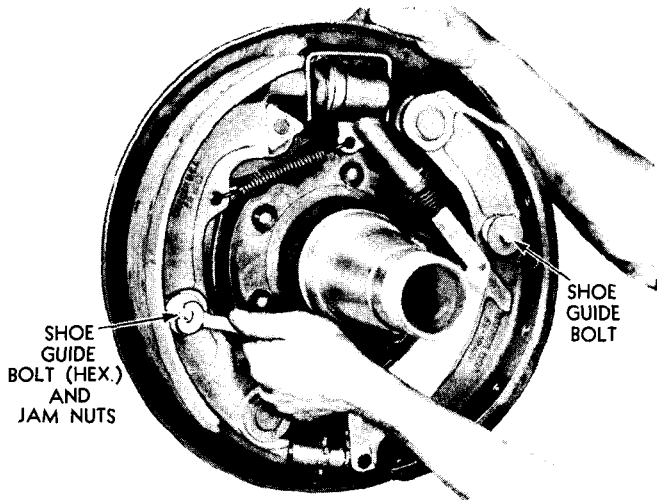

RA PD 18391

Figure 124 – Shoe Guide Bolt – Removal

(e) *Remove Drive Sprocket Assembly.*

(f) *Remove "C"-shaped Retaining Washer (fig. 123).*

HAMMER

SCREWDRIVER

Remove retaining washer from upper anchor pin. Do not remove "C"-shaped washer from lower anchor pin.

(g) *Install Brake Cylinder Clamp.*

(h) *Remove Brake Shoe Guide Bolts and Washers (fig. 124).*

WRENCH, end, $\frac{7}{16}$ -in.

Remove nuts (two each bolt) from brake shoe guide bolts. Remove bolts.

(i) *Remove Upper Brake Shoe Return Spring (fig. 125).*

ROD, hooked

Using hooked piece of rod, disconnect upper brake shoe return spring.

(j) *Remove Lower Brake Shoe Return Springs (fig. 126).*

ROD, hooked

Using hooked piece of rod, disconnect lower brake shoe return spring (two).

(k) *Remove Front Brake Shoe (fig. 127).*

(l) *Remove Rear Brake Shoe (fig. 128).* To remove lever-actuated shoe without injury to the hydraulic cylinder wall, grasp the actuating lever which is attached to the shoe and actuating push rod and move lever

BASIC HALF-TRACK VEHICLES (IHC) (PERSONNEL CARRIER M5, CAR M9A1, MULTIPLE GUN MOTOR CARRIAGE M14, AND SIMILAR IHC VEHICLES)

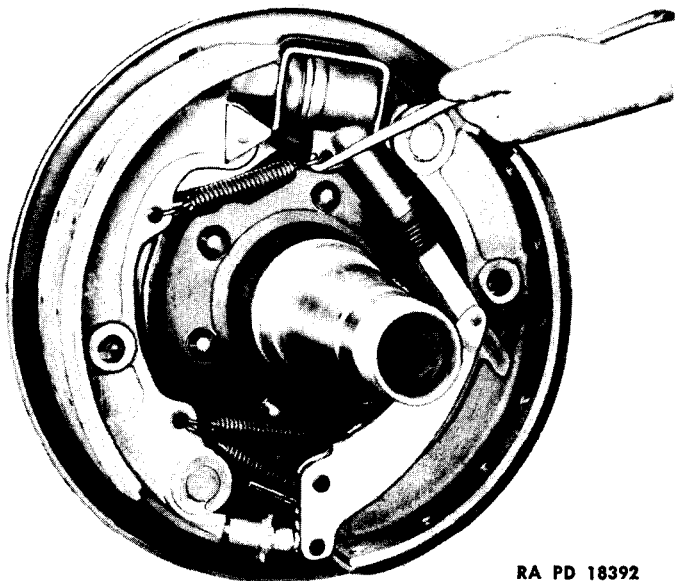

RA PD 18392

Figure 125 — Upper Brake Shoe Return Spring — Removal

into extreme applied position in the direction of the brake shoe contour. Hold lever in this position and rotate brake shoe outward. This will permit shaft to leave cylinder bore without interference.

(m) *Install Brake Shoes.* To install lever actuated brake shoe without injury to small cylinder bore, place brake shoe in extreme outward position and enter actuating push rod (fig. 128) into bore of wheel cylinder. Move shoe toward inner position.

(n) *Lubricate Lightly Surfaces of Shoe Bearings at Anchors, Cams, and Guides with Film of Wheel Bearing Grease.*

(o) *Install Brake Shoe Return Springs.*

(p) *Install "C"-shaped Retaining Washer.*

(q) *Install Brake Shoe Guide Bolts and Washers.* Adjust shoe guide washer so that a 0.010-inch forked feeler gage may be inserted between the shoe web and brake shoe guide washer at both sides at the same time (fig. 129). Lock jam nuts securely after ascertaining that the thick nut is installed first and the *thin nut on top.*

(r) *Install Drive Sprocket Assembly.*

(s) *Install Drive Sprocket Bearing Adjusting Nut.*

(t) *Adjust Drive Sprocket Bearings.* Adjustment is accomplished

BRAKE SYSTEMS

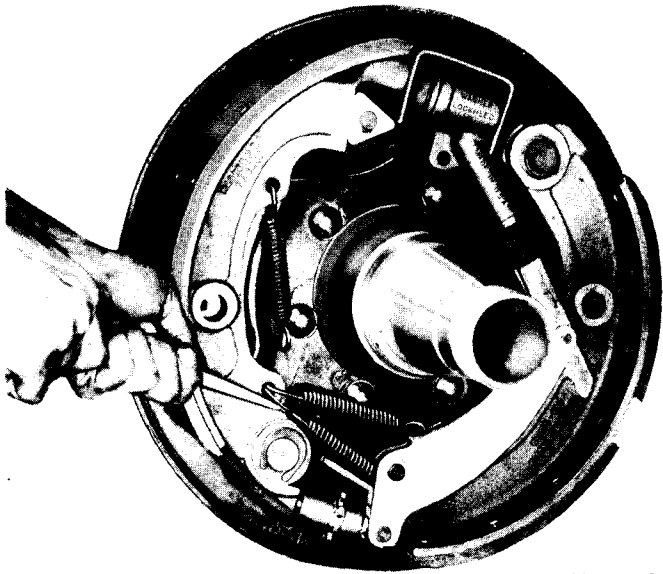

RA PD 18393

Figure 126 — Lower Brake Shoe Return Spring — Removal

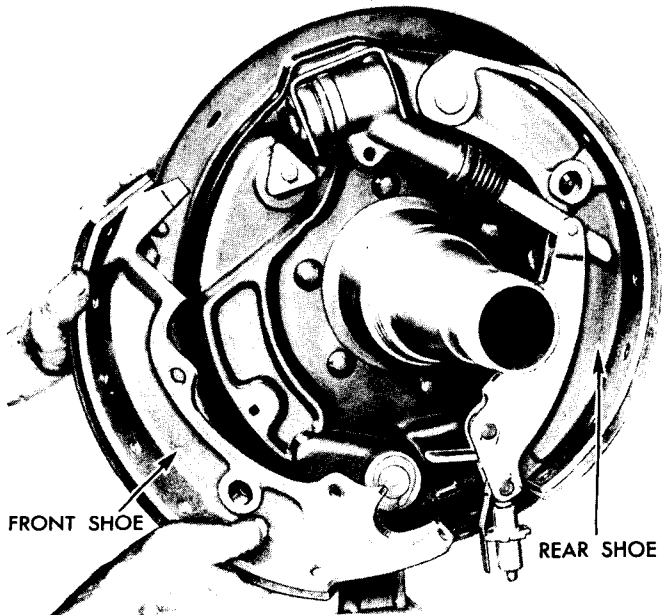

RA PD 18394

Figure 127 — Front Brake Shoe — Removal

**BASIC HALF-TRACK VEHICLES (IHC) (PERSONNEL CARRIER M5, CAR M9A1,
MULTIPLE GUN MOTOR CARRIAGE M14, AND SIMILAR IHC VEHICLES)**

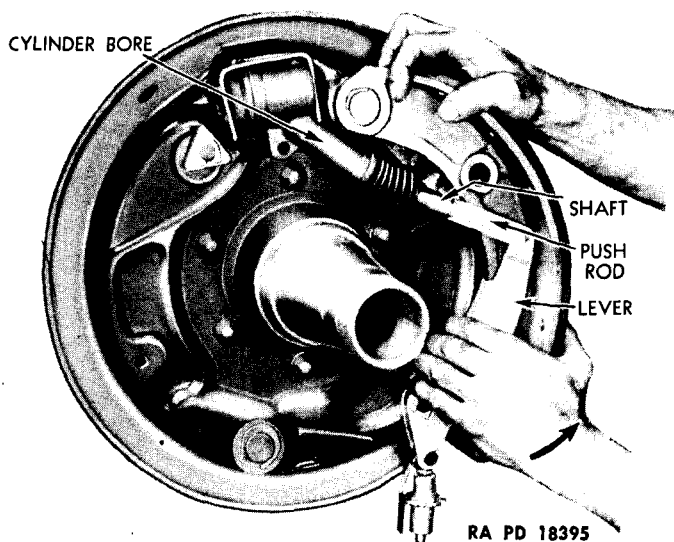

Figure 128 — Rear Brake Shoe — Removal

by drawing adjusting nut up until definite drag is felt while rotating drive sprocket. Back off adjustment one-eighth turn.

- (u) *Install Outer Lock Nut and Washer.*
- (v) *Install Axle Shaft and Install Drive Shaft Nuts.*
- (w) *Adjust Brakes (par. 65 a).*
- (x) *Install Track (par. 55 b).*
- (y) *Adjust Track (par. 57).*

64. SERVICE BRAKE PEDAL LINKAGE.

a. The clamping bolts for the service brake pedal linkage and its associated linkage must be kept tight. If pedal return spring is weak or broken, it should be replaced. Worn clevis pins should be renewed.

(1) **BRAKE PEDAL ADJUSTMENT.** The brake pedal should be adjusted to provide $\frac{1}{2}$ -inch free travel before the pressure stroke starts. This free travel is required to prevent blocking of compensating part in the master cylinder. Brakes will drag if compensating part becomes blocked due to pressure building up in the system. Should all brakes drag from this cause, pressure may be relieved by shortening the pedal push rod to allow piston to uncover the compensating part allowing fluid to escape into tank. This adjustment is accomplished as follows:

BRAKE SYSTEMS

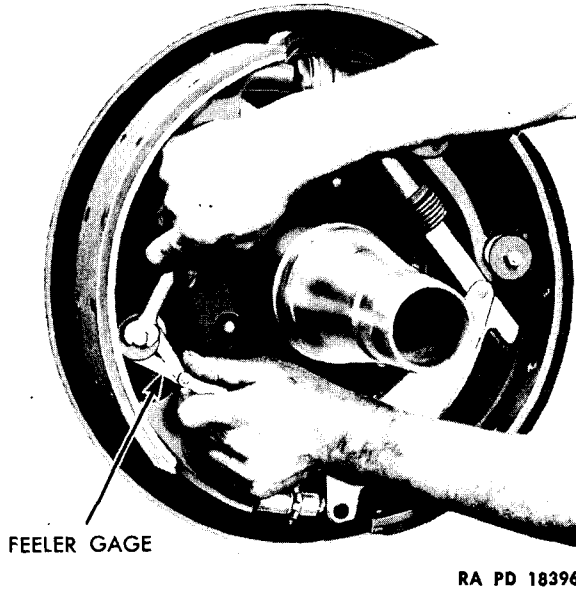

Figure 129 – Brake Shoe Guide Bolt Adjustment

(a) Equipment.

PLIERS

WRENCH, end, 7/8-in.

(b) Procedure.

1. *Disconnect brake pedal pull-back spring at pedal.*
2. *Disconnect brake pedal from push rod clevis.*

PLIERS

Remove cotter pin and clevis pin from push rod yoke.

3. *Adjust brake pedal push rod.*

WRENCH, end, 7/8-in.

Loosen lock nut on push rod yoke of master cylinder. Adjust rod length by screwing in or out until pedal will have 1/2-inch free travel.

(c) Connect Push Rod, Install Clevis Pin, and Hook Up Pedal Return Spring.

65. SERVICE BRAKE ADJUSTMENTS.

a. Service brake adjustments are necessary where brake linings become worn and excessive pedal free travel exists. Adjustment should be made before it is necessary to "pump" the brake pedal to secure proper braking effect. Before making brake adjustments, wheel bearings must be in proper adjustment. After brakes have been adjusted, there must be approximately 1/2-inch pedal free travel. To take up for lining wear,

BASIC HALF-TRACK VEHICLES (IHC) (PERSONNEL CARRIER M5, CAR M9A1, MULTIPLE GUN MOTOR CARRIAGE M14, AND SIMILAR IHC VEHICLES)

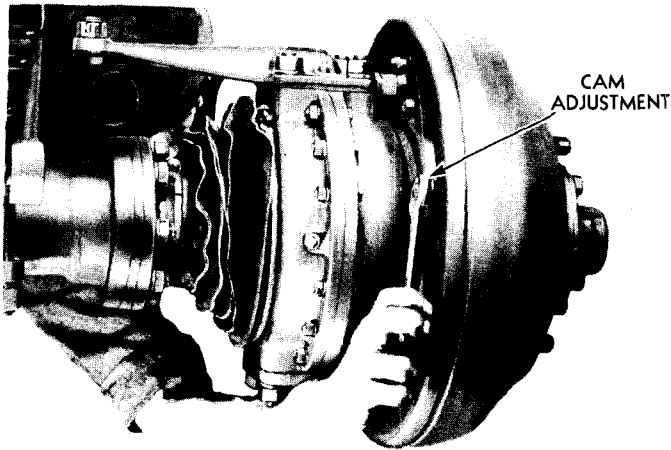

RA PD 18397

Figure 130 – Front Shoe Adjustment

only a minor adjustment is required. When installing new shoes or when brake anchor positions have been altered a major adjustment is required.

(1) ADJUSTMENT FOR MINOR WEAR, FRONT WHEELS.

(a) Equipment.

JACK (2)

WRENCH, end, $1\frac{1}{16}$ -in.

(b) Procedure.

1. Place hand brake lever in fully released position.

2. Raise front of vehicle.

JACK (2)

Jack up the truck until the front wheels are free from the floor.

3. Adjust front shoe (fig. 130).

WRENCH, $1\frac{1}{16}$ -in.

Rotate front shoe cam adjustment in the direction of the *forward* rotation of the wheel until the *front* shoe contacts the drum and a definite brake drag is felt.

4. *Back off adjustment.* Back off adjustment cam until the wheel is just free.

5. Adjust rear shoe.

WRENCH, $1\frac{1}{16}$ -in.

Rotate rear shoe cam adjustment in the direction of the reverse rota-

BRAKE SYSTEMS

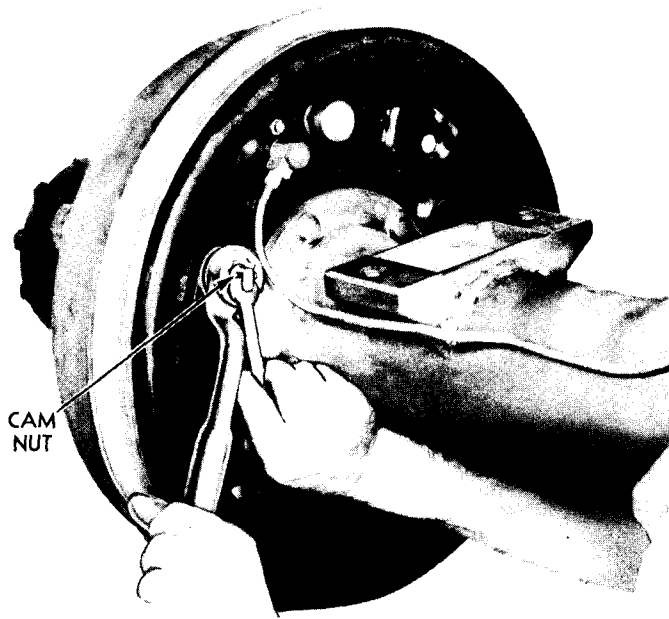

RA PD 18398

Figure 131 — Front Shoe Adjustment

tion of the wheel until the shoe contacts the drum and a definite brake drag is felt.

6. *Back off adjustment.* Back off adjustment cam until the wheel is just free.

7. *Lower vehicle and remove jacks.*

CAUTION: Do not alter positions of anchors (fig. 120).

(2) **ADJUSTMENT FOR MINOR WEAR, DRIVE SPROCKET BRAKES.**

(a) *Equipment.*

GAGE, feeler
SCREWDRIVER

WRENCH, box, $1\frac{1}{16}$ -in.

(b) *Procedure.* The drive sprocket brake backing plates have four feeler gage slots equally spaced to facilitate brake adjustment (fig. 121).

i. *Adjust front shoe cam adjustment* (fig. 131).

WRENCH, $1\frac{1}{16}$ -in.

Loosen the front shoe cam nut and turn cam in the direction of the forward rotation of the drive sprocket (moving the punch mark toward the drum) until the brake shoe contacts the drum.

2. *Back off adjustment.* Back off on cam nut until a clearance of

BASIC HALF-TRACK VEHICLES (IHC) (PERSONNEL CARRIER M5, CAR M9A1, MULTIPLE GUN MOTOR CARRIAGE M14, AND SIMILAR IHC VEHICLES)

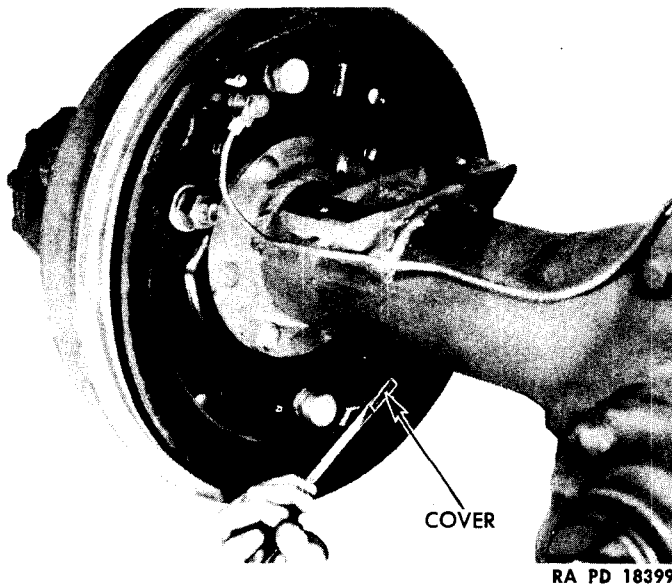

RA PD 18399

Figure 132 – Adjusting Hole Cover – Removal

0.008 inch (eight thousandths inches) is obtained at the *heel* end of the forward shoe.

3. *Remove adjusting hole cover* (fig. 132).

4. *Adjust star wheel.*

SCREWDRIVER

Insert screwdriver and turn star wheel, moving handle of screwdriver toward the axle until the shoe contacts the drum.

5. *Back off adjustment.* Back off star wheel by moving the handle of the screwdriver away from the axle until a clearance of 0.012 inch (twelve thousandths inch) is obtained at the *toe* end of the shoe as measured approximately 1½ inches from the end of the lining.

6. *Recheck clearances* (fig. 133). Recheck clearances to 0.008 inch and 0.012 inch. Tighten front shoe cam adjustment, being careful not to alter adjustment.

CAUTION: Do not alter positions of anchors (fig. 121).

(3) **FRONT BRAKE ADJUSTMENT AFTER RELINING** (figs. 119 and 120).

(a) *Equipment.*

GAGE, feeler

WRENCH, end, 1½/16-in.

WRENCH, end, 15/16-in.

BRAKE SYSTEMS

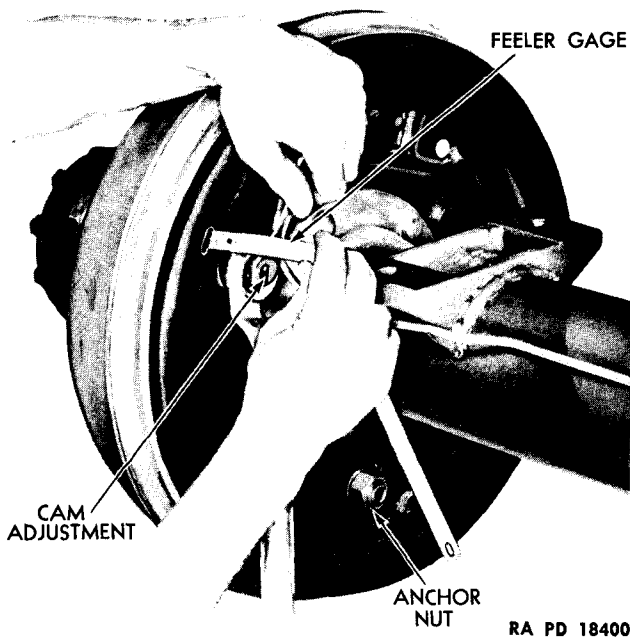

Figure 133 - Checking Shoe Clearance

(b) Procedure.

1. Position shoe centralizing anchors (figs. 119 and 120).

WRENCH, $1\frac{5}{16}$ -in.

Place shoe centralizing anchors so that punch marks are away from the shoes. In this position the punch marks will face each other.

2. Position cam adjustments (fig. 130).

WRENCH, $1\frac{1}{16}$ -in.

There are no punch marks on cam adjustments. Rotate cam adjustment on the front shoe as far as possible in the direction of the reverse rotation of the wheel. Rotate cam adjustment on the rear shoe as far as possible in the direction of the *forward* rotation of the wheel.

3. Adjust front brake shoe (figs. 119 and 120). Rotate cam adjustment in the direction of forward rotation of the wheel until there is a definite brake drag felt. Turn shoe centralizing anchor in the direction of *forward* rotation of the wheel (moving the punch mark away from the drum) until a definite brake drag is felt. Note position of the punch mark. Turn shoe centralizing anchor back in the opposite direction until the same amount of brake drag is felt. Note position of the punch mark. Turn shoe centralizing anchor until punch mark is half way between the two extremes, producing a free wheel. In this position the

BASIC HALF-TRACK VEHICLES (IHC) (PERSONNEL CARRIER M5, CAR M9A1, MULTIPLE GUN MOTOR CARRIAGE M14, AND SIMILAR IHC VEHICLES)

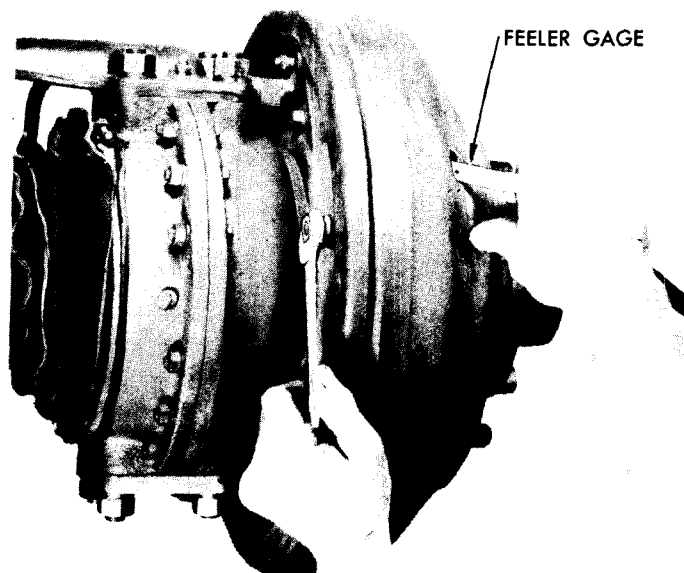

RA PD 18401

Figure 134 — Adjusting Brake Shoe Clearance

shoe is roughly centralized. NOTE: When shoe centralizing anchor is turned in the direction of the *reverse* rotation of the wheel, it will *decrease* the clearance at the *heel* and *increase* the clearance at the *toe* an equal amount at the same time. When the shoe centralizing anchor is moved in the opposite direction the clearance will *increase* at the *heel* and *decrease* at the *toe* an equal amount at the same time.

4. *Adjust clearances* (fig. 134). Check both *toe* and *heel* of the shoe with a thickness gage to determine the next steps to be taken. Adjust cam adjustment and shoe centralizing anchor in accordance with above instructions until a clearance of 0.005 inch (five thousandths inch) is obtained at the *heel* and a clearance of 0.010 inch (ten thousandths inch) is obtained at the *toe* end of the shoe as measured at approximately 1½ inches from the ends of the lining.

5. *Tighten lock nut* (fig. 135). Tighten lock nut *securely* on shoe centralizing anchor. Recheck clearances at both *toe* and *heel* ends of shoe to make sure adjustment has not altered.

6. *Adjust rear shoe*. Repeat operations in 3, 4, and 5, above at rear shoe cam adjustment and at shoe centralizing anchor substituting the word "*reverse*" for the word "*forward*" in the description of wheel rotation.

BRAKE SYSTEMS

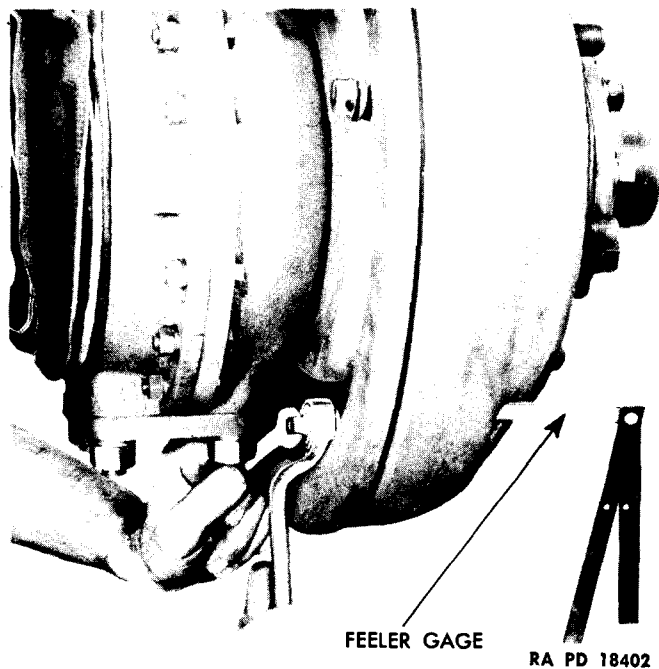

Figure 135 — Adjusting Brake Shoe Clearance

(4) ADJUSTMENT AFTER RELINING, REAR BRAKES.

(a) Equipment.

GAGE, feeler
SCREWDRIVER

WRENCH, Allen, $\frac{3}{8}$ -in.
WRENCH, box, $1\frac{1}{16}$ -in.

(b) Procedure.

1. Remove star wheel cover and anchor nut covers (fig. 136).
2. Position shoe centralizing anchors (fig. 137).

WRENCH, Allen, $\frac{3}{8}$ -in.

WRENCH, box, $1\frac{1}{16}$ -in.

Place the punch marks on the shoe centralizing anchors and cam adjustment away from the shoes. This will place adjustment cam and anchors in their full "OFF" position.

3. *Position star wheel.* Rotate star wheel to full "OFF" position by moving handle of screwdriver away from the axle until the star wheel is as far as it will go.

4. *Centralize front shoe* (figs. 137 and 138). Turn cam adjustment in the direction of the *forward* rotation of the sprocket (moving the punch mark *toward* the drum) until the shoe contacts the drum. Turn the shoe centralizing anchor, using an Allen wrench, moving the punch mark away

**BASIC HALF-TRACK VEHICLES (IHC) (PERSONNEL CARRIER M5, CAR M9A1,
MULTIPLE GUN MOTOR CARRIAGE M14, AND SIMILAR IHC VEHICLES)**

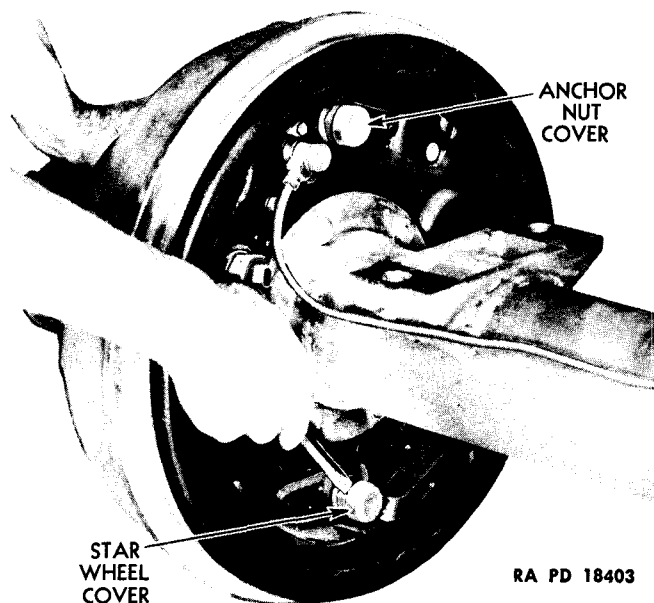

Figure 136 — Anchor Nut and Star Wheel Cover — Removal

from the drum (in the direction of the *forward* rotation of the sprocket) until the shoe contacts the drum. Note the position of the punch mark, then turn in the opposite direction (moving punch mark toward the drum) until the brake shoe again contacts the drum. Note position of punch mark. Turn anchor adjustment back until punch mark is half way between these two extremes. This will indicate that the shoe is roughly centralized. **NOTE:** When cam adjustment is turned in the direction of the *forward* rotation of the sprocket (moving the punch mark toward the drum) the clearance at *both* the *toe* and *heel* will be decreased at the same time. When the cam adjustment is turned in the opposite direction (moving the punch mark away from the drum) the clearance at *both* the *toe* and *heel* will be increased at the same time. When the shoe centralizing anchor is turned in the direction of the *reverse* rotation of the sprocket (moving the punch mark toward the drum) the clearance at the *heel* will be *decreased* and the clearance at the *toe* will be *increased* an equal amount at the same time. When turned in the opposite direction (moving the punch mark away from the drum) the clearance at the *heel* will be *increased* and the clearance at the *toe* will be *decreased* an equal amount at the same time.

5. *Adjust clearances* (figs. 134 and 135). Check *both* toe and heel of the shoe with a thickness gage to determine the next steps to be taken

BRAKE SYSTEMS

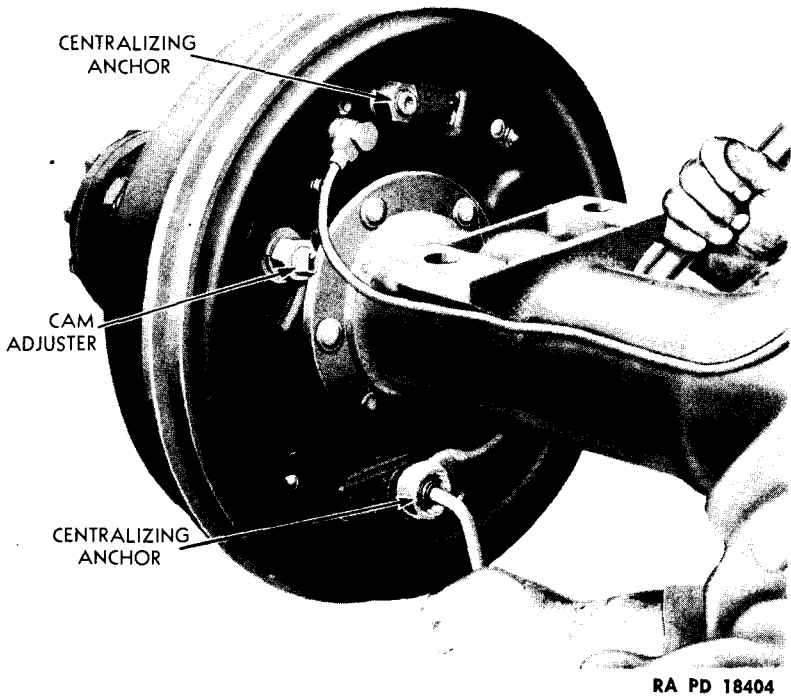

Figure 137 – Centralizing Brake Shoes

in moving the adjustments. Adjust cam and the shoe centralizing anchor in accordance with the above instructions until a clearance of 0.008 inch (eight thousandths inch) is obtained at the *heel* end of the shoe and a clearance of 0.012 inch (twelve thousandths inch) is obtained at the *toe* end of the shoe as measured at approximately 1½ inches from the ends of the lining.

6. *Lock adjustments.* Hold this adjustment while *securely* tightening the lock nut on shoe centralizing anchor and hold adjustment while *securely* tightening the lock nut on cam adjustment.

7. *Recheck clearances.* Recheck the clearances at both toe and heel to be sure adjustment has not altered.

8. *Centralize rear shoe* (fig. 138). Turn the star wheel, moving the handle of the screwdriver toward the axle until the shoe contacts the drum. Turn the shoe centralizing anchor in the direction of the *forward* rotation of the wheel (moving the punch mark away from the drum) until the shoe contacts the drum. Note the position of the punch mark, then turn in the opposite direction (moving the punch mark *toward* the drum) until the shoe again contacts the drum. Note the position of the punch mark. Turn anchor back until the punch mark is half way between

BASIC HALF-TRACK VEHICLES (IHC) (PERSONNEL CARRIER M5, CAR M9A1, MULTIPLE GUN MOTOR CARRIAGE M14, AND SIMILAR IHC VEHICLES)

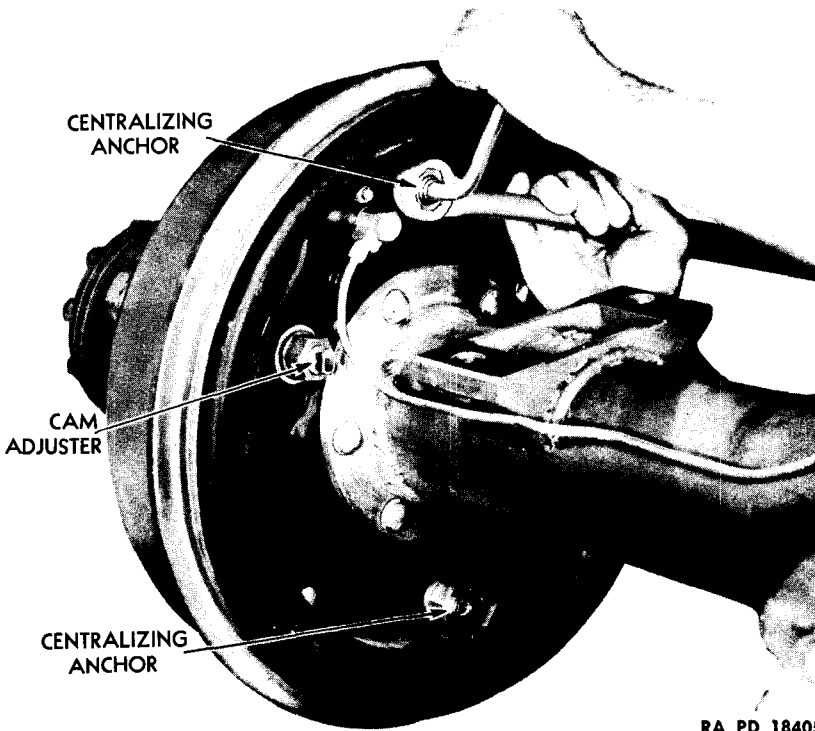

RA PD 18405

Figure 138 – Centralizing Brake Shoes

the two extremes. This will indicate that shoe is roughly centralized. **NOTE:** When the star wheel is turned with handle of the screwdriver moving toward the axle, the clearance at *both* the toe and heel will be *increased* at the same time. When the star wheel is turned with the handle of the screwdriver moving away from the axle, the clearance at *both* the toe and heel will be *decreased* at the same time. When the shoe centralizing anchor is turned in the direction of the reverse rotation of the sprocket (moving the punch mark *toward* the drum) the clearance at the *heel* will be *increased* and the clearance at the *toe* will be *decreased* an equal amount at the same time.

9. *Adjust clearances.* Check *both* toe and heel of the shoe with a thickness gage to determine the next steps to be taken in moving the adjustments. Adjust the star wheel and the shoe centralizing anchor (fig. 133) in accordance with the above instructions until a clearance of 0.008 inch (eight thousandths inch) is obtained at the *heel* end of the shoe and a clearance of 0.012 inch (twelve thousandths inch) is obtained at the *toe* end of the shoe as measured at approximately 1½ inches from the ends of the linings.

BRAKE SYSTEMS

10. *Lock adjustments.* Hold the adjustments while tightening securely the lock nut on shoe centralizer anchor.

11. *Recheck clearances.* Recheck the clearances at *both* toe and heel to be sure that adjustment has not altered.

12. *Replace star wheel cover and anchor nut covers.*

(5) **BRAKE LINES.** Figure 98 illustrates the brake piping diagram of this vehicle. Any leaks in the metal tubing or flexible lines will impair the effectiveness of the brakes. All couplings, connections, and fittings must be adjusted and tightened by tightening the nuts on the hose and tubing.

66. BLEEDING THE LINES.

a. Bleeding of the hydraulic system consists of displacing all trapped air which may have accumulated in the system with the fluid, by means of forcing the fluid through the lines until it flows in a solid stream from the bleeder valve at each of the wheel cylinders, each of the drive sprocket cylinders, and each of the three bleeder valves at the Hydrovac. This operation is only necessary when some part of the hydraulic system has been disconnected or when the fluid level in the master cylinder has become too low. *Only approved brake fluid should be used. Never use oil.* On this vehicle, the Hydrovac should be bled of trapped air *first*; then bleed the wheel cylinders and sprocket cylinders.

(1) PREPARATORY PROCEDURE.

(a) *Equipment.*

BLEEDER JAR
BLEEDER TUBE
SCREWDRIVER

WRENCH, end, $\frac{3}{8}$ -in.
WRENCH, end, $\frac{3}{4}$ -in.

(b) *Procedure.*

1. *Remove floor plate.*

SCREWDRIVER

Remove screws holding floor plate in driver's compartment over the master cylinder filler plug. Remove the plate.

2. *Remove filler plug from master cylinder.*

WRENCH, $\frac{3}{4}$ -in.

Remove filler plug and gasket from top of master cylinder. Be careful that no dirt is allowed to enter the master cylinder.

3. *Install fluid filler.*

FILLER, hydraulic fluid

Insert nozzle of fluid filler into filler hole of master cylinder.

BASIC HALF-TRACK VEHICLES (IHC) (PERSONNEL CARRIER M5, CAR M9A1, MULTIPLE GUN MOTOR CARRIAGE M14, AND SIMILAR IHC VEHICLES)

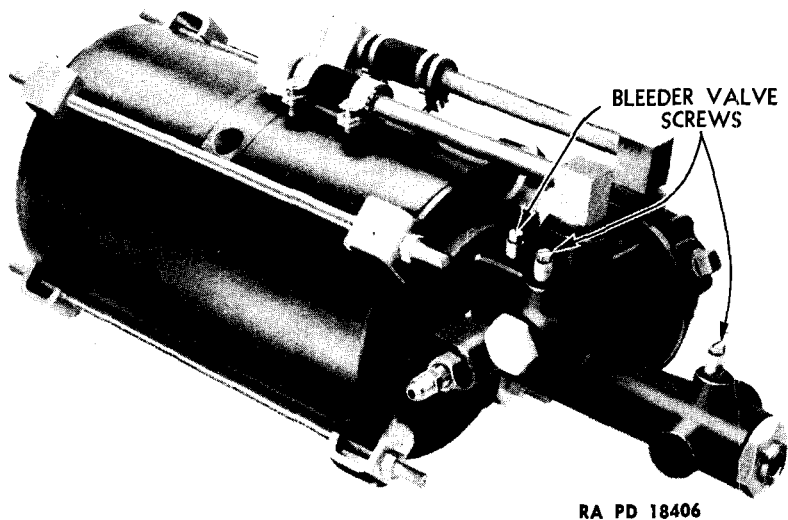

RA PD 18406

Figure 139 — Hydrovac Power Cylinder, Showing Bleeder Screws

(2) BLEEDING HYDROVAC (fig. 139).

(a) *Equipment.*

BLEEDER JAR
BLEEDER TUBE

SCREWDRIVER
WRENCH, end, $\frac{3}{8}$ -in.

(b) *Procedure.*

1. *Disconnect vacuum line at Hydrovac.*

SCREWDRIVER

Loosen clamp screw at vacuum line at Hydrovac.

2. *Bleed valve nearest power cylinder.*

BLEEDER JAR
BLEEDER TUBE

SCREWDRIVER
WRENCH, end, $\frac{3}{8}$ -in.

Remove the small bleeder valve screw from valve nearest power cylinder and insert bleeder tube, the end of which should be in a glass container holding a small amount of brake fluid. The end of the tube should be below the surface of the liquid. Unscrew the bleeder connection nut about three-fourths turn. Depress brake pedal *slowly* by hand and then allow pedal to return *slowly* to its released position. Continue this pumping action until no more air is expelled at the end of the bleeder tube as indicated by bubbles. Tighten bleeder tube. Install bleeder valve screw. **NOTE:** Master cylinder supply tank must be kept filled with brake fluid during the bleeding operation to prevent air from entering the system at the master cylinder.

BRAKE SYSTEMS

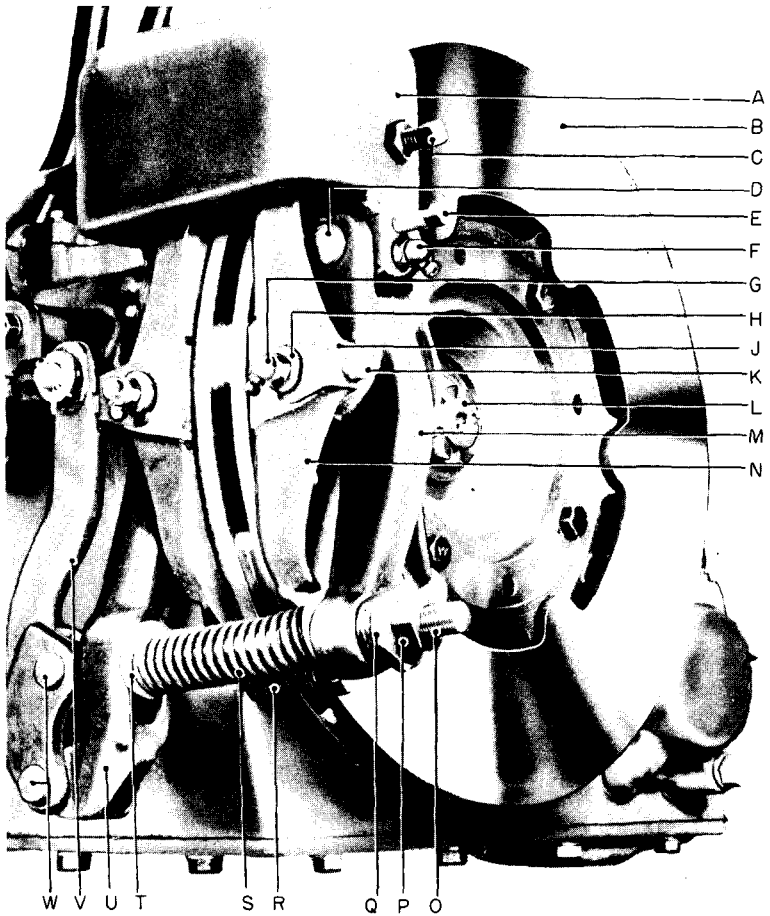

- | | |
|----------------------------------------------------------|---------------------------------------------------|
| A - BRAKE ANCHOR BRACKET | L - COMPANION FLANGE NUT |
| B - BRAKE DISC ASSEMBLY | M - BRAKE SHOE REAR LEVER ARM |
| C - BRAKE SHOE ADJUSTING SET
SCREW(2),W/LOCK NUT(2) | N - BRAKE SHOE(2) |
| D - LEVER ARM ANCHOR PIN(2) | O - OPERATING LEVER TIE ROD |
| E - LEVER ARM ANCHOR PIN LOCK
SCREW(2) | P - TIE ROD LOCK NUT |
| F - LEVER ARM ANCHOR PIN
LUBRICATING FITTING(2) | Q - TIE ROD SPHERICAL NUT |
| G - BRAKE SHOE PIN LUBRICATING
FITTING(2) | R - BRAKE SHOE SPRING |
| H - BRAKE SHOE PIN(2) | S - LEVER ARM RELEASE SPRING |
| J - BRAKE SHOE PIN RETAINER | T - RELEASE SPRING WASHER |
| K - BRAKE SHOE PIN RETAINER
SCREW(2),W/LOCK WASHER(2) | U - BRAKE SHOE FRONT LEVER ARM |
| | V - OPERATING LEVER |
| | W - OPERATING LEVER CLEVIS PIN
W/COTTER PIN(2) |

RA PD 3541

Figure 140 — Drive Shaft Brake — Installed

BASIC HALF-TRACK VEHICLES (IHC) (PERSONNEL CARRIER M5, CAR M9A1, MULTIPLE GUN MOTOR CARRIAGE M14, AND SIMILAR IHC VEHICLES)

3. Repeat operation in step (2) (b), above at other two bleeder valves.

4. Reconnect vacuum line at Hydrovac.

(3) BLEEDING WHEEL AND DRIVE SPROCKET CYLINDER.

(a) Equipment.

SCREWDRIVER

WRENCH, end, $\frac{3}{8}$ -in.

(b) Procedure.

1. Follow bleeding procedure at each front wheel cylinder and each drive sprocket cylinder as outlined in step (2) (b), above.

(4) REMOVE FLUID FILLER.

Remove fluid filler, install filler plug and gasket at master cylinder and reinstall floor plate.

67. DRIVE SHAFT BRAKE (figs. 140 and 141).

a. **Description.** The drive shaft brake comprises a ventilated disk mounted on the propeller shaft companion flange between the transmission and rear axle, two brake shoes which bear on the disk when actuated by the hand brake lever, a supporting bracket, and the necessary linkage. The hand brake should be set after the vehicle is brought to a stop and not when the vehicle is in motion.

b. **Maintenance and Adjustment (figs. 142 and 143).** Brake shoes normally must be parallel to, but not touching, the disk when the brake is in released position. When the linings become worn so the brake will not hold, adjustment should be made as follows:

(1) EQUIPMENT.

GAGE, feeler

WRENCH, open-end, $\frac{3}{8}$ -in.

PLIERS

WRENCH, open-end, $\frac{3}{4}$ -in.

SHIM, 0.010-in. (2)

WRENCH, open-end, $1\frac{1}{4}$ -in.

WRENCH, open-end, $\frac{5}{16}$ -in.

(2) OPERATION.

(a) Release Hand Lever Fully.

(b) Remove Hand Brake Lever Pull Rod Clevis Pin.

(c) Tighten Tie Rod Spherical Nut (fig. 140).

WRENCH, open-end, $\frac{3}{4}$ -in.

WRENCH, open-end, $1\frac{1}{4}$ -in.

Loosen tie rod lock nut and tighten spherical nut so that lever arm release spring exerts enough pressure to bring operating lever to stop solidly against brake shoe front lever arm.

BRAKE SYSTEMS

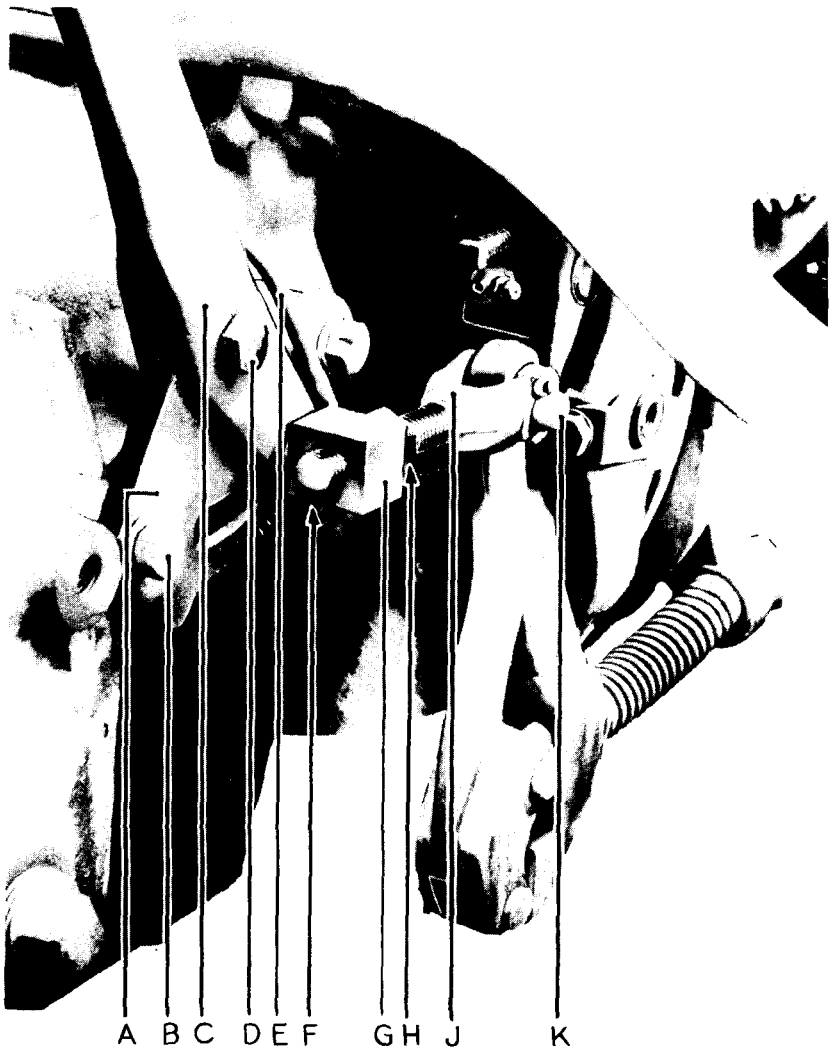

- A--HAND BRAKE LEVER QUADRANT
B--QUADRANT TO CASE SCREWS (2) W/LOCK WASHERS (2)
C--HAND BRAKE LEVER ASSEMBLY
D--HAND BRAKE TO QUADRANT SCREW W/NUT AND COTTER PIN
E--HAND BRAKE LEVER PAWL ROD
F--HAND BRAKE LEVER CLEVIS PIN, W/PAWL AND COTTER PIN
G--HAND BRAKE LEVER BLOCK, W/WASHER AND COTTER PIN
H--PULL ROD LOCK NUT
J--DRIVE SHAFT BRAKE YOKE END PULL ROD
K--PULL ROD CLEVIS PIN, W/COTTER PIN

RA PD 18527

Figure 141 — Drive Shaft Brake Linkage

BASIC HALF-TRACK VEHICLES (IHC) (PERSONNEL CARRIER M5, CAR M9A1, MULTIPLE GUN MOTOR CARRIAGE M14, AND SIMILAR IHC VEHICLES)

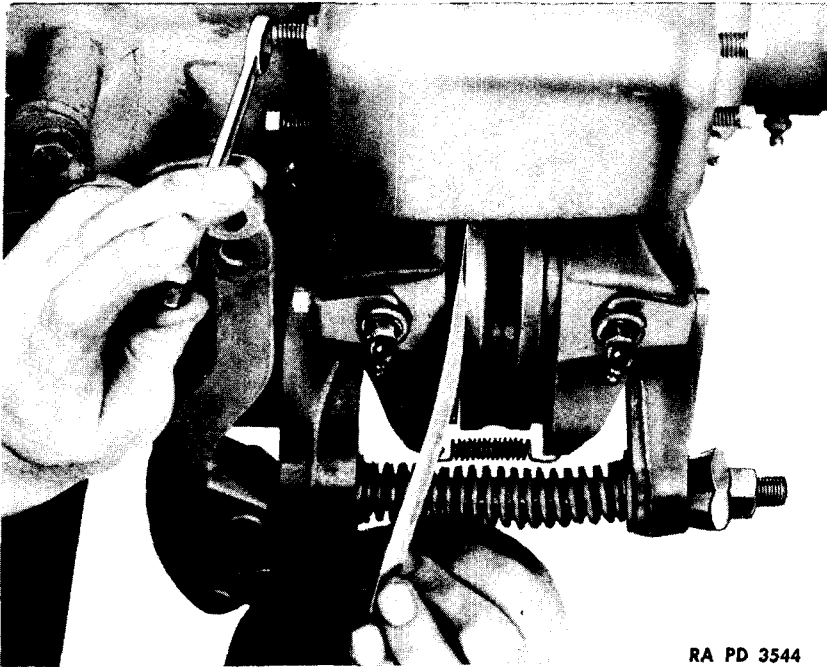

RA PD 3544

Figure 142 – Drive Shaft Brake Shoe Adjustment

(d) Adjust Brake Yoke End Pull Rod (fig. 141).

SHIM, 0.010-in., or GAGE, WRENCH, open-end, 3/4-in.
feeler

Insert a 0.010-inch shim or feeler gage between the front shoe lining and the disk. Loosen pull rod lock nut and adjust pull rod to maintain clearance of 0.010 inch.

(e) Connect Brake Yoke End Pull Rod.

PLIERS.

Connect brake yoke end pull rod to operating lever. Insert clevis pin and cotter pin.

(f) Adjust Rear Brake Shoe.

SHIM, 0.010-in., or GAGE, WRENCH, open-end, 1 1/4-in.
feeler

Insert a 0.010-inch feeler gage between rear shoe lining and disk. Tighten spherical nut to maintain 0.010-inch clearance.

(g) Adjust Brake Shoe Adjusting Set Screws (fig. 140).

WRENCH, open-end, 5/16-in. WRENCH, open-end, 3/8-in.

BRAKE SYSTEMS

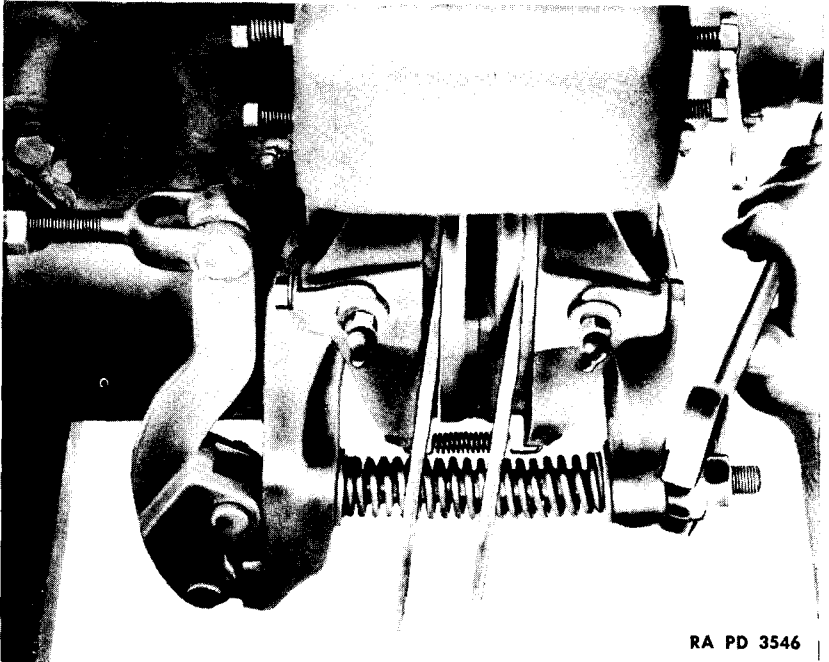

RA PD 3546

Figure 143 – Drive Shaft Brake Shoe Adjustment

Be sure that tension spring at bottom of brake shoe is in position. Loosen lock nut on adjusting set screw. Adjust set screws so that linings are parallel to steel disk. Tighten lock nut.

(h) *Remove Shims.*

c. Drive Shaft Brake Shoe Replacement (figs. 140 and 141).

(1) EQUIPMENT.

PLIERS

SHIM, .010-in. (2)

WRENCH, open-end, $\frac{5}{16}$ -in.

WRENCH, open-end, $\frac{3}{8}$ -in.

WRENCH, open-end, $\frac{7}{16}$ -in.

WRENCH, open-end, $\frac{1}{2}$ -in.

WRENCH, open-end, $\frac{3}{4}$ -in.

WRENCH, open-end, $1\frac{1}{4}$ -in.

(2) PROCEDURE.

(a) *Place Hand Lever in Fully Released Position.*

(b) *Disconnect Drive Shaft Brake Yoke Pull Rod.*

PLIERS

Remove cotter pin from drive shaft brake yoke and pull rod and remove clevis pin.

(c) *Remove Brake Shoe Tension Spring (fig. 140).*

PLIERS

Remove brake shoe spring from lower end of brake shoes.

**BASIC HALF-TRACK VEHICLES (IHC) (PERSONNEL CARRIER M5, CAR M9A1,
MULTIPLE GUN MOTOR CARRIAGE M14, AND SIMILAR IHC VEHICLES)**

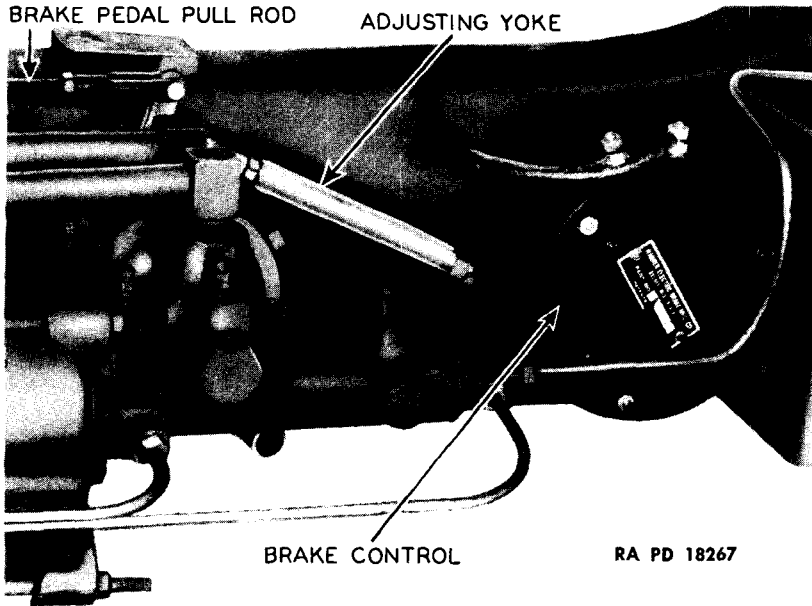

Figure 144 – Electric Trailer Brake Controller – Installed

(d) *Remove Spherical Nut from Operating Lever Tie Rod (fig. 140).*

WRENCH, $\frac{3}{4}$ -in.

WRENCH, $1\frac{1}{4}$ -in.

Remove lock nut from spherical nut on operating lever tie rod. Remove spherical nut.

(e) *Disconnect Operating Lever Tie Rod from Brake Shoe Lever Arm.*

Place operating lever in applied position (toward the front) to disconnect tie rod from rear brake shoe lever arm. Remove lever arm release spring.

(f) *Remove Brake Shoe Retainer Pin Screws.*

WRENCH, open-end, $\frac{3}{4}$ -in.

Remove front and rear brake shoe retainer pin screws.

(g) *Remove Brake Shoe Pivot Pins.*

(h) *Remove Brake Shoes.*

(i) *Install Brake Shoes.*

(j) *Install Brake Shoe Pivot Pins.*

BRAKE SYSTEMS

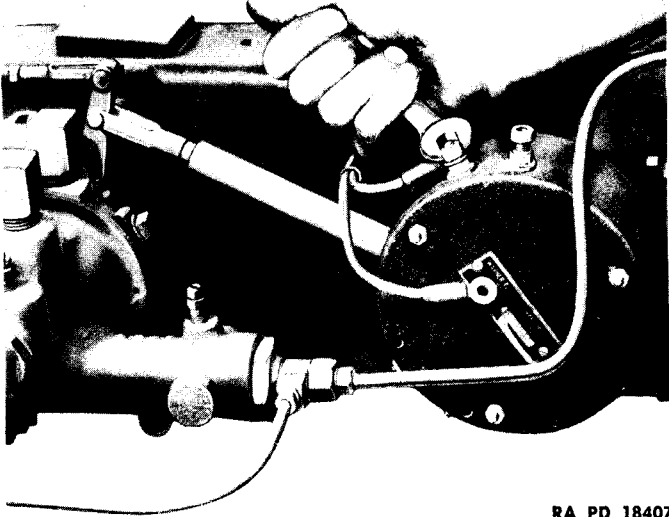

RA PD 18407

Figure 145 — Disconnecting Controller Cables

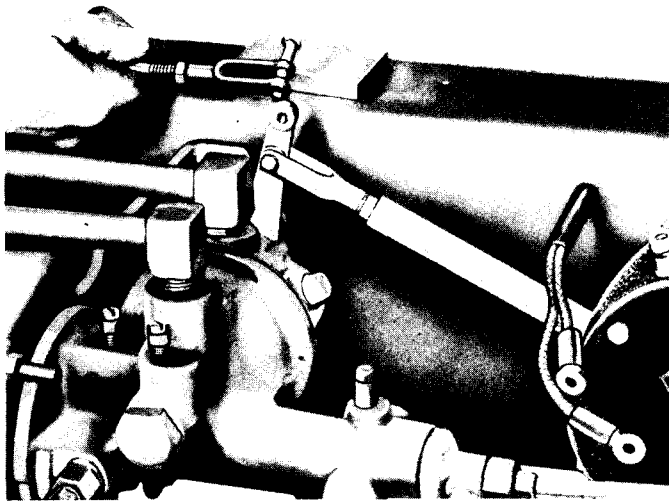

RA PD 18408

Figure 146 — Disconnecting Brake Pedal Pull Rod

**BASIC HALF-TRACK VEHICLES (IHC) (PERSONNEL CARRIER M5, CAR M9A1,
MULTIPLE GUN MOTOR CARRIAGE M14, AND SIMILAR IHC VEHICLES)**

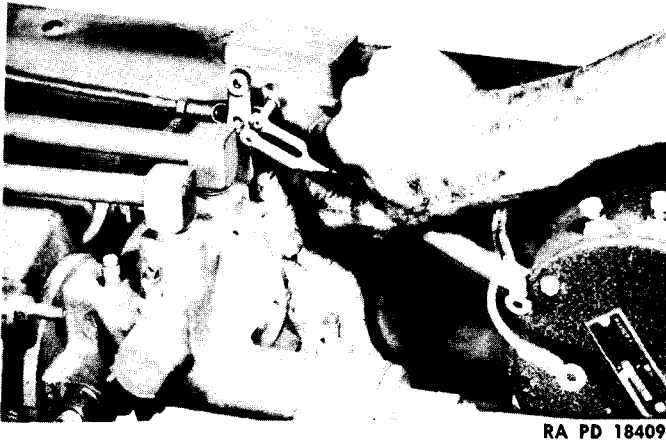

Figure 147 — Disconnecting Overtravel Clevis Rod

- (k) *Install Brake Shoe Retainer Pin Screws.*
- (l) *Install Brake Shoe Tension Spring at Bottom of Shoes.*
- (m) *Install Lever Arm Release Spring.*
- (n) *Connect Operating Lever Tie Rod at Brake Shoe Rear Lever Arm.*
- (o) *Adjust Brake. (Subpar. b (2) (c) to (h), above).*

68. ELECTRIC TRAILER BRAKE CONTROLLER (fig. 144).

a. Description. A manually operated electric brake controller is connected by means of adjustable linkage to the foot brake pedal. The device provides for application of electric trailer brakes at the same time and in proportion to the braking effort of the propelling vehicle. The intensity of application may be adjusted by means of the load control rheostat on the instrument panel. Turning the knob to the left decreases and to the right increases the braking effect.

b. Electric Trailer Brake Maintenance and Adjustments. No particular maintenance is required other than to keep nuts and screws tight and linkage free. A rod shift device is provided so that extreme variation in the relative total movement of the pedal rod and controller lever may be obtained. The shift is made by changing the clevis position on the controller arm to the outer, center, or inner positions on the controller lever at the housing. Ordinarily, the controller lever and rod motion are correct when the shift assembly is connected in the inner position. Setting the shift lever in the outer position causes a longer rod

BRAKE SYSTEMS

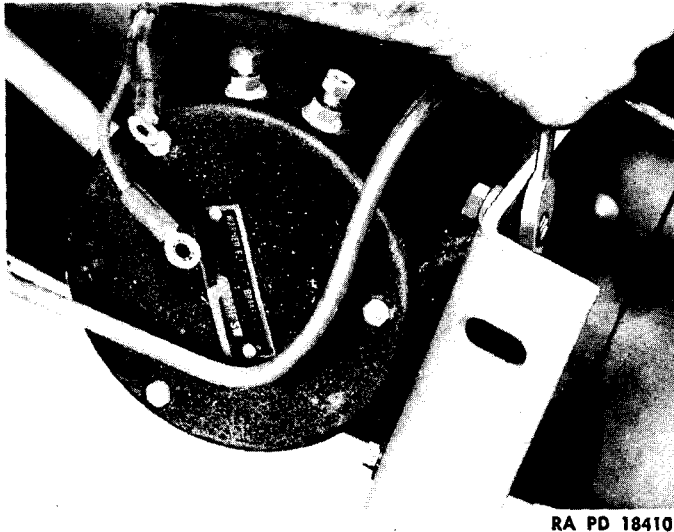

RA PD 18410

Figure 148 — Removing Controller-to-Bracket Attaching Bolts

motion for a given lever motion. Adjustment of the controller shift is accomplished by the following procedure:

- (1) DISCONNECT THE CONTROLLER PULL ROD AT THE BRAKE PEDAL.
- (2) PLACE CONTROLLER LEVER AT CONTROLLER IN EXTREME "OFF" POSITION.
- (3) PLACE BRAKE PEDAL IN FULLY RELEASED POSITION.
- (4) LENGTHEN OR SHORTEN PULL ROD TO PERMIT ATTACHMENT TO BRAKE PEDAL.

c. **Electric Trailer Brake Controller Replacement.** Should the controller become inoperative, it should be replaced as follows:

- (1) EQUIPMENT.

PLIERS

WRENCH, end, $\frac{9}{16}$ -in.

WRENCH, end, $\frac{7}{16}$ -in.

- (2) PROCEDURE.

- (a) *Disconnect Both Cables from Controller.*

WRENCH, end, $\frac{7}{16}$ -in.

Remove retaining nut and lock washers from terminals and disconnect cables (fig. 145).

BASIC HALF-TRACK VEHICLES (IHC) (PERSONNEL CARRIER M5, CAR M9A1, MULTIPLE GUN MOTOR CARRIAGE M14, AND SIMILAR IHC VEHICLES)

(b) Disconnect Brake Pedal Pull Rod at Relay Lever (fig. 146).

PLIERS

Remove cotter pin from clevis pin and remove pin to disconnect brake pedal pull rod.

(c) Disconnect Over-travel Clevis Rod at Relay Lever (fig. 147).

PLIERS

Remove cotter pin from over-travel clevis rod at relay lever. Remove clevis pin.

(d) Remove Controller-to-Bracket Attaching Bolts, Nuts, and Washers (fig. 148).

WRENCH, end, $\frac{9}{16}$ -in.

Remove two attaching bolts, nuts, and washers at bracket. Remove controller.

(e) Install Replacement Controller-to-Bracket with Bolts, Nuts, and Washers.

(f) Connect Over-travel Clevis Rod to Relay Lever.

(g) Connect and Adjust Brake Pedal Pull Rod at Relay Lever (substep (b) above).

Section XIV

CLUTCH

	Paragraph
Description	69
Operation	70
Trouble shooting	71
Maintenance and adjustment	72
Replacement	73

69. DESCRIPTION (fig. 149).

a. The clutch in this vehicle is a single plate, dry disk type unit and is secured to the flywheel by 12 cap screws. The clutch transmits power from the engine to the transmission. The weight of the clutch assembly is 51 pounds.

70. OPERATION.

a. Depressing the clutch pedal causes the throw-out bearing to move toward the front to contact the release levers. Pressure of the bearing against the release levers relieves the spring pressure on the clutch pressure plate or driving plate. In this position, the clutch is "released." The clutch must be either fully engaged or fully released while driving. The clutch should be engaged slowly and not allowed to engage suddenly. A properly adjusted clutch will take hold gradually, will not slip, and will release instantly when the pedal is depressed.

71. TROUBLE SHOOTING.

a. Improper operation of the clutch will be indicated by clutch slippage, grabbing, or rattling, causes and remedies of which are as follows:

(1) **SLIPPING.**

Possible Cause	Possible Remedy
Improper clutch pedal travel.	Adjust clutch pedal (par. 72 a).
Weak spring action.	Replace clutch (par. 73).
Torn clutch facings.	Replace driven member (par. 73).
Sticking pressure plate.	Replace clutch (par. 73).

(2) **GRABBING.**

Oil on facings.	Replace driven member (par. 73).
Loose engine mountings.	Tighten engine mountings.
Sticking pressure plate.	Replace clutch (par. 73).

BASIC HALF-TRACK VEHICLES (IHC) (PERSONNEL CARRIER M5, CAR M9A1, MULTIPLE GUN MOTOR CARRIAGE M14, AND SIMILAR IHC VEHICLES)

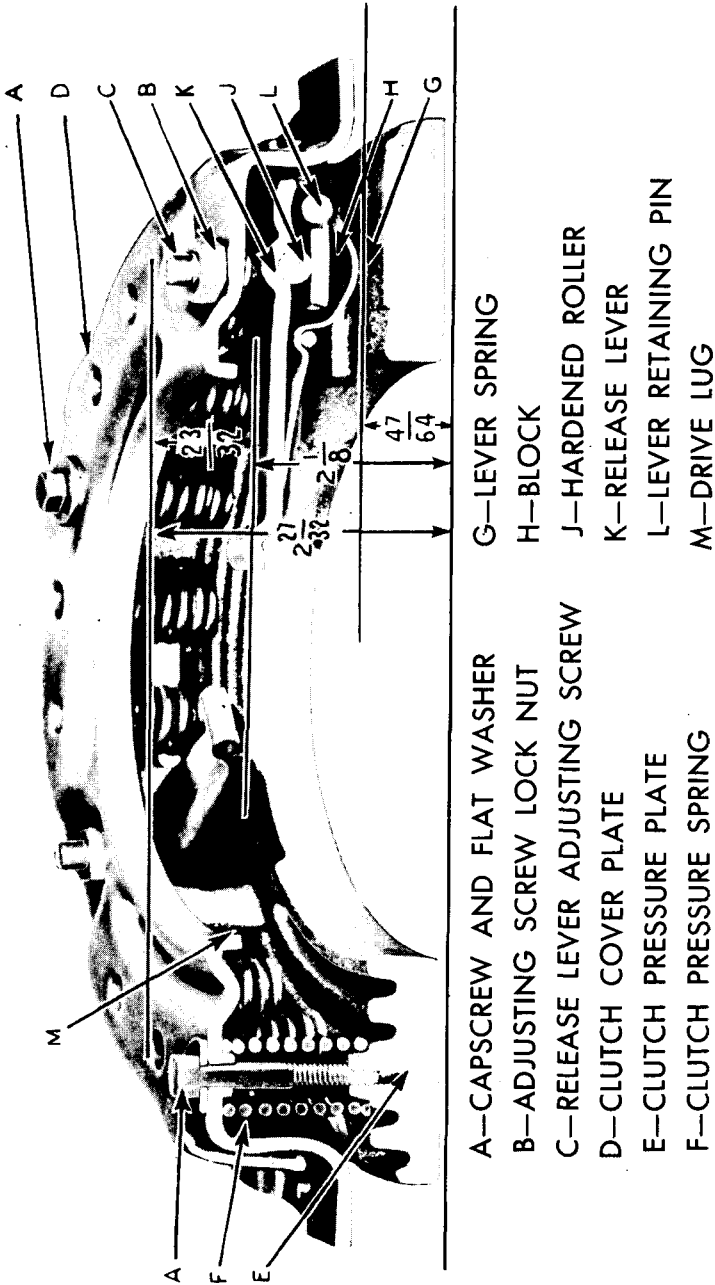

RA PD 18526

Figure 149 — Clutch — Sectionalized

CLUTCH

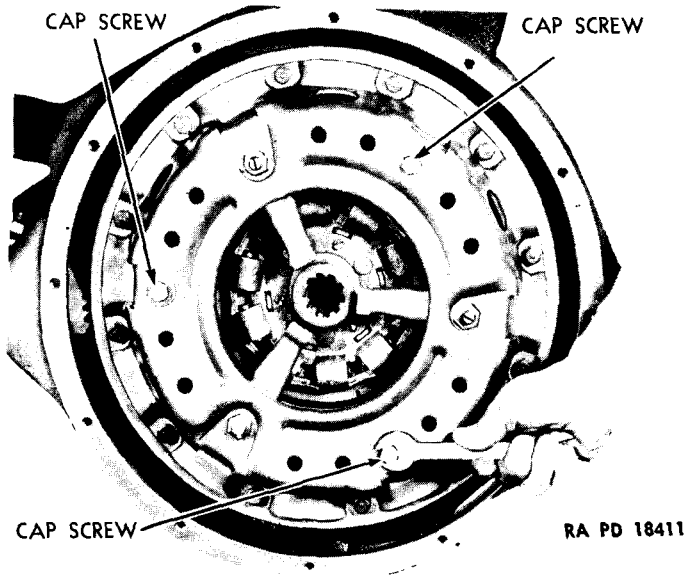

Figure 150 — Retaining Cap Screws — Installation

(3) RATTLING.

Possible Cause	Possible Remedy
Loose or weak pressure springs.	Replace clutch (par. 73).

(4) INSUFFICIENT PEDAL TRAVEL.

Release bearing too close to release levers.	Adjust pedal travel (par. 72).
----------------------------------------------	--------------------------------

(5) TOO MUCH PEDAL TRAVEL.

Release bearing too far from release levers.	Adjust pedal travel (par. 72 a).
----------------------------------------------	----------------------------------

(6) CLUTCH WILL NOT STOP GEARS.

Too much pedal travel.	Adjust pedal travel (par. 72 a).
------------------------	----------------------------------

b. Remedy. The using arms ordinarily will not attempt any repairs except to adjust for normal wear on the clutch facings through adjustment of pedal travel. Should other symptoms or defects arise report to ordnance maintenance personnel.

72. MAINTENANCE AND ADJUSTMENT.

a. The clutch should be adjusted when the natural wear on the clutch facings has decreased the free travel of the clutch pedal before

BASIC HALF-TRACK VEHICLES (IHC) (PERSONNEL CARRIER M5, CAR M9A1, MULTIPLE GUN MOTOR CARRIAGE M14, AND SIMILAR IHC VEHICLES)

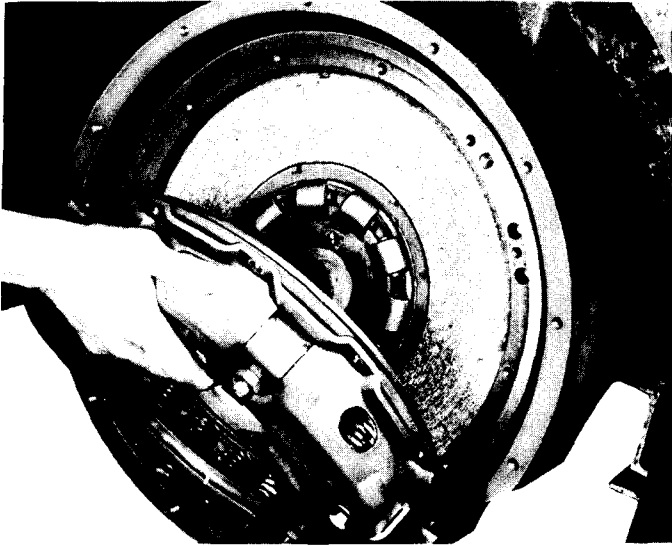

Figure 151 — Clutch Assembly — Removal

RA PD 18412

disengagement of the clutch pedal starts. The clutch pedal free travel should be adjusted to 1¾ to 2 inches of travel before clutch disengagement begins.

b. Procedure.

(1) EQUIPMENT.

PLIERS

WRENCH, end, 5/8-in.

(2) REMOVE COTTER PIN FROM ADJUSTABLE ROD-END YOKE AT RELEASE SHAFT.

PLIERS

Remove cotter pin from rod-end yoke pin at release shaft.

(3) LOOSEN LOCK NUT AT YOKE.

WRENCH, end, 5/8-in.

Loosen lock nut at yoke. Remove rod-end yoke pin.

(4) ADJUST YOKE.

Adjust yoke, either lengthening or shortening as necessary to provide 1¾ to 2 inches free travel. Disconnecting clutch pedal pull-back spring will facilitate feeling point of contact of release bearing with clutch release levers.

(5) INSTALL ROD-END YOKE PIN AND COTTER PIN.

(6) TIGHTEN LOCK NUT AT ADJUSTABLE YOKE.

CLUTCH

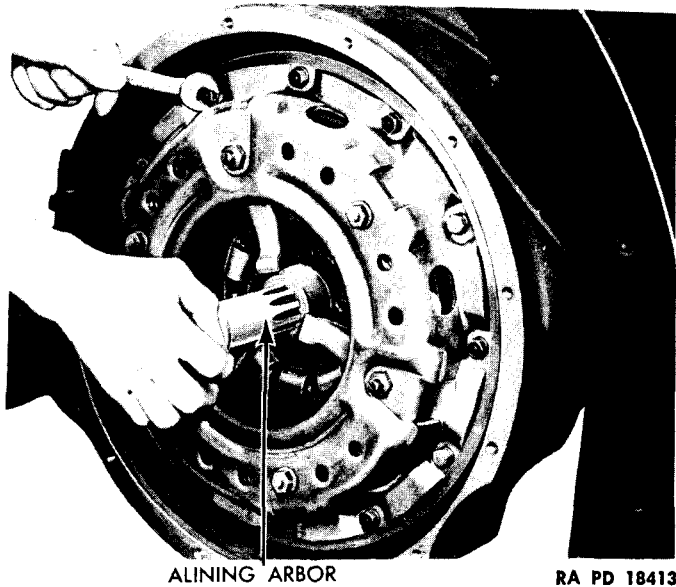

ALINING ARBOR

RA PD 18413

Figure 152 - Clutch - Installation

73. REPLACEMENT.

a. To replace a clutch assembly it is first necessary to remove the transmission from the chassis, unless the engine is already out for overhaul. (Engine removal is described in paragraph 118 and transmission removal is described in paragraph 148.)

b. Equipment.

ARBOR, clutch alining

EXTENSION, socket wrench

HANDLE, socket wrench

SCREW, cap, $\frac{3}{8}$ -16- x $1\frac{3}{4}$ -in.
(3)

WRENCH, end, $\frac{9}{16}$ -in.

WRENCH, socket, $\frac{9}{16}$ -in.

c. Install Holding Cap Screws (fig. 150).

SCREW, cap, $\frac{3}{8}$ -16- x $1\frac{3}{4}$ -in. (3)

Install three cap screws in clutch cover to hold assembly for facilitating removal of the assembly.

d. Remove Clutch (fig. 151).

EXTENSION, socket wrench

HANDLE, socket wrench

WRENCH, socket, $\frac{9}{16}$ -in.

Remove 12 cap screws holding clutch assembly to flywheel. Remove assembly and remove clutch disk.

BASIC HALF-TRACK VEHICLES (IHC) (PERSONNEL CARRIER M5, CAR M9A1, MULTIPLE GUN MOTOR CARRIAGE M14, AND SIMILAR IHC VEHICLES)**e. Install Clutch (fig. 152).**

ARBOR, clutch alining

Inspect clutch pilot bearing in flywheel and relubricate with **GREASE**, general purpose, No. 2. Place disk in position with long end of hub toward the rear. Place clutch in such position that arrow on clutch cover is as near as possible to letter "L" on flywheel. Insert 12 retaining cap screws and lock washers loosely in clutch assembly. Insert clutch alining arbor, or transmission main drive gear through driven member and enter end into flywheel bearing and hold while tightening retaining cap screws.

f. Remove Three Cap Screws from Cover.

WRENCH, end, $\frac{9}{16}$ -in.

Be sure to remove the three cap screws (fig. 150) and flat washers from cover assembly since they were installed merely to hold the assembly temporarily.

Section XV

COOLING SYSTEM

	Paragraph
Description	74
Trouble shooting	75
Radiator and shroud.....	76
Fan	77
Water pump	78
Fan belt adjustment.....	79
Thermostat	80
Surge tank	81
Antifreeze protection	82
Cooling system precautions.....	83

74. DESCRIPTION (figs. 153 and 154).

a. The engine cooling system consists of a thermostat, radiator, fan and shroud, centrifugal water pump, connecting lines and hose, and a surge tank. The system capacity is 31 quarts. The system may be drained by opening the drain cock located at the bottom of the radiator and removing the plug from the right-hand side of the block just behind the exhaust pipe and also removing the drain plug from the oil cooler at the bottom of the oil pan. Removal of the radiator filler cap will facilitate draining the system. The radiator fill pipe is at the upper left portion of the radiator and is accessible by raising the left-hand side of the hood. **NOTE:** After refilling radiator, permit engine to warm to approximately 160 F and then recheck water level. Add water if necessary.

75. TROUBLE SHOOTING.

a. **Overheating.**

Possible Cause	Possible Remedy
Insufficient coolant.	Refill system (par. 78 b (2) (o)).
Loose or damaged fan belts.	Adjust or replace belts (par. 79).
Thermostat stuck closed.	Replace thermostat (par. 80 b).
Defective water pump.	Replace water pump (par. 78 b).
Clogged cooling system.	Clean and flush system (par. 83)
Clogged radiator core.	Clean core (par. 83).
Incorrect engine timing.	Correct timing (par. 94).

BASIC HALF-TRACK VEHICLES (IHC) (PERSONNEL CARRIER M5, CAR M9A1,
MULTIPLE GUN MOTOR CARRIAGE M14, AND SIMILAR IHC VEHICLES)

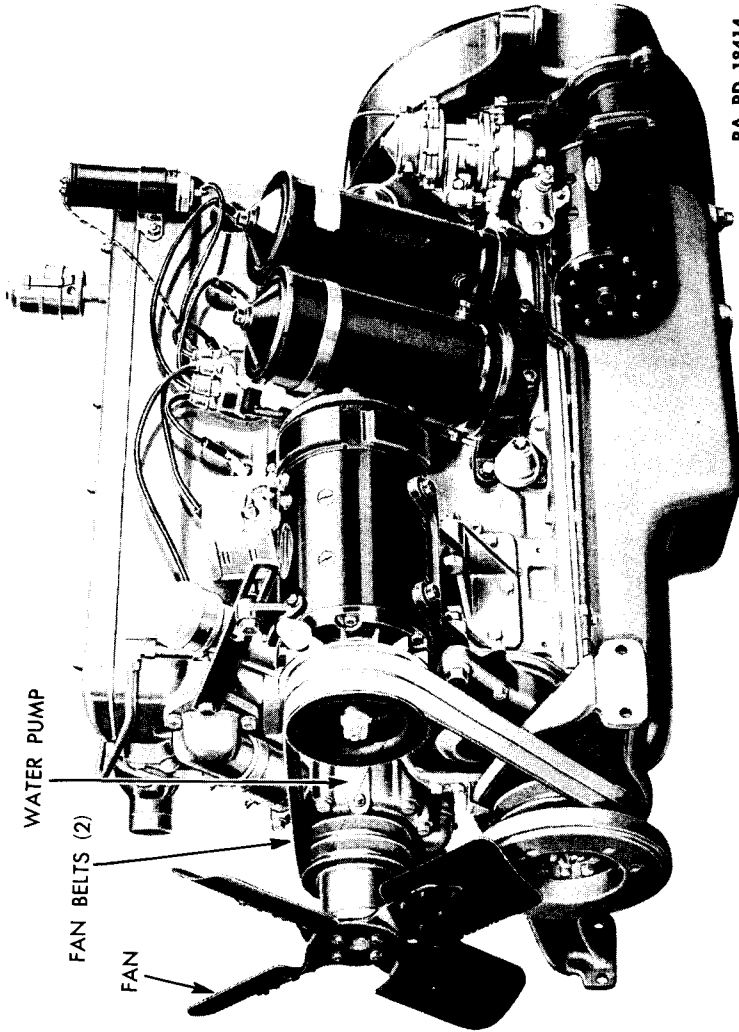

RA PD 18414

Figure 153 — Engine Showing Cooling System — Left Side

COOLING SYSTEM

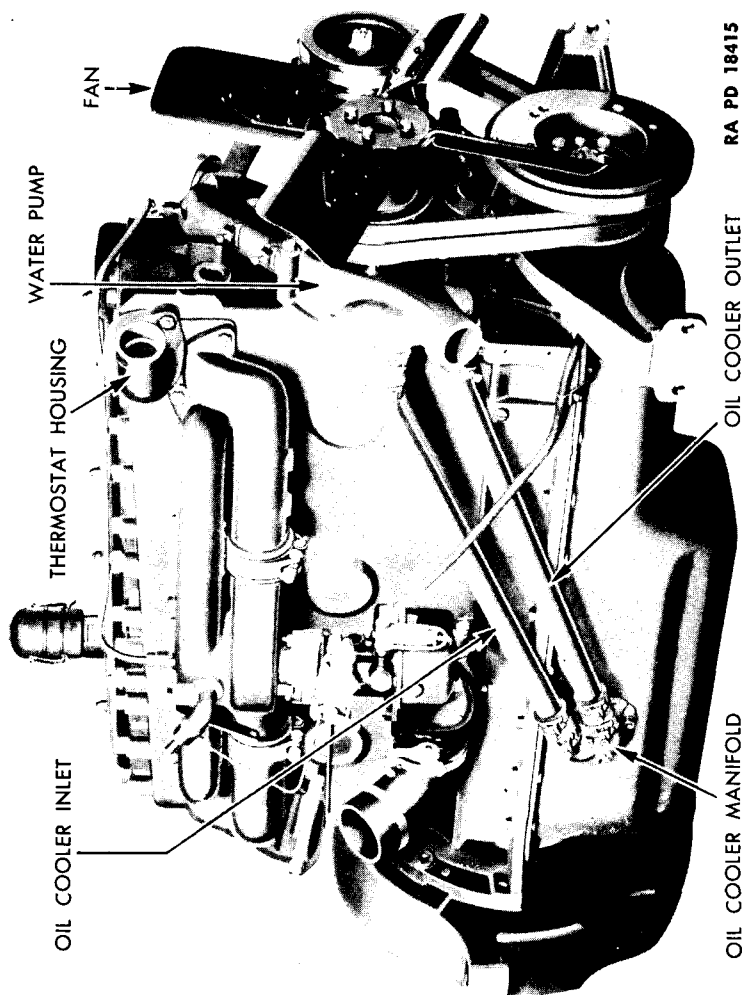

RA PD 18415

Figure 154 — Engine Showing Cooling System — Right Side

**BASIC HALF-TRACK VEHICLES (IHC) (PERSONNEL CARRIER M5, CAR M9A1,
MULTIPLE GUN MOTOR CARRIAGE M14, AND SIMILAR IHC VEHICLES)**

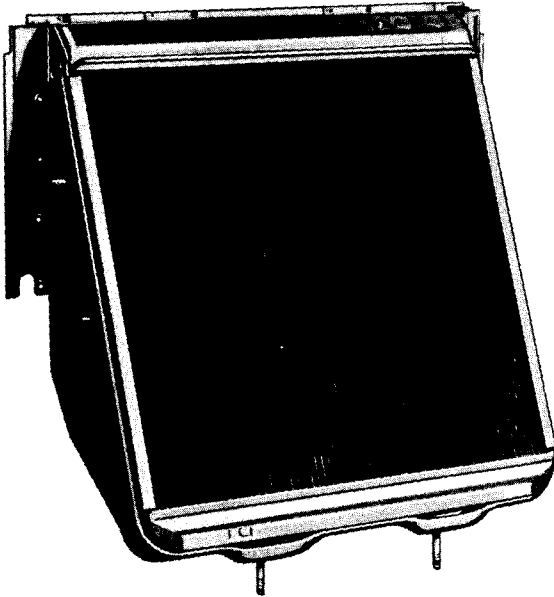

RA PD 18416

Figure 155 – Radiator – Front View

Possible Cause	Possible Remedy
Defective hose.	Replace hose.
Dragging brakes.	Adjust brakes (par. 65).
Frozen radiator.	Thaw out (par. 83).
b. Overcooling.	
Thermostat stuck open.	Replace thermostat (par. 80 b).
c. Leakage.	
Defective hose.	Replace hose.
Loose connections.	Check and tighten.
Loose or open drain valves.	Check and tighten.
Damaged radiator core.	Replace core (par. 76).

76. RADIATOR AND SHROUD (figs. 155 and 156).

a. Description. The radiator is of sheet metal reinforced construction and incorporates a fin and tubular construction core. The radiator core is shrouded. The weight of the assembly is 96 pounds.

COOLING SYSTEM

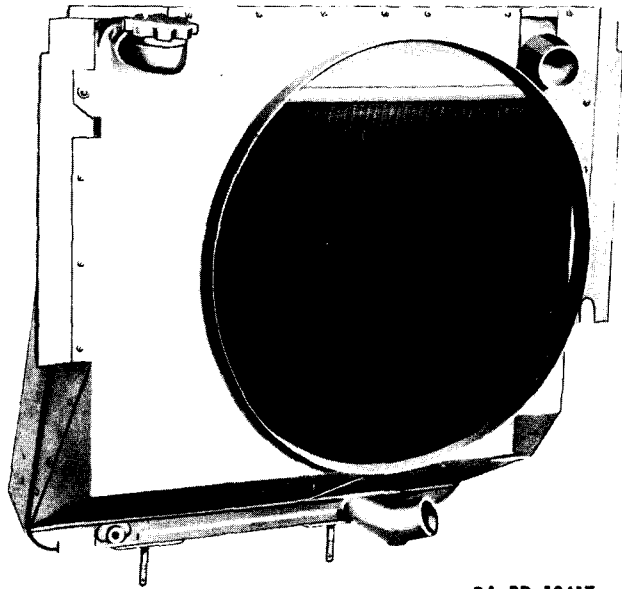

RA PD 18417

Figure 156 – Radiator – Rear View

b. Radiator and Shroud Removal.

(1) EQUIPMENT.

HANDLE, socket wrench

PLIERS

SCREWDRIVER

WRENCH, 1/2-in.

WRENCH, end, 7/16-in.

WRENCH, end, 9/16-in.

WRENCH, end, 5/8-in.

WRENCH, end, 3/4-in.

WRENCH, end, 7/8-in.

WRENCH, socket, 3/4-in.

(2) PROCEDURE.

(a) *Drain Cooling System.*

Open drain cock at bottom of radiator.

(b) *Remove Hood.*

SCREWDRIVER

WRENCH, end, 9/16-in.

Raise hood and remove slotted screws at both front (two) and rear end (three) of hood top panel. Remove bolt from hood at front top panel. Front bolt holds the radio bonding strap. Remove hood.

(c) *Remove Louvre Plate.*

SCREWDRIVER

WRENCH, end, 9/16-in.

Remove four slotted screws and nuts from louvre plate. Remove plate.

BASIC HALF-TRACK VEHICLES (IHC) (PERSONNEL CARRIER M5, CAR M9A1, MULTIPLE GUN MOTOR CARRIAGE M14, AND SIMILAR IHC VEHICLES)

(d) Remove Screws.

Remove slotted screws from louvre assembly and side armor plate.

(e) Disconnect Louvre Assembly Frame at Chassis Frame.

SCREWDRIVER

WRENCH, end, 3/4-in.

WRENCH, end, 9/16-in.

Remove louvre frame brackets from each side of the louvre frame at the frame side rail. There are five cap screws with nuts and washers at each bracket.

(f) Disconnect Louvre Assembly Cross Rods.

WRENCH, end, 3/4-in.

Remove the two louvre assembly stay rod mounting cap screws at the frame cross member.

(g) Disconnect Louvre Control Rod.

Tilt louvre assembly forward and remove cotter pin from control rod. Remove radiator louvre control rod from louvre assembly located at right side of the radiator.

(h) Remove Radiator Louvre and Frame Assembly.

Lift louvre and frame assembly from chassis.

(i) Disconnect Radiator Stay Rods from Radiator.

WRENCH, end, 3/4-in.

Remove radiator stay rod mounting nuts, one each side of radiator. **NOTE:** When reinstalling radiator, adjust stay rods to provide 1/2- to 3/4-inch clearance between fan blade tip and radiator top tank.

(j) Loosen Radiator Stay Rods at Cross Member.

HANDLE, socket wrench

WRENCH, socket, 3/4-in.

Loosen stay rod mounting nuts at each side of radiator at cross member, working from underneath. Disconnect stay rods from studs at side of radiator.

(k) Remove Radiator Mounting Nuts, Washers, Springs, and Mounting Pads.

PLIERS

WRENCH, end, 3/4-in.

Remove cotter pins, two nuts, washers, springs, and mounting pads from radiator lower support.

(l) Disconnect Upper Radiator Hose.

SCREWDRIVER

Loosen screws in upper radiator hose connection. Remove radiator hose connection.

COOLING SYSTEM

(m) *Disconnect Tube to Surge Tank.*

WRENCH, end, $\frac{9}{16}$ -in.

Disconnect tube from radiator to surge tank at radiator.

(n) *Disconnect Bonding Straps at Radiator.*

WRENCH, end, $\frac{7}{16}$ -in.

Remove nut and lock washer holding bonding strap at both left and right sides of radiator and disconnect bonding straps.

(o) *Remove Fan Blades from Fan Hub.*

WRENCH, $\frac{1}{2}$ -in.

Remove four bolts from fan blade to hub. Remove fan blades.

(p) *Remove Radiator and Shroud from Chassis.*

(q) *Remove Lower Hose Assembly from Radiator.*

SCREWDRIVER

WRENCH, $\frac{1}{2}$ -in.

Remove bracket bolt and disconnect lower hose clamps. Remove hose.

c. Radiator Core and Shroud Installation.

(1) INSTALL LOWER HOSE ASSEMBLY.

(2) INSTALL RADIATOR AND SHROUD ON CHASSIS.

(3) INSTALL FAN BLADES ON FAN HUB. (Adjust radiator stay rods to assure $\frac{1}{2}$ - to $\frac{3}{4}$ -inch clearance between fan blade tip and radiator top tank.)

(4) CONNECT BONDING STRAPS TO RIGHT AND LEFT SIDES OF RADIATOR.

(5) CONNECT TUBE TO SURGE TANK AT RADIATOR.

(6) CONNECT UPPER AND LOWER RADIATOR HOSE.

(7) INSTALL RADIATOR MOUNTING PADS, SPRINGS, WASHERS, NUTS, AND COTTER PINS.

(8) CONNECT RADIATOR STAY RODS AT EACH SIDE AND AT FRAME CROSS MEMBER.

(9) INSTALL LOUVRE ASSEMBLY AND FRAME ON CHASSIS FRAME.

(10) CONNECT RADIATOR LOUVRE CONTROL ROD TO LOUVRE ASSEMBLY.

(11) CONNECT LOUVRE RODS TO FRAME CROSS MEMBER.

(12) CONNECT LOUVRE ASSEMBLY FRAME TO SIDE FRAME.

(13) INSTALL LOUVRE PLATE.

(14) INSTALL HOOD.

(15) REFILL COOLING SYSTEM.

**BASIC HALF-TRACK VEHICLES (IHC) (PERSONNEL CARRIER M5, CAR M9A1,
MULTIPLE GUN MOTOR CARRIAGE M14, AND SIMILAR IHC VEHICLES)**

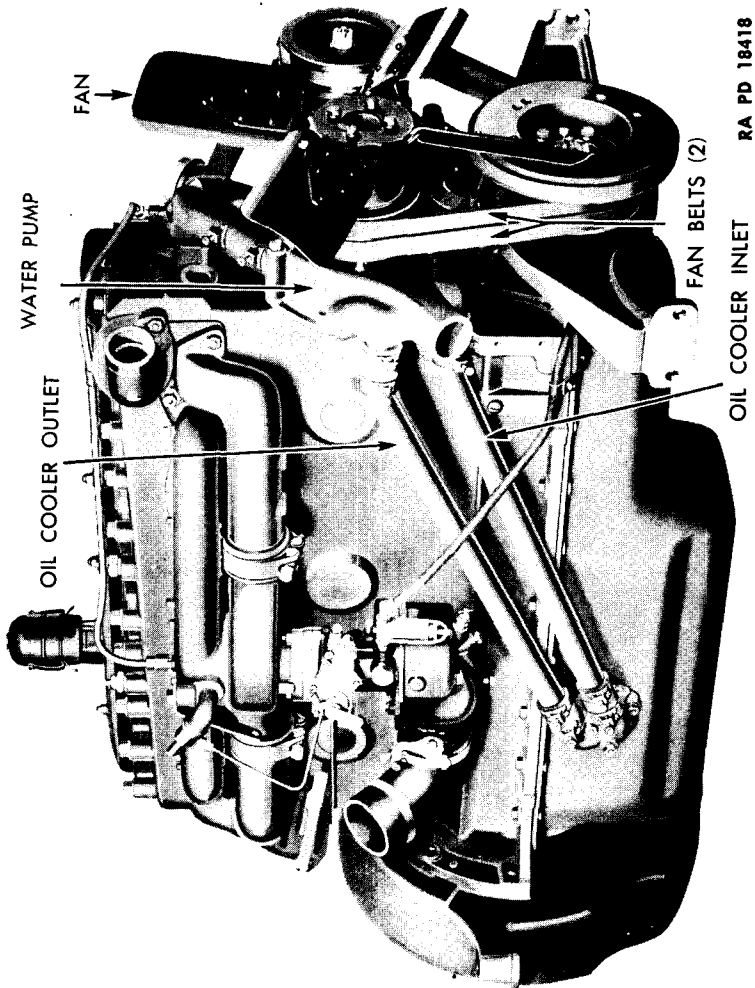

Figure 157 — Water Pump and Fan — Installed

COOLING SYSTEM

77. FAN.

a. The air flow through the radiator core is maintained by movement of the vehicle and a four-bladed fan which is enclosed in a shroud. The fan is driven off the crankshaft by dual V-belts. The fan is secured to the hub on the water pump by four $\frac{5}{16}$ -inch cap screws. The fan hub is integral with the water pump. (For replacement, see paragraph 78.)

78. WATER PUMP (fig. 157).

a. **Description.** The water pump is of the centrifugal type and is of packless design and requires no external adjustment. Lubrication is provided to the shaft and bearings (sec. V).

b. **Water Pump Replacement.** Water pump and fan replacement is accomplished as follows:

(1) EQUIPMENT.

SCREWDRIVER

WRENCH, end, $\frac{1}{2}$ -in.

WRENCH, end, $\frac{9}{16}$ -in.

WRENCH, end, $\frac{5}{8}$ -in.

WRENCH, end, $\frac{3}{4}$ -in.

WRENCH, end, $1\frac{3}{16}$ -in.

WRENCH, end, 1-in.

(2) PROCEDURE.

(a) *Drain Cooling System.*

Open drain cock at lower corner of the radiator and remove radiator cap.

(b) *Disconnect Water Pump Hose Connections.*

SCREWDRIVER

Loosen water hose connections at water pump inlet (lower), water pump outlet (upper). Loosen two oil hose connections (lower rear portion of water pump).

(c) *Loosen Fan Belts and Remove.*

WRENCH, end, $\frac{5}{8}$ -in.

WRENCH, end, $\frac{3}{4}$ -in.

WRENCH, end, $1\frac{3}{16}$ -in.

WRENCH, end, 1-in.

Loosen two generator lower bracket mounting bolts. Remove two generator adjusting strap bolts. Move generator in toward engine. Remove belts.

(d) *Remove Water Pump and Fan (fig. 158).*

WRENCH, end, $\frac{9}{16}$ -in.

Remove four water-pump-body-to-cylinder-block bolts. Remove pump.

(e) *Remove Water-Pump-Body-to-Cylinder-Block Gasket.*

BASIC HALF-TRACK VEHICLES (IHC) (PERSONNEL CARRIER M5, CAR M9A1, MULTIPLE GUN MOTOR CARRIAGE M14, AND SIMILAR IHC VEHICLES)



RA PD 18419

Figure 158 — Water Pump — Removal

(f) Remove Fan Assembly.

WRENCH, end, ½-in.

Remove four bolts and lock washers securing fan to fan hub. Remove fan.

(g) Install Fan on Fan Hub with Four Bolts and Lock Washers.

(h) Install New Water-Pump-Body-to-Cylinder-Block Gasket.

(i) Install Water Pump and Fan Assembly on Cylinder Block.

(j) Install Water-Pump-Body-to-Cylinder-Block Bolts.

(k) Connect Water Pump Hose at Inlet, Outlet, and at Oil Cooler Connections.

(l) Install Fan Belts.

(m) Install Generator Adjustment Strap.

COOLING SYSTEM

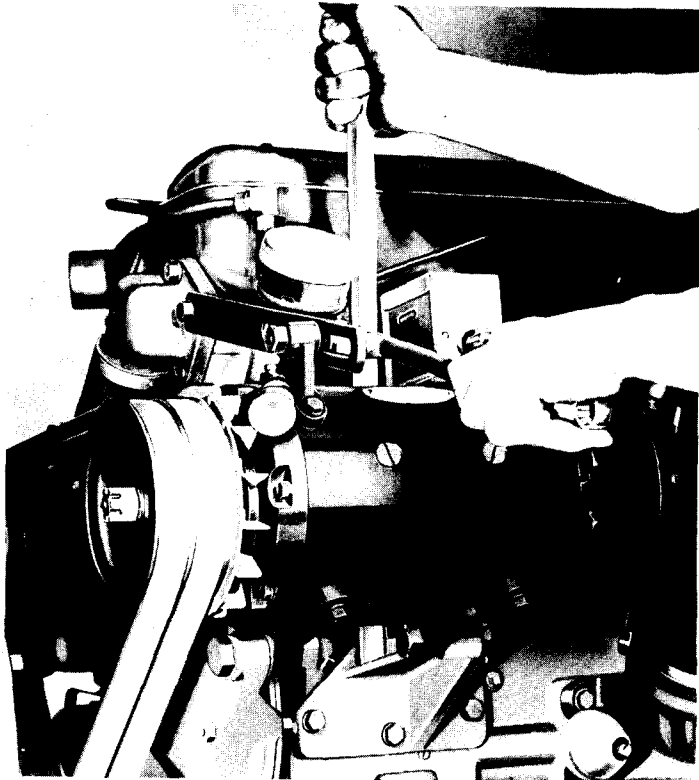

RA PD 18420

Figure 159 — Fan Belt Adjustment

(n) Adjust Fan Belt Tension.

For proper tension, refer to paragraph 79. Tighten generator mounting bolts.

(o) Refill Cooling System.

NOTE: After refilling cooling system, permit engine to warm to approximately 160 F and then recheck water level. Add water if necessary.

79. FAN BELT ADJUSTMENT (fig. 159).

a. The tension of the two fan belts is important since too loose a tension will contribute to slipping while excessive tension will cause premature fan belt failure. When replacing a fan belt, two new belts should be installed. This will assure both belts having the same tension.

(1) ADJUSTMENT OF TENSION OF FAN BELTS.

(a) Equipment.

HANDLE, hub stud nut wrench **WRENCH,** end, ¾-in.

**BASIC HALF-TRACK VEHICLES (IHC) (PERSONNEL CARRIER M5, CAR M9A1,
MULTIPLE GUN MOTOR CARRIAGE M14, AND SIMILAR IHC VEHICLES)**

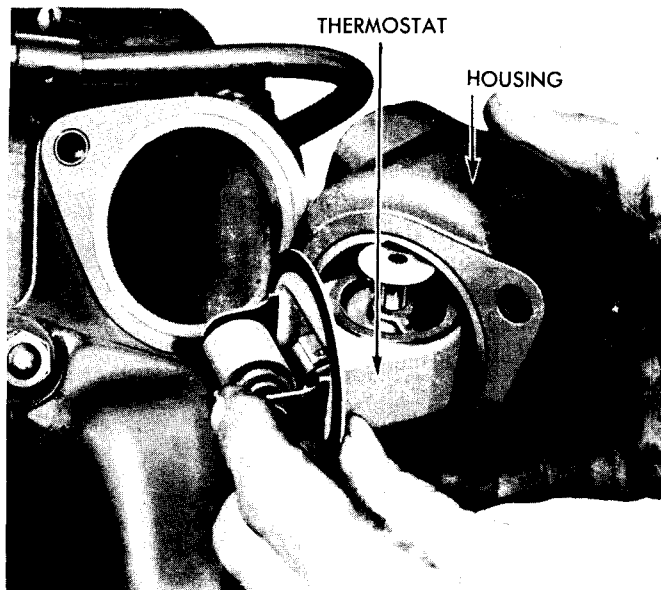

RA PD 18421

Figure 160 – Thermostat – Removal

(b) Procedure.

1. *Loosen generator adjustment strap bolt nut.*

WRENCH, end, $\frac{3}{4}$ -in.

Loosen generator adjustment strap bolt nut.

2. *Adjust fan belt tension.*

WRENCH, end, $\frac{3}{4}$ -in.

Correct adjustment of fan belt tension is indicated by approximately $\frac{1}{2}$ -inch deflection or sag from a straight line representing the back side of the belt and tangent to the fan pulley and the generator pulley, measured at a point midway between the two pulleys. Insert the bar between the generator and the engine just to the rear of the adjusting strap and place the lower end of the bar in the recess in the mounting bracket holding generator to engine (fig. 159). Loosen the generator-to-adjusting-strap-bolt nut, by using the bar as a pry bar, pull the generator away from engine firmly, exerting full one-arm pull of an average man on bar. Tighten generator-to-adjusting-strap-bolt nut *securely*.

80. THERMOSTAT.

a. **Description.** A balanced type thermostat is located in the water outlet passage in the cylinder head at the right front of the engine. For

COOLING SYSTEM

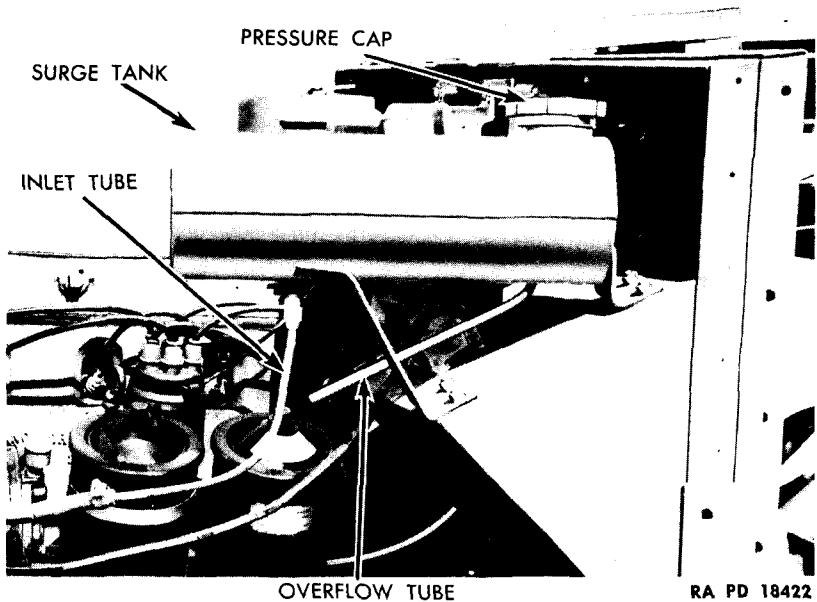

Figure 161 – Surge Tank – Installed

engines below serial number 3635 it is set to start opening when the water temperature reaches 145 F, and should be fully open at 180 F. In engine serial numbers 3635 and later, it starts to open at 170 F. The engine should not be operated without the thermostat in cool or cold weather.

b. **Thermostat Replacement.** To replace thermostat, proceed as follows:

(1) EQUIPMENT.

SCREWDRIVER

WRENCH, end, $\frac{9}{16}$ -in.

(2) PROCEDURE.

(a) *Partially Drain Cooling System.*

(b) *Loosen Upper Radiator Hose.*

SCREWDRIVER

Loosen hose clamp screws at water outlet connection.

(c) *Remove Thermostat Housing.*

WRENCH, end, $\frac{9}{16}$ -in.

Remove two bolts and lock washers from thermostat housing (water outlet passage). Remove outlet connection. Remove thermostat (fig. 160).

BASIC HALF-TRACK VEHICLES (IHC) (PERSONNEL CARRIER M5, CAR M9A1, MULTIPLE GUN MOTOR CARRIAGE M14, AND SIMILAR IHC VEHICLES)*(d) Install Replacement Thermostat.*

Install thermostat with housing up and with small valve of thermostat toward right-hand side of engine.

*(e) Install Water Outlet Connection (Thermostat Housing).**(f) Connect Upper Radiator Hose.**(g) Refill Cooling System.*

After refilling radiator, warm engine to approximately 160 F and re-check water level. Add water if necessary.

81. SURGE TANK (fig. 161).

a. Description. A surge tank is mounted on brackets on the dash of the vehicle in the engine compartment. The tank is connected to the radiator by tubing. The purpose of the surge tank is to act as an expansion chamber or overflow chamber for coolant from the radiator, since the cooling system is under sealed pressure. The tank cap is of pressure type comprising a relief valve to prevent system rising above a predetermined pressure. Never remove this cap when filling the cooling system. Fill system only at radiator.

b. Replacement. Should it become necessary to replace the surge tank, proceed as follows:

(1) EQUIPMENT.

WRENCH, end, $\frac{9}{16}$ -in.

(2) PROCEDURE.*(a) Disconnect Tube from Surge Tank to Radiator.*

WRENCH, $\frac{9}{16}$ -in.

Disconnect tube to radiator at base of surge tank.

(b) Remove Surge Tank.

WRENCH, end, $\frac{9}{16}$ -in.

Remove four bolts, nuts, and lock washers from surge tank mounting brackets. Remove tank.

*(c) Install Surge Tank and Mounting Bolts, Nuts, and Washers.**(d) Connect Tube to Radiator at Base of Surge Tank.***82. ANTIFREEZE PROTECTION.**

a. In freezing weather the cooling system should be filled with an ETHYLENE GLYCOL antifreeze solution, either reclaimed or new, as outlined below. The system should be cleaned thoroughly and tightened before antifreeze is added. The following table gives the required quantity of new ETHYLENE GLYCOL antifreeze necessary for various temperature conditions, based on the system capacity of 31 quarts.

COOLING SYSTEM

Percent by Volume	Qt (approx.) ETHYLENE GLYCOL	Provides Protection to	
		Deg (C)	Deg (F)
0 percent	0	0	32
10 percent	3	-4	25
20 percent	6	-9	16
30 percent	9	-16	4
40 percent	12	-24	-12
50 percent	15	-37	-35
52 percent	16	-40	-40
55 percent	17	-46	-50

(1) **RECLAIMED SOLUTIONS.** Reclaimed solutions should be used up, as far as practicable, in administrative vehicles. Never use reclaimed solutions in vehicles in combat service.

(a) *Initial Preparation of Old Solutions.*

1. Place drum containing the old solution on a rack and install tap.
2. Test for strength with a hydrometer and discard all solutions testing above 20 F.
3. Strain a sample through muslin or several thicknesses of cheese-cloth into a clean glass container. Solution should be green or blue. Discard all solutions with brown or rusty tint.
4. If the solution tests higher than the temperature to which protection is required, determine the amount of new **ETHYLENE GLYCOL** required to reach the desired protection from the following table:

Solution Strength	Desired Strength					
	10	0	-10	-20	-30	-40
20 F	1	1½	2¼	2¾	3	3½
10 F	—	1	1½	2	2½	3
0 F	—	—	¾	1¼	1¾	2¼
-10 F	—	—	—	¾	1¼	1¾
-20 F	—	—	—	—	¾	1
-30 F	—	—	—	—	—	¾

EXAMPLE: If the solution tests +10 F and the desired protection is -30 F, reading the table indicates that 2½ pints will be required.

BASIC HALF-TRACK VEHICLES (IHC) (PERSONNEL CARRIER M5, CAR M9A1, MULTIPLE GUN MOTOR CARRIAGE M14, AND SIMILAR IHC VEHICLES)

5. Strain the old solution through muslin or several thicknesses of cheesecloth into a clean container in which the quantities can be measured, and from which the solution can be poured into the radiator of the vehicle.

6. Add the determined quantity of **ETHYLENE GLYCOL** for each gallon of reclaimed solution. **NOTE:** Do not strain new antifreeze solution.

(b) It is necessary that the cooling system of the vehicle be clean, particularly of rust. If the cooling system was cleaned and inhibited, it may be necessary only to drain, refill with clean water, and again drain.

1. Heaters, oil coolers, etc., connected into the cooling system must be cleaned together with the radiator and block. When the system is drained, the drain valve at the right-hand side of the block, the drain plug at the bottom of the oil cooler in the oil pan, and the radiator drain cock must all be opened to assure complete draining.

2. All hoses should be inspected and replaced if deteriorated. All connections, plugs, and pet cocks should be inspected, and made water-tight. If there is evidence of exhaust gas or air leakage into the system, necessary correction must be made.

(c) When the cooling system is clean and tight, the strained antifreeze of the proper strength should be added. After filling to the proper level, add one container of reinhibitor for every four gallons of antifreeze solution in the cooling system. The contents of the container should be poured into the radiator while the engine is idling at normal operating temperature to assure thorough mixing. The cooling system capacity of this vehicle is 31 quarts.

(d) While the engine is warm, the solution strength should be checked with a hydrometer and strengthened if necessary.

(e) Reinhibitor is available on requisition under Federal Stock No. 511-136-85, **INHIBITOR**, antifreeze compound. **NOTE:** If delivery of reinhibitor is delayed, it should be added at the earliest possible moment.

(2) **NEW SOLUTIONS.**

(a) The cooling system of vehicles to be protected with new solutions is to be prepared in accordance with subparagraph a (1) (b) above.

(b) New antifreeze solutions may then be added. The following table may be used as a guide in preparation of the solution:

COOLING SYSTEM

TABLE No. 3 GUIDE FOR PREPARING FRESH ANTIFREEZE SOLUTIONS	
Protection to	Pints of ETHYLENE GLYCOL to be added to make one gallon of antifreeze solution
10 F	2
0 F	2½
-10 F	3
-20 F	3½
-30 F	4
-40 F	4½

(c) First add some water to the radiator. Then add required amount of ETHYLENE GLYCOL to the system and fill with water to slightly below the filler neck. (See also table 1 above.)

(d) After installing the solution and warming the engine, the level should be adjusted and the solution checked with a hydrometer and strengthened if necessary.

(e) Do not add reinhibitor to freshly prepared antifreeze solutions.

(3) In service with either new or used solution, the coolant should be inspected weekly for strength and color. If the solution becomes rusty, it is to be discarded, the cooling system thoroughly cleaned, and new solution added. If new solution is not available, do not discard rusty solution.

(4) In handling antifreeze solution, it is essential that it be kept clean. Use containers and water that are free from dirt, rust, and oil.

(5) Always use an accurate hydrometer. To test the hydrometer, make a solution of one part ETHYLENE GLYCOL and two parts water. This solution should give a reading on the hydrometer of protection to 0 F.

(6) ETHYLENE GLYCOL is the only antifreeze authorized for use in ordnance vehicles.

83. COOLING SYSTEM PRECAUTIONS.

a. **Servicing.** Cooling systems should be given a systematic servicing every 6,000 miles, or about twice a year (spring and fall). Cooling systems should always be serviced before the introduction of an anti-freeze into the system and also following its removal. Add ½ pint rust solvent each time the system is serviced.

(1) **CLEANING.** The servicing of a cooling system consists of dis-

BASIC HALF-TRACK VEHICLES (IHC) (PERSONNEL CARRIER M5, CAR M9A1, MULTIPLE GUN MOTOR CARRIAGE M14, AND SIMILAR IHC VEHICLES)

solving the dirt, rust, scale, and grease in the system and a thorough flushing. This operation is initiated by removing one gallon of water from the system and adding a solution of one pound of washing soda (sal soda) or one-half pound of SODA ASH in one gallon of clear water. The engine should then be run until the solution boils thoroughly. Covering the front of the radiator will speed up this operation. Drain the system by opening the valve at the side of the engine, removing the drain plug from the oil cooler base and *by disconnecting the lower hose connection.*

(2) **FLUSHING.** Flushing of the cooling system should be effected in the direction opposite to the direction of normal flow. This is called "reverse flushing." The radiator should be flushed up from the lower hose connection and out the upper hose connection. After flushing the system, the thermostat should be removed, checked by dipping in hot water, and its action noted.

(3) **REFILLING.** Before reconnecting clamps and sections of hose, all hoses should be carefully examined for serviceability. Replace any unserviceable parts. Refill system and check for leaks.

(4) **THAWING.** If the water in the cooling system of a vehicle freezes solid, it must be thawed by placing the vehicle in a warm place. Under no circumstances should the engine be operated when the water in the system is completely frozen. In the case of mush ice, it is safe to place the vehicle in a warm place, but the ice may be thawed by covering the radiator and running the engine slowly. If the engine has been started and the radiator is steaming, stop the engine. Cover the radiator and close the hood. When the steaming stops, start and run the engine until proper circulation is reestablished.

(5) **LINKAGES.** Check radiator supports and tie rods and keep tightened. Also check connection of control linkage to louvres.

b. Overheating Precaution for Radio-equipped Vehicles.

(1) Since the radio transmitter on radio-equipped vehicles will not function properly on a current supply of voltage lower than approximately 11.5 volts, the occasion will sometimes arise wherein the engine must be run at sufficient speed to permit the generator to develop the voltage required to maintain radio communication. During such operation of the engine, care must be exercised so that damage to the engine through overheating does not occur.

(2) Whenever it is necessary to operate the engine while the vehicle is not moving, for the purpose of maintaining radio communication, the heat indicator must be watched attentively. If the temperature of the engine rises (200 F, approximately) the engine should be stopped.

COOLING SYSTEM

(3) Every vehicle in which a tendency to overheat is encountered should be given a complete check as soon as possible and necessary corrections made to eliminate the overheating tendency.

(4) Circumstances permitting engine overheating may be relieved somewhat by facing the vehicle into the wind and opening the hood. Radiator louvres normally must be open. Prolonged engine operation, with vehicle at standstill, for the purpose of charging a battery, will be discouraged. Discharged batteries must be replaced and recharged from another source.

c. **Radiator Shutters.** To prevent excessive cooling of the engine and poor combustion in cold weather, the radiator shutters or louvres should be partially closed or the radiator core partly covered in some manner.

d. **Hose Connections.** Hose connections should be examined frequently and should be replaced if they show signs of defect or disintegration. This will prevent leaks and obstructions of the system by loose particles.

e. **Draining System.** Drain the system in cold weather if it does not contain antifreeze. It is advisable to operate the engine for approximately one-half minute after draining to assure elimination of water pockets in the crankcase, cylinder head, or water pump. **NOTE:** Be sure to drain at right-hand side of crankcase, and at oil cooler at bottom of oil pan as well as at radiator drain cock.

BASIC HALF-TRACK VEHICLES (IHC) (PERSONNEL CARRIER M5, CAR M9A1, MULTIPLE GUN MOTOR CARRIAGE M14, AND SIMILAR IHC VEHICLES)

Section XVI

ELECTRICAL SYSTEM

	Paragraph
Description	84
Ignition trouble shooting.....	85
Battery	86
Starting motor	87
Generator	88
Generator regulator	89
Ignition coil	90
Distributor	91
Spark plugs	92
Radio noise suppression.....	93
Timing	94
Circuit breakers	95
Switches	96
Amphenol plugs	97
Terminal box	98
Headlights and marker lights.....	99
Taillights	100
Electric brake control.....	101
Horns	102

84. DESCRIPTION.

a. The 12-volt system (direct current) is of single wire, ground return type and energized from a storage battery whose negative terminal is grounded to the frame. The system is divided into three general classifications to include the battery, starter, generator, and generator regulator; the closed circuit, battery and coil, high-tension ignition group; and the miscellaneous lighting, protective, and control equipment. Figures 162, 163, and 164 illustrate the vehicle wiring diagram. Figures 165 to 170 illustrate the several wiring harnesses and the type of electrical connections on each wire. (Also, refer to paragraph 97).

85. IGNITION TROUBLE SHOOTING.

a. Table.

(1) LOSS OF ENERGY IN THE PRIMARY CIRCUIT.

Possible Cause	Possible Remedy
Loose connections.	Tighten connections.
Defective leads.	Replace wire (subpar. b (1) below).

ELECTRICAL SYSTEM

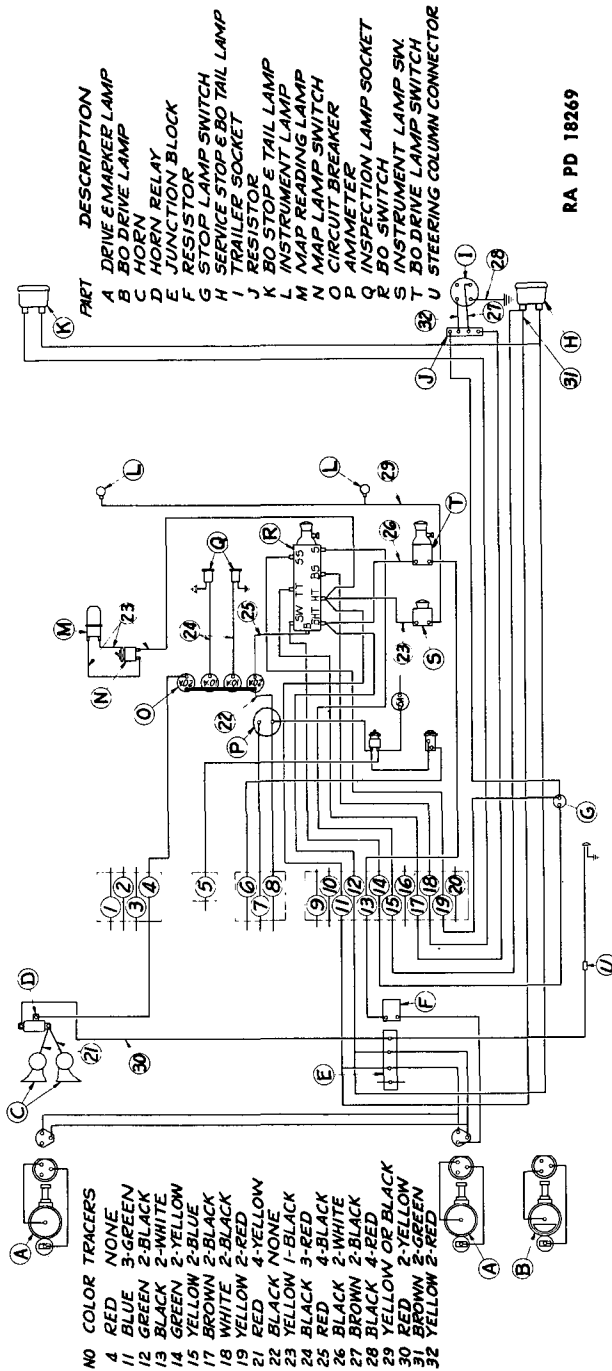
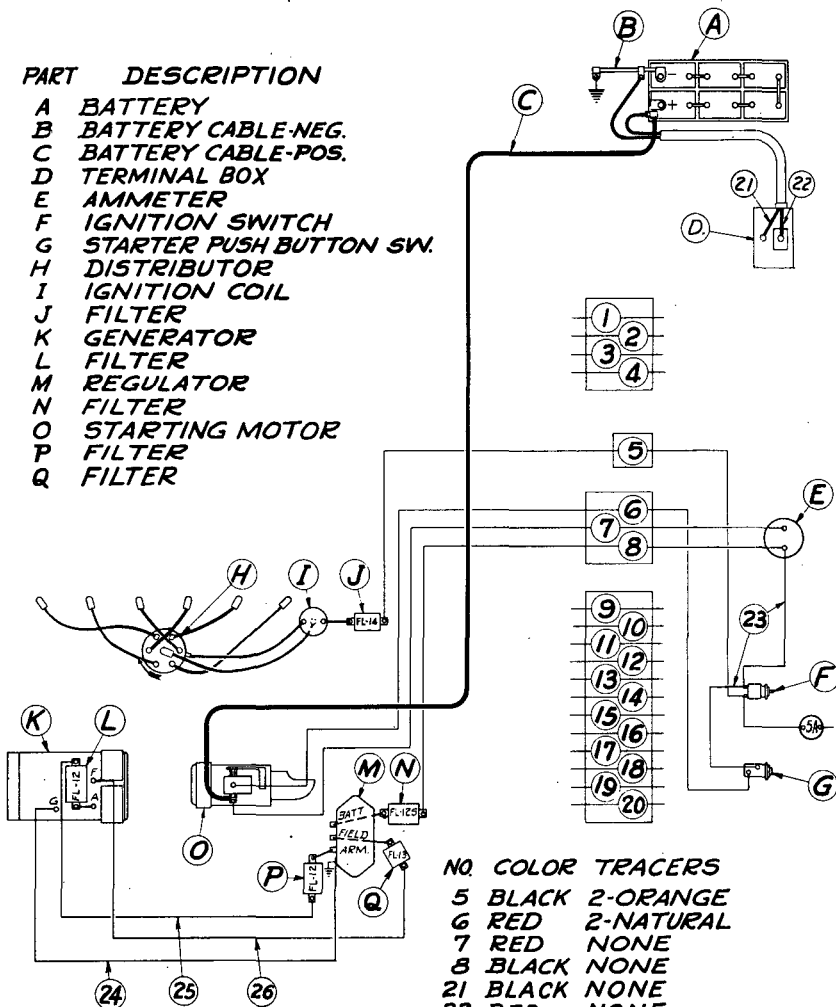

Figure 162 — Wiring Diagram — Lighting Circuit

BASIC HALF-TRACK VEHICLES (IHC) (PERSONNEL CARRIER M5, CAR M9A1, MULTIPLE GUN MOTOR CARRIAGE M14, AND SIMILAR IHC VEHICLES)

PART DESCRIPTION

- A BATTERY
- B BATTERY CABLE-NEG.
- C BATTERY CABLE-POS.
- D TERMINAL BOX
- E AMMETER
- F IGNITION SWITCH
- G STARTER PUSH BUTTON SW.
- H DISTRIBUTOR
- I IGNITION COIL
- J FILTER
- K GENERATOR
- L FILTER
- M REGULATOR
- N FILTER
- O STARTING MOTOR
- P FILTER
- Q FILTER



- NO. COLOR TRACERS**
- 5 BLACK 2-ORANGE
 - 6 RED 2-NATURAL
 - 7 RED NONE
 - 8 BLACK NONE
 - 21 BLACK NONE
 - 22 RED NONE
 - 23 ORANGE 2-BLACK
 - 24 BLACK 2-GREEN
 - 25 SEAL BROWN-BLACK & RED
 - 26 BLACK 2-RED

RA PD 18537

Figure 163 – Wiring Diagram – Starting and Charging Circuit

ELECTRICAL SYSTEM

Possible Cause	Possible Remedy
Burned contact points.	Replace points (par. 91 b).
Burned ignition switch contacts.	Replace switch (par. 96).
Coil primary resistance high.	Replace coil (par. 90 c).
Coil primary open, short, or ground.	Replace coil (par. 90 c).
Condenser defective.	Replace condenser.
Battery discharged.	Replace battery (par. 86 a (7)).
Primary circuit grounded.	Replace wiring.
Distributor primary circuit grounded.	Replace distributor (par. 91 c below).

(2) **LOSS OF ENERGY IN SECONDARY CIRCUIT.**

High-tension wires defective.	Replace wiring (par. 91 b).
High-tension circuit connections defective.	Tighten connections (par. 91 b).
Spark plugs fouled or cracked.	Replace plugs (par. 92 a (2)).
Spark plug gaps out of adjustment.	Adjust (par. 92 a (1)).
Spark plug wrong heat range.	Use proper plugs (par. 92).
Coil insulation defective.	Replace (par. 90 c).
Distributor defective.	Replace (par. 91 b).
Rotor defective.	Replace (par. 91 b).
Coil defective.	Replace (par. 90 c).

(3) **OUT OF TIME.**

Timing off.	Adjust timing (par. 94 b).
Centrifugal advance defective.	Replace distributor (par. 91 b).
Points not synchronized.	Synchronize points (par. 91 b).

b. Checking. In order to determine which of the wiring circuits is causing the trouble, a definite system of checking should be used. The following must be considered merely as quick checks to get an approximate idea of the location of trouble. This may aid in temporarily correcting the trouble in an emergency so that the vehicle can be brought in for a more comprehensive check. Complete ignition analysis requires accurate testing instruments. Two separate quick checks can be made, according to whether the engine will or will not run.

BASIC HALF-TRACK VEHICLES (IHC) (PERSONNEL CARRIER M5, CAR M9A1, MULTIPLE GUN MOTOR CARRIAGE M14, AND SIMILAR IHC VEHICLES)

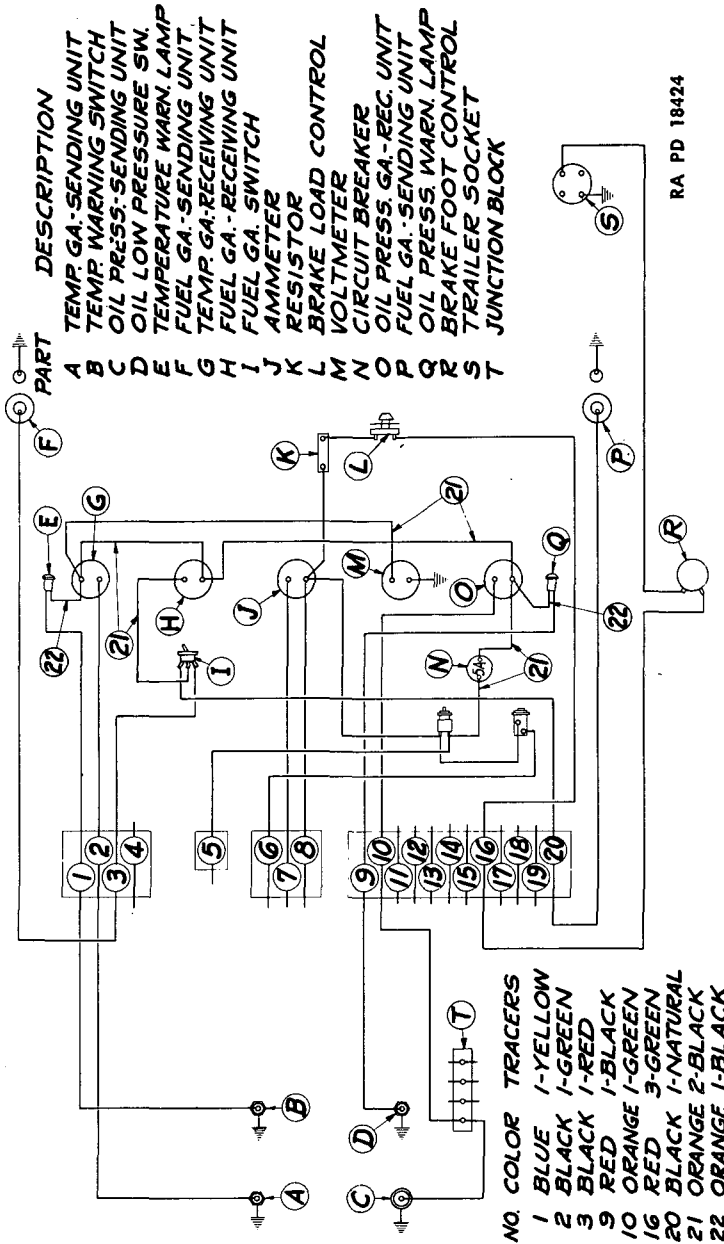

Figure 164 — Wiring Diagram — Instrument Circuit

ELECTRICAL SYSTEM

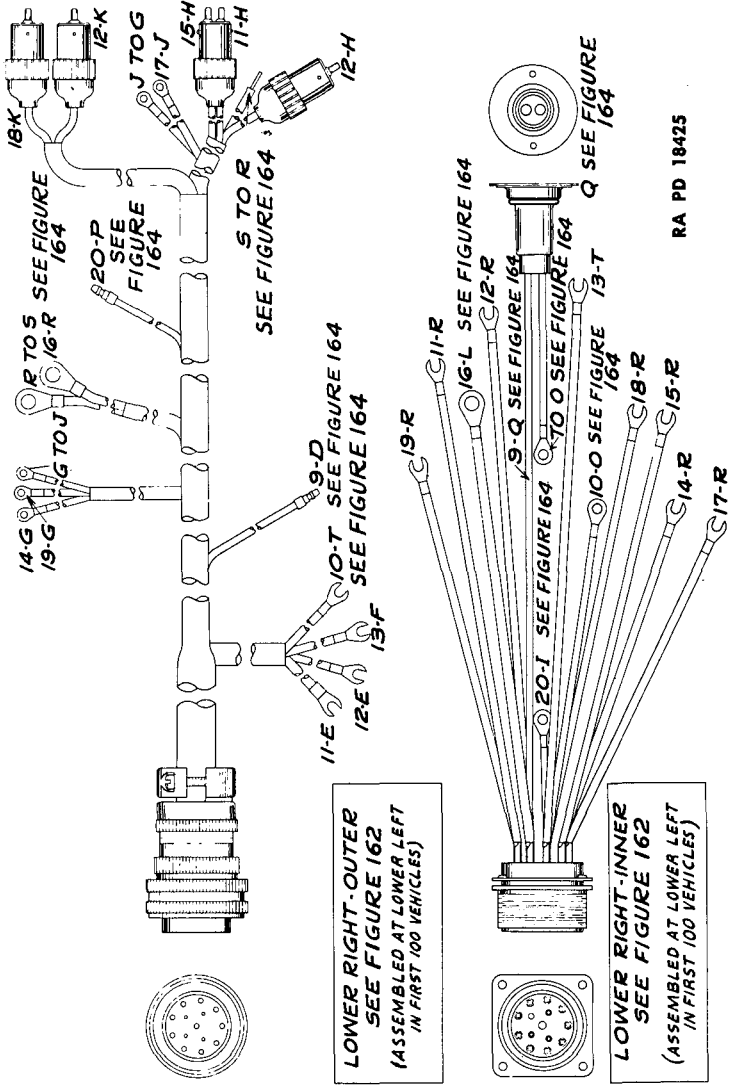

Figure 165 — Wiring Harness — Lower Right — Outer and Inner

BASIC HALF-TRACK VEHICLES (IHC) (PERSONNEL CARRIER M5, CAR M9A1, MULTIPLE GUN MOTOR CARRIAGE M14, AND SIMILAR IHC VEHICLES)

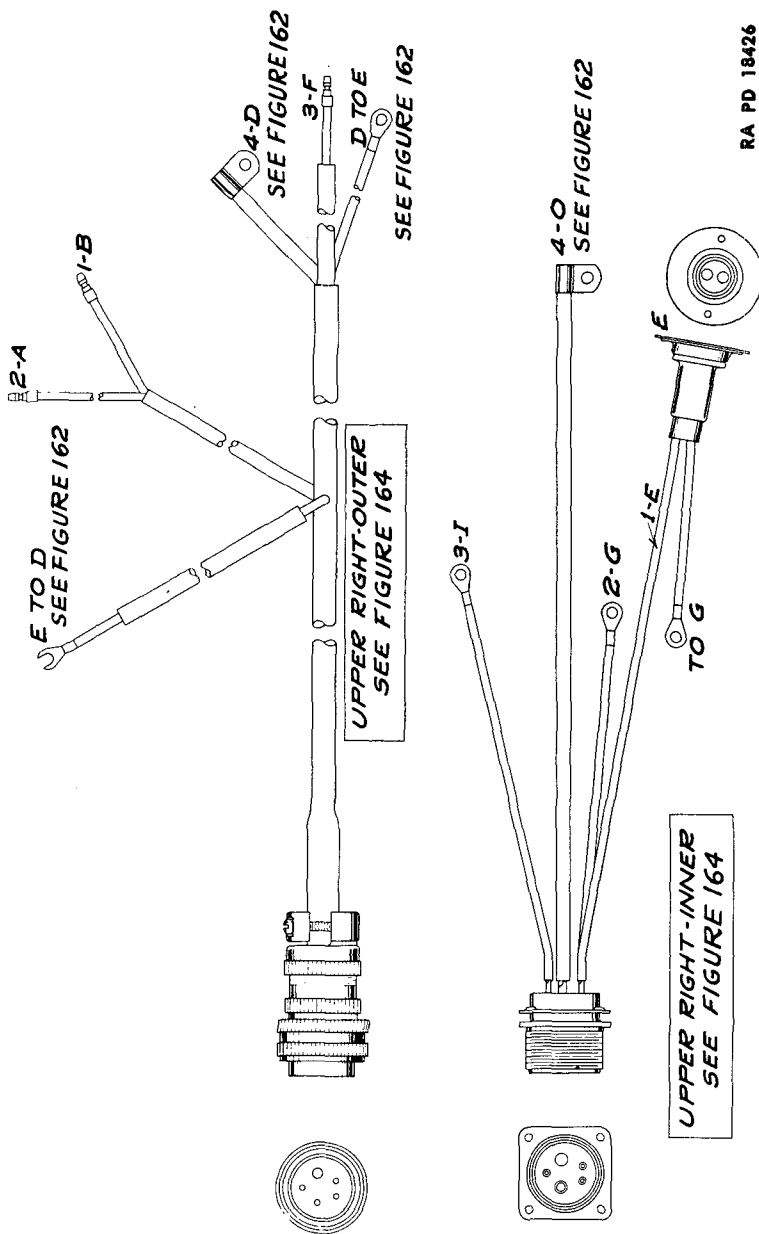

Figure 166 — Wiring Harness — Upper Right — Outer and Inner

ELECTRICAL SYSTEM

(1) **ENGINE WILL NOT START.** If the cranking motor cranks the engine at normal cranking speed, but the engine will not start, remove lead from one spark plug and hold lead terminal about $\frac{3}{16}$ inch from engine block. If a good spark occurs while engine is being cranked, the ignition primary and secondary circuits are probably not at fault and the trouble is likely arising from an out-of-time condition, or from something outside the ignition, such as carburetion, etc. **CAUTION:** Do not continue to crank if the engine does not start. This practice will damage the cranking motor or run down the battery. Cranking should not continue more than 30 seconds at one time to avoid overheating the starting motor. If a spark does not occur, check the dash ammeter while cranking.

(a) If there is a small reading which shows some fluctuation while cranking, the primary is probably not at fault. The secondary is not delivering spark due to loss of energy in the secondary circuit, or a defective condenser.

(b) If there is no reading, the primary circuit is open, due to loose connections, defective wiring or switch, distributor points not making contact, or an open coil primary. Visual inspection of the points and the use of a test light will aid in locating trouble.

(c) If the ammeter shows a reading of several amperes and the needle does not fluctuate while cranking, either the contact points are out of adjustment, so they are not breaking, or the coil primary circuit is grounded, in the coil or externally. *If the cranking motor cranks the engine slowly or not at all*, then the trouble probably lies either in the battery, starting cables, or cable connections, starting switch, or in the cranking motor.

(2) If the engine runs, but not satisfactorily, the usual recourse is a complete engine tuneup, during which the cause or causes of trouble will be found and eliminated. This condition is usually somewhat difficult to analyze, because of the many other factors besides ignition which enter into the operation of the engine, and which could influence engine performance. Some indication of the trouble, if due to ignition, may be deduced from the type of trouble being obtained.

(a) Overheating, if due to ignition, could be caused by improper timing.

(b) Detonation or spark rap, other than that produced by certain grades of fuel, may be caused by improper timing, improper centrifugal advance operation, carbon accumulation in combustion chamber, points out of adjustment, plugs fouled or of wrong heat range.

BASIC HALF-TRACK VEHICLES (IHC) (PERSONNEL CARRIER M5, CAR M9A1, MULTIPLE GUN MOTOR CARRIAGE M14, AND SIMILAR IHC VEHICLES)

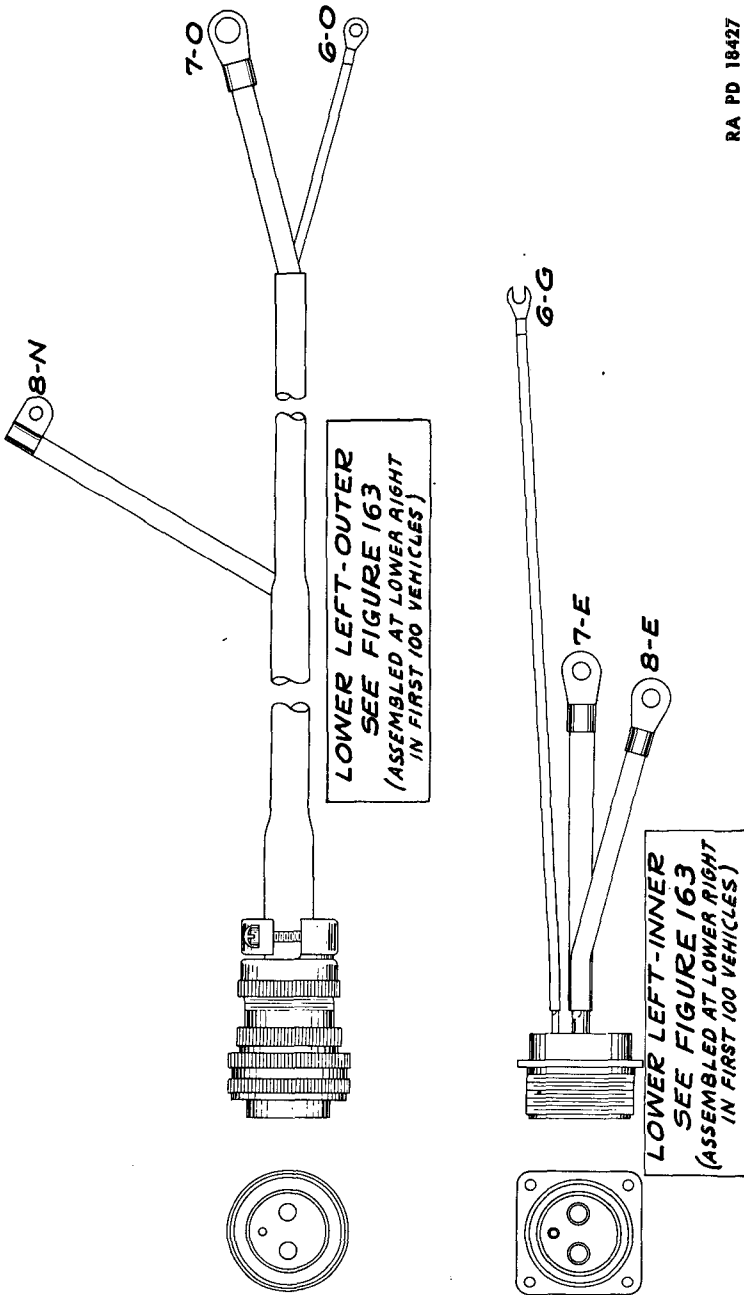

RA PD 18427

Figure 167 — Wiring Harness — Lower Left — Outer and Inner

ELECTRICAL SYSTEM

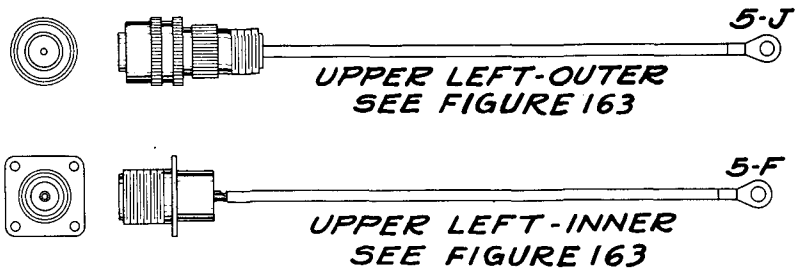

RA PD 18428

Figure 168 – Wiring Harness – Upper Left – Outer and Inner

(c) With missing, hard starting, or loss of power, a complete check-up of the ignition system and remainder of the engine should be made, since these complaints could arise from many causes. **NOTE:** Overheating, detonation, missing, hard starting, or loss of power, all may arise from many conditions in the engine aside from ignition.

c. Detailed Testing. A systematic analysis of fundamentals is of great value in locating ignition system troubles. An accurate low scale direct-current ammeter will aid in localizing the difficulties. The following is a suggested routine for trouble shooting:

(1) **COIL DISTRIBUTOR CIRCUIT.** Remove the coil-to-distributor high-tension (secondary) cable and hold it three-eighths of an inch from a ground such as any convenient metal part of the engine which is free of gasoline, oil, etc. Make and break the primary circuit with the ignition turned on, either by using the starting motor or by rocking the cam inside the distributor back and forth. A hot, snappy spark should result, and if so, proceed to test (2) below. If no spark occurs, check the coil-to-distributor wire to be sure it can conduct current, or substitute a wire known to be good and repeat test. If a weak spark is obtained, either the condenser or the coil or both are at fault. Turn engine over with the starting motor and look for excessive arcing at the breaker points, which would be an indication of a bad condenser. Replace condenser and repeat original test. If spark is still weak, coil replacement is indicated.

(2) **DISTRIBUTOR COVER.** With the coil-to-distributor wire inserted in the center well of the distributor cover, remove cover, and turn engine crankshaft to produce current in the secondary circuit. Observe cover interior for cracks and moisture and watch for leakage or a short circuit wherein sparks jump from the center terminal to the spark plug

BASIC HALF-TRACK VEHICLES (IHC) (PERSONNEL CARRIER M5, CAR M9A1,
MULTIPLE GUN MOTOR CARRIAGE M14, AND SIMILAR IHC VEHICLES)

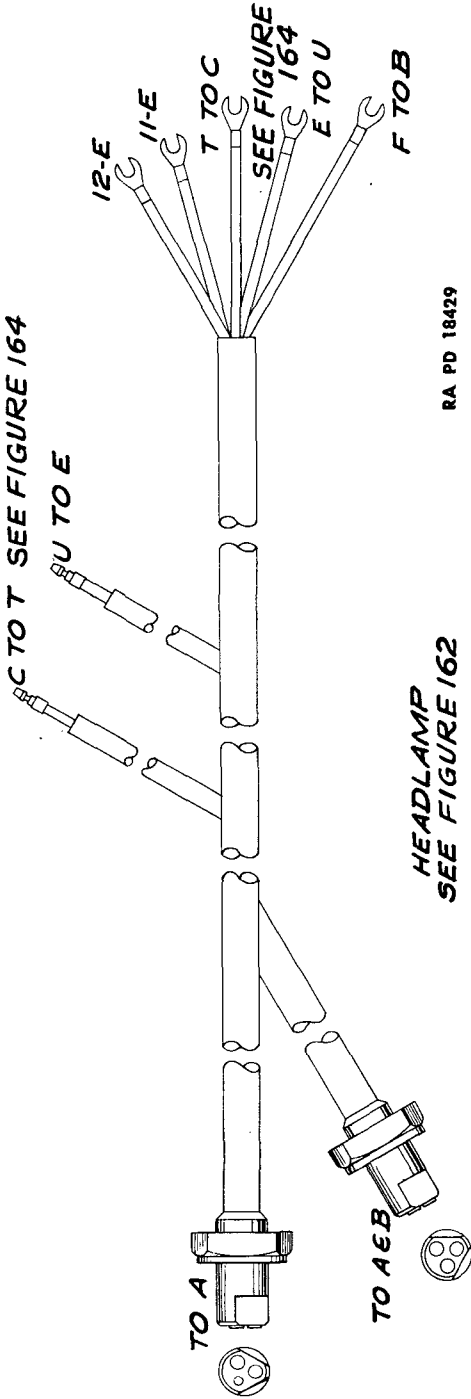

RA PD 18429

HEADLAMP
SEE FIGURE 162

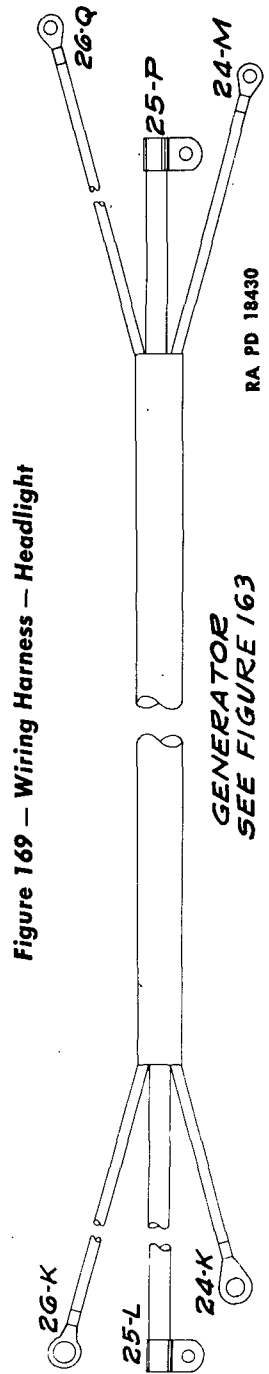

RA PD 18430

GENERATOR
SEE FIGURE 163

Figure 169 — Wiring Harness — Headlight

Figure 170 — Wiring Harness — Generator

ELECTRICAL SYSTEM

terminals. Carbon paths which resemble cracks will also be apparent in the bakelite of the cover. To test whether the secondary circuit is established through the center brush or terminal inside the cover, hold one end of a high-tension cable against this point with its other end three-eighths of an inch from a ground. A spark should jump to ground when a secondary current is induced.

(3) **DISTRIBUTOR ROTOR.** A grounded rotor will interrupt the passage of current between the center segment and the spark plug cables. To test the insulation of the rotor, detach at the cover the cable leading from the coil, remove the distributor cover, and hold the coil to distributor cable approximately three-eighths of an inch from the rotor. Induce a secondary voltage by making and breaking the primary circuit. If a spark occurs, the rotor is grounded and must be cleaned or replaced.

(4) **SPARK PLUG TESTING.** With the secondary circuit checked as far as the spark plugs, the latter must be tested to insure that the spark jumps the gap and ignites the charge in the cylinder. There are several ways in which faulty plugs may be detected.

(a) A spark plug tester may be used. This instrument requires the plug to fire in a chamber of compressed air the pressure of which may be regulated. A mirror arrangement permits observation of sparks occurring at the electrodes, and external sparking or leaking may be noted for faulty plugs.

(b) A spark that will jump the point or gap of a spark plug when the plug is out of the cylinder may not have enough strength to jump the gap when the plug is screwed into the cylinder and under compression.

(c) A running engine has a certain rhythm. If a spark plug of a regularly firing cylinder is shorted out, a different rhythm is produced. By shorting out individual plugs with a bit of a screwdriver across the terminal to a ground, and noting the result on the operation of the engine, faulty cylinders may be checked quickly. If a cylinder is already missing, no change will be noted when its plug is shorted out.

(d) If a plug does not fire satisfactorily after it has been cleaned and adjusted for the correct gap setting, replacement is necessary.

d. Ammeter Indicates Constant Normal Discharge. Under such circumstances the primary circuit is complete but it is not being interrupted to induce a secondary discharge. Several tests can be made for checking troubles of this kind in circuits beyond the ignition coil.

(1) **DISTRIBUTOR.** Disconnect the primary wire where it enters the distributor and if the ammeter needle returns to zero, the distributor is at fault. Remove the distributor cover and watch for opening of the

BASIC HALF-TRACK VEHICLES (IHC) (PERSONNEL CARRIER M5, CAR M9A1, MULTIPLE GUN MOTOR CARRIAGE M14, AND SIMILAR IHC VEHICLES)

contact points; look for presence of foreign matter as a shunt around the points; inspect terminal insulation to insure that movable point is not grounded; check condenser. If the condenser is shorted, a spark will occur when the condenser "pig-tail" is disconnected from the distributor and touched to the live wire.

(2) **COIL-TO-DISTRIBUTOR WIRE.** If the ammeter needle does not return to zero when the primary circuit is opened at the distributor as above, reconnect the wire to the distributor and disconnect the end at the primary exit of the coil to check for a grounded coil-distributor wire. If the needle still does not return to zero, examine the coil terminal for a ground, foreign material, etc. If no ground is found externally, the trouble may be inside the coil where one of the primary windings near the exit may be grounded. Coil replacement is necessary.

e. Ammeter Shows No Discharge. A zero reading on the ammeter with the ignition switch closed indicates an open circuit. Ground the terminal where the primary winding enters the distributor, and if a spark results, the trouble is in the distributor. If no flash occurs, the fault lies back of that source.

(1) **DISTRIBUTOR.** Check the points for closing and make sure that there is a continuous path for the current through the points to ground (distributor base).

(2) **PRIMARY CIRCUIT.** Return to the *battery side* of the ammeter and flash test the wire by holding one end of a test at the terminal being tested and striking the other against a convenient ground. If the starting motor turns the engine, current must be available, and by starting at the ammeter, the trouble may be traced from there.

(a) If a spark is obtained on the battery side of the ammeter, *place this lead on the opposite terminal of the ammeter against excessive test currents.*

(b) Continue the tests for the circuit breakers, the battery side of the ignition switch, the dead side with the switch closed, and so on to complete the circuit to the distributor. The break or defect will be found between the last terminal that showed the presence of current and the next succeeding one that denoted its absence. After satisfactory repair or replacement has been accomplished, the ammeter should be reconnected in the circuit.

f. Ammeter Shows Abnormal Discharge. Such a discharge may be caused by a ground before the primary circuit passes through the majority of the primary windings of the coil. The trouble can be localized by observing the ammeter while turning the ignition switch.

ELECTRICAL SYSTEM

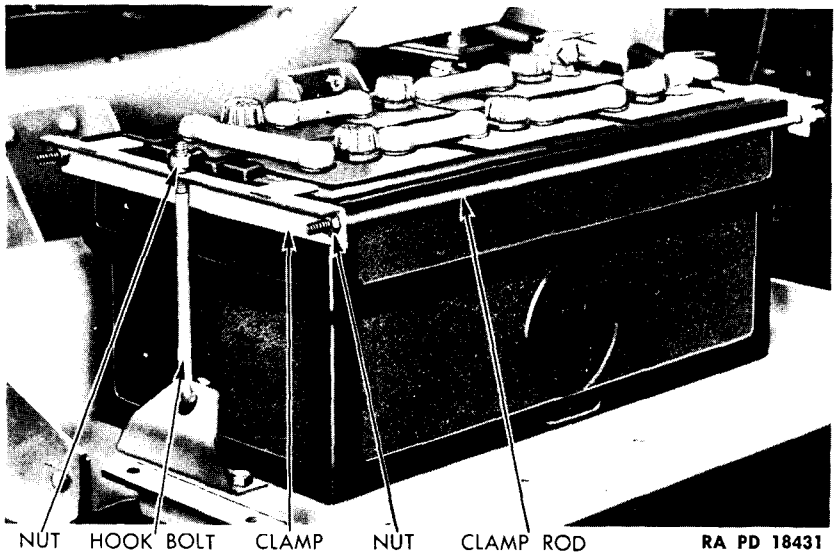

Figure 171 – Battery in Position

(1) SWITCH “OFF.” If the dash ammeter registers zero with the switch “OFF,” the trouble must be past the switch but short of the coil exit terminal.

(2) SWITCH “ON” OR “OFF.” If the discharge exists with the switch either “ON” or “OFF,” the trouble lies between the ammeter and the switch involving the examination of the generator circuit and lead to the circuit breakers. Remove the respective wires to note the effect on the ammeter and to localize the fault. A large discharge or direct short should affect the circuit breaker.

86. BATTERY (fig. 171).

a. The 6-cell, 25-plate per cell, lead acid type battery is rated at 168 ampere hours at the 6-hour rate. The battery is located in a compartment at the side of the frame below the right door. The weight of the battery is 165 pounds.

(1) **VOLTMETER CHECK.** A direct-current voltmeter may be used to indicate to some degree the battery’s condition as far as its capacity to supply current is concerned. With the engine shut down and no load on the battery, the open circuit reading should be approximately 12 volts. An excessive drop (more than 2 to 3 volts) in voltage under heavy load (starting motor engaged, for example) will indicate that something is wrong with the battery or its connection.

BASIC HALF-TRACK VEHICLES (IHC) (PERSONNEL CARRIER M5, CAR M9A1, MULTIPLE GUN MOTOR CARRIAGE M14, AND SIMILAR IHC VEHICLES)**(2) BATTERY FLUID.**

(a) The battery fluid (electrolyte) should be checked at regular intervals and maintained to a level of three-eighths inch above the plates. Clean distilled water only should be used. In cold weather, water should be added just before, or at the beginning of, a charge so that gassing will insure thorough mixing and danger of freezing will be avoided. The specific gravity should be maintained above 1.250. A reading of 1.270 to 1.290 should be maintained when the temperature of the battery fluid is 80 F. A reading of 1.220 indicates a half-charged battery and a reading of 1.150 or lower indicates a complete discharge. Tests with a battery hydrometer made immediately after water has been added will not register correctly. Tests should be made before water is added or after the battery has been on charge or in use for a few hours.

(b) To determine the actual specific gravity of the electrolyte, it is necessary to check the temperature of the solution with a thermometer. If the temperature is normal, 80 F, the specific gravity reading will be correct. However, if the temperature is above or below 80 F it will be necessary to make an allowance to determine the actual specific gravity. This is due to the fact that the liquid expands when warm and the same volume weighs less than it weighs at normal temperature. The reverse is also true and when the temperature is below normal or 80 F the liquid has contracted and the same volume weighs more than it weighs at normal. The correction chart (fig. 172) shows the figures to be used to make these corrections. For example, when the specific gravity, as shown by the hydrometer reading, is 1.290 and the temperature of the electrolyte is 60 F, it will be necessary to *subtract* 8 points or 0.008 from the 1.290 which gives 1.282 as the actual specific gravity. If the hydrometer reading shows 1.270 at a temperature of 110 F it will be necessary to add 12 points or 0.012 to the reading which gives 1.282 as the actual specific gravity.

(3) MAINTENANCE.

(a) *Cleaning.* The battery and battery compartment must be kept clean and dry and the vent plugs tightened although the breather holes in the latter must be kept open. If electrolyte is spilled or any parts are damp with acid, a solution of ordinary baking soda (one pound of soda to one gallon of water) or weak ammonia should be applied, and the surfaces should then be rinsed with fresh water and dried. No cleaning solution should be allowed to enter a cell. Cleaning cloths contaminated with acid should be discarded, and special care must be exercised to keep them away from materiel.

ELECTRICAL SYSTEM

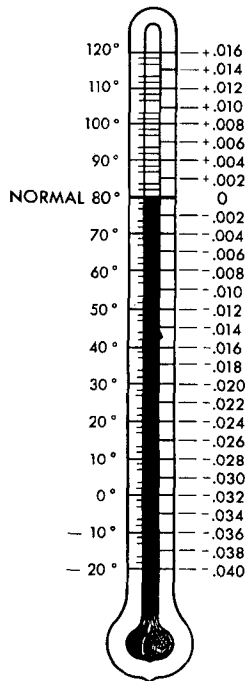

RA PD 43402

Figure 172 – Hydrometer Correction Chart

(b) *Connections.* Cables and terminals should be kept tight or the proper connections cannot be maintained. Scrape clean with a coarse wire brush and then wash surface with hot water and soap. Coat terminals with vaseline, not grease, to prevent formation of corrosion.

(c) *Charging.* Provision is made on the vehicle for normal charging in service from a voltage-regulated, battery-charging direct-current generator as explained in following subparagraphs. Should the battery become discharged through overloading or neglect, however, it should be recharged by a standard auxiliary battery charger.

(4) **TEMPERATURE EFFECTS.** Check the battery for heating in warm weather. If the battery feels more than blood warm, approximately 100 F, check for short circuits and excessive charging.

(a) *Hot Regions.* In tropical regions, danger of overheating is much greater than in cooler climates. The battery, when fully charged, should be adjusted to have a gravity of 1.225 under such conditions.

(b) *Cold Regions.*

1. A fully charged battery at 80 F has only partial discharge capacity at lower temperatures as shown in the following chart:

BASIC HALF-TRACK VEHICLES (IHC) (PERSONNEL CARRIER M5, CAR M9A1, MULTIPLE GUN MOTOR CARRIAGE M14, AND SIMILAR IHC VEHICLES)

TEMPERATURE DEGREES	PERCENT DISCHARGE CAPACITY
80 F	100 percent
40 F	76 percent
20 F	61 percent
0 F	43 percent
-10 F	35 percent
-20 F	25 percent
-30 F	15 percent
-40 F	10 percent

2. The specific gravity of the battery electrolyte determines the temperature at which a battery will be harmed or damaged by freezing as shown in the following chart:

ELECTROLYTE SPECIFIC GRAVITY	ELECTROLYTE FREEZING POINT
1.280	-90 F
1.220	-30 F
1.210	-20 F
1.180	-10 F
1.160	0 F
1.140	+10 F
1.100	+20 F
1.000	+32 F

(5) **STORAGE.** Batteries may be stored for several months without dismantling provided the electrolyte is fully maintained at the proper level. They must be kept charged either by periodic charging (every two weeks, approximately) or by trickle charging. If either of these procedures is followed, stored batteries will be available for immediate use. Batteries tend to be self-discharging while standing idle. Idle batteries will discharge much faster in warm surroundings than those stored in a cool place. After being idle for several months and then put back into service in a discharged or partially charged state, the battery plates may buckle and have a shorter life, and a much reduced capacity to recharge.

(6) **TROUBLE SHOOTING.**

(a) *Discharged Battery.*

ELECTRICAL SYSTEM

Connections loose.	Tighten connections.
Connections dirty.	Clean connections.
Generator regulator out of order.	Replace regulator (par. 89).
Generator not charging.	Replace generator (par. 88 e).
<i>(b) Battery Overheating.</i>	
Generator regulator out of order.	Replace regulator (par. 89).
High charging rate.	Check or replace regulator (par. 89).

(7) **BATTERY REPLACEMENT.** To reach the battery it is necessary to remove the side and top armor plates forming part of the battery housing.

(a) Equipment.

WRENCH, end, 1/2-in.

WRENCH, end, 9/16-in.

(b) Procedure.

1. *Remove battery box cover.*

WRENCH, end, 9/16-in.

Remove three cap screws holding battery box top cover. Remove cover.

2. *Remove battery box side plate.*

WRENCH, end, 9/16-in.

Remove four cap screws and nuts holding the battery box side plate. Remove plate.

3. *Disconnect battery cables.*

WRENCH, end, 9/16-in.

Disconnect positive and negative battery cables from battery. *Disconnect negative cable first.* This will prevent destructive arcs.

4. *Remove battery hold-down bolts.*

WRENCH, end, 9/16-in.

Remove nuts from two battery hold-down bolts, one at each end of battery.

5. *Remove battery.*

Lift out battery and battery clamp assembly.

6. *Remove battery clamp assembly.*

WRENCH, end, 1/2-in.

Loosen nuts at ends of battery clamp assembly rods. Remove clamp assembly.

7. *Install clamp assembly.*

**BASIC HALF-TRACK VEHICLES (IHC) (PERSONNEL CARRIER M5, CAR M9A1,
MULTIPLE GUN MOTOR CARRIAGE M14, AND SIMILAR IHC VEHICLES)**

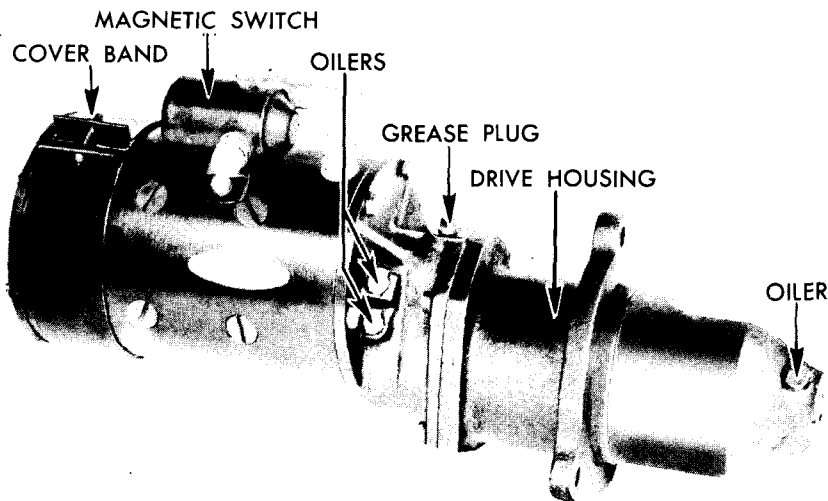

Figure 173 — Starting Motor

RA PD 18432

8. *Install battery.*
9. *Install battery hold-down bolt nuts and washers.*
10. *Connect battery cables to battery.*
Connect negative or ground terminal last.
11. *Install side armor plate.*
12. *Install top or cover armor plate.*

87. STARTING MOTOR (figs. 173 and 174).

a. The cranking motor is a flange-mounted, 6-brush, 6-pole unit, with Bendix drive, operated by a magnetic switch and using internal reduction gears. The Bendix drive provides automatic meshing of the driving pinion when the cranking motor control switch is closed and the magnetic switch is energized. When the engine starts, the drive pinion is automatically disengaged. The weight of the unit is 42 pounds.

b. **Maintenance.** Every 100 hours or 1,000 miles, the following should be performed: Lubricate by adding 8 to 10 drops of light engine oil to visible hinge cap oilers. The cover band should be removed and the brushes and commutator inspected. If the commutator is dirty, it may be cleaned with PAPER, flint, class B, No. 00. **CAUTION: CLOTH, abrasive, aluminum-oxide, must not be used.** If the commutator is rough, out of round, burned, or has high mica, the cranking motor must be removed so the commutator can be turned down in a lathe and the mica

ELECTRICAL SYSTEM

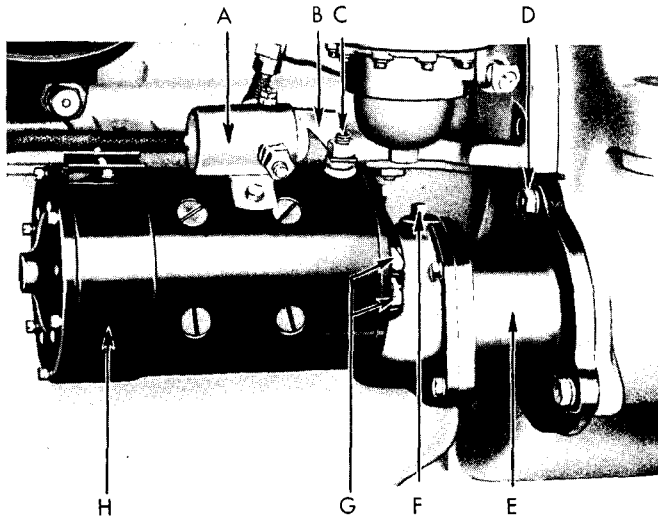

A—MAGNETIC SWITCH
 B—SWITCH CONNECTOR STRAP
 C—STARTER TERMINAL STUD
 D—STARTER MOTOR TO HOUSING
 SCREW (3) WITH LOCKWASHER (3)

E—DRIVE HOUSING
 F—GREASE PLUG
 G—OILERS
 H—COVER BAND

RA PD 18433

Figure 174 — Starting Motor — Installed

undercut. The brush tension for good contact as measured on tension scale is from 30 to 40 ounces. If the brushes wear rapidly, it may be advisable to remove the cranking motor and check for excessive spring tension, roughness, and high mica on the commutator. The connections at the terminals must be tight and the mounting studs and lock washers in place and tight. Every 600 hours or 6,000 miles, the cranking motor should be removed from the vehicle and replaced by a new, rebuilt unit. The old unit should be sent to a higher echelon for repair and rebuilding.

c. **Procedure.** The operator has the responsibility of properly operating the cranking motor when starting the engine, and of observing the manner in which the cranking motor operates so that if abnormal operation is noted, proper corrective steps can be taken. When the cranking motor is operated, it should take hold promptly, and spin the engine at a good cranking speed. **CAUTION:** Never operate the cranking motor more than 30 seconds at a time without a pause of several minutes, since excessive operation will damage the cranking motor. Never attempt to move the vehicle with the cranking motor.

d. **Trouble Shooting.** If the cranking motor cranks the engine slowly or not at all, check as follows to locate the trouble:

BASIC HALF-TRACK VEHICLES (IHC) (PERSONNEL CARRIER M5, CAR M9A1, MULTIPLE GUN MOTOR CARRIAGE M14, AND SIMILAR IHC VEHICLES)

(1) If the cranking motor cranks the engine slowly, check the battery, battery terminals, switch connections, and cables, in the circuit from the battery to the cranking motor. Defects at any of these points will prevent normal cranking motor operation. Low temperatures, as well as mechanical conditions in the engine or cranking motor (tight bearings, excessively heavy oil, etc.) will reduce cranking speed. If the trouble is due to poor connections at the battery, it is sometimes possible to twist the clamp on the terminal back and forth a few degrees so that better contact is established and starting can be accomplished. The remedy is to clean the terminal and tighten the connection. If the connections seem to be in good order, remove the cranking motor cover band and check the brushes and commutator. Dirty, gummy, or oily commutator, weak brush spring tension, or worn brushes may prevent good cranking motor operation. If the cause of defective operation seems to be a dirty or gummy commutator, it may be cleaned by operating the cranking motor and holding a piece of fine PAPER, flint, class B, No. 00, against the commutator. This is a temporary correction; the cranking motor should be removed from the vehicle as soon as possible and replaced.

(2) If the cranking motor does not operate at all, it may be the result of conditions discussed in the previous paragraph. Also, it could be due to open circuits in the magnetic switch or solenoid switch control circuit. Test by placing a jumper lead from battery terminal of magnetic switch to the small terminal on the top of the magnetic switch. This bypasses the magnetic switch control circuit. If the magnetic switch and the cranking motor now operate, the magnetic switch control circuit is open. If the switch and cranking motor still do not operate, connect a heavy jumper lead between the two main terminals, connecting the lead to nuts and nut studs, to avoid burning threads. This connects the cranking motor direct to the battery and if it is in normal condition, it will operate normally and the cause of trouble is known to be in the ignition switch. If the cranking motor still does not operate, and the battery leads and connections are good, then the cause of trouble is in the cranking motor. The cranking motor cover band should be removed so the brushes, commutator, and internal connections can be checked as outlined in the previous paragraph. If the cranking motor commutator is so dirty or burned that there is no circuit between the commutator and brushes, it is sometimes possible to get started by rotating the armature a few degrees by hand, using a piece of fine PAPER, flint, class B, No. 00, to clean the commutator so that good contact is established. Do not rotate the armature with a screwdriver or similar instrument, as this would damage the commutator or riser bars. Replace the cranking motor as soon as possible.

ELECTRICAL SYSTEM

Starting Motor Replacement.

(1) EQUIPMENT.

HANDLE, socket wrench

WRENCH, end, $\frac{5}{8}$ -in.

WRENCH, end, $1\frac{1}{32}$ -in.

WRENCH, socket, $\frac{9}{16}$ -in.

(2) PROCEDURE.

(a) *Disconnect Battery and Ammeter Cables.*

WRENCH, end, $\frac{5}{8}$ -in.

Disconnect battery cable and ammeter cable at starter.

(b) *Disconnect Starter-Button-to-Starter-Switch Wire.*

WRENCH, end, $1\frac{1}{32}$ -in.

Disconnect starter-button-to-starter-switch wire at switch.

(c) *Remove Starter-to-Housing Screws and Lock Washers.*

HANDLE, ratchet wrench

WRENCH, socket, $\frac{9}{16}$ -in.

Remove three starter-to-flywheel-housing cap screws and washers.

(d) *Remove Starting Motor.*

(e) *Install Replacement Starting Motor and Retaining Cap Screws and Washers.*

(f) *Connect Wire from Starter Button to Starter Switch.*

(g) *Connect Battery and Ammeter Wires to Starting Motor Switch.*

88. GENERATOR (figs. 175 and 176).

a. **Description.** The generator is a heavy-duty, 12-volt, 55-ampere, 6 $\frac{9}{16}$ -inch frame size, ventilated unit, driven by a pulley, with the armature supported at both the drive end and commutator end of the generator by heavy-duty ball bearings. The generator output is controlled by the regulator, in the manner detailed in the regulator section (par. 89). The generator weighs 83 pounds.

b. **Maintenance.**

(1) Every 100 hours or 1,000 miles, the cover band should be removed and the commutator and brushes inspected. If the commutator is dirty, it may be cleaned with PAPER, flint, class B, No. 00. CAUTION: Never use CLOTH, abrasive, aluminum-oxide, to clean the commutator. The proper brush tension for good contact as measured on a tension scale is 25 ounces. If the brush length is not sufficient to last until the next inspection period, the generator should be replaced. The pulley nut should be tight, the belt tension should be correct, and the mounting bolts tight. The connections and wiring in the generator-to-battery circuit should be in good condition. Lubricate the ball bearings by turning grease cups down one turn.

BASIC HALF-TRACK VEHICLES (IHC) (PERSONNEL CARRIER M5, CAR M9A1, MULTIPLE GUN MOTOR CARRIAGE M14, AND SIMILAR IHC VEHICLES)

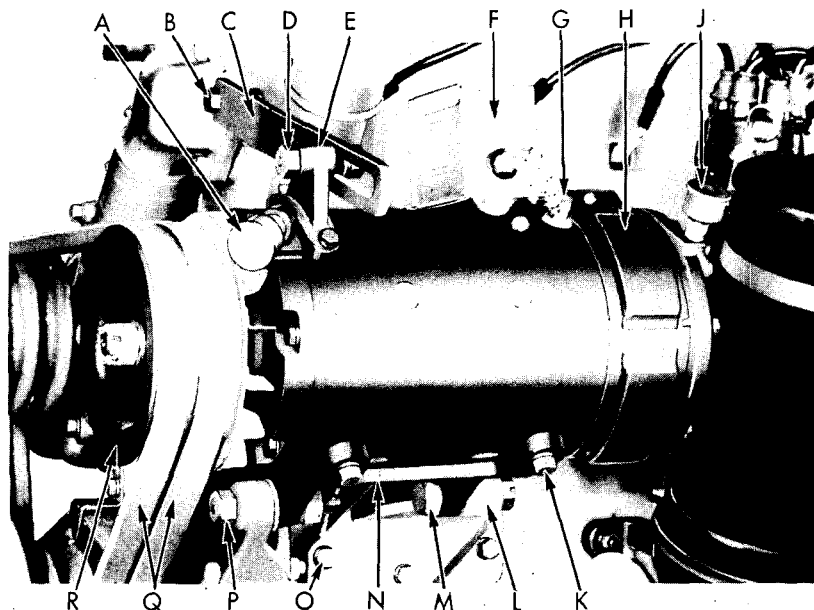

- | | |
|---------------------------------------|--------------------------------|
| A—GREASE CUP | L—GENERATOR SUPPORT BRACKET |
| B—STRAP TO PUMP BOLT | M—GENERATOR TO CRANKCASE |
| C—ADJUSTMENT SLOTTED STRAP | BRACKET MOUNTING BOLT—REAR |
| D—STRAP TO GENERATOR BRACKET BOLT | N—GENERATOR SUPPORT BRACKET |
| E—FAN BELT ADJUSTING BRACKET | O—MOUNTING BRACKET TO |
| F—FILTER | CRANKCASE CAPSCREW |
| G—ARMATURE TERMINAL | P—GENERATOR TO GEAR COVER |
| H—COVER BAND | MOUNTING BOLT—FRONT |
| J—GREASE CUP | Q—FAN BELTS (2) |
| K—BRACKET TO GENERATOR SCREW (4) WITH | R—GENERATOR PULLEY, WITH SHAFT |
| LOCKWASHERS (4) | NUT, WASHER, AND COTTER PIN |

RA PD 18434

Figure 175 — Generator — Installed

(2) Every 600 hours or 6,000 miles the generator should be removed from the vehicle and replaced by a new or rebuilt unit. The old unit should be sent to a higher echelon for repair and rebuilding. See "Polarizing generator" under "Replacement," below.

c. **Procedure.** The operator of the vehicle has the responsibility of observing the manner in which the generator is performing, so that if some abnormal operating conditions are noted, proper corrective steps may be taken before complete failure of the equipment takes place. During starting, and after the equipment is in operation, the position of the ammeter should be noted. If the battery is in a low state of charge, the ammeter

ELECTRICAL SYSTEM

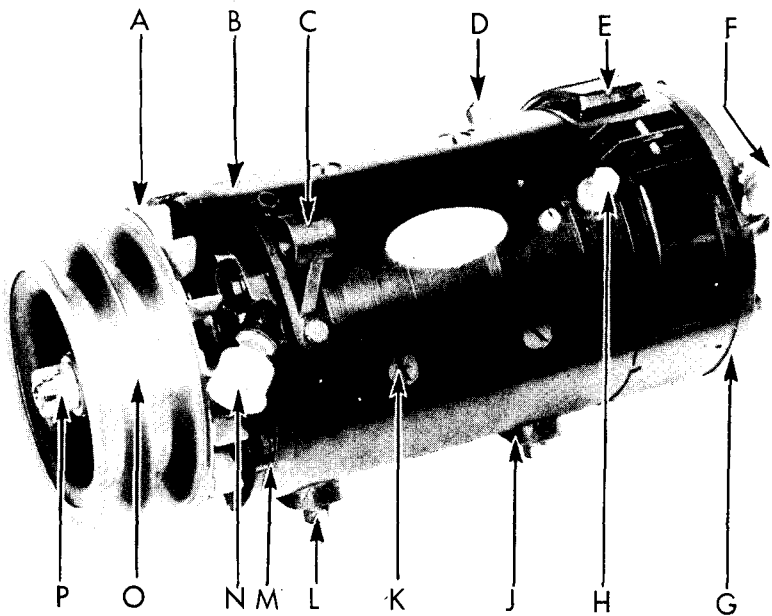

- | | |
|------------------------------|----------------------------------------------------------|
| A—VENTILATOR FAN | J—GENERATOR SUPPORT BRACKET |
| B—GENERATOR HOUSING | K—POLE SCREW |
| C—FAN BELT ADJUSTING BRACKET | L—BRACKET TO GENERATOR SCREW
(4) WITH LOCK WASHER (4) |
| D—FIELD TERMINAL | M—DRIVE END FRAME |
| E—COVER BAND | N—GREASE CUP—FRONT |
| F—GREASE CUP—REAR | O—GENERATOR PULLEY |
| G—END FRAME | P—SHAFT NUT, WITH WASHER,
AND COTTER PIN |
| H—ARMATURE TERMINAL | |

RA PD 18435

Figure 176 – Generator

hand will indicate a fairly high charging rate. If the battery is in a good state of charge, the generator will soon begin to reduce its output as the current used in starting is replaced in the battery. This reduction of output is accomplished by the operation of the generator regulator, and results in a tapering off of generator output to a few amperes as the battery reaches a charged condition. This action is indicated by a dropping back of the ammeter needle toward zero. Failure of the equipment to function in this manner requires further consideration of the units as outlined below.

d. Trouble Shooting. The regulator controls the generator output at all times for any particular load and speed condition in the operating range. Consequently, when any abnormal condition of operation is noted,

BASIC HALF-TRACK VEHICLES (IHC) (PERSONNEL CARRIER M5, CAR M9A1, MULTIPLE GUN MOTOR CARRIAGE M14, AND SIMILAR IHC VEHICLES)

it is first necessary to check the generator-regulator system as a whole in order to isolate the trouble in either the generator or the regulator. This procedure is outlined under the regulator section (par. 89). If the trouble is found to be due to some condition in the generator, the generator may be checked further as indicated below.

(1) **NO GENERATOR OUTPUT.** If no output can be obtained from the generator, remove the cover band and check for sticking or worn out brushes, gummed or burned commutator, or other causes or poor contact between the commutator and the brushes. If the trouble is due to a gummed or dirty commutator, operation may be temporarily restored by holding a strip of PAPER, flint, class B, No. 00, against the commutator with a piece of wood while the generator is operated. **CAUTION:** Do not use CLOTH, abrasive, aluminum-oxide. Worn brushes, rough or out-of-round commutator, or other troubles not readily apparent, will require removal and replacement of the generator.

(2) **UNSTEADY OR LOW OUTPUT.** Check for loose drive belt, sticking brushes, low brush spring tension, dirty, out-of-round, or rough commutator, or high mica on the commutator.

(3) **EXCESSIVE OUTPUT.** The maximum output of the generator is not shown on the service ammeter while in operation, but when cold is approximately 55 amperes at 13 volts and 900 revolutions per minute. Excessive output is usually the result of a high regulator setting, etc.

(4) **NOISY GENERATOR.** Check for loose pulley, mounting, worn bearings, and improperly seated brushes.

e. Generator Replacement.

(1) EQUIPMENT.

PLIERS	WRENCH, end, $\frac{3}{4}$ -in.
SCREWDRIVER	WRENCH, end, $1\frac{3}{16}$ -in.
WRENCH, end, $\frac{9}{16}$ -in.	WRENCH, end, $\frac{7}{8}$ -in.
WRENCH, end, $\frac{5}{8}$ -in.	WRENCH, end, 1-in.

(2) PROCEDURE.

(a) *Disconnect Wires at Armature Terminal and at Field Terminal.*

WRENCH, end, $\frac{9}{16}$ -in.

Disconnect cable at armature terminal of generator and at field terminal of generator.

(b) *Disconnect Wires at Radio Suppression Filter.*

SCREWDRIVER

Disconnect wires at filter.

ELECTRICAL SYSTEM

- (c) *Disconnect Generator-to-Regulator Ground Wire.*

SCREWDRIVER

Disconnect ground wire at generator.

- (d) *Remove Adjusting-Strap-to-Generator-Bracket Bolt.*

WRENCH, end, $\frac{5}{8}$ -in.

WRENCH, end, $\frac{3}{4}$ -in.

Remove generator-adjusting-strap-to-generator-bracket bolt with nut and washers. Hold bolt with $\frac{5}{8}$ -inch wrench and remove nut with $\frac{3}{4}$ -inch wrench.

- (e) *Remove Fan Belts.*

Move generator in toward engine to permit removal of fan and generator drive belts from generator. Remove belts from generator pulleys.

- (f) *Remove Generator-to-Lower-Bracket-Mounting Bolts, Cotter Pins, Nuts, and Washers.*

PLIERS

WRENCH, end, $\frac{7}{8}$ -in.

WRENCH, end, $1\frac{3}{16}$ -in.

WRENCH, end, 1-in.

Remove cotter pin from lower bracket front bolt. Remove nuts and washers from generator-to-bracket-mounting bolts. Remove bolts and remove generator.

- (g) *Remove Radio Suppression Filters.*

Remove screws holding filters to generator. Remove filters.

- (h) *Install Filters on Replacement Generator.*

- (i) *Install Replacement Generator and Lower Bracket Mounting Bolts.*

- (j) *Connect Fan and Generator Drive Belts.*

- (k) *Install but Do Not Tighten Generator-Adjusting-Strap-to-Generator-Bracket Bolt, Nut, and Washer.*

- (l) *Adjust Fan and Generator Drive Belts.*

Move generator away from engine, using wheel hub stud nut wrench handle as lever exerting full one-arm pull on bar so that fan belts will be tightened snugly. Tighten all generator mounting bolt nuts.

- (m) *Connect Wires to Radio Noise Suppression Filters.*

- (n) *Connect Cables to Armature Terminal and to Field Terminals of Generator.*

After polarizing generator as outlined in substep (p) 1 below.

- (o) *Connect Ground Wire.*

- (p) *Precautions.*

BASIC HALF-TRACK VEHICLES (IHC) (PERSONNEL CARRIER M5, CAR M9A1, MULTIPLE GUN MOTOR CARRIAGE M14, AND SIMILAR IHC VEHICLES)

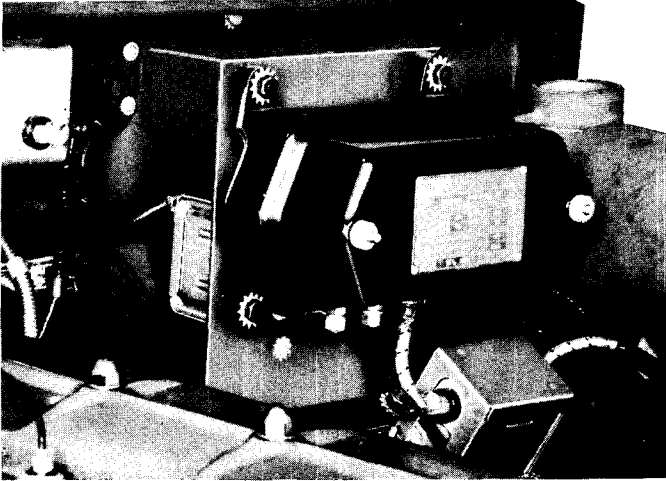

RA PD 18436

Figure 177 – Generator Regulator – Installed

1. Polarizing generator.

After the generator is reinstalled on the engine, connect all leads except the lead to the generator field "F" terminal. Use a jumper lead to connect this field "F" terminal momentarily to the insulated battery terminal. This allows a momentary flash of current to flow through the field windings which correctly polarizes the generator with respect to the system.

2. Open circuit operation.

Never operate the generator with the field circuit connected and the armature "A" terminal disconnected (open circuit operation) since this would allow high voltage to build up within the generator which would damage the fields and armature.

89. GENERATOR REGULATOR (fig. 177).

a. Description. The generator regulator consists of three units, a cut-out relay, a voltage regulator, and a current regulator.

(1) The *cut-out relay* closes the circuit between the generator and the battery when the generator voltage has built up to a value sufficient to force a charge into the battery. The cut-out relay opens the circuit when the generator slows or stops and current begins to flow back from the battery into the generator.

ELECTRICAL SYSTEM

(2) The *voltage regulator* prevents the line voltage from exceeding a predetermined value and thus protects the battery and other electrical units in the system from high voltage. One characteristic of batteries is that as either the specific gravity or the charging rate increases, other conditions being the same, the battery terminal voltage increases. If the terminal voltage is held constant as the battery comes up to charge (specific gravity increases) the charging rate will be reduced. The voltage regulator performs this job of holding the voltage constant and it consequently protects the electrical system from high voltage and the battery from overcharge.

(3) The *current regulator* limits the generator output to a safe value. It is, in effect, a current limiting device which operates when the generator output has increased to its safe maximum and it prevents the generator from exceeding this value.

b. Generator Regulator Replacement. Every 600 hours or 6,000 miles, the generator regulator should be replaced by a new or rebuilt unit and the old unit sent to a higher echelon for check and adjustment.

(1) EQUIPMENT.

SCREWDRIVER

WRENCH, end, 1/2-in.

(2) PROCEDURE.

(a) *Disconnect Wiring at Generator Regulator.*

SCREWDRIVER

WRENCH, end, 1/2-in.

Using a 1/2-inch end wrench disconnect wires at armature terminal on generator regulator, at field terminal on generator regulator, and at battery terminal on generator regulator. Be sure that lead clip does not ground. Cover it with tape. Do not ground wrench while disconnecting battery lead.

(b) *Remove Generator-Regulator-to-Bracket-Mounting Bolts.*

WRENCH, end, 1/2-in.

Remove the four generator-regulator-to-bracket-mounting bolts, nuts, and 12 special lock washers.

(c) *Disconnect Ground Terminal Wire and Remove Generator Regulator.*

SCREWDRIVER

Tip generator regulator to permit removal of ground terminal screw from bottom of case. Remove generator regulator from vehicle.

(d) *Install Replacement Generator Regulator and Connect Ground Terminal.*

(e) *Install Generator-Regulator-to-Bracket-Mounting Bolts, Nuts, and Special Lock Washers.*

BASIC HALF-TRACK VEHICLES (IHC) (PERSONNEL CARRIER M5, CAR M9A1, MULTIPLE GUN MOTOR CARRIAGE M14, AND SIMILAR IHC VEHICLES)

NOTE: The special lock washers are an important part of the radio noise suppression system and must be installed at each bolt having one washer under head of bolt, one washer between generator regulator base and bracket, and one washer under nut of bolt.

(f) Connect Wires at Generator Regulator.

Connect battery terminal wire, field terminal wire, and armature terminal wire at generator regulator.

(g) Polarize Generator.

Procedure is outlined in paragraph 88 e (2) (p).

c. Operation.

Under "Operation" and "Trouble Shooting" in paragraph 88 e and d on the generator, the manner in which the generator and the regulator operate together has already been detailed. The current regulator prevents the generator output from exceeding the safe maximum of the generator. The generator regulator tapers the output down as the battery comes up to charge and load requirements are reduced. Failure to operate in this manner requires further analysis as outlined below.

d. Trouble Shooting.

When defective operation is noted, the trouble may be further analyzed in order to locate the source of trouble, so the proper corrective steps may be taken.

(1) FULLY CHARGED BATTERY AND A HIGH CHARGING RATE.

(a) This condition is abnormal, and will produce battery overcharge and possibly high voltage. To determine which unit is at fault, with the generator operating at about 2,000 revolutions per minute, disconnect the lead from the regulator "F" terminal. If the output drops off, the generator regulator is at fault. If the output remains high, the generator is defective and must be replaced.

(b) Before replacing a regulator which appears at fault, the effect of temperature should be considered. Abnormally high temperatures, as for example might be encountered in the desert or tropics, tend to reduce battery resistance so that battery overcharge may occur, even with normal generator regulator settings. Report to higher authority.

(2) A LOW BATTERY AND A LOW OR NO CHARGING RATE.

Check the circuit for defective wiring and loose connections. If these are in order, momentarily connect a jumper lead between the *armature* and the *field* terminals of the regulator with the generator operating at about 2,000 revolutions per minute. If the output increases substantially, the regulator may be considered to be at fault, and it should be replaced.

ELECTRICAL SYSTEM

If the output remains low with the terminals bridged, then the generator may be considered as being at fault, and it should be checked as outlined in the trouble shooting part of the generator section (par. 88).

e. Failure in Operation.

In the event of an emergency involving the voltage regulator, it would be practical to disconnect the field terminal lead at the generator to prevent the latter from developing any voltage while operating with generator regulator out of action, or until the particular trouble can be identified and corrected. In case contacts of the generator regulator relays tend to seal, the generator has no protection electrically other than to have its field and armature terminals disconnected since it cannot readily be removed if the engine is to continue running and retain the belt drive for the fan. The best procedure, if material is available, is to replace a generator regulator when there is indication of trouble that cannot be simply determined and corrected.

90. IGNITION COIL (fig. 178).

a. Description.

(1) The ignition coil is oil filled and tightly sealed with a porcelain cap at the lower end to assure constant oil immersion of the high-tension terminal connection.

(2) The purpose of the coil is to convert the pulsations of direct current of the ignition system to high voltage surges which are produced at the correct intervals and with the correct timing to the engine. Each high voltage surge produces a spark at the spark plug gap which ignites the mixture of air and fuel which had been drawn into the cylinder. When the distributor points are closed, current flows through them to the coil, causing a magnetic field to build up in the coil. When the contact points open, the current stops and the magnetic field collapses, causing a high voltage surge to be induced. This high voltage surge then passes through the wiring, distributor cap, and rotor, to the spark plugs.

b. Trouble Shooting and Maintenance. If in doubt as to a coil's performance, substitute a unit known to be satisfactory and check difference in operation, or if time permits, proceed as in paragraph 89 to locate the trouble. Terminals must be kept tight, clean, and dry.

c. Coil Replacement.

(1) EQUIPMENT.

WRENCH, end, $\frac{3}{8}$ -in.

WRENCH, end, $\frac{1}{2}$ -in.

(2) PROCEDURE.

(a) *Disconnect High-tension Cable from Coil.*

BASIC HALF-TRACK VEHICLES (IHC) (PERSONNEL CARRIER M5, CAR M9A1, MULTIPLE GUN MOTOR CARRIAGE M14, AND SIMILAR IHC VEHICLES)

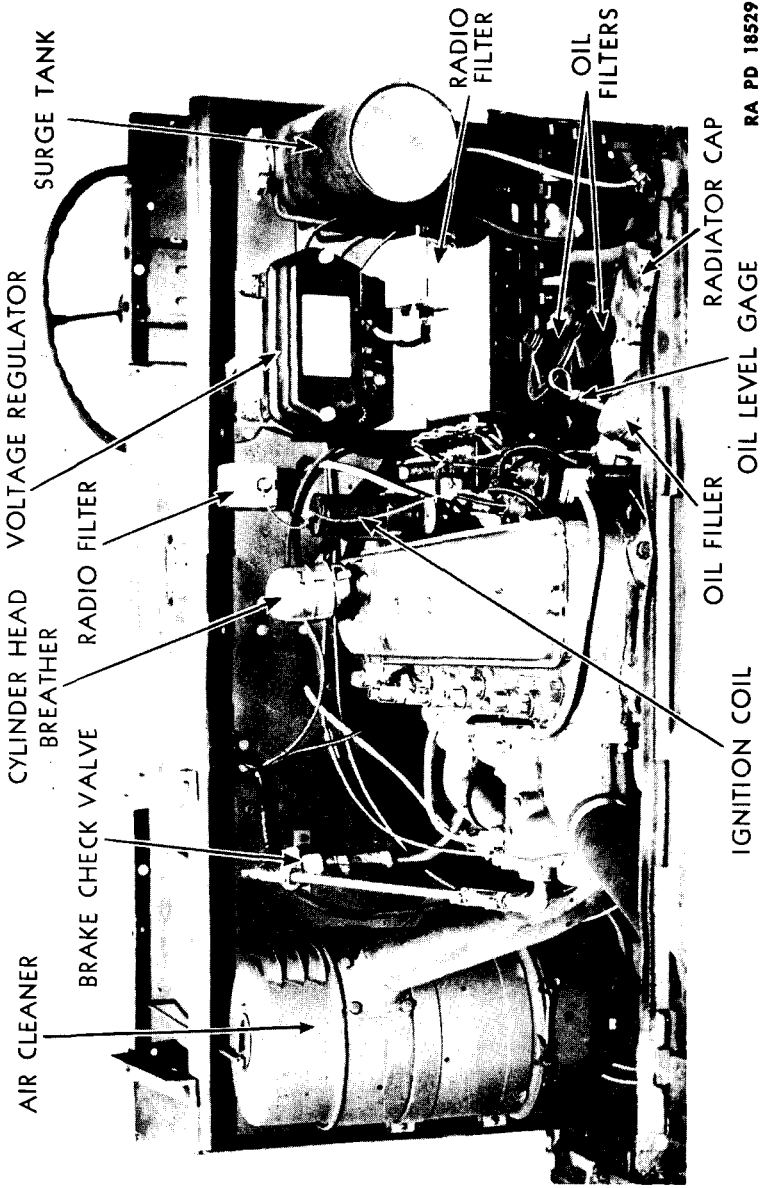
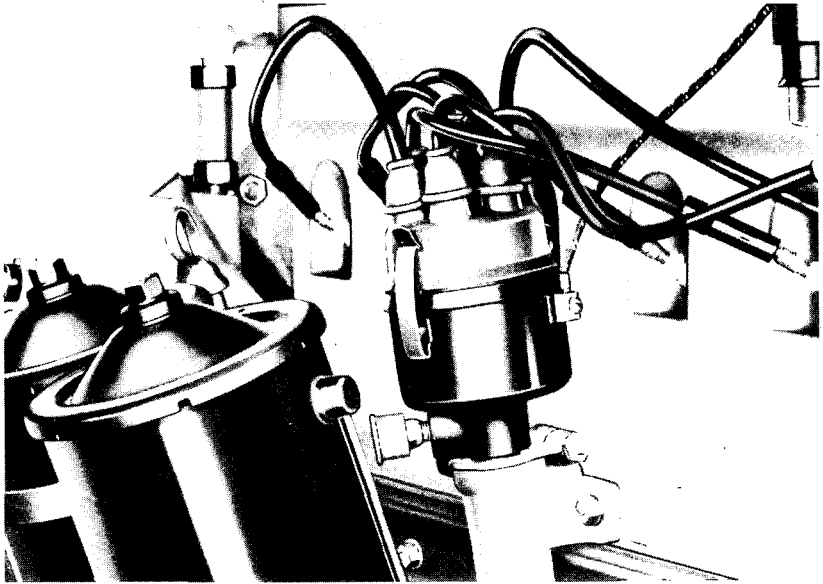

Figure 178 — Engine View from Front, Showing Coil

ELECTRICAL SYSTEM



RA PD 18437

Figure 179 – Distributor – Installed

(b) *Disconnect Low-tension Wires to Distributor and to Switch.*

WRENCH, end, $\frac{3}{8}$ -in.

Disconnect low-tension leads from coil.

(c) *Remove Coil.*

WRENCH, end, $\frac{1}{2}$ -in.

Remove two coil mounting bracket nuts and four special lock washers. Remove coil.

(d) *Install Replacement Coil.*

Place one special lock washer on each side of coil mounting bracket at each mounting screw.

(e) *Connect Low-tension Leads to Coil.*

(f) *Connect High-tension Cable to Coil.*

91. DISTRIBUTOR.

a. **Description** (fig. 179). The distributor is of the fully automatic advance type and is driven by the camshaft through an extension of the lubricating oil pump shaft. Rotation of the distributor shaft is clockwise viewed from the top of the unit. The advance mechanism (at 4 degrees B.T.C.) starts to operate at about 300 revolutions per minute engine speed and a maximum advance $22\frac{1}{2}$ degrees is at 1,800 revolutions per minute engine speed.

BASIC HALF-TRACK VEHICLES (IHC) (PERSONNEL CARRIER M5, CAR M9A1, MULTIPLE GUN MOTOR CARRIAGE M14, AND SIMILAR IHC VEHICLES)

b. **Maintenance.** Every 100 hours or 1,000 miles, make the following checks. The distributor cap should be removed so the cap and rotor can be inspected for chips, cracks, and burned paths. Cap and rotor should be wiped with a soft cloth. Check centrifugal advance by rotating cam in its direction of normal rotation by hand. It should turn a few degrees against the advance springs and, when released, should come back to its original position. Inspect high-tension wiring and connections. Check the contact points. If the points are badly burned or pitted, it will be necessary to replace them. The points may be adjusted by setting the point opening to 0.018 to 0.024 inch or cam angle to 35 degrees.

(1) **EQUIPMENT.**

GAGE, feeler	SCREWDRIVER
OIL STONE, moderate coarse	TENSION SCALE

(2) **PROCEDURE.**

(a) *Remove Distributor Cap and Rotor and Dust Cap from Distributor.*

(b) *Disconnect Condenser Wire.*

SCREWDRIVER

Disconnect condenser wire at breaker arm in distributor.

(c) *Remove Breaker Arm from Distributor.*

(d) *Remove Contact Screw from Breaker Plate in Distributor.*

SCREWDRIVER

Remove screw from contact point at breaker plate in distributor. Remove contact point.

(e) *Replace Contact Points and Set Breaker Arm Tension.*

TENSION SCALE

Replace contacts and set breaker arm tension at 17 to 21 ounces as measured on scale. Tension may be changed by bending contact arm spring. Connect condenser wire.

(f) *Adjust Breaker Contacts.*

Turn engine over until breaker contacts are fully separated. This will be when the fiber rubbing block on the breaker arm is on the highest point of the cam. Loosen the lock nut on the contact screw and adjust to obtain maximum gap of 0.018 to 0.024 inch with points fully separated. Point opening for new points may be checked with a feeler gage but the roughness of used points make point setting with gage unsatisfactory. A dial indicator or contact angle meter should be used to check the point opening of used points. (Contact or dwell angle is 35 degrees.)

ELECTRICAL SYSTEM

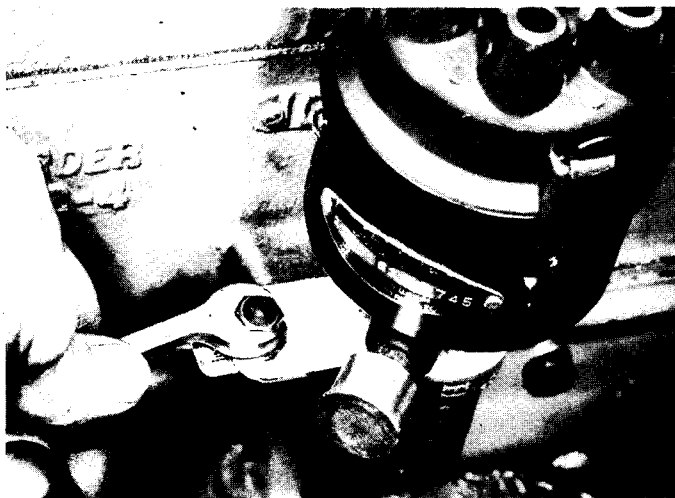

RA PD 18438

Figure 180 – Distributor Retaining Bolt – Removal

When setting contact point opening with a feeler gage, check opening for every point lobe. The difference should not exceed 0.001 inch. If the difference is 0.002 inch or more, or the cams are eccentric, the distributor should be replaced. As the rubbing block on the ignition contact arm wears down, the timing becomes late.

(g) Tighten Nut on Contact Screw and Recheck Gap.

Insert a narrow strip of paper between the contacts and turn the engine until the contacts close. Draw the paper back and forth to remove any oil or grease remaining on the points to assure good contact.

(h) Install Rotor and Check Setting.

Move rotor back and forth as far as the slack in the distributor gear will permit. If the setting is correct, the points will open and close. Remove rotor.

(i) Install Dust Shield, Rotor, and Distributor Cap.

(j) Test Engine.

Try out engine at various speeds after replacing distributor cap. If the engine does not run smoothly, check engine ignition timing.

c. Distributor Replacement.

(1) EQUIPMENT.

SCREWDRIVER

WRENCH, end, $\frac{7}{16}$ -in.

(2) PROCEDURE.

(a) Disconnect Distributor High-tension Wires from Distributor Cap.

BASIC HALF-TRACK VEHICLES (IHC) (PERSONNEL CARRIER M5, CAR M9A1, MULTIPLE GUN MOTOR CARRIAGE M14, AND SIMILAR IHC VEHICLES)

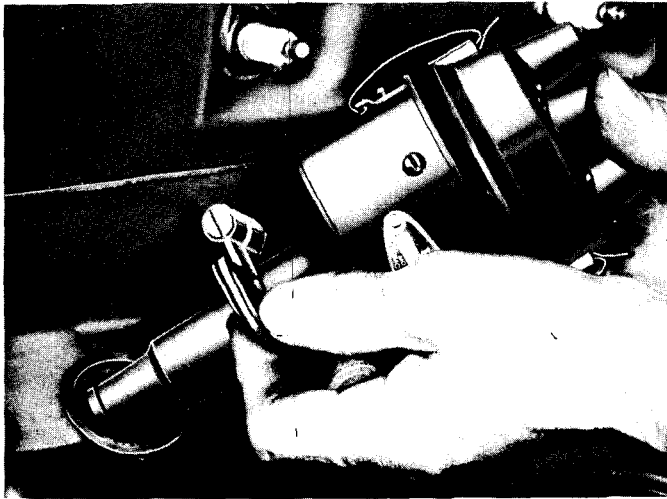

RA PD 18439

Figure 181 – Distributor – Removal

(b) Disconnect Low-tension Lead at Side of Distributor.

SCREWDRIVER

Disconnect low-tension lead from side of distributor.

(c) Remove Distributor Retaining Bolt and Washer (fig. 180).

WRENCH, end, $\frac{7}{16}$ -in.

Remove distributor retaining bolt and washer from distributor clamp arm.

(d) Remove Distributor from Tachometer Drive Housing (fig. 181).

(e) Replacement Distributor Installation.

If the engine has not been rotated while the distributor was removed, the distributor can be remounted in the original position. However, if engine has been rotated it will be necessary to proceed as follows:

1. Rotate engine in normal direction of operation until the No. 1 piston is at top dead center. This position may be checked with a position gage through the hole of the No. 1 spark plug. The notch on the crankshaft drive pulley (fig. 182) should now coincide with the pointer on the timing gear cover. Place indicator at distributor clamp arm at zero (fig. 183). Place distributor rotor in position for No. 1 spark plug. Insert distributor into the tachometer drive housing from the upper end, meshing the tongue at the end of the distributor shaft with the groove in the clutch of the drive shaft of the tachometer housing.

2. Rotate the distributor body into position so that breaker contacts are just opening. This step can be performed most accurately

ELECTRICAL SYSTEM

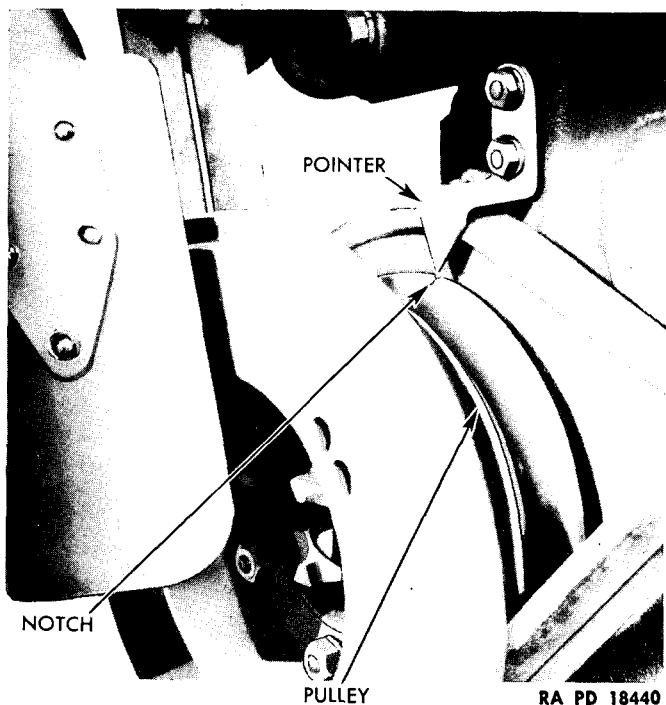

Figure 182 — Timing Notch and Pointer

by connecting a small lamp across the contacts. The lamp will light up the instant the contacts begin to separate. Tighten the clamp arm bolt. The ignition should now be correct. If not, loosen the clamp arm bolt and rotate the housing to advance or retard as required and again tighten clamp arm bolt.

(f) *Tighten Distributor Clamp Arm Bolt.*

(g) *Connect High-tension Wires in Distributor Cap in Firing Order 1-5-3-6-2-4.*

(h) *Check Ignition Timing.*

With indicator at clamp arm at zero, and with No. 1 piston at top dead center and timing notch on crankshaft drive pulley indexing with pointer, No. 1 spark plug should just begin to fire. If adjustment is not correct, adjust as outlined in substep (e) above. **NOTE:** An advance and retard dial and pointer are located below the distributor. Their purpose is to provide easy adjustment of timing in accordance with the octane rating of the fuel being used. Adjustment is accomplished by loosening the retaining bolt with a $\frac{7}{16}$ -inch wrench and rotating the distributor and clamp bracket toward advance or retard as desired. Retighten retaining bolt.

BASIC HALF-TRACK VEHICLES (IHC) (PERSONNEL CARRIER M5, CAR M9A1, MULTIPLE GUN MOTOR CARRIAGE M14. AND SIMILAR IHC VEHICLES)

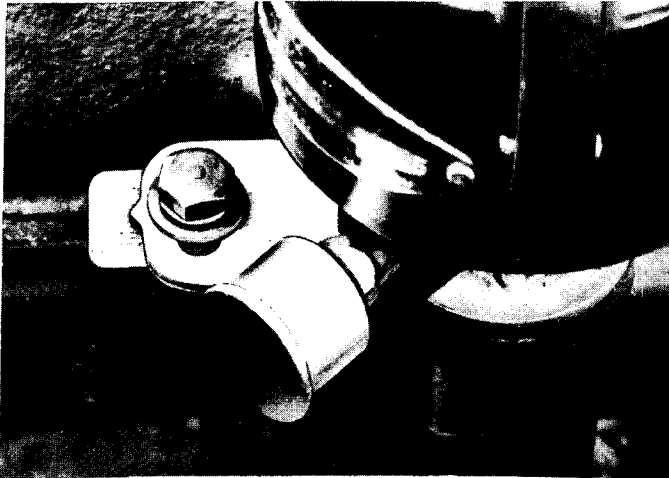

RA PD 18441

Figure 183 – Advance and Retard Indicator Plate .

92. SPARK PLUGS (figs. 184 and 185).

a. The spark at the electrodes of each spark plug must be full strength at all engine speeds and under all conditions of operation.

(1) **SERVICING.** Spark plug gaps should be checked carefully with a round wire gap gage every 5,000 miles. Plugs should be checked in a tester every 4,000 miles, cleaned if necessary, and regapped with a round wire gage to from 0.028 to 0.032 inch.

(2) **SPARK PLUG REPLACEMENT.** Gaps are burned open by the constant application of spark, heat, pressure, and chemical action of the fuel mixture. Electrodes become oxidized and corroded, causing increased resistance to the passage of current. The firing end of the core becomes crusted with carbon and other deposits, resulting in missing because of current loss over and through these deposits. Plugs develop a gas leakage between the core and shell or between the center electrode and core. Experience indicates that by reason of the above, spark plugs literally wear out and should be replaced after 10,000 miles.

93. RADIO NOISE SUPPRESSION.

a. **Description.** When the engine of any motor vehicle is running, the electrical system of that vehicle is a source of radio interference. It actually broadcasts radio waves or signals that will interfere with any receiving apparatus that may be operating in the vehicle or in its vicinity. This interference also would enable the enemy to determine the exact

ELECTRICAL SYSTEM

location of the vehicle through the use of detecting instruments. In view of the foregoing, this vehicle has been suppressed to eliminate radiated disturbances at their sources. Radio noise suppression on this vehicle is accomplished through filters, condensers, resistor-suppressors, and bonds.

(1) **FILTERS.**

(a) *Description.* A filter is an assembly consisting of a winding and one or more condensers connected internally in a metal case and mounted at the desired location in such a manner that the case is well grounded to the vehicle.

(2) **RESISTOR SUPPRESSORS.**

(a) *Description.* A resistor suppressor is a high-resistance unit or element mounted securely in an insulated housing having electrical connections in both ends and so constructed as to have electrical contacts at each end.

(3) **BONDS.**

(a) *Description.* A bond is an electrical contact, of extremely low resistance, between two or more metal parts. Flexible braided metal bonding straps are used for bonding on this vehicle.

(4) **WASHER "PILE-UP".**

(a) *Description.* Special shakeproof lock washers are used in varied numbers at the points of bonding and they are securely fastened by bolts and nuts. **NOTE:** When disconnecting, replacing, or servicing bonds, the washer "pile-up" must be installed exactly as installed by the manufacturer.

b. Points of Noise Suppression.

(1) **FILTERS.** Filters on this vehicle are as follows:

(a) *Filter #FL-12, Capacity 30-volt, 55-ampere.* Mounted on the generator.

(b) *Filter #FL-14, Capacity 30-volt, 10-ampere.* Mounted at dash in ignition switch to coil circuit. **NOTE:** Do not interchange with item (c).

(c) *Filter #FL-12, Capacity 30-volt, 55-ampere.* Connected to generator regulator at armature terminal. **NOTE:** Do not interchange with item (b).

(d) *Filter #FL-13, Capacity 30-volt, 10-ampere.* Connected to generator regulator at field terminal.

(e) *Filter #FL-12-S, Capacity 30-volt, 55-ampere.* Connected to generator regulator at battery terminal.

BASIC HALF-TRACK VEHICLES (IHC) (PERSONNEL CARRIER M5, CAR M9A1, MULTIPLE GUN MOTOR CARRIAGE M14, AND SIMILAR IHC VEHICLES)

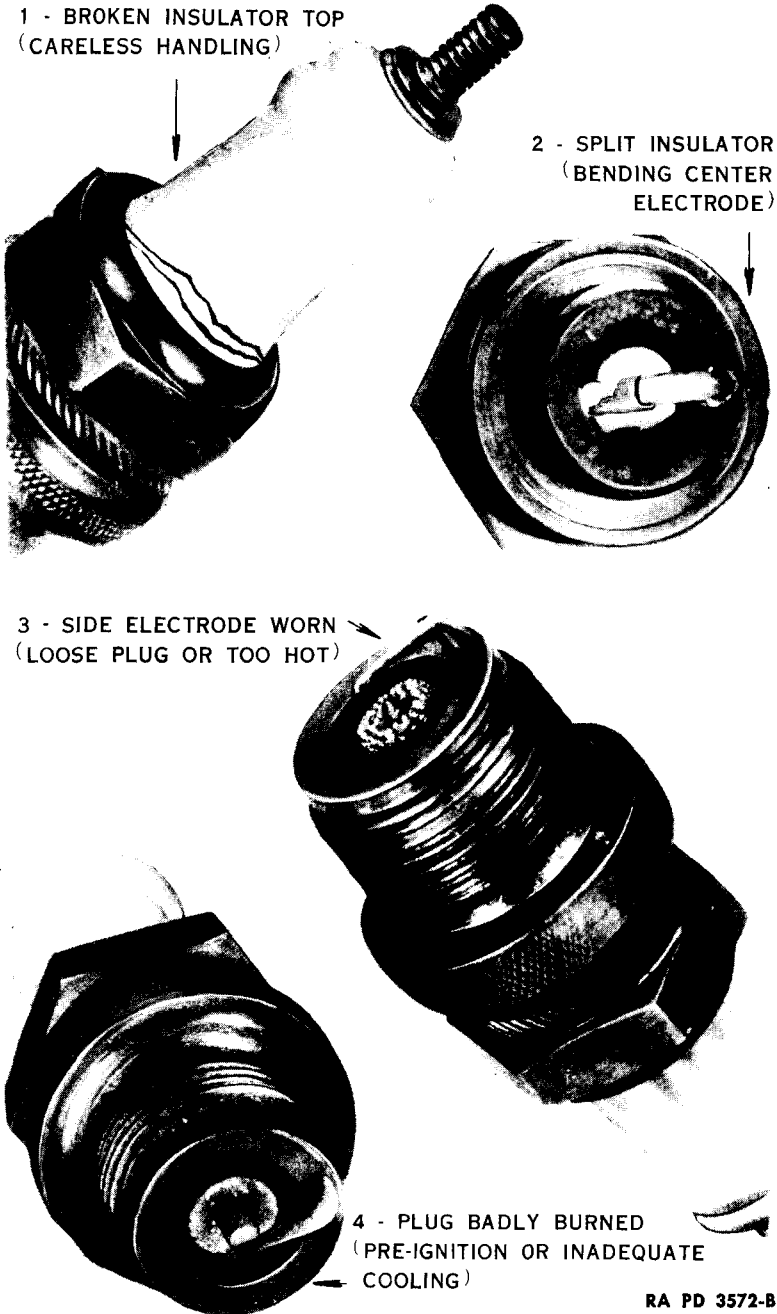

Figure 184 — Spark Plug Applications and Operating Conditions

ELECTRICAL SYSTEM

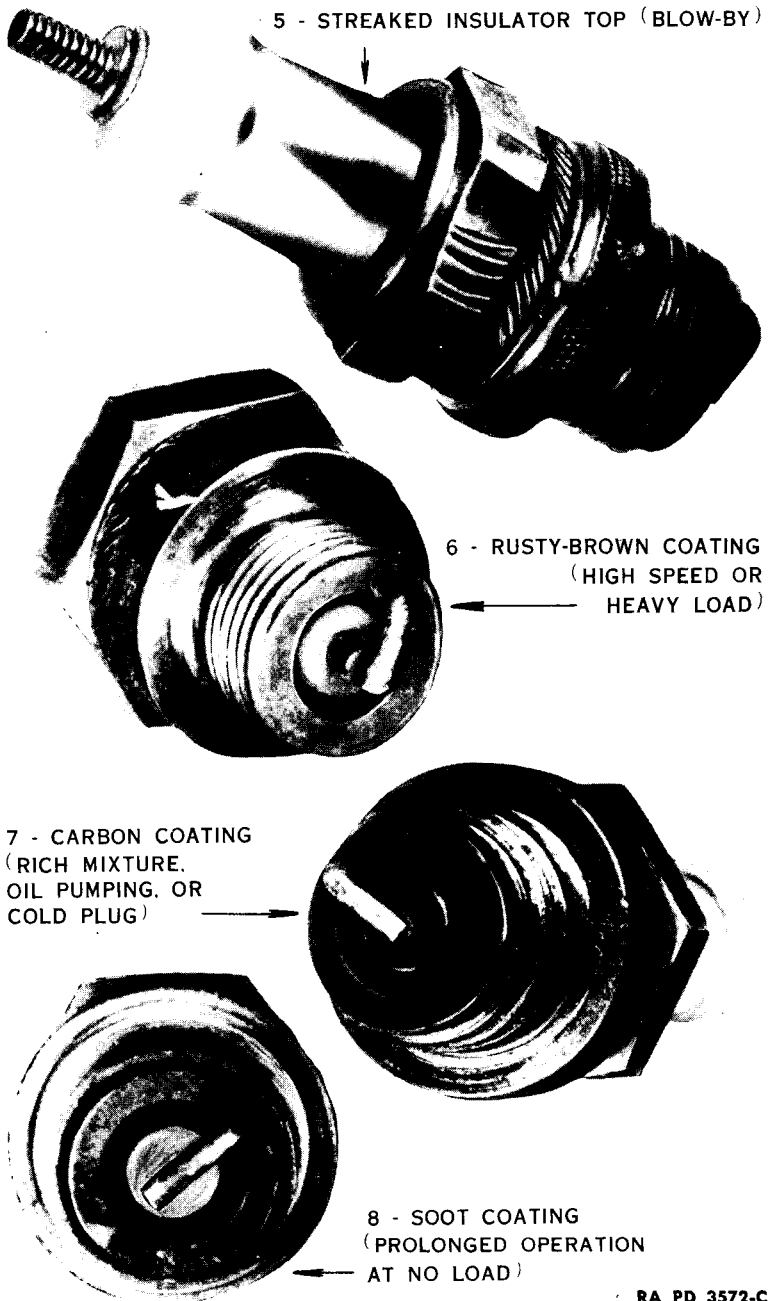

Figure 185 — Spark Plug Applications and Operating Conditions

BASIC HALF-TRACK VEHICLES (IHC) (PERSONNEL CARRIER M5, CAR M9A1, MULTIPLE GUN MOTOR CARRIAGE M14, AND SIMILAR IHC VEHICLES)

(2) **RESISTOR SUPPRESSORS.** Resistor suppressors on this vehicle are as follows:

(a) *Spark Plug Suppressors.* Each spark plug suppressor has a capacity of 10,000 ohms resistance. When disconnecting spark plug cables at plugs do so with a twisting motion, not by direct pull.

(b) *High-tension Cable from Coil at Distributor.* This suppressor has a capacity of 10,000 ohms resistance.

(3) **BONDS.** Points of bonding on this vehicle are as follows:

(a) *Front end of hood top panel to stud on radiator core.* (Two washers at radiator and four washers at hood panel.)

(b) *Radiator Core to Frame Side Rail, Each Side of Vehicle.*

1. Two washers at each radiator point and three washers at each frame side rail.

(c) *Steering Gear Column to Frame Side Rail.*

1. Three washers at steering column and three washers at frame side rail.

(d) *Hood Side Armor, Upper, to Hood Side Armor, Lower, Each Side of Vehicle.*

1. Contact spring type bond. Three lock washers at each bonding point.

(e) *Hood Top Panel to Hood Side Panel, Each Side of Vehicle.*

1. Three washers at top panel and three washers at side panel.

(f) *Hood Center Panel to Hood Top Panel, Each Side of Vehicle.*

1. Three washers at top panel and three washers at center panel, each bonding point.

(g) *Engine to Dash at Ignition Coil.*

1. Two washers at coil and three washers at dash.

(h) *Speedometer Cable to Dash.*

1. Two washers at speedometer cable clip and four washers at dash and instrument panel ground wire.

(i) *Tachometer Cable to Dash.*

1. Three washers at dash and two washers at tachometer cable clip holding choke and throttle control conduits.

(j) *Lock Washer Bonding at Hood Side Armor to Side-Armor-to-Frame Brace, Each Side of Vehicle.*

1. Three washers holding spring clip (substep (d)).

ELECTRICAL SYSTEM

(k) *Lock Washer Bonding at Hood Side Armor Brace to Frame Side Rail, Each Side of Vehicle.*

1. Three lock washers at each bonding point.

(l) *Hood Center Panel to Dash at Center Panel Ledge.*

1. Three lock washers required at the center panel bonding point.

(m) *Windshield Wiper Tube to Dash.*

1. Three lock washers at tube and three at compression tee at dash.

c. Maintenance.

(1) Periodic check of the radio noise suppression system is essential. Any worn, broken, or defective items of the suppression system must be replaced. If the vehicle is causing interference to radio equipment located in the vehicle or in adjacent vehicles, it is certain that the suppression system is not functioning properly and a thorough and systematic check of the vehicle must be made. *The engine must be in proper condition of tune-up.* Successful radio noise suppression demands that the engine electrical system be in proper condition, for the following deficiencies vitally affect the radio noise suppression system:

(a) Faulty distributor cap.

(b) Faulty spark plugs or improper gaps.

(c) Faulty or improperly spaced distributor breaker points.

(d) Defective wiring.

(e) Loose electrical connections.

(f) Poor battery connections.

(2) Electrical contacts, wherever possible, must be of low resistance. Such a contact would be a welded connection. This type connection is not always possible or even desirable. The best alternative must therefore be chosen.

d. Trouble Shooting.

(1) RESISTOR SUPPRESSORS.

(a) Remove resistor suppressors one at a time and, with a clean cloth, thoroughly remove any dirt or moisture that may be present. Examine each resistor suppressor carefully and replace those found to be cracked or scorched. *They cannot be repaired.* When installing new resistor suppressors, or those found in good condition, be sure to form a good tight connection. NOTE: The best method of testing suspected resistor suppressors is by substituting each of the suppressors with a new one or one that is known to be good.

BASIC HALF-TRACK VEHICLES (IHC) (PERSONNEL CARRIER M5, CAR M9A1, MULTIPLE GUN MOTOR CARRIAGE M14, AND SIMILAR IHC VEHICLES)

(2) **FILTERS.** Check vehicle against circuit diagrams and against listing in subparagraph **b** above, and assure that all filters are designated both as to part numbers and as to location. This is important since filter units *look* alike but *differ* in their internal construction. When checking filter units, assure that terminal connections and wiring make good electrical contact. Mounting and grounding bolts should be drawn *very tight*. All mounting surfaces, tops, and bottoms, of all filters and their placement positions on the vehicle must be clean and free of paint or accumulated dirt.

(3) **BONDING.** Broken or frayed bonds should be replaced. When replacing bonds, assure that mounting surfaces must be thoroughly cleaned of paint, dirt, and corrosion. Replace all parts exactly as they were. Replace lock washers in their proper sequence. All bonds must be absolutely tight. All prepared or tinned spots must be *carefully* cleaned. Vigorous sanding will remove the tinning from the surface and rust and corrosion will result.

94. TIMING.

a. Procedure. Correct ignition timing is of utmost importance in proper engine performance. In consequence, the ignition distributor should not be disturbed until it is positively known to be inoperative or out of adjustment.

b. Checking. If a neon timing light is available a final check should be made as follows:

(1) With a piece of chalk, mark the timing notch on the crankshaft drive pulley (fig. 182).

(2) Remove the spark plug cable from the No. 1 spark plug and connect one lead of the light to the spark plug and the other lead to the spark plug cable.

(3) Start the engine and let it run at idling speed of approximately 350 revolutions per minute directing the light flash at the crankshaft drive pulley to check the position of the chalk-marked notch in relation to the pointer on the timing gear cover. The notch and the pointer should coincide at the time of the flash (stroboscopic effect). If they fail to do so, loosen the distributor advance arm clamp screw and advance or retard the unit as the case may be.

(4) If the chalk mark blurs or widens out, it is an indication of a worn distributor shaft, sticking governor weights, weak governor weight springs, improper breaker contact adjustment or excessive wear in the distributor drive gears. The difficulty should be investigated and reported to proper authority.

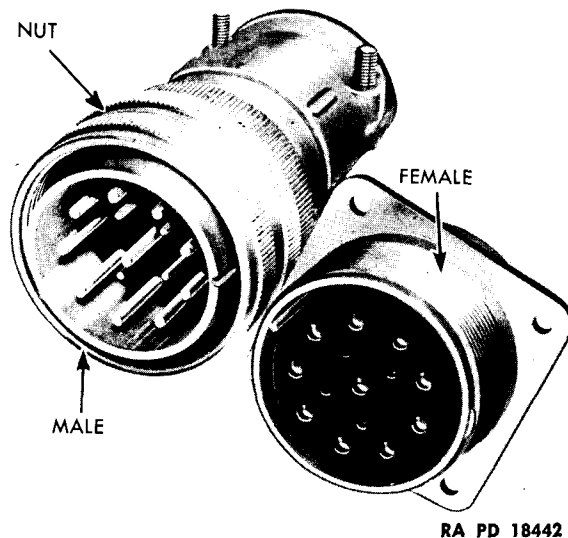
ELECTRICAL SYSTEM

RA PD 18442
Figure 186 – Amphenol Plug

95. CIRCUIT BREAKERS.

a. Ignition system on this vehicle is provided with automatic circuit breakers which are of the automatic reset type. These circuit breakers serve the same purpose and function as fuses. There are five of these circuit breakers, two 20-ampere, two 10-ampere, and one 5-ampere, all located on the instrument panel inside the case. **NOTE:** Moisture which may have collected in the trouble lamp sockets on the instrument panel might cause trouble in the circuit breakers.

(1) To overcome this difficulty, press a cork into the receptacle when not in use.

(2) Corks may be procured locally.

96. SWITCHES.

a. All switches with the exception of the stop light switch are mounted on the instrument panel, and access to them for service requires removal of the instrument panel from its case. Description of all switches and replacement instructions are covered in paragraph 132.

97. AMPHENOL PLUGS (figs. 165 to 170, and 189).

a. **Description.** Amphenol plugs are used on this vehicle. Their purpose is to provide a quick and sure means of corrosion-free wiring connection. All four major wiring harnesses are equipped with these plugs. Reference to the wiring harness diagrams will indicate their position

**BASIC HALF-TRACK VEHICLES (IHC) (PERSONNEL CARRIER M5, CAR M9A1,
MULTIPLE GUN MOTOR CARRIAGE M14, AND SIMILAR IHC VEHICLES)**

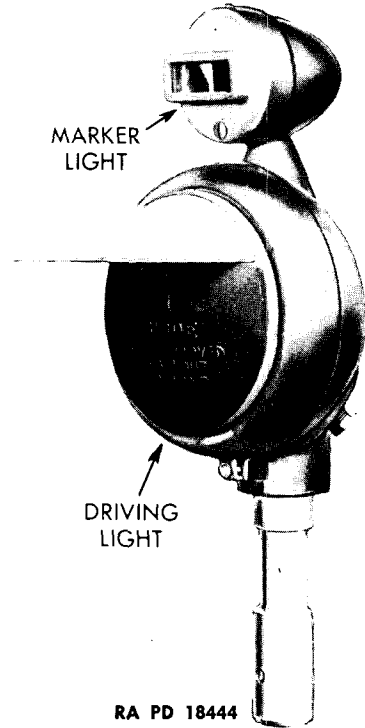
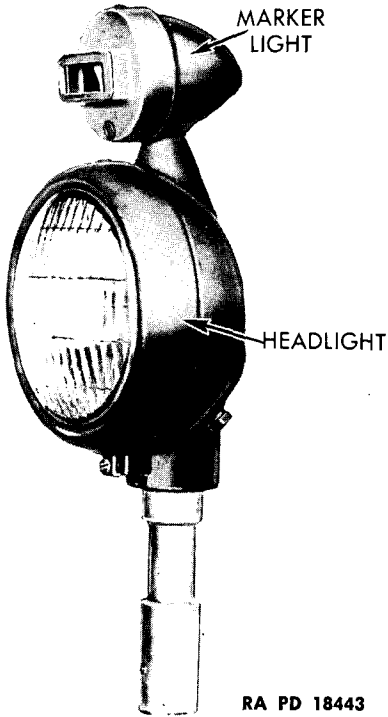

Figure 187 – Service Headlight and Marker Light **Figure 188 – Blackout Driving Light and Marker Light**

at point of connection in the instrument panel. “UPPER LEFT” and “LOWER RIGHT” refer to the lower pair of amphenol plugs. The term “INNER” refers to the portion of the harness inside the instrument panel case. “OUTER” refers to the portion of the harness on the engine compartment side.

b. Servicing. Disconnecting amphenol plugs is accomplished by unscrewing the retainer collar and pulling the male portion (on “outside” portion of harness) from the panel receptacle portion much as a radio tube would be removed from a socket. When *connecting* amphenol plugs, exercise care that the small lug in the male end (outer portion of harness) indexes with the slot in the female portion. This will assure proper connection of the wires.

98. TERMINAL BOX.

a. Description. A radio terminal box is mounted on the floor inside of both the right and left seat compartments. The purpose of the terminal box is to provide convenient take-off terminals for the radio.

ELECTRICAL SYSTEM



LOCATING PLUNGER

RA PD 18445

Figure 189 – Headlight – Installed

99. HEADLIGHTS AND MARKER LIGHTS.

a. Description. Two sealed beam headlights with superimposed blackout marker lights are used on this vehicle. Both assemblies are demountable as an assembly. Installation of a blackout driving light and superimposed blackout marker light assembly can only be made on the left-hand side. The sealed beam headlight assemblies (fig. 187) are operated from the 12-volt circuit while the blackout driving light (fig 188) is a 6-volt assembly. This is accomplished by passing the current through a dash mounted resistance coil. The blackout driving light contacts differ from those of the regular headlight assembly.

b. Headlight Removal (fig. 189). Headlight assemblies are removed from their fender mounting bracket by screwing out the plunger which is

BASIC HALF-TRACK VEHICLES (IHC) (PERSONNEL CARRIER M5, CAR M9A1, MULTIPLE GUN MOTOR CARRIAGE M14, AND SIMILAR IHC VEHICLES)

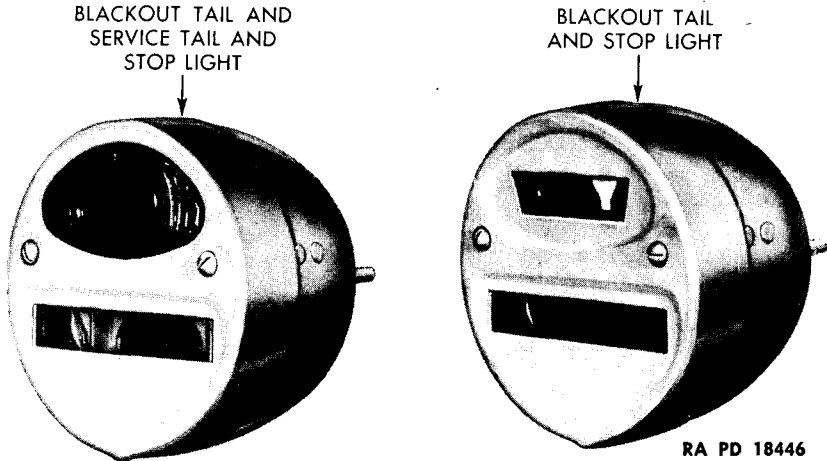

Figure 190 – Stop and Taillights

mounted in the mounting bracket to release the locating pin from the light mounting shaft. Raise light assembly from mounting bracket. Installation is accomplished by pushing light assembly to bottom of socket while locating pin is out. Screw locating plunger in to connect pin and hole in light shaft.

c. Headlight Bracket Plug. A special chain-mounted headlight bracket plug is attached to the headlight bracket. It is used to close the headlight bracket opening when the lights are not in position.

d. Maintenance.

(1) **HEADLIGHTS.** The optical portion of this light is of sealed beam type requiring replacement of lens, reflector, and bulb assembly in case of failure of any part. Removal is accomplished by removing the lower retaining screw from the rim, and removing the rim, which will permit the sealed unit to come out of the body. Disconnect the wires at the connectors and remove assembly. Install new sealed beam unit and connect wires at the connectors; install rim and screw.

(2) **BLACKOUT DRIVING LIGHT.** The optical portion of this light is of sealed beam type and is covered by a shield and hood assembly. Replacement of lens, reflector, and bulb is required in case of failure of any one part. Removal of sealed beam unit is accomplished by removing the retaining screw at the base of the retainer rim and removing the rim. This will permit sealed unit with shield and hood to come out of the light body. Disconnect wires at connectors and remove unit. Shield

ELECTRICAL SYSTEM

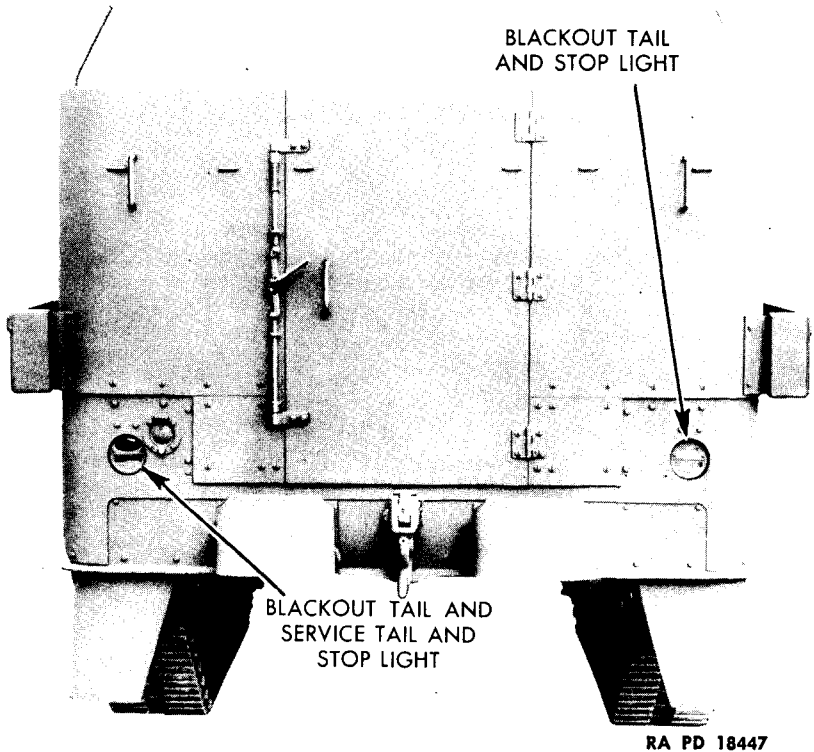

Figure 191 – Taillights – Installed

and hood are integral with the optical portion of the light and must be replaced at the same time. Install sealed beam unit with shield and hood in light body. Connect wires at connectors. Install rim and retainer screw.

(3) **BLACKOUT MARKER LIGHTS.** The lens and lens retainer are held in place by a retainer screw at the lower part of the marker light body. Remove retaining screw and remove lens retainer. The lamp is a Mazda 1247, and replacement is accomplished in the conventional manner.

e. Adjustment.

(1) **HEADLIGHT AND BLACKOUT DRIVING LIGHT.** Adjustment of the headlights for beam projection is accomplished through the shifting of the headlight body in its supporting bracket. Loosen three brackets to light body screws. Shift light body as required for desired beam projection and tighten mounting screws. Adjustment is provided for from four degrees below the horizontal center line of the light to two degrees above the horizontal center line.

**BASIC HALF-TRACK VEHICLES (IHC) (PERSONNEL CARRIER M5, CAR M9A1,
MULTIPLE GUN MOTOR CARRIAGE M14, AND SIMILAR IHC VEHICLES)**



RA PD 18281

Figure 192 — Horns — Installed

100. TAILLIGHTS (figs. 190 and 191).

a. Description. The two taillights are of different types, both containing sealed lamp and lens assemblies.

(1) **LEFT TAILLIGHT.** This light is a combination blackout taillight (upper element) and a service taillight and stop light (lower element), and is mounted at the left rear of the vehicle.

(2) **RIGHT TAILLIGHT.** This light is a combination blackout taillight (upper element) and a blackout stop light (lower element) and is mounted at the right rear of the vehicle.

ELECTRICAL SYSTEM

b. **Maintenance.** Should failure occur in either of the separate sealed units they may be replaced by removing the two retainer screws and removing the retainer cover. Disconnect the wiring at the rear of the unit being replaced and replace unit. Install the wiring at the rear of unit. Install retainer cover and two screws.

101. ELECTRIC BRAKE CONTROL (fig. 244).

a. **Description.** Movement of the dial brake control knob on the instrument panel varies the braking effort of the electric trailer brakes by varying the current in the system to compensate for changing loads and conditions. Brake lining wear of the vehicle will necessitate an adjustment of the trailer braking effort. Increase on the trailer is obtained when the dial knob is turned to "HEAVY" and this position is required for the maximum trailer load. Approximately one-half the effect is obtained when the dial knob is turned to "LIGHT." Adjust for operation between these ranges.

b. **Brake Control Replacement.** For removal and installation instructions see paragraph 132. Replacement requires removal of instrument panel from case.

102. HORNS.

a. **Description.** Dual type (high and low note) vibrator horns are provided and mounted on the engine side of the dash below the air cleaner. A horn relay is also installed above the horn mounting. The center terminal is for the battery connection, the "S" terminal is for the button connection, and the "H" terminal is for the horn connections.

**BASIC HALF-TRACK VEHICLES (IHC) (PERSONNEL CARRIER M5, CAR M9A1,
MULTIPLE GUN MOTOR CARRIAGE M14, AND SIMILAR IHC VEHICLES)**

Section XVII

ENGINE

	Paragraph
Description	103
Tabulated data	104
Accessories	105
Trouble shooting	106
Cylinder head replacement.....	107
Timing marks	108
Manifold replacement	109
Oil pump	110
Valves	111
Valve replacement	112
Cleaning carbon	113
Tune-up	114
Oil pan replacement.....	115
Crankcase ventilator	116
Oil cooler	117
Engine replacement	118

103. DESCRIPTION (figs. 193 and 194).

a. **Description.** The gasoline engine in this vehicle is 4-cycle, 6-cylinder-in-line, overhead-valve type. The engine serial number is stamped on a pad at the left front side just below the cylinder head. Cylinders are numbered from front to rear, as viewed from the front end, engine crankshaft rotation is clockwise. The weight of the engine assembly with accessories is 1,250 pounds.

104. TABULATED DATA.

Model	International Red-450-B
Firing order	1-5-3-6-2-4
Brake horsepower (max. at 2,600 rpm).....	143
Weight with accessories.....	1,250 lb
Crankcase oil capacity.....	10½ qt
Crankcase oil (refill).....	9 qt
Oil filling location	Left front side

ENGINE

Oil level bayonet gage.....	Left side center
Oil draining location	Bottom rear of pan
Oil pressure	
Min. at 200 to 300 rpm.....	10 to 15
Max. at 1,500 to 1,800 rpm.....	40 to 45
Oil pressure regulation	Oil filter base
Cooling system capacity	31 qt
Cooling system drains	
Engine block	Right side rear
Oil cooler	At oil pan rear
Radiator	At lower right corner

105. ACCESSORIES.

a. Cooling System.

- (1) FAN BLADES. "Service Products" Model 4775-DX.
- (2) FAN BELTS. Two used.
- (3) THERMOSTAT. Engine serial numbers below 3635. "Dole" 145 degrees to 150 degrees.
- (4) THERMOSTAT. Engine serial numbers 3635 and later. "Dole" 170 degrees to 175 degrees.

b. Electrical System.

- (1) STARTER. "Delco-Remy" Model 000790, gear reduction type with Bendix drive.
- (2) GENERATOR. "Delco-Remy" Model 1117308, belt driven, shunt type.
- (3) IGNITION COIL. "Delco-Remy" Model 1115079, oil immersed type.
- (4) DISTRIBUTOR. "Delco-Remy" Model 1110161, full automatic type.
- (5) SPARK PLUGS. "Champion" Model J-10 Com.

c. Fuel System.

- (1) FUEL PUMP. "AC" Model GR-11558, Type AJ, combination vacuum type.
- (2) FUEL FILTER. "Zenith" Model F349X3.
- (3) CARBURETOR. "Zenith" Model 63-AW-14R, updraft.

BASIC HALF-TRACK VEHICLES (IHC) (PERSONNEL CARRIER M5, CAR M9A1, MULTIPLE GUN MOTOR CARRIAGE M14, AND SIMILAR IHC VEHICLES)

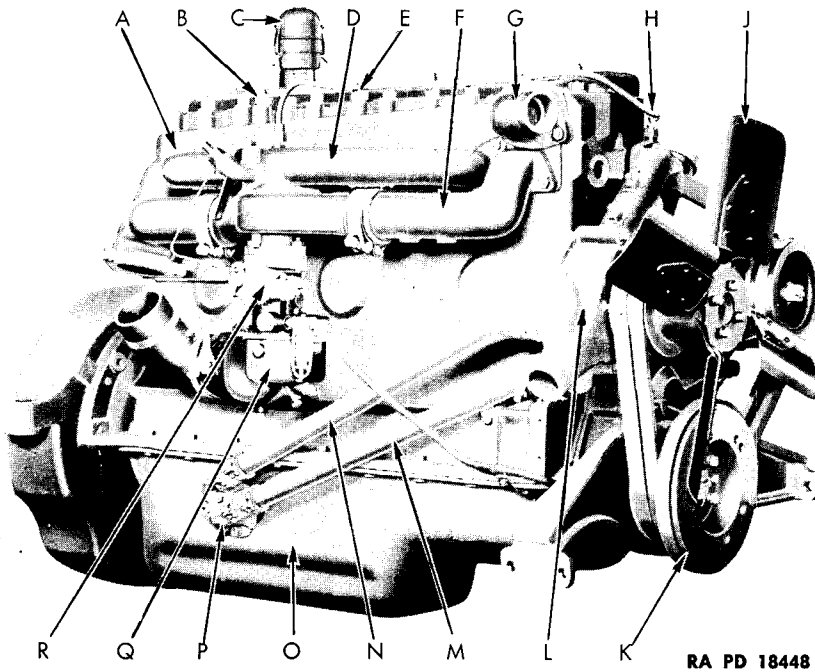

RA PD 18448

- A—CYLINDER HEAD
- B—ENGINE TEMPERATURE WARNING UNIT
- C—CYLINDER HEAD BREATHER
- D—INTAKE MANIFOLD
- E—ENGINE TEMPERATURE SENDING UNIT
- F—EXHAUST MANIFOLD
- G—THERMOSTAT HOUSING
- H—CRANKCASE BREATHER
- J—FAN ASSEMBLY

- K—VIBRATION DAMPER
- L—WATER PUMP
- M—OIL COOLER OUTLET
- N—OIL COOLER INLET
- O—OIL PAN
- P—OIL COOLER MANIFOLD
- Q—CARBURETOR
- R—GOVERNOR

RA PD 18448-B

Figure 193 — Engine and Accessories — Right Side

ENGINE

- A—CRANKCASE VENTILATOR
- B—OIL FILLER CAP
- C—VALVE ROCKER-ARM COVER
- D—DISTRIBUTOR
- E—CYLINDER BREATHER
- F—IGNITION COIL
- G—FUEL PUMP
- H—STARTING MOTOR
- J—OIL PAN
- K—OIL FILTERS
- L—OIL LEVEL GAGE
- M—GENERATOR
- N—WATER PUMP
- O—FAN

RA PD 18449

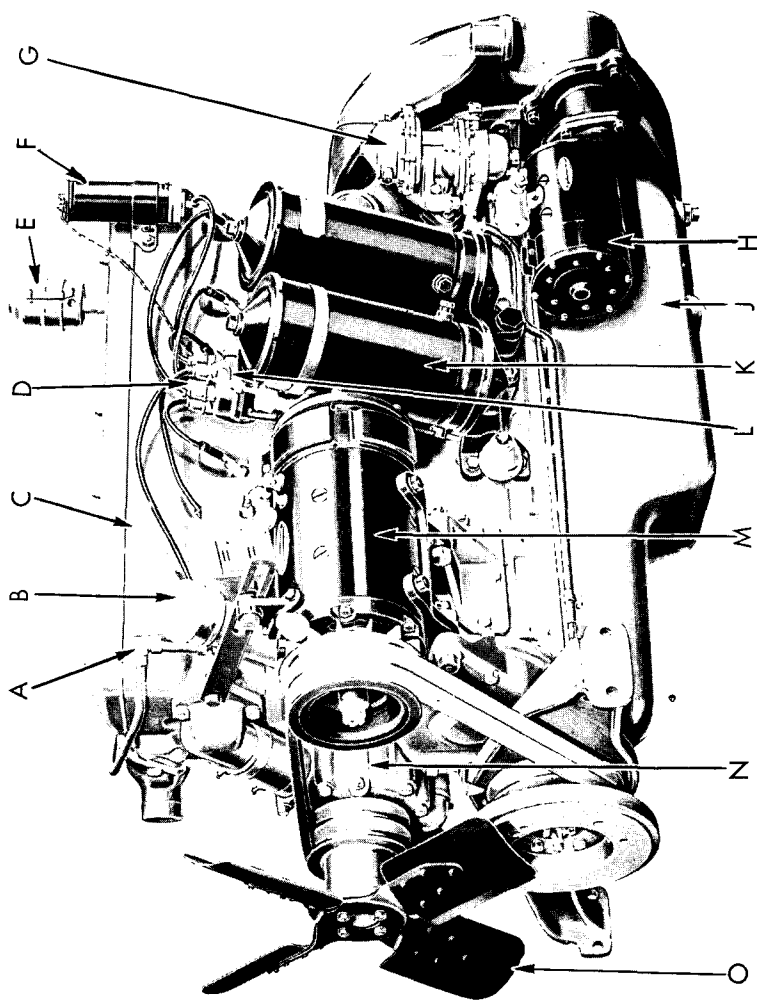

Figure 194 — Engine and Accessories — Left Side

BASIC HALF-TRACK VEHICLES (IHC) (PERSONNEL CARRIER M5, CAR M9A1, MULTIPLE GUN MOTOR CARRIAGE M14, AND SIMILAR IHC VEHICLES)

(4) **AIR CLEANER.** "Donaldson" Model 9241, oil bath type.

d. Lubricating System.

(1) **OIL COOLER.** "Modine."

(2) **OIL FILTER.** "Michiana," dual cartridge type.

e. Clutch.

(1) **MODEL "Rockford" 14TT,** single plate.

(2) **DRIVEN MEMBER FACINGS.** US-969-XR-#1.

f. Cylinder Head Ventilator. "Donaldson" Model 2XC-277.

g. Crankcase Ventilator Valve. "Donaldson" Model V4-16.

106. TROUBLE SHOOTING.

a. In order to locate and correct a malfunction or fault in an engine, operating personnel should understand the fundamental principles of engine operation, recognize and identify fundamental trouble symptoms, and be prepared to follow a systematic procedure of diagnosis to eliminate the tedious guesswork of a hit-or-miss search for the difficulty. The essential factors necessary for an engine to operate include: cranking; fuel and air; compression; ignition; exhaust; proper lubrication and cooling; and correct adjustments. Symptoms within the scope of this publication concern some of the following:

(1) **LACK OF POWER.**

Possible Cause	Possible Remedy
Ignition system defective.	Refer to section XVI.
Carburetor not functioning properly.	Replace unit (par. 130).
Fuel pump not functioning properly.	Replace unit (par. 128).
Fuel filter dirty.	Clean filter (par. 129).
Air cleaner dirty.	Service air cleaner (par. 131).
Engine overheating.	Refer to paragraph 75.
Engine too cold.	Check or replace thermostat (par. 80).
Improper engine tune-up.	Tune up engine (par. 114).
Improper valve clearance.	Adjust valves (par. 111).
Air leaks in vacuum lines.	Check and tighten connections.
Air leaks at manifold.	Replace manifold gaskets (par. 109).

ENGINE

(2) **OVERHEATING.**

Possible Cause	Possible Remedy
Cooling system defective.	Refer to paragraph 75.
Ignition timing faulty.	Correct timing (par. 94).
Thermostat defective.	Replace thermostat (par. 80).
Insufficient cooling medium in system.	Refill cooling system.
Cooling system frozen.	Thaw out system (par. 83).
Clogged cooling system.	Clean system (par. 83).
Loose or defective fan belts.	Adjust or replace belts (par. 79).
Defective water pump.	Replace water pump (par. 78).

(3) **EXCESSIVE OIL CONSUMPTION.**

Improper grade of oil.	Drain and refill with proper grade for season or temperature (sec. V).
Oil level too high.	Keep oil to "FULL" mark on bayonet oil level gage.
Oil leaks at gaskets and seals.	Replace faulty gaskets.
Broken vacuum pump diaphragm.	Replace fuel pump (par. 128).

(4) **LOW OIL PRESSURE.**

Improper grade of oil.	Drain and refill with proper grade (sec. V).
Lack of oil.	Check level and fill to "FULL" on gage.
Defective oil pump.	Replace oil pump (par. 110).
Clogged oil screen of oil pump.	Clean oil screen (par. 110).
Defective oil gage dash unit.	Replace instrument (par. 132).

(5) **POPPING, SPITTING, AND SPARK KNOCK.**

Ignition timing faulty.	Check and correct ignition timing (par. 94).
Excessive carbon deposits.	Clean carbon (par. 113).
Carburetor dirty or faulty.	Replace carburetor (par. 130).

(6) **LOUD KNOCK.**

Broken valve.	Replace valve (par. 112).
Connecting rod bearing fracture.	Report to ordnance personnel.
Broken piston.	Report to ordnance personnel.

(7) **DULL, HEAVY THUMP.**

Crankshaft main bearing failure.	Report to ordnance personnel.
----------------------------------	-------------------------------

BASIC HALF-TRACK VEHICLES (IHC) (PERSONNEL CARRIER M5, CAR M9A1, MULTIPLE GUN MOTOR CARRIAGE M14, AND SIMILAR IHC VEHICLES)

(8) LIGHT RATTLING NOISE.

Possible Cause

Possible Remedy

Lack of engine oil.

Stop engine immediately. Investigate loss of oil. Refill crankcase with oil. Correct or report source of oil leak.

(9) LIGHT CLICKING NOISE.

Sticking valves.

Replace valves (par. 112).

Broken valve springs.

Replace valve springs (par. 112).

Faulty valve adjustment.

Adjust valve clearances (par. 111).

(10) HARD STARTING.

Ignition timing faulty.

Correct timing (par. 94).

Weak or discharged battery.

Install fully charged battery (par. 86).

Poor battery ground connection.

Clean and tighten connection.

Defective distributor.

Replace distributor (par. 91).

Choke not opening fully.

Correct choke linkage.

Faulty spark plugs.

Clean, regap, or replace spark plugs (par. 92).

Defective coil.

Replace coil (par. 90).

Defective condenser.

Replace condenser (par. 91).

(11) ENGINE WILL NOT IDLE.

Improper carburetor idle adjustment.

Adjust idle adjustment (par. 130).

Faulty spark plugs.

Clean, regap, or replace spark plugs (par. 92).

Improper valve clearance adjustment.

Adjust valve clearance (par. 111).

Faulty ignition timing.

Check and correct ignition timing (par. 94).

107. CYLINDER HEAD REPLACEMENT.

a. Equipment.

EXTENSION, socket wrench

SCREWDRIVER

GAGE, feeler

WRENCH, box, 1/2-in.

HANDLE, socket wrench

WRENCH, end, 3/8-in.

PLIERS

WRENCH, end, 1/2-in.

ENGINE

WRENCH, end, $\frac{9}{16}$ -in.

WRENCH, end, $\frac{5}{8}$ -in.

WRENCH, end, $\frac{3}{4}$ -in.

WRENCH, socket, $\frac{9}{16}$ -in.

WRENCH, socket, $\frac{3}{4}$ -in.

WRENCH, spark plug

b. Procedure.

(1) REMOVE HOOD

SCREWDRIVER

WRENCH, end, $\frac{9}{16}$ -in.

Remove two slotted screws at both front and rear end of hood top panel. Front cap screw holds the radio bonding strap to the radiator. Remove hood.

(2) DRAIN COOLING SYSTEM.

Open drain cock at lower right of radiator.

(3) DISCONNECT CRANKCASE BREATHER LINE.

WRENCH, end, $\frac{5}{8}$ -in.

Disconnect crankcase breather vacuum line at oil filler pipe.

(4) DISCONNECT GENERATOR ADJUSTING STRAP.

WRENCH, end, $\frac{5}{8}$ -in.

Remove bolt and nut at generator adjusting strap at water pump.

(5) REMOVE SPARK PLUGS.

WRENCH, spark plug

Disconnect spark plug high-tension cables using a twisting motion rather than a direct pull to free springs from terminals. Remove spark plugs.

(6) REMOVE COIL.

WRENCH, end, $\frac{1}{2}$ -in.

Remove two cap screws and special lock washer from coil mounting bracket at cylinder head. Remove coil.

(7) DISCONNECT WATER PUMP AT HEAD.

WRENCH, end, $\frac{5}{8}$ -in.

Remove two cap screws and washers holding water pump to cylinder head.

(8) DISCONNECT ENGINE WATER OUTLET (UPPER) TO RADIATOR.

WRENCH, end, $\frac{5}{8}$ -in.

Remove two cap screws and washers holding water outlet to cylinder head.

(9) DISCONNECT CRANKCASE BREATHER VACUUM LINE AT MANIFOLD.

WRENCH, end, $\frac{5}{8}$ -in.

BASIC HALF-TRACK VEHICLES (IHC) (PERSONNEL CARRIER M5, CAR M9A1, MULTIPLE GUN MOTOR CARRIAGE M14, AND SIMILAR IHC VEHICLES)

Disconnect breather vacuum line at manifold.

- (10) **DISCONNECT VACUUM LINE TO FUEL AND VACUUM PUMP.**
WRENCH, end, $\frac{3}{8}$ -in.

Disconnect vacuum line to fuel pump at manifold.

- (11) **DISCONNECT VACUUM LINE TO BRAKE CHECK VALVE.**
SCREWDRIVER

Disconnect vacuum line to check valve at manifold.

- (12) **DISCONNECT AIR CLEANER ELBOW AT AIR CLEANER.**
WRENCH, end, $\frac{1}{2}$ -in.

Remove four cap screws and washers holding air cleaner elbow to air cleaner.

- (13) **DISCONNECT AIR CLEANER ELBOW AT CARBURETOR.**
SCREWDRIVER

Loosen screw clamp on air cleaner elbow at carburetor. Disconnect elbow.

- (14) **DISCONNECT THROTTLE CONTROL WIRE.**
SCREWDRIVER

Disconnect throttle control wire at carburetor by loosening clamp screw.

- (15) **DISCONNECT CHOKE CONTROL WIRE.**
SCREWDRIVER

Loosen screw in clamp holding choke control wire at carburetor. Disconnect choke control.

- (16) **DISCONNECT ACCELERATOR CONTROL AT CARBURETOR.**
PLIERS

Disconnect throttle lever pull-back spring from manifold extension. Remove cotter pin from accelerator control rod at carburetor. Disconnect rod.

- (17) **DISCONNECT GASOLINE LINE AT CARBURETOR.**
WRENCH, end, $\frac{1}{2}$ -in.

Disconnect fuel line at carburetor.

- (18) **REMOVE CARBURETOR.**
WRENCH, end, $\frac{5}{8}$ -in.

Remove two nuts and washers from carburetor mounting screws at manifold. Remove carburetor and insulator adapter.

- (19) **REMOVE MANIFOLD ASSEMBLY.**
EXTENSION, socket wrench **WRENCH**, socket, $\frac{9}{16}$ -in.
HANDLE, socket wrench

ENGINE

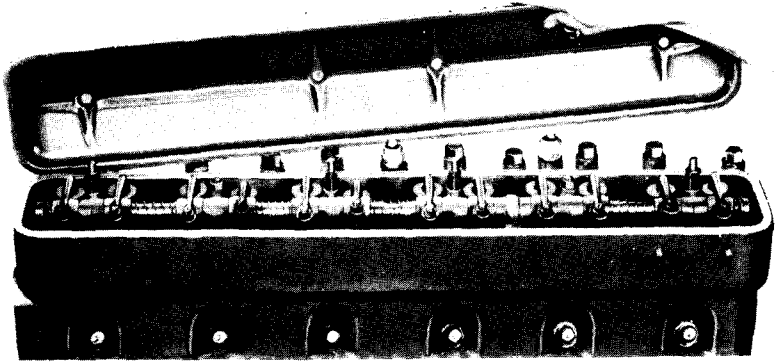

RA PD 18450

Figure 195 – Valve Rocker Arm Cover – Removal

Remove twelve nuts and washers from intake and exhaust manifold assembly. Remove manifold assembly and gaskets.

(20) REMOVE VALVE ROCKER ARM COVER (fig. 195).

WRENCH, end, $\frac{5}{8}$ -in.

Remove four special dome nuts from valve rocker arm cover. Remove cover and remove gasket.

(21) REMOVE VALVE ROCKER ARM COVER SUPPORTS (fig. 196).

WRENCH, end, $\frac{9}{16}$ -in.

Remove four square rocker arm cover support screws.

(22) REMOVE ROCKER ARM BRACKET CAP SCREWS (fig. 197).

HANDLE, socket wrench

WRENCH, socket, $\frac{3}{16}$ -in.

EXTENSION, socket wrench

Remove six rocker arm bracket cap screws holding brackets to cylinder head. Note that center bolt is drilled to provide oil feed to rocker arms (fig. 198).

(23) REMOVE VALVE ROCKER ARM ASSEMBLY IN TWO SECTIONS, FRONT HALF AND REAR HALF (fig. 199).

Remove pushrods (fig. 200).

(24) REMOVE CYLINDER HEAD CAP SCREWS (fig. 201).

EXTENSION, socket wrench

WRENCH, socket, $\frac{3}{4}$ -in.

HANDLE, socket wrench

Remove twenty-three cylinder-head-to-cylinder-block cap screws and washers.

(25) REMOVE CYLINDER HEAD AND GASKET (fig. 202).

BASIC HALF-TRACK VEHICLES (IHC) (PERSONNEL CARRIER M5, CAR M9A1, MULTIPLE GUN MOTOR CARRIAGE M14, AND SIMILAR IHC VEHICLES)

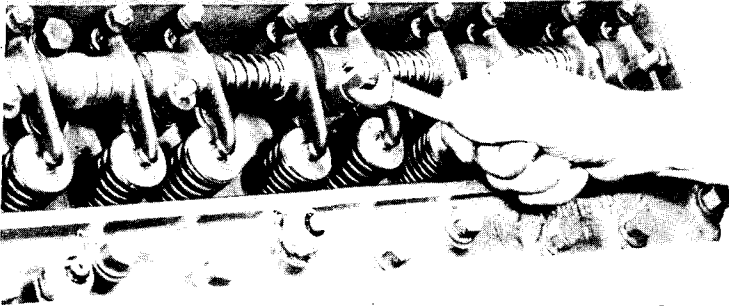

RA PD 18451

Figure 196 – Rocker Arm Cover Supports – Removal

- (26) INSTALL CYLINDER HEAD AND NEW GASKET.
- (27) INSTALL CYLINDER HEAD CAP SCREWS.

Install cylinder head cap screws, draw cap screws down alternately, a little at a time. Final tightening should be done with a tension wrench and drawn to 77 foot-pounds (Ammco reading 220).

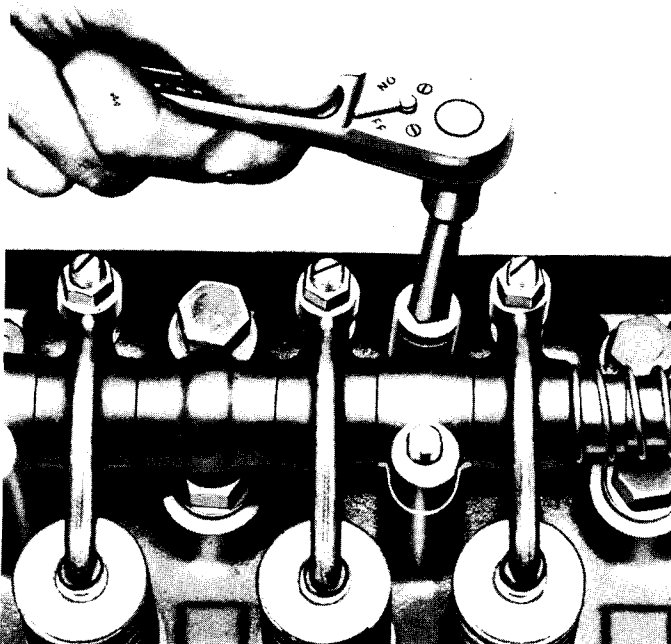

RA PD 18452

Figure 197 – Rocker Arm Bracket Cap Screws – Removal

ENGINE

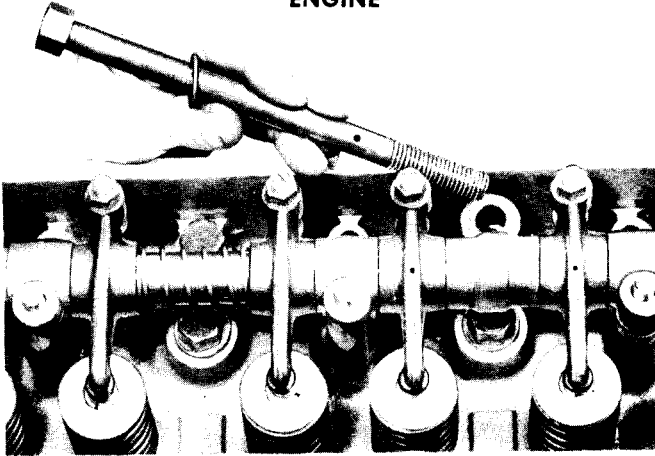

RA PD 18453

Figure 198 — Drilled Cap Screw — Removal

- (28) INSTALL VALVE ROCKER ARM ASSEMBLIES AND VALVE PUSH RODS, FRONT AND REAR.
- (29) INSTALL ROCKER ARM BRACKET CAP SCREWS.
Be sure to install drilled cap screws in proper location.
- (30) INSTALL ROCKER ARM COVER SUPPORT AND SCREWS.
- (31) INSTALL MANIFOLD ASSEMBLY AND NEW GASKETS.
- (32) INSTALL GASKET, CARBURETOR, AND INSULATOR ADAPTER ON INTAKE MANIFOLD.
- (33) CONNECT FUEL LINE AT CARBURETOR.
- (34) CONNECT ACCELERATOR CONTROL ROD AT CARBURETOR.

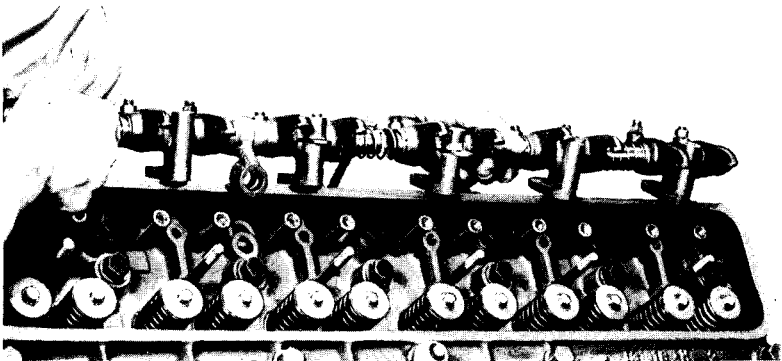

RA PD 18454

Figure 199 — Rocker Arm Assembly — Removal

BASIC HALF-TRACK VEHICLES (IHC) (PERSONNEL CARRIER M5, CAR M9A1, MULTIPLE GUN MOTOR CARRIAGE M14, AND SIMILAR IHC VEHICLES)

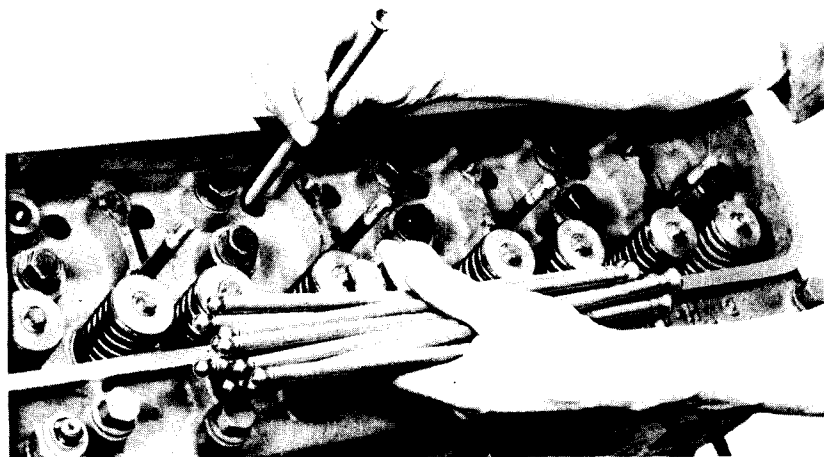

RA PD 18455

Figure 200 – Valve Push Rods – Removal

- (35) CONNECT CHOKE CONTROL WIRE CONDUIT AT CARBURETOR.
- (36) CONNECT THROTTLE CONTROL AT CARBURETOR.
- (37) CONNECT AIR CLEANER ELBOW AT AIR CLEANER.
- (38) CONNECT AIR CLEANER ELBOW AT CARBURETOR.
- (39) CONNECT VACUUM LINE TO BRAKE CHECK VALVE AT MANIFOLD.
- (40) CONNECT FUEL PUMP VACUUM LINE TO MANIFOLD.
- (41) CONNECT CRANKCASE BREATHER VACUUM LINE AT MANIFOLD.

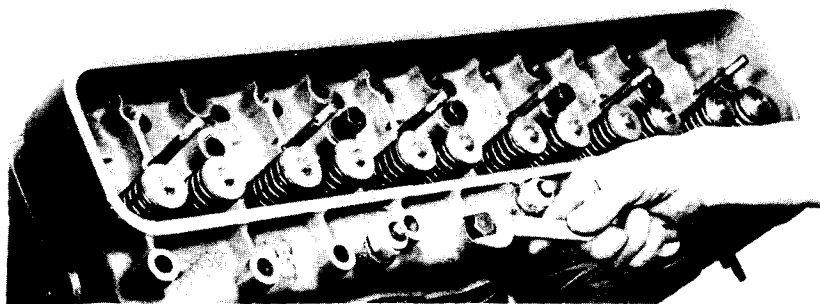

RA PD 18456

Figure 201 – Cylinder Head Cap Screws – Removal

ENGINE

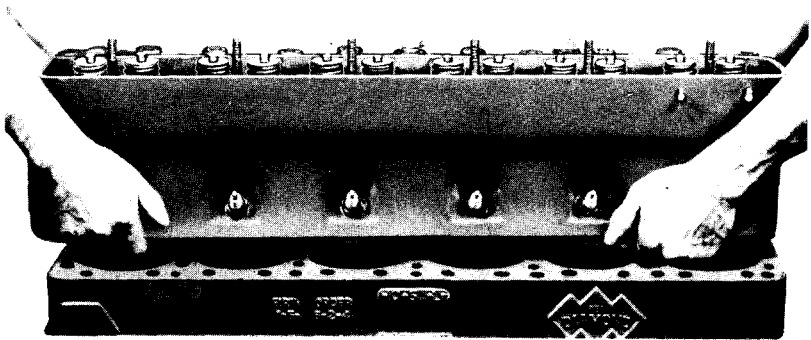

RA PD 18457

Figure 202 – Cylinder Head – Removal

- (42) CONNECT ENGINE WATER OUTLET (UPPER) TO CYLINDER HEAD.
- (43) CONNECT WATER PUMP TO CYLINDER HEAD.
- (44) CONNECT CRANKCASE BREATHER VACUUM LINE AT OIL FILLER PIPE.
- (45) INSTALL IGNITION COIL.

Be sure to replace special lock washers in their original sequence.

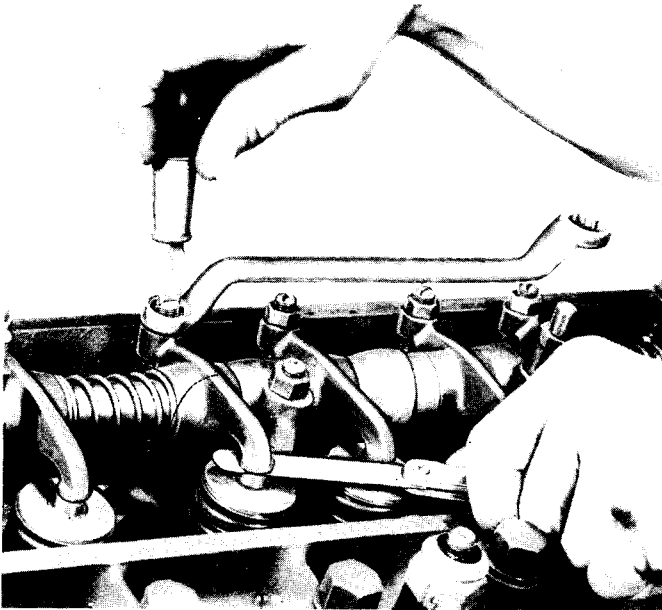

RA PD 18458

Figure 203 – Adjusting Valve Stem Clearance

**BASIC HALF-TRACK VEHICLES (IHC) (PERSONNEL CARRIER M5, CAR M9A1,
MULTIPLE GUN MOTOR CARRIAGE M14, AND SIMILAR IHC VEHICLES)**

(46) INSTALL SPARK PLUGS AND CONNECT HIGH-TENSION CABLES.

(47) CONNECT GENERATOR ADJUSTING STRAP TO WATER PUMP.
Adjust fan belt tension (par. 79).

(48) REFILL COOLING SYSTEM.

(49) START ENGINE AFTER TURNING ENGING OVER BY HAND TO ASSURE THAT ALL VALVE ROCKER ARMS HAVE AMPLE CLEARANCE AT VALVE STEMS.

(50) WHEN ENGINE HAS ATTAINED OPERATING TEMPERATURE OF APPROXIMATELY 160 F, RETIGHTEN CYLINDER HEAD TO 77 FOOT-POUNDS USING TENSION WRENCH.

(51) ADJUST VALVE STEM CLEARANCE (fig. 203).

GAGE, feeler
SCREWDRIVER

WRENCH, box, 1/2-in.

Adjust valve-stem-to-rocker-arm clearance to 0.018 inch with engine hot and running. This is accomplished by loosening lock nut on adjusting screw, and turning screw to attain clearance of 0.018 inch between rocker arm and valve stem end. Tighten lock nut.

(52) INSTALL ROCKER ARM VALVE COVER AND GASKET.

(53) INSTALL HOOD.

108. TIMING MARKS.

a. There are no timing marks on the flywheel of this engine. Timing of this engine is accomplished as outlined in paragraph 94. A timing notch is located on the crankshaft drive pulley and an indexing pointer on the gear case cover (fig. 182).

109. MANIFOLD REPLACEMENT

a. Replacement of the intake and exhaust manifolds is accomplished as follows:

(1) EQUIPMENT.

EXTENSION, socket wrench	WRENCH, end, 1/2-in.
HANDLE, socket wrench	WRENCH, end, 1/16-in.
PLIERS	WRENCH, end, 5/8-in.
SCREWDRIVER	WRENCH, end, 3/4-in.
WRENCH, end, 3/8-in.	WRENCH, socket, 1/16-in.

ENGINE

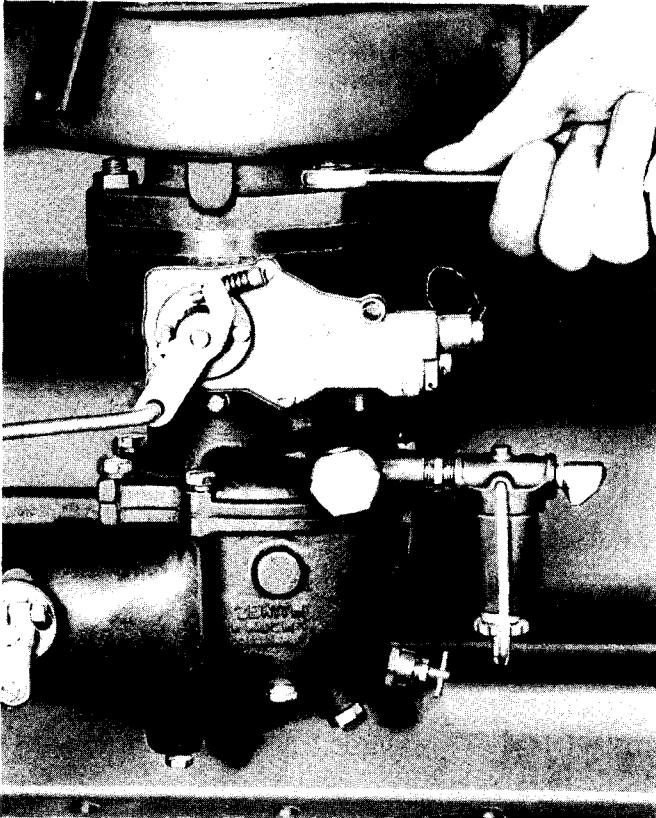

RA PD 18459

Figure 204 – Carburetor Mounting Nut – Removal

(2) PROCEDURE.

(a) *Disconnect Fuel Line at Carburetor.*

WRENCH, end, ½-in.

Loosen nut on fuel line at the carburetor and disconnect fuel line.

(b) *Disconnect Air Cleaner Elbow at Carburetor.*

SCREWDRIVER

Loosen clamp screw on air cleaner elbow at carburetor and disconnect air cleaner elbow.

(c) *Disconnect Air Cleaner Elbow at Air Cleaner.*

WRENCH, end, ½-in.

Remove four cap screws and washers holding air cleaner elbow to air cleaner. Remove air cleaner elbow.

(d) *Disconnect Throttle Control Wire at Carburetor.*

SCREWDRIVER

BASIC HALF-TRACK VEHICLES (IHC) (PERSONNEL CARRIER M5, CAR M9A1, MULTIPLE GUN MOTOR CARRIAGE M14, AND SIMILAR IHC VEHICLES)

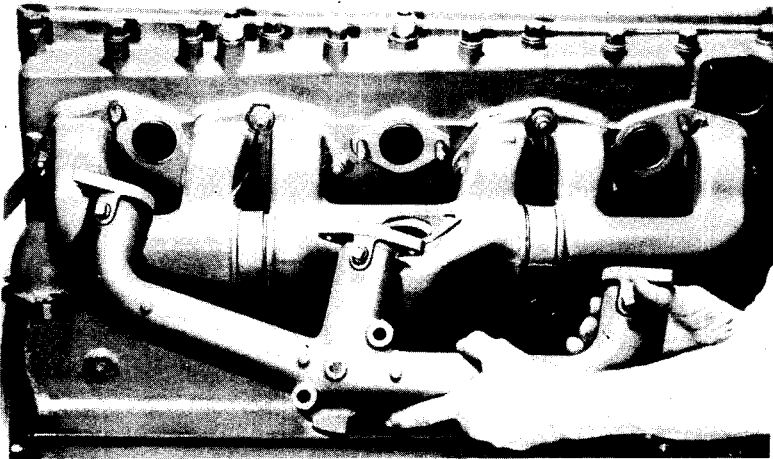

RA PD 18460

Figure 205 – Intake Manifold – Removal

Loosen screw in retaining clamp of throttle control. Disconnect wire.

(e) *Disconnect Choke Control Wire at Carburetor.*

SCREWDRIVER

Loosen screw in retaining clamp of choke control wire at carburetor. Disconnect wire.

(f) *Disconnect Accelerator Control at Carburetor.*

PLIERS

Disconnect pull-back spring and remove cotter pin from accelerator control rod. Disconnect rod at carburetor.

(g) *Remove Carburetor (fig. 204).*

WRENCH, end, $\frac{5}{8}$ -in.

Remove two nuts from carburetor mounting screws. Remove carburetor.

(h) *Disconnect Vacuum Line to Fuel Pump.*

WRENCH, end, $\frac{3}{8}$ -in.

Loosen coupling nut on vacuum line to fuel pump at manifold. Disconnect vacuum line.

(i) *Disconnect Vacuum Line to Crankcase Breather.*

WRENCH, end, $\frac{5}{8}$ -in.

Loosen coupling nut of crankcase breather vacuum line at manifold. Disconnect line.

ENGINE



RA PD 18461

Figure 206 – Intake Manifold Port Seal Rings – Removal

- (j) *Disconnect Vacuum Line to Brake Check Valve.*

SCREWDRIVER

Loosen clamp screws on vacuum line to brake check valve. Disconnect vacuum line.

- (k) *Disconnect Exhaust Manifold at Exhaust Pipe Flange.*

WRENCH, end, $\frac{3}{4}$ -in.

Remove six nuts from exhaust manifold to exhaust pipe flange. Disconnect exhaust pipe and exhaust manifold.

- (l) *Remove Intake Manifold.*

HANDLE, socket wrench **WRENCH**, socket, $\frac{9}{16}$ -in.

Remove six nuts and washers and two cap screws holding intake manifold to cylinder head and to exhaust manifold. Remove manifold (fig. 205). Remove seal rings from ports (fig. 206).

- (m) *Remove Exhaust Manifold.*

WRENCH, $\frac{9}{16}$ -in.

Remove four nuts and washers holding exhaust manifold assembly to cylinder head. Remove assembly (fig. 207).

- (n) *Disconnect Exhaust Manifold Sections.*

WRENCH, end, $\frac{9}{16}$ -in.

Loosen two clamp screws holding manifold sections. Separate two end sections from center portion (fig. 208).

- (o) *Install Intake Manifold, After First Inserting Port Seal Rings and New Gaskets.*

BASIC HALF-TRACK VEHICLES (IHC) (PERSONNEL CARRIER M5, CAR M9A1, MULTIPLE GUN MOTOR CARRIAGE M14, AND SIMILAR IHC VEHICLES)

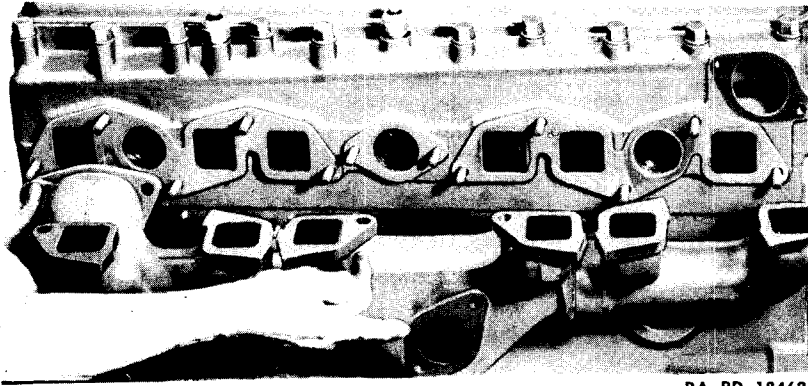

RA PD 18462

Figure 207 – Exhaust Manifold – Removal

(p) Install Exhaust Manifold.

Connect the three sections of exhaust manifold, but do not tighten the clamp screws. Install manifold with new gaskets on cylinder head studs.

(q) Install Intake-to-Exhaust-Manifold Cap Screws.

(r) Tighten All Manifold-to-Cylinder-Head Nuts.

(s) Tighten Exhaust Manifold Section Clamp Screws.

(t) Connect Exhaust Manifold at Exhaust Pipe Flange.

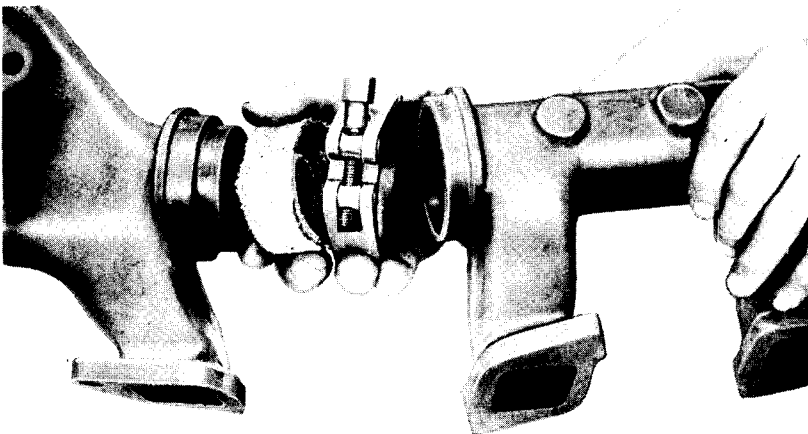

RA PD. 18463

Figure 208 – Exhaust Manifold – Disassembly

ENGINE



RA PD 18464

Figure 209 – Oil Pan – Removal

See that exhaust pipe flange seal ring is in proper position before tightening nuts.

- (u) *Connect Vacuum Line to Brake Check Valve at Manifold.*
- (v) *Connect Vacuum Line to Fuel Pump at Manifold.*
- (w) *Connect Vacuum Line to Crankcase Breather at Manifold.*
- (x) *Install Carburetor.*
- (y) *Connect Accelerator Control Rod and Pull-back Spring.*
- (z) *Connect Choke Control.*

Make sure that choke is fully open and control button is in against dash.

- (aa) *Connect Throttle Control.*

Make sure that throttle button is in against dash and that throttle is closed.

- (bb) *Connect Air Cleaner Elbow at Air Cleaner.*
- (cc) *Connect Air Cleaner Elbow at Carburetor.*

Be sure all connections are tight and free from leaks.

- (dd) *Connect Fuel Line at Carburetor.*

110. OIL PUMP.

a. **Description.** The engine oil pump is of gear type developing pressure of a minimum of 10 to 15 pounds at 200 to 300 revolutions per minute, and a maximum of 40 to 45 pounds at 1,500 to 1,800 revolutions per minute. The oil intake and screen is of float type. Whenever the

BASIC HALF-TRACK VEHICLES (IHC) (PERSONNEL CARRIER M5, CAR M9A1, MULTIPLE GUN MOTOR CARRIAGE M14, AND SIMILAR IHC VEHICLES)

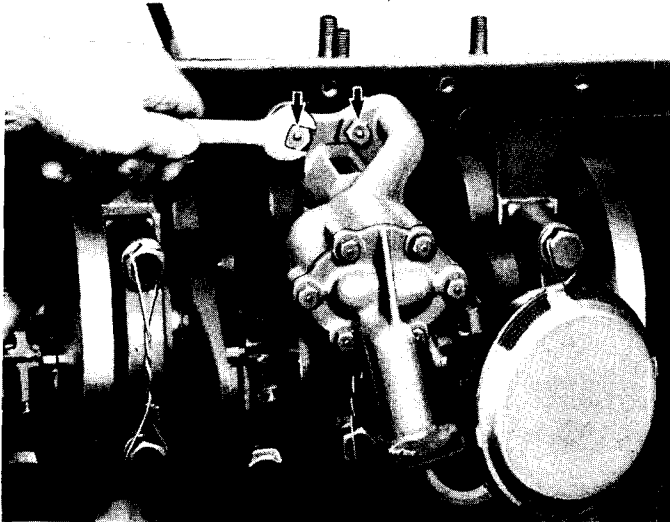

RA PD 18465

Figure 210 — Oil Pump Retaining Cap Screws — Removal

oil pump has been removed from the engine, the ignition distributor must be removed prior to pump installation.

h. Oil Pump Replacement.

(1) EQUIPMENT.

- EXTENSION, socket wrench
- HANDLE, socket wrench
- PLIERS
- SCREWDRIVER
- WRENCH, end, 1/2-in.
- WRENCH, end, 9/16-in.

- WRENCH, end, 1 1/8-in.
- WRENCH, socket, 9/16-in.
- WRENCH, socket, 5/8-in.
- WRENCH, socket, 3/4-in.
- WRENCH, socket 7/8-in.

(2) PROCEDURE.

(a) Remove Oil Pan Guard.

- EXTENSION, socket wrench
- HANDLE, socket wrench

- WRENCH, socket, 3/4-in.

Remove eight bolts, nuts, and washers (four at each frame side rail) from oil pan guard. Remove oil pan guard.

(b) Drain Cooling System.

- WRENCH, end, 1/2-in.

Open radiator drain cock and remove oil cooler plug at bottom of oil pan.

(c) Drain Oil Pan.

- WRENCH, end, 1 1/8-in.

Remove oil pan drain plug from bottom of oil pan.

ENGINE

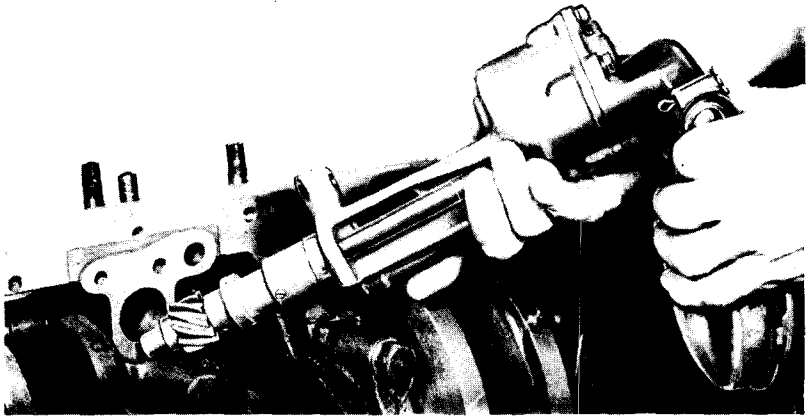

RA PD 18466

Figure 211 — Oil Pump — Removal

(d) *Disconnect Oil Cooler Hose Connections.*

SCREWDRIVER

Loosen clamp screws from oil cooler inlet and outlet hose connections. Disconnect hose.

(e) *Remove Oil Pan (fig. 209).*

EXTENSION, socket wrench

WRENCH, socket, $\frac{9}{16}$ -in.

HANDLE, socket wrench

WRENCH, socket, $\frac{5}{8}$ -in.

Remove two nuts and lock washers from front end of oil pan screws. Remove nine cap screws (less nuts) and eleven cap screws with nuts and lock washers. Remove oil pan and gasket.

(f) *Remove Oil Pump (fig. 210).*

WRENCH, end, $\frac{9}{16}$ -in.

Remove two cap screws and lock washers holding oil pump to case. Remove oil pump and gasket (fig. 211).

(g) *Remove Oil Strainer (Float) (fig. 212).*

PLIERS

Remove cotter pin and remove float assembly.

(h) *Install Float Assembly.*

(i) *Install Replacement Oil Pump.*

Remove distributor, before installation of pump and new gasket (par. 91).

(j) *Install Oil Pan and Gasket.*

BASIC HALF-TRACK VEHICLES (IHC) (PERSONNEL CARRIER M5, CAR M9A1, MULTIPLE GUN MOTOR CARRIAGE M14, AND SIMILAR IHC VEHICLES)

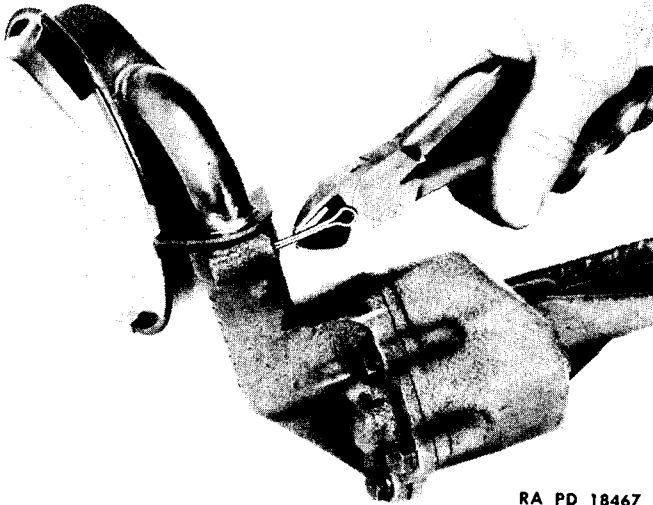

Figure 212 – Oil Strainer – Removal

(k) Connect Oil Cooler Hose, Inlet and Outlet.

(l) Refill Oil Pan.

Refill capacity 9 quarts.

(m) Refill Cooling System.

Capacity 31 quarts.

(n) Install Oil Pan Guard.

(o) Install and Retime Distributor (par. 114).

III. VALVES.

a. Description. The intake valve has a head diameter of $2\frac{1}{4}$ inches, a stem diameter of 0.434 inch, and a valve face angle of 15 degrees. The exhaust valve has a head diameter of $1\frac{35}{64}$ inches, a stem diameter of 0.434 inch, and a valve face angle of 45 degrees. The valves are actuated by valve lifters at the camshaft which in turn operate valve push rods. These push rods actuate valve rocker arms which open and close the valves.

b. Valve Maintenance and Adjustments.

(1) Valve stem to rocker arm clearance is 0.018 inch, as measured with a feeler gage, with the engine running, and with engine at normal operating temperature.

ENGINE

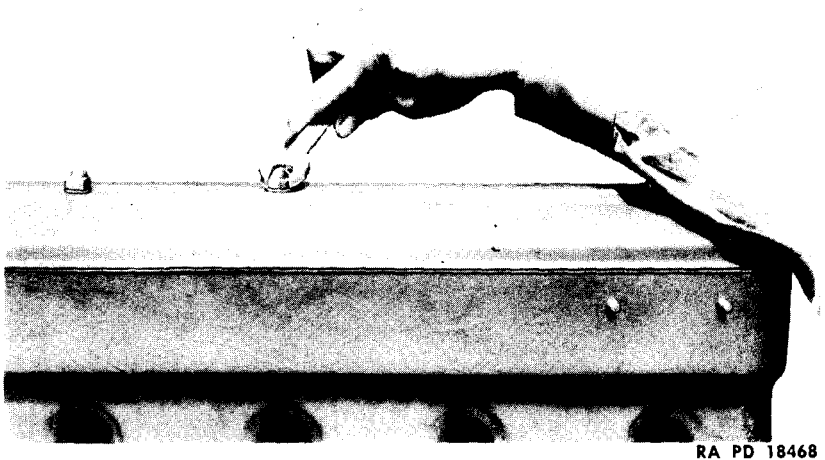

RA PD 18468

Figure 213 – Valve Rocker Arm Cover – Removal

(2) **VALVE ADJUSTMENT.** Valve adjustment requires the removal of the valve rocker arm compartment cover and is accomplished as follows:

(a) *Equipment.*

GAGE, feeler

WRENCH, $\frac{9}{16}$ -in.

SCREWDRIVER

WRENCH, end, $\frac{1}{2}$ -in.

(b) *Procedure.*

1. Remove valve rocker arm cover (fig. 213).

WRENCH, end, $\frac{1}{2}$ -in.

Remove four dome nuts from valve rocker arm cover. Remove cover.

2. Adjust tappets (fig. 203).

GAGE, feeler

WRENCH, $\frac{9}{16}$ -in.

SCREWDRIVER

With engine hot and running, loosen valve rocker arm lock nut and adjust each of twelve adjusting screws until 0.018-inch clearance is obtained between rocker arm and valve stem end. Tighten lock nut and recheck clearance.

3. *Install valve rocker arm cover.*

Make sure that leaks are not present between cover, cover gasket, and cylinder head.

**BASIC HALF-TRACK VEHICLES (IHC) (PERSONNEL CARRIER M5, CAR M9A1,
MULTIPLE GUN MOTOR CARRIAGE M14, AND SIMILAR IHC VEHICLES)**

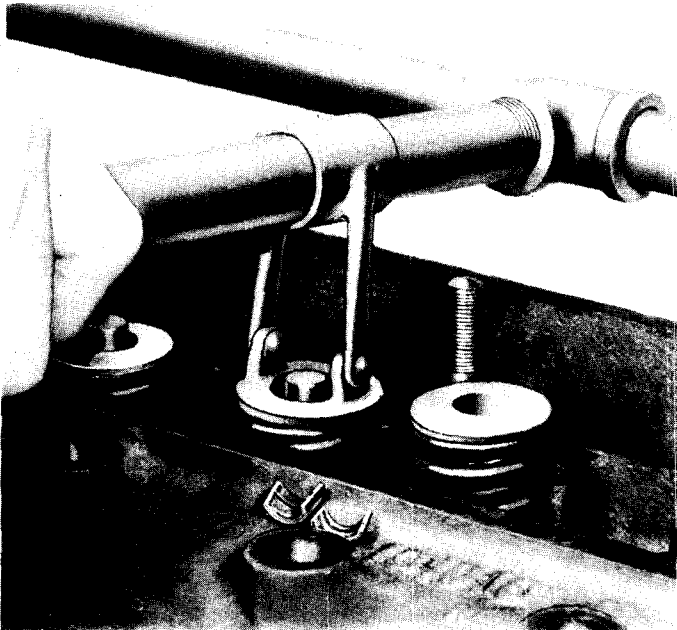

RA PD 18469

Figure 214 — Compressing Valve Springs for Valve — Removal

112. VALVE REPLACEMENT.

a. Valve replacement requires removal of the engine cylinder head and engine manifolds, and draining of the cooling system, and is accomplished as follows:

(1) **EQUIPMENT.** Same equipment as required for cylinder head removal (par. 107) plus valve spring compressor.

(2) **PROCEDURE.**

(a) *Remove Cylinder Head.*

See paragraph 107 a and b (1) to (25).

(b) *Remove Valves* (fig. 213).

COMPRESSOR, valve spring

Compress valve springs, and remove valve locks from retainers. Number each valve as to port from which it is removed so it may be returned to same valve seat. Remove inner and outer valve springs. Remove valves.

(c) *Clean Out Carbon.*

Scrape or brush out carbon from combustion chambers. Clean carbon from valves.

ENGINE

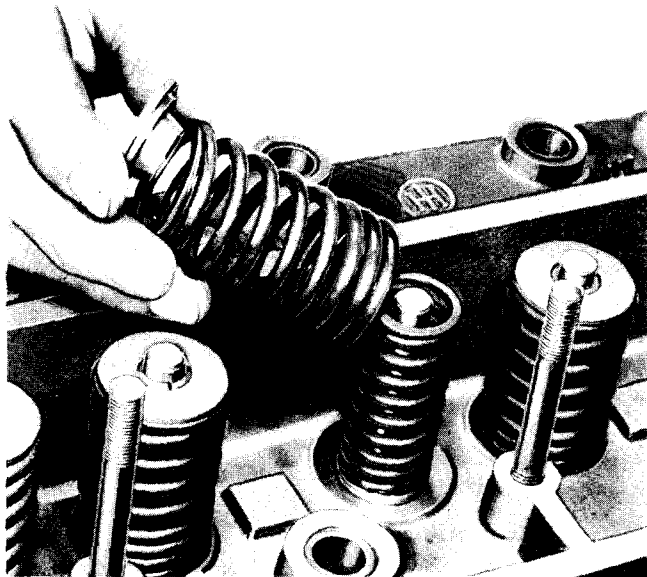

RA PD 18470

Figure 215 – Valve Springs – Installation

(d) Install Valves.

Valves which give no indication of poor seating can be returned to their original seats. Valves giving indication of poor seating should be replaced.

(e) Install Valve Springs (fig. 215).

Place inner and outer valve springs over valve stem with closed coils on spring retainer seats nearest head of valve. Place valve lock retainer on springs. Compress spring and install locks.

(f) Install New Cylinder Head Gasket.

Install gasket with marked side "THIS SIDE OUT" toward the top.

(g) Install Cylinder Head (par. 107 b (26) to (53)).

113. CLEANING CARBON.

a. Whenever the engine cylinder head is removed, the combustion chambers should be cleaned of carbon accumulation.

(1) EQUIPMENT.

BRUSH, carbon

SCRAPER

(2) PROCEDURE.

(a) Any areas on top of the motor block showing carbon should be scraped clean and tops of pistons should also be scraped clean (fig. 216).

BASIC HALF-TRACK VEHICLES (IHC) (PERSONNEL CARRIER M5, CAR M9A1, MULTIPLE GUN MOTOR CARRIAGE M14, AND SIMILAR IHC VEHICLES)

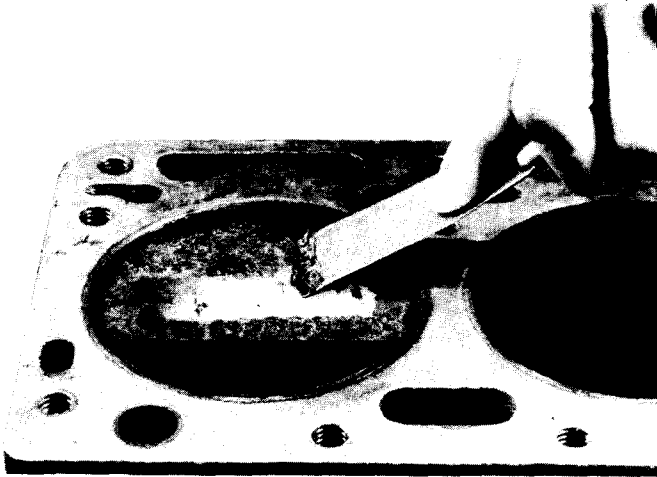

RA PD 18471

Figure 216 — Removing Carbon from Top of Piston

(b) Carbon accumulation in the combustion chambers of the cylinder head can be removed with a scraper (fig. 217) or carbon cleaning brush powered by an electric drill.



RA PD 18472

Figure 217 — Removing Carbon from Cylinder Head

ENGINE

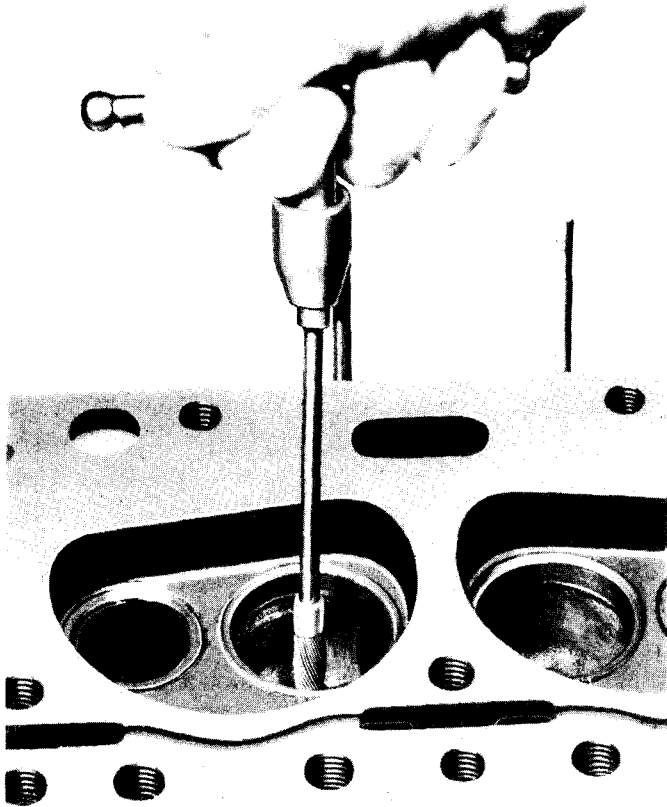

RA PD 18473

Figure 218 – Cleaning Valve Stem Guides

(c) When valves are removed, accumulated carbon can be readily removed and valve guides can be cleaned, using a suitable valve guide cleaning tool (fig. 218).

114. TUNE-UP.

a. Before an engine tune-up is accomplished, a test of the engine compression should be made, since excessively uneven compression in the cylinders makes successful tuning impossible. Recommended tune-up procedure is as follows:

(1) **SPARK PLUGS.** Check for proper size and heat range, fouled gap, cracked porcelain, gap settings (par. 92).

(2) **BATTERY AND IGNITION CABLES.** Inspect ground strap and starter cable; check ignition wiring. Terminals must be tight and clean (par. 84).

BASIC HALF-TRACK VEHICLES (IHC) (PERSONNEL CARRIER M5, CAR M9A1, MULTIPLE GUN MOTOR CARRIAGE M14, AND SIMILAR IHC VEHICLES)

(3) **DISTRIBUTOR.** Inspect points for evidence of pitting or burning; check breaker point gap; inspect cap for cracks and pitted posts; check operation of centrifugal weights and movements; check condenser (par. 91).

(4) **CARBURETOR.** Clean air cleaner; check for leaks; adjust carburetor idling screw if necessary; check connection of controls (par. 130).

(5) **TIMING.** Check ignition timing with a neon timing lamp to assure that No. 1 cylinder is firing in accordance with the timing mark on the crankshaft drive pulley and timing pointer on the gear cover (par. 94).

115. OIL PAN REPLACEMENT.

a. Oil pan replacement requires draining of the cooling system and draining of the oil pan.

(1) **EQUIPMENT.**

EXTENSION, socket wrench	WRENCH, end, 1 1/8-in.
HANDLE, socket wrench	WRENCH, socket, 1/16-in.
PLIERS	WRENCH, socket, 5/8-in.
SCREWDRIVER	WRENCH, socket, 3/4-in.
WRENCH, end, 1/2-in.	WRENCH, socket, 7/8-in.
WRENCH, end, 3/16-in.	

(2) **PROCEDURE.**

(a) *Remove Oil Pan Guard.*

EXTENSION, socket wrench	WRENCH, socket, 3/4-in.
HANDLE, socket wrench	

Remove eight bolts, nuts, and washers (four at each frame side rail) from oil pan guard. Remove oil pan guard.

(b) *Drain Cooling System.*

WRENCH, end, 1/2-in.

Open radiator drain cock and remove oil cooler plug at bottom of oil pan; drain cooling fluid.

(c) *Drain Oil Pan.*

WRENCH, end, 1 1/8-in.

Remove oil pan drain plug from bottom of oil pan; drain oil.

(d) *Disconnect Oil Cooler Hose Connections.*

SCREWDRIVER

Loosen clamp screw from oil cooler hose connections at pan. Disconnect hose.

ENGINE

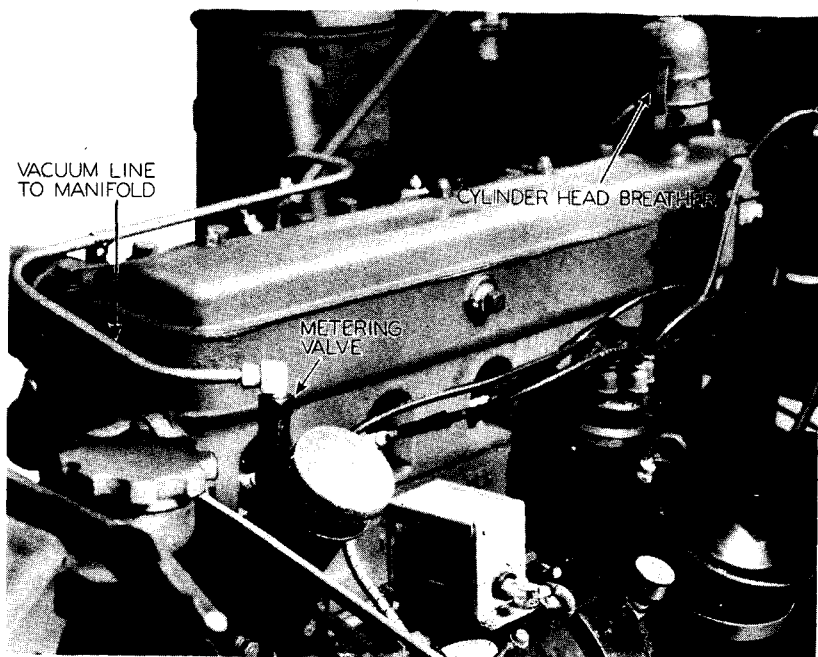

RA PD 18283

Figure 219 – Engine, Showing Crankcase Ventilator and Cylinder Head Breather – Left Side

(e) *Remove Oil Pan.*

HANDLE, socket wrench

WRENCH, socket, $\frac{5}{8}$ -in.

WRENCH, socket, $\frac{9}{16}$ -in.

Remove two nuts and lock washers from front end of oil pan screws. Remove nine cap screws (less nuts) and eleven cap screws with nuts and lock washers. Remove oil pan and gasket.

(f) *Install Oil Pan and Gasket.*

(g) *Connect Oil Cooler Hose Connections.*

(h) *Install Oil Pan Guard.*

(i) *Refill Cooling System (Capacity 31 Quarts).*

(j) *Refill Oil Pan to "FULL" Mark on Oil Level Bayonet Gage (Refill 9 Quarts).*

116. CRANKCASE VENTILATOR (fig. 219).

a. Crankcase ventilation is obtained by drawing off crankcase fumes from the engine and passing them into the intake manifold of the engine.

**BASIC HALF-TRACK VEHICLES (IHC) (PERSONNEL CARRIER M5, CAR M9A1
MULTIPLE GUN MOTOR CARRIAGE M14, AND SIMILAR IHC VEHICLES**

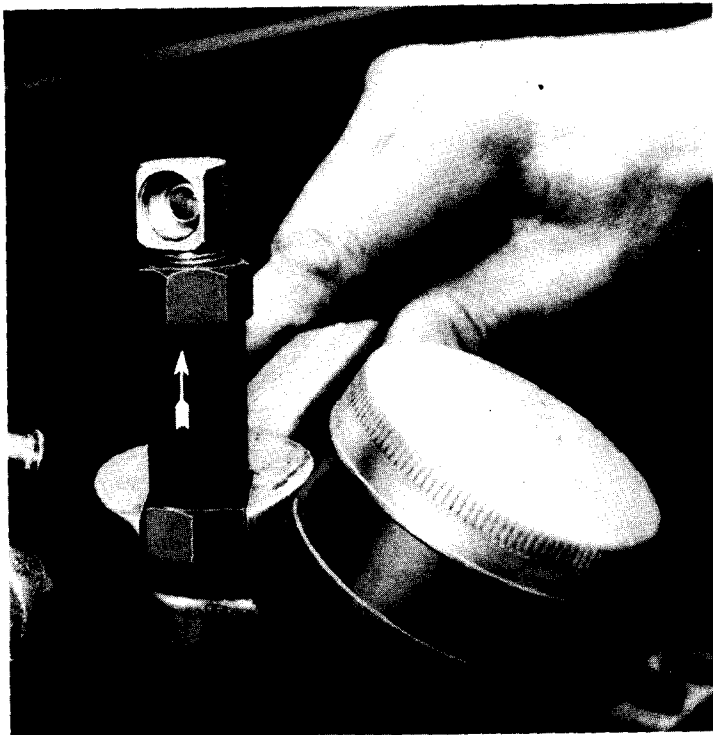

RA PD 18474

Figure 220 – Ventilator Metering Valve – Installation

(1) **DESCRIPTION.** A vacuum line is connected at the intake manifold and passes along the cylinder head to the oil filler pipe on the left front of the engine. At this point the vacuum line attaches to a vacuum metering valve, the purpose of which is to control the vacuum to which the crankcase is subjected, particularly at idle engine speeds. The cylinder head valve compartment is ventilated by means of an oil type breather located on the valve rocker arm cover.

(2) **MAINTENANCE.**

(a) **Crankcase Ventilator.** No adjustment is necessary or provided for the crankcase ventilator. However, the metering valve should be removed at intervals of approximately 10,000 miles for cleaning. Disassemble and clean parts in varnish remover and reassemble. When installing metering valve, the arrow must point upward (fig. 220).

(b) **Cylinder Head Breather.** The cylinder head breather should be serviced weekly, making sure that oil in the cup is at proper level. If operated under extreme conditions, this attention should be accorded daily. When evidence of dirt is noted, the breather should be removed

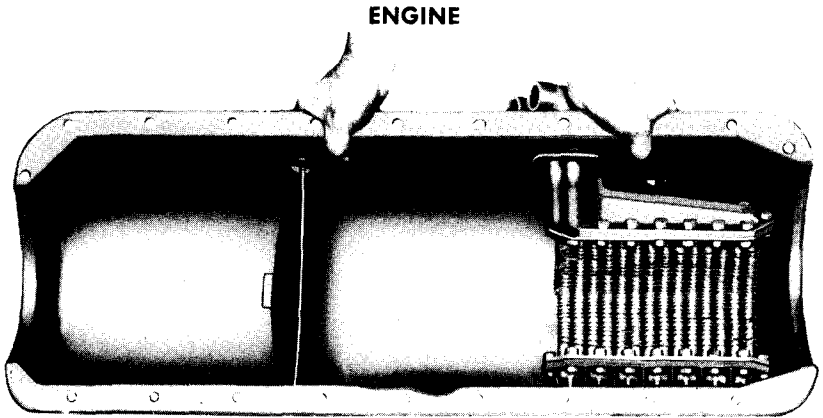

RA PD 18475

Figure 221 – Oil Pan, Showing Oil Cooler Unit – Installed

from the rocker arm cover, disassembled and cleaned, refilled and reinstalled.

117. OIL COOLER.

a. **Description.** Engine lubricating oil temperature is controlled to efficient temperature by means of an oil cooler unit located in the oil pan (fig. 221). Cooling medium is circulated through this cooler unit from the water pump. The hose connections are located on the right-hand side of the engine. The upper hose is the cooler inlet, and the lower hose is the outlet.

b. **Oil Cooler Replacement.** Replacement of the oil cooler unit itself is outside the scope of this manual. Replacement of the complete oil pan and cooler unit assembly should be made as outlined in paragraph 115.

118. ENGINE REPLACEMENT.

a. Equipment.

EXTENSION, socket wrench
HANDLE, socket wrench
PLIERS
SCREWDRIVER
WRENCH, end, $1\frac{1}{32}$ -in.
WRENCH, end, $\frac{3}{8}$ -in.
WRENCH, end, $\frac{7}{16}$ -in.
WRENCH, end, $\frac{1}{2}$ -in.

WRENCH, end, $\frac{9}{16}$ -in.
WRENCH, end, $\frac{5}{8}$ -in.
WRENCH, end, $\frac{3}{4}$ -in.
WRENCH, end, $\frac{7}{8}$ -in.
WRENCH, end, 1-in.
WRENCH, socket, $\frac{9}{16}$ -in.
WRENCH, socket, $\frac{3}{4}$ -in.
WRENCH, socket, 1-in.

b. Procedure.

(1) REMOVE RADIATOR.

Procedure is outlined in paragraph 76 b.

BASIC HALF-TRACK VEHICLES (IHC) (PERSONNEL CARRIER M5, CAR M9A1, MULTIPLE GUN MOTOR CARRIAGE M14, AND SIMILAR IHC VEHICLES)

- (2) **DISCONNECT TACHOMETER DRIVE SHAFT.**

PLIERS

Disconnect tachometer drive shaft at distributor housing by unscrewing coupling nut.

- (3) **DISCONNECT BATTERY CABLE AT BATTERY.**

WRENCH, end, $\frac{9}{16}$ -in.

Remove battery box cover and disconnect negative battery cable from battery.

- (4) **DISCONNECT WIRING AT GENERATOR.**

SCREWDRIVER**WRENCH, end, $\frac{9}{16}$ -in.**

Disconnect cables at armature terminal and field terminals of generator. Disconnect wires to suppression filter. Disconnect generator-to-regulator ground wire at generator.

- (5) **DISCONNECT WIRING AT COIL.**

WRENCH, end, $\frac{3}{8}$ -in.

Disconnect low-tension wires at top of coil.

- (6) **DISCONNECT WIRING AT STARTING MOTOR.**

WRENCH, end, $1\frac{1}{32}$ -in.**WRENCH, end, $\frac{5}{8}$ -in.**

Disconnect battery cable and ammeter cables at starter terminal. Disconnect starter-button-to-starter-switch wire at starter terminal.

- (7) **DISCONNECT VACUUM LINE TO WINDSHIELD WIPERS AT FUEL PUMP.**

WRENCH, end, $\frac{1}{2}$ -in.

Loosen connection of vacuum line to windshield wipers at fuel pump.

- (8) **DISCONNECT FUEL LINE FROM FUEL TANKS AT FUEL PUMP.**

WRENCH, end, $\frac{1}{2}$ -in.**WRENCH, end, $\frac{5}{8}$ -in.**

Shut off fuel at shut-off valves. Disconnect fuel line at fuel pump.

- (9) **REMOVE AIR CLEANER TO CARBURETOR ELBOW.**

SCREWDRIVER**WRENCH, end, $\frac{1}{2}$ -in.**

Disconnect air cleaner elbow at carburetor. Remove four cap screws from air cleaner elbow at air cleaner. Remove air cleaner elbow.

- (10) **DISCONNECT VACUUM LINE TO BRAKE CHECK VALVE.**

SCREWDRIVER

Loosen clamp screws on vacuum line to brake check valve. Disconnect.

- (11) **DISCONNECT THROTTLE CONTROL AND CHOKE CONTROL WIRES AT CARBURETOR.**

SCREWDRIVER

Loosen clamp screws at carburetor holding throttle and choke control wires.

ENGINE

(12) DISCONNECT ACCELERATOR CONTROL ROD.

PLIERS

Remove cotter pin from accelerator control rod at carburetor. Disconnect.

(13) REMOVE OIL PAN GUARD.

EXTENSION, socket wrench WRENCH, socket, $\frac{3}{4}$ -in.
HANDLE, socket wrench

Remove eight bolts, nuts, and washers (four at each frame side rail) from oil pan guard. Remove guard.

(14) REMOVE EXHAUST PIPE.

WRENCH, end, $\frac{1}{16}$ -in. WRENCH, end, $\frac{3}{4}$ -in.

Remove six nuts and three bolts from exhaust pipe to manifold flange. Remove seal ring. Loosen clamp bolt nut at exhaust pipe connection to muffler. Remove exhaust pipe.

(15) DISCONNECT TRANSMISSION AT ENGINE FLYWHEEL HOUSING.

EXTENSION, socket wrench WRENCH, socket, $\frac{9}{16}$ -in.
HANDLE, socket wrench

Remove twelve cap screws and washers from engine flywheel housing to transmission bell housing.

(16) REMOVE ENGINE REAR MOUNTING CAP SCREWS.

EXTENSION, socket wrench WRENCH, end, $\frac{7}{8}$ -in.
HANDLE, socket wrench WRENCH, socket, 1-in.

Remove nuts from two (one at each side of engine) mounting cap screws. Remove cap screws.

(17) ATTACH SLING TO ENGINE.

Attach sling around engine in such a manner that it will be blocked away from accessories to avoid their damage and in such manner that firm and secure hold will be had on engine.

(18) DISCONNECT FRONT AXLE BRAKE TUBE AT FRONT CROSS MEMBER ENGINE SUPPORT.

WRENCH, end, $\frac{9}{16}$ -in. WRENCH, end, 1-in.
WRENCH, end, $\frac{3}{4}$ -in.

Disconnect front axle brake tube at rear side of engine front support arm. Disconnect brake tube connection at front support.

(19) REMOVE ENGINE FRONT MOUNTING SUPPORT BOLTS, NUTS, AND WASHERS.

WRENCH, end, $\frac{3}{4}$ -in.

BASIC HALF-TRACK VEHICLES (IHC) (PERSONNEL CARRIER M5, CAR M9A1, MULTIPLE GUN MOTOR CARRIAGE M14, AND SIMILAR IHC VEHICLES)

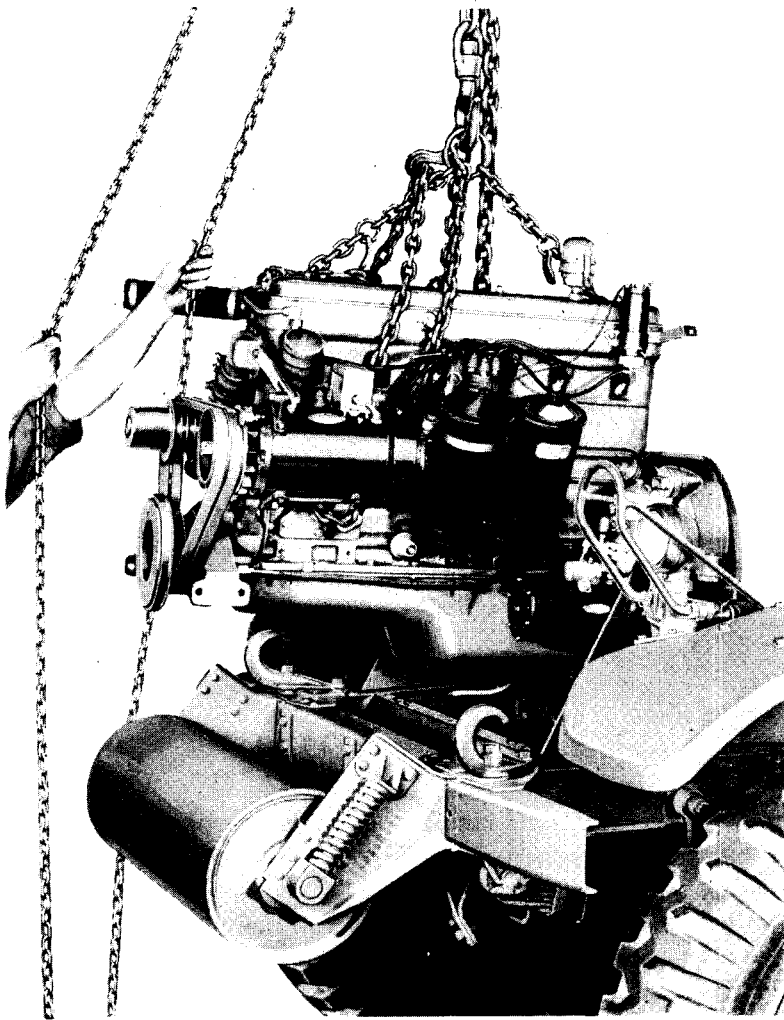

RA PD 18476

Figure 222 – Removing Engine from Chassis

Remove four bolts, nuts, and washers (two at each end of front support arm). Be sure to have engine supported by sling before removing these bolts.

(20) REMOVE ENGINE FROM CHASSIS (fig. 222).

Guide engine carefully to avoid damage to parts and to prevent strain to clutch and to transmission main drive gear shaft. Remove engine from chassis.

ENGINE**(21) INSTALL REPLACEMENT ENGINE IN CHASSIS.**

Attach sling around engine and attach hoist to sling. Raise and guide engine carefully into position to assure connection of clutch splines and transmission main shaft.

(22) CONNECT ENGINE FRONT AND REAR MOUNTINGS.

Remove sling.

(23) CONNECT FRONT AXLE BRAKE TUBE AT ENGINE SUPPORT ARM.**(24) INSTALL TRANSMISSION BELL HOUSING TO ENGINE FLYWHEEL HOUSING CAP SCREWS.****(25) INSTALL EXHAUST PIPE AND CONNECT AT FRONT AND REAR.****(26) INSTALL OIL PAN GUARD.****(27) CONNECT ACCELERATOR, THROTTLE, AND CHOKE CONTROLS.****(28) CONNECT VACUUM LINE AT BRAKE CHECK VALVE.****(29) CONNECT AIR CLEANER ELBOW AT AIR CLEANER AND AT CARBURETOR.****(30) CONNECT VACUUM LINE TO WINDSHIELD WIPERS AT FUEL PUMP.****(31) CONNECT FUEL LINE FROM FUEL TANKS AT FUEL PUMP.**

Open shut-off valves.

(32) CONNECT BATTERY CABLE, AMMETER CABLE, AND STARTER SWITCH WIRE AT STARTING MOTOR.**(33) CONNECT LOW-TENSION WIRES AT COIL.****(34) CONNECT CABLES AT ARMATURE AND FIELD TERMINALS OF GENERATOR.**

Connect radio suppression filter wires.

(35) CONNECT TACHOMETER DRIVE SHAFT AT DISTRIBUTOR HOUSING.**(36) INSTALL RADIATOR (par. 76 c (1) to (15)).****(37) CONNECT NEGATIVE BATTERY CABLE AT BATTERY.****(38) BLEED BRAKE LINES (par. 66).**

**BASIC HALF-TRACK VEHICLES (IHC) (PERSONNEL CARRIER M5, CAR M9A1,
MULTIPLE GUN MOTOR CARRIAGE M14, AND SIMILAR IHC VEHICLES)**

Section XVIII

EXHAUST SYSTEM

	Paragraph
Description	119
Maintenance	120
Removal of parts.....	121

119. DESCRIPTION (figs. 221 and 222).

a. The exhaust system consists of an exhaust pipe from the engine manifold, a muffler, and an exhaust tail pipe.

120. MAINTENANCE.

a. The exhaust system must be kept cleaned out since a clogged system will adversely affect engine performance. Exhaust pipe flange bolts must be kept tight at all times as must exhaust pipe to muffler clamp bolts, in order to prevent dangerous leaks.

(1) **INSIDE.**

(a) *Opened Seams in Muffler.* Where this condition exists, replace muffler.

(b) *Corroded Metal.* Replace muffler.

(c) *Loose and Defective Gaskets and Baffles.* Tighten or replace.

(2) **OUTSIDE.**

(a) *Dents or Breaks.* Replace if the metal is opened.

(b) *Corrosion.* Replace unit.

121. REMOVAL OF PARTS.

a. An exhaust system should be replaced whenever leaks develop.

(1) **EXHAUST PIPE.**

(a) *Equipment.*

EXTENSION, ratchet wrench

WRENCH, end, $\frac{1}{16}$ -in.

HANDLE, ratchet wrench

WRENCH, end, $\frac{3}{4}$ -in.

WRENCH, end, $\frac{1}{2}$ -in.

WRENCH, socket, $\frac{3}{4}$ -in.

EXHAUST SYSTEM

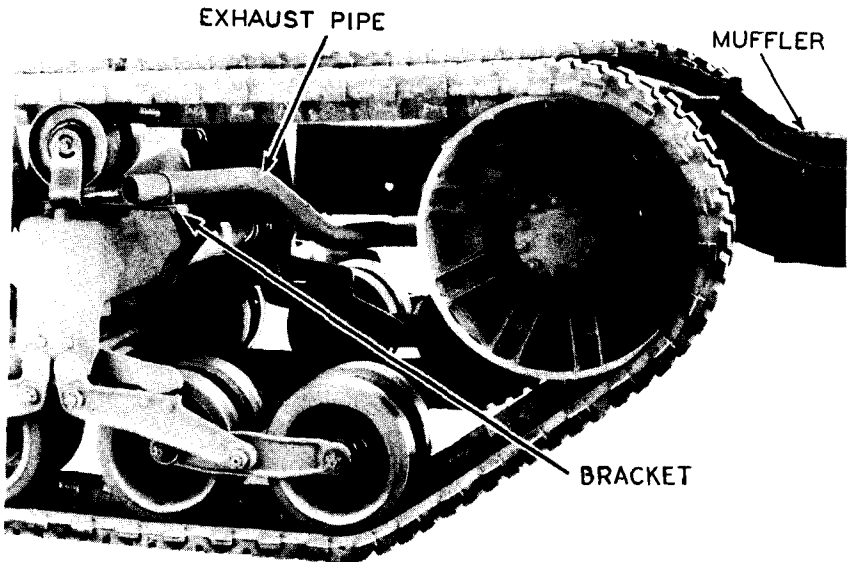

RA PD 18284

Figure 223 – Tail Pipe – Installed

(b) Procedure.

1. Loosen clamp at muffler.

WRENCH, end, $\frac{9}{16}$ -in.

Loosen clamp bolt at junction of exhaust pipe and muffler.

2. Remove manifold to exhaust pipe flange nuts.

EXTENSION, ratchet wrench

WRENCH, end, $\frac{3}{4}$ -in.

HANDLE, ratchet wrench

WRENCH, socket, $\frac{3}{4}$ -in.

Raise hood on right side. Remove three lock nuts and three flange bolt nuts from exhaust pipe flange.

3. Remove exhaust pipe.

Move exhaust pipe forward to free from muffler and remove pipe and steel seal ring.

4. Install replacement exhaust pipe.

Be sure to reinstall steel seal ring between exhaust pipe and manifold.

5. Install flange bolt nuts and lock nuts.

6. Tighten clamp bolt nut at muffler.

(2) MUFFLER.

(a) Equipment.

WRENCH, end, $\frac{1}{2}$ -in.

WRENCH, end, $\frac{9}{16}$ -in.

**BASIC HALF-TRACK VEHICLES (IHC) (PERSONNEL CARRIER M5, CAR M9A1,
MULTIPLE GUN MOTOR CARRIAGE M14, AND SIMILAR IHC VEHICLES)**

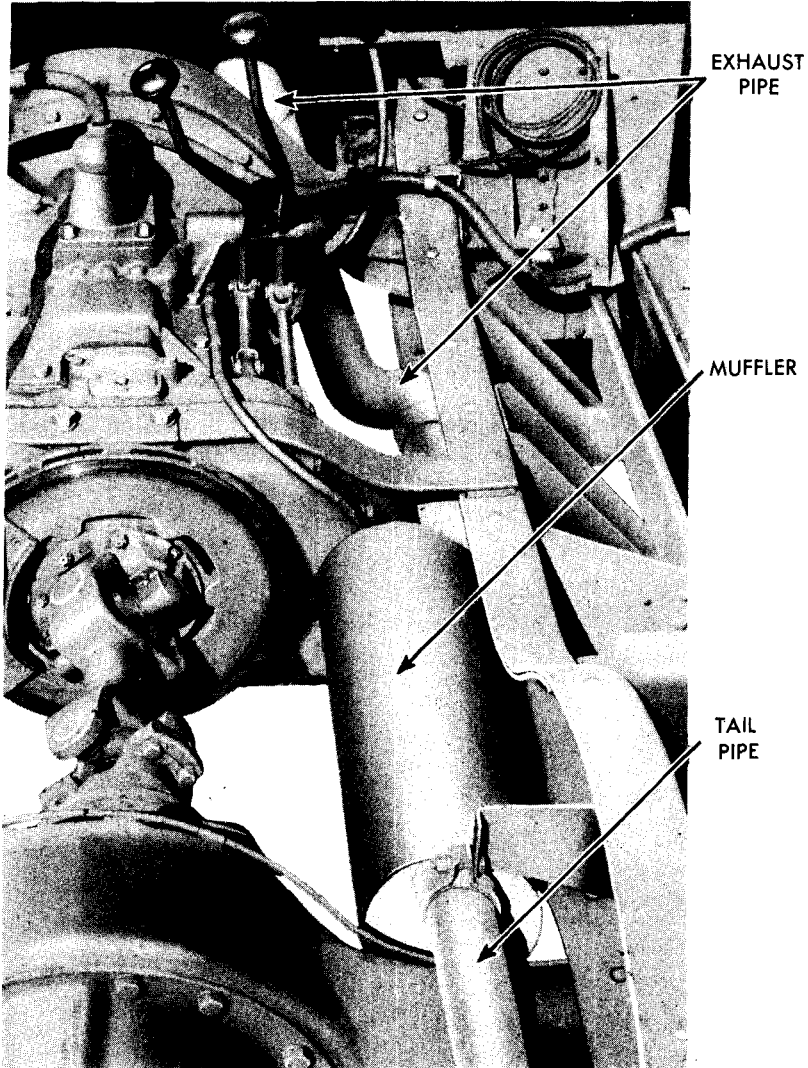

RA PD 18477

Figure 224 — Muffler and Exhaust Pipe — Installed

EXHAUST SYSTEM

(b) Procedure.

1. *Loosen exhaust pipe clamp bolt.*

WRENCH, end, $\frac{9}{16}$ -in.

Loosen clamp bolt at front of muffler holding exhaust pipe.

2. *Remove tail pipe clamp bolt.*

WRENCH, end, $\frac{9}{16}$ -in.

Remove tail pipe clamp bolt at rear of muffler.

3. *Remove tail pipe support bracket clamp bolt.*

WRENCH, end, $\frac{1}{2}$ -in.

Remove clamp bolt in tail pipe supporting bracket.

4. *Remove muffler.*

Shift tail pipe toward rear and free from muffler. Move muffler toward rear and remove.

5. *Install replacement muffler and insert exhaust pipe.*

6. *Connect tail pipe to muffler.*

7. *Tighten muffler to exhaust pipe clamp bolt.*

8. *Install muffler to tail pipe clamp bolt.*

9. *Install tail pipe support clamp bolt.*

(3) TAIL PIPE.

(a) Equipment.

WRENCH, end, $\frac{1}{2}$ -in.

WRENCH, end, $\frac{9}{16}$ -in.

(b) Procedure.

1. *Remove muffler to tail pipe clamp bolt.*

WRENCH, end, $\frac{9}{16}$ -in.

Remove clamp bolt to tail pipe at muffler.

2. *Remove tail pipe support bracket clamp bolt.*

WRENCH, end, $\frac{1}{2}$ -in.

Remove clamp bolt in tail pipe support bracket.

3. *Remove tail pipe.*

4. *Install replacement tail pipe.*

5. *Install tail pipe support bracket clamp bolt.*

6. *Install muffler to tail pipe clamp bolt.*

**BASIC HALF-TRACK VEHICLES (IHC) (PERSONNEL CARRIER M5, CAR M9A1,
MULTIPLE GUN MOTOR CARRIAGE M14, AND SIMILAR IHC VEHICLES)**

Section XIX

FRAME

	Paragraph
Frame	122
Pintle and tow hooks	123
Roller	124

122. FRAME.

a. The chassis frame consists of reenforced channel sections and reenforced cross members.

123. PINTLE AND TOW HOOKS (figs. 225 and 226).

a. Towing facilities are provided at the front by towing hooks, one at each front corner. Safety chain eyebolts are located at the rear of the frame between the bumperettes. A pintle hook is provided at the rear of the frame.

124. ROLLER (fig. 227).

a. **Description.** Some of the Half-track M5 and M9A1 Vehicles are equipped with a roller at the front of the frame. Its purpose is to

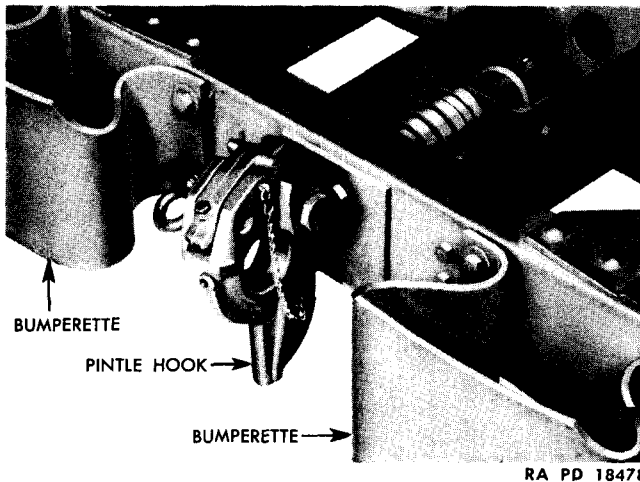
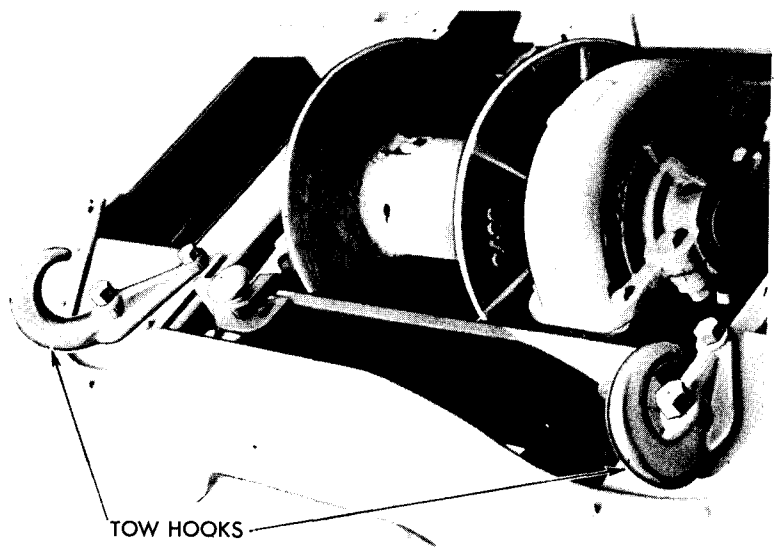

Figure 225 – Pintle Hook and Bumperettes – Installed

FRAME



RA PD 18479

Figure 226 — Tow Hooks — Installed

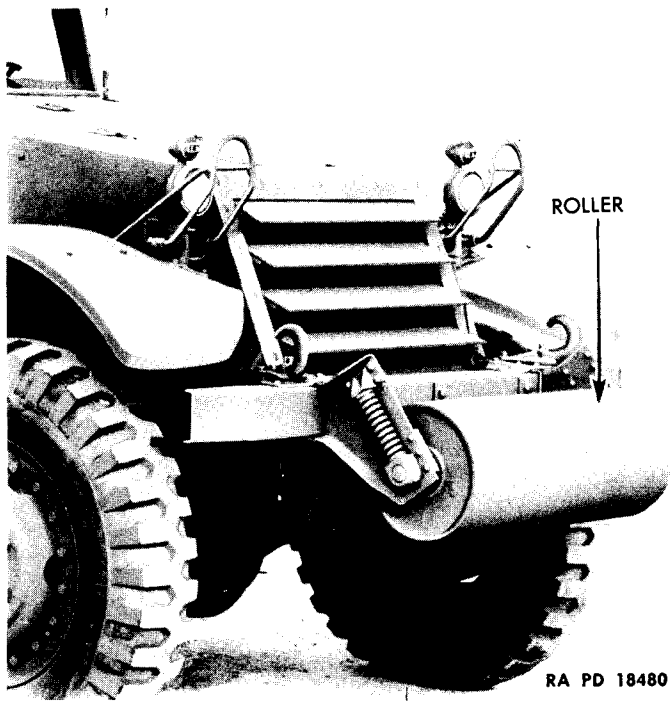

RA PD 18480

Figure 227 — Roller — Installed

BASIC HALF-TRACK VEHICLES (IHC) (PERSONNEL CARRIER M5, CAR M9A1, MULTIPLE GUN MOTOR CARRIAGE M14, AND SIMILAR IHC VEHICLES)

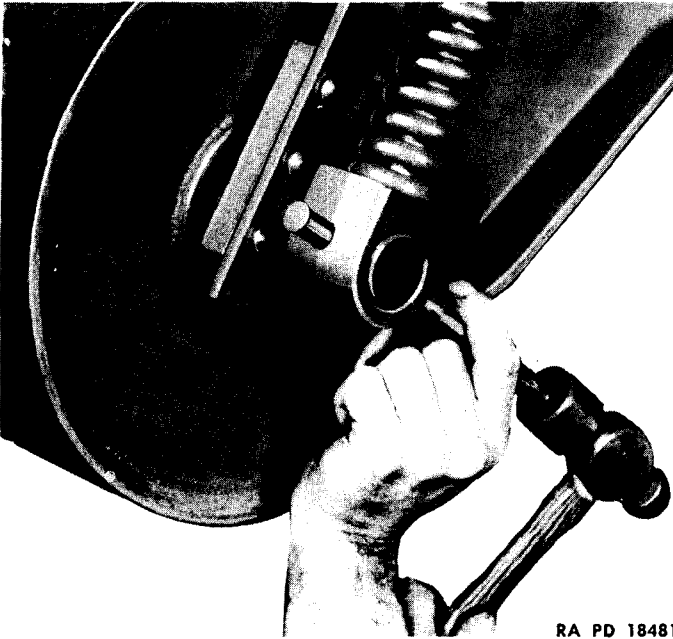

RA PD 18481

Figure 228 – Roller Shaft Taper Pins – Removal

assist in maneuvering through ditches and holes. Two compression springs, mounted on the roller supports, act as shock absorbers. The balance of the vehicles are equipped with winches as described in section III.

b. Roller Replacement. Should the roller become damaged, it can be replaced as follows:

(1) **EQUIPMENT.**

CLAMP, C- (2)
HAMMER

JACK
PUNCH

(2) **PROCEDURE.**

(a) Remove roller shaft taper pins (fig. 228).

HAMMER

PUNCH

Remove one taper pin from each end of roller shaft, using hammer and punch.

FRAME

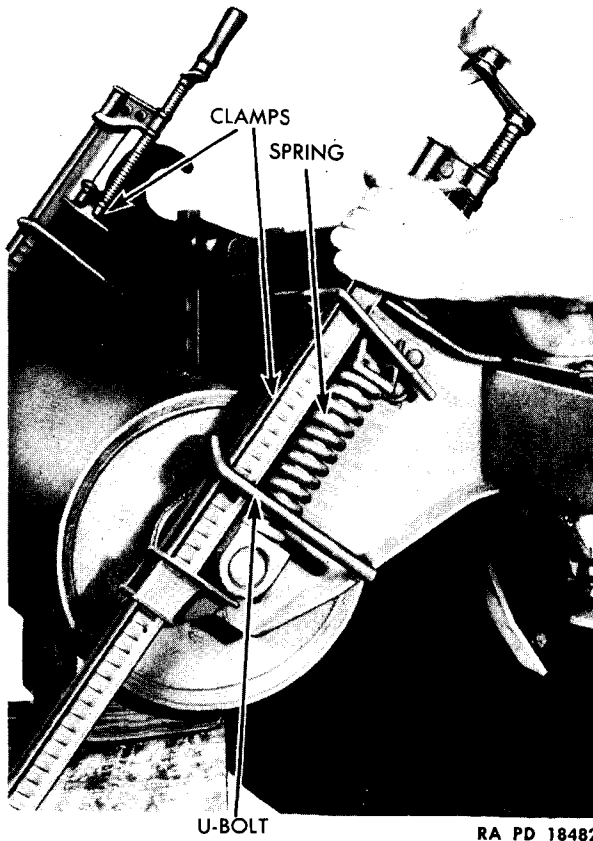

Figure 229 – Compressing Roller Springs

(b) *Compress Roller Springs.*

CLAMP, C- (2)

Using carpenters' clamps or large C-clamps, compress roller springs to take weight off roller shaft (fig. 229).

(c) *Remove Roller Shaft.*

HAMMER

JACK

Place jack under roller for support. Remove roller shaft from roller (fig. 230).

(d) *Lower Roller and Remove Jack.*

(e) *Release Clamps on Springs and Remove.*

(f) *Install Springs and Roller Supports to Replacement Roller with Clamps.*

**BASIC HALF-TRACK VEHICLES (IHC) (PERSONNEL CARRIER M5, CAR M9A1,
MULTIPLE GUN MOTOR CARRIAGE M14, AND SIMILAR IHC VEHICLES)**

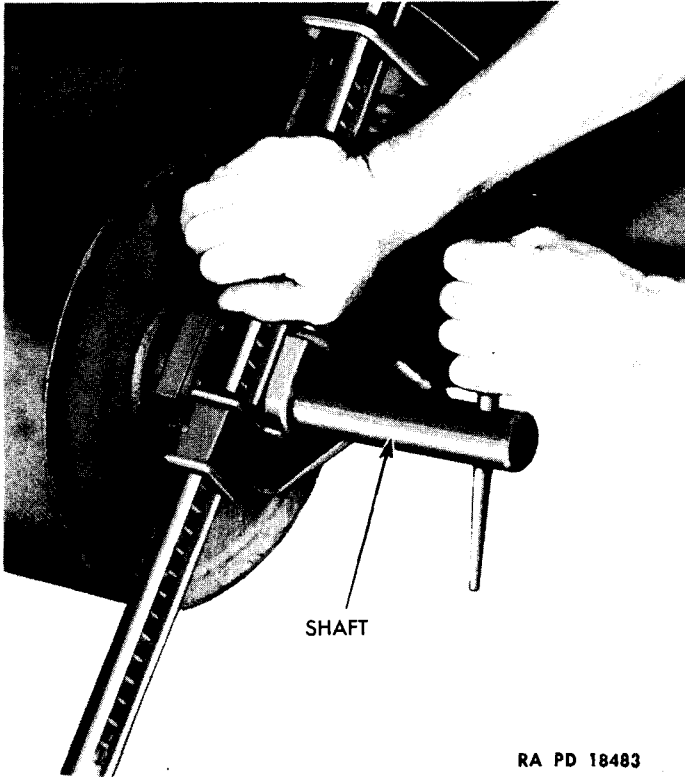

Figure 230 – Roller Shaft – Removal

- (g) Raise Roller into Position on Jacks.*
- (h) Insert Roller Shaft and Line up Taper Pin Holes.*
- (i) Insert Taper Pins.*
- (j) Remove Clamps and Jacks.*

Section XX

FUEL SYSTEM

	Paragraph
Description	125
Trouble shooting	126
Fuel tanks	127
Fuel and vacuum pump.....	128
Filter	129
Carburetor	130
Air cleaner	131

125. DESCRIPTION (fig. 231).

a. The air-fuel system consists of two main fuel tanks, fuel lines, a transfer and shut-off valve, a fuel and vacuum pump, fuel filter, carburetor, air cleaner, throttle controls, and engine manifold. Flexible connections are provided from the tanks to the anchored fuel lines and from the anchored lines to the fuel pump to prevent breakage from vibration.

(1) OPERATION. The fuel take-off from each of the tanks is through the transfer shut-off valve behind the driver's seat where one tank or the other may be selected for the supply of fuel.

(2) CAPACITY. Total capacity of the system is 60 gallons.

126. TROUBLE SHOOTING.

a. Many symptoms which might be attributed to the air-fuel system are, in reality, due to faulty ignition. Before attempting any but the obviously required adjustments to the air-fuel system, check the ignition system thoroughly (par. 85).

(1) FUEL.

(a) *Supply.* The fuel supply should be checked regularly. If fuel gage is inaccurate, use dip stick. If the engine has stopped by reason of a lack of fuel resulting from empty tanks, the fuel supply should be replenished and the engine cranked for about 15 seconds with the ignition turned off and choke pulled out. This will draw fuel into the pump and into the carburetor.

(b) *Impurities.* If the engine does not start, the reason may be water, dirt, or ice in the fuel system. This will be observed in the fuel pump sediment bowl and in the filter settling bowl. Clean the strainers

BASIC HALF-TRACK VEHICLES (IHC) (PERSONNEL CARRIER M5, CAR M9A1,
MULTIPLE GUN MOTOR CARRIAGE M14, AND SIMILAR IHC VEHICLES)

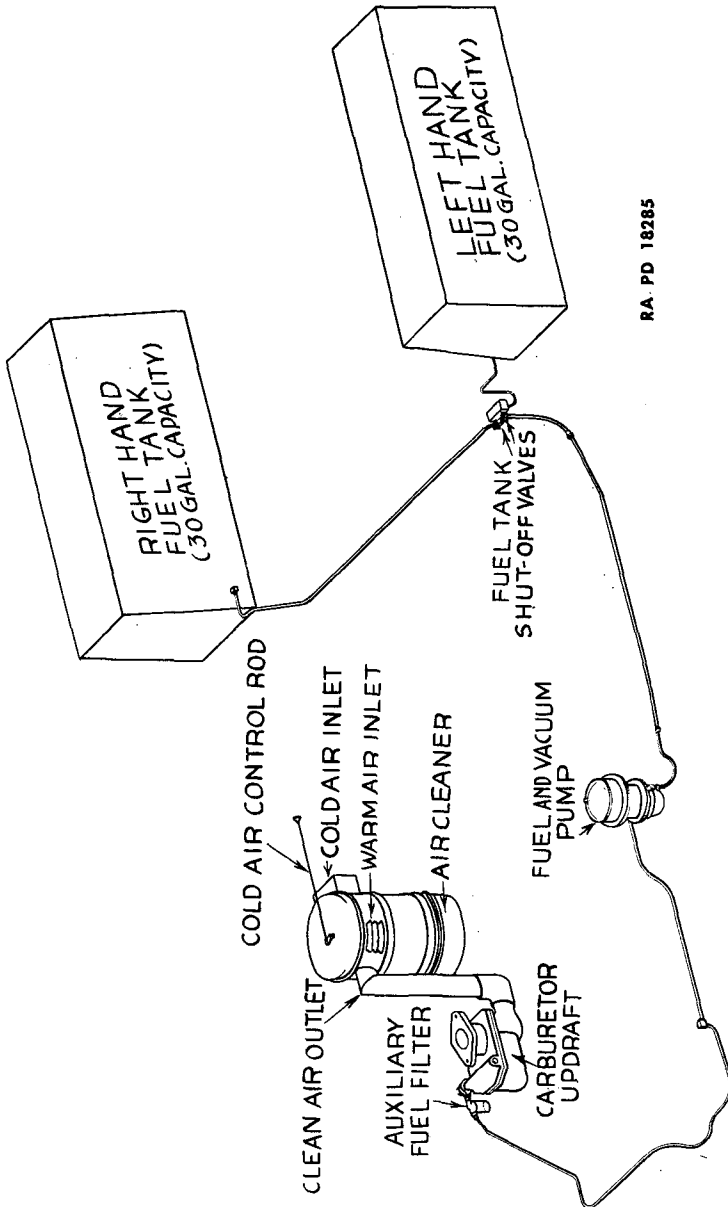

Figure 231 — Schematic Diagram of Fuel System

FUEL SYSTEM

in the fuel pump and filter and empty the settling bowls. Drain fuel from the fuel tanks until the fuel flows free of impurities. Disconnect both ends of fuel lines and blow out with air. (Condensation of water vapor from the atmosphere may be in part avoided by keeping fuel tanks full.) If ice is found, heat the parts with boiling water before cleaning. Water in the fuel tanks forms from the condensation of moisture in the air which is drawn into the tank as the fuel is used. It accumulates more rapidly in cold, damp weather and when the tanks are relatively empty of fuel.

(2) CARBURETOR.

(a) *Flooding.* Excessive use of the choke during cranking results in flooding the cylinders and prevents starting. A noticeable odor of gasoline, or dripping at the carburetor will usually indicate a flooded condition. To remedy a flooded condition, push in the choke, close the ignition switch, open the throttle wide (do not pump) and crank the engine for about 10 seconds. Turn on ignition, and when the engine starts, partly close the throttle and do not use the choke again unless it is necessary to keep the engine from stalling. If the carburetor still drips, tap it sharply or remove the cover of the float chamber and clean out dirt. If this fails, replace the carburetor (par. 130).

(b) *Choke Valve Setting.* If the engine will not start after cranking for several seconds with the choke pulled out and while ignition is satisfactory, the choke valve may not be closing completely. Examine the choke valve at the carburetor when the choke button is pulled out all the way. If the valve has not closed, change the setting of the choke control so that the valve closes.

(c) *Hissing Sound at Carburetor.* If a hissing sound is not heard in the carburetor when cranking with the choke out, a lack of gasoline is indicated in the carburetor. Test by disconnecting the fuel supply line at the filter. With ignition turned off, crank motor. If there is not a steady flow of fuel from the fuel line, the trouble must be traced back through the fuel system. If the flow of fuel is ample, the trouble is in the carburetor, and the unit should be replaced (par. 130).

(d) *Mixture.* If the engine runs irregularly at idling speed, or black smoke appears in the exhaust, it indicates that the carburetor mixture is too rich. Dry soot in the shell or porcelain near the points of the spark plugs also indicates too rich a mixture. If a warm engine backfires into the carburetor when accelerating or when the vehicle is running downhill in gear, the air-fuel mixture may be too lean. Spark plugs having a light straw color on the porcelain also indicate this condition. Excessive spark plug point burning indicates a lean mixture or the wrong type spark plug. Adjust the carburetor to remedy the complaint

BASIC HALF-TRACK VEHICLES (IHC) (PERSONNEL CARRIER M5, CAR M9A1, MULTIPLE GUN MOTOR CARRIAGE M14, AND SIMILAR IHC VEHICLES)

of too rich or too lean idle speed mixture using a vacuum gage (par. 130). Summer driving requires a different adjustment from winter driving. A dirty air cleaner causes a rich mixture and a loss of power.

(3) FUEL PUMP.

(a) *No Fuel.* Disconnect the fuel line at the carburetor. With the ignition turned off, crank the engine. If no fuel appears, the trouble may be in the supply line, pump, or strainers. Examine the tubing for kinks and leaks and check strainer bowl for sediment. Clean if necessary. Replace gasket and assure a tight and leakproof connection. Disconnect the fuel line from the tank at the fuel pump. Apply air to fuel tank to test condition of fuel line and flow. If the fuel line is open and the connections are tight, the pump is defective and must be replaced (par. 128).

(b) *Leaks.* In case of leakage at the diaphragm, tighten the cover screws alternately and securely. Sometimes there appears to be a leak at the diaphragm, whereas the leak actually exists at one of the pipe fittings and the fuel runs down around the diaphragm flange. Leakage of fuel through the fuel pump body venthole, a worn or punctured diaphragm, loose diaphragm nut, or defective pull rod requires replacement of fuel pump. Complete disassembly of fuel pumps is not authorized for the using arms (par. 128).

(4) **MANIFOLD.** A steady whistling sound at the manifold indicates a leaky gasket, and irregular engine performance at idling speed generally results. While the engine is running, squirt oil around the inlet manifold gasket to locate the point where the whistling will cease. If defective gaskets are found they should be replaced (par. 109). Examine hose connections at the windshield wiper connections, brake vacuum cylinder and accessories for air leaks. Replace defective hose if encountered, and tighten hose connections.

(5) **CONTROLS.** Check for sticking linkage and frayed or defective controls when response to operation of accelerator and controls becomes unsatisfactory.

127. FUEL TANKS.

a. **Description.** Two fuel tanks of 30 gallons capacity each are provided for this vehicle. Both tanks are within the body and are further protected by a bullet-sealing covering. The filler caps are readily accessible from the personnel compartment. Special screens are provided as flame arresters and must be removed and cleaned occasionally. The

FUEL SYSTEM

filler caps must be kept tightly closed and the breather valves kept open. A drain plug is recessed into the bottom of each tank. Should continual removal and replacement of this plug cause the threads to wear in the sump and result in a loose fit, replace plug with a 1/4-inch pipe plug having a 3/8-inch square head.

b. Fuel Tank Removal and Replacement.

(1) **EQUIPMENT.**

SCREWDRIVER	WRENCH, end, 1/2-in.
WRENCH, end, 1 1/32-in.	WRENCH, end, 1/16-in.
WRENCH, end, 7/16-in.	WRENCH, end, 5/8-in.

(2) **PROCEDURE.**

(a) *Drain Fuel Tank.*

WRENCH, end, 5/8-in.

Drain fuel tank by removing the drain plug from the fuel tank sump located at the bottom of the fuel tank. This drain plug is accessible through a hole in the under side of the track housing.

(b) *Remove Fuel Line Protection Shield.*

SCREWDRIVER WRENCH, end, 7/16-in.

Remove four fuel line protection shield slotted screws, and nuts and washers. Remove shield.

(c) *Disconnect Fuel Line Connection.*

WRENCH, end, 1/2-in.

Disconnect fuel line connection of fuel tank.

(d) *Loosen Fuel Tank Shield at Top.*

SCREWDRIVER

Remove three screws from top of fuel tank shield.

(e) *Loosen Fuel Tank Shield at Bottom.*

WRENCH, end, 1/16-in.

Remove three mounting screw nuts from the bottom of the fuel tank shield. If necessary hold screws at under side of track housing.

(f) *Remove Shield.*

(g) *Disconnect Ground Strap.*

SCREWDRIVER

Remove from fuel tank screw which holds ground strap. This is accessible through under side of track housing.

BASIC HALF-TRACK VEHICLES (IHC) (PERSONNEL CARRIER M5, CAR M9A1,
MULTIPLE GUN MOTOR CARRIAGE M14, AND SIMILAR IHC VEHICLES)

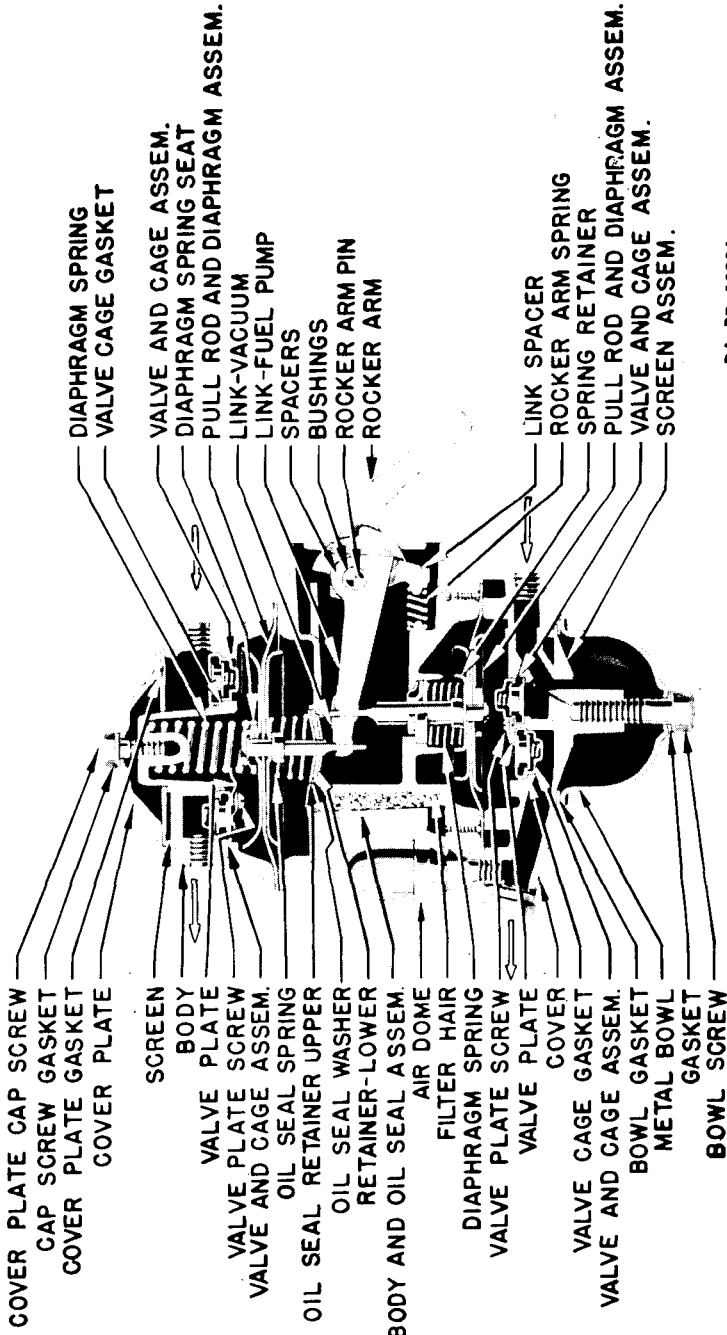

RA PD 18286

Figure 232 — Fuel and Vacuum Pump — Sectionalized

FUEL SYSTEM

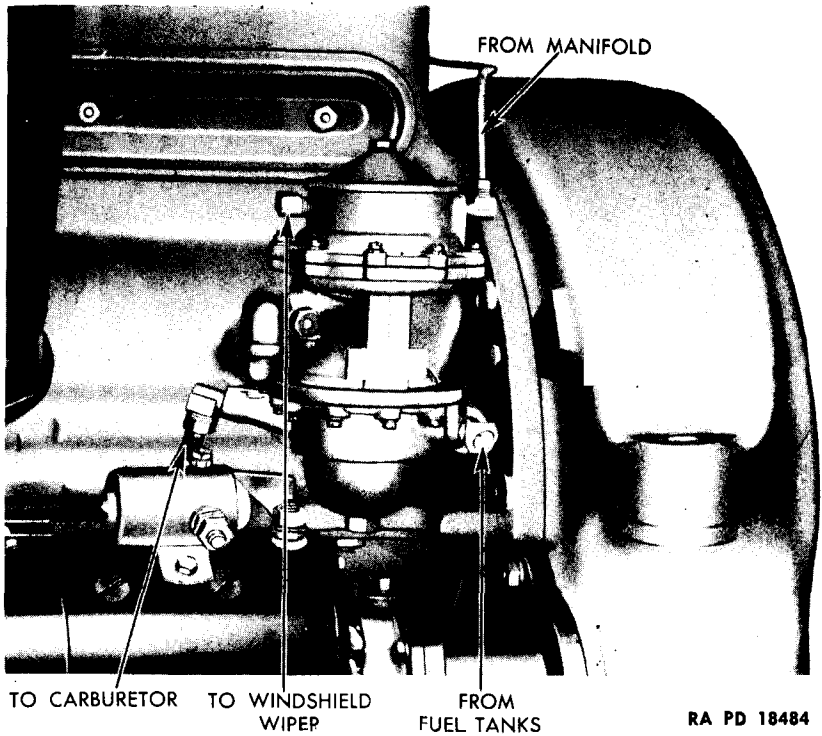

RA PD 18484

Figure 233 – Fuel and Vacuum Pump – Installed

(h) *Disconnect Fuel Gage Sender Wire at Tank.*

WRENCH, end, $1\frac{1}{32}$ -in.

Disconnect fuel gage tank unit sender wire from top of tank.

(i) *Remove Fuel Tank.*

(j) *Install Replacement Fuel Tank.*

(k) *Connect Fuel Gage Sender Wire.*

(l) *Connect Ground Strap.*

(m) *Install Fuel Tank Shield.*

(n) *Connect Fuel Tank Shield at Bottom.*

(o) *Connect Fuel Tank Shield at Top.*

(p) *Connect Fuel Line Connections.*

(q) *Install Fuel Line Protection Shield.*

(r) *Fill Fuel Tank.*

(s) *Test Fuel Tank Gage for Accuracy.*

**BASIC HALF-TRACK VEHICLES (IHC) (PERSONNEL CARRIER M5, CAR M9A1,
MULTIPLE GUN MOTOR CARRIAGE M14, AND SIMILAR IHC VEHICLES)**

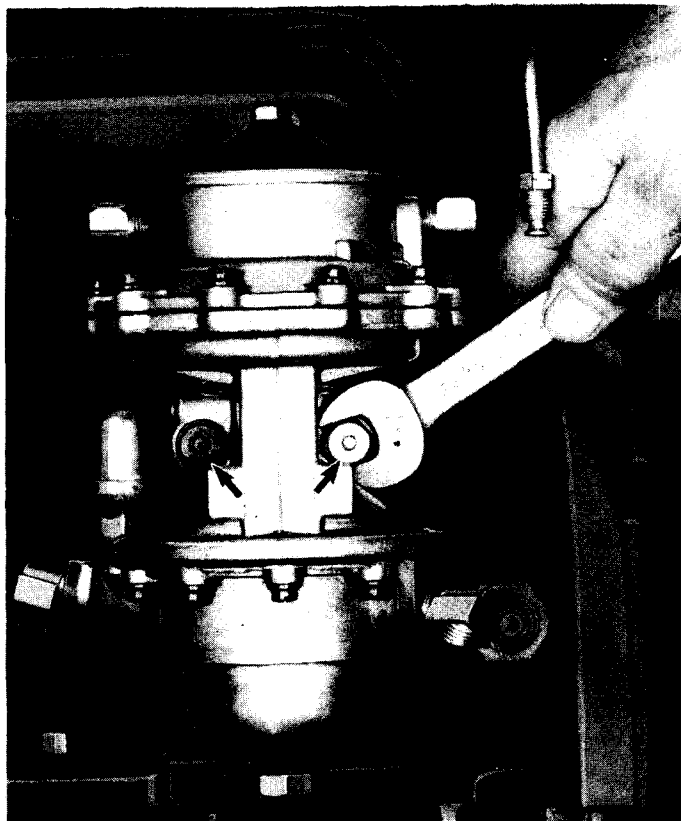

RA PD 18485

Figure 234 — Fuel Pump to Adapter Cap Screws — Removal

128. FUEL AND VACUUM PUMP (figs. 232 and 233).

a. Description. Fuel is drawn from the supply tanks and pumped to the carburetor by a mechanical, diaphragm-type, combination fuel and vacuum pump which is attached to the crankcase and is operated by an eccentric on the engine camshaft. The upper element of the pump is the vacuum section, and the lower element is the pump section. The vacuum section acts as a booster in the operation of the windshield wipers at open throttle when the inlet vacuum at the manifold is too low.

b. Fuel and Vacuum Pump Maintenance. The pump requires no adjustment within the scope of this text. Working parts are lubricated from the engine oil which comes through the opening in the crankcase. Vacuum and fuel line connector fittings should be checked regularly

FUEL SYSTEM



RA PD 18486

Figure 235 – Fuel Pump – Removal

for leaks. Body screws retaining the diaphragms must be kept tight to prevent air and fuel leaks, and the mounting screws must be tight. The metal sediment bowl may be removed for cleaning and for draining.

c. Fuel and Vacuum Pump Replacement. When the fuel pump fails to function properly, it should be replaced. Replacement procedure is as follows:

(1) **EQUIPMENT.**

WRENCH, end, $\frac{3}{8}$ -in.
WRENCH, end, $\frac{1}{2}$ -in.

WRENCH, end, $\frac{9}{16}$ -in.
WRENCH, end, $\frac{5}{8}$ -in.

(2) **PROCEDURE.**

(a) *Disconnect Fuel Line from Fuel Tank to Fuel Pump at Pump.*

WRENCH, end, $\frac{1}{2}$ -in. WRENCH, end, $\frac{5}{8}$ -in.

Disconnect fuel line at fuel pump after closing shut-off valve.

(b) *Disconnect Fuel Line to Carburetor at Fuel Pump.*

WRENCH, end, $\frac{1}{2}$ -in.

Disconnect fuel line to carburetor at fuel pump.

BASIC HALF-TRACK VEHICLES (IHC) (PERSONNEL CARRIER M5, CAR M9A1, MULTIPLE GUN MOTOR CARRIAGE M14, AND SIMILAR IHC VEHICLES)

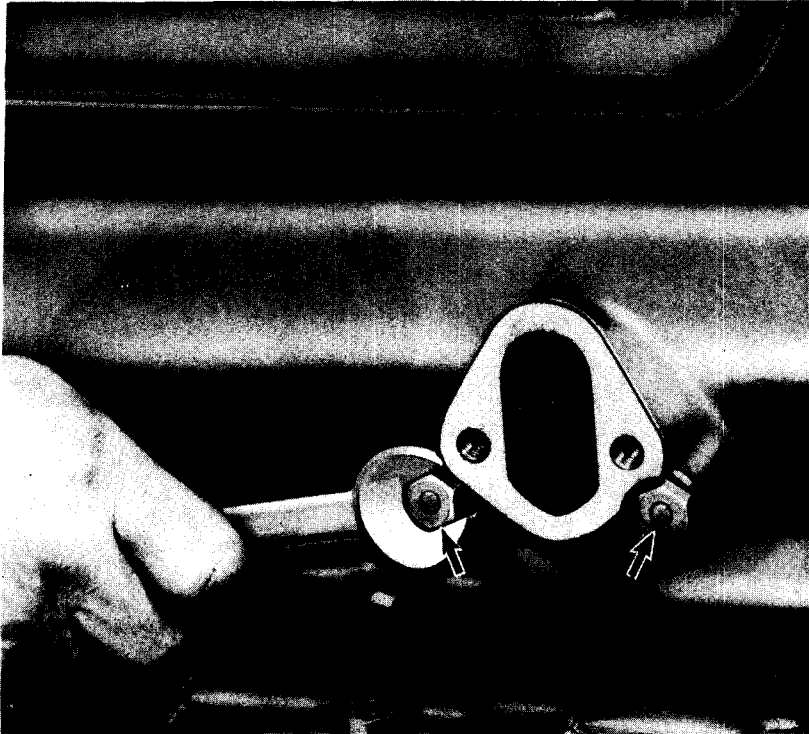

RA PD 18487

Figure 236 – Adapter to Crankcase Cap Screws – Removal

(c) *Disconnect Vacuum Lines at Fuel Pump.*

WRENCH, end, $\frac{3}{8}$ -in.

Disconnect vacuum lines at fuel pump to manifold and to windshield wipers.

(d) *Remove Fuel Pump to Adapter Mounting Cap Screws (fig. 234).*

WRENCH, end, $\frac{9}{16}$ -in.

Remove two cap screws holding fuel pump to adapter at crankcase.

(e) *Remove Fuel Pump (fig. 235).*

(f) *Remove Fuel Pump Adapter Cap Screws (fig. 236).*

WRENCH, end, $\frac{9}{16}$ -in.

Remove two cap screws holding fuel pump adapter to crankcase.

(g) *Remove Adapter with Plunger (fig. 237).*

(h) *Install New Gasket, Fuel Pump, Adapter, and Retaining Cap Screws.*

FUEL SYSTEM

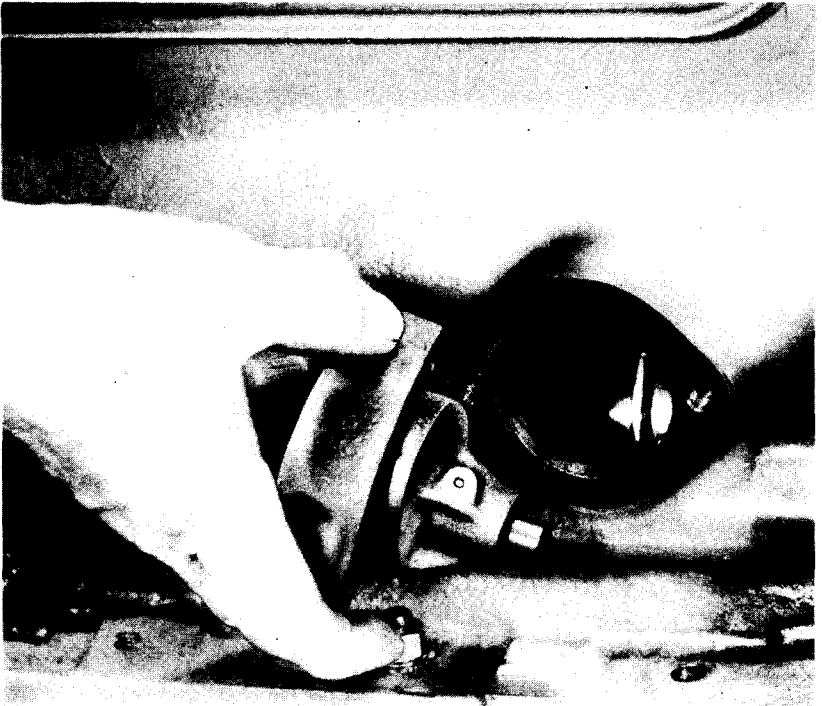

Figure 237 — Fuel Pump Adapter — Removal

RA PD 18488

- (i) Connect Fuel Line to Carburetor at Fuel Pump.
- (j) Connect Fuel Line to Fuel Tanks at Pump.
- (k) Connect Vacuum Line at Fuel Pump.
- (l) Open Shut-off Valve.

129. FILTER.

a. **Description.** A fuel filter is provided between the fuel pump and carburetor at the carburetor. Its purpose is to provide a settling bowl for sediment and water. Filtering is accomplished through a series of thin filtering disks.

b. **Filter Maintenance.** The fuel filter can be easily cleaned as follows:

- (1) PROCEDURE.
 - (a) Unscrew Settling Bowl Thumbscrew and Remove Bowl from Filter (fig. 238).
 - (b) Remove Filtering Element.
Unscrew element with fingers (fig. 239).

**BASIC HALF-TRACK VEHICLES (IHC) (PERSONNEL CARRIER M5, CAR M9A1,
MULTIPLE GUN MOTOR CARRIAGE M14, AND SIMILAR IHC VEHICLES)**

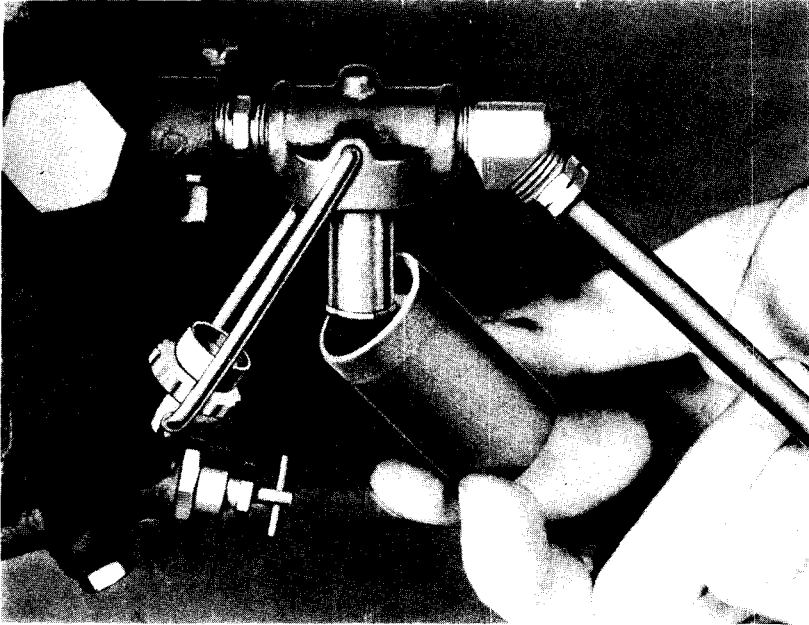

RA PD 18489

Figure 238 — Fuel Filter Bowl — Removal

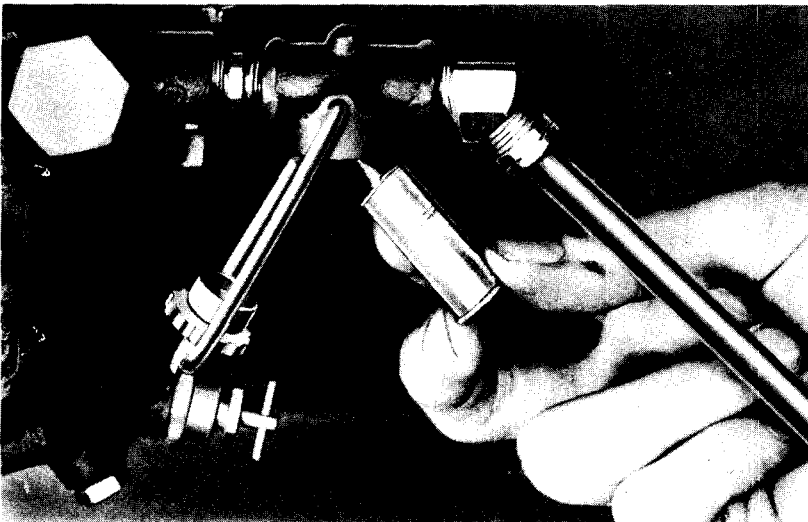

RA PD 18490

Figure 239 — Filtering Element — Removal

FUEL SYSTEM

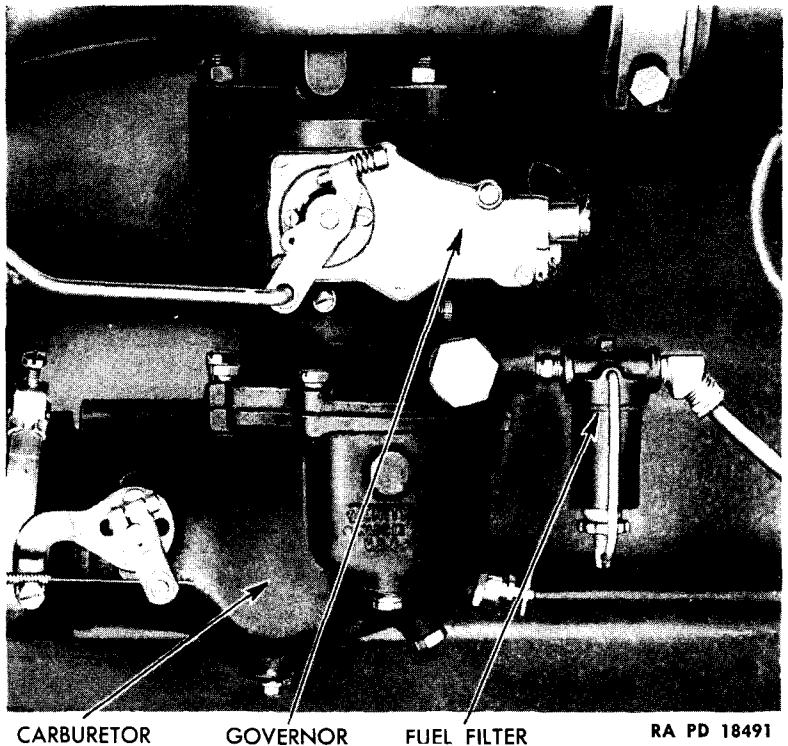

Figure 240 – Carburetor – Installed

- (c) *Remove Settling Bowl Gasket.*
- (d) *Wash Settling Bowl.*
- (e) *Clean Filtering Element.* Clean filtering element disks in gasoline.
- (f) *Install Filtering Element.*
Use fingers only.
- (g) *Install New Settling Bowl Gasket.*
- (h) *Install Settling Bowl and Tighten Thumbscrew.*

c. Fuel Filter Replacement.

(1) **EQUIPMENT.**

WRENCH, end, 1/2-in.

(2) **PROCEDURE.**

- (a) *Disconnect Fuel Line to Filter at Filter.*

WRENCH, end, 1/2-in.

Disconnect gas line at filter.

BASIC HALF-TRACK VEHICLES (IHC) (PERSONNEL CARRIER M5, CAR M9A1, MULTIPLE GUN MOTOR CARRIAGE M14, AND SIMILAR IHC VEHICLES)

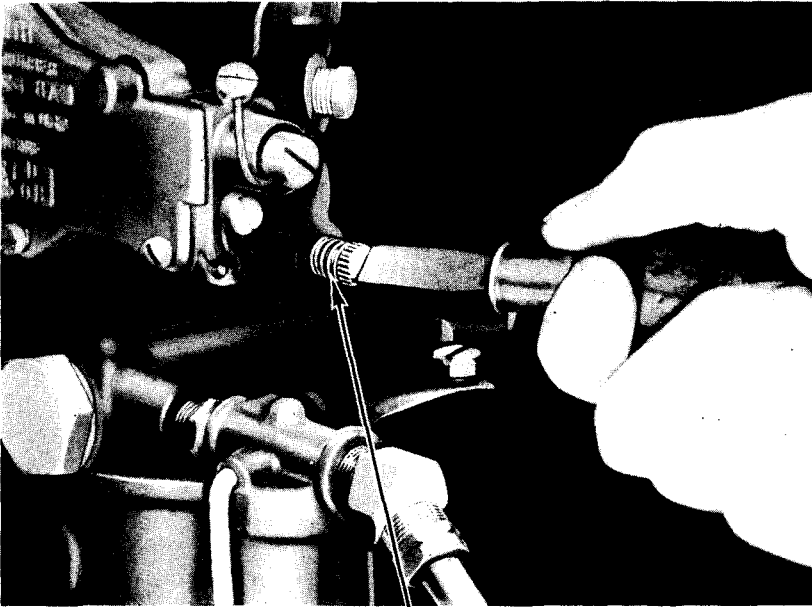

IDLE SCREW

RA PD 18492

Figure 241 – Adjusting Carburetor Idle Screw

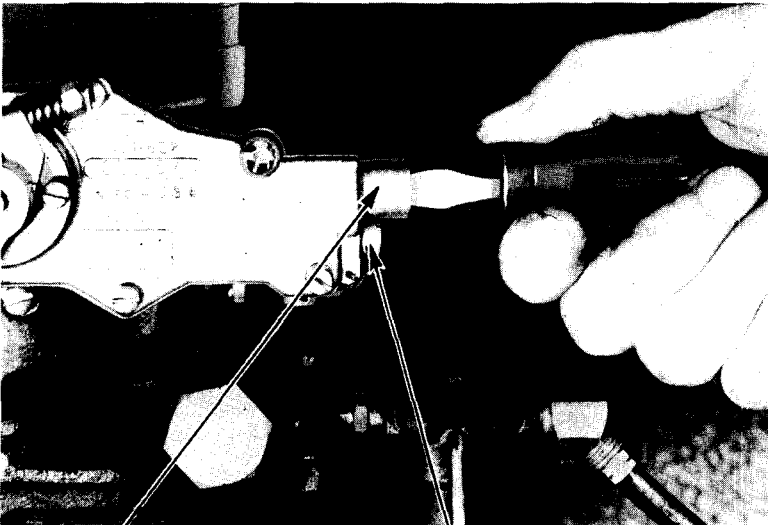

PRIMARY ADJUSTMENT

SECONDARY ADJUSTMENT

RA PD 18493

Figure 242 – Adjusting Governor – Primary Adjustment

FUEL SYSTEM

PRIMARY ADJUSTMENT

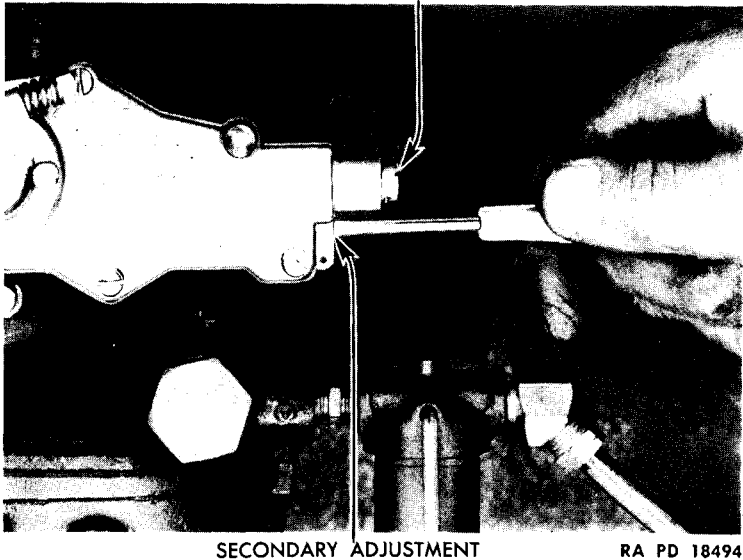

Figure 243 — Adjusting Governor — Secondary Adjustment

- (b) *Remove Filter.*
Unscrew fuel filter at carburetor.
- (c) *Install Replacement Fuel Filter.*
- (d) *Connect Fuel Line at Fuel Filter.*

130. CARBURETOR (fig. 240).

a. **Description.** The carburetor is an updraft unit of double-venturi design. It is of balanced construction which maintains a proper depression ratio between the air intake and the fuel bowl. The carburetor incorporates an integral velocity type governor. Only the idling adjustment screw and the main jet are adjustable.

b. **Carburetor Maintenance and Adjustment.** The carburetor needs but very little attention if properly installed. To prevent air leaks, however, a check should be made frequently to assure all connections being tight.

(1) **IDLING** (fig. 241). Engine should be at operating temperature of approximately 160 F before adjusting idle speed of carburetor. Adjustment should be made in conjunction with a vacuum gage. Connect vacuum gage at manifold and adjust idle adjustment screw to give highest steady gage reading at approximately 350 to 400 revolutions per minute.

BASIC HALF-TRACK VEHICLES (IHC) (PERSONNEL CARRIER M5, CAR M9A1, MULTIPLE GUN MOTOR CARRIAGE M14, AND SIMILAR IHC VEHICLES)

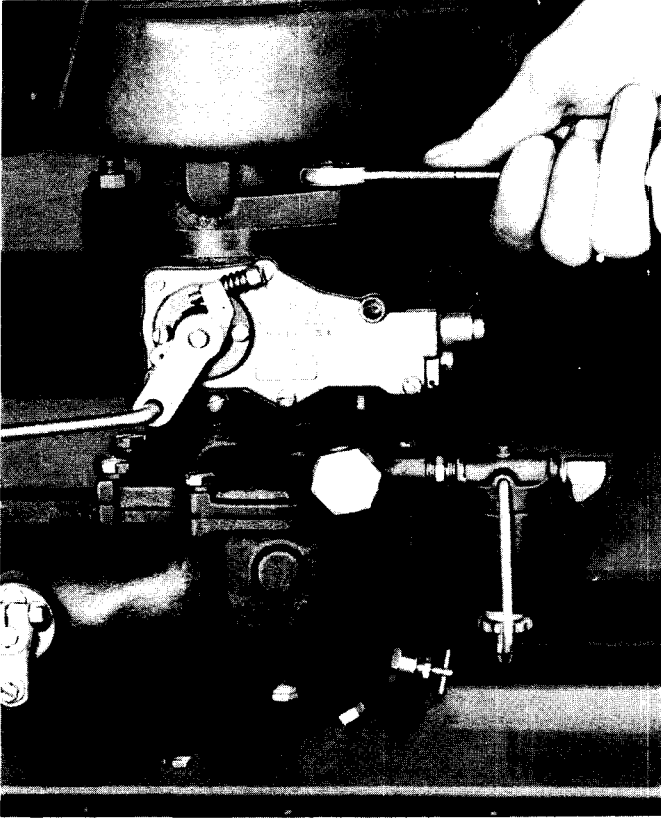

RA PD 18459

Figure 244 – Carburetor Mounting Nuts – Removal

(2) **CHOKE.** The choke wire control should be checked to see that the choke valve is fully open when the choke control button is in against the instrument panel, and fully closed when the button is pulled out. This can be checked by removing air connection elbow at carburetor. Adjust with screwdriver at choke lever.

(3) **GOVERNOR ADJUSTMENT.** There are two adjustment screws for the governor. Primary (upper screw) and secondary (lower screw) adjustment are as follows and only a screwdriver and a pair of pliers are required:

(a) *Primary Adjustment (Upper Screw)* (fig. 242).

1. Remove governor seal and seal wire.
2. Remove screw plug.
3. To increase speed, turn adjustment screw clockwise.

FUEL SYSTEM

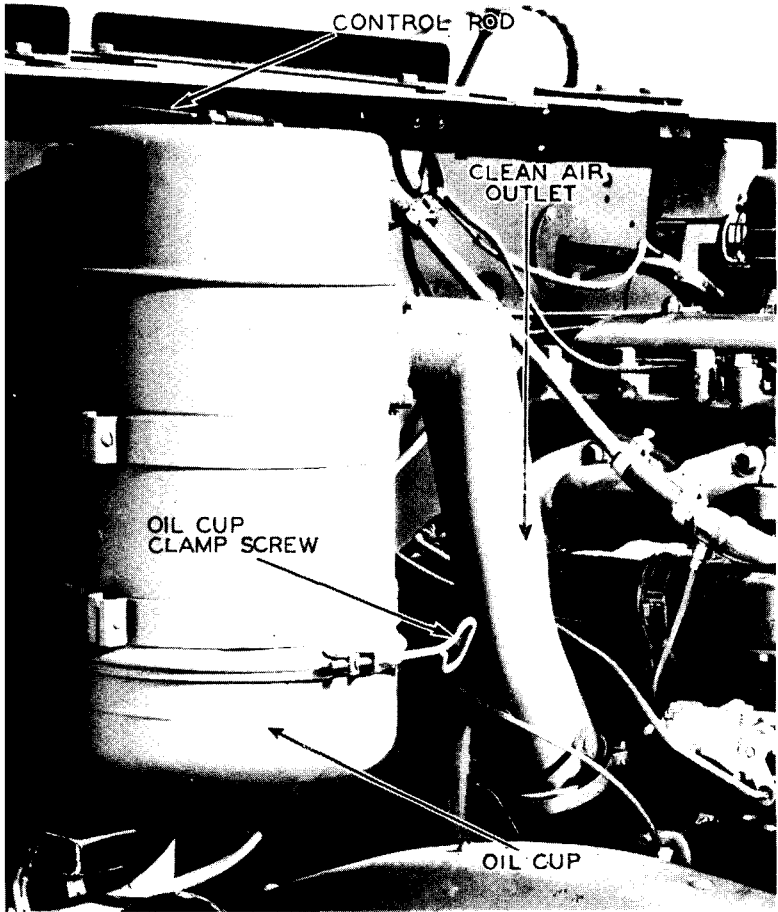

RA PD 18287

Figure 245 – Air Cleaner – Installed

4. To decrease speed, turn adjustment screw counterclockwise.
5. Replace screw plug.
6. Install new seal wire and seal.

(b) Secondary Adjustment (Lower Screw).

If surge is encountered or it is desired to lower the governed speed to less than approximately 25 miles per hour, it may be necessary to:

1. Remove seal wire.
2. Remove screw plug.
3. Adjust secondary adjustment screw (fig. 243). Turn secondary adjustment screw (inside) by turning counterclockwise one-half turn at

BASIC HALF-TRACK VEHICLES (IHC) (PERSONNEL CARRIER M5, CAR M9A1, MULTIPLE GUN MOTOR CARRIAGE M14, AND SIMILAR IHC VEHICLES)

a time until surge is remedied. If the governor does not regulate the governed speed closely enough, turn the adjustment screw clockwise one-half turn at a time until surge results and then one-half turn counterclockwise to eliminate surge.

4. *Replace screw plug and seal wire.*

c. **Carburetor Replacement.** When the carburetor or governor fails to operate properly and fails to respond to adjustments, replacement should be made as follows:

(1) **EQUIPMENT.**

PLIERS

WRENCH, end, 1/2-in.

SCREWDRIVER

WRENCH, end, 5/8-in.

(2) **PROCEDURE.**

(a) *Disconnect Air Cleaner Elbow at Carburetor.*

SCREWDRIVER

Disconnect air cleaner at carburetor.

(b) *Disconnect Control Linkage.*

SCREWDRIVER

Disconnect choke control and throttle control linkage at carburetor.

(c) *Disconnect Gas Line at Carburetor.*

WRENCH, end, 1/2-in.

Disconnect fuel line and filter at carburetor.

(d) *Remove Carburetor (fig. 244).*

WRENCH, end, 5/8-in.

Remove two nuts holding carburetor to manifold. Remove carburetor and insulator. Remove gasket.

(e) *Install New Gasket.*

(f) *Install Carburetor and Insulator.*

Install nuts.

(g) *Connect Fuel Line and Filter to Carburetor.*

(h) *Connect Choke and Throttle Control Linkage.*

(i) *Connect Air Cleaner Elbow at Carburetor.*

(j) *Adjust Carburetor Idle.*

Have engine at operating temperature and adjust idle speed as outlined in subparagraph b (1), above.

(k) *Adjust Governor if Necessary.*

Procedure is outlined in subparagraph b (3), above.

FUEL SYSTEM

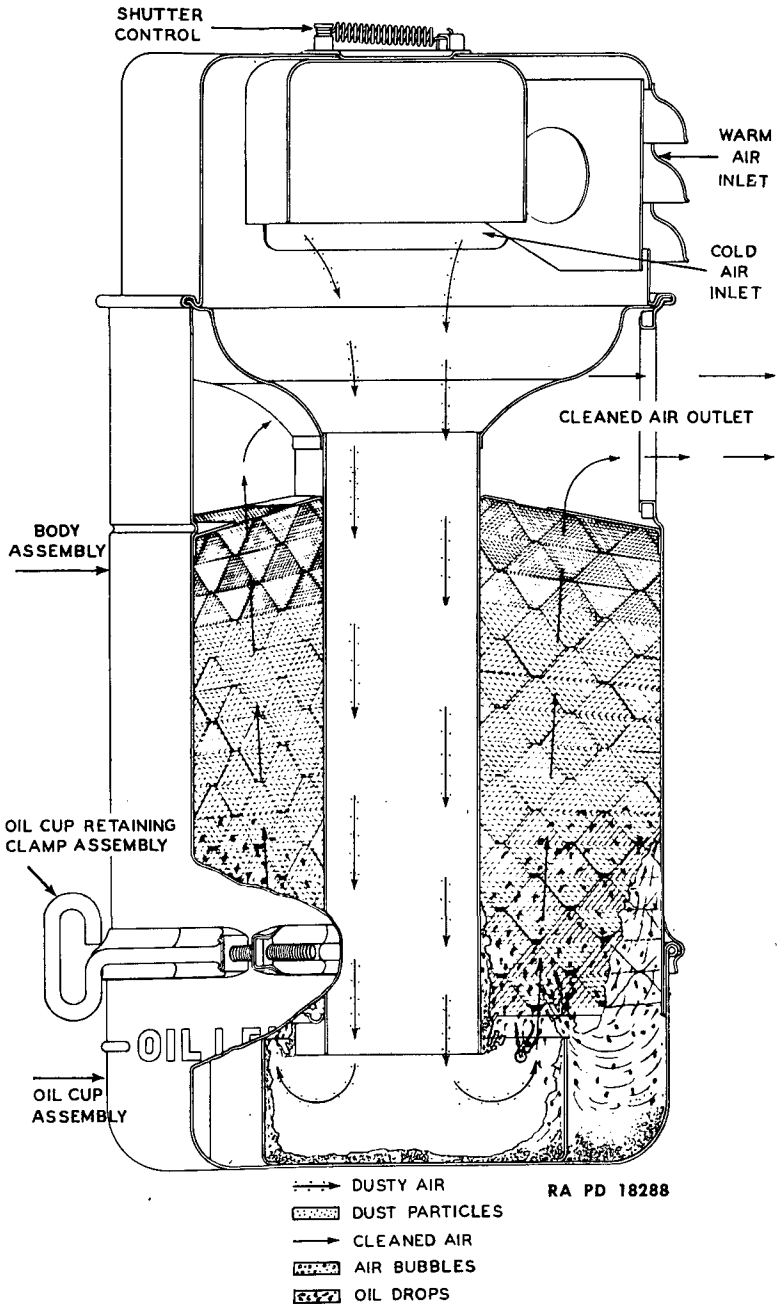

Figure 246 — Air Cleaner — Sectionalized

BASIC HALF-TRACK VEHICLES (IHC) (PERSONNEL CARRIER M5, CAR M9A1, MULTIPLE GUN MOTOR CARRIAGE M14, AND SIMILAR IHC VEHICLES)**131. AIR CLEANER** (figs. 245 and 246).

a. **Description.** The air cleaner is of oil bath type and is dash mounted. A connection is also provided to permit drawing cool air from the driver's compartment and shutting off the warm air inlet from the engine at the air cleaner.

b. **Air Cleaner Maintenance.** The oil and sludge level in the cup should be checked at least once a week, preferably daily, by loosening the clamp and lowering the cup to note the oil level in reference to the oil level indicating bead. Accumulation of dirt should not exceed $\frac{1}{2}$ inch. Oil level should be maintained at indicating level bead in cup. The reservoir should be cleaned thoroughly and refilled with fresh oil each time the crankcase is drained and refilled. The capacity of the oil reservoir is $3\frac{3}{4}$ pints. Oil similar to that in the crankcase should be used in the air cleaner reservoir. The air cleaner should be removed from the dash occasionally, washed in kerosene, and blown out. The foregoing instructions cover the care of air cleaner when conditions are normal. When the air is laden with large quantities of dust and dirt, the recommended attention should be given at more frequent intervals. **NOTE:** Do not remove oil cup while engine is running.

c. **Air Cleaner Replacement.** When it is desirable to remove and replace air cleaner assembly, proceed as follows:

(1) **EQUIPMENT.**

PLIERS

WRENCH, end, $\frac{9}{16}$ -in.

SCREWDRIVER

(2) **PROCEDURE.**(a) *Disconnect Cab Air Shutter Control.*

PLIERS

Disconnect pull rod.

(b) *Disconnect Air Cleaner Elbow at Carburetor.*

SCREWDRIVER

Disconnect air cleaner elbow at carburetor.

(c) *Loosen Air Cleaner Clamp Mounting Screws.*

SCREWDRIVER

Loosen screws at mounting clamps.

(d) *Lift Air Cleaner out of Mounting Bands.*(e) *Install Air Cleaner Assembly.*(f) *Tighten Clamp Screws at Mounting Clamps.*(g) *Connect Air Cleaner Elbow at Carburetor.*(h) *Connect Cab Air Shutter Control.*

Section XXI

INSTRUMENTS AND GAGES

	Paragraph
Instruments	132
Instrument panel	133
Compass	134

132. INSTRUMENTS (figs. 247 and 248).

a. The various instruments and gages on this vehicle are mounted on an instrument panel. This panel serves as the cover to the protecting case or shield. Replacement of any of these gages or instruments requires removal of the panel from the shield case (par. 133). The various instruments and gages are as follows:

(1) **SPEEDOMETER.** The speedometer is of dial type graduated in miles per hour from 0 to 80 miles per hour. Total mileage of 99,999 miles and trip mileage from 0 to 100 miles are recorded on totalizers. The speedometer is driven by a flexible drive shaft. A flexible reset shaft is located at the instrument panel below the speedometer.

(a) *Speedometer Replacement.*

1. *Remove clamp bracket.* Remove two clamp wing nuts and washers. Remove bracket.
2. *Remove speedometer.* Remove speedometer to the front.
3. *Install replacement speedometer.* Install from the front.

(2) **TACHOMETER.** The tachometer is graduated to read in hundreds of engine revolutions per minute from 0 to 4,000 revolutions per minute. It also incorporates a revolution totalizer reading in thousands of engine revolutions.

(a) *Tachometer Replacement.*

1. *Remove clamp bracket.* Remove two clamp wing nuts and washers. Remove clamp bracket.
2. *Remove tachometer.* Remove tachometer from front.
3. *Install replacement tachometer.* Install from front.
4. *Install clamp bracket and clamp bracket wing nuts and washers.*

(3) **AMMETER.** The ammeter is graduated to read from minus 100 amperes to plus 100 amperes and is marked: -100, 50, 0, 50, and +100. Readings toward the minus sign (-) indicate total current discharge of the battery. Readings toward the plus sign (+) indicate the net cur-

BASIC HALF-TRACK VEHICLES (IHC) (PERSONNEL CARRIER M5, CAR M9A1,
MULTIPLE GUN MOTOR CARRIAGE M14, AND SIMILAR IHC VEHICLES)

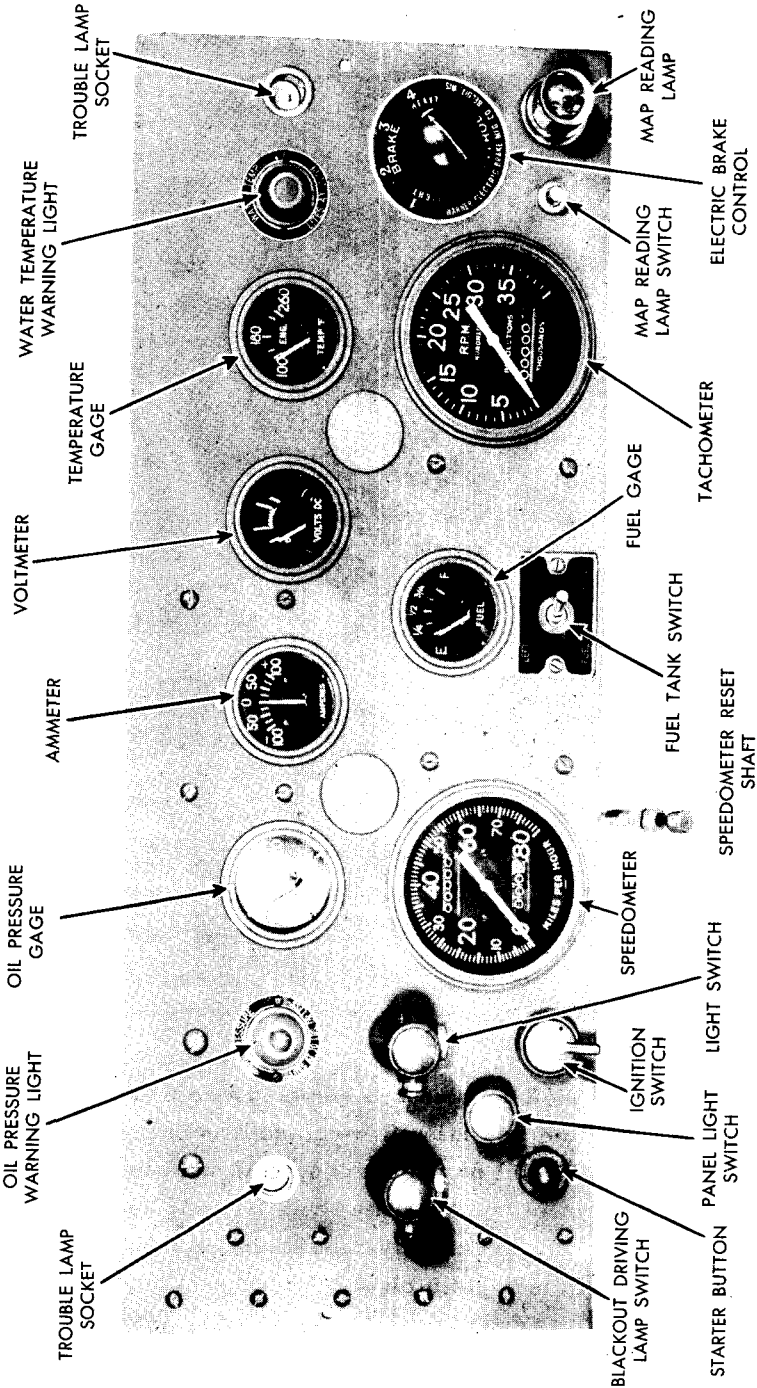

RA PD 18538

Figure 247 — Instrument Panel — Front

INSTRUMENTS AND GAGES

rent charge to the battery. The total output of the generator is not indicated by the ammeter readings.

(a) *Ammeter Replacement.*

1. *Disconnect wires.*

WRENCH, end, $\frac{3}{8}$ -in.

Remove nuts from two terminal posts at rear of ammeter. Disconnect wires.

2. *Remove clamp bracket.*

WRENCH, end, $\frac{3}{8}$ -in.

Remove two nuts from terminal posts retaining clamp bracket. Remove clamp bracket.

3. *Remove ammeter.* Remove ammeter from the front.
4. *Install replacement ammeter.*
5. *Install ammeter clamp bracket and retaining nuts.*
6. *Connect wires at terminal posts.*

(4) **VOLTMETER.** The voltmeter is dialed to indicate a normal range in direct-current volts.

(a) *Voltmeter Replacement.*

1. *Disconnect wires.*

WRENCH, end, $\frac{3}{8}$ -in.

2. *Remove voltmeter.*

WRENCH, end, $\frac{3}{8}$ -in.

Remove nuts from mounting bracket clamps. Remove voltmeter.

3. *Install replacement voltmeter and retaining clamps.*
4. *Connect wires.*

(5) **FUEL GAGE.** The fuel gage is dialed E (empty), $\frac{1}{4}$, $\frac{1}{2}$, $\frac{3}{4}$, F (full). A transfer switch permits checking on one gage the amount of fuel in either tank. The ignition switch must be in the "ON" position before readings can be taken.

(a) *Fuel Gage Replacement.*

1. *Disconnect ignition wires.*

WRENCH, end, $\frac{3}{8}$ -in.

Disconnect wires at terminal posts at rear of fuel gage.

2. *Remove clamp brackets.*

WRENCH, end, $\frac{3}{8}$ -in.

Remove two nuts from clamp brackets. Remove brackets.

BASIC HALF-TRACK VEHICLES (IHC) (PERSONNEL CARRIER M5, CAR M9A1,
MULTIPLE GUN MOTOR CARRIAGE M14, AND SIMILAR IHC VEHICLES)

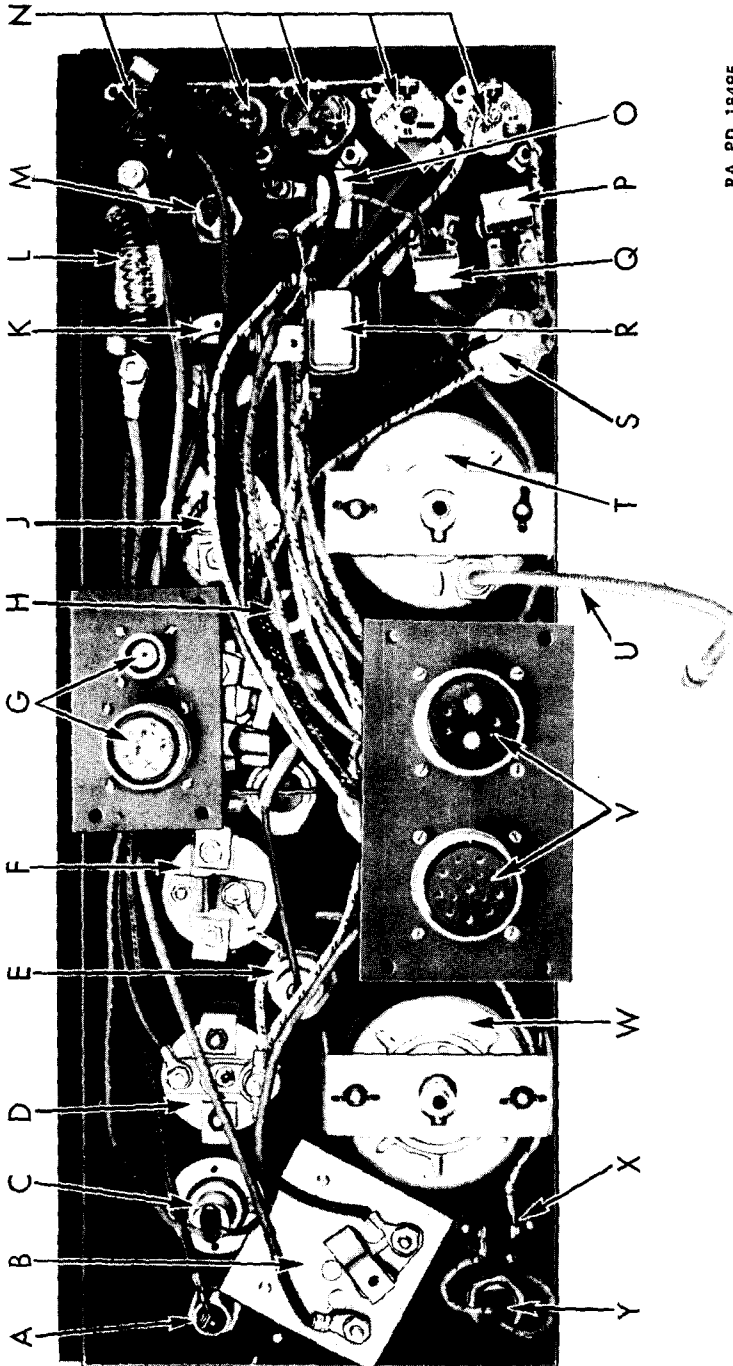

RA PD 18495

Figure 248 — Instrument Panel — Inside

INSTRUMENTS AND GAGES

A—INSPECTION LAMP SOCKET	N—CIRCUIT BREAKERS
B—BRAKE CONTROL RHEOSTAT	O—BLACKOUT DRIVING LAMP SWITCH
C—WATER TEMPERATURE WARNING LIGHT	P—STARTER SWITCH
D—WATER TEMPERATURE GAGE	Q—PANEL LIGHT SWITCH
E—PANEL LIGHT	R—SERVICE LIGHT SWITCH
F—VOLTMETER	S—IGNITION SWITCH
G—AMPHENOL PLUGS	T—SPEEDOMETER
H—PANEL LIGHT	U—SPEEDOMETER RESET SHAFT
J—OIL PRESSURE GAGE	V—AMPHENOL PLUGS
K—OIL PRESSURE WARNING LIGHT	W—TACHOMETER
L—BRAKE CONTROL RESISTOR	X—MAP READING LAMP SWITCH
M—INSPECTION LAMP SOCKET	Y—MAP READING LAMP

RA PD 18495 B

Legend for Figure 248 — Instrument Panel — Inside

BASIC HALF-TRACK VEHICLES (IHC) (PERSONNEL CARRIER M5, CAR M9A1, MULTIPLE GUN MOTOR CARRIAGE M14, AND SIMILAR IHC VEHICLES)

3. *Remove fuel gage.*
4. *Install replacement fuel gage.*
5. *Install clamp brackets and nuts.*
6. *Connect wires to terminal posts.*

(6) **OIL PRESSURE GAGE AND WARNING LIGHT.** The oil pressure gage is graduated in the range 0, 30, 60, 90, 120 pounds. A "tell-tale" or warning light is also mounted on the instrument panel which operates when the oil pressure is 10 pounds or less. At idle speed of the engine it is possible that the warning light will flicker or operate intermittently because condition of oil may cause pressure to be below the 10 pound minimum. This condition, at engine idle speed, need cause no concern as long as slightly increased engine speed will cause warning light to be extinguished, indicating presence of ample oil pressure.

(a) *Oil Gage Replacement.* The oil pressure gage can be removed and replaced as follows:

1. *Disconnect wires at gage.*

SCREWDRIVER

Disconnect wires.

2. *Remove gage retaining clamps.*

WRENCH, end, $\frac{3}{8}$ -in.

Remove nuts and lock washers from gage mounting clamp brackets. Remove brackets.

3. *Remove gage.*
4. *Install replacement gage.*
5. *Install gage mounting clamp brackets and nuts and washers.*
6. *Connect wires to gage.*

(7) **WATER TEMPERATURE GAGE.** The temperature gage is calibrated in the range 100, 180, and 260 F. There is also a warning light on the instrument panel which operates at 225 F.

(a) *Water Temperature Gage Removal.* The water temperature gage can be removed and replaced as follows:

1. *Disconnect wires at gage.*

SCREWDRIVER

Disconnect wires at back of gage.

2. *Remove gage mounting clamp brackets.*

WRENCH, end, $\frac{3}{8}$ -in.

INSTRUMENTS AND GAGES

Remove nuts and lock washers from the mounting clamp brackets. Remove mounting clamp brackets.

3. *Remove gage from panel.*
4. *Install replacement gage in panel.*
5. *Install gage mounting clamp brackets and nuts and lock washers.*
6. *Connect wires to gage.*

(8) **IGNITION SWITCH.** The ignition switch lever has two positions. In the vertical position, the ignition is "OFF." When turned toward the left, the ignition is "ON."

(a) *Ignition Switch Replacement.* The ignition switch can be removed and replaced as follows:

1. *Disconnect wires.*

SCREWDRIVER

Disconnect wires from switch.

2. *Remove switch lever.* Turn switch to "ON" position. Insert small wire into hole and press against spring. Turn switch further toward left while holding spring down with wire. Remove lever.

3. *Remove nut from switch.*

WRENCH, spanner, or PLIERS

Unscrew retaining nut from front of panel.

4. *Remove switch.*

5. *Install switch and retaining nut.*

6. *Install switch lever.* Insert assembly in horizontal position and turn down.

7. *Connect wires.*

(9) **INSTRUMENT LIGHT SWITCH.** The instrument light switch is a push-pull type and operates the instrument panel lights. In the "IN" position the lights are off. When the switch is pulled out, the instrument panel light will operate.

(a) *Light Switch Replacement.*

1. *Remove pull knob.*

SCREWDRIVER

Loosen screw in knob. Unscrew knob from switch.

2. *Disconnect wires.*

SCREWDRIVER

Disconnect wires from switch.

BASIC HALF-TRACK VEHICLES (IHC) (PERSONNEL CARRIER M5, CAR M9A1, MULTIPLE GUN MOTOR CARRIAGE M14, AND SIMILAR IHC VEHICLES)

3. *Remove switch.*

WRENCH, end, $\frac{9}{16}$ -in.

Remove retaining nut and washer. Remove switch.

4. *Install replacement switch and retaining nut and washer.*
5. *Connect wires to switch.*
6. *Install switch pull knob.*

(10) **ELECTRIC BRAKE LOAD CONTROL SWITCH.** A brake load control dial switch is mounted on the instrument panel. It is of rheostat type and is dialed: 1 (LIGHT), 2, 3, 4 (HEAVY), for providing proper load control of the electric brakes on the trailer (par. 68).

- (a) *Brake Control Switch Replacement.*

1. *Remove load control knob.*

SCREWDRIVER

Remove screw from knob. Remove knob.

2. *Disconnect wires.*

WRENCH, end, $\frac{7}{16}$ -in.

Remove nuts at terminal posts and disconnect wires.

3. *Remove load control switch.*

WRENCH, end, $\frac{9}{16}$ -in.

Remove nut and fiber washer from front of load control. Remove load control switch.

4. *Install replacement load control switch, washer, and nut.*
5. *Connect wires.*
6. *Install control knob.*

(11) **MAP READING LAMP.** A map reading lamp is provided and is operated by a push-pull type switch.

- (a) *Map Reading Lamp Replacement.*

1. *Disconnect wires.*

SCREWDRIVER

Disconnect wires at rear of lamp.

2. *Remove lamp.*

WRENCH, end, $1\frac{5}{16}$ -in.

Remove nut and lock washer from lamp. Remove lamp.

3. *Install replacement lamp and retaining nut and washer.*
4. *Connect wires at rear of lamp.*

INSTRUMENTS AND GAGES

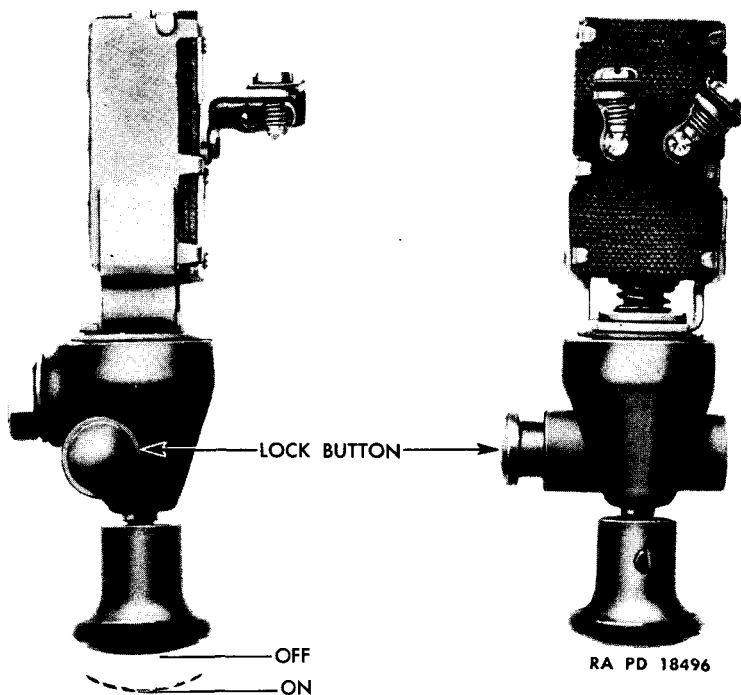

Figure 249 - Blackout Driving Light Switch Details

(12) TROUBLE-LAMP SOCKET. Two inspection lamp sockets are provided into which the trouble lamp can be connected.

(a) *Trouble-Lamp Socket Replacement.*

1. *Disconnect wires.*

SCREWDRIVER

Disconnect wire at rear of socket.

2. *Remove socket.*

WRENCH, end, $\frac{7}{8}$ -in.

Remove socket retaining nut and lock washer. Remove socket.

3. *Install replacement socket and retaining nut and washer.*

4. *Connect wire to socket.*

(13) BLACKOUT DRIVING LIGHT SWITCH (fig. 249). The blackout driving light switch has two positions. A thumb button must be depressed to permit pulling back on knob to operate the driving light.

(a) *Blackout Driving Light Switch Replacement.*

1. *Remove pull knob.*

SCREWDRIVER

Remove set screw attaching knob to switch. Unscrew knob.

BASIC HALF-TRACK VEHICLES (IHC) (PERSONNEL CARRIER M5, CAR M9A1, MULTIPLE GUN MOTOR CARRIAGE M14, AND SIMILAR IHC VEHICLES)

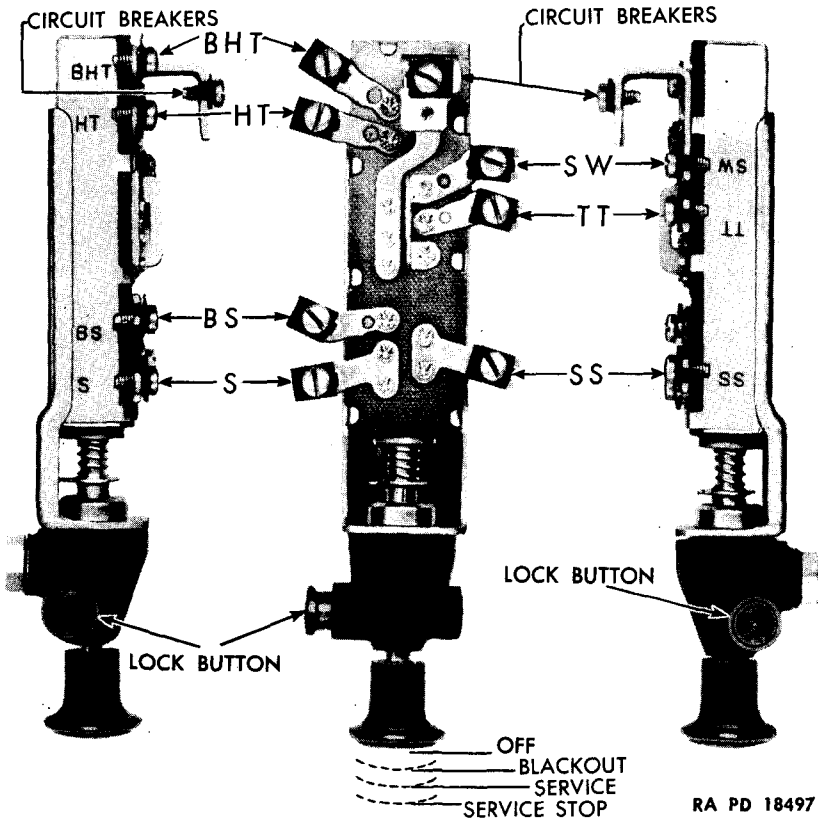

Figure 250 – Blackout Service Light Switch Details

2. Disconnect wires from switch.

SCREWDRIVER

Disconnect wires from rear of switch.

3. Remove switch mounting bushing.

WRENCH, end, 1/2-in.

Remove screw holding mounting bushing to switch. Remove mounting bushing from switch by pressing in on release button.

4. Remove switch.

WRENCH, 3/4-in.

Remove retaining nut and washer. Remove switch.

5. Install replacement switch, mounting bushing, retaining nut, and washer.

6. Install mounting bushing screw.

7. Install pull knob and setscrew.

8. Connect wires to switch.

INSTRUMENTS AND GAGES

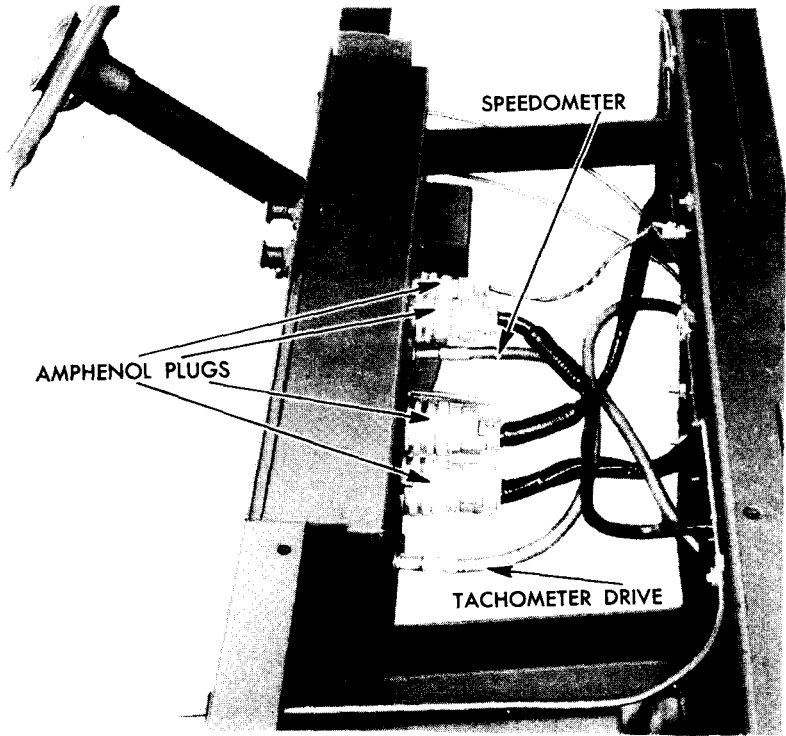

RA PD 18498

Figure 251 – Instrument Panel – Rear

(14) **BLACKOUT LIGHT SWITCH** (fig. 250). The blackout light switch which controls the headlights, taillights, and marker lights has four positions. When switch is against the instrument panel all lights are "OFF." The switch can be pulled back to the first position which will operate the blackout stop lights. Depressing the thumb button permits pulling the switch back to the next position where the service head and taillights and the service stop lights will operate. Pulling the switch back one more position will permit only stop lights to operate.

(a) *Blackout Light Switch Replacement.*

1. *Disconnect wires from switch.*

SCREWDRIVER

Tag and disconnect wires from switch. (For further description of wiring connections, see section XVI.)

2. *Remove pull knob.*

SCREWDRIVER

Remove set screw from pull knob. Unscrew and remove pull knob.

BASIC HALF-TRACK VEHICLES (IHC) (PERSONNEL CARRIER M5, CAR M9A1, MULTIPLE GUN MOTOR CARRIAGE M14, AND SIMILAR IHC VEHICLES)

3. *Remove lock-out control assembly.*

WRENCH, end, $\frac{9}{16}$ -in.

Remove retaining screw from lock-out control housing. Remove housing.

4. *Remove switch retaining nut. Unscrew lock nut holding switch to panel.*

5. *Remove switch.*

WRENCH, end, $\frac{3}{4}$ -in.

Remove retaining nut and washer. Remove switch.

6. *Install switch and retaining nut.*
7. *Install lock-out control assembly.*
8. *Install pull knob.*
9. *Connect wires to switch.*

(15) **STARTING SWITCH.** The starting switch connects the circuit to the cranking motor. It is a push type button switch.

(a) Starting Switch Replacement.

1. *Disconnect wires.*

SCREWDRIVER

Disconnect two wires at back of switch.

2. *Remove switch.*

WRENCH, end, $\frac{7}{8}$ -in.

Remove retaining nut from front of instrument panel. Remove switch.

3. *Install replacement switch and retaining nut.*
4. *Connect wires to switch.*

133. INSTRUMENT PANEL.

a. The instruments and gages described in paragraph 132 are mounted in the instrument panel. Service of these units requires lifting panel from case or shield. This is accomplished by removal of one screw at each end of the panel, removal of eight screws at the center portion of the panel at the front, and disconnecting the four amphenol plugs from the rear. Also disconnect the speedometer and tachometer drive shafts at the rear of the case (fig. 251).

134. COMPASS (fig. 252).

a. **Description.** A compass is mounted on the windshield divider strip and is horizontally and vertically in line with the vehicle.

b. **Adjustment.** The compass may be adjusted or compensated by use of coin, and not a screwdriver. A screwdriver might be magnetic.

(1) Point the vehicle north. (Determine directions by a reliable compass located outside the vehicle.) Turn the lower compensator screw

INSTRUMENTS AND GAGES

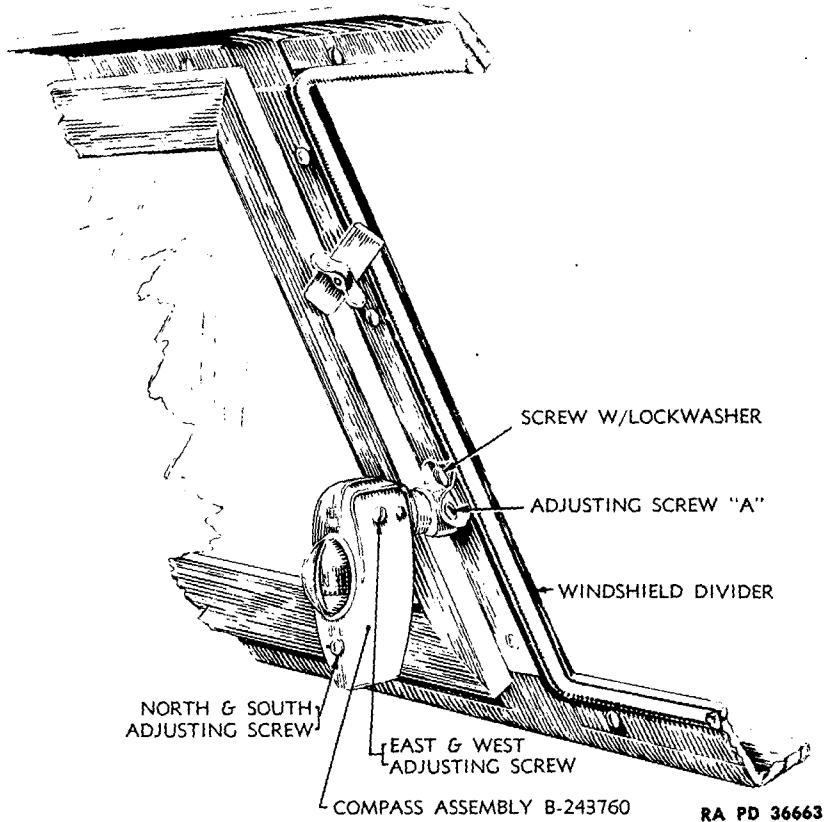

Figure 252 – Compass Mounting and Adjustment

slot (marked N-S) only as far as is necessary to make the dial read "NORTH" or "SOUTH" and no farther. (If the dial reads "SOUTH" instead of "NORTH," see substep (2), below, to correct it.)

(2) Point the vehicle east. Turn the upper compensator screw slot (marked E-W) just enough to make the dial read "EAST" and no farther.

(3) Point the vehicle south. If necessary, turn the lower compensator screw slot (marked N-S) slightly to make the dial read "SOUTH."

(4) Point the vehicle west. If necessary, turn the upper compensator screw slot (marked E-W) slightly to make the dial read "WEST."

NOTE: Body doors should be closed when adjusting compass and taking direction. The engine should be running, or better still, if practical, the vehicle should be in motion when adjustments are made, since the magnetic drives of the speedometer and tachometer affect compass readings. The steering wheel should be in a straight-ahead position.

**BASIC HALF-TRACK VEHICLES (IHC) (PERSONNEL CARRIER M5, CAR M9A1,
MULTIPLE GUN MOTOR CARRIAGE M14, AND SIMILAR IHC VEHICLES)**

Section XXII

PROPELLER SHAFTS

	Paragraph
Description	135
Propeller shaft maintenance	136
Propeller shaft replacement	137

135. DESCRIPTION (fig. 253).

a. Power is transmitted from the transfer case to the rear axle and to the front axle by means of propeller drive shafts equipped with universal joints. Each shaft incorporates two universal joints and a slip joint. Flanged yokes are provided on the universals for attaching the respective shafts to the companion flanges of the transfer case, front axle, and rear axle.

136. PROPELLER SHAFT MAINTENANCE.

a. Inspect all universal joints for wear and for defective grease seals. The axis of the yokes or propeller shaft ends must be in the same plane. Replace bent or damaged shafts. Replace the slip joint members when there is sufficient clearance to cause propeller shaft vibration.

137. PROPELLER SHAFT REPLACEMENT.

a. **General.** Disconnecting respective propeller shafts permits removal of the transmission and transfer case, front axle, or rear axle, without disturbing the unit assembly at the opposite end of the shaft. A new shaft will be installed in case of breakage. Install flange bolts with new lock washers and draw up bolts evenly, alternately, and securely.

b. Equipment.

- | | |
|-------------|--------------------------------------|
| SCREWDRIVER | WRENCH, end, $\frac{1}{16}$ -in. (2) |
| WIRE | WRENCH, end, $\frac{5}{8}$ -in. |

c. Procedure.

(1) PROPELLER SHAFT TO FRONT AXLE.

- | | |
|-------------|---------------------------------|
| SCREWDRIVER | WRENCH, end, $\frac{5}{8}$ -in. |
| WIRE | |

(a) *Disconnect at Front Axle.* Remove four bolts from propeller

PROPELLER SHAFTS

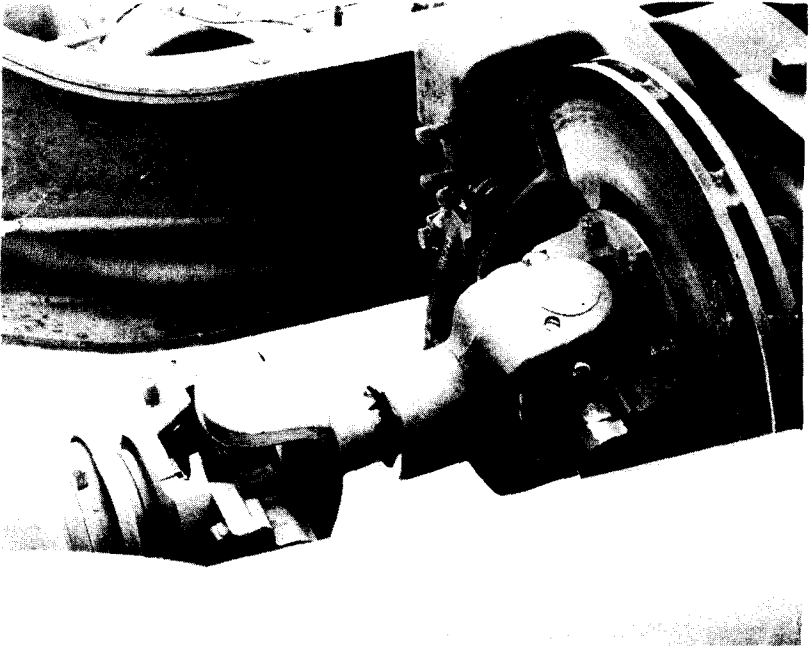

RA PD 18290

Figure 253 — Rear Propeller Shaft — Installed

shaft bearings attached to companion flange at front axle after bending tabs on locking plates.

(b) *Lower Propeller Shaft End to Floor.* Fasten bearings to yoke with wire to prevent their falling off.

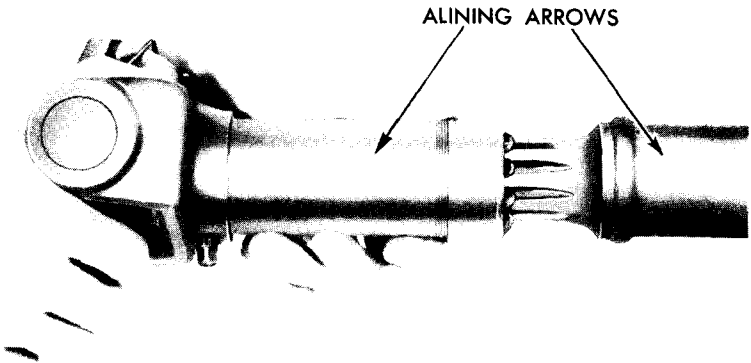

RA PD 18499

Figure 254 — Alinement of Arrows on Front Propeller Shaft

BASIC HALF-TRACK VEHICLES (IHC) (PERSONNEL CARRIER M5, CAR M9A1, MULTIPLE GUN MOTOR CARRIAGE M14, AND SIMILAR IHC VEHICLES)

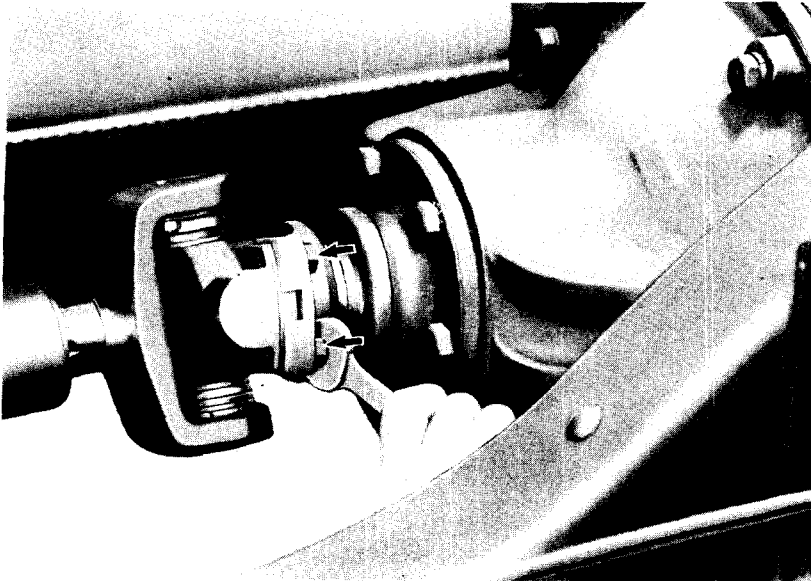

RA PD 18364

Figure 255 — Disconnecting Rear Propeller Shaft at Rear Axle

(c) *Disconnect at Transfer Case.* Remove four bolts from propeller shaft bearings at companion flange at transfer case after bending locking tabs on lock plates.

(d) *Lower Propeller Shaft End to Floor.* Fasten bearings to yoke with wire to prevent their falling off.

(e) *Install Replacement Propeller Shaft End at Transfer Case.* Use new lock washers and new lock plates.

(f) *Install Propeller Shaft End at Front Axle.* Use new lock washers and new lock plates. **CAUTION:** Arrow on spline of shaft must line up with arrow on slip joint sleeve.

(2) PROPELLER SHAFT TO REAR AXLE.

WRENCH, end, $\frac{9}{16}$ -in. (2)

(a) *Remove Six Nuts from Six Cap Screws Holding the Companion Flange to the Brake Disk.* Two cap screws will remain in place, holding the brake disk to the companion flange at the transmission.

(b) *Remove Four Bolts from Propeller Shaft Bearings at Rear Axle* (fig. 255).

(c) *Lower Propeller Shaft to Floor.* Fasten bearings to yoke with wire to prevent their falling off.

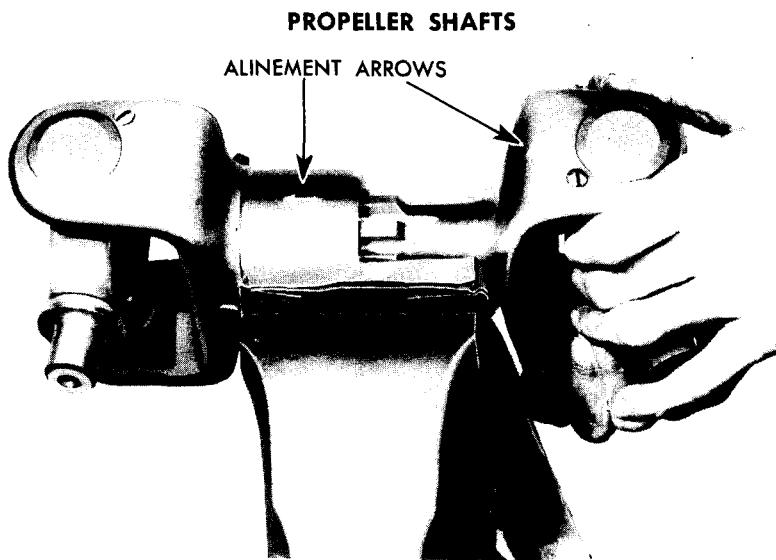

Figure 256 — Alinement of Arrows on Rear Propeller Shaft

- (d) *Install Propeller Shaft End at Brake Disk.*
- (e) *Install Propeller Shaft End at Rear Axle.*

CAUTION: Propeller shaft yokes must be alined in accordance with arrows (fig. 256).

BASIC HALF-TRACK VEHICLES (IHC) (PERSONNEL CARRIER M5, CAR M9A1, MULTIPLE GUN MOTOR CARRIAGE M14, AND SIMILAR IHC VEHICLES)

Section XXIII

SPRINGS AND SHOCK ABSORBERS

	Paragraph
Description	138
Trouble shooting	139
Spring maintenance and adjustment	140
Spring replacement	141

138. DESCRIPTION.

a. **Springs** (fig. 257). Two springs are used at the front axle. They are anchored at the front end and mounted in shackles at the rear end.

b. **Shock Absorbers.** Double acting shock absorbers are used to control the action of the springs. The shock absorber mechanism is bolted to the frame and the connecting links are attached to the front axle underneath the springs.

139. TROUBLE SHOOTING.

a. **Springs.**

(1) **HARD RIDING.**

<i>Possible Cause</i>	<i>Possible Remedy</i>
Insufficient lubrication.	Lubricate (section V).
Broken shackle pins.	Replace pins (par. 141 a).
Uneven load distribution.	Rearrange load.

(2) **TOO FLEXIBLE.**

Broken spring leaves.	Replace spring (par. 141 a).
Excess lubrication.	Clean springs.

(3) **EXCESSIVE NOISE.**

Worn pins or bushings.	Replace pins or spring (par. 141 a).
------------------------	--------------------------------------

b. **Shock Absorbers.**

(1) **HARD RIDING.**

Faulty adjustment.	Adjust shock absorber (par. 140 b).
Inoperative shock absorber.	Replace shock absorber (par. 141 b).

SPRINGS AND SHOCK ABSORBERS

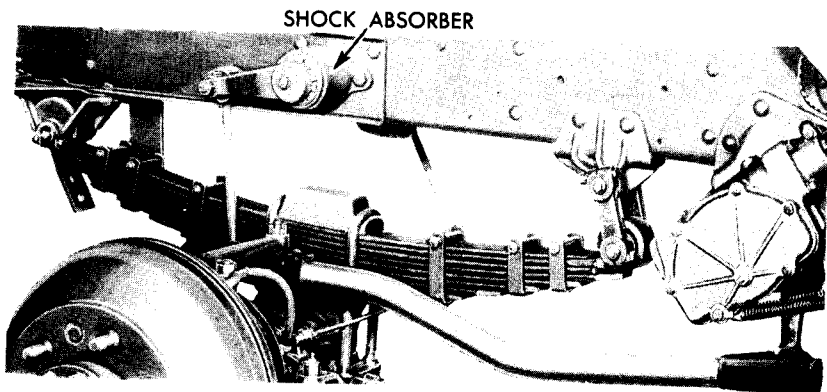

RA PD 18501

Figure 257 – Front Spring and Shock Absorber – Installed

(2) OVER FLEXIBLE.

Possible Cause

Insufficient fluid in shock absorber.

Faulty adjustment.

Inoperative shock absorber.

Possible Remedy

Refill shock absorber (par. 140 b).

Adjust shock absorber (par. 140 b).

Replace shock absorber (par. 141 b).

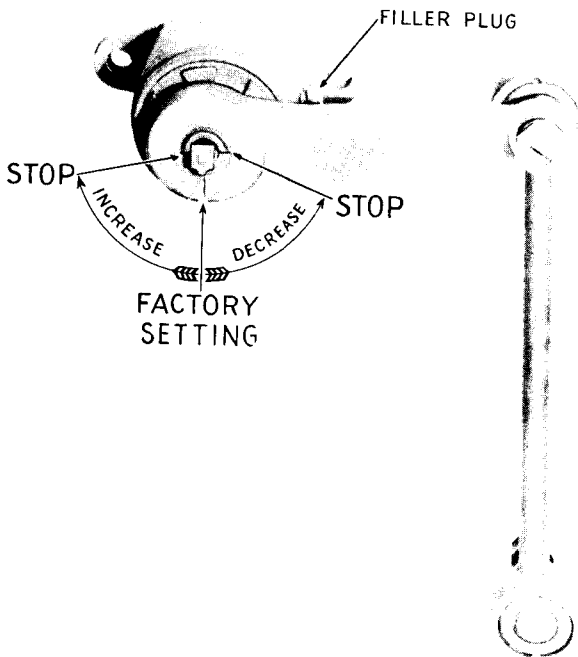

RA PD 18299

Figure 258 – Shock Absorber Adjustment

**BASIC HALF-TRACK VEHICLES (IHC) (PERSONNEL CARRIER M5, CAR M9A1,
MULTIPLE GUN MOTOR CARRIAGE M14, AND SIMILAR IHC VEHICLES)**

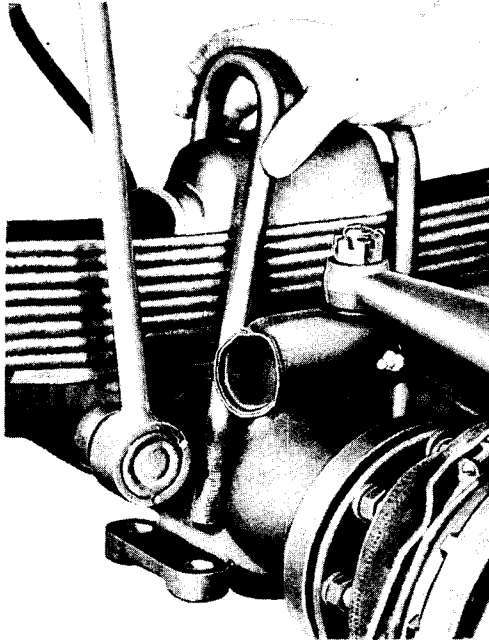

RA PD 18502

Figure 259 — Front Spring U-Bolt — Removal

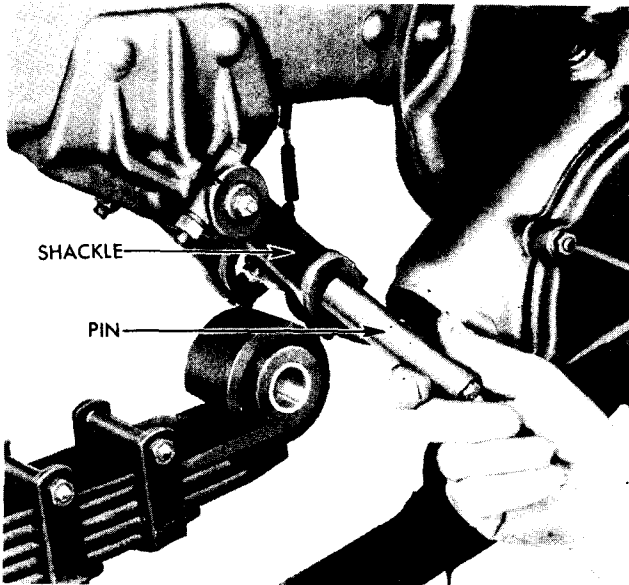

RA PD 18503

Figure 260 — Rear Shackle Pin — Removal

SPRINGS AND SHOCK ABSORBERS

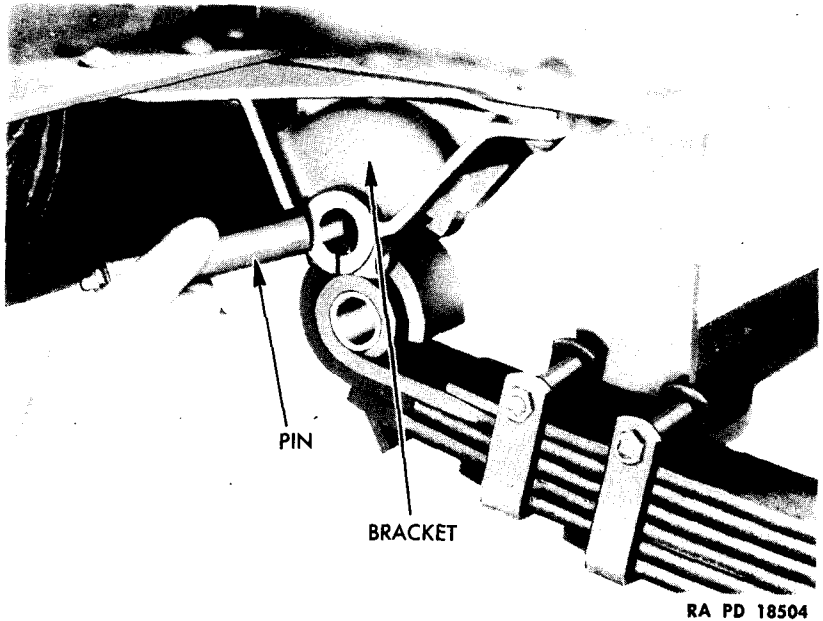

RA PD 18504

Figure 261 — Front Spring Pin — Removal

140. SPRING MAINTENANCE AND ADJUSTMENT.

a. **Springs.** The spring U-bolts which fasten the springs to the axles should be examined regularly and kept tight. Loose U-bolts allow the axle to shift and cause breaking of the leaves and improper alinement of the wheels. Springs should be inspected for broken leaves and for evidence of settling or overloading of the springs.

b. **Shock Absorbers (fig. 258).** The valve adjustments on the shock absorber resistance made at the factory are expected to meet the demands for average general requirements. Adjustments can be made, however, to meet preferred operating conditions. To adjust the shock absorber operating mechanism, the valve indicator on the outside of the instrument is rotated. To *increase* the resistance of the shock absorber, the indicator is rotated *clockwise*. The indicator should not be turned more than one-eighth of an inch at a time until satisfactory control is obtained. Do not adjust past the shoulder stops. Fluid level in shock absorbers should be even with level plug on housing. To fill, remove filler plug, disconnect link at axle, and move link up and down slowly while filling housing with shock absorber fluid. Replace plug and connect link at axle.

**BASIC HALF-TRACK VEHICLES (IHC) (PERSONNEL CARRIER M5, CAR M9A1,
MULTIPLE GUN MOTOR CARRIAGE M14, AND SIMILAR IHC VEHICLES)**

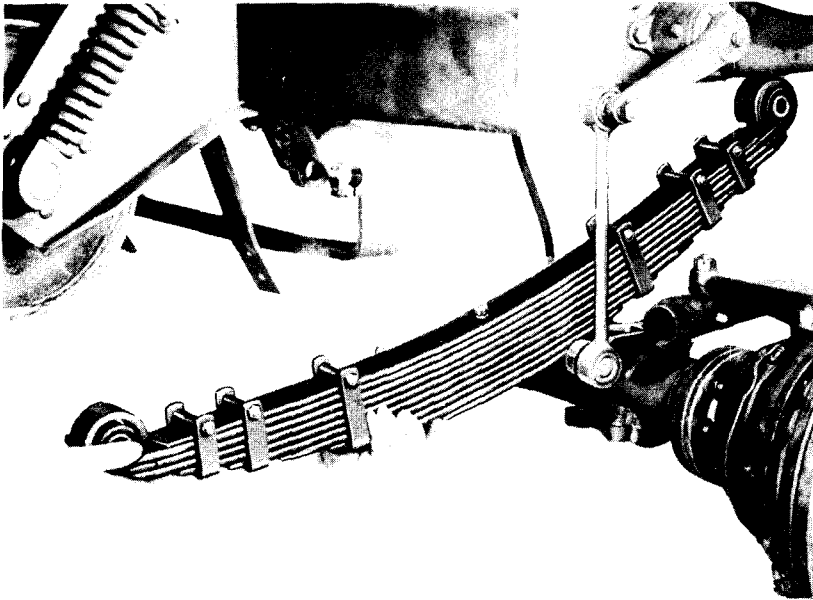

RA PD 18505

Figure 262 – Front Spring – Removal

SPRING REPLACEMENT.

Springs. Springs can be replaced as follows:

(1) EQUIPMENT.

HAMMER

WRENCH, $\frac{3}{16}$ -in.

JACK, 12-ton (2)

WRENCH, 1-in.

PUNCH

(2) PROCEDURE.

(a) Remove Spring U-bolts (fig. 259).

Remove four spring U-bolt nuts and washers. Remove U-bolts.

(b) Jack Up Vehicle.

JACK, 12-ton (2)

Jack up vehicle at frame.

(c) Remove Rear Shackle Pin Retainer Bolt.

WRENCH, $\frac{3}{16}$ -in.

Remove nut and lock washer from shackle pin retainer bolt. Remove bolt.

SPRINGS AND SHOCK ABSORBERS

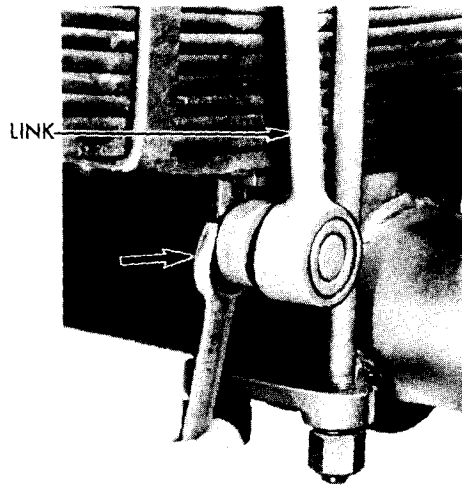

RA PD 18506

Figure 263 — Disconnecting Shock Absorber Link

(d) *Remove Rear Shackle Pin (fig. 260).*

HAMMER

Remove spring pin from shackle.

(e) *Remove Front Spring Pin Retainer Bolts.*

WRENCH, $\frac{9}{16}$ -in.

Remove nuts and washers from both spring pin retainer bolts. Remove bolts.

(f) *Remove Front Spring Pin (fig. 261).*

HAMMER

PUNCH

Remove front spring pin from pin retainer.

(g) *Remove Spring (fig. 262).*

(h) *Install Replacement Spring.*

(i) *Install Front Spring Pin.*

Install front spring pin in pin retainer and install bolts, washers, and nuts in retainer.

(j) *Install Rear Spring Pin.*

Install rear spring pin in shackle, install shackle pin retainer bolt, lock washer, and nut.

(k) *Remove Jacks.*

Lower and remove jacks.

BASIC HALF-TRACK VEHICLES (IHC) (PERSONNEL CARRIER M5, CAR M9A1, MULTIPLE GUN MOTOR CARRIAGE M14, AND SIMILAR IHC VEHICLES)

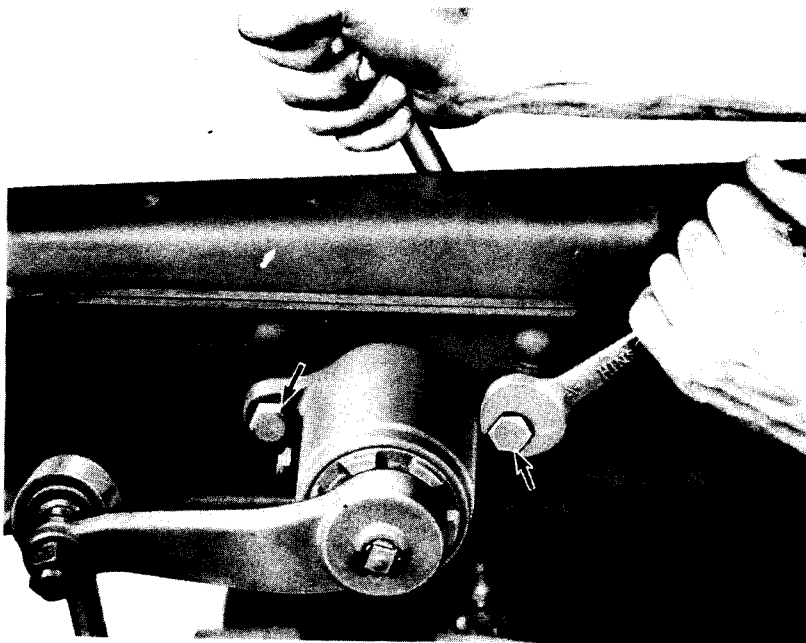

RA PD 18507

Figure 264 – Shock Absorber Mounting Bolts – Removal

(1) *Install Spring U-bolts and Nuts*

b. Shock Absorbers. Shock absorbers can be replaced as follows:

(1) **EQUIPMENT.**

HANDLE, socket wrench

WRENCH, 7/8-in.

WRENCH, end, 3/4-in.

WRENCH, socket, 3/4-in.

(2) **PROCEDURE.**

(a) *Disconnect Shock Absorber Link at Spring Seat (fig. 263).*

WRENCH, 7/8-in.

Remove nut and washer from connector link at spring seat.

(b) *Remove Shock Absorber Mounting Bolts (fig. 264).*

HANDLE, socket wrench

WRENCH, end, 3/4-in.

WRENCH, socket, 3/4-in.

Remove nuts and washers from two bolts mounting shock absorber to frame. Remove shock absorber.

(c) *Install Replacement Shock Absorber and Retaining Bolts on Frame.*

(d) *Connect Shock Absorber Connecting Link on Spring Seat.*

(e) *Install Connecting Link Nut and Washer.*

Section XXIV

STEERING GEAR

	Paragraph
Description	142
Trouble shooting	143
Steering gear assembly maintenance and adjustments	144
Steering gear assembly replacement	145

142. DESCRIPTION.

a. **Steering Gear** (fig. 265). The steering gear is of a cam and twin-lever type. The case is bracket-mounted to the chassis frame and the column is supported by a dash bracket. The cam, lever, and shaft are mounted in an oiltight case with full provision for adjustment of both cam and cam follower. The weight of the assembly is 40 pounds.

b. **Drag Link.** The drag link is of tubular type, having adjustable ball sockets which are spring-loaded. At the axle end, the spring is between the ball seat and the end plug. At the steering gear end of the drag link the spring is between the ball seat and the front of the drag link. Each drag link is covered by a protective boot.

c. **Steering Wheel.** The steering wheel is of three-spoke design and is 18 inches in diameter.

143. TROUBLE SHOOTING.

a. **Steering Difficulties.**

(1) **SHIMMY (AT SPEEDS LESS THAN 30 MILES PER HOUR).**

Possible Cause	Possible Remedy
Excessive caster.	Report to ordnance personnel.
Tire pressure incorrect.	Inflate tires to 70 pounds (max.).
Wheel bearings loose.	Adjust bearings (par. 152 a).
Steering arms loose.	Tighten arms (par. 48).
Steering gear loose.	Adjust steering gear (par. 144 a to d).
Drag link ends loose.	Adjust ends (par. 144 e).
Drag link springs weak or broken.	Replace drag link springs (par. 145 c).
Spring shackles loose.	Adjust shackles (par. 140 a).
Trunnion yoke bearings loose.	Adjust bearings (par. 48).
Tie rod ends loose or worn.	Tighten or replace ends.
Shimmy following lubrication.	Check for worn parts.

BASIC HALF-TRACK VEHICLES (IHC) (PERSONNEL CARRIER M5, CAR M9A1, MULTIPLE GUN MOTOR CARRIAGE M14, AND SIMILAR IHC VEHICLES)

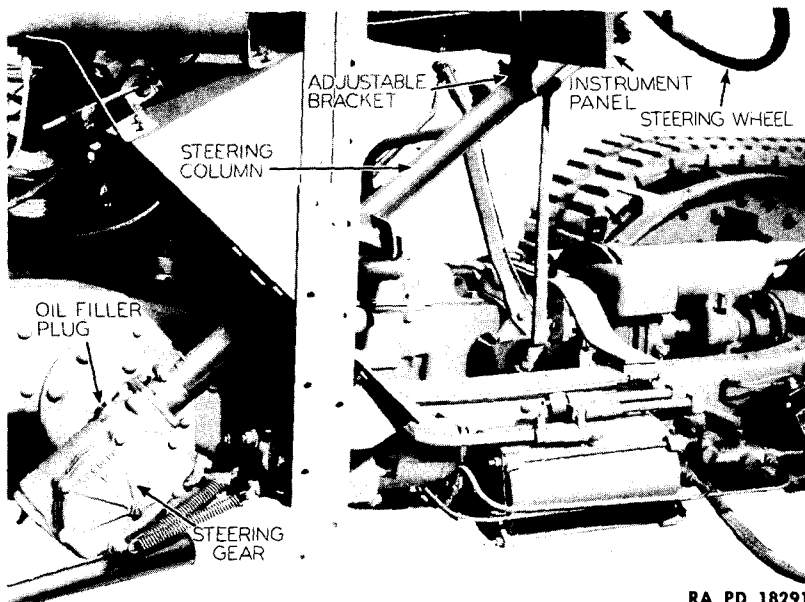

RA PD 18291

Figure 265 – Steering Gear – Installed

(2) SHIMMY (AT SPEEDS ABOVE 35 MILES PER HOUR).

Possible Cause	Possible Remedy
Incorrect tire inflation.	Inflate tires evenly to 70 pounds (max.).
Unbalanced front wheels.	Report to ordnance personnel.
Too flexible front springs.	Replace springs (par. 141 a).
Shock absorbers ineffective.	Adjust or replace (par. 140 b or 141 b).
Loose wheel bearings.	Adjust bearings (par. 152 a).
Too much toe-in of front wheels.	Adjust toe-in.
Shimmy following lubrication.	Check for worn parts.

(3) SIDE PULL.

Unequal camber.	Report to ordnance personnel.
Unequal caster.	Report to ordnance personnel.
Tire inflation incorrect.	Correct inflation to 70 pounds (max.).
Tight wheel bearings.	Adjust bearings (par. 152 a).
Dragging brakes.	Adjust brakes (par. 65).

STEERING GEAR

(4) WANDER OR WEAVING.

Possible Cause	Possible Remedy
Tire inflation incorrect.	Correct inflation to 70 pounds (max.).
Wheel bearings loose.	Adjust bearings.
Trunnion bearings loose or worn.	Adjust if loose (par. 48). Report to ordnance personnel if worn.
Steering gear arm loose.	Tighten arm (par. 48).
Too little caster.	Report to ordnance personnel.
Incorrect camber.	Report to ordnance personnel.
Drag link ends tight or loose.	Adjust drag link (par. 144 e).
Drag link springs weak or broken.	Replace drag link springs (par. 145 c).
Front axle bent.	Report to ordnance personnel.
Front springs broken.	Replace springs (par. 141 a).
Frame bent. Diamond shape.	Report to ordnance personnel.

(5) HARD STEERING.

Tire inflation low.	Inflate tires to 70 pounds (max.).
Trunnion bearings too tight.	Adjust bearings (par. 48).
Steering gear too tight.	Adjust assembly (par. 144).
Caster excessive.	Report to ordnance personnel.

(6) ROAD SHOCK.

Badly alined drag link.	Report to ordnance personnel.
Excessive spring flexibility.	Replace springs (par. 141 a).
Improper shock absorber adjustment.	Adjust shock absorbers (par. 140 b).

144. STEERING GEAR ASSEMBLY MAINTENANCE AND ADJUSTMENTS (fig. 266).

a. Location and correction of steering troubles can best be accomplished by first disconnecting the drag link from the steering gear arm. This will permit easier location of the source of trouble. If difficulty is encountered in turning steering gear through its entire range, it is evident that steering gear adjustment or service is required. Should the steering gear seem satisfactory, attention must be directed elsewhere. If the need of steering gear adjustment is indicated, the procedure is as follows:

BASIC HALF-TRACK VEHICLES (IHC) (PERSONNEL CARRIER M5, CAR M9A1, MULTIPLE GUN MOTOR CARRIAGE M14, AND SIMILAR IHC VEHICLES)

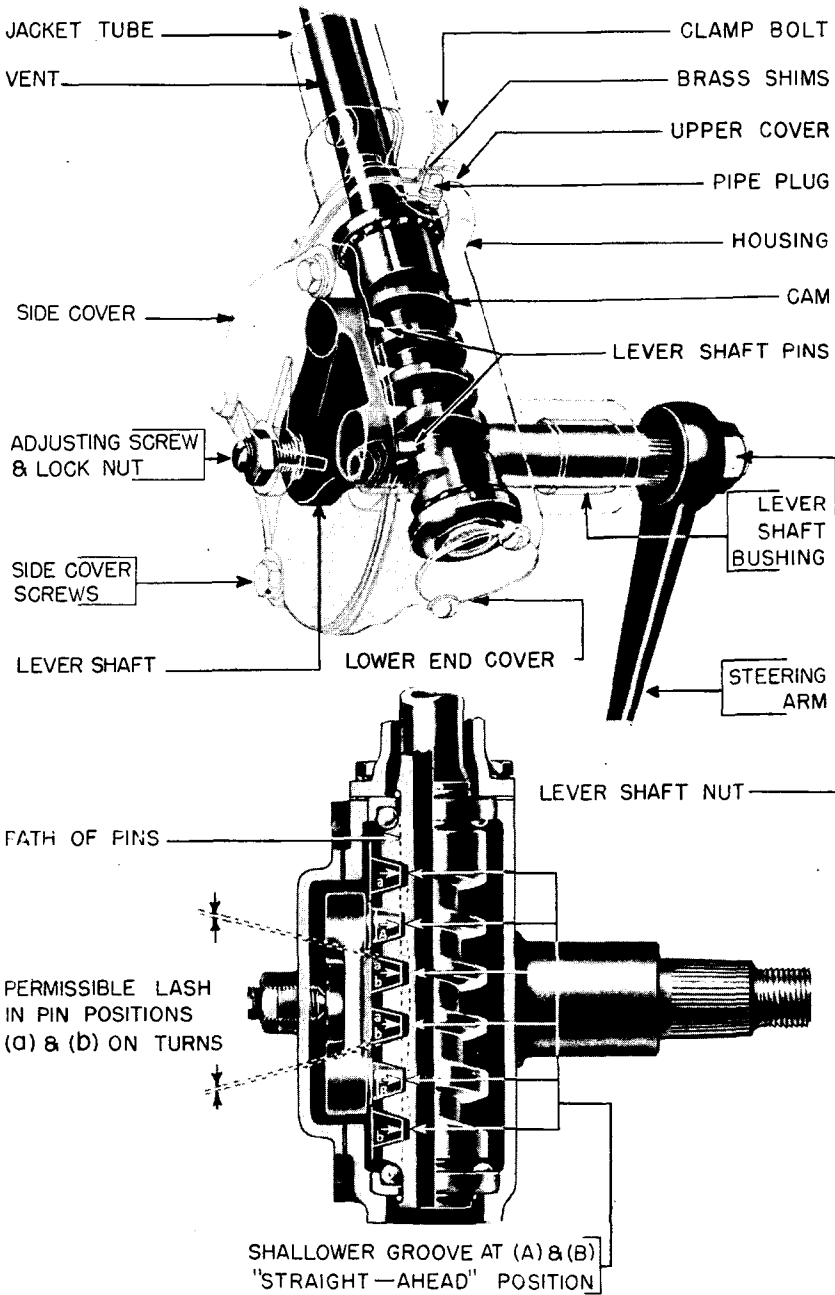

RAFSD-702A

Figure 266 — Steering Gear — Sectionalized

STEERING GEAR

(1) CAM END PLAY.

(a) *Equipment.*

SCREWDRIVER	WRENCH, end, $1\frac{1}{16}$ -in.
WRENCH, end, $\frac{9}{16}$ -in.	WRENCH, end, $\frac{3}{4}$ -in.

(b) *Procedure.*

1. *Loosen lever shaft adjusting screw.*

SCREWDRIVER	WRENCH, end, $\frac{3}{4}$ -in.
-------------	---------------------------------

Loosen housing side cover adjusting screw, lock nut, and screw to free pins from grooves.

2. *Remove upper cover shims.*

WRENCH, end, $\frac{9}{16}$ -in.	WRENCH, end, $1\frac{1}{16}$ -in.
----------------------------------	-----------------------------------

Loosen column clamp bolt and loosen four upper cover cap screws. Raise cover to permit removal of shims. A combination of 0.003-, 0.010-, and 0.300-inch shims are used. Clip and remove one thin shim or more as required to remove end play.

3. *Replace cover.* Tighten cap screws.

4. *Tighten column clamp.*

5. *Adjust lever shaft adjusting screw.*

SCREWDRIVER

Adjust lever shaft adjusting screw to a barely perceptible drag so that steering wheel can be turned freely.

6. *Tighten lock nut on lever shaft adjusting screw.*

SCREWDRIVER	WRENCH, end, $\frac{3}{4}$ -in.
-------------	---------------------------------

Hold screw adjustment and tighten lock nut.

(2) LEVER SHAFT END PLAY. Backlash of the tapered cam studs shows up as end play of the lever shaft, and as backlash at the steering wheel and the ball of the steering arm. Adjustment for lash of the lever shaft must be made with the steering gear in the central or straight-ahead position. This is because the groove on the gear (fig. 266) is cut deeper in the ends of the cam to prevent binding during extreme turning angles, and is cut shallower in the central position (straight-ahead) where the majority of driving is done. Do not adjust in other positions (turns) where backlash is not objectionable.

(a) *Equipment.*

SCREWDRIVER	WRENCH, end, $\frac{3}{4}$ -in.
-------------	---------------------------------

BASIC HALF-TRACK VEHICLES (IHC) (PERSONNEL CARRIER M5, CAR M9A1, MULTIPLE GUN MOTOR CARRIAGE M14, AND SIMILAR IHC VEHICLES)

(b) *Procedure.*

1. *Loosen lever shaft screw lock nut.*

SCREWDRIVER

WRENCH, end, $\frac{3}{4}$ -in.

Loosen lever shaft adjusting screw lock nut while holding adjusting screw.

2. *Adjust lever shaft screw.*

Adjust lever shaft screw until a very slight drag is felt through the mid-position (high-range) when turning the steering wheel slowly from one extreme to the other. **CAUTION:** The gear must not bind at any place and only a very slight drag should be felt. A closer adjustment will not correct any steering condition, but will damage and wear the steering gear parts and impair operation.

3. *Tighten lock nut.*

SCREWDRIVER

WRENCH, end, $\frac{3}{4}$ -in.

Hold adjusting screw to prevent turning, and tighten lock nut securely.

4. *Test adjustment.*

After all lock nuts and bolts are tightened, test steering gear through entire range. If necessary, readjust.

b. Precautions. The foregoing cam end play and lever shaft end play adjustments are usually all that are required. Always adjust cam end play first. Do not attempt to cure wander, shimmy, or road shock by tightening steering gear. Adjust steering gear only to remove excessive play.

c. Column Alinement. If stiffness or bind exists after tightening the U-bolt at the instrument panel steering column support, the gear has been adjusted too tight or the steering column is out of alinement. The column must not be sprung in any direction. If misalinement exists proceed as follows:

(1) **LOOSEN STEERING COLUMN SUPPORT BRACKET AT INSTRUMENT PANEL (fig. 267).**

(2) **LOOSEN STEERING GEAR TORQUE BOLT AT FRAME BRACKET (fig. 268).**

(3) **POSITION STEERING COLUMN TO INSTRUMENT PANEL.**

(4) **TIGHTEN TORQUE BOLT AT FRAME BRACKET.**

(5) **TIGHTEN STEERING COLUMN SUPPORT BRACKET AT INSTRUMENT PANEL.**

STEERING GEAR

d. Drag Link Installation.

(1) PLACE STEERING GEAR IN MID-POSITION (Half Way Between Two Extreme Positions).

(2) PLACE FRONT WHEELS IN "STRAIGHT-AHEAD" POSITION. In this position, drag link end should be in position to connect to steering gear arm ball. If not, it will be necessary to reposition steering gear arm on lever shaft as follows:

(a) *Remove Lever Shaft Nut.*

HANDLE, socket wrench WRENCH, socket, 1¾-in.

Remove nut.

(b) *Remove Steering Gear Arm.*

PULLER

Remove steering gear arm. Do not strike lever shaft with hammer or use pry bars.

(c) *Install Steering Gear Arm.* With steering gear in mid-position and with wheels straight ahead, replace steering gear arm on lever shaft so that drag link will connect to steering arm ball. Tighten lever shaft nut securely.

(3) CONNECT DRAG LINK (see subpar. e, below).

(4) INSTALL DRAG LINK END BOOT.

e. Drag Link Adjustment.

(1) EQUIPMENT.

PLIERS

SCREWDRIVER

(2) PROCEDURE.

(a) *Remove Boot from Drag Link End.*

(b) *Remove Cotter Key.*

(c) *Tighten End Plug Snugly and Then Back Off One-eighth Turn or to Nearest Cotter Keyhole.*

(d) *Install Cotter Key.*

(e) *Install Boot.*

145. STEERING GEAR ASSEMBLY REPLACEMENT.

a. Horn Button.

(1) Disconnect horn cable terminal at base of steering gear housing.

(2) Depress horn button with palm of hand and rotate one-sixth of a turn to left. Release pressure on horn button.

BASIC HALF-TRACK VEHICLES (IHC) (PERSONNEL CARRIER M5, CAR M9A1, MULTIPLE GUN MOTOR CARRIAGE M14, AND SIMILAR IHC VEHICLES)

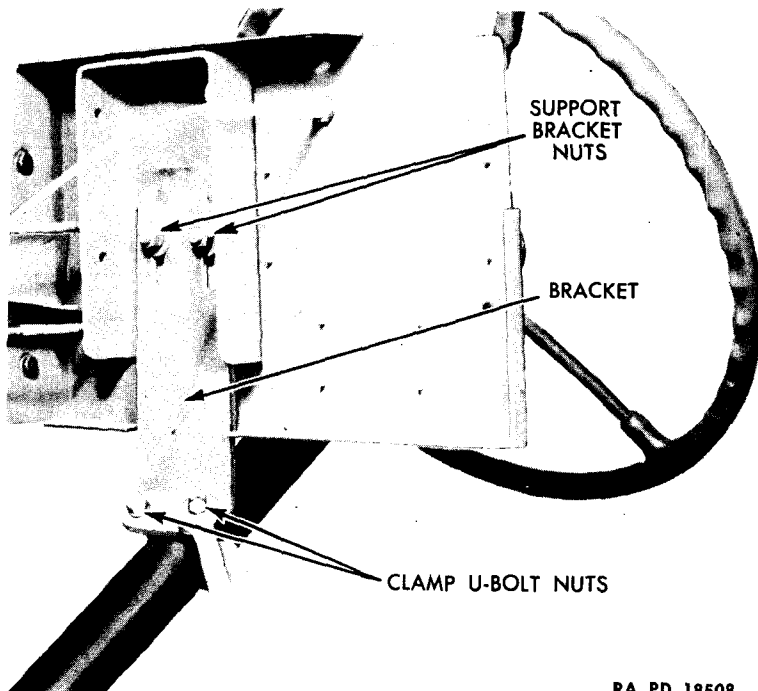

RA PD 18508

Figure 267 — Steering Gear Column Tube Support at Dash Panel

- (3) Position horn button lugs in steering wheel.
- (4) Depress button with palm of hand and rotate one-sixth of a turn to right. Release pressure.
- (5) Connect horn cable at base of steering gear housing.

b. Steering Wheel Replacement.

(1) EQUIPMENT.

HANDLE, socket wrench

SCREWDRIVER

PULLER, steering wheel

WRENCH, socket, $1\frac{3}{16}$ -in.

(2) PROCEDURE.

(a) *Remove Horn Button.* (see subpar. a, above).

(b) *Remove Horn Button Base Plate*

SCREWDRIVER

Remove three screws from base plate. Remove plate and horn cable.

(c) *Remove Steering Wheel Nut.*

HANDLE, socket wrench

WRENCH, socket, $1\frac{3}{16}$ -in.

Remove steering wheel nut and lock washer.

STEERING GEAR

LOCK TORQUE BOLT NUT

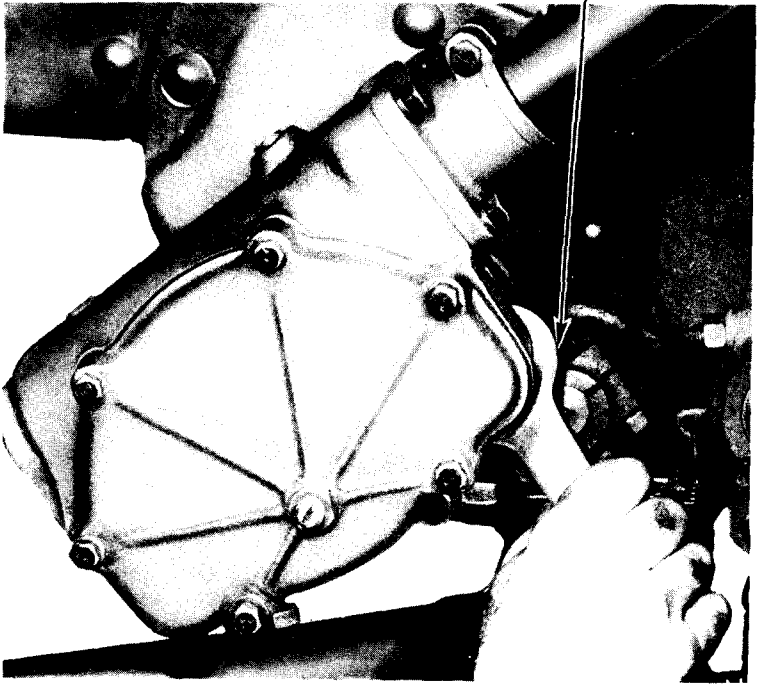

RA PD 18509

Figure 268 — Loosening Lock Torque Bolt at Frame

(d) Remove Steering Wheel.

PULLER, steering wheel

Using puller and adapters for steering post, remove wheel.

(e) Install Replacement Steering Wheel.

(f) Install Steering Wheel Nut and Washer.

(g) Install Horn Base Plate and Horn Cable.

(h) Install Horn Button.

(i) Connect Horn Cable at Base of Steering Gear.

c. Drag Link Replacement.

(1) EQUIPMENT.

PLIERS

SCREWDRIVER

(2) PROCEDURE.

(a) Remove Boot from Each End.

(b) Remove Cotter Pins from Each End.

**BASIC HALF-TRACK VEHICLES (IHC) (PERSONNEL CARRIER M5, CAR M9A1,
MULTIPLE GUN MOTOR CARRIAGE M14, AND SIMILAR IHC VEHICLES)**

(c) *Remove End Plugs.*

SCREWDRIVER

Remove end plugs at each end. From front end remove ball seat and from rear end remove spring seat, spring, and ball seat.

(d) *Remove Drag Link from Steering Arm Balls.*

(e) *Install Replacement Drag Link.* Have ball seats, spring seats, and springs in proper relation.

(f) *Install Outer End Ball Seats, Spring Seats, and Springs.*

(g) *Adjust Drag Link Ends.*

SCREWDRIVER

Tighten end plugs securely and then back off one-eighth turn or to nearest cotter hole. Install new cotters.

(h) *Install Drag Link End Boots.*

d. Steering Gear Replacement.

(1) **EQUIPMENT.**

PLIERS	WRENCH, 7/8-in.
PULLER, steering wheel	WRENCH, 1-in.
SCREWDRIVER	WRENCH, 1 ¹ / ₁₆ -in.
WRENCH, 1/2-in.	

(2) **PROCEDURE.**

(a) *Disconnect Brake and Clutch Pedal Springs from Steering Housing.*

(b) *Disconnect Drag Link at Steering Gear Arm (subpar. c, above).*

(c) *Remove Steering Wheel (subpar. b, above).*

(d) *Disconnect Steering Column at Instrument Panel (fig. 267).*

WRENCH, 1/2-in.

Remove nuts from U-bolt at instrument panel.

(e) *Remove Lock Torque Bolt (fig. 268).*

WRENCH, 7/8-in. WRENCH, 1-in.

Remove lock torque bolt at steering gear frame bracket.

(f) *Remove Frame Bracket Clamp Cap (fig. 269).*

WRENCH, 7/8-in.

Remove two nuts and washers from steering gear frame bracket clamps.

(g) *Remove Clamp Bracket Cap.*

STEERING GEAR

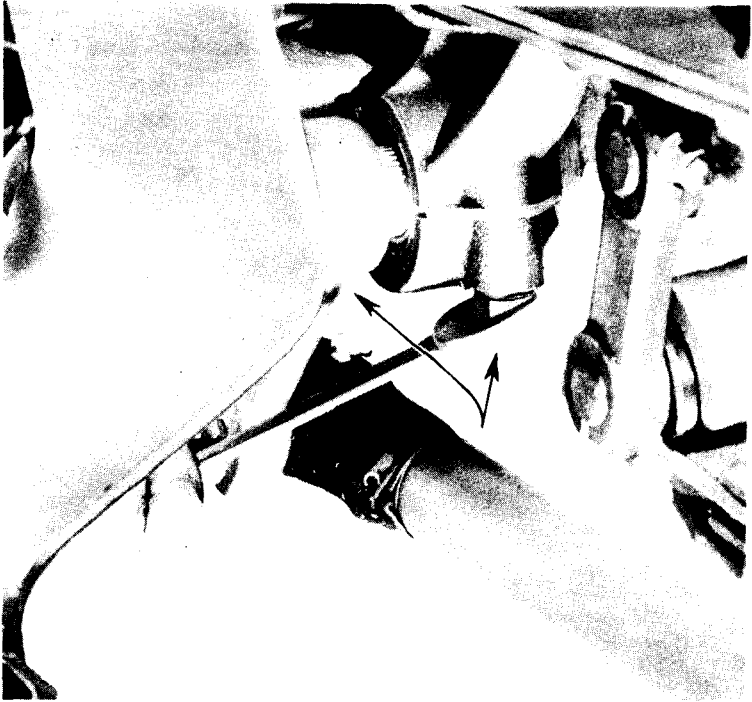

RA PD 18510

Figure 269 — Loosening Frame Bracket Clamp Cap Nuts

- (h) *Lower Steering Gear.* In lowering assembly to floor be careful not to bend or damage steering column tube.
- (i) *Raise Replacement Steering Gear to Position.*
- (j) *Install Bracket Clamp Cap.* Do not tighten nuts.
- (k) *Install Lock Torque Bolt.* Do not tighten.
- (l) *Install U-bolt and Nuts at Instrument Panel.* Do not tighten.
- (m) *Position Steering Gear.* Hold steering assembly in normal position at frame and instrument panel.
- (n) *Tighten Steering Gear Housing Clamp Cap Nuts.*
- (o) *Tighten Lock Torque Bolt.*
- (p) *Tighten U-bolt Nuts at Instrument Panel.*
- (q) *Install Steering Wheel* (subpar. h, above).
- (r) *Connect Drag Link* (subpar. c, above).

e. Steering Gear Position. The steering wheel and column can be adjusted up or down.

BASIC HALF-TRACK VEHICLES (IHC) (PERSONNEL CARRIER M5, CAR M9A1, MULTIPLE GUN MOTOR CARRIAGE M14, AND SIMILAR IHC VEHICLES)

(1) **EQUIPMENT.**

EXTENSION, socket wrench	WRENCH, 1-in.
HANDLE, socket wrench	WRENCH, socket, 7/8-in.
WRENCH, 1/2-in.	

(2) **PROCEDURE.**

(a) *Loosen Lock Torque Bolt at Frame Bracket (fig. 268).*

WRENCH, 1-in.

Loosen lock torque bolt nut.

(b) *Loosen Frame Bracket Clamp Cap (fig. 269).*

EXTENSION, socket wrench	WRENCH, socket, 7/8-in.
HANDLE, socket wrench	

(c) *Loosen Steering Column Support Bracket at Instrument Panel (fig. 267).*

WRENCH, 1/2-in.

Loosen support bracket mounting bolt nuts at instrument panel.

(d) *Place Steering Wheel in Desired Position.*

(e) *Tighten Steering Gear Housing Clamp Cap.*

(f) *Tighten Lock Torque Bolt.*

(g) *Tighten Column Support Bracket Bolts at Instrument Panel (fig. 267).*

Section XXV

TRANSMISSION AND TRANSFER CASE

	Paragraph
Description	146
Trouble shooting	147
Transmission replacement	148

146. DESCRIPTION (figs. 270 to 272).

a. The transmission and transfer case are bolted together to form one unit. The front end of the assembly is bolted to the engine at the bell housing of the flywheel. The hand brake is mounted on the left side of the transfer case and the transfer case shift levers are on the right side of the transmission. The weight of the transmission with power take-off is 503 pounds. The power take-off weighs 36 pounds.

b. **Transmission.** The transmission incorporates four forward speeds and one reverse speed. A power take-off is mounted on the left-hand side of the transmission on winch-equipped vehicles.

c. **Transfer Case.** The transfer case is the unit through which the front axle and the rear axle are driven, and provides an additional speed reduction for any selection of the transmission gear speeds. Provision is also made for optional engagement or declutching of the front wheel drive. The front wheel drive can be used with any of the transmission speeds since interlocks are not incorporated in the transmission. Speedometer drive gears are incorporated in a housing on the rear of the case and engaged with the front axle drive shaft projecting therein.

d. **Gear Ratios and Shifts.** Details concerning gear shifting are discussed in section II and are illustrated in figure 18.

147. TROUBLE SHOOTING.

a. **General.** The most common abuse to which a transmission is subjected is the inexpert shifting of gears. This results in broken shifting levers and forks, sprung shafts, and internal damage. Frequent inspections should be made of the lubricant level and the case gaskets to insure against lubricant leakage. Transmission hanger bolts should be inspected frequently and kept tightened.

b. **Noises.** Peculiar or foreign sounds which seem to come from the transmission or transfer case may actually originate in some other part of the chassis. Therefore, a thorough check by actual driving should be made to determine the real source of the noise before initiating any actual mechanical work on the transmission or transfer case. Attention

BASIC HALF-TRACK VEHICLES (IHC) (PERSONNEL CARRIER M5, CAR M9A1, MULTIPLE GUN MOTOR CARRIAGE M14, AND SIMILAR IHC VEHICLES)

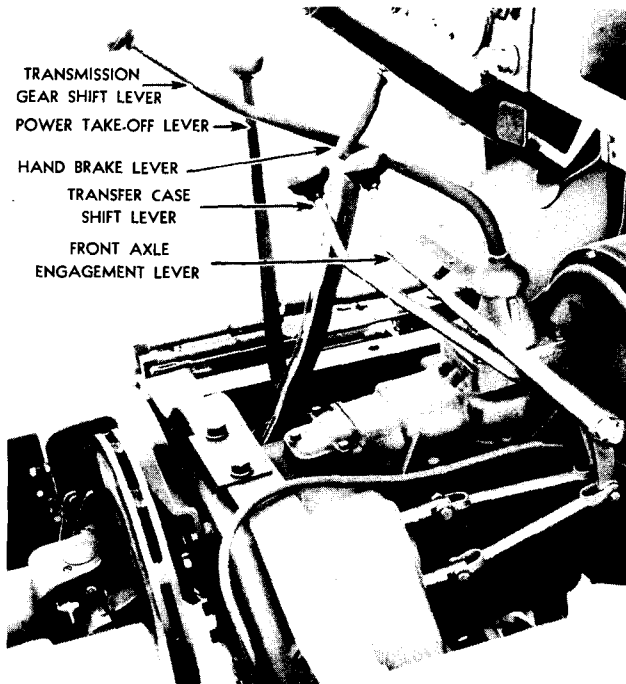

RA PD 18547

Figure 270 — Transmission and Transfer Case — Installed — Right Side

should be directed especially to the propeller shaft which may have worn bearings or journals that may cause noise. Other possible sources of trouble, however, may be as follows. For the most part, their corrections are not within the scope of this manual.

Possible Cause	Possible Remedy
Improper lubricant.	Change lubricant (sec. V).
Insufficient lubricant.	Add lubricant to level.
Misalignment of clutch bell housing.	Report to ordnance personnel.
Loose engine mountings.	Tighten mountings (sec. XVII).
Misalignment or wear of main drive gear spline shaft.	Report to ordnance personnel.
Stripped gears.	Report to ordnance personnel.
Gear lash from worn gear teeth.	Report to ordnance personnel.
Loose gears.	Report to ordnance personnel.
Improper gear shift rods adjustment.	Report to ordnance personnel.

TRANSMISSION AND TRANSFER CASE

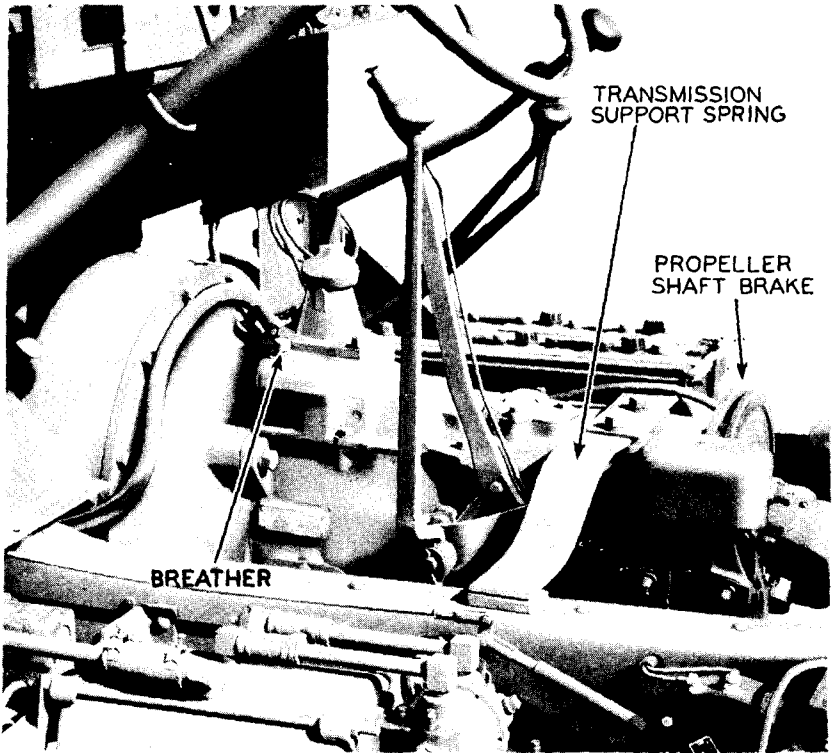

RA PD 18293

Figure 271 — Transmission and Transfer Case — Installed — Left Side

148. TRANSMISSION REPLACEMENT.

a. **General.** The transmission and transfer case are not removed as a part of the engine group but are accessible by removing the tunnel floor plate in the driver's compartment.

b. Transmission Shift Lever Replacement.

(1) EQUIPMENT.

HANDLE, socket wrench
PLIERS

SCREWDRIVER
WRENCH, socket, $\frac{1}{16}$ -in.

(2) PROCEDURE.

(a) Remove Tunnel Floor Plates Over Transmission

SCREWDRIVER

Remove screws holding tunnel plate over transmission. Remove plate.

(b) Remove Transmission Shifter Housing Cover and Shift Lever.

HANDLE, socket wrench WRENCH, socket, $\frac{1}{16}$ -in.

Remove four nuts and lock washers from studs in shifter housing and remove cover and gasket.

BASIC HALF-TRACK VEHICLES (IHC) (PERSONNEL CARRIER M5, CAR M9A1, MULTIPLE GUN MOTOR CARRIAGE M14, AND SIMILAR IHC VEHICLES)

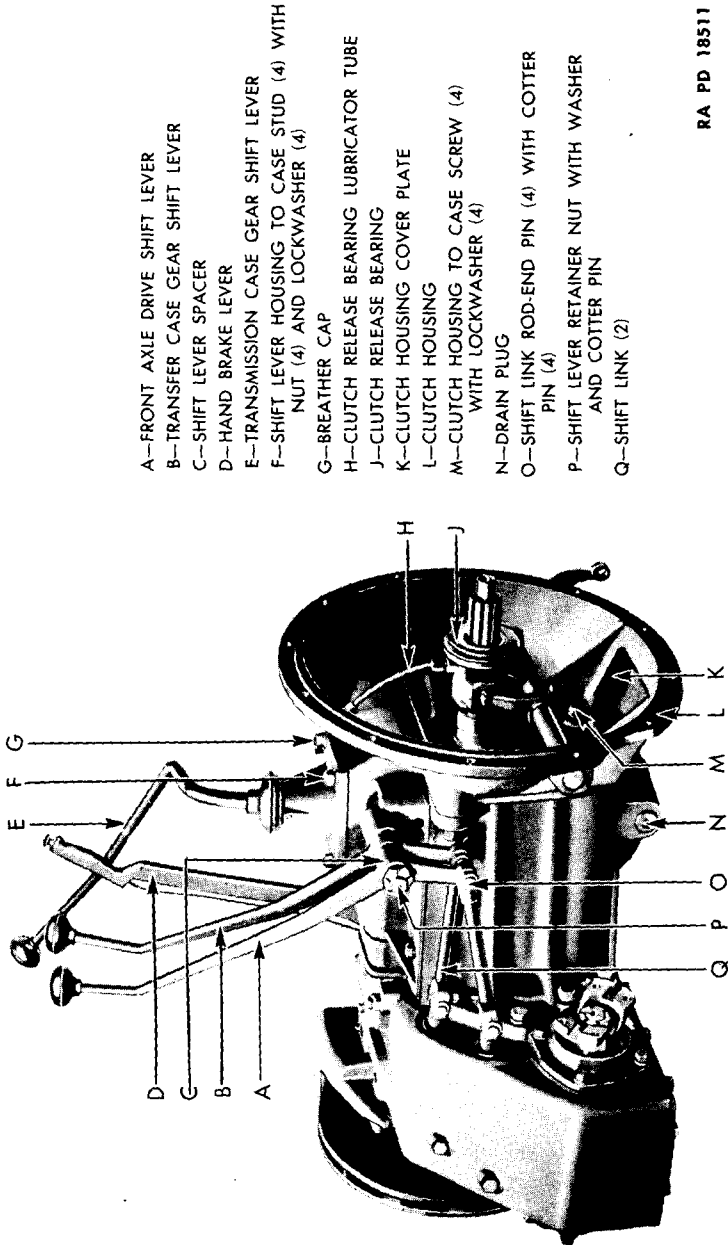

- A--FRONT AXLE DRIVE SHIFT LEVER
- B--TRANSFER CASE GEAR SHIFT LEVER
- C--SHIFT LEVER SPACER
- D--HAND BRAKE LEVER
- E--TRANSMISSION CASE GEAR SHIFT LEVER
- F--SHIFT LEVER HOUSING TO CASE STUD (4) WITH NUT (4) AND LOCKWASHER (4)
- G--BREATHER CAP
- H--CLUTCH RELEASE BEARING LUBRICATOR TUBE
- J--CLUTCH RELEASE BEARING
- K--CLUTCH HOUSING COVER PLATE
- L--CLUTCH HOUSING
- M--CLUTCH HOUSING TO CASE SCREW (4) WITH LOCKWASHER (4)
- N--DRAIN PLUG
- O--SHIFT LINK ROD-END PIN (4) WITH COTTER PIN (4)
- P--SHIFT LEVER RETAINER NUT WITH WASHER AND COTTER PIN
- Q--SHIFT LINK (2)

RA PD 18511

Figure 272 -- Transmission and Transfer Case -- Removed -- Right Side

TRANSMISSION AND TRANSFER CASE

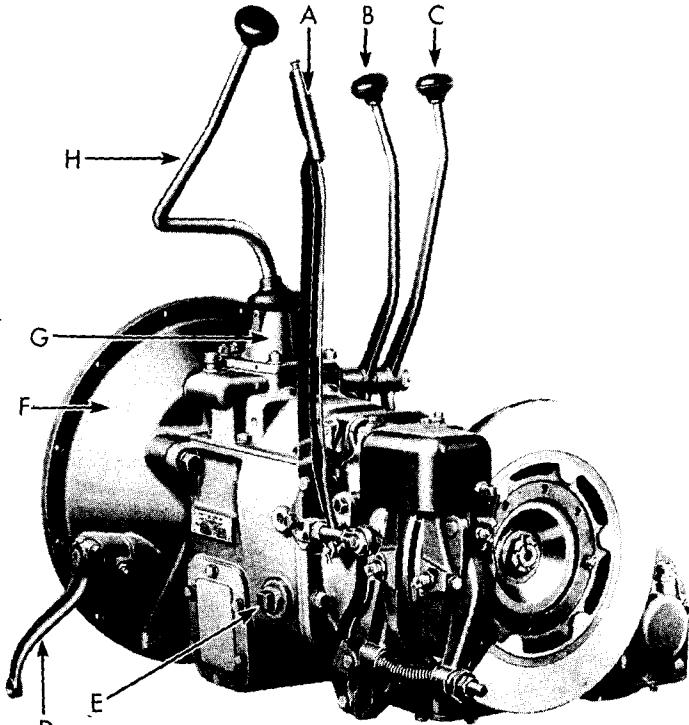

- A—HAND BRAKE LEVER
- B—TRANSFER CASE GEAR SHIFT LEVER
- C—FRONT AXLE DRIVE SHIFT LEVER
- D—CLUTCH RELEASE LEVER
- E—LUBRICANT LEVEL PLUG
- F—CLUTCH HOUSING
- G—SHIFT LEVER HOUSING
- H—TRANSMISSION CASE GEAR SHIFT LEVER

RA PD 18512

Figure 273 — Transmission and Transfer Case — Removed — Left Side

(c) Remove Transmission Shift Lever Support Spring from Cover.
PLIERS

Gripping wire at bottom end, twist to release spring from holding lug in cover and remove spring.

(d) Remove Transmission Shift Lever.

Unscrew shift lever handle and remove handle. Lift off rubber grommet. Remove shift lever through bottom of housing.

(e) Install Replacement Shift Lever Through Bottom of Housing.
Locate lever at guide pins.

BASIC HALF-TRACK VEHICLES (IHC) (PERSONNEL CARRIER M5, CAR M9A1, MULTIPLE GUN MOTOR CARRIAGE M14, AND SIMILAR IHC VEHICLES)

- (f) *Install Shift Lever Support Spring in Cover.*
- (g) *Install Rubber Grommet at Cover.*
- (h) *Install Shift Lever Handle.*
- (i) *Install Shifter Housing Cover and Shift Lever on Transmission.*
- (j) *Install Tunnel Floor Plates and Retaining Screws.*

c. Transfer Case Shift Lever Replacement.

(1) **EQUIPMENT.**

PLIERS

WRENCH, 1 $\frac{5}{16}$ -in.

(2) **PROCEDURE.**

- (a) *Remove Cotter Pin.*

PLIERS

Remove cotter pin from shift lever retainer nut.

- (b) *Remove Retainer Nut.*

WRENCH, 1 $\frac{5}{16}$ -in.

Remove retainer nut from shift lever.

- (c) *Remove Cotter Pins.*

PLIERS

Remove cotter pin from each shift link rod at shift lever.

- (d) *Remove Shift Link Rod End Pins.*

- (e) *Remove Front Axle Drive Shift Lever.*

- (f) *Remove Shift Lever Spacer.*

- (g) *Remove Transfer Case Shift Lever.*

- (h) *Install Transfer Case Shift Lever.*

- (i) *Install Shift Lever Spacer.*

- (j) *Install Front Axle Drive Shift Lever.*

- (k) *Install Shift Lever Nut and Cotter Pin.*

- (l) *Install Shift Link Rod End Pin and Cotter Pin at Transfer Case Shift Lever.*

- (m) *Install Shift Link Rod End Pin and Cotter Pin at Front Axle Drive Shift Lever.*

d. Gear Box Assembly Removal.

(1) **EQUIPMENT.**

CHAIN BLOCK

DRIFT, brass

HAMMER

HANDLE, socket wrench

HOOK, chain block

JACK

TRANSMISSION AND TRANSFER CASE

- | | |
|-----------------------------|-------------------------------------|
| PAIL, large | WRENCH, $\frac{9}{16}$ -in. |
| PLIERS | WRENCH, $\frac{5}{8}$ -in. |
| ROPE, 1-in. | WRENCH, $\frac{3}{4}$ -in. |
| SCREWDRIVER | WRENCH, $\frac{7}{8}$ -in. |
| WRENCH, $\frac{5}{16}$ -in. | WRENCH, 1 $\frac{1}{4}$ -in. |
| WRENCH, $\frac{3}{8}$ -in. | WRENCH, socket, $\frac{9}{16}$ -in. |
| WRENCH, $\frac{7}{16}$ -in. | WRENCH, socket, $\frac{3}{4}$ -in. |
| WRENCH, $\frac{1}{2}$ -in. | WRENCH, socket, 1-in. |

(2) PROCEDURE.

(a) *Drain Transmission and Transfer Case.*

- | | |
|-------------|----------------------------|
| PAIL, large | WRENCH, $\frac{7}{8}$ -in. |
|-------------|----------------------------|

Remove two drain plugs from bottom of transmission and transfer case and drain lubricating oil into pail.

(b) *Remove Floor Plates Over Transmission.*

SCREWDRIVER

Remove screws holding tunnel plate and screws holding transfer case shift lever floor plate. Remove plates.

(c) *Disconnect Speedometer Cable.*

- | | |
|--------|-----------------------------|
| PLIERS | WRENCH, $\frac{9}{16}$ -in. |
|--------|-----------------------------|

Remove round coupling nut holding speedometer drive shaft to transfer case front drive shaft rear bearing cap. Remove two cap screws which secure speedometer cable clips to transmission and remove clips.

(d) *Disconnect Propeller Shaft to Rear Axle* (par. 137).

(e) *Disconnect Propeller Shaft to Front Axle at Transfer Case* (par. 137).

(f) *Remove Drive Shaft Brake* (par. 67).

(g) *Disconnect Front-drive Shift and Under-drive Shift Lever Links.*

- | | |
|--------|--------|
| PLIERS | HAMMER |
|--------|--------|

Remove two cotter pins from shifting link rod end pins at the transfer case shift end and remove rod end pins. This will allow shifting levers to lie flat to facilitate removal of assembly.

(h) *Remove Hand Brake Lever Assembly.*

- | | |
|--------------|-----------------------------|
| DRIFT, brass | PLIERS |
| HAMMER | WRENCH, $\frac{9}{16}$ -in. |

Remove cotter pin and rod end pin securing brake pull rod to brake lever. Remove two cap screws and lock washers holding brake lever quadrant to transfer case. Remove hand brake lever assembly.

BASIC HALF-TRACK VEHICLES (IHC) (PERSONNEL CARRIER M5, CAR M9A1, MULTIPLE GUN MOTOR CARRIAGE M14, AND SIMILAR IHC VEHICLES)

(i) *Remove Frame Tie Cross Member Below Transmission.*

WRENCH, $\frac{3}{4}$ -in.

Remove 10 cap screws, nuts, and lock washers (four on left side and six on right side) holding cross member to frame, and lower to floor.

(j) *Remove Transmission Shifter Housing Cover and Shift Lever.*

WRENCH, $\frac{5}{16}$ -in.

Remove four nuts and lock washers from studs in shifter housing, and remove cover and gasket.

(k) *Disconnect Clutch Release Shaft Lever from Clutch Linkage.*

HAMMER

PLIERS

Remove cotter pin and rod end pin holding release shaft lever to relay shaft lever.

(l) *Mount Sling Around Transmission.*

CHAIN BLOCK

ROPE, 1-in.

HOOK, chain block

Put rope around and under transmission, making certain that assembly will be balanced in sling during removal in order to prevent injury to splined shaft.

(m) *Disconnect Transmission Support Spring and Spring Pressure Plate.*

WRENCH, $\frac{7}{8}$ -in.

Remove two cap screws and lock washers holding support spring and pressure plate to transmission.

(n) *Disconnect Transmission Bell Housing from Engine Flywheel Bell Housing.*

WRENCH, $\frac{9}{16}$ -in.

Remove the 12 cap screws and lock washers holding transmission bell housing to the engine flywheel bell housing.

(o) *Remove Transmission.*

Using sling as support, slowly push transmission toward the rear, rocking it slightly as it is withdrawn, until the splined shaft is free from the clutch. Be sure to keep transmission in line while removing, in order to prevent injury to splined shaft and clutch. Lower assembly and remove sling.

e. Transmission Installation.

(1) EQUIPMENT.

Use same equipment listed in subparagraph d, above.

TRANSMISSION AND TRANSFER CASE

(2) PROCEDURE.

(a) *Remove Transmission Bell Housing Hand Hole Cover Plate.*

WRENCH, $\frac{1}{16}$ -in.

Remove four cap screws and washers holding bell housing cover plate. Remove plate.

(b) *Raise Transmission into Place.*

Mount sling around the transmission, and raise and guide transmission carefully to enter splined shaft into clutch splines.

(c) *Connect Transmission Bell Housing to Engine Flywheel Bell Housing.*

(d) *Connect Transmission Support Spring and Spring Pressure Plate at Transmission.*

(e) *Remove Sling from Transmission.*

(f) *Connect Clutch Release Shaft Lever to Clutch Linkage.*

(g) *Install Transmission Shifter Housing Cover and Shift Lever.*

(h) *Install Frame Tie Cross Member Below Transmission.*

(i) *Install Hand Brake Lever Assembly at Transfer Case.*

(j) *Connect Front Drive Shift and Under-drive Shift Lever Links.*

(k) *Install Drive Shaft Brake to Rear Axle (sec. XI).*

(l) *Connect Propeller Shaft to Front Axle at Transfer Case (par. 137).*

(m) *Connect Propeller Shaft to Rear Axle (par. 137).*

(n) *Connect Speedometer Cable and Install Speedometer Cable Clips.*

(o) *Install Transmission Bell Housing Cover Plate.*

(p) *Fill Transmission and Transfer Case to Proper Level with Lubricant (sec. V).*

(q) *Install Floor Plates and Retaining Screws.*

**BASIC HALF-TRACK VEHICLES (IHC) (PERSONNEL CARRIER M5, CAR M9A1,
MULTIPLE GUN MOTOR CARRIAGE M14, AND SIMILAR IHC VEHICLES)**

Section XXVI

WHEELS, TIRES, AND WHEEL BEARINGS

	Paragraph
Description	149
Trouble shooting	150
Front wheel maintenance and adjustments	151
Wheel bearings	152

149. DESCRIPTION (fig. 274).

a. The front wheels are of the dismountable type having a ventilated steel disk and are of combat type having a side retainer rim held in place by 18 retaining cap screws.

b. Combat tires with mud and snow tread and size 9.00-20 are used on this vehicle together with bead locks. The metal bead locks are flexible steel bands with several metal flanged blocks attached. The bead locks fit between the beads of the tire. The flanged blocks secure the beads in position, preventing the beads from being forced together, since in an emergency the tires are used without air.

c. Recommended tire pressure is 70 pounds (max.) as measured with an inflation gage. Tires should be cool when checking and correcting inflation.

150. TROUBLE SHOOTING.

a. Certain symptoms of trouble which concern the tires and wheels are as follows:

(1) HARD STEERING.

Possible Cause	Possible Remedy
Tires underinflated.	Inflate to 70 pounds (max.).
Wheel bearings out of adjustment.	Adjust wheel bearings (par. 152 a).

(2) AIR LEAKAGE.

Valve cap missing.	Replace cap.
Valve core loose.	Retighten.
Torn or punctured tube.	Repair tube (par. 151 a).

WHEELS, TIRES, AND WHEEL BEARINGS

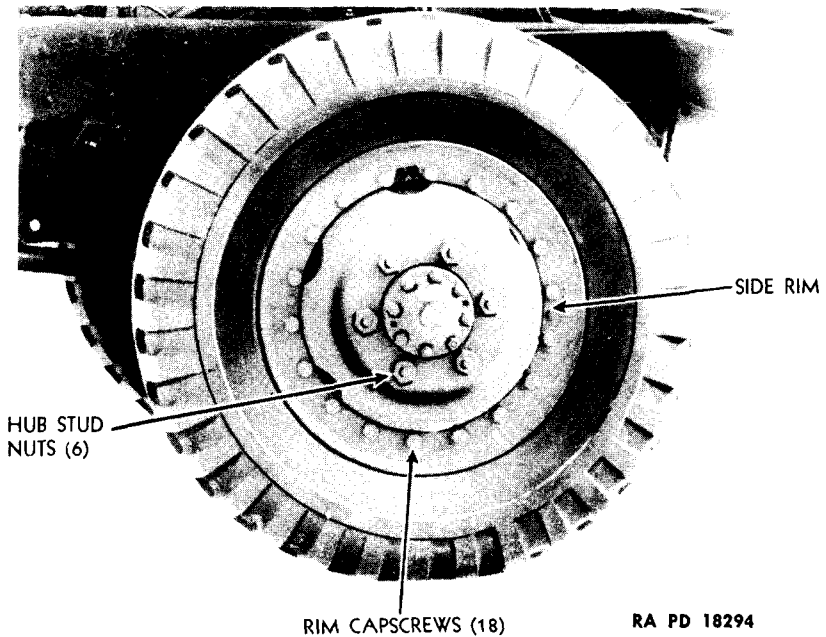
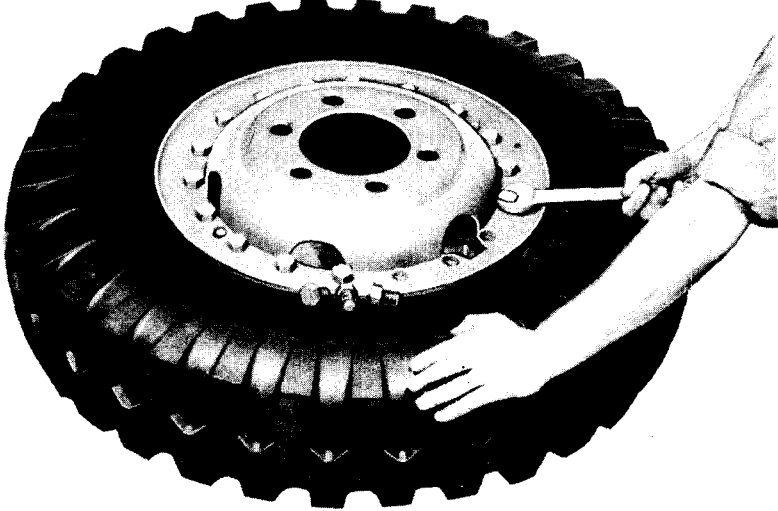

Figure 274 - Front Wheel - Installed

151. FRONT WHEEL MAINTENANCE AND ADJUSTMENTS.

a. **Tires and Tubes.** Tires should be repaired in accordance with conventional methods. Punctures and tears causing exposure of the cord or fabric should be vulcanized. Holes in bullet-resisting and puncture-sealing tubes should be repaired by cold-patching. Do not attempt to hot-patch puncture-sealing tubes. Tires must be inflated equally and not operated underinflated. Balanced tire pressures (if correct) facilitate steering, improve riding comfort, and contribute to safe driving and maximum tire mileage. Before pumping air into tubes, depress valve momentarily to blow out any dirt in the valve. Keep caps on valves to prevent entrance of dirt and foreign matter. When removing the tire from the rim remove the valve to release all air. Remove the 18 retaining cap screws from the side ring (fig. 275). Pry off side ring, using a pinch bar (fig. 276). Remove tire assembly from rim (fig. 277). Using a pinch bar, collapse the bead lock ring to permit its removal from the casing (fig. 278). When reassembling tire insert the tube in the casing, insert the flap and partially inflate the tube to spread the beads. Insert the bead lock between the beads. Deflate the tube, making sure that the flanged blocks of the bead lock are centered between the beads. Place the tire assembly on the wheel, apply the flange and pull down into place with cap screws (fig. 279) and tighten evenly. Inflate tire to 70 pounds (max.).

BASIC HALF-TRACK VEHICLES (IHC) (PERSONNEL CARRIER M5, CAR M9A1, MULTIPLE GUN MOTOR CARRIAGE M14, AND SIMILAR IHC VEHICLES)



RA PD 18513

Figure 275 — Side Ring Retaining Cap Screws — Removal

b. Oil and grease have a harmful effect on rubber. Every attempt should be made to keep these substances from coming in contact with the tires.

c. **Wheels.** Check and tighten wheel stud nuts daily for the first 500 to 1,000 miles of service to compensate "setting-in" of clamping surfaces. Use wrench provided for the purpose and do not use an extension on

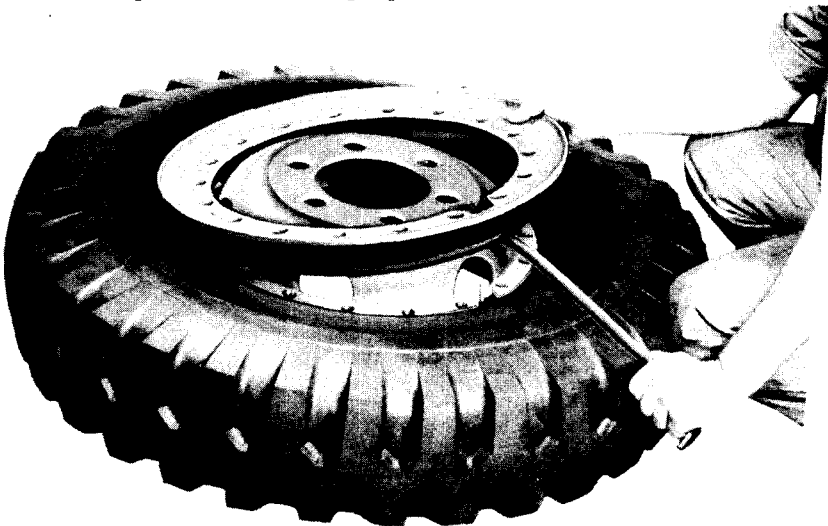

RA PD 18514

Figure 276 — Side Ring — Removal

WHEELS, TIRES, AND WHEEL BEARINGS



Figure 277 — Removing Tire from Rim

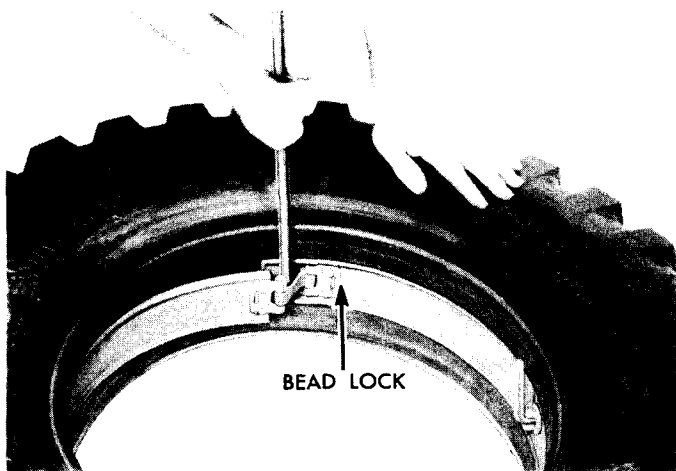
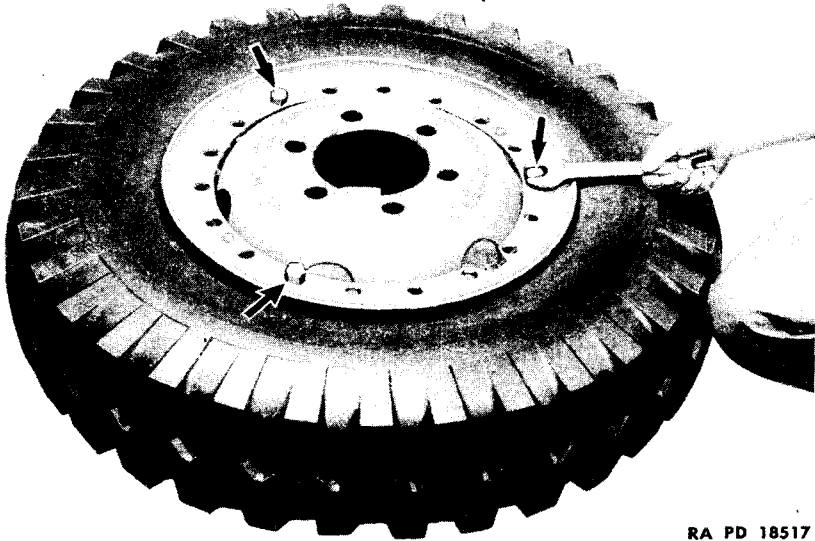

Figure 278 — Collapsing Tire Bead Lock

**BASIC HALF-TRACK VEHICLES (IHC) (PERSONNEL CARRIER M5, CAR M9A1,
MULTIPLE GUN MOTOR CARRIAGE M14, AND SIMILAR IHC VEHICLES)**



RA PD 18517

Figure 279 – Side Ring – Installation

the handle or apply excessive pressure other than direct hand effort. Successively tighten opposite nuts to prevent cocking wheel on studs. Never use oil on wheel stud nuts.

152. WHEEL BEARINGS.

a. **Front Wheel Adjustment.** The front wheel bearings are adjustable and the procedure is as follows:

(1) **EQUIPMENT.**

HANDLE, wheel bearing nut
wrench
JACK

SCREWDRIVER
WRENCH, $\frac{3}{4}$ -in.
WRENCH, wheel bearing nut

(2) **PROCEDURE.**

(a) *Raise Wheel.*

JACK

Place jack under front axle on side to be serviced. Raise wheel from floor.

(b) *Remove Front Wheel Drive Flange (fig. 280).*

WRENCH, $\frac{3}{4}$ -in.

Remove front wheel drive flange nuts and washers. Insert cap screws in threaded holes in drive flange and pull flange off of splined outer end of axle shaft by turning screws alternately.

WHEELS, TIRES, AND WHEEL BEARINGS

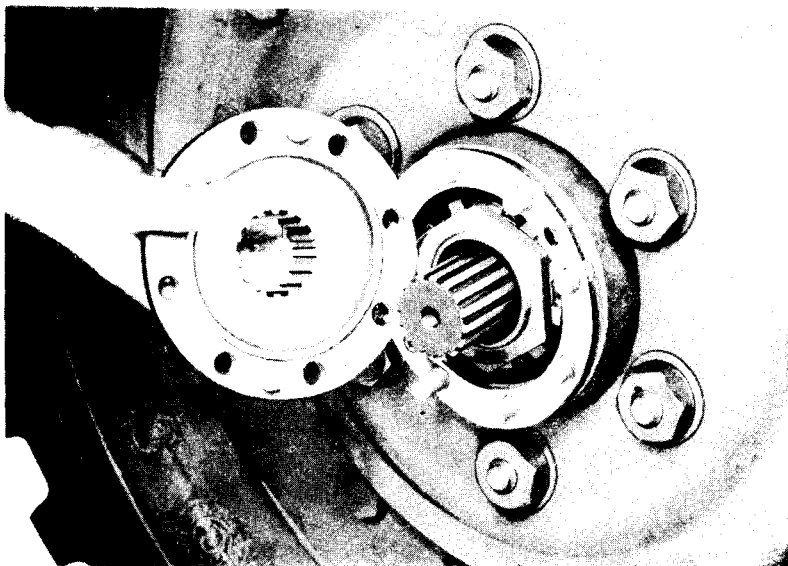

RA PD 18518

Figure 280 — Front Wheel Drive Flange — Removal

(c) *Remove Outer Lock Nut.*

SCREWDRIVER

WRENCH, wheel bearing nut

Straighten tab on lock washer. Remove outer bearing lock nut.

(d) *Adjust bearings (fig. 281).*

WRENCH, wheel bearing nut

Tighten wheel bearing nut while rotating wheel until bind or drag is felt. Back off on nut approximately one-eighth turn.

(e) *Install Lock Washer and Outer Lock Nut; Bend tab on washer.*

(f) *Install Wheel Drive Flange.*

(g) *Install Wheel Drive Flange Nuts and Washers.*

(h) *Lower Wheel and Remove Jack.*

b. Drive Sprocket Adjustment. The rear axle drive sprocket bearings can be adjusted as outlined in paragraph 52.

c. Front Wheel Bearing Replacement. Front wheel bearing replacement is accomplished as follows:

(1) EQUIPMENT.

DRIFT, brass

SCREWDRIVER

HAMMER

WRENCH, $\frac{3}{4}$ -in.

JACK

WRENCH, wheel bearing nut

BASIC HALF-TRACK VEHICLES (IHC) (PERSONNEL CARRIER M5, CAR M9A1, MULTIPLE GUN MOTOR CARRIAGE M14, AND SIMILAR IHC VEHICLES)

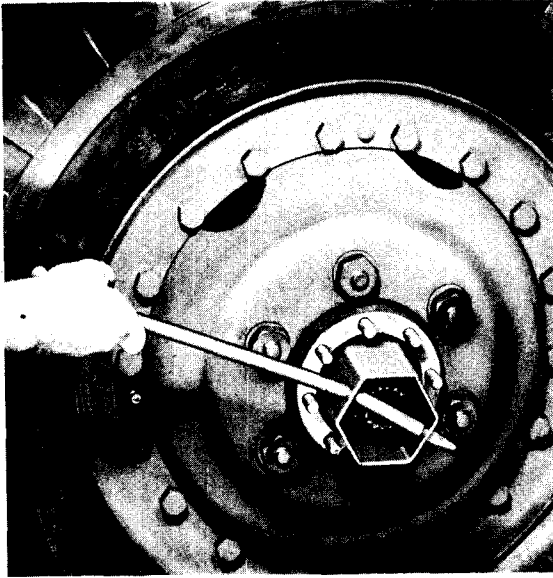

RA PD 18519

Figure 281 – Adjusting Front Wheel Bearings

(2) PROCEDURE.

(a) *Raise Wheel.*

JACK

Raise wheel from floor (subpar. a (2) (a), above).

(b) *Remove Wheel Drive Flange* (fig. 280).

WRENCH, 3/4-in.

Remove the 10 wheel drive flange nuts and washers. Screw in cap screws to force drive flange out. Remove drive flange (subpar. a (2) (b)).

(c) *Remove Wheel Bearing Lock Nut.*

SCREWDRIVER

WRENCH, wheel bearing nut

Bend tab on lock washer. Remove wheel bearing outer lock nut. Remove lock washer.

(d) *Remove Wheel Bearing Adjustment Nut.*

WRENCH, wheel bearing nut

Remove front wheel bearing adjusting nut.

(e) *Remove Wheel.*

(f) *Remove Outer Bearing.*

WHEELS, TIRES, AND WHEEL BEARINGS

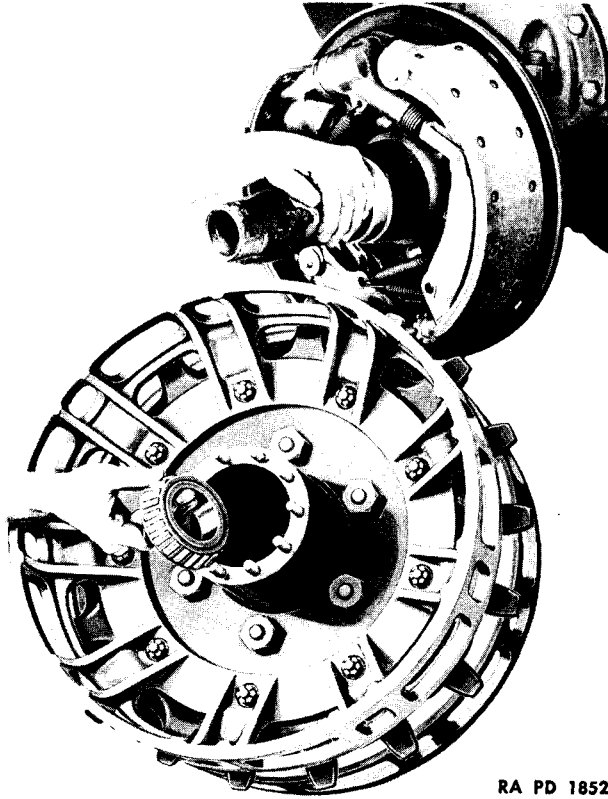

RA PD 18520

Figure 282 — Drive Sprocket and Hub Assembly — Removed

- (g) Remove Inner Bearing.
- (h) Remove Bearing Cones.

DRIFT, brass

HAMMER

Using brass drift and hammer, knock out bearing cones or races from wheel.

- (i) Install Replacement Bearing Cones.
- (j) Install Inner Bearing on Spindle Sleeve.
- (k) Install Wheel.
- (l) Install Outer Bearing.
- (m) Install and Adjust Wheel Bearing Adjustment Nut.
Tighten nut until bind or drag is felt while rotating wheel. Back off one-eighth turn (fig. 281).
- (n) Install Lock Washer and Outer Lock Nut.
- (o) Install Wheel Drive Flange.

**BASIC HALF-TRACK VEHICLES (IHC) (PERSONNEL CARRIER M5, CAR M9A1,
MULTIPLE GUN MOTOR CARRIAGE M14, AND SIMILAR IHC VEHICLES)**

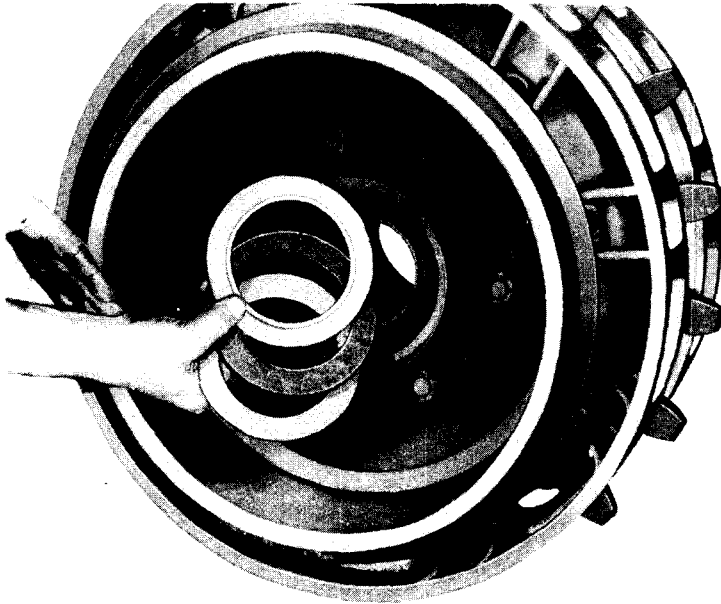

RA PD 18521

Figure 283 – Drive Sprocket Grease Seal – Removal

- (p) *Install Drive Flange Nuts and Washers.*
- (q) *Lower Wheel and Remove Jack.*

d. Drive Sprocket Bearing Replacement.

(1) EQUIPMENT.

- | | |
|-------------------------------------|---------------------------|
| BAR, pinch | JACK, 12-ton (2) |
| CHAIN, with turnbuckles | SCREWDRIVER |
| CROWBAR | WRENCH, end, 3/4-in. |
| DRIFT, brass | WRENCH, end, 2 1/4-in. |
| EXTENSION, socket wrench | WRENCH, end, 2 5/16-in. |
| HAMMER | WRENCH, socket, 3/4-in. |
| HANDLE, ratchet wrench | WRENCH, wheel bearing nut |
| HANDLE, wheel bearing nut
wrench | |

(2) PROCEDURE.

- (a) *Remove Track (par 55).*
- (b) *Remove Driving Shaft (fig. 55).*

- | | |
|--------------------------|-------------------------|
| BAR, pinch | HANDLE, ratchet wrench |
| EXTENSION, socket wrench | WRENCH, socket, 3/4-in. |

WHEELS, TIRES, AND WHEEL BEARINGS

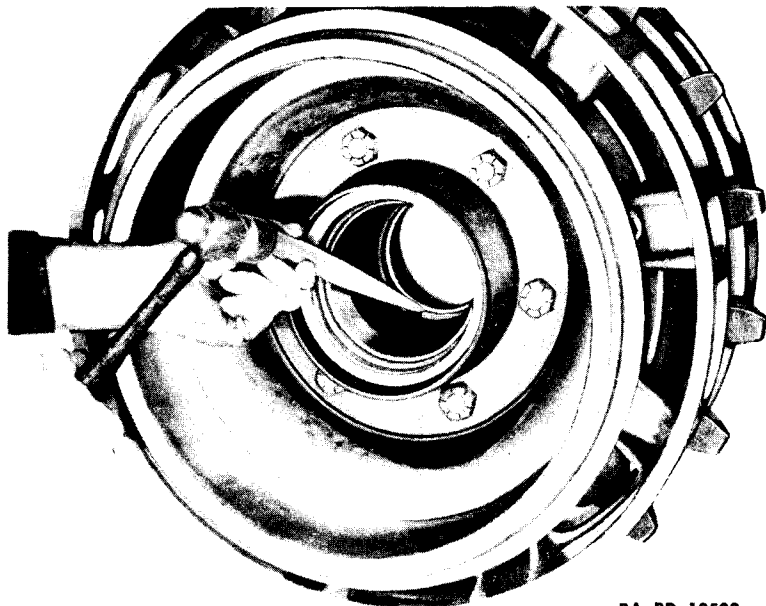

RA PD 18522

Figure 284 – Drive Sprocket Hub Bearing Cone – Removal

Remove the 10 driving shaft flange nuts and lock washers. Insert flange screws and force shaft outward. Remove driving shaft.

(c) *Remove Bearing Lock Nut* (fig. 56).

SCREWDRIVER

WRENCH, wheel bearing nut

Straighten tang on lock washer. Remove outer lock nut. Remove lock washer.

(d) *Remove Bearing Adjusting Nut.*

WRENCH, wheel bearing nut

Remove bearing adjusting nut.

(e) *Remove Drive Sprocket and Hub Assembly* (fig. 282)

(f) *Remove Bearings.*

DRIFT, brass

SCREWDRIVER

HAMMER

Remove outer bearing. Remove snap ring retaining inner grease seal. Remove grease seal. Remove inner bearing (fig. 283).

(g) *Remove Bearing Cones* (fig. 284).

DRIFT, brass

HAMMER

Knock out inner and outer bearing cones.

BASIC HALF-TRACK VEHICLES (IHC) (PERSONNEL CARRIER M5, CAR M9A1, MULTIPLE GUN MOTOR CARRIAGE M14, AND SIMILAR IHC VEHICLES)

- (h) Install Bearing Cones.*
- (i) Install Inner Bearing and Inner Oil Seal.*
- (j) Install Drive Sprocket Assembly on Rear Axle.*
- (k) Install Outer Bearing and Adjusting Nut.*

Adjust nut so that a bind or drag is felt while rotating the drive sprocket. Back off adjustment nut one-eighth turn (fig. 57).

- (l) Install Lock Washer and Outer Lock Nut.*
- (m) Install Driving Shaft and Retaining Nuts and Washers.*
- (n) Install Track.*

Procedure is outlined in paragraph 55.

Section XXVII

WINCH

	Paragraph
Description	153
Trouble shooting	154
Winch maintenance and adjustments	155
Shear pin replacement	156
Winch removal	157
Winch installation	158

153. DESCRIPTION.

a. **General.** The winch, mounted at the front of this vehicle, is Tulsa Model 18-G Winch of normal rating of 10,000 pounds capacity line pull on first layer of cable with full drum of cable, rating is 40 percent of normal. The power is transmitted through the vehicle transmission to a power take-off unit, mounted on the side of the transmission case, then through a drive shaft to the winch assembly. Operation of the winch is controlled from the driver's compartment.

b. **Operation.** A shear pin located in the front universal joint of the winch drive shaft is designed to shear off before damage occurs, should the winch be excessively overloaded. A control lever is located in the driver's compartment, which, when in the full forward position operates the winch in reverse rotation. In the full rearward position of the lever the winch is operated in the forward direction. **NOTE:** To permit shifting of the lever, it is necessary to raise the small locking plate at the side of the lever. The winch proper is operated by a sliding clutch and lever at the side of the winch drum. The winch drum must be engaged by means of the sliding clutch lever before the winch can be operated.

154. TROUBLE SHOOTING.

a. Winch Fails to Operate.

Possible Cause	Possible Remedy
Power take-off not engaged.	Engage power take-off.
Sliding clutch disengaged from winch drum.	Move clutch shifter lever to forward position and engage pin in hole.
Shear pin in winch drive shaft front universal sheared.	Replace shear pin (par. 156).

BASIC HALF-TRACK VEHICLES (IHC) (PERSONNEL CARRIER M5, CAR M9A1,
MULTIPLE GUN MOTOR CARRIAGE M14, AND SIMILAR IHC VEHICLES)

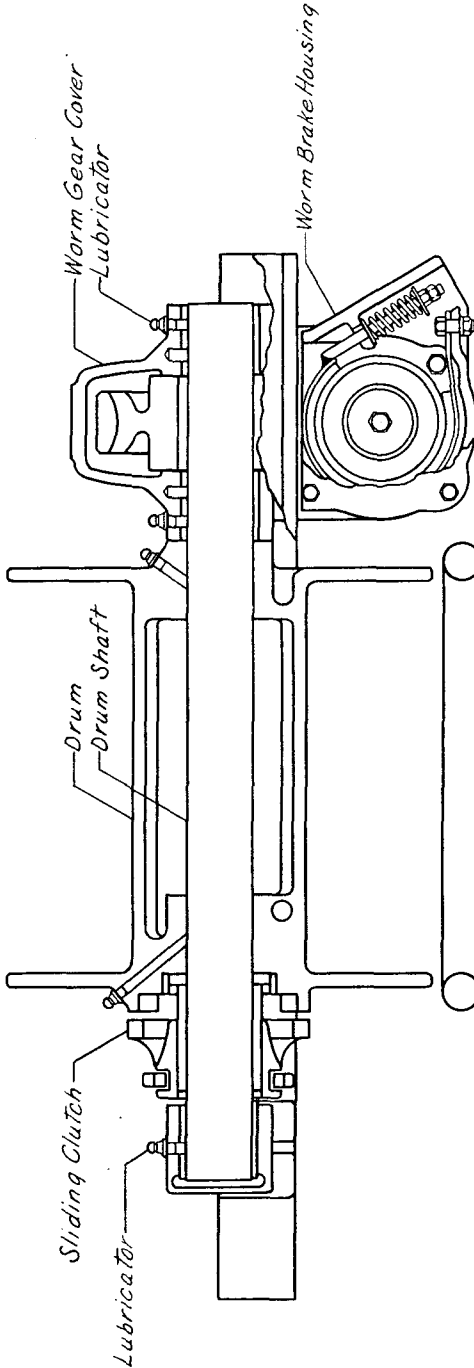

RA PD 18524

Figure 285 — Winch Details

WINCH

b. Noisy Operation of Winch.

Possible Cause	Possible Remedy
Insufficient lubrication of cable drum shaft.	Lubricate through fittings.
Lubricant low in worm housing.	Fill housing to level of plug on side of housing.
Insufficient clearance between power take-off and transmission gears causing hum or whine.	Install sufficient gaskets to correct clearance.
Excessive clearance between power take-off and transmission gears causing chatter.	Remove sufficient gaskets to correct clearance.
Excessive end play in winch worm shaft.	Notify ordnance personnel.

c. Winch Will Not Hold Load.

Safety brake not properly adjusted or lining damaged.	Adjust safety brake.
-------------------------------------------------------	----------------------

d. Winch Drum Spins When Cable is Being Released.

Winch drum brake not properly adjusted.	Adjust drum brake.
-----------------------------------------	--------------------

155. WINCH MAINTENANCE AND ADJUSTMENTS.

a. **Adjustments.** There are only two possible adjustments on the winch. These are the automatic worm brake and the drum drag brake. Adjustment for the automatic worm brake is on the outer end of the worm brake housing located on the end of the worm gear case. If adjustment of automatic worm brake is necessary, loosen the two cap screws on back of worm brake cover and turn the adjusting cam to tighten or loosen as indicated by arrow on outside of cam. Turn two notches, and test. When new brake shoes are installed, set the pointer on the fourth notch. When adjustment of the drum drag brake is necessary, adjustment may be made as desired by adjusting jam nuts on eyebolt.

156. SHEAR PIN REPLACEMENT.

a. **Shear Pin.** A shear pin is located in the winch drive shaft universal joint hub and worm shaft and is provided as a safety measure to prevent damage to winch and power take-off. Spare shear pins are included in the vehicle tool kit. Replacement is made by driving out the pin with a

BASIC HALF-TRACK VEHICLES (IHC) (PERSONNEL CARRIER M5, CAR M9A1, MULTIPLE GUN MOTOR CARRIAGE M14, AND SIMILAR IHC VEHICLES)

hammer and punch, lining up the holes, inserting new shear pin in place, and inserting cotter pin.

157. WINCH REMOVAL (fig. 285).

a. **Remove Winch.** Remove the eight winch frame angle to frame support mounting bolts, nuts, and lockwashers (two at each end of each angle) using a $\frac{5}{8}$ -inch wrench. Remove shear pin from winch drive shaft universal joint hub, and slip hub off from worm shaft. Lift winch from position, using sling and hoist.

158. WINCH INSTALLATION.

a. **Install Winch.** Install sling on winch. Lift winch with hoist and guide winch into position on frame of vehicle. Remove sling and secure winch frame angle to frame support with the eight mounting bolts, lock washers, and nuts (two at each end of each angle). Install winch drive shaft, universal joint hub on worm shaft, and install shear pin in hub.

Section XXVIII

REFERENCES

	Paragraph
Standard nomenclature lists	159
Explanatory publications	160

159. STANDARD NOMENCLATURE LISTS.

a. Ammunition.

- Ammunition, fixed and semifixed, all types, for pack, light and medium field artillery, including complete round data..... SNL R-1
- Ammunition, revolver, automatic pistol, and sub-machine gun
- Ammunition, rifle, carbine, and automatic gun... SNL T-2

b. Armament.

- Gun, machine, cal. .50, Browning, M2, aircraft, basic
- Gun, machine, cal. .50, Browning, M2, water-cooled, flexible, and mounts..... SNL A-37
- Gun, submachine, cal. .45, Thompson, M1928A1 and M1
- Pistol, automatic, cal. .45, M1911 and M1911A1 SNL B-6
- Rifle, U. S., cal. .30, M1903, M1903A1, and M1903A3
- Rifle, U. S., cal. .30, M1903, Mk. I (special).
- Tools, maintenance, for repair of automatic guns, automatic gun antiaircraft materiel, automatic and semiautomatic cannon, and mortars..... SNL A-35

c. Maintenance.

- Half-track vehicles: Car, half-track, M9 (M2E5) (International Harvester Co.); carrier, personnel, half-track, M5 (M3E2) (International Harvester Co.); carriage, motor, multiple gun, M14 (International Harvester Co.); carriage, motor, multiple gun, M17..... SNL G-147
- Cleaning, preserving, and lubricating materials; recoil fluids, special oils, and miscellaneous related items

**BASIC HALF-TRACK VEHICLES (IHC) (PERSONNEL CARRIER M5, CAR M9A1,
MULTIPLE GUN MOTOR CARRIAGE M14, AND SIMILAR IHC VEHICLES)**

Soldering, brazing and welding material, gases, and related items	SNL K-2
Tools, maintenance, for repair of automatic guns, automatic gun antiaircraft materiel, automatic and semiautomatic cannon, and mortars.....	SNL A-35
Truck, small arms repair, M1.....	SNL G-72
Truck, spare parts, M14 (load A and B ₁).....	SNL G-144
Current standard nomenclature lists are tabu- lated here. An up-to-date list of SNL's is main- tained as the "Ordnance Publications for Supply Index"	OPSI

160. EXPLANATORY PUBLICATIONS.

a. Ammunition.

Ammunition, general	TM 9-1900
Grenades	FM 23-30
Small arms ammunition	OFSB 3-5

b. Armament.

Automatic pistol, cal. .45, M1911 and M1911A1	FM 23-35
Browning machine gun, cal. .30, HB, M1919A4 (mounted in combat vehicles).....	FM 23-50
Browning machine gun, cal. .50, all types.....	TM 9-1225
Grenades	FM 23-30
Instruction guide: Small arms data.....	TM 9-2200
Thompson submachine gun, cal. .45, M1928A1....	FM 23-40

c. Communications.

Radio fundamentals	TM 11-455
The radio operator	TM 11-454
Radio Set, SCR 593-A	TM 11-859

d. Maintenance and Inspection.

Automotive brakes	TM 10-565
Automotive lubrication	TM 10-540
Automotive power transmission units.....	TM 10-585

REFERENCES

- | | |
|---------------------------------------------------------------------------------------------------------------------------------------------------------------------------------------------------------------------------------------------------------------------------------|---------------|
| Chassis, body, and trailer units | TM 10-560 |
| Chemical decontamination materials and equip-
ment | TM 3-220 |
| Cleaning, preserving, lubricating, and welding
materials and similar items issued by the Ord-
nance Department | TM 9-850 |
| Defense against chemical attack | FM 21-40 |
| Detailed lubrication instructions for ordnance
materiel | OFSB 6-series |
| Echelon system of maintenance | TM 10-525 |
| Fire prevention, safety precautions, accidents... | TM 10-360 |
| Motor transport inspections | TM 10-545 |
| Sheet metal work, body, fender, and radiator re-
pairs | TM 10-450 |
| The motor vehicle | TM 10-510 |
| e. Miscellaneous. | |
| Automotive electricity | TM 10-580 |
| Camouflage | FM 5-20 |
| Electric fundamentals | TM 1-455 |
| Fuels and carburetion | TM 10-550 |
| Half-track vehicles | TM 9-710 |
| List of publications for training | FM 21-6 |
| Military motor transportation | TM 10-505 |
| Military motor vehicles | AR 850-15 |
| Motor transport | FM 25-10 |
| The internal combustion engine | TM 10-570 |
| f. Storage and Shipment. | |
| Registration of motor vehicles | AR 850-10 |
| Rules governing the loading of mechanized and
motorized Army equipment, also major caliber
guns for the United States Army and Navy,
on open top equipment—Published by the
Operations and Maintenance Department of
the Association of American Railroads | |
| Storage of motor vehicle equipment | AR 850-18 |

BASIC HALF-TRACK VEHICLES (IHC) (PERSONNEL CARRIER M5, CAR M9A1, MULTIPLE GUN MOTOR CARRIAGE M14, AND SIMILAR IHC VEHICLES)

INDEX

A	Page No.	Page No.
Accelerator control rod, disconnect...	345	
Accessories		
clutch	316	
cooling system	313	
electrical system	313	
fuel system	313-316	
lubricating system	316	
Adjustments:		
backlash in lever shaft.....	405	
carburetor	371-374	
idling	371	
clutch	239-240	
compass	388-389	
drag link	407	
drive shaft brake.....	228-231	
drive sprocket	427	
drive sprocket brakes.....	217-218	
electric trailer brake controller	234-235	
fan belt tension.....	253	
front axle	137-145	
front brake shoe.....	219-220	
headlights and marker lights.....	309	
idlers	177-185	
intake valve	334-335	
rear axle	149-151	
rear brakes	221-225	
service brake	215-225	
service brake pedal linkage....	214-215	
springs and shock absorbers.....	397	
steering gear	403-407	
tension of tracks.....	159-161	
tracks	183-184	
wheel bearing	426-427	
winch	435	
Air cleaners		
care under unusual conditions.....	116	
description and maintenance.....	376	
lubrication	70-71	
servicing		
after operation and weekly.....	44	
at the halt	42	
Air filters, operation in sandy and desert terrain	118	
Air leakage in tires, cause and remedy	422	
Alignment of instrument panel steering column support	406	
Ammeter		
replacement	379	
trouble shooting	273-275	
Amphenol plugs		
description	305-306	
servicing	306	
Antifreeze chart	257, 259	
Auxiliary equipment controls and operation (winch)		
controls	33	
lubrication	35	
operation	33-34	
Axle and transfer vents		
service after operation and weekly	45	
service at the halt	41	
B		
Backlash		
adjustment for in lever shaft	405	
rear axle	149	
Ball bearing, lubrication.....	283	
Battery		
care under unusual conditions	116	
inspection	339	
maintenance	54, 276-277	
replacement	279-280	
storage	278	
trouble shooting	278-279	
voltmeter check	275	
Bearing lock nut, removal	431	
Blackout driving light switch, replacement	385-386	
Blackout light switch, replacement	387-388	
Bleeding hydraulic system	225-228	
Bogie arm plates, removal	170	
Bogie suspension and track		
adjusting idlers	177-185	
bogies	166-177	
description	159	
track supporting rollers	185-188	
tracks	159-165	
Bogies		
description	166	
disassembly	166-171	
maintenance	174-176	
reassembly	171-174	

INDEX

B — Cont'd	Page No.	Page No.
Brake master cylinder, maintenance	63	
Brake systems		
bleeding the line	225-228	
description	189	
drive shaft, brake	228-234	
electric trailer brake controller	234-236	
master cylinder	192-194	
service brake adjustment	215-225	
service brake pedal linkage	214-215	
service brake shoes	205-214	
trouble shooting	189-192	
vacuum power unit (hydro- vac)	195-203	
Brakes		
inspection	58	
lubrication	75-76	
maintenance	51	
operation	29	
under unusual conditions	117	
C		
Carburetor		
care under unusual conditions	116	
cleaning	340	
description	371	
maintenance and adjustment	371-374	
replacement	374	
trouble shooting	359-360	
Circuit breakers, description	305	
Cleaning battery	276	
Clutch		
description	237	
maintenance and adjustment	239-240	
maintenance duties by echelons	125	
operation	237	
replacement	241-242	
service before operation	40	
trouble shooting	237-239	
Clutch pedal, maintenance	63	
Coil distributor circuit, testing	271	
Cold weather accessories	117	
Compass		
adjustment	388-389	
description	388	
Controls, driving	22-32	
Cooling system		
antifreeze protection	256-259	
description	243	
fan	251	
fan belt adjustment	253-254	
precautions	259-261	
preparation for operation under unusual conditions	115-117	
radiator and shroud	246-249	
surge tank	256	
thermostat	254-256	
trouble shooting	243-246	
water pump	251-253	
Cotter pin, removal from rod-end yoke	240	
Crankcase ventilator		
description	342	
maintenance	342-343	
Cylinder head, replacement	318-326	
Cylinder head and gasket, maintenance	53	
D		
Data		
engine	312-313	
vehicles	19-21	
Description:		
air cleaner	376	
bogie suspension and track		
bogies	166	
track supporting rollers	185	
tracks	159	
brake system		
drive shaft brake	228	
electric trailer brake control- ler	234	
service brake shoes	205-207	
vacuum power unit (hydro- vac)	195-196	
clutch	237	
cooling system		
radiator and shroud	246	
surge tank	256	
thermostat	254-255	
water pump	251	
electrical system		
amphenol plugs	305-306	
distributor	293	
electric brake control	311	
generator	283	
generator regulator	288-289	
headlights and marker lights	307	
ignition coil	291	
radio noise suppression	298-299	
taillights	310	

BASIC HALF-TRACK VEHICLES (IHC) (PERSONNEL CARRIER M5, CAR M9A1, MULTIPLE GUN MOTOR CARRIAGE M14, AND SIMILAR IHC VEHICLES)

D — Cont'd	Page No.	Page No.
Description — Cont'd		
engine		removal 153, 431
crankcase ventilator	342	replacement 430-432
intake valve	334	Drive sprocket bearing, adjust-
oil cooler	343	ment 150-151
oil pump	331-332	Drive sprocket brakes, adjust-
exhaust system	348	ment 217-218
front axle	135	Drive sprocket shaft, removal
fuel system		209
carburetor	371	Driving controls and operation
fuel and vacuum pump	364	controls 22-23
fuel filter	367	operating the vehicle 27-32
fuel tanks	360-361	starting and warming up engine 23-27
half-track car M9A1	4	Driving shaft, replacement
half-track personnel carrier M5 ..	3-4	151-153
instruments and gages		E
compass	388	Echelons, definition of
multiple gun motor carriage M14	4	121-122
propeller shafts	390	Electric brake control, description
rear axle	149	and replacement 311
roller	352-354	Electric brake load control switch,
springs and shock absorbers	394	replacement 384
steering gear	401	Electric trailer brake controller
transmission and transfer case ...	413	description
wheels, tires, and wheel bearing ..	422	description 234
winch	433	maintenance and adjustment.. 234-235
Disassembly of bogies	166-171	replacement 235-236
Distributor		Electrical system
care under unusual conditions	115	amphenol plugs
description	293	battery
inspection	340	circuit breakers
lubrication	74	description
maintenance	55, 294-295	distributor
replacement	295-297	description 262
Distributor cover, testing	271-273	distributor 293-297
Drag link		electric brake control
adjustment	407	generator
description	401	generator regulator
installation	407	generator regulator 288-291
replacement	409-411	headlights and marker lights.. 307-309
Dragging brakes	191	horns
Draining cooling system	261	description 311
Drive shaft brake (system)		ignition coil
description	228	description 291-293
maintenance and adjustment 228-231		ignition trouble shooting
replacement	231-234	description 262-275
trouble shooting	192	maintenance duties by
Drive sprocket		echelons
adjustment	427	description 125-126
		radio noise suppression
		description 298-304
		spark plugs
		description 298
		starting motor
		description 280-283
		switches
		description 305
		taillights
		description 310-311
		terminal box
		description 306
		timing
		description 304
		Electrolyte, checking in battery
		276
		Engine
		accessories
		description 313-316
		carbon, cleaning
		description 337-339
		crankcase ventilator
		description 341-343

INDEX

E — Cont'd	Page No.	Page No.
Engine — Cont'd		
data	312-313	
description	312	
maintenance	52	
oil cooler	343	
oil pump	331-334	
replacement		
cylinder head	318-326	
engine	343-347	
manifold	326-331	
oil pan	340-341	
valve	336-337	
timing marks	326	
trouble shooting	316-318	
tune-up	339-340	
valves	334-335	
Engine and components, maintenance duties by echelons	126-128	
Engine controls, servicing		
after operation and weekly	45	
during operation	40	
Engine cooling system, maintenance duties by echelons	126	
Engine cylinder head, cleaning		
carbon	337-339	
Exhaust pipe, removal	345	
Exhaust system		
description	348	
maintenance	348	
duties by echelons	128	
removal of parts	348-351	
F		
Filters, description	299	
Final road test	69	
Fire extinguishers		
inspection	68	
before operation	38	
service after operation and weekly	44	
Frame		
pintle and tow hooks	352	
roller	352-356	
Front axle		
description	135	
maintenance	62-63	
duties by echelons	122-123	
replacement	145-148	
steering maintenance and adjustments	137-145	
trouble shooting	136	
Front axle drive, operation	29	
Front wheel bearings, lubrication	71	
Fuel and vacuum pump		
description	364	
maintenance	364-365	
replacement	365-367	
Fuel filter		
description	367	
maintenance	56, 367-369	
replacement	369-371	
Fuel gage, replacement	379-382	
Fuel line protection shield, removal	361	
Fuel pump		
maintenance	56	
operation under unusual conditions	116	
trouble shooting	360	
Fuel system		
air cleaner	376	
carburetor	371-374	
description	357	
filter	367-371	
fuel and vacuum pump	364-367	
fuel tanks	360-363	
maintenance duties by echelons ..	128	
trouble shooting	357-360	
Fuel tanks		
description	360-361	
removal and replacement	361-363	
Fuels for low temperatures	113-114	
G		
Gear box assembly, removal	418-420	
Generator		
description	283	
maintenance	283-284	
replacement	286-288	
trouble shooting	285-286	
Generator regulator		
description	288-289	
operation	290	
failure	291	
replacement	289-290	
trouble shooting	290-291	
Governor adjustment	372-374	
Grabbing clutch	237	

BASIC HALF-TRACK VEHICLES (IHC) (PERSONNEL CARRIER M5, CAR M9A1, MULTIPLE GUN MOTOR CARRIAGE M14, AND SIMILAR IHC VEHICLES)

O — Cont'd	Page No.		Page No.
Operation		installation	249
clutch	237	removal	247-249
driving controls	22-32	Radiator louvre and frame assem- bly, removal	248
generator regulator	290	Radio noise suppression	
inspection		description	298-299
after and weekly	42-47	maintenance	303-304
at halt	41-42	points of	299-303
before	37-39	Rear axle (assembly)	
during	40-41	description	149
under unusual conditions		maintenance and adjustment	149-151
cold weather accessories	117	maintenance duties by echelons....	123
fuels for low temperatures..	113-114	replacement	151-158
high temperature operation	117-118	trouble shooting	149
lubrication of vehicles	114-115	Rear brakes, adjustment after re- lining	221-225
preparation of vehicle	115-117	Reassembly of bogies	171-174
sandy and desert terrain		Rebuild defined	122
driving	120	Regimental maintenance platoon	
maintenance	119	tools, list of	132-134
special equipment	119-120	Repair defined	122
subzero operation	113	Replace defined	122
winch	435	Resistor suppressors	
winch controls	33-34	description	299
Organization maintenance tools, list of	132	trouble shooting	303
Overheating:		Reverse winch load	34
battery	279	Roller	
cooling system	243-246, 260-261	description	352-354
engine	317	replacement	354-356
P			
Pintle and tow hooks, description....	352	S	
Precautions		Second echelon maintenance basic	
adjusting cam end play.....	406	instruction	47-48
cooling system		Serial numbers	7
draining	261	Service brake, adjustment.....	215-225
overheating	260-261	Service brake pedal linkage, ad- justment	214-215
servicing	259-260	Service brake shoes	
maintenance of starting		description	205-207
motor	280-281	replacement	
Propeller shaft		drive sprocket	209-214
description	390	front wheels	207-209
inspection	63	Service defined	122
maintenance	390	Servicing master cylinder	192-193
echelon duties	130	Shimmy, cause and remedy	
replacement	390-393	front axle	136
R		steering gear	401
Radiator, maintenance	54		
Radiator and shroud			
description	246		

INDEX

S — Cont'd	Page No.	Page No.	
Shock absorbers, inspection.....	62	Surge tank, description and replacement	256
(See also Springs and shock absorbers)			
6,000 mile maintenance	49-69	Tachometer, replacement	377
Slipping clutch	237	Tachometer, cable, lubrication	76
Spark plugs		Tachometer drive shaft, disconnecting	344
care under unusual conditions.....	115	Taillights	
maintenance	54	description	310
servicing and replacement	298	maintenance	311
testing	273	Terminal box, description	306
tune-up	339	Testing vacuum power unit (hydrovac)	196-198
Specific gravity of electrolyte.....	276	Thermostat	
Speedometer, replacement	377	description	254-255
Speedometer cable		replacement	255-256
lubrication	76	Tires	
operation under unusual conditions	117	desert operation	119
Springs and shock absorbers		inspection	57-58
description	394	maintenance and adjustment	423-424
maintenance and adjustment	397	Tools and equipment stowage on the vehicle	
maintenance duties by echelons...	130	gun equipment	98-105
replacement	398-400	gun spare parts	105-112
trouble shooting	394-395	gun tools	97-98
Starting and warming engine		vehicular equipment	86-95
hints	23-27	vehicular spare parts	95-97
instructions	23	vehicular tools	77-86
Starting motor		Track assembly, maintenance duties by echelons	130-131
maintenance	280-281	Track chain, installation	30-32
replacement	283	Track supporting rollers	
trouble shooting	281-282	bearing and oil seal replacement	185-188
Starting switch, replacement	388	description	185
Steering gear		Track tension, adjustment	60
description	401	Tracks	
maintenance and adjustment ..	403-407	adjustment	183-184
maintenance duties by echelons ..	130	description	159
replacement		maintenance	165
drag link	409-411	removal and replacement	161-165
horn button	407-408	service after operation and weekly	45
steering gear position	411-412	Traction aids in operating the vehicle	30
steering wheel	408-409	Transfer case	
trouble shooting	401-403	maintenance duties by echelons ..	131
Steering knuckle bearing		operation	28
adjustment	137-140	(See also Transmission and transfer case)	
toe-in	140-145		
inspection	61		
Steering wheel			
description	401		
replacement	408-409		
Subzero operation	113		
Supporting roller assembly, removal	185		

BASIC HALF-TRACK VEHICLES (IHC) (PERSONNEL CARRIER M5, CAR M9A1, MULTIPLE GUN MOTOR CARRIAGE M14, AND SIMILAR IHC VEHICLES)

T — Cont'd	Page No.	Page No.	
Transfer case shift lever, replacement	418	Valve mechanism, maintenance	53
Transmission and transfer case description	413	Valve rocker arm cover, installation	335
installation	420-421	Vehicle assembly, maintenance duties by echelons	131
replacement	415-421	Vehicles	
trouble shooting	413-414	data	19-21
Transmission shift lever, replacement	415-418	lubrication	65-66
Trouble-lamp socket, removal	385	Vehicular tools, list of	77-86
Trouble shooting		Vision slots	17
brake system	189-192	Voltmeter, replacement	379
clutch	237-239		
cooling system	243-246	W	
electrical system		Water pump	
battery	278-279	description	251
generator	285-286	maintenance	55
generator regulator	290-291	replacement	251-253
ignition	262-275	Water temperature gage, replacement	382
ignition coil	291	Weekly inspection of vehicle	42-47
starting motor	281-282	Weight of battery	275
engine	316-318	Wheel and tire assembly, removal ..	146
front axle	136	Wheel bearing	
fuel system	357-360	adjustment	426-427
rear axle	149	replacement	427-430
springs and shock absorbers ..	394-395	Wheels, tires, and wheel bearing	
steering gear	401-403	description	422
transmission and transfer case ..	413-414	front wheel maintenance and adjustment	423-426
wheels, tires, and wheel bearing ..	422	maintenance and adjustment ..	424-426
winch	433-435	trouble shooting	422
U		wheel bearings	426-432
Universal joints, lubrication	71-73	Winch	
Unusual conditions, operation of materiel under	113-120	description	433
Unusual engine noises	53	inspection	66
V		installation	436
Vacuum power unit (hydrovac)		maintenance and adjustment	435
description	195-196	maintenance duties by echelons ..	131
hydrovac air cleaner	201-203	removal	436
replacement	198-201	shear pin replacement	435-436
testing	196-198	trouble shooting	433-435
		Winch universal joints, lubrication ..	76

INDEX

[A.G. 062.11 (5-4-43)
O.O.M. 461/12364 C. of O. (5-22-43)]

BY ORDER OF THE SECRETARY OF WAR:

G. C. MARSHALL,
Chief of Staff.

OFFICIAL:

J. A. ULIO,
Major General,
The Adjutant General.

DISTRIBUTION: R 2, 3, 5, 7, 9, 17 and 44(4); Bn 9(2); IBn 2, 3, 5, 7,
17, 18 and 44(5); C 9(8); IC 2, 3, 5, 7, 17, 18 and 44(4)

(For explanation of symbols, see FM 21-6)